

FCC SAR Test Report

Report No. : SA190625C21

Applicant : Microsoft Corporation

Address : One Microsoft Way Redmond, Wa 98052-6399, U.S.A

Product : PORTABLE COMPUTING DEVICE

FCC ID : C3K1866

Brand : Microsoft

Model No. : 1866

Standards : FCC 47 CFR Part 2 (2.1093), IEEE C95.1:1992, IEEE Std 1528:2013
KDB 865664 D01 v01r04, KDB 865664 D02 v01r02
KDB 248227 D01 v02r02, KDB 447498 D01 v06, KDB 616217 D04 v01r02

Sample Received Date : Jun. 25, 2019

Date of Testing : Jul. 08, 2019 ~ Jul. 24, 2019

Lab Address : No. 47-2, 14th Ling, Chia Pau Vil., Lin Kou Dist., New Taipei City, Taiwan, R.O.C.

Test Location : No. 19, Hwa Ya 2nd Rd, Wen Hwa Vil, Kwei Shan Dist., Taoyuan City 33383, Taiwan (R.O.C)

CERTIFICATION: The above equipment have been tested by **Bureau Veritas Consumer Products Services (H.K.) Ltd., Taoyuan Branch – Lin Kou Laboratories**, and found compliance with the requirement of the above standards. The test record, data evaluation & Equipment Under Test (EUT) configurations represented herein are true and accurate accounts of the measurements of the sample’s SAR characteristics under the conditions specified in this report. It should not be reproduced except in full, without the written approval of our laboratory. The client should not use it to claim product certification, approval, or endorsement by TAF or any government agencies.

Prepared By : Gina Liu
Gina Liu / Specialist

Approved By : Gordon Lin
Gordon Lin / Assistant Manager



FCC Accredited No.: TW0003

This report is for your exclusive use. Any copying or replication of this report to or for any other person or entity, or use of our name or trademark, is permitted only with our prior written permission. This report sets forth our findings solely with respect to the test samples identified herein. The results set forth in this report are not indicative or representative of the quality or characteristics of the lot from which a test sample was taken or any similar or identical product unless specifically and expressly noted. Our report includes all of the tests requested by you and the results thereof based upon the information that you provided to us. You have 60 days from date of issuance of this report to notify us of any material error or omission caused by our negligence, provided, however, that such notice shall be in writing and shall specifically address the issue you wish to raise. A failure to raise such issue within the prescribed time shall constitute your unqualified acceptance of the completeness of this report, the tests conducted and the correctness of the report contents. Unless specific mention, the uncertainty of measurement has been explicitly taken into account to declare the compliance or non-compliance to the specification.

Table of Contents

Release Control Record	3
1. Summary of Maximum SAR Value	4
2. Description of Equipment Under Test	5
3. SAR Measurement System	6
3.1 Definition of Specific Absorption Rate (SAR)	6
3.2 SPEAG DASY52 System	6
3.2.1 Robot	7
3.2.2 Probes	8
3.2.3 Data Acquisition Electronics (DAE)	8
3.2.4 Phantoms	9
3.2.5 Device Holder	10
3.2.6 System Validation Dipoles	10
3.2.7 Tissue Simulating Liquids	11
3.3 SAR System Verification	13
3.4 SAR Measurement Procedure	14
3.4.1 Area & Zoom Scan Procedure	14
3.4.2 Volume Scan Procedure	14
3.4.3 Power Drift Monitoring	15
3.4.4 Spatial Peak SAR Evaluation	15
3.4.5 SAR Averaged Methods	15
4. SAR Measurement Evaluation	16
4.1 EUT Configuration and Setting	16
4.2 EUT Testing Position	19
4.2.1 Body Exposure Conditions	19
4.2.2 SAR Test Exclusion Evaluations	20
4.3 Tissue Verification	21
4.4 System Validation	22
4.5 System Verification	22
4.6 Maximum Output Power	23
4.6.1 Maximum Target Conducted Power	23
4.6.2 Measured Conducted Power Result	38
4.7 SAR Testing Results	44
4.7.1 SAR Test Reduction Considerations	44
4.7.2 SAR Results for Body Exposure Condition	45
4.7.3 SAR Measurement Variability	49
4.7.4 Simultaneous Multi-band Transmission Evaluation	50
5. Calibration of Test Equipment	53
6. Measurement Uncertainty	54
7. Information of the Testing Laboratories	55
Appendix A. SAR Plots of System Verification	
Appendix B. SAR Plots of SAR Measurement	
Appendix C. Calibration Certificate for Probe and Dipole	
Appendix D. Photographs of EUT and Setup	

1. Summary of Maximum SAR Value

Equipment Class	Mode	Highest Scaled SAR-1g Body (W/kg)			
		Tablet Mode (Mode 1)		Laptop Mode (Mode 2)	
		FIT Ant.	AWAN Ant.	FIT Ant.	AWAN Ant.
DTS	2.4G WLAN	0.64	0.86	0.40	0.34
NII	5.3G WLAN	1.12	0.95	0.77	0.96
	5.6G WLAN	1.14	1.14	0.78	0.72
	5.8G WLAN	1.18	0.95	0.93	1.02
DSS	Bluetooth	0.42	0.48	0.00	0.02

Highest Simultaneous Transmission SAR	Highest Scaled SAR-1g Body (W/kg)			
	Tablet Mode (Mode 1)		Laptop Mode (Mode 2)	
	FIT Ant.	AWAN Ant.	FIT Ant.	AWAN Ant.
	1.52	1.58	0.77	0.89

Note:

- The SAR criteria (**Head & Body: SAR-1g 1.6 W/kg, and Extremity: SAR-10g 4.0 W/kg**) for general population / uncontrolled exposure is specified in FCC 47 CFR part 2 (2.1093) and ANSI/IEEE C95.1-1992.

2. Description of Equipment Under Test

EUT Type	PORTABLE COMPUTING DEVICE
FCC ID	C3K1866
Brand Name	Microsoft
Model Name	1866
Tx Frequency Bands (Unit: MHz)	WLAN : 2412 ~ 2472, 5180 ~ 5240, 5250 ~ 5320, 5500 ~ 5720, 5745 ~ 5825 Bluetooth : 2402 ~ 2480
Uplink Modulations	802.11b : DSSS 802.11a/g/n/ac/ax : OFDM Bluetooth : GFSK, $\pi/4$ -DQPSK, 8-DPSK
Maximum Tune-up Conducted Power (Unit: dBm)	Please refer to section 4.6.1 of this report
Antenna Type	PIFA Antenna
EUT Stage	Engineering Sample

Note:

- The antenna information is listed as below.

Sample	Antenna Type	Manufacturer	Parts Number	Antenna Gain (dBi)			
				BT/WLAN 2.4GHz	WLAN 5.15~5.35 GHz	WLAN 5.47~5.725 GHz	WLAN 5.725~5.85 GHz
1	PIFA	FIT	Main Antenna: 1415-07C20QS	1.6	3.1	2.9	2.5
			Aux. Antenna: 1415-07C30QS	0.8	1.7	2.3	1.0
2		AWAN	Main Antenna: 1415-07BL0QS	1.5	3.0	2.5	2.5
			Aux. Antenna: 1415-07BJ0QS	0.5	1.5	2.2	1.0

- The above EUT information is declared by manufacturer and for more detailed features description please refer to the manufacturer's specifications or User's Manual.

3. SAR Measurement System

3.1 Definition of Specific Absorption Rate (SAR)

SAR is related to the rate at which energy is absorbed per unit mass in an object exposed to a radio field. The SAR distribution in a biological body is complicated and is usually carried out by experimental techniques or numerical modeling. The standard recommends limits for two tiers of groups, occupational/controlled and general population/uncontrolled, based on a person's awareness and ability to exercise control over his or her exposure. In general, occupational/controlled exposure limits are higher than the limits for general population/uncontrolled.

The SAR definition is the time derivative (rate) of the incremental energy (dW) absorbed by (dissipated in) an incremental mass (dm) contained in a volume element (dv) of a given density (ρ). The equation description is as below:

$$\text{SAR} = \frac{d}{dt} \left(\frac{dW}{dm} \right) = \frac{d}{dt} \left(\frac{dW}{\rho dv} \right)$$

SAR is expressed in units of Watts per kilogram (W/kg)

SAR measurement can be related to the electrical field in the tissue by

$$\text{SAR} = \frac{\sigma |E|^2}{\rho}$$

Where: σ is the conductivity of the tissue, ρ is the mass density of the tissue and E is the RMS electrical field strength.

3.2 SPEAG DASY52 System

DASY52 system consists of high precision robot, probe alignment sensor, phantom, robot controller, controlled measurement server and near-field probe. The robot includes six axes that can move to the precision position of the DASY52 software defined. The DASY52 software can define the area that is detected by the probe. The robot is connected to controlled box. Controlled measurement server is connected to the controlled robot box. The DAE includes amplifier, signal multiplexing, AD converter, offset measurement and surface detection. It is connected to the Electro-optical coupler (ECO). The ECO performs the conversion from the optical into digital electric signal of the DAE and transfers data to the PC.

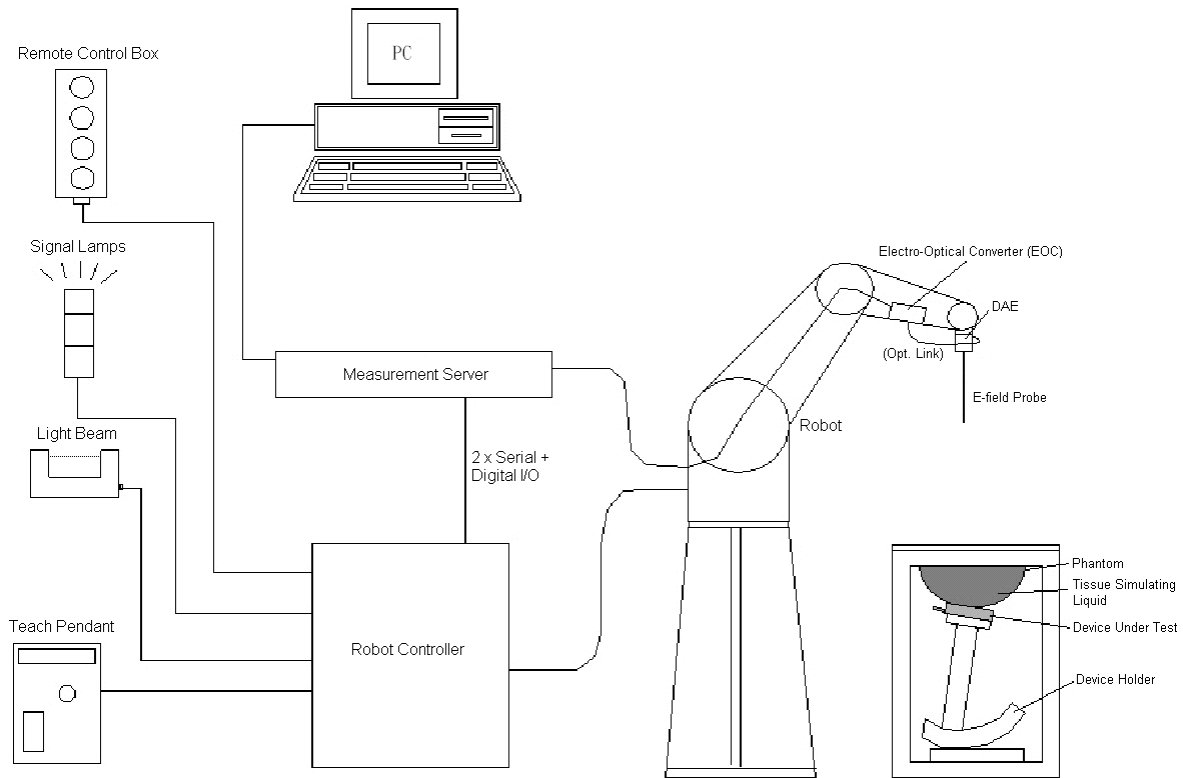

Fig-3.1 SPEAG DASY52 System Setup

3.2.1 Robot

The DASY52 systems use the high precision robots from Stäubli SA (France). For the 6-axis controller system, the robot controller version of CS8c from Stäubli is used. The Stäubli robot series have many features that are important for our application:

- High precision (repeatability ± 0.035 mm)
- High reliability (industrial design)
- Jerk-free straight movements
- Low ELF interference (the closed metallic construction shields against motor control fields)





Fig-3.2 SPEAG DASY52 System

FCC SAR Test Report

3.2.2 Probes

The SAR measurement is conducted with the dosimetric probe. The probe is specially designed and calibrated for use in liquid with high permittivity. The dosimetric probe has special calibration in liquid at different frequency.

Model	EX3DV4	
Construction	Symmetrical design with triangular core. Built-in shielding against static charges. PEEK enclosure material (resistant to organic solvents, e.g., DGBE).	
Frequency	10 MHz to 6 GHz Linearity: ± 0.2 dB	
Directivity	± 0.3 dB in HSL (rotation around probe axis) ± 0.5 dB in tissue material (rotation normal to probe axis)	
Dynamic Range	10 μ W/g to 100 mW/g Linearity: ± 0.2 dB (noise: typically < 1 μ W/g)	
Dimensions	Overall length: 337 mm (Tip: 20 mm) Tip diameter: 2.5 mm (Body: 12 mm) Typical distance from probe tip to dipole centers: 1 mm	

Model	ES3DV3	
Construction	Symmetrical design with triangular core. Interleaved sensors. Built-in shielding against static charges. PEEK enclosure material (resistant to organic solvents, e.g., DGBE).	
Frequency	10 MHz to 4 GHz Linearity: ± 0.2 dB	
Directivity	± 0.2 dB in HSL (rotation around probe axis) ± 0.3 dB in tissue material (rotation normal to probe axis)	
Dynamic Range	5 μ W/g to 100 mW/g Linearity: ± 0.2 dB	
Dimensions	Overall length: 337 mm (Tip: 20 mm) Tip diameter: 3.9 mm (Body: 12 mm) Distance from probe tip to dipole centers: 2.0 mm	

Model	ET3DV6	
Construction	Symmetrical design with triangular core Built-in optical fiber for surface detection system. Built-in shielding against static charges. PEEK enclosure material (resistant to organic solvents, e.g., DGBE)	
Frequency	10 MHz to 2.3 GHz; Linearity: ± 0.2 dB	
Directivity	± 0.2 dB in TSL (rotation around probe axis) ± 0.4 dB in TSL (rotation normal to probe axis)	
Dynamic Range	5 μ W/g to 100 mW/g; Linearity: ± 0.2 dB	
Dimensions	Overall length: 337 mm (Tip: 16 mm) Tip diameter: 6.8 mm (Body: 12 mm) Distance from probe tip to dipole centers: 2.7 mm	

3.2.3 Data Acquisition Electronics (DAE)

Model	DAE3, DAE4	
Construction	Signal amplifier, multiplexer, A/D converter and control logic. Serial optical link for communication with DASY embedded system (fully remote controlled). Two step probe touch detector for mechanical surface detection and emergency robot stop.	
Measurement Range	-100 to +300 mV (16 bit resolution and two range settings: 4mV, 400mV)	
Input Offset Voltage	$< 5\mu$ V (with auto zero)	
Input Bias Current	< 50 fA	
Dimensions	60 x 60 x 68 mm	

FCC SAR Test Report

3.2.4 Phantoms

Model	Twin SAM	
Construction	The shell corresponds to the specifications of the Specific Anthropomorphic Mannequin (SAM) phantom defined in IEEE 1528 and IEC 62209-1. It enables the dosimetric evaluation of left and right hand phone usage as well as body mounted usage at the flat phantom region. A cover prevents evaporation of the liquid. Reference markings on the phantom allow the complete setup of all predefined phantom positions and measurement grids by teaching three points with the robot.	
Material	Vinylester, glass fiber reinforced (VE-GF)	
Shell Thickness	2 ± 0.2 mm (6 ± 0.2 mm at ear point)	
Dimensions	Length: 1000 mm Width: 500 mm Height: adjustable feet	
Filling Volume	approx. 25 liters	

Model	ELI	
Construction	Phantom for compliance testing of handheld and body-mounted wireless devices in the frequency range of 30 MHz to 6 GHz. ELI is fully compatible with the IEC 62209-2 standard and all known tissue simulating liquids. ELI has been optimized regarding its performance and can be integrated into our standard phantom tables. A cover prevents evaporation of the liquid. Reference markings on the phantom allow installation of the complete setup, including all predefined phantom positions and measurement grids, by teaching three points. The phantom is compatible with all SPEAG dosimetric probes and dipoles.	
Material	Vinylester, glass fiber reinforced (VE-GF)	
Shell Thickness	2.0 ± 0.2 mm (bottom plate)	
Dimensions	Major axis: 600 mm Minor axis: 400 mm	
Filling Volume	approx. 30 liters	

FCC SAR Test Report

3.2.5 Device Holder

Model	Mounting Device	
Construction	In combination with the Twin SAM Phantom or ELI4, the Mounting Device enables the rotation of the mounted transmitter device in spherical coordinates. Rotation point is the ear opening point. Transmitter devices can be easily and accurately positioned according to IEC, IEEE, FCC or other specifications. The device holder can be locked for positioning at different phantom sections (left head, right head, flat).	
Material	POM	

Model	Laptop Extensions Kit	
Construction	Simple but effective and easy-to-use extension for Mounting Device that facilitates the testing of larger devices according to IEC 62209-2 (e.g., laptops, cameras, etc.). It is lightweight and fits easily on the upper part of the Mounting Device in place of the phone positioner.	
Material	POM, Acrylic glass, Foam	

3.2.6 System Validation Dipoles

Model	D-Serial	
Construction	Symmetrical dipole with 1/4 balun. Enables measurement of feed point impedance with NWA. Matched for use near flat phantoms filled with tissue simulating solutions.	
Frequency	750 MHz to 5800 MHz	
Return Loss	> 20 dB	
Power Capability	> 100 W (f < 1GHz), > 40 W (f > 1GHz)	

3.2.7 Tissue Simulating Liquids

For SAR measurement of the field distribution inside the phantom, the phantom must be filled with homogeneous tissue simulating liquid to a depth of at least 15 cm. For head SAR testing, the liquid height from the ear reference point (ERP) of the phantom to the liquid top surface is larger than 15 cm. For body SAR testing, the liquid height from the center of the flat phantom to the liquid top surface is larger than 15 cm. The nominal dielectric values of the tissue simulating liquids in the phantom and the tolerance of 5% are listed in Table-3.1.

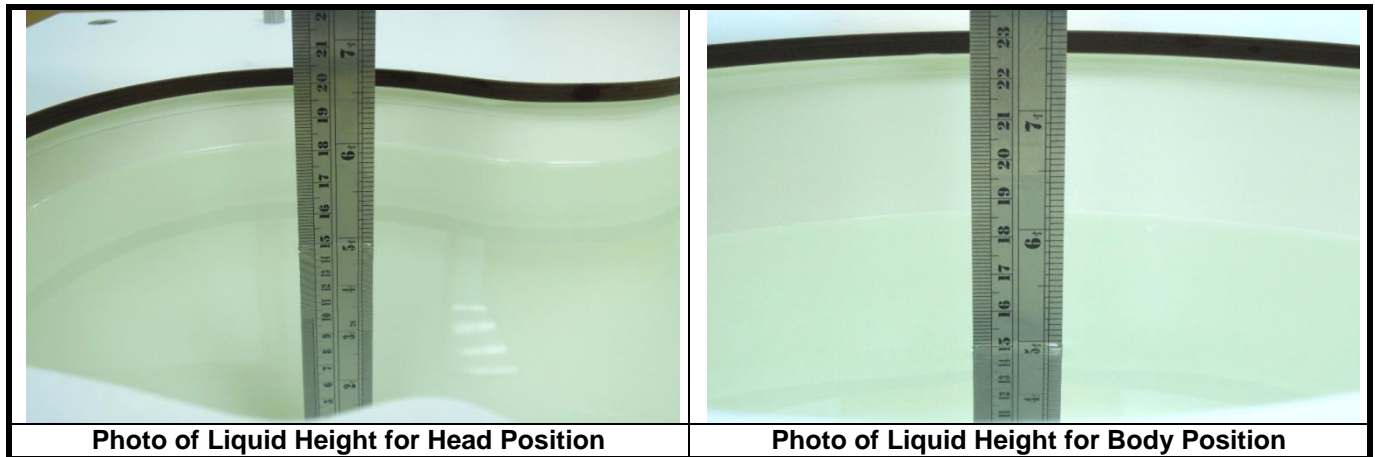

The dielectric properties of the head tissue simulating liquids are defined in IEEE 1528, and KDB 865664 D01 Appendix A. For the body tissue simulating liquids, the dielectric properties are defined in KDB 865664 D01 Appendix A. The dielectric properties of the tissue simulating liquids were verified prior to the SAR evaluation using a dielectric assessment kit and a network analyzer.

Table-3.1 Targets of Tissue Simulating Liquid

Frequency (MHz)	Target Permittivity	Range of $\pm 5\%$	Target Conductivity	Range of $\pm 5\%$
750	41.9	39.8 ~ 44.0	0.89	0.85 ~ 0.93
835	41.5	39.4 ~ 43.6	0.90	0.86 ~ 0.95
900	41.5	39.4 ~ 43.6	0.97	0.92 ~ 1.02
1450	40.5	38.5 ~ 42.5	1.20	1.14 ~ 1.26
1640	40.3	38.3 ~ 42.3	1.29	1.23 ~ 1.35
1750	40.1	38.1 ~ 42.1	1.37	1.30 ~ 1.44
1800	40.0	38.0 ~ 42.0	1.40	1.33 ~ 1.47
1900	40.0	38.0 ~ 42.0	1.40	1.33 ~ 1.47
2000	40.0	38.0 ~ 42.0	1.40	1.33 ~ 1.47
2300	39.5	37.5 ~ 41.5	1.67	1.59 ~ 1.75
2450	39.2	37.2 ~ 41.2	1.80	1.71 ~ 1.89
2600	39.0	37.1 ~ 41.0	1.96	1.86 ~ 2.06
3500	37.9	36.0 ~ 39.8	2.91	2.76 ~ 3.06
5200	36.0	34.2 ~ 37.8	4.66	4.43 ~ 4.89
5300	35.9	34.1 ~ 37.7	4.76	4.52 ~ 5.00
5500	35.6	33.8 ~ 37.4	4.96	4.71 ~ 5.21
5600	35.5	33.7 ~ 37.3	5.07	4.82 ~ 5.32
5800	35.3	33.5 ~ 37.1	5.27	5.01 ~ 5.53

The following table gives the recipes for tissue simulating liquids.

Table-3.2 Recipes of Tissue Simulating Liquid

Tissue Type	Bactericide	DGBE	HEC	NaCl	Sucrose	Triton X-100	Water	Diethylene Glycol Monohexylether
H750	0.2	-	0.2	1.5	56.0	-	42.1	-
H835	0.2	-	0.2	1.5	57.0	-	41.1	-
H900	0.2	-	0.2	1.4	58.0	-	40.2	-
H1450	-	43.3	-	0.6	-	-	56.1	-
H1640	-	45.8	-	0.5	-	-	53.7	-
H1750	-	47.0	-	0.4	-	-	52.6	-
H1800	-	44.5	-	0.3	-	-	55.2	-
H1900	-	44.5	-	0.2	-	-	55.3	-
H2000	-	44.5	-	0.1	-	-	55.4	-
H2300	-	44.9	-	0.1	-	-	55.0	-
H2450	-	45.0	-	0.1	-	-	54.9	-
H2600	-	45.1	-	0.1	-	-	54.8	-
H3500	-	8.0	-	0.2	-	20.0	71.8	-
H5G	-	-	-	-	-	17.2	65.5	17.3

3.3 SAR System Verification

The system check verifies that the system operates within its specifications. It is performed daily or before every SAR measurement. The system check uses normal SAR measurements in the flat section of the phantom with a matched dipole at a specified distance. The system verification setup is shown as below.

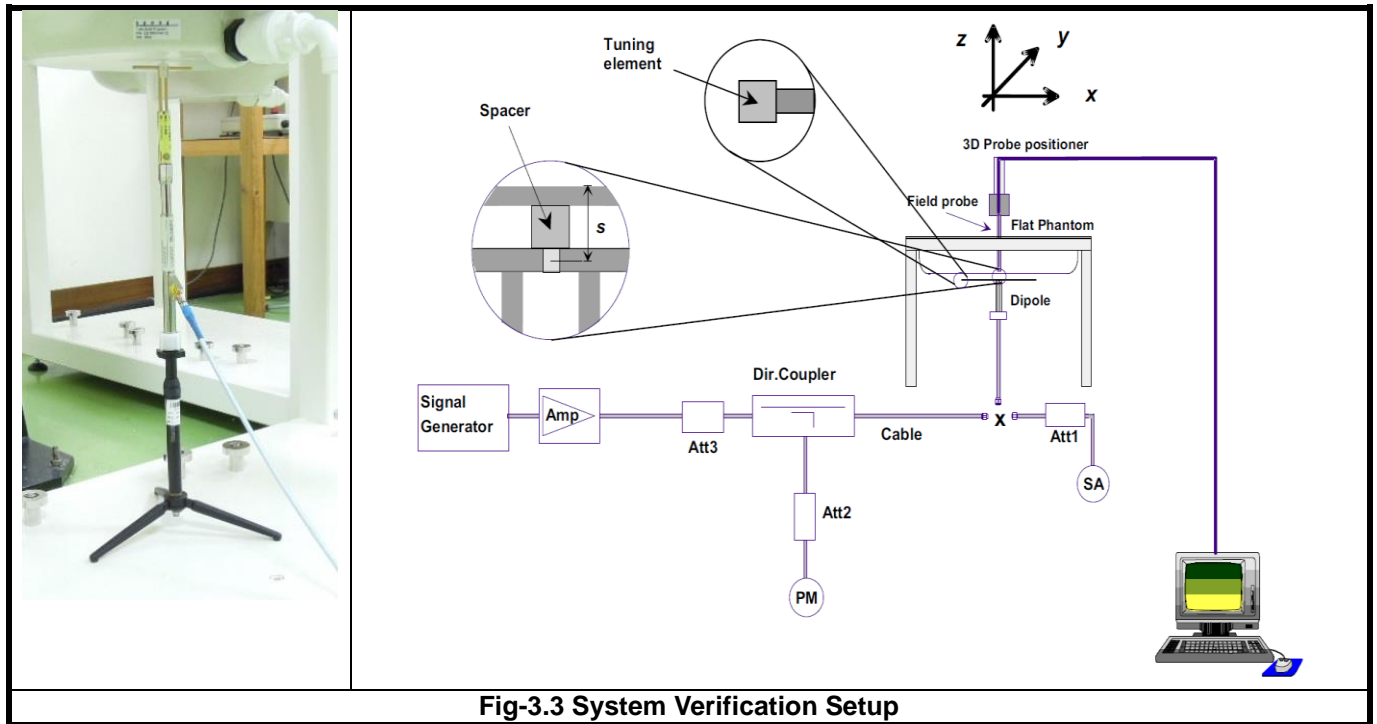

Fig-3.3 System Verification Setup

The validation dipole is placed beneath the flat phantom with the specific spacer in place. The distance spacer is touch the phantom surface with a light pressure at the reference marking and be oriented parallel to the long side of the phantom. The spectrum analyzer measures the forward power at the location of the system check dipole connector. The signal generator is adjusted for the desired forward power (250 mW is used for 700 MHz to 3 GHz, 100 mW is used for 3.5 GHz to 6 GHz) at the dipole connector and the power meter is read at that level. After connecting the cable to the dipole, the signal generator is readjusted for the same reading at power meter.

After system check testing, the SAR result will be normalized to 1W forward input power and compared with the reference SAR value derived from validation dipole certificate report. The deviation of system check should be within 10 %.

3.4 SAR Measurement Procedure

According to the SAR test standard, the recommended procedure for assessing the peak spatial-average SAR value consists of the following steps:

- (a) Power reference measurement
- (b) Area scan
- (c) Zoom scan
- (d) Power drift measurement

The SAR measurement procedures for each of test conditions are as follows:

- (a) Make EUT to transmit maximum output power
- (b) Measure conducted output power through RF cable
- (c) Place the EUT in the specific position of phantom
- (d) Perform SAR testing steps on the DASY system
- (e) Record the SAR value

3.4.1 Area & Zoom Scan Procedure

First Area Scan is used to locate the approximate location(s) of the local peak SAR value(s). The measurement grid within an Area Scan is defined by the grid extent, grid step size and grid offset. Next, in order to determine the EM field distribution in a three-dimensional spatial extension, Zoom Scan is required. The Zoom Scan is performed around the highest E-field value to determine the averaged SAR-distribution over 10 g. According to KDB 865664 D01, the resolution for Area and Zoom scan is specified in the table below.

Items	<= 2 GHz	2-3 GHz	3-4 GHz	4-5 GHz	5-6 GHz
Area Scan ($\Delta x, \Delta y$)	<= 15 mm	<= 12 mm	<= 12 mm	<= 10 mm	<= 10 mm
Zoom Scan ($\Delta x, \Delta y$)	<= 8 mm	<= 5 mm	<= 5 mm	<= 4 mm	<= 4 mm
Zoom Scan (Δz)	<= 5 mm	<= 5 mm	<= 4 mm	<= 3 mm	<= 2 mm
Zoom Scan Volume	>= 30 mm	>= 30 mm	>= 28 mm	>= 25 mm	>= 22 mm

Note:

When zoom scan is required and report SAR is <= 1.4 W/kg, the zoom scan resolution of $\Delta x / \Delta y$ (2-3GHz: <= 8 mm, 3-4GHz: <= 7 mm, 4-6GHz: <= 5 mm) may be applied.

3.4.2 Volume Scan Procedure

The volume scan is used for assess overlapping SAR distributions for antennas transmitting in different frequency bands. It is equivalent to an oversized zoom scan used in standalone measurements. The measurement volume will be used to enclose all the simultaneous transmitting antennas. For antennas transmitting simultaneously in different frequency bands, the volume scan is measured separately in each frequency band. In order to sum correctly to compute the 1g aggregate SAR, the EUT remain in the same test position for all measurements and all volume scan use the same spatial resolution and grid spacing. When all volume scan were completed, the software, SEMCAD postprocessor can combine and subsequently superpose these measurement data to calculating the multiband SAR.

3.4.3 Power Drift Monitoring

All SAR testing is under the EUT install full charged battery and transmit maximum output power. In DASY measurement software, the power reference measurement and power drift measurement procedures are used for monitoring the power drift of EUT during SAR test. Both these procedures measure the field at a specified reference position before and after the SAR testing. The software will calculate the field difference in dB. If the power drift more than 5%, the SAR will be retested.

3.4.4 Spatial Peak SAR Evaluation

The procedure for spatial peak SAR evaluation has been implemented according to the test standard. It can be conducted for 1g and 10g, as well as for user-specific masses. The DASY software includes all numerical procedures necessary to evaluate the spatial peak SAR value.

The base for the evaluation is a "cube" measurement. The measured volume must include the 1g and 10g cubes with the highest averaged SAR values. For that purpose, the center of the measured volume is aligned to the interpolated peak SAR value of a previously performed area scan.

The entire evaluation of the spatial peak values is performed within the post-processing engine (SEMCAD). The system always gives the maximum values for the 1g and 10g cubes. The algorithm to find the cube with highest averaged SAR is divided into the following stages:

- (a) Extraction of the measured data (grid and values) from the Zoom Scan
- (b) Calculation of the SAR value at every measurement point based on all stored data (A/D values and measurement parameters)
- (c) Generation of a high-resolution mesh within the measured volume
- (d) Interpolation of all measured values from the measurement grid to the high-resolution grid
- (e) Extrapolation of the entire 3-D field distribution to the phantom surface over the distance from sensor to surface
- (f) Calculation of the averaged SAR within masses of 1g and 10g

3.4.5 SAR Averaged Methods

In DASY, the interpolation and extrapolation are both based on the modified Quadratic Shepard's method. The interpolation scheme combines a least-square fitted function method and a weighted average method which are the two basic types of computational interpolation and approximation.

Extrapolation routines are used to obtain SAR values between the lowest measurement points and the inner phantom surface. The extrapolation distance is determined by the surface detection distance and the probe sensor offset. The uncertainty increases with the extrapolation distance. To keep the uncertainty within 1% for the 1 g and 10 g cubes, the extrapolation distance should not be larger than 5 mm.

4. SAR Measurement Evaluation

4.1 EUT Configuration and Setting

<Considerations Related to WLAN for Setup and Testing>

In general, various vendor specific external test software and chipset based internal test modes are typically used for SAR measurement. These chipset based test mode utilities are generally hardware and manufacturer dependent, and often include substantial flexibility to reconfigure or reprogram a device. A Wi-Fi device must be configured to transmit continuously at the required data rate, channel bandwidth and signal modulation, using the highest transmission duty factor supported by the test mode tools for SAR measurement. The test frequencies established using test mode must correspond to the actual channel frequencies. When 802.11 frame gaps are accounted for in the transmission, a maximum transmission duty factor of 92 - 96% is typically achievable in most test mode configurations. A minimum transmission duty factor of 85% is required to avoid certain hardware and device implementation issues related to wide range SAR scaling. In addition, a periodic transmission duty factor is required for current generation SAR systems to measure SAR correctly. The reported SAR must be scaled to 100% transmission duty factor to determine compliance at the maximum tune-up tolerance limit.

According to KDB 248227 D01, this device has installed WLAN engineering testing software which can provide continuous transmitting RF signal. During WLAN SAR testing, this device was operated to transmit continuously at the maximum transmission duty with specified transmission mode, operating frequency, lowest data rate, and maximum output power.

Initial Test Configuration

An initial test configuration is determined for OFDM transmission modes in 2.4 GHz and 5 GHz bands according to the channel bandwidth, modulation and data rate combination(s) with the highest maximum output power specified for production units in each standalone and aggregated frequency band. When the same maximum power is specified for multiple transmission modes in a frequency band, the largest channel bandwidth, lowest order modulation, lowest data rate and lowest order 802.11a/g/n/ac mode is used for SAR measurement, on the highest measured output power channel in the initial test configuration, for each frequency band.

Subsequent Test Configuration

SAR measurement requirements for the remaining 802.11 transmission mode configurations that have not been tested in the initial test configuration are determined separately for each standalone and aggregated frequency band, in each exposure condition, according to the maximum output power specified for production units. Additional power measurements may be required to determine if SAR measurements are required for subsequent highest output power channels in a subsequent test configuration. When the highest reported SAR for the initial test configuration according to the initial test position or fixed exposure position requirements, is adjusted by the ratio of the subsequent test configuration to initial test configuration specified maximum output power and the adjusted SAR is ≤ 1.2 W/kg, SAR is not required for that subsequent test configuration.

SAR Test Configuration and Channel Selection

When multiple channel bandwidth configurations in a frequency band have the same specified maximum output power, the initial test configuration is using largest channel bandwidth, lowest order modulation, lowest data rate, and lowest order 802.11 mode (i.e., 802.11a is chosen over 802.11n then 802.11ac or 802.11g is chosen over 802.11n). After an initial test configuration is determined, if multiple test channels have the same measured maximum output power, the channel chosen for SAR measurement is determined according to the following.

- 1) The channel closest to mid-band frequency is selected for SAR measurement.
- 2) For channels with equal separation from mid-band frequency; for example, high and low channels or two mid-band channels, the higher frequency (number) channel is selected for SAR measurement.

Test Reduction for U-NII-1 (5.2 GHz) and U-NII-2A (5.3 GHz) Bands

For devices that operate in both U-NII bands using the same transmitter and antenna(s), SAR test reduction is determined according to the following.

- 1) When the same maximum output power is specified for both bands, begin SAR measurement in U-NII-2A band by applying the OFDM SAR requirements. If the highest reported SAR for a test configuration is ≤ 1.2 W/kg, SAR is not required for U-NII-1 band for that configuration (802.11 mode and exposure condition).
- 2) When different maximum output power is specified for the bands, begin SAR measurement in the band with higher specified maximum output power. The highest reported SAR for the tested configuration is adjusted by the ratio of lower to higher specified maximum output power for the two bands. When the adjusted SAR is ≤ 1.2 W/kg, SAR is not required for the band with lower maximum output power in that test configuration.

FCC SAR Test Report

<Considerations Related to Bluetooth for Setup and Testing>

This device has installed Bluetooth engineering testing software which can provide continuous transmitting RF signal. During Bluetooth SAR testing, this device was operated to transmit continuously at the maximum transmission duty with specified transmission mode, operating frequency, lowest data rate, and maximum output power.

The Bluetooth call box has been used during SAR measurement and the EUT was set to DH5 mode at the maximum output power. Its duty factor was calculated as below and the measured SAR for Bluetooth would be scaled to the 100% transmission duty factor to determine compliance.

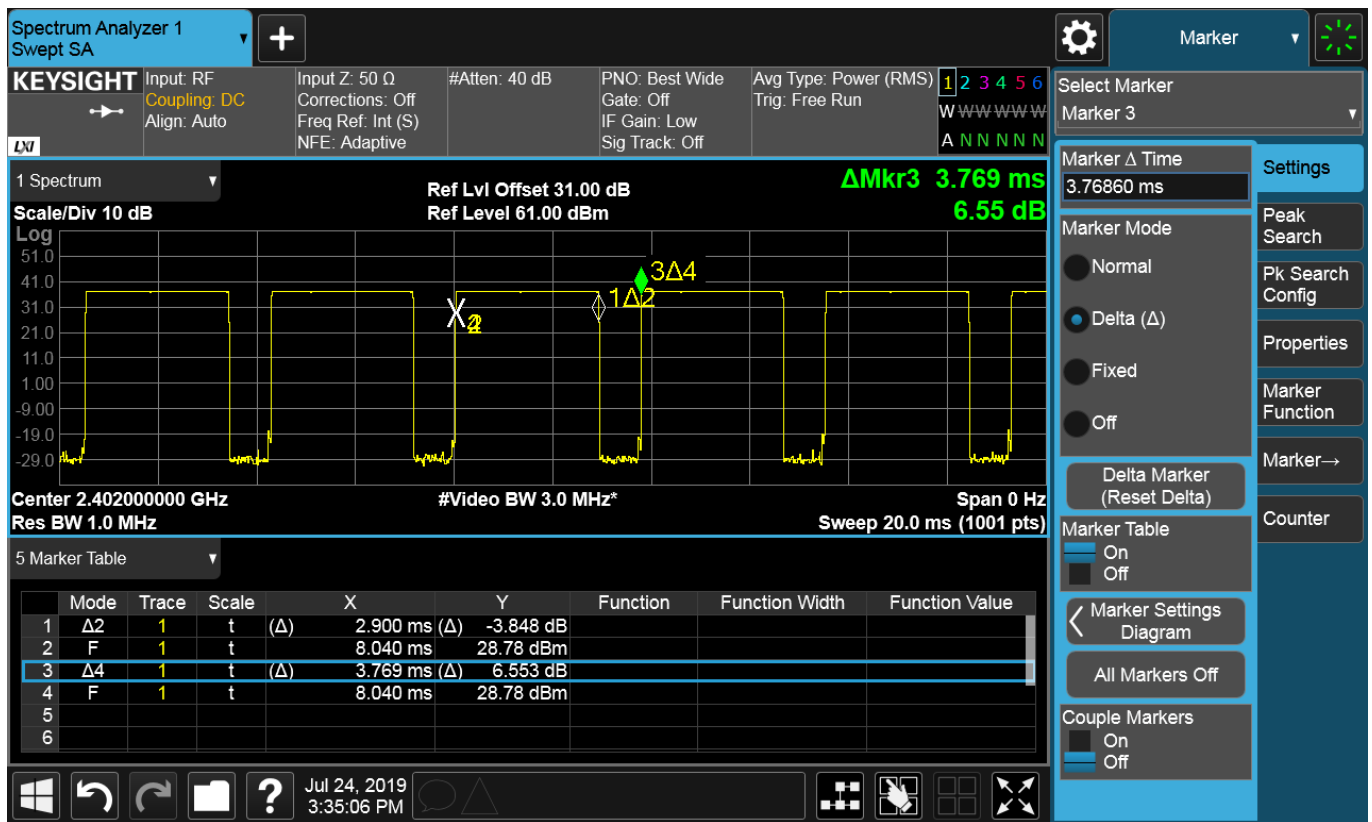

Time-domain plot for Bluetooth transmission signal

The duty factor of Bluetooth signal has been calculated as following.

$$\text{Duty Factor} = \text{Pulse Width} / \text{Total Period} = (2.900) / (3.769) = 76.94 \%$$

4.2 EUT Testing Position

4.2.1 Body Exposure Conditions

For mode 1, SAR evaluation is required for back surface and edges. For mode, SAR evaluation is required for the bottom surface of the keyboard.

FCC SAR Test Report

4.2.2 SAR Test Exclusion Evaluations

According to KDB 447498 D01, the SAR test exclusion condition is based on source-based time-averaged maximum conducted output power, adjusted for tune-up tolerance, and the minimum test separation distance required for the exposure conditions. The SAR exclusion threshold is determined by the following formula.

1. For the test separation distance ≤ 50 mm

$$\frac{\text{Max. Tune up Power}_{(mW)}}{\text{Min. Test Separation Distance}_{(mm)}} \times \sqrt{f_{(GHz)}} \leq 3.0 \text{ for SAR-1g, } \leq 7.5 \text{ for SAR-10g}$$

When the minimum test separation distance is < 5 mm, a distance of 5 mm is applied to determine SAR test exclusion.

2. For the test separation distance > 50 mm, and the frequency at 100 MHz to 1500 MHz

$$\left[(\text{Threshold at 50 mm in Step 1}) + (\text{Test Separation Distance} - 50 \text{ mm}) \times \left(\frac{f_{(MHz)}}{150} \right) \right]_{(mW)}$$

3. For the test separation distance > 50 mm, and the frequency at > 1500 MHz to 6 GHz

$$[(\text{Threshold at 50 mm in Step 1}) + (\text{Test Separation Distance} - 50 \text{ mm}) \times 10]_{(mW)}$$

<For WLAN Ant-0>

Mode	Max. Tune-up Power (dBm)	Max. Tune-up Power (mW)	Rear Face			Left Side			Right Side			Top Side			Bottom Side		
			Ant. to Surface (mm)	Calculated Result	Require SAR Testing?	Ant. to Surface (mm)	Calculated Result	Require SAR Testing?	Ant. to Surface (mm)	Calculated Result	Require SAR Testing?	Ant. to Surface (mm)	Calculated Result	Require SAR Testing?	Ant. to Surface (mm)	Calculated Result	Require SAR Testing?
WLAN 2.4G	10.5	11	5	3.46	Yes	77.13	367 mW	No	168.37	1279 mW	No	1.77	3.45	Yes	190.96	1505 mW	No
WLAN 5.2G	10.5	11	5	5.04	Yes	77.13	337 mW	No	168.37	1249 mW	No	1.77	5.04	Yes	190.96	1475 mW	No
WLAN 5.3G	10.5	11	5	5.07	Yes	77.13	336 mW	No	168.37	1249 mW	No	1.77	5.07	Yes	190.96	1475 mW	No
WLAN 5.6G	10.5	11	5	5.26	Yes	77.13	334 mW	No	168.37	1246 mW	No	1.77	5.26	Yes	190.96	1472 mW	No
WLAN 5.8G	10.5	11	5	5.31	Yes	77.13	333 mW	No	168.37	1246 mW	No	1.77	5.31	Yes	190.96	1472 mW	No

<For BT/WLAN Ant-1>

Mode	Max. Tune-up Power (dBm)	Max. Tune-up Power (mW)	Rear Face			Left Side			Right Side			Top Side			Bottom Side		
			Ant. to Surface (mm)	Calculated Result	Require SAR Testing?	Ant. to Surface (mm)	Calculated Result	Require SAR Testing?	Ant. to Surface (mm)	Calculated Result	Require SAR Testing?	Ant. to Surface (mm)	Calculated Result	Require SAR Testing?	Ant. to Surface (mm)	Calculated Result	Require SAR Testing?
WLAN 2.4G	10.5	11	5	3.46	Yes	210.57	1701 mW	No	63.63	232 mW	No	1.77	3.45	Yes	190.96	1505 mW	No
WLAN 5.2G	10.5	11	5	5.04	Yes	210.57	1671 mW	No	63.63	202 mW	No	1.77	5.04	Yes	190.96	1475 mW	No
WLAN 5.3G	10.5	11	5	5.07	Yes	210.57	1671 mW	No	63.63	201 mW	No	1.77	5.07	Yes	190.96	1475 mW	No
WLAN 5.6G	10.5	11	5	5.26	Yes	210.57	1668 mW	No	63.63	199 mW	No	1.77	5.26	Yes	190.96	1472 mW	No
WLAN 5.8G	10.5	11	5	5.31	Yes	210.57	1668 mW	No	63.63	198 mW	No	1.77	5.31	Yes	190.96	1472 mW	No
BT	9.0	8	5	2.52	No	210.57	1701 mW	No	63.63	232 mW	No	1.77	2.52	No	190.96	1505 mW	No

FCC SAR Test Report

<For WLAN Ant-0 + Ant-1>

Mode	Max. Tune-up Power (dBm)	Max. Tune-up Power (mW)	Rear Face			Left Side			Right Side			Top Side			Bottom Side		
			Ant. to Surface (mm)	Calculated Result	Require SAR Testing?	Ant. to Surface (mm)	Calculated Result	Require SAR Testing?	Ant. to Surface (mm)	Calculated Result	Require SAR Testing?	Ant. to Surface (mm)	Calculated Result	Require SAR Testing?	Ant. to Surface (mm)	Calculated Result	Require SAR Testing?
WLAN 2.4G	10.5	11	5	3.46	Yes	77.13	367 mW	No	63.63	232 mW	No	1.77	3.45	Yes	190.96	1505 mW	No
WLAN 5.2G	10.5	11	5	5.04	Yes	77.13	337 mW	No	63.63	202 mW	No	1.77	5.04	Yes	190.96	1475 mW	No
WLAN 5.3G	10.5	11	5	5.07	Yes	77.13	336 mW	No	63.63	201 mW	No	1.77	5.07	Yes	190.96	1475 mW	No
WLAN 5.6G	10.5	11	5	5.26	Yes	77.13	334 mW	No	63.63	199 mW	No	1.77	5.26	Yes	190.96	1472 mW	No
WLAN 5.8G	10.5	11	5	5.31	Yes	77.13	333 mW	No	63.63	198 mW	No	1.77	5.31	Yes	190.96	1472 mW	No

4.3 Tissue Verification

The measuring results for tissue simulating liquid are shown as below.

Test Date	Frequency (MHz)	Liquid Temp. (°C)	Measured Conductivity (σ)	Measured Permittivity (ϵ_r)	Target Conductivity (σ)	Target Permittivity (ϵ_r)	Conductivity Deviation (%)	Permittivity Deviation (%)
Jul. 08, 2019	2450	23.2	1.871	38.915	1.8	39.2	3.94	-0.73
Jul. 09, 2019	2450	23.4	1.852	38.607	1.8	39.2	2.89	-1.51
Jul. 10, 2019	2450	23.3	1.861	38.747	1.8	39.2	3.39	-1.16
Jul. 17, 2019	2450	23.3	1.829	38.581	1.8	39.2	1.61	-1.58
Jul. 08, 2019	5250	23.2	4.601	35.761	4.71	35.9	-2.31	-0.39
Jul. 09, 2019	5250	23.3	4.606	35.721	4.71	35.9	-2.21	-0.50
Jul. 11, 2019	5250	23.3	4.633	37.51	4.71	35.9	-1.63	4.48
Jul. 18, 2019	5250	23.2	4.852	35.71	4.71	35.9	3.01	-0.53
Jul. 08, 2019	5600	23.2	4.965	35.254	5.07	35.5	-2.07	-0.69
Jul. 09, 2019	5600	23.3	4.972	35.216	5.07	35.5	-1.93	-0.80
Jul. 11, 2019	5600	23.3	5.056	36.215	5.07	35.5	-0.28	2.01
Jul. 19, 2019	5600	23.2	5.006	36.08	5.07	35.5	-1.26	1.63
Jul. 24, 2019	5600	23.4	5.179	34.605	5.07	35.5	2.15	-2.52
Jul. 08, 2019	5750	23.2	5.142	35.078	5.22	35.4	-1.49	-0.91
Jul. 10, 2019	5750	23.3	5.147	35.033	5.22	35.4	-1.40	-1.04
Jul. 11, 2019	5750	23.3	5.099	36.378	5.22	35.4	-2.32	2.76
Jul. 20, 2019	5750	23.3	5.278	34.377	5.22	35.4	1.11	-2.89

Note:

The dielectric properties of the tissue simulating liquid must be measured within 24 hours before the SAR testing and within $\pm 5\%$ of the target values. Liquid temperature during the SAR testing must be within ± 2 °C.

FCC SAR Test Report

4.4 System Validation

The SAR measurement system was validated according to procedures in KDB 865664 D01. The validation status in tabulated summary is as below.

Test Date	Probe S/N	Calibration Point	Measured Conductivity (σ)	Measured Permittivity (ϵ_r)	Validation for CW			Validation for Modulation		
					Sensitivity Range	Probe Linearity	Probe Isotropy	Modulation Type	Duty Factor	PAR
Jul. 08, 2019	3971	2450	1.871	38.915	Pass	Pass	Pass	OFDM	N/A	Pass
Jul. 09, 2019	3650	2450	1.852	38.607	Pass	Pass	Pass	OFDM	N/A	Pass
Jul. 10, 2019	7375	2450	1.861	38.747	Pass	Pass	Pass	OFDM	N/A	Pass
Jul. 17, 2019	7375	2450	1.829	38.581	Pass	Pass	Pass	OFDM	N/A	Pass
Jul. 08, 2019	3971	5250	4.601	35.761	Pass	Pass	Pass	OFDM	N/A	Pass
Jul. 09, 2019	7375	5250	4.606	35.721	Pass	Pass	Pass	OFDM	N/A	Pass
Jul. 11, 2019	3971	5250	4.633	37.51	Pass	Pass	Pass	OFDM	N/A	Pass
Jul. 18, 2019	7375	5250	4.852	35.71	Pass	Pass	Pass	OFDM	N/A	Pass
Jul. 08, 2019	3971	5600	4.965	35.254	Pass	Pass	Pass	OFDM	N/A	Pass
Jul. 09, 2019	7375	5600	4.972	35.216	Pass	Pass	Pass	OFDM	N/A	Pass
Jul. 11, 2019	7375	5600	5.056	36.215	Pass	Pass	Pass	OFDM	N/A	Pass
Jul. 19, 2019	7375	5600	5.006	36.08	Pass	Pass	Pass	OFDM	N/A	Pass
Jul. 24, 2019	3971	5600	5.179	34.605	Pass	Pass	Pass	OFDM	N/A	Pass
Jul. 08, 2019	3971	5750	5.142	35.078	Pass	Pass	Pass	OFDM	N/A	Pass
Jul. 10, 2019	7375	5750	5.147	35.033	Pass	Pass	Pass	OFDM	N/A	Pass
Jul. 11, 2019	7375	5750	5.099	36.378	Pass	Pass	Pass	OFDM	N/A	Pass
Jul. 20, 2019	7375	5750	5.278	34.377	Pass	Pass	Pass	OFDM	N/A	Pass

4.5 System Verification

The measuring result for system verification is tabulated as below.

Test Date	Frequency (MHz)	Input Power (mW)	1W Target SAR-1g (W/kg)	Measured SAR-1g (W/kg)	Normalized to 1W SAR-1g (W/kg)	Deviation (%)	Dipole S/N	Probe S/N	DAE S/N
Jul. 08, 2019	2450	250	51.50	13	52.00	0.97	737	3971	1431
Jul. 09, 2019	2450	250	51.50	13.3	53.20	3.30	737	3650	861
Jul. 10, 2019	2450	250	51.50	13.9	55.60	7.96	737	7375	1277
Jul. 17, 2019	2450	250	51.50	13	52.00	0.97	737	7375	1277
Jul. 08, 2019	5250	100	80.70	7.96	79.60	-1.36	1019	3971	1431
Jul. 09, 2019	5250	100	80.70	8.28	82.80	2.60	1019	7375	1277
Jul. 11, 2019	5250	100	80.70	8.01	80.10	-0.74	1019	3971	1431
Jul. 18, 2019	5250	100	80.70	8.05	80.50	-0.25	1019	7375	1277
Jul. 08, 2019	5600	100	85.80	8.35	83.50	-2.68	1019	3971	1431
Jul. 09, 2019	5600	100	85.80	8.45	84.50	-1.52	1019	7375	1277
Jul. 11, 2019	5600	100	85.80	8.43	84.30	-1.75	1019	7375	1277
Jul. 19, 2019	5600	100	85.80	8.7	87.00	1.40	1019	7375	1277
Jul. 24, 2019	5600	100	85.80	8.41	84.10	-1.98	1019	3971	1431
Jul. 08, 2019	5750	100	81.50	7.55	75.50	-7.36	1019	3971	1431
Jul. 10, 2019	5750	100	81.50	8.12	81.20	-0.37	1019	7375	1277
Jul. 11, 2019	5750	100	81.50	8.75	87.50	7.36	1019	7375	1277
Jul. 20, 2019	5750	100	81.50	7.58	75.80	-6.99	1019	7375	1277

Note:

Comparing to the reference SAR value provided by SPEAG, the validation data should be within its specification of 10 %. The result indicates the system check can meet the variation criterion and the plots can be referred to Appendix A of this report.

The input power

4.6 Maximum Output Power

4.6.1 Maximum Target Conducted Power

The maximum conducted average power (Unit: dBm) including tune-up tolerance is shown as below.

Mode 1

<WLAN 2.4G>

Mode	Channel	Frequency (MHz)	Tune-up Power (SISO Ant-0)	Tune-up Power (SISO Ant-1)
802.11b	1	2412	10.5	10.5
	6	2437	10.5	10.5
	11	2462	10.5	10.5
	12	2467	10.5	10.5
	13	2472	10.5	10.5
802.11g	1	2412	10.5	10.5
	6	2437	10.5	10.5
	11	2462	10.5	10.5
	12	2467	10.5	10.5
	13	2472	10.5	10.5
802.11n (HT20)	1	2412	10.5	10.5
	6	2437	10.5	10.5
	11	2462	10.5	10.5
	12	2467	10.5	10.5
	13	2472	10.5	10.5
802.11n (HT40)	3	2422	10.5	10.5
	6	2437	10.5	10.5
	9	2452	10.5	10.5
	10	2457	10.5	10.5
	11	2462	10.5	10.5
802.11ac (VHT20)	1	2412	10.5	10.5
	6	2437	10.5	10.5
	11	2462	10.5	10.5
	12	2467	10.5	10.5
	13	2472	10.5	10.5
802.11ac (VHT40)	3	2422	10.5	10.5
	6	2437	10.5	10.5
	9	2452	10.5	10.5
	10	2457	10.5	10.5
	11	2462	10.5	10.5
802.11ax (HE20)	1	2412	10.5	10.5
	6	2437	10.5	10.5
	11	2462	10.5	10.5
	12	2467	10.5	10.5
	13	2472	10.5	10.5
802.11ax (HE40)	3	2422	10.5	10.5
	6	2437	10.5	10.5
	9	2452	10.5	10.5
	10	2457	10.5	10.5
	11	2462	10.5	10.5

FCC SAR Test Report

Mode	Channel	Frequency (MHz)	Tune-up Power (MIMO Ant-0)	Tune-up Power (MIMO Ant-1)	Tune-up Power (MIMO Ant-0 + Ant-1)
802.11n (HT20)	1	2412	7.5	7.5	10.5
	6	2437	7.5	7.5	10.5
	11	2462	7.5	7.5	10.5
	12	2467	7.5	7.5	10.5
	13	2472	7.5	7.5	10.5
802.11n (HT40)	3	2422	7.5	7.5	10.5
	6	2437	7.5	7.5	10.5
	9	2452	7.5	7.5	10.5
	10	2457	7.5	7.5	10.5
	11	2462	7.5	7.5	10.5
802.11ac (VHT20)	1	2412	7.5	7.5	10.5
	6	2437	7.5	7.5	10.5
	11	2462	7.5	7.5	10.5
	12	2467	7.5	7.5	10.5
	13	2472	7.5	7.5	10.5
802.11ac (VHT40)	3	2422	7.5	7.5	10.5
	6	2437	7.5	7.5	10.5
	9	2452	7.5	7.5	10.5
	10	2457	7.5	7.5	10.5
	11	2462	7.5	7.5	10.5
802.11ax (HE20)	1	2412	7.5	7.5	10.5
	6	2437	7.5	7.5	10.5
	11	2462	7.5	7.5	10.5
	12	2467	7.5	7.5	10.5
	13	2472	7.5	7.5	10.5
802.11ax (HE40)	3	2422	7.5	7.5	10.5
	6	2437	7.5	7.5	10.5
	9	2452	7.5	7.5	10.5
	10	2457	7.5	7.5	10.5
	11	2462	7.5	7.5	10.5

FCC SAR Test Report

<WLAN 5.2G>

Mode	Channel	Frequency (MHz)	Tune-up Power (SISO Ant-0)	Tune-up Power (SISO Ant-1)
802.11a	36	5180	10.5	10.5
	40	5200	10.5	10.5
	44	5220	10.5	10.5
	48	5240	10.5	10.5
802.11n (HT20)	36	5180	10.5	10.5
	40	5200	10.5	10.5
	44	5220	10.5	10.5
	48	5240	10.5	10.5
802.11n (HT40)	38	5190	10.5	10.5
	46	5230	10.5	10.5
802.11ac (VHT20)	36	5180	10.5	10.5
	40	5200	10.5	10.5
	44	5220	10.5	10.5
	48	5240	10.5	10.5
802.11ac (VHT40)	38	5190	10.5	10.5
	46	5230	10.5	10.5
802.11ac (VHT80)	42	5210	10.5	10.5
802.11ax (HE20)	36	5180	10.5	10.5
	40	5200	10.5	10.5
	44	5220	10.5	10.5
	48	5240	10.5	10.5
802.11ax (HE40)	38	5190	10.5	10.5
	46	5230	10.5	10.5
802.11ax (HE80)	42	5210	10.5	10.5

Mode	Channel	Frequency (MHz)	Tune-up Power (MIMO Ant-0)	Tune-up Power (MIMO Ant-1)	Tune-up Power (MIMO Ant-0 + Ant-1)
802.11n (HT20)	36	5180	7.5	7.5	10.5
	40	5200	7.5	7.5	10.5
	44	5220	7.5	7.5	10.5
	48	5240	7.5	7.5	10.5
802.11n (HT40)	38	5190	7.5	7.5	10.5
	46	5230	7.5	7.5	10.5
802.11ac (VHT20)	36	5180	7.5	7.5	10.5
	40	5200	7.5	7.5	10.5
	44	5220	7.5	7.5	10.5
	48	5240	7.5	7.5	10.5
802.11ac (VHT40)	38	5190	7.5	7.5	10.5
	46	5230	7.5	7.5	10.5
802.11ac (VHT80)	42	5210	7.5	7.5	10.5
802.11ax (HE20)	36	5180	7.5	7.5	10.5
	40	5200	7.5	7.5	10.5
	44	5220	7.5	7.5	10.5
	48	5240	7.5	7.5	10.5
802.11ax (HE40)	38	5190	7.5	7.5	10.5
	46	5230	7.5	7.5	10.5
802.11ax (HE80)	42	5210	7.5	7.5	10.5

FCC SAR Test Report

<WLAN 5.3G>

Mode	Channel	Frequency (MHz)	Tune-up Power (SISO Ant-0)	Tune-up Power (SISO Ant-1)
802.11a	52	5260	10.5	10.5
	56	5280	10.5	10.5
	60	5300	10.5	10.5
	64	5320	10.5	10.5
802.11n (HT20)	52	5260	10.5	10.5
	56	5280	10.5	10.5
	60	5300	10.5	10.5
	64	5320	10.5	10.5
802.11n (HT40)	54	5270	10.5	10.5
	62	5310	10.5	10.5
802.11ac (VHT20)	52	5260	10.5	10.5
	56	5280	10.5	10.5
	60	5300	10.5	10.5
	64	5320	10.5	10.5
802.11ac (VHT40)	54	5270	10.5	10.5
	62	5310	10.5	10.5
802.11ac (VHT80)	58	5290	10.5	10.5
802.11ac (VHT160)	50	5250	10.5	10.5
802.11ax (HE20)	52	5260	10.5	10.5
	56	5280	10.5	10.5
	60	5300	10.5	10.5
	64	5320	10.5	10.5
802.11ax (HE40)	54	5270	10.5	10.5
	62	5310	10.5	10.5
802.11ax (HE80)	58	5290	10.5	10.5
802.11ax (HE160)	50	5250	10.5	10.5

Mode	Channel	Frequency (MHz)	Tune-up Power (MIMO Ant-0)	Tune-up Power (MIMO Ant-1)	Tune-up Power (MIMO Ant-0 + Ant-1)
802.11n (HT20)	52	5260	7.5	7.5	10.5
	56	5280	7.5	7.5	10.5
	60	5300	7.5	7.5	10.5
	64	5320	7.5	7.5	10.5
802.11n (HT40)	54	5270	7.5	7.5	10.5
	62	5310	7.5	7.5	10.5
802.11ac (VHT20)	52	5260	7.5	7.5	10.5
	56	5280	7.5	7.5	10.5
	60	5300	7.5	7.5	10.5
	64	5320	7.5	7.5	10.5
802.11ac (VHT40)	54	5270	7.5	7.5	10.5
	62	5310	7.5	7.5	10.5
802.11ac (VHT80)	58	5290	7.5	7.5	10.5
802.11ac (VHT160)	50	5250	7.5	7.5	10.5
802.11ax (HE20)	52	5260	7.5	7.5	10.5
	56	5280	7.5	7.5	10.5
	60	5300	7.5	7.5	10.5
	64	5320	7.5	7.5	10.5
802.11ax (HE40)	54	5270	7.5	7.5	10.5
	62	5310	7.5	7.5	10.5
802.11ax (HE80)	58	5290	7.5	7.5	10.5
802.11ax (HE160)	50	5250	7.5	7.5	10.5

FCC SAR Test Report

<WLAN 5.6G>

Mode	Channel	Frequency (MHz)	Tune-up Power (SISO Ant-0)	Tune-up Power (SISO Ant-1)
802.11a	100	5500	10.5	10.5
	116	5580	10.5	10.5
	120	5600	10.5	10.5
	124	5620	10.5	10.5
	132	5660	10.5	10.5
	140	5700	10.5	10.5
	144	5720	10.5	10.5
802.11n (HT20)	100	5500	10.5	10.5
	116	5580	10.5	10.5
	120	5600	10.5	10.5
	124	5620	10.5	10.5
	132	5660	10.5	10.5
	140	5700	10.5	10.5
	144	5720	10.5	10.5
802.11n (HT40)	102	5510	10.5	10.5
	110	5550	10.5	10.5
	118	5590	10.5	10.5
	126	5630	10.5	10.5
	134	5670	10.5	10.5
	142	5710	10.5	10.5
	144	5720	10.5	10.5
802.11ac (VHT20)	100	5500	10.5	10.5
	116	5580	10.5	10.5
	120	5600	10.5	10.5
	124	5620	10.5	10.5
	132	5660	10.5	10.5
	140	5700	10.5	10.5
	144	5720	10.5	10.5
802.11ac (VHT40)	102	5510	10.5	10.5
	110	5550	10.5	10.5
	118	5590	10.5	10.5
	126	5630	10.5	10.5
	134	5670	10.5	10.5
	142	5710	10.5	10.5
	144	5720	10.5	10.5
802.11ac (VHT80)	106	5530	10.5	10.5
	122	5610	10.5	10.5
	138	5690	10.5	10.5
802.11ac (VHT160)	114	5570	10.5	10.5
802.11ax (HE20)	100	5500	10.5	10.5
	116	5580	10.5	10.5
	120	5600	10.5	10.5
	124	5620	10.5	10.5
	132	5660	10.5	10.5
	140	5700	10.5	10.5
	144	5720	10.5	10.5
802.11ax (HE40)	102	5510	10.5	10.5
	110	5550	10.5	10.5
	118	5590	10.5	10.5
	126	5630	10.5	10.5
	134	5670	10.5	10.5
	142	5710	10.5	10.5
	144	5720	10.5	10.5
802.11ax (HE80)	106	5530	10.5	10.5
	122	5610	10.5	10.5
	138	5690	10.5	10.5
802.11ax (HE160)	114	5570	10.5	10.5

FCC SAR Test Report

Mode	Channel	Frequency (MHz)	Tune-up Power (MIMO Ant-0)	Tune-up Power (MIMO Ant-1)	Tune-up Power (MIMO Ant-0 + Ant-1)
802.11n (HT20)	100	5500	7.5	7.5	10.5
	116	5580	7.5	7.5	10.5
	120	5600	7.5	7.5	10.5
	124	5620	7.5	7.5	10.5
	132	5660	7.5	7.5	10.5
	140	5700	7.5	7.5	10.5
	144	5720	7.5	7.5	10.5
802.11n (HT40)	102	5510	7.5	7.5	10.5
	110	5550	7.5	7.5	10.5
	118	5590	7.5	7.5	10.5
	126	5630	7.5	7.5	10.5
	134	5670	7.5	7.5	10.5
	142	5710	7.5	7.5	10.5
802.11ac (VHT20)	100	5500	7.5	7.5	10.5
	116	5580	7.5	7.5	10.5
	120	5600	7.5	7.5	10.5
	124	5620	7.5	7.5	10.5
	132	5660	7.5	7.5	10.5
	140	5700	7.5	7.5	10.5
	144	5720	7.5	7.5	10.5
802.11ac (VHT40)	102	5510	7.5	7.5	10.5
	110	5550	7.5	7.5	10.5
	118	5590	7.5	7.5	10.5
	126	5630	7.5	7.5	10.5
	134	5670	7.5	7.5	10.5
	142	5710	7.5	7.5	10.5
802.11ac (VHT80)	106	5530	7.5	7.5	10.5
	122	5610	7.5	7.5	10.5
	138	5690	7.5	7.5	10.5
802.11ac (VHT160)	114	5570	7.5	7.5	10.5
802.11ax (HE20)	100	5500	7.5	7.5	10.5
	116	5580	7.5	7.5	10.5
	120	5600	7.5	7.5	10.5
	124	5620	7.5	7.5	10.5
	132	5660	7.5	7.5	10.5
	140	5700	7.5	7.5	10.5
	144	5720	7.5	7.5	10.5
802.11ax (HE40)	102	5510	7.5	7.5	10.5
	110	5550	7.5	7.5	10.5
	118	5590	7.5	7.5	10.5
	126	5630	7.5	7.5	10.5
	134	5670	7.5	7.5	10.5
	142	5710	7.5	7.5	10.5
802.11ax (HE80)	106	5530	7.5	7.5	10.5
	122	5610	7.5	7.5	10.5
	138	5690	7.5	7.5	10.5
802.11ax (HE160)	114	5570	7.5	7.5	10.5

FCC SAR Test Report

<WLAN 5.8G>

Mode	Channel	Frequency (MHz)	Tune-up Power (SISO Ant-0)	Tune-up Power (SISO Ant-1)
802.11a	149	5745	10.5	10.5
	153	5765	10.5	10.5
	157	5785	10.5	10.5
	161	5805	10.5	10.5
	165	5825	10.5	10.5
802.11n (HT20)	149	5745	10.5	10.5
	153	5765	10.5	10.5
	157	5785	10.5	10.5
	161	5805	10.5	10.5
	165	5825	10.5	10.5
802.11n (HT40)	151	5755	10.5	10.5
	159	5795	10.5	10.5
802.11ac (VHT20)	149	5745	10.5	10.5
	153	5765	10.5	10.5
	157	5785	10.5	10.5
	161	5805	10.5	10.5
	165	5825	10.5	10.5
802.11ac (VHT40)	151	5755	10.5	10.5
	159	5795	10.5	10.5
802.11ac (VHT80)	155	5775	10.5	10.5
802.11ax (HE20)	149	5745	10.5	10.5
	153	5765	10.5	10.5
	157	5785	10.5	10.5
	161	5805	10.5	10.5
	165	5825	10.5	10.5
802.11ax (HE40)	151	5755	10.5	10.5
	159	5795	10.5	10.5
802.11ax (HE80)	155	5775	10.5	10.5

FCC SAR Test Report

Mode	Channel	Frequency (MHz)	Tune-up Power (MIMO Ant-0)	Tune-up Power (MIMO Ant-1)	Tune-up Power (MIMO Ant-0 + Ant-1)
802.11n (HT20)	149	5745	7.5	7.5	10.5
	153	5765	7.5	7.5	10.5
	157	5785	7.5	7.5	10.5
	161	5805	7.5	7.5	10.5
	165	5825	7.5	7.5	10.5
802.11n (HT40)	151	5755	7.5	7.5	10.5
	159	5795	7.5	7.5	10.5
802.11ac (VHT20)	149	5745	7.5	7.5	10.5
	153	5765	7.5	7.5	10.5
	157	5785	7.5	7.5	10.5
	161	5805	7.5	7.5	10.5
	165	5825	7.5	7.5	10.5
802.11ac (VHT40)	151	5755	7.5	7.5	10.5
	159	5795	7.5	7.5	10.5
802.11ac (VHT80)	155	5775	7.5	7.5	10.5
802.11ax (HE20)	149	5745	7.5	7.5	10.5
	153	5765	7.5	7.5	10.5
	157	5785	7.5	7.5	10.5
	161	5805	7.5	7.5	10.5
	165	5825	7.5	7.5	10.5
802.11ax (HE40)	151	5755	7.5	7.5	10.5
	159	5795	7.5	7.5	10.5
802.11ax (HE80)	155	5775	7.5	7.5	10.5

<Bluetooth>

Mode	Channel	Frequency (MHz)	Tune-up Power
Bluetooth BDR	0	2402	9.0
	39	2441	9.0
	78	2480	9.0
Bluetooth LE	0	2402	7.0
	19	2440	7.0
	39	2480	7.0

FCC SAR Test Report

Mode 2

<WLAN 2.4G>

Mode	Channel	Frequency (MHz)	Tune-up Power (SISO Ant-0)	Tune-up Power (SISO Ant-1)
802.11b	1	2412	19.50	19.00
	6	2437	21.00	21.00
	11	2462	19.50	20.00
	12	2467	18.50	18.50
	13	2472	15.00	15.00
802.11g	1	2412	17.00	17.00
	6	2437	21.00	21.00
	11	2462	17.00	17.00
	12	2467	15.00	15.00
	13	2472	13.00	12.50
802.11n (HT20)	1	2412	17.00	17.00
	6	2437	21.00	21.00
	11	2462	16.00	17.00
	12	2467	15.00	15.00
	13	2472	13.50	12.50
802.11n (HT40)	3	2422	16.50	16.50
	6	2437	15.50	15.50
	9	2452	14.50	16.00
	10	2457	13.00	12.50
	11	2462	13.00	13.00
802.11ac (HT20)	1	2412	17.00	17.00
	6	2437	20.00	20.00
	11	2462	15.50	15.00
	12	2467	15.00	15.00
	13	2472	13.00	12.50
802.11ac (HT40)	3	2422	16.50	16.50
	6	2437	15.50	15.50
	9	2452	15.00	16.50
	10	2457	13.00	12.50
	11	2462	13.00	13.00
802.11ax (HE20)	1	2412	17.00	17.00
	6	2437	20.00	20.00
	11	2462	17.00	15.00
	12	2467	15.00	15.00
	13	2472	13.50	12.50
802.11ax (HE40)	3	2422	17.50	16.50
	6	2437	17.00	15.50
	9	2452	16.50	16.50
	10	2457	13.00	12.50
	11	2462	13.00	13.00

FCC SAR Test Report

Mode	Channel	Frequency (MHz)	Tune-up Power (MIMO Ant-0)	Tune-up Power (MIMO Ant-1)	Tune-up Power (MIMO Ant-0 + Ant-1)
802.11n (HT20)	1	2412	14.00	14.00	17.00
	6	2437	17.50	17.50	20.50
	11	2462	14.50	14.50	17.50
	12	2467	12.00	12.00	15.00
	13	2472	10.00	10.00	13.00
802.11n (HT40)	3	2422	14.50	14.50	17.50
	6	2437	14.00	14.00	17.00
	9	2452	13.50	13.50	16.50
	10	2457	9.50	9.50	12.50
	11	2462	11.00	11.00	14.00
802.11ac (HT20)	1	2412	14.00	14.00	17.00
	6	2437	17.00	17.00	20.00
	11	2462	14.00	14.00	17.00
	12	2467	12.00	12.00	15.00
	13	2472	11.00	11.00	14.00
802.11ac (HT40)	3	2422	14.50	14.50	17.50
	6	2437	14.00	14.00	17.00
	9	2452	13.50	13.50	16.50
	10	2457	9.50	9.50	12.50
	11	2462	11.00	11.00	14.00
802.11ax (HE20)	1	2412	14.25	14.25	17.25
	6	2437	17.25	17.25	20.25
	11	2462	14.25	14.25	17.25
	12	2467	12.25	12.25	15.25
	13	2472	10.50	10.50	13.50
802.11ax (HE40)	3	2422	14.75	14.75	17.75
	6	2437	14.25	14.25	17.25
	9	2452	13.75	13.75	16.75
	10	2457	9.75	9.75	12.75
	11	2462	11.00	11.00	14.00

<WLAN 5.2G>

Mode	Channel	Frequency (MHz)	Tune-up Power (SISO Ant-0)	Tune-up Power (SISO Ant-1)
802.11a	36	5180	19.00	19.50
	40	5200	19.50	20.00
	44	5220	19.50	20.00
	48	5240	21.00	21.50
802.11n (HT20)	36	5180	18.50	19.00
	40	5200	19.50	19.50
	44	5220	19.50	19.50
	48	5240	20.50	21.00
802.11n (HT40)	38	5190	18.50	18.50
	46	5230	21.00	21.00
802.11ac (VHT80)	42	5210	18.50	18.50
802.11ax (HE20)	36	5180	19.00	19.00
	40	5200	20.00	20.00
	44	5220	20.00	20.00
	48	5240	21.00	21.00
802.11ax (HE40)	38	5190	18.50	19.00
	46	5230	20.50	20.50
802.11ax (HE80)	42	5210	18.50	18.50

Mode	Channel	Frequency (MHz)	Tune-up Power (MIMO Ant-0)	Tune-up Power (MIMO Ant-1)	Tune-up Power (MIMO Ant-0 + Ant-1)
802.11n (HT20)	36	5180	15.50	15.50	18.50
	40	5200	16.50	16.50	19.50
	44	5220	16.50	16.50	19.50
	48	5240	18.00	18.00	21.00
802.11n (HT40)	38	5190	16.00	16.00	19.00
	46	5230	18.00	18.00	21.00
802.11ac (VHT80)	42	5210	16.00	16.00	19.00
802.11ax (HE20)	36	5180	15.50	15.50	18.50
	40	5200	17.00	17.00	20.00
	44	5220	17.00	17.00	20.00
	48	5240	18.00	18.00	21.00
802.11ax (HE40)	38	5190	15.50	15.50	18.50
	46	5230	18.50	18.50	21.50
802.11ax (HE80)	42	5210	16.50	16.50	19.50

<WLAN 5.3G>

Mode	Channel	Frequency (MHz)	Tune-up Power (SISO Ant-0)	Tune-up Power (SISO Ant-1)
802.11a	52	5260	21.50	21.50
	56	5280	21.50	21.50
	60	5300	21.50	21.50
	64	5320	18.50	18.50
802.11n (HT20)	52	5260	21.50	21.00
	56	5280	21.50	21.00
	60	5300	21.50	21.00
	64	5320	18.50	18.50
802.11n (HT40)	54	5270	20.50	20.50
	62	5310	18.50	17.50
802.11ac (VHT80)	58	5290	18.00	18.00
802.11ax (HE20)	52	5260	21.50	21.50
	56	5280	21.50	21.50
	60	5300	21.50	21.50
	64	5320	18.00	18.50
802.11ax (HE40)	54	5270	20.50	20.50
	62	5310	17.50	17.50
802.11ax (HE80)	58	5290	18.00	18.00
802.11ax (HE160)	50	5250	15.00	15.50

Mode	Channel	Frequency (MHz)	Tune-up Power (MIMO Ant-0)	Tune-up Power (MIMO Ant-1)	Tune-up Power (MIMO Ant-0 + Ant-1)
802.11n (HT20)	52	5260	18.00	18.00	21.00
	56	5280	18.00	18.00	21.00
	60	5300	18.00	18.00	21.00
	64	5320	15.50	15.50	18.50
802.11n (HT40)	54	5270	18.00	18.00	21.00
	62	5310	14.50	14.50	17.50
802.11ac (VHT80)	58	5290	15.00	15.00	18.00
802.11ax (HE20)	52	5260	18.00	18.00	21.00
	56	5280	18.00	18.00	21.00
	60	5300	18.00	18.00	21.00
	64	5320	15.50	15.50	18.50
802.11ax (HE40)	54	5270	18.00	18.00	21.00
	62	5310	14.50	14.50	17.50
802.11ax (HE80)	58	5290	14.50	14.50	17.50
802.11ax (HE160)	50	5250	13.00	13.00	16.00

FCC SAR Test Report



<WLAN 5.6G>

Mode	Channel	Frequency (MHz)	Tune-up Power (SISO Ant-0)	Tune-up Power (SISO Ant-1)
802.11a	100	5500	19.00	19.50
	116	5580	21.50	21.50
	120	5600	21.50	21.50
	124	5620	21.50	21.50
	132	5660	21.50	21.50
	140	5700	18.50	18.00
	144	5720	20.50	20.50
802.11n (HT20)	100	5500	19.00	19.00
	116	5580	21.50	21.50
	120	5600	21.50	21.50
	124	5620	21.50	21.50
	132	5660	21.50	21.50
	140	5700	18.00	18.00
	144	5720	20.50	20.50
802.11n (HT40)	102	5510	18.50	18.50
	110	5550	21.50	21.50
	118	5590	21.50	21.50
	126	5630	21.50	20.50
	134	5670	19.50	19.50
	142	5710	20.50	20.50
802.11ac (VHT80)	106	5530	19.00	19.00
	122	5610	20.00	20.00
	138	5690	21.00	20.50
802.11ac (VHT160)	114	5570	14.50	14.50
802.11ax (HE20)	100	5500	19.00	19.00
	116	5580	21.00	21.00
	120	5600	21.00	21.00
	124	5620	21.00	21.00
	132	5660	21.00	21.00
	140	5700	17.50	18.00
	144	5720	21.00	21.00
802.11ax (HE40)	102	5510	18.50	18.50
	110	5550	21.00	21.50
	118	5590	21.00	21.50
	126	5630	21.00	21.50
	134	5670	19.00	19.00
	142	5710	20.50	21.00
802.11ax (HE80)	106	5530	19.00	19.50
	122	5610	19.50	19.50
	138	5690	21.00	21.00
802.11ax (HE160)	114	5570	14.50	14.50

FCC SAR Test Report

Mode	Channel	Frequency (MHz)	Tune-up Power (MIMO Ant-0)	Tune-up Power (MIMO Ant-1)	Tune-up Power (MIMO Ant-0 + Ant-1)
802.11n (HT20)	100	5500	16.00	16.00	19.00
	116	5580	18.50	18.50	21.50
	120	5600	18.50	18.50	21.50
	124	5620	18.50	18.50	21.50
	132	5660	18.50	18.50	21.50
	140	5700	15.00	15.00	18.00
	144	5720	18.50	18.50	21.50
802.11n (HT40)	102	5510	15.00	15.00	18.00
	110	5550	18.50	18.50	21.50
	118	5590	18.50	18.50	21.50
	126	5630	18.50	18.50	21.50
	134	5670	18.00	18.00	21.00
	142	5710	19.00	19.00	22.00
802.11ac (VHT80)	106	5530	16.00	16.00	19.00
	122	5610	18.00	18.00	21.00
	138	5690	18.50	18.50	21.50
802.11ac (VHT160)	114	5570	11.50	11.50	14.50
802.11ax (HE20)	100	5500	16.00	16.00	19.00
	116	5580	18.00	18.00	21.00
	120	5600	18.00	18.00	21.00
	124	5620	18.00	18.00	21.00
	132	5660	18.00	18.00	21.00
	140	5700	15.00	15.00	18.00
	144	5720	18.50	18.50	21.50
802.11ax (HE40)	102	5510	15.00	15.00	18.00
	110	5550	18.00	18.00	21.00
	118	5590	18.00	18.00	21.00
	126	5630	18.00	18.00	21.00
	134	5670	17.50	17.50	20.50
	142	5710	19.00	19.00	22.00
802.11ax (HE80)	106	5530	16.00	16.00	19.00
	122	5610	18.50	18.50	21.50
	138	5690	19.00	19.00	22.00
802.11ax (HE160)	114	5570	11.50	11.50	14.50

FCC SAR Test Report

<WLAN 5.8G>

Mode	Channel	Frequency (MHz)	Tune-up Power (SISO Ant-0)	Tune-up Power (SISO Ant-1)
802.11a	149	5745	21.00	21.50
	153	5765	21.50	21.50
	157	5785	21.50	21.50
	161	5805	21.50	21.50
	165	5825	21.50	21.50
802.11n (HT20)	149	5745	21.00	21.00
	153	5765	21.50	21.50
	157	5785	21.50	21.50
	161	5805	21.50	21.50
	165	5825	21.00	21.00
802.11n (HT40)	151	5755	21.00	21.50
	159	5795	21.00	21.00
802.11ac (VHT80)	155	5775	19.00	19.00
802.11ax (HE20)	149	5745	21.00	21.50
	153	5765	21.50	21.50
	157	5785	21.50	21.50
	161	5805	21.50	21.50
	165	5825	21.50	21.50
802.11ax (HE40)	151	5755	21.00	20.50
	159	5795	21.00	21.00
802.11ax (HE80)	155	5775	19.00	18.50

Mode	Channel	Frequency (MHz)	Tune-up Power (MIMO Ant-0)	Tune-up Power (MIMO Ant-1)	Tune-up Power (MIMO Ant-0 + Ant-1)
802.11n (HT20)	149	5745	17.50	17.50	20.50
	153	5765	17.50	17.50	20.50
	157	5785	17.50	17.50	20.50
	161	5805	17.50	17.50	20.50
	165	5825	17.50	17.50	20.50
802.11n (HT40)	151	5755	18.00	18.00	21.00
	159	5795	18.00	18.00	21.00
802.11ac (VHT80)	155	5775	16.50	16.50	19.50
802.11ax (HE20)	149	5745	17.50	17.50	20.50
	153	5765	17.50	17.50	20.50
	157	5785	17.50	17.50	20.50
	161	5805	17.50	17.50	20.50
	165	5825	17.50	17.50	20.50
802.11ax (HE40)	151	5755	18.00	18.00	21.00
	159	5795	18.00	18.00	21.00
802.11ax (HE80)	155	5775	16.50	16.50	19.50

<Bluetooth>

Mode	Channel	Frequency (MHz)	Tune-up Power
Bluetooth BDR	0	2402	9.0
	39	2441	9.0
	78	2480	9.0
Bluetooth LE	0	2402	7.0
	19	2440	7.0
	39	2480	7.0

FCC SAR Test Report

4.6.2 Measured Conducted Power Result

The measuring conducted average power (Unit: dBm) is shown as below.

Sample1 - Mode 1

<WLAN 2.4G>

Mode	Channel	Frequency (MHz)	Average Power (SISO Ant-0)	Average Power (SISO Ant-1)
802.11b	1	2412	10.42	10.41
	6	2437	10.43	10.43
	11	2462	10.45	10.42
	12	2467	10.41	10.45
	13	2472	10.49	10.49

Mode	Channel	Frequency (MHz)	Average Power (MIMO Ant-0)	Average Power (MIMO Ant-1)	Average Power (MIMO Ant-0 + Ant-1)
802.11n (HT40)	3	2422	7.42	7.33	10.39
	6	2437	7.49	7.41	10.46
	9	2452	7.47	7.39	10.44
	10	2457	7.46	7.38	10.43
	11	2462	7.46	7.49	10.49

<WLAN 5.3G>

Mode	Channel	Frequency (MHz)	Average Power (SISO Ant-0)	Average Power (SISO Ant-1)
802.11ac (VHT160)	50	5250	10.41	10.49

Mode	Channel	Frequency (MHz)	Average Power (MIMO Ant-0)	Average Power (MIMO Ant-1)	Average Power (MIMO Ant-0 + Ant-1)
802.11ac (VHT160)	50	5250	7.36	7.49	10.44

<WLAN 5.6G>

Mode	Channel	Frequency (MHz)	Average Power (SISO Ant-0)	Average Power (SISO Ant-1)
802.11ac (VHT160)	114	5570	10.42	10.47

Mode	Channel	Frequency (MHz)	Average Power (MIMO Ant-0)	Average Power (MIMO Ant-1)	Average Power (MIMO Ant-0 + Ant-1)
802.11ac (VHT160)	114	5570	7.42	7.49	10.47

<WLAN 5.8G>

Mode	Channel	Frequency (MHz)	Average Power (SISO Ant-0)	Average Power (SISO Ant-1)
802.11ac (VHT80)	155	5775	10.44	10.41

Mode	Channel	Frequency (MHz)	Average Power (MIMO Ant-0)	Average Power (MIMO Ant-1)	Average Power (MIMO Ant-0 + Ant-1)
802.11ac (VHT80)	155	5775	7.45	7.49	10.48

FCC SAR Test Report

<Bluetooth>

Mode	Channel	Frequency (MHz)	Average Power
Bluetooth BDR	0	2402	8.31
	39	2441	8.55
	78	2480	8.56
Bluetooth LE	0	2402	6.31
	19	2440	6.25
	39	2480	6.68

Sample1 - Mode 2

<WLAN 2.4G>

Mode	Channel	Frequency (MHz)	Average Power (SISO Ant-0)	Average Power (SISO Ant-1)
802.11b	1	2412	19.45	19.00
	6	2437	20.99	20.98
	11	2462	19.47	19.82
	12	2467	18.49	18.30
	13	2472	14.89	14.87

Mode	Channel	Frequency (MHz)	Average Power (MIMO Ant-0)	Average Power (MIMO Ant-1)	Average Power (MIMO Ant-0 + Ant-1)
802.11n (HT20)	1	2412	13.97	13.84	16.92
	6	2437	17.49	17.08	20.30
	11	2462	14.22	14.33	17.29
	12	2467	12.00	11.96	14.99
	13	2472	9.96	9.68	12.83

<WLAN 5.2G & 5.3G>

Mode	Channel	Frequency (MHz)	Average Power (MIMO Ant-0)	Average Power (MIMO Ant-1)	Average Power (MIMO Ant-0 + Ant-1)
802.11ax (HE40)	38	5190	15.22	15.42	18.33
	46	5230	18.24	18.29	21.28

Mode	Channel	Frequency (MHz)	Average Power (SISO Ant-0)	Average Power (SISO Ant-1)
802.11a	52	5260	21.49	21.50
	56	5280	21.25	21.41
	60	5300	21.24	21.47
	64	5320	18.47	18.25

FCC SAR Test Report

<WLAN 5.6G>

Mode	Channel	Frequency (MHz)	Average Power (SISO Ant-0)	Average Power (SISO Ant-1)
802.11n (HT40)	102	5510	18.34	18.44
	110	5550	21.37	21.47
	118	5590	21.20	21.40
	126	5630	21.19	20.10
	134	5670	19.22	19.25
	142	5710	20.48	20.19

Mode	Channel	Frequency (MHz)	Average Power (MIMO Ant-0)	Average Power (MIMO Ant-1)	Average Power (MIMO Ant-0 + Ant-1)
802.11ax (HE80)	106	5530	15.64	15.83	18.75
	122	5610	18.34	18.13	21.25
	138	5690	18.9	18.58	21.75

<WLAN 5.8G>

Mode	Channel	Frequency (MHz)	Average Power (SISO Ant-0)	Average Power (SISO Ant-1)
802.11a	149	5745	20.88	-
	153	5765	21.46	-
	157	5785	21.49	-
	161	5805	21.44	-
	165	5825	21.15	-
802.11n (HT40)	151	5755	-	21.20
	159	5795	-	20.70

Mode	Channel	Frequency (MHz)	Average Power (MIMO Ant-0)	Average Power (MIMO Ant-1)	Average Power (MIMO Ant-0 + Ant-1)
802.11n (HT40)	151	5755	17.86	17.82	20.85
	159	5795	17.89	17.99	20.95

<Bluetooth>

Mode	Channel	Frequency (MHz)	Average Power
Bluetooth BDR	0	2402	8.31
	39	2441	8.55
	78	2480	8.56
Bluetooth LE	0	2402	6.31
	19	2440	6.25
	39	2480	6.68

FCC SAR Test Report

Sample2 - Mode 1

<WLAN 2.4G>

Mode	Channel	Frequency (MHz)	Average Power (SISO Ant-0)	Average Power (SISO Ant-1)
802.11b	1	2412	10.39	10.36
	6	2437	10.38	10.35
	11	2462	10.44	10.38
	12	2467	10.37	10.42
	13	2472	10.46	10.48

Mode	Channel	Frequency (MHz)	Average Power (MIMO Ant-0)	Average Power (MIMO Ant-1)	Average Power (MIMO Ant-0 + Ant-1)
802.11n (HT40)	3	2422	7.42	7.33	10.39
	6	2437	7.49	7.41	10.46
	9	2452	7.47	7.39	10.44
	10	2457	7.46	7.38	10.43
	11	2462	7.46	7.49	10.49

<WLAN 5.3G>

Mode	Channel	Frequency (MHz)	Average Power (SISO Ant-0)	Average Power (SISO Ant-1)
802.11ac (VHT160)	50	5250	10.39	10.46

Mode	Channel	Frequency (MHz)	Average Power (MIMO Ant-0)	Average Power (MIMO Ant-1)	Average Power (MIMO Ant-0 + Ant-1)
802.11ac (VHT160)	50	5250	7.36	7.49	10.44

<WLAN 5.6G>

Mode	Channel	Frequency (MHz)	Average Power (SISO Ant-0)	Average Power (SISO Ant-1)
802.11ac (VHT160)	114	5570	10.41	10.45

Mode	Channel	Frequency (MHz)	Average Power (MIMO Ant-0)	Average Power (MIMO Ant-1)	Average Power (MIMO Ant-0 + Ant-1)
802.11ac (VHT160)	114	5570	7.42	7.49	10.47

<WLAN 5.8G>

Mode	Channel	Frequency (MHz)	Average Power (SISO Ant-0)	Average Power (SISO Ant-1)
802.11ac (VHT80)	155	5775	10.37	10.35

Mode	Channel	Frequency (MHz)	Average Power (MIMO Ant-0)	Average Power (MIMO Ant-1)	Average Power (MIMO Ant-0 + Ant-1)
802.11ac (VHT80)	155	5775	7.45	7.49	10.48

FCC SAR Test Report

<Bluetooth>

Mode	Channel	Frequency (MHz)	Average Power
Bluetooth BDR	0	2402	8.31
	39	2441	8.45
	78	2480	8.48
Bluetooth LE	0	2402	6.28
	19	2440	6.26
	39	2480	6.59

Sample2 - Mode 2

<WLAN 2.4G>

Mode	Channel	Frequency (MHz)	Average Power (SISO Ant-0)	Average Power (SISO Ant-1)
802.11b	1	2412	19.42	18.97
	6	2437	20.96	20.96
	11	2462	19.43	19.76
	12	2467	18.44	18.23
	13	2472	14.76	14.82

Mode	Channel	Frequency (MHz)	Average Power (MIMO Ant-0)	Average Power (MIMO Ant-1)	Average Power (MIMO Ant-0 + Ant-1)
802.11n (HT20)	1	2412	13.94	13.83	16.90
	6	2437	17.47	17.06	20.28
	11	2462	14.21	14.30	17.27
	12	2467	11.98	11.92	14.96
	13	2472	9.94	9.59	12.78

<WLAN 5.2G & 5.3G>

Mode	Channel	Frequency (MHz)	Average Power (MIMO Ant-0)	Average Power (MIMO Ant-1)	Average Power (MIMO Ant-0 + Ant-1)
802.11ax (HE40)	38	5190	15.22	15.36	18.30
	46	5230	18.19	18.27	21.24

Mode	Channel	Frequency (MHz)	Average Power (SISO Ant-0)	Average Power (SISO Ant-1)
802.11a	52	5260	21.44	21.46
	56	5280	21.26	21.40
	60	5300	21.26	21.45
	64	5320	18.39	18.24

FCC SAR Test Report

<WLAN 5.6G>

Mode	Channel	Frequency (MHz)	Average Power (SISO Ant-0)	Average Power (SISO Ant-1)
802.11n (HT40)	102	5510	18.27	18.41
	110	5550	21.36	21.45
	118	5590	21.16	21.32
	126	5630	21.14	20.06
	134	5670	19.15	19.27
	142	5710	20.45	20.18

Mode	Channel	Frequency (MHz)	Average Power (MIMO Ant-0)	Average Power (MIMO Ant-1)	Average Power (MIMO Ant-0 + Ant-1)
802.11ax (HE80)	106	5530	16.60	15.81	19.23
	122	5610	18.29	18.07	21.19
	138	5690	18.88	18.54	21.72

<WLAN 5.8G>

Mode	Channel	Frequency (MHz)	Average Power (SISO Ant-0)	Average Power (SISO Ant-1)
802.11a	149	5745	20.76	-
	153	5765	21.43	-
	157	5785	21.48	-
	161	5805	21.42	-
	165	5825	21.14	-
802.11n (HT40)	151	5755	-	21.16
	159	5795	-	20.68

Mode	Channel	Frequency (MHz)	Average Power (MIMO Ant-0)	Average Power (MIMO Ant-1)	Average Power (MIMO Ant-0 + Ant-1)
802.11n (HT40)	151	5755	17.82	17.81	20.83
	159	5795	17.85	17.93	20.9

<Bluetooth>

Mode	Channel	Frequency (MHz)	Average Power
Bluetooth BDR	0	2402	8.31
	39	2441	8.45
	78	2480	8.48
Bluetooth LE	0	2402	6.28
	19	2440	6.26
	39	2480	6.59

4.7 SAR Testing Results

4.7.1 SAR Test Reduction Considerations

<KDB 447498 D01, General RF Exposure Guidance>

Testing of other required channels within the operating mode of a frequency band is not required when the reported SAR for the mid-band or highest output power channel is:

- (1) ≤ 0.8 W/kg or 2.0 W/kg, for 1-g or 10-g respectively, when the transmission band is ≤ 100 MHz
- (2) ≤ 0.6 W/kg or 1.5 W/kg, for 1-g or 10-g respectively, when the transmission band is between 100 MHz and 200 MHz
- (3) ≤ 0.4 W/kg or 1.0 W/kg, for 1-g or 10-g respectively, when the transmission band is ≥ 200 MHz

When SAR is not measured at the maximum power level allowed for production units, the measured SAR will be scaled to the maximum tune-up tolerance limit to determine compliance. The scaling factor for the tune-up power is defined as maximum tune-up limit (mW) / measured conducted power (mW). The reported SAR would be calculated by measured SAR x tune-up power scaling factor.

The SAR has been measured with highest transmission duty factor supported by the test mode tools for WLAN and/or Bluetooth. When the transmission duty factor could not achieve 100%, the reported SAR will be scaled to 100% transmission duty factor to determine compliance at the maximum tune-up power. The scaling factor for the duty factor is defined as 100% / transmission duty cycle (%). The reported SAR would be calculated by measured SAR x tune-up power scaling factor x duty cycle scaling factor.

<KDB 248227 D01, SAR Guidance for Wi-Fi Transmitters>

- (1) For handsets operating next to ear, hotspot mode or mini-tablet configurations, the initial test position procedures were applied. The test position with the highest extrapolated peak SAR will be used as the initial test position. When the reported SAR of initial test position is ≤ 0.4 W/kg, SAR testing for remaining test positions is not required. Otherwise, SAR is evaluated at the subsequent highest peak SAR positions until the reported SAR result is ≤ 0.8 W/kg or all test positions are measured.
- (2) For WLAN 2.4 GHz, the highest measured maximum output power channel for DSSS was selected for SAR measurement. When the reported SAR is ≤ 0.8 W/kg, no further SAR testing is required. Otherwise, SAR is evaluated at the next highest measured output power channel. When any reported SAR is > 1.2 W/kg, SAR is required for the third channel. For OFDM modes (802.11g/n), SAR is not required when the highest reported SAR for DSSS is adjusted by the ratio of OFDM to DSSS specified maximum output power and it is ≤ 1.2 W/kg.
- (3) For WLAN 5 GHz, the initial test configuration was selected according to the transmission mode with the highest maximum output power. When the reported SAR of initial test configuration is > 0.8 W/kg, SAR is required for the subsequent highest measured output power channel until the reported SAR result is ≤ 1.2 W/kg or all required channels are measured. For other transmission modes, SAR is not required when the highest reported SAR for initial test configuration is adjusted by the ratio of subsequent test configuration to initial test configuration specified maximum output power and it is ≤ 1.2 W/kg.
- (4) For WLAN MIMO mode, the power-based standalone SAR test exclusion or the sum of SAR provision in KDB 447498 to determine simultaneous transmission SAR test exclusion should be applied. Otherwise, SAR for MIMO mode will be measured with all applicable antennas transmitting simultaneously at the specified maximum output power of MIMO operation.

FCC SAR Test Report

4.7.2 SAR Results for Body Exposure Condition

Mode 1

Plot No.	Band	Mode	Test Position	Separation Distance (mm)	Ch.	Sample	Ant. Status	Keyboard	Duty Cycle	Crest Factor	Max. Tune-up Power (dBm)	Measured Conducted Power (dBm)	Scaling Factor	Power Drift (dB)	Measured SAR-1g (W/kg)	Scaled SAR-1g (W/kg)
	WLAN2.4G	802.11b	Rear Face	0	13	1	Ant 0	w/o	99.90	1.00	10.5	10.49	1.00	0.11	0.131	0.13
	WLAN2.4G	802.11b	Top Side	0	13	1	Ant 0	w/o	99.90	1.00	10.5	10.49	1.00	-0.18	0.496	0.50
	WLAN2.4G	802.11b	Rear Face	0	13	1	Ant 1	w/o	99.90	1.00	10.5	10.49	1.00	0.04	0.118	0.12
	WLAN2.4G	802.11b	Top Side	0	13	1	Ant 1	w/o	99.90	1.00	10.5	10.49	1.00	0.09	0.614	0.61
	WLAN2.4G	802.11n HT40	Rear Face	0	11	1	Ant 0	w/o	99.90	1.00	7.5	7.46	1.01	0.14	0.063	0.06
							Ant 1	w/o	99.90	1.00	7.5	7.49	1.00	0.14	0.082	0.08
	WLAN2.4G	802.11n HT40	Top Side	0	11	1	Ant 0	w/o	99.90	1.00	7.5	7.46	1.01	0.12	0.331	0.33
							Ant 1	w/o	99.90	1.00	7.5	7.49	1.00	0.12	0.365	0.37
	WLAN2.4G	802.11b	Top Side	0	1	1	Ant 1	w/o	99.90	1.00	10.5	10.41	1.02	0.15	0.401	0.41
	WLAN2.4G	802.11b	Top Side	0	6	1	Ant 1	w/o	99.90	1.00	10.5	10.43	1.02	0.03	0.492	0.50
	WLAN2.4G	802.11b	Top Side	0	11	1	Ant 1	w/o	99.90	1.00	10.5	10.42	1.02	0.09	0.588	0.60
01	WLAN2.4G	802.11b	Top Side	0	12	1	Ant 1	w/o	99.90	1.00	10.5	10.45	1.01	0.18	0.629	0.64
	WLAN2.4G	802.11b	Top Side	0	12	1	Ant 1	w/	99.90	1.00	10.5	10.45	1.01	-0.11	0.563	0.57
	WLAN5.3G	802.11ac VHT160	Rear Face	0	50	1	Ant 0	w/o	99.00	1.01	10.5	10.41	1.02	0.00	<0.001	0.00
	WLAN5.3G	802.11ac VHT160	Top Side	0	50	1	Ant 0	w/o	99.00	1.01	10.5	10.41	1.02	-0.01	1.02	1.05
	WLAN5.3G	802.11ac VHT160	Rear Face	0	50	1	Ant 1	w/o	99.00	1.01	10.5	10.49	1.00	0.00	<0.001	0.00
02	WLAN5.3G	802.11ac VHT160	Top Side	0	50	1	Ant 1	w/o	99.00	1.01	10.5	10.49	1.00	-0.01	1.11	1.12
	WLAN5.3G	802.11ac VHT160	Rear Face	0	50	1	Ant 0	w/o	99.00	1.01	7.5	7.36	1.03	0.00	<0.001	0.00
							Ant 1	w/o	99.00	1.01	7.5	7.49	1.00	0.00	<0.001	0.00
	WLAN5.3G	802.11ac VHT160	Top Side	0	50	1	Ant 0	w/o	99.00	1.01	7.5	7.36	1.03	0.07	0.477	0.50
							Ant 1	w/o	99.00	1.01	7.5	7.49	1.00	0.07	0.635	0.64
	WLAN5.3G	802.11ac VHT160	Top Side	0	50	1	Ant 1	w/	99.00	1.01	10.5	10.49	1.00	0.18	1.08	1.09
	WLAN5.3G	802.11ac VHT160	Top Side	0	50	1	Ant 1	w/o	99.00	1.01	10.5	10.49	1.00	-0.08	1.07	1.08
	WLAN5.6G	802.11ac VHT160	Rear Face	0	114	1	Ant 0	w/o	99.00	1.01	10.5	10.42	1.02	0.00	<0.001	0.00
	WLAN5.6G	802.11ac VHT160	Top Side	0	114	1	Ant 0	w/o	99.00	1.01	10.5	10.42	1.02	-0.04	1.07	1.10
	WLAN5.6G	802.11ac VHT160	Rear Face	0	114	1	Ant 1	w/o	99.00	1.01	10.5	10.47	1.01	0.00	<0.001	0.00
03	WLAN5.6G	802.11ac VHT160	Top Side	0	114	1	Ant 1	w/o	99.00	1.01	10.5	10.47	1.01	-0.07	1.12	1.14
	WLAN5.6G	802.11ac VHT160	Rear Face	0	114	1	Ant 0	w/o	99.00	1.01	7.5	7.42	1.02	0.00	<0.001	0.00
							Ant 1	w/o	99.00	1.01	7.5	7.49	1.00	0.00	<0.001	0.00
	WLAN5.6G	802.11ac VHT160	Top Side	0	114	1	Ant 0	w/o	99.00	1.01	7.5	7.42	1.02	0.04	0.556	0.57
							Ant 1	w/o	99.00	1.01	7.5	7.49	1.00	0.04	0.611	0.62
	WLAN5.6G	802.11ac VHT160	Top Side	0	114	1	Ant 1	w/	99.00	1.01	10.5	10.47	1.01	0.04	0.846	0.86
	WLAN5.6G	802.11ac VHT160	Top Side	0	114	1	Ant 1	w/o	99.00	1.01	10.5	10.47	1.01	-0.11	1.05	1.07
	WLAN5.8G	802.11ac VHT80	Rear Face	0	155	1	Ant 0	w/o	99.00	1.01	10.5	10.44	1.01	0.00	<0.001	0.00
	WLAN5.8G	802.11ac VHT80	Top Side	0	155	1	Ant 0	w/o	99.00	1.01	10.5	10.44	1.01	0.08	0.812	0.83
	WLAN5.8G	802.11ac VHT80	Rear Face	0	155	1	Ant 1	w/o	99.00	1.01	10.5	10.41	1.02	0.07	0.153	0.16
04	WLAN5.8G	802.11ac VHT80	Top Side	0	155	1	Ant 1	w/o	99.00	1.01	10.5	10.41	1.02	0.01	1.15	1.18
	WLAN5.8G	802.11ac VHT80	Rear Face	0	155	1	Ant 0	w/o	99.00	1.01	7.5	7.45	1.01	0.00	<0.001	0.00
							Ant 1	w/o	99.00	1.01	7.5	7.49	1.00	0.00	<0.001	0.00
	WLAN5.8G	802.11ac VHT80	Top Side	0	155	1	Ant 0	w/o	99.00	1.01	7.5	7.45	1.01	0.08	0.508	0.52
							Ant 1	w/o	99.00	1.01	7.5	7.49	1.00	0.08	0.621	0.63
	WLAN5.8G	802.11ac VHT80	Top Side	0	155	1	Ant 1	w/	99.00	1.01	10.5	10.41	1.02	-0.12	0.846	0.87
	WLAN5.8G	802.11ac VHT80	Top Side	0	155	1	Ant 1	w/o	99.00	1.01	10.5	10.41	1.02	-0.07	1.09	1.12
	BT	BDR	Rear Face	0	78	1	Ant 1	w/o	76.94	1.30	9.0	8.56	1.11	0.12	0.068	0.10
05	BT	BDR	Top Side	0	78	1	Ant 1	w/o	76.94	1.30	9.0	8.56	1.11	0.11	0.292	0.42
	BT	BDR	Top Side	0	0	1	Ant 1	w/o	76.94	1.30	9.0	8.31	1.17	-0.11	0.231	0.35
	BT	BDR	Top Side	0	39	1	Ant 1	w/o	76.94	1.30	9.0	8.55	1.11	0.07	0.196	0.28
	BT	BDR	Top Side	0	78	1	Ant 1	w/	76.94	1.30	9.0	8.56	1.11	0.03	0.251	0.36

Note: The "< 0.001" means there is no SAR value or the SAR is too low to be measured.

FCC SAR Test Report

Plot No.	Band	Mode	Test Position	Separation Distance (mm)	Ch.	Sample	Ant. Status	Keyboard	Duty Cycle	Crest Factor	Max. Tune-up Power (dBm)	Measured Conducted Power (dBm)	Scaling Factor	Power Drift (dB)	Measured SAR-1g (W/kg)	Scaled SAR-1g (W/kg)
	WLAN2.4G	802.11b	Rear Face	0	13	2	Ant 0	w/o	99.90	1.00	10.5	10.46	1.01	-0.03	0.186	0.19
	WLAN2.4G	802.11b	Top Side	0	13	2	Ant 0	w/o	99.90	1.00	10.5	10.46	1.01	0.10	0.665	0.67
	WLAN2.4G	802.11b	Rear Face	0	13	2	Ant 1	w/o	99.90	1.00	10.5	10.48	1.00	-0.08	0.196	0.20
	WLAN2.4G	802.11b	Top Side	0	13	2	Ant 1	w/o	99.90	1.00	10.5	10.48	1.00	0.03	0.692	0.69
	WLAN2.4G	802.11n HT40	Rear Face	0	11	2	Ant 0	w/o	99.90	1.00	7.5	7.46	1.01	-0.01	0.103	0.10
							Ant 1	w/o	99.90	1.00	7.5	7.49	1.00	0.10	0.633	0.63
	WLAN2.4G	802.11n HT40	Top Side	0	11	2	Ant 0	w/o	99.90	1.00	7.5	7.46	1.01	-0.03	0.324	0.33
							Ant 1	w/o	99.90	1.00	7.5	7.49	1.00	-0.03	0.39	0.39
	WLAN2.4G	802.11b	Top Side	0	1	2	Ant 1	w/o	99.90	1.00	10.5	10.36	1.03	-0.07	0.537	0.55
	WLAN2.4G	802.11b	Top Side	0	6	2	Ant 1	w/o	99.90	1.00	10.5	10.35	1.04	0.12	0.685	0.71
	WLAN2.4G	802.11b	Top Side	0	11	2	Ant 1	w/o	99.90	1.00	10.5	10.38	1.03	0.07	0.739	0.76
06	WLAN2.4G	802.11b	Top Side	0	12	2	Ant 1	w/o	99.90	1.00	10.5	10.42	1.02	-0.08	0.839	0.86
	WLAN2.4G	802.11b	Top Side	0	12	2	Ant 1	w/	99.90	1.00	10.5	10.42	1.02	-0.11	0.704	0.72
	WLAN2.4G	802.11b	Top Side	0	12	2	Ant 1	w/o	99.90	1.00	10.5	10.42	1.02	0.09	0.822	0.84
	WLAN5.3G	802.11ac VHT160	Rear Face	0	50	2	Ant 0	w/o	99.00	1.01	10.5	10.39	1.03	0.00	<0.001	0.00
	WLAN5.3G	802.11ac VHT160	Top Side	0	50	2	Ant 0	w/o	99.00	1.01	10.5	10.39	1.03	-0.08	0.905	0.94
	WLAN5.3G	802.11ac VHT160	Rear Face	0	50	2	Ant 1	w/o	99.00	1.01	10.5	10.46	1.01	-0.07	0.161	0.16
07	WLAN5.3G	802.11ac VHT160	Top Side	0	50	2	Ant 1	w/o	99.00	1.01	10.5	10.46	1.01	-0.01	0.929	0.95
	WLAN5.3G	802.11ac VHT160	Rear Face	0	50	2	Ant 0	w/o	99.00	1.01	7.5	7.36	1.03	0.00	<0.001	0.00
							Ant 1	w/o	99.00	1.01	7.5	7.49	1	0.00	<0.001	0.00
	WLAN5.3G	802.11ac VHT160	Top Side	0	50	2	Ant 0	w/o	99.00	1.01	7.5	7.36	1.03	-0.01	0.456	0.47
							Ant 1	w/o	99.00	1.01	7.5	7.49	1	-0.01	0.466	0.47
	WLAN5.3G	802.11ac VHT160	Top Side	0	50	2	Ant 1	w/	99.00	1.01	10.5	10.46	1.01	-0.11	0.847	0.86
	WLAN5.3G	802.11ac VHT160	Top Side	0	50	2	Ant 1	w/o	99.00	1.01	10.5	10.46	1.01	-0.08	0.897	0.92
	WLAN5.6G	802.11ac VHT160	Rear Face	0	114	2	Ant 0	w/o	99.00	1.01	10.5	10.41	1.02	0.00	<0.001	0.00
	WLAN5.6G	802.11ac VHT160	Top Side	0	114	2	Ant 0	w/o	99.00	1.01	10.5	10.41	1.02	-0.02	1.07	1.10
	WLAN5.6G	802.11ac VHT160	Rear Face	0	114	2	Ant 1	w/o	99.00	1.01	10.5	10.45	1.01	0.00	<0.001	0.00
08	WLAN5.6G	802.11ac VHT160	Top Side	0	114	2	Ant 1	w/o	99.00	1.01	10.5	10.45	1.01	-0.03	1.12	1.14
	WLAN5.6G	802.11ac VHT160	Rear Face	0	114	2	Ant 0	w/o	99.00	1.01	7.5	7.42	1.02	0.00	<0.001	0.00
							Ant 1	w/o	99.00	1.01	7.5	7.49	1	0.00	<0.001	0.00
	WLAN5.6G	802.11ac VHT160	Top Side	0	114	2	Ant 0	w/o	99.00	1.01	7.5	7.42	1.02	-0.08	<0.001	0.00
							Ant 1	w/o	99.00	1.01	7.5	7.49	1	-0.08	0.59	0.60
	WLAN5.6G	802.11ac VHT160	Top Side	0	114	2	Ant 1	w/	99.00	1.01	10.5	10.45	1.01	-0.09	0.994	1.01
	WLAN5.6G	802.11ac VHT160	Top Side	0	114	2	Ant 1	w/o	99.00	1.01	10.5	10.45	1.01	-0.08	1.08	1.10
	WLAN5.8G	802.11ac VHT80	Rear Face	0	155	2	Ant 0	w/o	99.00	1.01	10.5	10.37	1.03	0.11	0.335	0.35
	WLAN5.8G	802.11ac VHT80	Top Side	0	155	2	Ant 0	w/o	99.00	1.01	10.5	10.37	1.03	-0.19	0.867	0.90
	WLAN5.8G	802.11ac VHT80	Rear Face	0	155	2	Ant 1	w/o	99.00	1.01	10.5	10.35	1.04	0.08	0.256	0.27
09	WLAN5.8G	802.11ac VHT80	Top Side	0	155	2	Ant 1	w/o	99.00	1.01	10.5	10.35	1.04	-0.09	0.906	0.95
	WLAN5.8G	802.11ac VHT80	Rear Face	0	155	2	Ant 0	w/o	99.00	1.01	7.5	7.45	1.01	0.00	<0.001	0.00
							Ant 1	w/o	99.00	1.01	7.5	7.49	1	0.00	<0.001	0.00
	WLAN5.8G	802.11ac VHT80	Top Side	0	155	2	Ant 0	w/o	99.00	1.01	7.5	7.45	1.01	-0.02	0.41	0.42
							Ant 1	w/o	99.00	1.01	7.5	7.49	1	-0.02	0.429	0.43
	WLAN5.8G	802.11ac VHT80	Top Side	0	155	2	Ant 1	w/	99.00	1.01	10.5	10.37	1.03	0.03	0.818	0.85
	WLAN5.8G	802.11ac VHT80	Top Side	0	155	2	Ant 1	w/o	99.00	1.01	10.5	10.37	1.03	0.01	0.887	0.92
	BT	BDR	Rear Face	0	78	2	Ant 1	w/o	76.94	1.30	9.0	8.48	1.13	-0.03	0.092	0.14
	BT	BDR	Top Side	0	78	2	Ant 1	w/o	76.94	1.30	9.0	8.48	1.13	-0.07	0.308	0.45
10	BT	BDR	Top Side	0	0	2	Ant 1	w/o	76.94	1.30	9.0	8.31	1.17	0.11	0.316	0.48
	BT	BDR	Top Side	0	39	2	Ant 1	w/o	76.94	1.30	9.0	8.45	1.14	0.02	0.277	0.41
	BT	BDR	Top Side	0	0	2	Ant 1	w/	76.94	1.30	9.0	8.31	1.17	-0.12	0.304	0.46

Note: The "< 0.001" means there is no SAR value or the SAR is too low to be measured.

FCC SAR Test Report

Mode 2

Plot No.	Band	Mode	Test Position	Separation Distance (mm)	Ch.	Sample	Ant. Status	Duty Cycle	Crest Factor	Max. Tune-up Power (dBm)	Measured Conducted Power (dBm)	Scaling Factor	Power Drift (dB)	Measured SAR-1g (W/kg)	Scaled SAR-1g (W/kg)
	WLAN2.4G	802.11b	Bottom	0	6	1	Ant 0	98.90	1.01	21.0	20.99	1.00	0.00	<0.001	0.00
	WLAN2.4G	802.11b	Back of Pannel	25	6	1	Ant 0	98.90	1.01	21.0	20.99	1.00	0.01	0.073	0.07
11	WLAN2.4G	802.11b	Top of Pannel	25	6	1	Ant 0	98.90	1.01	21.0	20.99	1.00	0.15	0.399	0.40
	WLAN2.4G	802.11b	Bottom	0	6	1	Ant 1	98.90	1.01	21.0	20.98	1.00	0.00	<0.001	0.00
	WLAN2.4G	802.11b	Back of Pannel	25	6	1	Ant 1	98.90	1.01	21.0	20.98	1.00	0.02	0.035	0.04
	WLAN2.4G	802.11b	Top of Pannel	25	6	1	Ant 1	98.90	1.01	21.0	20.98	1.00	-0.12	0.171	0.17
	WLAN2.4G	802.11n HT20	Bottom	0	6	1	Ant 0	98.90	1.01	17.5	17.49	1.00	0.00	<0.001	0.00
	WLAN2.4G	802.11n HT20	Back of Pannel	25	6	1	Ant 1	98.90	1.01	17.5	17.08	1.10	0.00	<0.001	0.00
	WLAN2.4G	802.11n HT20	Top of Pannel	25	6	1	Ant 0	98.90	1.01	17.5	17.49	1.00	0.00	<0.001	0.00
	WLAN2.4G	802.11n HT20	Top of Pannel	25	6	1	Ant 1	98.90	1.01	17.5	17.08	1.10	-0.13	0.113	0.11
	WLAN2.4G	802.11b	Top of Pannel	25	1	1	Ant 0	98.90	1.01	19.5	19.45	1.01	0.08	0.238	0.24
	WLAN2.4G	802.11b	Top of Pannel	25	11	1	Ant 0	98.90	1.01	19.5	19.47	1.01	-0.11	0.326	0.33
	WLAN2.4G	802.11b	Top of Pannel	25	12	1	Ant 0	98.90	1.01	18.5	18.49	1.00	-0.05	0.267	0.27
	WLAN2.4G	802.11b	Top of Pannel	25	13	1	Ant 0	98.90	1.01	15.0	14.89	1.03	-0.15	0.103	0.11
	WLAN5.3G	802.11a	Bottom	0	52	1	Ant 0	97.38	1.03	21.5	21.49	1.00	0.00	<0.001	0.00
	WLAN5.3G	802.11a	Back of Pannel	25	52	1	Ant 0	97.38	1.03	21.5	21.49	1.00	0.08	0.121	0.12
12	WLAN5.3G	802.11a	Top of Pannel	25	52	1	Ant 0	97.38	1.03	21.5	21.49	1.00	-0.13	0.749	0.77
	WLAN5.3G	802.11a	Bottom	0	52	1	Ant 1	97.38	1.03	21.5	21.50	1.00	0.00	<0.001	0.00
	WLAN5.3G	802.11a	Back of Pannel	25	52	1	Ant 1	97.38	1.03	21.5	21.50	1.00	0.00	<0.001	0.00
	WLAN5.3G	802.11a	Top of Pannel	25	52	1	Ant 1	97.38	1.03	21.5	21.50	1.00	-0.12	0.359	0.37
	WLAN5.2G	802.11ax HE40	Bottom	0	46	1	Ant 0	98.64	1.01	18.5	18.24	1.06	0.00	<0.001	0.00
	WLAN5.2G	802.11ax HE40	Back of Pannel	25	46	1	Ant 1	98.64	1.01	18.5	18.29	1.05	0.00	<0.001	0.00
	WLAN5.2G	802.11ax HE40	Top of Pannel	25	46	1	Ant 0	98.64	1.01	18.5	18.24	1.06	0.00	<0.001	0.00
	WLAN5.2G	802.11ax HE40	Top of Pannel	25	46	1	Ant 1	98.64	1.01	18.5	18.29	1.05	-0.18	0.303	0.32
	WLAN5.3G	802.11a	Top of Pannel	25	56	1	Ant 0	97.38	1.03	21.5	21.25	1.06	-0.01	0.691	0.75
	WLAN5.3G	802.11a	Top of Pannel	25	60	1	Ant 0	97.38	1.03	21.5	21.24	1.06	0.02	0.655	0.72
	WLAN5.3G	802.11a	Top of Pannel	25	64	1	Ant 0	97.38	1.03	18.5	18.47	1.01	-0.12	0.336	0.35
	WLAN5.6G	802.11n HT40	Bottom	0	110	1	Ant 0	98.67	1.01	21.5	21.37	1.03	0.00	<0.001	0.00
	WLAN5.6G	802.11n HT40	Back of Pannel	25	110	1	Ant 0	98.67	1.01	21.5	21.37	1.03	0.00	<0.001	0.00
	WLAN5.6G	802.11n HT40	Top of Pannel	25	110	1	Ant 0	98.67	1.01	21.5	21.37	1.03	-0.02	0.388	0.40
	WLAN5.6G	802.11n HT40	Bottom	0	110	1	Ant 1	98.67	1.01	21.5	21.47	1.01	0.00	<0.001	0.00
	WLAN5.6G	802.11n HT40	Back of Pannel	25	110	1	Ant 1	98.67	1.01	21.5	21.47	1.01	0.03	0.133	0.14
13	WLAN5.6G	802.11n HT40	Top of Pannel	25	110	1	Ant 1	98.67	1.01	21.5	21.47	1.01	0.02	0.768	0.78
	WLAN5.6G	802.11ax HT80	Bottom	0	138	1	Ant 0	98.66	1.01	19.0	18.90	1.02	0.00	<0.001	0.00
	WLAN5.6G	802.11ax HT80	Back of Pannel	25	138	1	Ant 1	98.66	1.01	19.0	18.58	1.10	0.00	<0.001	0.00
	WLAN5.6G	802.11ax HT80	Top of Pannel	25	138	1	Ant 0	98.66	1.01	19.0	18.90	1.02	0.00	<0.001	0.00
	WLAN5.6G	802.11ax HT80	Top of Pannel	25	138	1	Ant 1	98.66	1.01	19.0	18.58	1.10	-0.05	0.263	0.27
	WLAN5.6G	802.11n HT40	Top of Pannel	25	102	1	Ant 1	98.67	1.01	18.5	18.44	1.01	-0.09	0.356	0.36
	WLAN5.6G	802.11n HT40	Top of Pannel	25	134	1	Ant 1	98.67	1.01	19.5	19.25	1.06	-0.03	0.496	0.53
	WLAN5.6G	802.11n HT40	Top of Pannel	25	142	1	Ant 1	98.67	1.01	20.5	20.19	1.07	0.07	0.556	0.60
	WLAN5.8G	802.11a	Bottom	0	157	1	Ant 0	97.38	1.03	21.5	21.49	1.00	0.01	<0.001	0.00
	WLAN5.8G	802.11a	Back of Pannel	25	157	1	Ant 0	97.38	1.03	21.5	21.49	1.00	-0.16	0.158	0.16
	WLAN5.8G	802.11a	Top of Pannel	25	157	1	Ant 0	97.38	1.03	21.5	21.49	1.00	0.03	0.615	0.63
	WLAN5.8G	802.11n HT40	Bottom	0	151	1	Ant 1	98.67	1.01	21.5	21.20	1.07	0.11	<0.001	0.00
	WLAN5.8G	802.11n HT40	Back of Pannel	25	151	1	Ant 1	98.67	1.01	21.5	21.20	1.07	0.09	0.167	0.18
14	WLAN5.8G	802.11n HT40	Top of Pannel	25	151	1	Ant 1	98.67	1.01	21.5	21.20	1.07	0.12	0.861	0.93
	WLAN5.8G	802.11n HT40	Bottom	0	159	1	Ant 0	98.66	1.01	18.0	17.89	1.03	0.00	<0.001	0.00
	WLAN5.8G	802.11n HT40	Back of Pannel	25	159	1	Ant 1	98.66	1.01	18.0	17.99	1.00	0.00	<0.001	0.00
	WLAN5.8G	802.11n HT40	Top of Pannel	25	159	1	Ant 0	98.66	1.01	18.0	17.99	1.00	0.00	<0.001	0.00
	WLAN5.8G	802.11n HT40	Top of Pannel	25	159	1	Ant 1	98.66	1.01	18.0	17.99	1.00	0.01	0.278	0.29
	WLAN5.8G	802.11n HT40	Top of Pannel	25	159	1	Ant 1	98.67	1.01	21.0	20.70	1.07	0.02	0.815	0.88
	WLAN5.8G	802.11n HT40	Top of Pannel	25	151	1	Ant 1	98.67	1.01	21.5	21.20	1.07	0.01	0.818	0.88
	BT	BDR	Bottom	0	78	1	Ant 1	76.94	1.30	9.0	8.56	1.11	0.00	<0.001	0.00
	BT	BDR	Back of Pannel	25	78	1	Ant 1	76.94	1.30	9.0	8.56	1.11	0.02	0.000713	0.00
15	BT	BDR	Top of Pannel	25	78	1	Ant 1	76.94	1.30	9.0	8.56	1.11	-0.15	0.00344	0.00
	BT	BDR	Top of Pannel	25	0	1	Ant 1	76.94	1.30	9.0	8.31	1.17	-0.18	0.00315	0.00
	BT	BDR	Top of Pannel	25	39	1	Ant 1	76.94	1.30	9.0	8.55	1.11	0.02	0.00303	0.00

Note: The "< 0.001" means there is no SAR value or the SAR is too low to be measured.

FCC SAR Test Report

Plot No.	Band	Mode	Test Position	Separation Distance (mm)	Ch.	Sample	Ant. Status	Duty Cycle	Crest Factor	Max. Tune-up Power (dBm)	Measured Conducted Power (dBm)	Scaling Factor	Power Drift (dB)	Measured SAR-1g (W/kg)	Scaled SAR-1g (W/kg)
	WLAN2.4G	802.11b	Bottom	0	6	2	Ant 0	98.90	1.01	21.0	20.96	1.01	0.00	<0.001	0.00
	WLAN2.4G	802.11b	Back of Pannel	25	6	2	Ant 0	98.90	1.01	21.0	20.96	1.01	-0.01	0.049	0.05
	WLAN2.4G	802.11b	Top of Pannel	25	6	2	Ant 0	98.90	1.01	21.0	20.96	1.01	0.18	0.301	0.31
	WLAN2.4G	802.11b	Bottom	0	6	2	Ant 1	98.90	1.01	21.0	20.96	1.01	0	<0.001	0.00
	WLAN2.4G	802.11b	Back of Pannel	25	6	2	Ant 1	98.90	1.01	21.0	20.96	1.01	0.02	0.069	0.07
16	WLAN2.4G	802.11b	Top of Pannel	25	6	2	Ant 1	98.90	1.01	21.0	20.96	1.01	0.13	0.332	0.34
	WLAN2.4G	802.11n HT20	Bottom	0	6	2	Ant 0	98.90	1.01	17.5	17.47	1.01	0.00	<0.001	0.00
	WLAN2.4G	802.11n HT20	Bottom	0	6	2	Ant 1	98.90	1.01	17.5	17.06	1.11	0.00	<0.001	0.00
	WLAN2.4G	802.11n HT20	Back of Pannel	25	6	2	Ant 0	98.90	1.01	17.5	17.47	1.01	0.00	<0.001	0.00
	WLAN2.4G	802.11n HT20	Back of Pannel	25	6	2	Ant 1	98.90	1.01	17.5	17.06	1.11	0.00	<0.001	0.00
	WLAN2.4G	802.11n HT20	Top of Pannel	25	6	2	Ant 0	98.90	1.01	17.5	17.47	1.01	-0.18	0.103	0.11
	WLAN2.4G	802.11n HT20	Top of Pannel	25	6	2	Ant 1	98.90	1.01	17.5	17.06	1.11	-0.18	0.181	0.20
	WLAN2.4G	802.11b	Top of Pannel	25	1	2	Ant 1	98.90	1.01	19.0	18.97	1.01	-0.01	0.172	0.18
	WLAN2.4G	802.11b	Top of Pannel	25	11	2	Ant 1	98.90	1.01	20.0	19.76	1.06	-0.15	0.302	0.32
	WLAN2.4G	802.11b	Top of Pannel	25	12	2	Ant 1	98.90	1.01	18.5	18.23	1.06	0.05	0.219	0.23
	WLAN2.4G	802.11b	Top of Pannel	25	13	2	Ant 1	98.90	1.01	15.0	14.82	1.04	0.12	0.065	0.07
	WLAN5.3G	802.11a	Bottom	0	52	2	Ant 0	97.38	1.03	21.5	21.44	1.01	0.00	<0.001	0.00
	WLAN5.3G	802.11a	Back of Pannel	25	52	2	Ant 0	97.38	1.03	21.5	21.44	1.01	0.05	0.107	0.11
	WLAN5.3G	802.11a	Top of Pannel	25	52	2	Ant 0	97.38	1.03	21.5	21.44	1.01	-0.01	0.382	0.40
	WLAN5.3G	802.11a	Bottom	0	52	2	Ant 1	97.38	1.03	21.5	21.46	1.01	0.00	<0.001	0.00
	WLAN5.3G	802.11a	Back of Pannel	25	52	2	Ant 1	97.38	1.03	21.5	21.46	1.01	-0.08	0.124	0.13
17	WLAN5.3G	802.11a	Top of Pannel	25	52	2	Ant 1	97.38	1.03	21.5	21.46	1.01	0.01	0.919	0.96
	WLAN5.2G	802.11ax HT40	Bottom	0	46	2	Ant 0	98.64	1.01	18.5	18.19	1.07	0.00	<0.001	0.00
	WLAN5.2G	802.11ax HT40	Bottom	0	46	2	Ant 1	98.64	1.01	18.5	18.27	1.05	0.00	<0.001	0.00
	WLAN5.2G	802.11ax HT40	Back of Pannel	25	46	2	Ant 0	98.64	1.01	18.5	18.19	1.07	0.00	<0.001	0.00
	WLAN5.2G	802.11ax HT40	Back of Pannel	25	46	2	Ant 1	98.64	1.01	18.5	18.27	1.05	0.00	<0.001	0.00
	WLAN5.2G	802.11ax HT40	Top of Pannel	25	46	2	Ant 0	98.64	1.01	18.5	18.19	1.07	0.07	0.198	0.21
	WLAN5.2G	802.11ax HT40	Top of Pannel	25	46	2	Ant 1	98.64	1.01	18.5	18.27	1.05	0.07	0.306	0.32
	WLAN5.3G	802.11a	Top of Pannel	25	56	2	Ant 1	97.38	1.03	21.5	21.40	1.02	0.13	0.675	0.71
	WLAN5.3G	802.11a	Top of Pannel	25	60	2	Ant 1	97.38	1.03	21.5	21.45	1.01	0.15	0.641	0.67
	WLAN5.3G	802.11a	Top of Pannel	25	64	2	Ant 1	97.38	1.03	18.5	18.24	1.06	0.02	0.334	0.36
	WLAN5.3G	802.11a	Top of Pannel	25	52	2	Ant 1	97.38	1.03	21.5	21.46	1.01	-0.03	0.901	0.94
	WLAN5.6G	802.11n HT40	Bottom	0	110	2	Ant 0	98.67	1.01	21.5	21.36	1.03	0.00	<0.001	0.00
	WLAN5.6G	802.11n HT40	Back of Pannel	25	110	2	Ant 0	98.67	1.01	21.5	21.36	1.03	-0.03	0.199	0.21
	WLAN5.6G	802.11n HT40	Top of Pannel	25	110	2	Ant 0	98.67	1.01	21.5	21.36	1.03	-0.07	0.487	0.51
	WLAN5.6G	802.11n HT40	Bottom	0	110	2	Ant 1	98.67	1.01	21.5	21.45	1.01	0.00	<0.001	0.00
	WLAN5.6G	802.11n HT40	Back of Pannel	25	110	2	Ant 1	98.67	1.01	21.5	21.45	1.01	-0.11	0.156	0.16
18	WLAN5.6G	802.11n HT40	Top of Pannel	25	110	2	Ant 1	98.67	1.01	21.5	21.45	1.01	-0.02	0.709	0.72
	WLAN5.6G	802.11ax HT80	Bottom	0	138	2	Ant 0	98.66	1.01	19.0	18.88	1.03	0.00	<0.001	0.00
	WLAN5.6G	802.11ax HT80	Bottom	0	138	2	Ant 1	98.66	1.01	19.0	18.84	1.11	0.00	<0.001	0.00
	WLAN5.6G	802.11ax HT80	Back of Pannel	25	138	2	Ant 0	98.66	1.01	19.0	18.88	1.03	-0.12	0.111	0.12
	WLAN5.6G	802.11ax HT80	Back of Pannel	25	138	2	Ant 1	98.66	1.01	19.0	18.84	1.11	-0.12	0.176	0.20
	WLAN5.6G	802.11ax HT80	Top of Pannel	25	138	2	Ant 0	98.66	1.01	19.0	18.88	1.03	-0.11	0.281	0.29
	WLAN5.6G	802.11ax HT80	Top of Pannel	25	138	2	Ant 1	98.66	1.01	19.0	18.84	1.11	-0.11	0.444	0.50
	WLAN5.6G	802.11n HT40	Top of Pannel	25	102	2	Ant 1	98.67	1.01	18.5	18.41	1.02	0.09	0.381	0.39
	WLAN5.6G	802.11n HT40	Top of Pannel	25	134	2	Ant 1	98.67	1.01	19.5	19.27	1.05	0.04	0.321	0.34
	WLAN5.6G	802.11n HT40	Top of Pannel	25	142	2	Ant 1	98.67	1.01	20.5	20.18	1.08	-0.07	0.457	0.50
	WLAN5.8G	802.11a	Bottom	0	157	2	Ant 0	97.38	1.03	21.5	21.48	1.00	0.00	<0.001	0.00
	WLAN5.8G	802.11a	Back of Pannel	25	157	2	Ant 0	97.38	1.03	21.5	21.48	1.00	0.05	0.351	0.36
	WLAN5.8G	802.11a	Top of Pannel	25	157	2	Ant 0	97.38	1.03	21.5	21.48	1.00	-0.03	0.844	0.87
	WLAN5.8G	802.11n HT40	Bottom	0	151	2	Ant 1	98.67	1.01	21.5	21.16	1.08	0.02	<0.001	0.00
	WLAN5.8G	802.11n HT40	Back of Pannel	25	151	2	Ant 1	98.67	1.01	21.5	21.16	1.08	0.11	0.143	0.16
	WLAN5.8G	802.11n HT40	Top of Pannel	25	151	2	Ant 1	98.67	1.01	21.5	21.16	1.08	0.11	0.538	0.59
	WLAN5.8G	802.11n HT40	Bottom	0	159	2	Ant 0	98.66	1.01	18.0	17.85	1.04	0.00	<0.001	0.00
	WLAN5.8G	802.11n HT40	Bottom	0	159	2	Ant 1	98.66	1.01	18.0	17.93	1.02	0.00	<0.001	0.00
	WLAN5.8G	802.11n HT40	Back of Pannel	25	159	2	Ant 0	98.66	1.01	18.0	17.85	1.04	0.02	0.068	0.07
	WLAN5.8G	802.11n HT40	Back of Pannel	25	159	2	Ant 1	98.66	1.01	18.0	17.93	1.02	0.02	0.039	0.04
	WLAN5.8G	802.11n HT40	Top of Pannel	25	159	2	Ant 0	98.66	1.01	18.0	17.85	1.04	-0.13	0.167	0.18
	WLAN5.8G	802.11n HT40	Top of Pannel	25	159	2	Ant 1	98.66	1.01	18.0	17.93	1.02	-0.13	0.143	0.15
19	WLAN5.8G	802.11a	Top of Pannel	25	149	2	Ant 0	97.38	1.03	21.0	20.76	1.06	-0.06	0.937	1.02
	WLAN5.8G	802.11a	Top of Pannel	25	153	2	Ant 0	97.38	1.03	21.5	21.43	1.02	-0.03	0.867	0.91
	WLAN5.8G	802.11a	Top of Pannel	25	161	2	Ant 0	97.38	1.03	21.5	21.42	1.02	0.13	0.861	0.90
	WLAN5.8G	802.11a	Top of Pannel	25	165	2	Ant 0	97.38	1.03	21.5	21.14	1.09	0.05	0.829	0.93
	WLAN5.8G	802.11a	Top of Pannel	25	149	2	Ant 0	97.38	1.03	21.0	20.76	1.06	-0.01	0.918	1.00
	BT	BDR	Bottom	0	78	2	Ant 1	76.94	1.30	9.0	8.48	1.13	0.00	<0.001	0.00
	BT	BDR	Back of Pannel	25	78	2	Ant 1	76.94	1.30	9.0	8.48	1.13	0.01	0.00469	0.01
20	BT	BDR	Top of Pannel	25	78	2	Ant 1	76.94	1.30	9.0	8.48	1.13	0.18	0.016	0.02
	BT	BDR	Top of Pannel	25	0	2	Ant 1	76.94	1.30	9.0	8.31	1.17	-0.01	0.012	0.02
	BT	BDR	Top of Pannel	25	39	2	Ant 1	76.94	1.30	9.0	8.45	1.14	-0.11	0.013	0.02

Note: The "< 0.001" means there is no SAR value or the SAR is too low to be measured.

4.7.3 SAR Measurement Variability

According to KDB 865664 D01, SAR measurement variability was assessed for each frequency band, which is determined by the SAR probe calibration point and tissue-equivalent medium used for the device measurements. When both head and body tissue-equivalent media are required for SAR measurements in a frequency band, the variability measurement procedures should be applied to the tissue medium with the highest measured SAR, using the highest measured SAR configuration for that tissue-equivalent medium. Alternatively, if the highest measured SAR for both head and body tissue-equivalent media are ≤ 1.45 W/kg and the ratio of these highest SAR values, i.e., largest divided by smallest value, is ≤ 1.10 , the highest SAR configuration for either head or body tissue-equivalent medium may be used to perform the repeated measurement. These additional measurements are repeated after the completion of all measurements requiring the same head or body tissue-equivalent medium in a frequency band. The test device should be returned to ambient conditions (normal room temperature) with the battery fully charged before it is re-mounted on the device holder for the repeated measurement(s) to minimize any unexpected variations in the repeated results.

SAR repeated measurement procedure:

1. When the highest measured SAR is < 0.80 W/kg, repeated measurement is not required.
2. When the highest measured SAR is ≥ 0.80 W/kg, repeat that measurement once.
3. If the ratio of largest to smallest SAR for the original and first repeated measurements is > 1.20 , or when the original or repeated measurement is ≥ 1.45 W/kg, perform a second repeated measurement.
4. If the ratio of largest to smallest SAR for the original, first and second repeated measurements is > 1.20 , and the original, first or second repeated measurement is ≥ 1.5 W/kg, perform a third repeated measurement.

Mode 1

Band	Mode	Test Position	Ch.	Sample	Original Measured SAR-1g (W/kg)	1st Repeated SAR-1g (W/kg)	L/S Ratio	2nd Repeated SAR-1g (W/kg)	L/S Ratio	3rd Repeated SAR-1g (W/kg)	L/S Ratio
WLAN5.3G	802.11ac VHT160	Top Side	50	1	1.11	1.07	1.04	N/A	N/A	N/A	N/A
WLAN5.6G	802.11ac VHT160	Top Side	114	1	1.12	1.05	1.07	N/A	N/A	N/A	N/A
WLAN5.8G	802.11ac VHT80	Top Side	155	1	1.15	1.09	1.06	N/A	N/A	N/A	N/A
WLAN2.4G	802.11b	Top Side	12	2	0.839	0.822	1.02	N/A	N/A	N/A	N/A
WLAN5.3G	802.11ac VHT160	Top Side	50	2	0.929	0.897	1.04	N/A	N/A	N/A	N/A
WLAN5.6G	802.11ac VHT160	Top Side	114	2	1.12	1.08	1.04	N/A	N/A	N/A	N/A
WLAN5.8G	802.11ac VHT80	Top Side	155	2	0.906	0.887	1.02	N/A	N/A	N/A	N/A

Mode 2

Band	Mode	Test Position	Ch.	Sample	Original Measured SAR-1g (W/kg)	1st Repeated SAR-1g (W/kg)	L/S Ratio	2nd Repeated SAR-1g (W/kg)	L/S Ratio	3rd Repeated SAR-1g (W/kg)	L/S Ratio
WLAN5.8G	802.11n HT40	Top of Pannel	151	2	0.861	0.818	1.05	N/A	N/A	N/A	N/A
WLAN5.3G	802.11a	Top of Pannel	52	2	0.919	0.901	1.02	N/A	N/A	N/A	N/A
WLAN5.8G	802.11a	Top of Pannel	149	2	0.937	0.918	1.02	N/A	N/A	N/A	N/A

FCC SAR Test Report

4.7.4 Simultaneous Multi-band Transmission Evaluation

<Possibilities of Simultaneous Transmission>

The simultaneous transmission possibilities for this device are listed as below.

Simultaneous TX Combination	Capable Transmit Configurations	Body Exposure Condition
1	WLAN2.4G_Ant. 0+BT_Ant. 1	Yes
2	WLAN5G_Ant. 0+BT_Ant. 1	Yes
3	WLAN5G_Ant. MIMO+BT_Ant. 1	Yes

Note: The WLAN 2.4G and WLAN 5G cannot transmit simultaneously.

<Estimated SAR Calculation>

According to KDB 447498 D01, when standalone SAR test exclusion applies to an antenna that transmits simultaneously with other antennas, the standalone SAR was estimated according to following formula to result in substantially conservative SAR values of ≤ 0.4 W/kg to determine simultaneous transmission SAR test exclusion.

$$\text{Estimated SAR} = \frac{\text{Max. Tune up Power}_{(mW)}}{\text{Min. Test Separation Distance}_{(mm)}} \times \frac{\sqrt{f_{(GHz)}}}{7.5}$$

If the minimum test separation distance is < 5 mm, a distance of 5 mm is used for estimated SAR calculation. When the test separation distance is > 50 mm, the 0.4 W/kg is used for SAR-1g.

Mode / Band	Frequency (GHz)	Max. Tune-up Power (dBm)	Test Position	Separation Distance (mm)	Estimated SAR (W/kg)
WLAN (DTS)	2.462	10.5	Body	50 mm +	0.40
WLAN (NII)	5.2	10.5	Body	50 mm +	0.40
WLAN (NII)	5.3	10.5	Body	50 mm +	0.40
WLAN (NII)	5.6	10.5	Body	50 mm +	0.40
WLAN (NII)	5.8	10.5	Body	50 mm +	0.40
BT (DSS)	2.48	9.0	Body	50 mm +	0.33

Note:

1. The separation distance is determined from the outer housing of the EUT to the user.
2. When standalone SAR testing is not required, an estimated SAR can be applied to determine simultaneous transmission SAR test exclusion.

FCC SAR Test Report

<SAR Summation Analysis>

Simultaneous transmission SAR test exclusion is determined for each operating configuration and exposure condition according to the reported standalone SAR of each applicable simultaneous transmitting antenna. When the sum of SAR_{1g} of all simultaneously transmitting antennas in an operating mode and exposure condition combination is within the SAR limit (SAR_{1g} 1.6 W/kg), the simultaneous transmission SAR is not required. When the sum of SAR_{1g} is greater than the SAR limit (SAR_{1g} 1.6 W/kg), SAR test exclusion is determined by the SPLSR.

Sample 1

Mode	Position	1	2	3	4	1+4	2+4	3+4
		WLAN 2.4GHz Ant 0	WLAN 5GHz Ant 0	WLAN 5GHz Ant 0+1	BT Ant 1	Summing result 1g SAR W/kg	Summing result 1g SAR W/kg	Summing result 1g SAR W/kg
		1g SAR W/kg	1g SAR W/kg	1g SAR W/kg	1g SAR W/kg			
Mode 1	Rear Face	0.13	0.00	0.00	0.10	0.23	0.10	0.10
	Left Side	0.40	0.40	0.40	0.33	0.73	0.73	0.73
	Right Side	0.40	0.40	0.40	0.33	0.73	0.73	0.73
	Top Side	0.50	1.10	0.64	0.42	0.92	1.52	1.06
	Bottom Side	0.40	0.40	0.40	0.33	0.73	0.73	0.73

Mode	Position	1	2	3	4	1+4	2+4	3+4
		WLAN 2.4GHz Ant 0	WLAN 5GHz Ant 0	WLAN 5GHz Ant 0+1	BT Ant 1	Summing result 1g SAR W/kg	Summing result 1g SAR W/kg	Summing result 1g SAR W/kg
		1g SAR W/kg	1g SAR W/kg	1g SAR W/kg	1g SAR W/kg			
Mode 2	Back of Panel	0.07	0.16	0.00	0.00	0.07	0.16	0.00
	Top of Panel	0.40	0.77	0.56	0.00	0.40	0.77	0.56
	Bottom	0.00	0.00	0.00	0.00	0.00	0.00	0.00

FCC SAR Test Report

Sample 2

Mode	Position	1	2	3	4	1+4	2+4	3+4
		WLAN 2.4GHz Ant 0	WLAN 5GHz Ant 0	WLAN 5GHz Ant 0+1	BT Ant 1	Summing result 1g SAR W/kg	Summing result 1g SAR W/kg	Summing result 1g SAR W/kg
		1g SAR W/kg	1g SAR W/kg	1g SAR W/kg	1g SAR W/kg			
Mode 1	Rear Face	0.19	0.35	0.00	0.14	0.33	0.49	0.14
	Left Side	0.40	0.40	0.40	0.33	0.73	0.73	0.73
	Right Side	0.40	0.40	0.40	0.33	0.73	0.73	0.73
	Top Side	0.67	1.10	0.60	0.48	1.15	1.58	1.08
	Bottom Side	0.40	0.40	0.40	0.33	0.73	0.73	0.73

Mode	Position	1	2	3	4	1+4	2+4	3+4
		WLAN 2.4GHz Ant 0	WLAN 5GHz Ant 0	WLAN 5GHz Ant 0+1	BT Ant 1	Summing result 1g SAR W/kg	Summing result 1g SAR W/kg	Summing result 1g SAR W/kg
		1g SAR W/kg	1g SAR W/kg	1g SAR W/kg	1g SAR W/kg			
Mode 2	Back of Panel	0.05	0.36	0.20	0.01	0.06	0.37	0.21
	Top of Panel	0.31	0.87	0.50	0.02	0.33	0.89	0.51
	Bottom	0.00	0.00	0.00	0.00	0.00	0.00	0.00

Test Engineer : James Chu, and Kevin Yao

5. Calibration of Test Equipment

Equipment	Manufacturer	Model	SN	Cal. Date	Cal. Interval
System Validation Dipole	SPEAG	D2450V2	737	Aug. 24, 2018	1 Year
System Validation Dipole	SPEAG	D5GHzV2	1019	Mar. 21, 2019	1 Year
Dosimetric E-Field Probe	SPEAG	EX3DV4	3650	May. 20, 2019	1 Year
Dosimetric E-Field Probe	SPEAG	EX3DV4	3971	Mar. 29, 2019	1 Year
Dosimetric E-Field Probe	SPEAG	EX3DV4	7375	Dec. 13, 2018	1 Year
Data Acquisition Electronics	SPEAG	DAE4	1431	Mar. 25, 2019	1 Year
Data Acquisition Electronics	SPEAG	DAE4	1277	Jan. 24, 2019	1 Year
Data Acquisition Electronics	SPEAG	DAE4	861	May. 08, 2019	1 Year
Spectrum Analyzer	R&S	FSL6	102006	Mar. 26, 2019	1 Year
ENA Series Network Analyzer	Agilent	E5071C	MY46104190	Apr. 16, 2019	1 Year
MXG Analog Signal Generator	Agilent	N5181A	MY50143868	Jun. 27, 2019	1 Year
Power Meter	Anritsu	ML2495A	1218009	Jun. 28, 2019	1 Year
Power Sensor	Anritsu	MA2411B	1207252	Jun. 28, 2019	1 Year
Thermometer	YFE	YF-160A	130504591	Mar. 22, 2019	1 Year

6. Measurement Uncertainty

According to KDB 865664 D01, SAR measurement uncertainty analysis is required in SAR reports only when the highest measured SAR in a frequency band is ≥ 1.5 W/kg for 1-g SAR, and ≥ 3.75 W/kg for 10-g SAR. The procedures described in IEEE Std 1528-2013 should be applied. The expanded SAR measurement uncertainty must be ≤ 30 %, for a confidence interval of $k = 2$. When the highest measured SAR within a frequency band is < 1.5 W/kg for 1-g and < 3.75 W/kg for 10-g, the extensive SAR measurement uncertainty analysis described in IEEE Std 1528-2013 is not required in SAR reports submitted for equipment approval. Hence, the measurement uncertainty analysis is not required in this SAR report because the test result met the condition.

7. Information of the Testing Laboratories

We, Bureau Veritas Consumer Products Services (H.K.) Ltd., Taoyuan Branch, were founded in 1988 to provide our best service in EMC, Radio, Telecom and Safety consultation. Our laboratories are accredited and approved according to ISO/IEC 17025.

If you have any comments, please feel free to contact us at the following:

Taiwan HwaYa EMC/RF/Safety/Telecom Lab:

Add: No. 19, Hwa Ya 2nd Rd, Wen Hwa Vil., Kwei Shan Hsiang, Taoyuan Hsien 333, Taiwan, R.O.C.

Tel: 886-3-318-3232

Fax: 886-3-327-0892

Taiwan LinKou EMC/RF Lab:

Add: No. 47-2, 14th Ling, Chia Pau Vil., Linkou Dist., New Taipei City 244, Taiwan, R.O.C.

Tel: 886-2-2605-2180

Fax: 886-2-2605-1924

Taiwan HsinChu EMC/RF Lab:

Add: E-2, No.1, Li Hsin 1st Road, Hsinchu Science Park, Hsinchu City 30078, Taiwan, R.O.C.

Tel: 886-3-593-5343

Fax: 886-3-593-5342

Email: service.adt@tw.bureauveritas.com

Web Site: www.bureauveritas-adt.com

The road map of all our labs can be found in our web site also.

---END---

Appendix A. SAR Plots of System Verification

The plots for system verification with largest deviation for each SAR system combination are shown as follows.

System Check_H2450_190710

DUT: Dipole 2450 MHz; Type: D2450V2; SN: 737

Communication System: CW; Frequency: 2450 MHz; Duty Cycle: 1:1

Medium: H19T27N1_0710 Medium parameters used: $f = 2450$ MHz; $\sigma = 1.861$ S/m; $\epsilon_r = 38.747$; $\rho = 1000$ kg/m³

Ambient Temperature : 23.7 °C ; Liquid Temperature : 23.3 °C

DASY5 Configuration:

- Probe: EX3DV4 - SN7375; ConvF(7.64, 7.64, 7.64); Calibrated: 2018/12/13
- Sensor-Surface: 1.4mm (Mechanical Surface Detection)
- Electronics: DAE4 Sn1277; Calibrated: 2019/01/24
- Phantom: ELI Phantom_1204; Type: QDOVA;
- Measurement SW: DASY52, Version 52.10 (2); SEMCAD X Version 14.6.12 (7450)

Pin=250mW/Area Scan (81x81x1): Interpolated grid: dx=1.200 mm, dy=1.200 mm

Maximum value of SAR (interpolated) = 23.3 W/kg

Pin=250mW/Zoom Scan (7x7x7)/Cube 0: Measurement grid: dx=5mm, dy=5mm, dz=5mm

Reference Value = 113.6 V/m; Power Drift = -0.09 dB

Peak SAR (extrapolated) = 28.9 W/kg

SAR(1 g) = 13.9 W/kg; SAR(10 g) = 6.49 W/kg

Maximum value of SAR (measured) = 23.4 W/kg

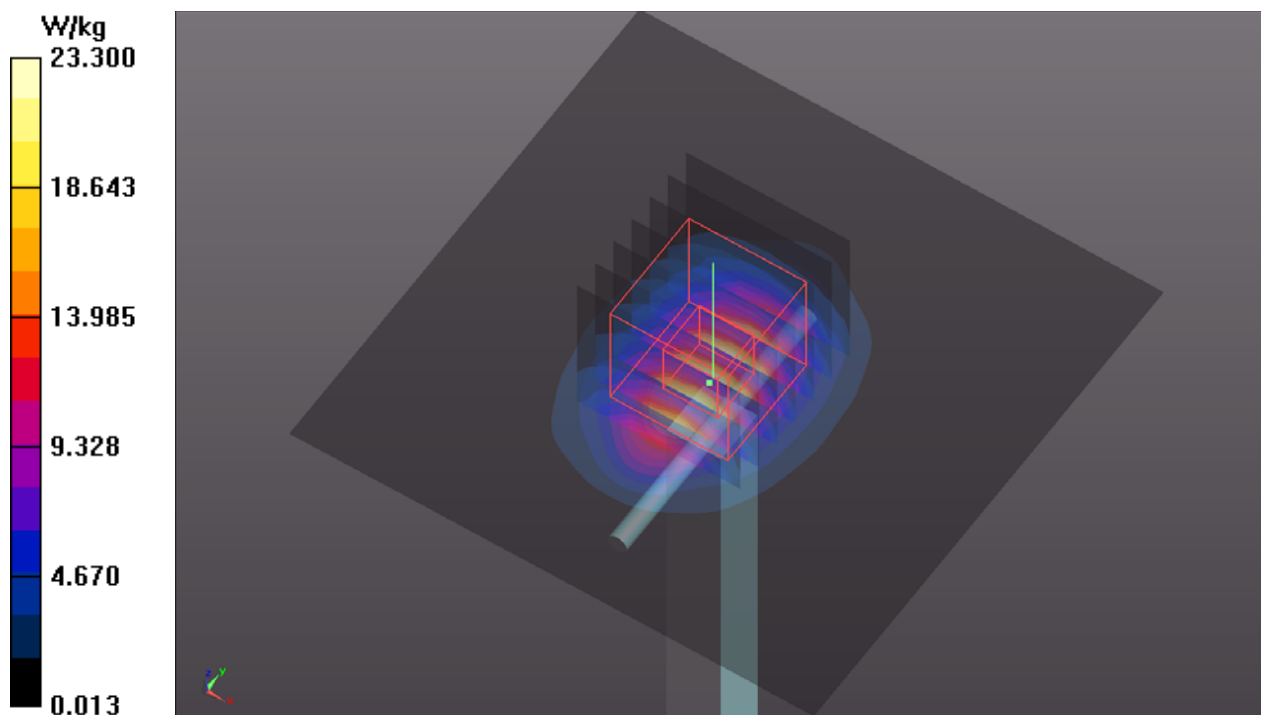

System Check_H5250_190709

DUT: Dipole 5 GHz; Type: D5GHzV2; SN: 1019

Communication System: CW; Frequency: 5250 MHz; Duty Cycle: 1:1

Medium: H34T60N1_0709 Medium parameters used: $f = 5250$ MHz; $\sigma = 4.606$ S/m; $\epsilon_r = 35.721$; $\rho = 1000$ kg/m³

Ambient Temperature : 23.7 °C ; Liquid Temperature : 23.3 °C

DASY5 Configuration:

- Probe: EX3DV4 - SN7375; ConvF(5.29, 5.29, 5.29); Calibrated: 2018/12/13
- Sensor-Surface: 1.4mm (Mechanical Surface Detection)
- Electronics: DAE4 Sn1277; Calibrated: 2019/01/24
- Phantom: ELI Phantom_1204; Type: QDOVA;
- Measurement SW: DASY52, Version 52.10 (2); SEMCAD X Version 14.6.12 (7450)

Pin=100mW/Area Scan (91x91x1): Interpolated grid: dx=1.000 mm, dy=1.000 mm

Maximum value of SAR (interpolated) = 19.0 W/kg

Pin=100mW/Zoom Scan (7x7x12)/Cube 0: Measurement grid: dx=4mm, dy=4mm, dz=2mm

Reference Value = 73.94 V/m; Power Drift = 0.02 dB

Peak SAR (extrapolated) = 32.5 W/kg

SAR(1 g) = 8.28 W/kg; SAR(10 g) = 2.38 W/kg

Maximum value of SAR (measured) = 20.7 W/kg

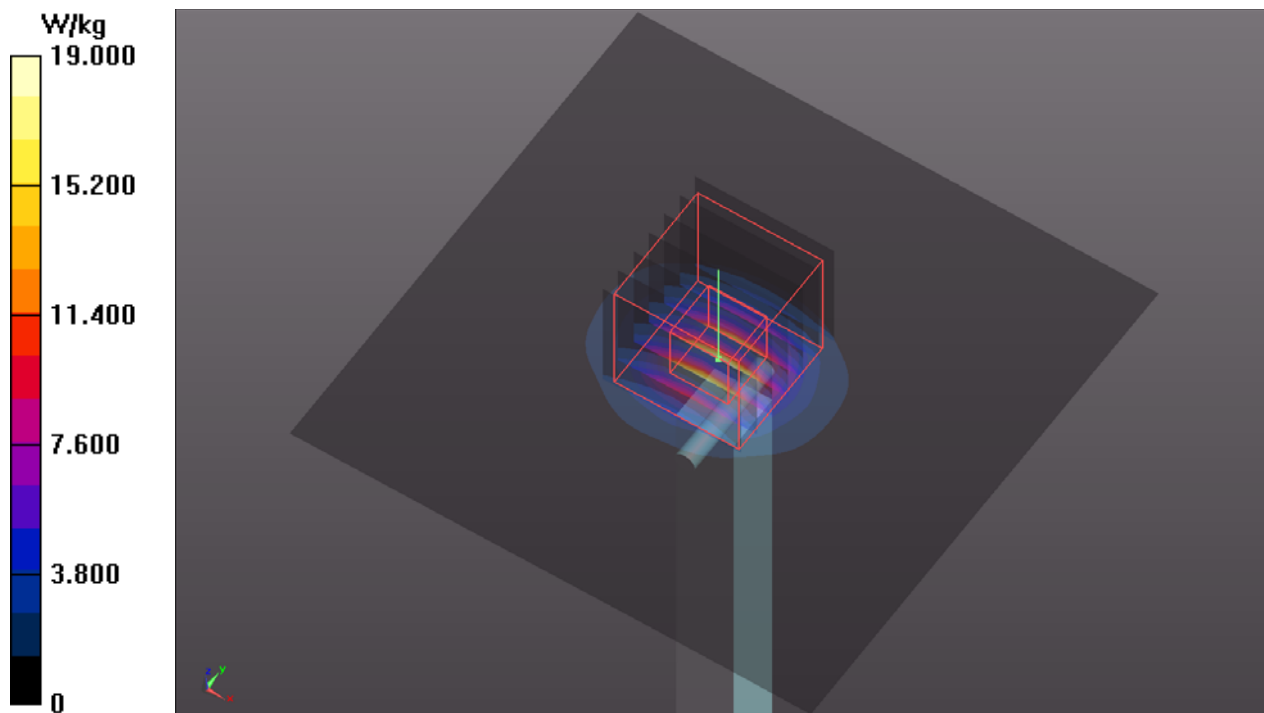

System Check_H5600_190708

DUT: Dipole 5 GHz; Type: D5GHzV2; SN: 1019

Communication System: CW; Frequency: 5600 MHz; Duty Cycle: 1:1

Medium: H34T60N1_0708 Medium parameters used: $f = 5600$ MHz; $\sigma = 4.965$ S/m; $\epsilon_r = 35.254$; $\rho = 1000$ kg/m³

Ambient Temperature : 23.7 °C ; Liquid Temperature : 23.2 °C

DASY5 Configuration:

- Probe: EX3DV4 - SN3971; ConvF(4.78, 4.78, 4.78); Calibrated: 2019/03/29
- Sensor-Surface: 1.4mm (Mechanical Surface Detection)
- Electronics: DAE4 Sn1431; Calibrated: 2019/03/25
- Phantom: ELI Phantom_1043; Type: QDOVA;
- Measurement SW: DASY52, Version 52.10 (2); SEMCAD X Version 14.6.12 (7470)

Pin=100mW/Area Scan (91x91x1): Interpolated grid: dx=1.000 mm, dy=1.000 mm

Maximum value of SAR (interpolated) = 20.3 W/kg

Pin=100mW/Zoom Scan (7x7x12)/Cube 0: Measurement grid: dx=4mm, dy=4mm, dz=2mm

Reference Value = 73.64 V/m; Power Drift = -0.10 dB

Peak SAR (extrapolated) = 38.5 W/kg

SAR(1 g) = 8.35 W/kg; SAR(10 g) = 2.37 W/kg

Maximum value of SAR (measured) = 21.8 W/kg

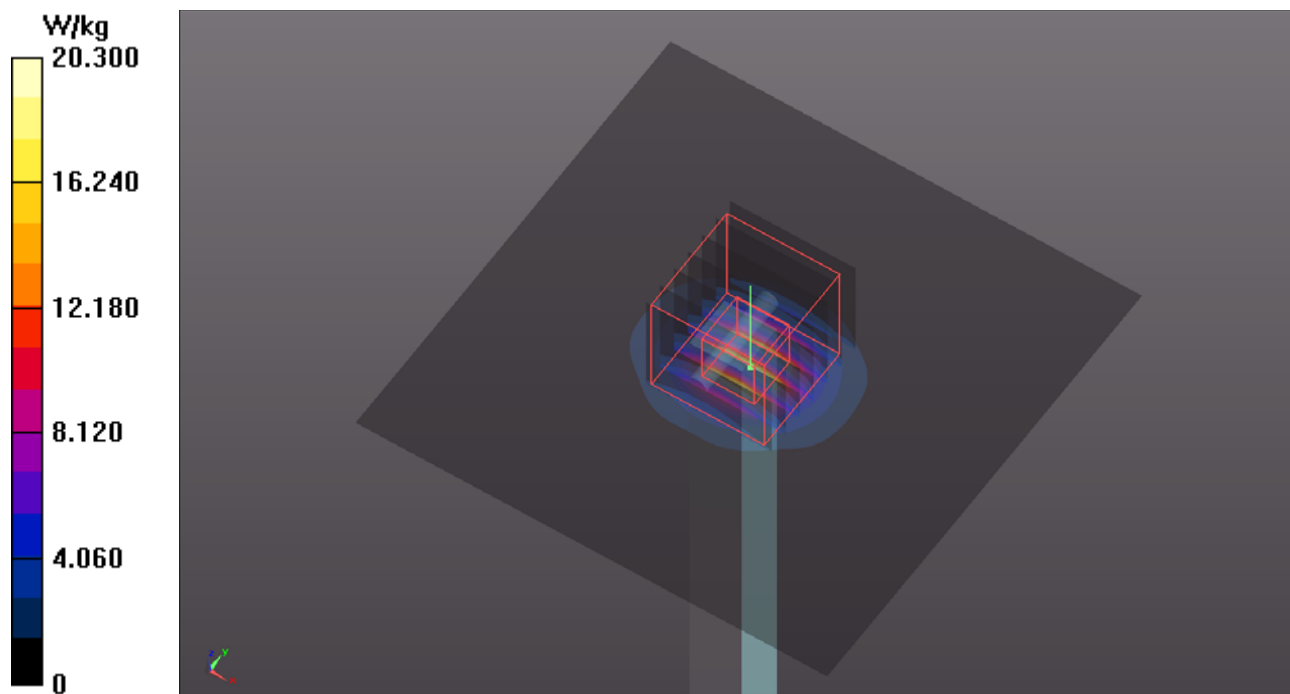

System Check_H5750_190708

DUT: Dipole 5 GHz; Type: D5GHzV2; SN: 1019

Communication System: CW; Frequency: 5750 MHz; Duty Cycle: 1:1

Medium: H34T60N1_0708 Medium parameters used: $f = 5750$ MHz; $\sigma = 5.142$ S/m; $\epsilon_r = 35.078$; $\rho = 1000$ kg/m³

Ambient Temperature : 23.7 °C ; Liquid Temperature : 23.2 °C

DASY5 Configuration:

- Probe: EX3DV4 - SN3971; ConvF(4.92, 4.92, 4.92); Calibrated: 2019/03/29
- Sensor-Surface: 1.4mm (Mechanical Surface Detection)
- Electronics: DAE4 Sn1431; Calibrated: 2019/03/25
- Phantom: ELI Phantom_1043; Type: QDOVA;
- Measurement SW: DASY52, Version 52.10 (2); SEMCAD X Version 14.6.12 (7470)

Pin=100mW/Area Scan (91x91x1): Interpolated grid: dx=1.000 mm, dy=1.000 mm
Maximum value of SAR (interpolated) = 18.7 W/kg

Pin=100mW/Zoom Scan (7x7x12)/Cube 0: Measurement grid: dx=4mm, dy=4mm, dz=2mm
Reference Value = 56.61 V/m; Power Drift = 0.19 dB
Peak SAR (extrapolated) = 34.6 W/kg
SAR(1 g) = 7.55 W/kg; SAR(10 g) = 2.17 W/kg
Maximum value of SAR (measured) = 19.7 W/kg

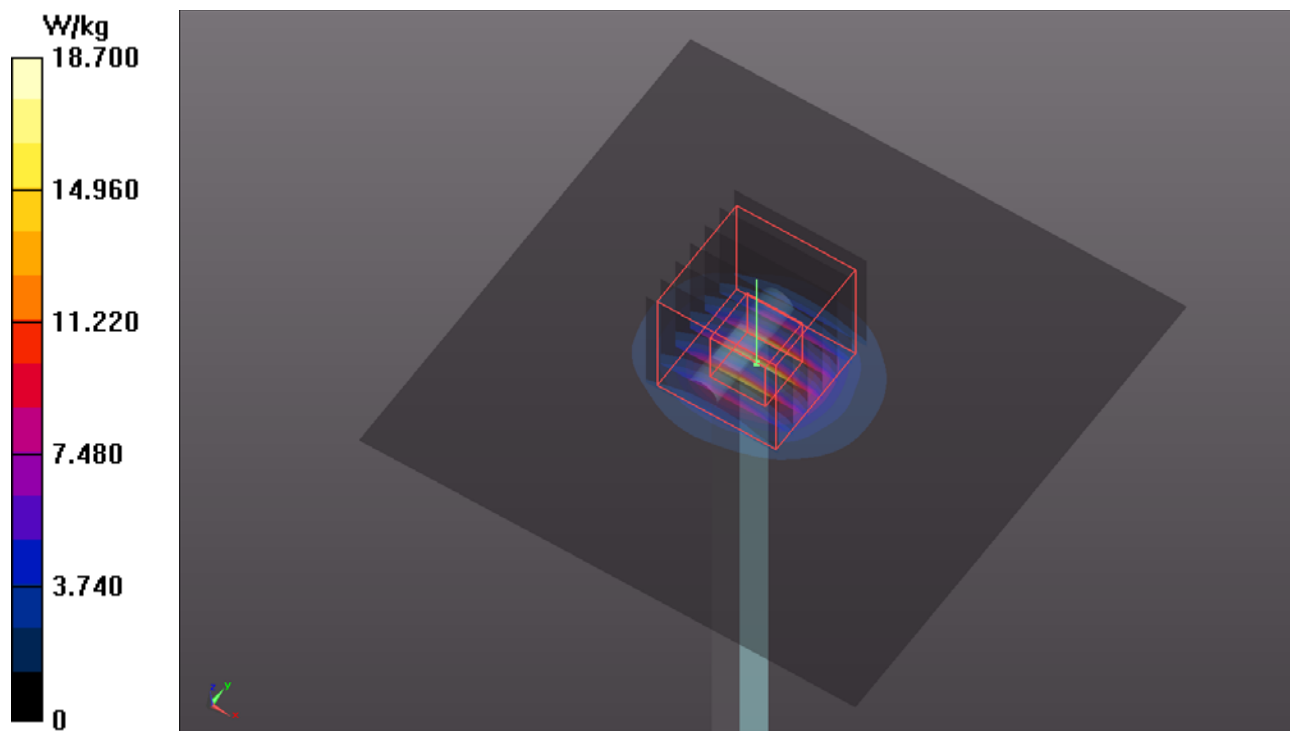



Appendix B. SAR Plots of SAR Measurement

The SAR plots for highest measured SAR in each exposure configuration, wireless mode and frequency band combination, and measured SAR > 1.5 W/kg are shown as follows.

P01 WLAN2.4G_802.11b_Top Side_0mm_Ch12_Sample1_Ant1_keyboard_w_o

DUT: 190625C21

Communication System: WLAN_2.4G; Frequency: 2467 MHz; Duty Cycle: 1:1

Medium: H19T27N3_0708 Medium parameters used: $f = 2467$ MHz; $\sigma = 1.89$ S/m; $\epsilon_r = 38.877$; $\rho = 1000$ kg/m³

Ambient Temperature : 23.7 °C ; Liquid Temperature : 23.2 °C

DASY5 Configuration:

- Probe: EX3DV4 - SN3971; ConvF(7.65, 7.65, 7.65); Calibrated: 2019/03/29
- Sensor-Surface: 1.4mm (Mechanical Surface Detection)
- Electronics: DAE4 Sn1431; Calibrated: 2019/03/25
- Phantom: ELI Phantom_1043; Type: QDOVA;
- Measurement SW: DASY52, Version 52.10 (2); SEMCAD X Version 14.6.12 (7470)

- **Area Scan (51x291x1):** Interpolated grid: dx=1.200 mm, dy=1.200 mm

Maximum value of SAR (interpolated) = 0.431 W/kg

- **Zoom Scan (5x5x7)/Cube 0:** Measurement grid: dx=8mm, dy=8mm, dz=5mm

Reference Value = 13.56 V/m; Power Drift = 0.18 dB

Peak SAR (extrapolated) = 1.68 W/kg

SAR(1 g) = 0.629 W/kg; SAR(10 g) = 0.211 W/kg

Maximum value of SAR (measured) = 0.937 W/kg

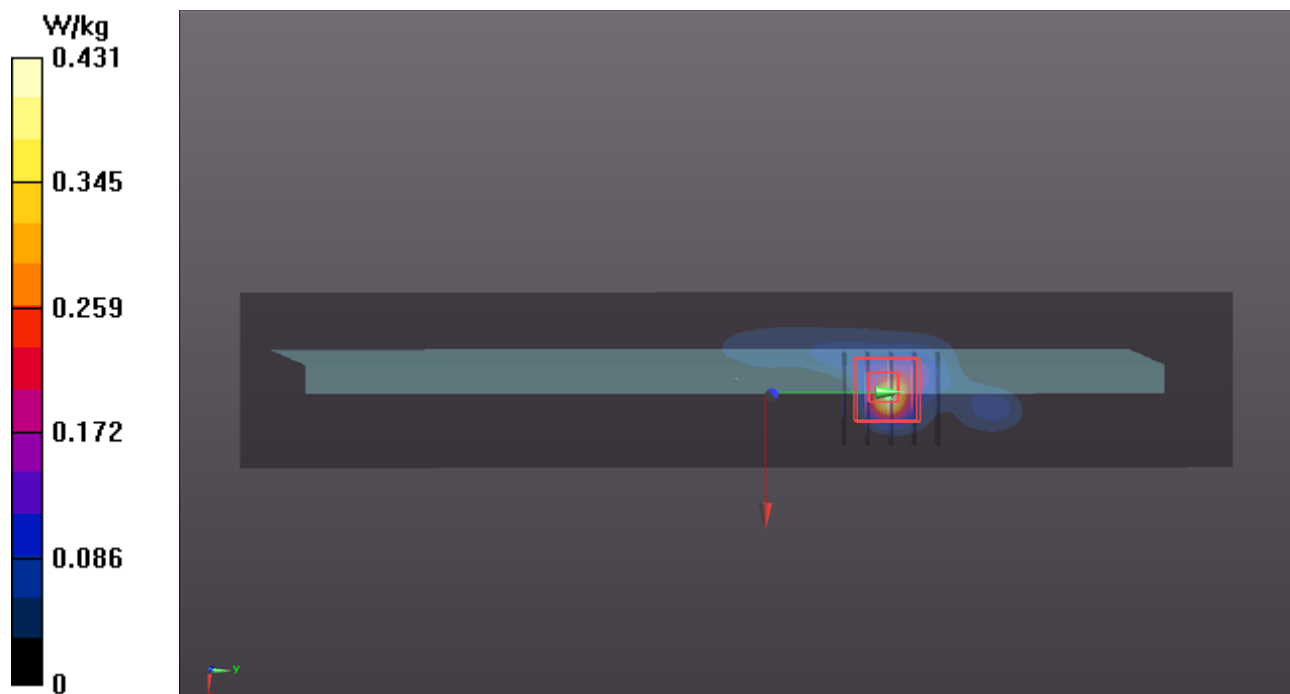

P02 WLAN5.3G_802.11ac VHT160_Top Side_0mm_Ch50_Sample1_Ant1_keyboard_w_o

DUT: 190625C21

Communication System: WLAN_5G; Frequency: 5250 MHz; Duty Cycle: 1:1.01

Medium: H34T60N1_0708 Medium parameters used: $f = 5250$ MHz; $\sigma = 4.601$ S/m; $\epsilon_r = 35.761$; $\rho = 1000$ kg/m³

Ambient Temperature : 23.7 °C ; Liquid Temperature : 23.1 °C

DASY5 Configuration:

- Probe: EX3DV4 - SN3971; ConvF(5.12, 5.12, 5.12); Calibrated: 2019/03/29
- Sensor-Surface: 1.4mm (Mechanical Surface Detection)
- Electronics: DAE4 Sn1431; Calibrated: 2019/03/25
- Phantom: ELI Phantom_1043; Type: QDOVA;
- Measurement SW: DASY52, Version 52.10 (2); SEMCAD X Version 14.6.12 (7470)

- **Area Scan (61x341x1):** Interpolated grid: dx=1.000 mm, dy=1.000 mm

Maximum value of SAR (interpolated) = 0.297 W/kg

- **Zoom Scan (6x6x12)/Cube 0:** Measurement grid: dx=5mm, dy=5mm, dz=2mm

Reference Value = 7.306 V/m; Power Drift = -0.01 dB

Peak SAR (extrapolated) = 9.19 W/kg

SAR(1 g) = 1.11 W/kg; SAR(10 g) = 0.196 W/kg

Maximum value of SAR (measured) = 2.74 W/kg

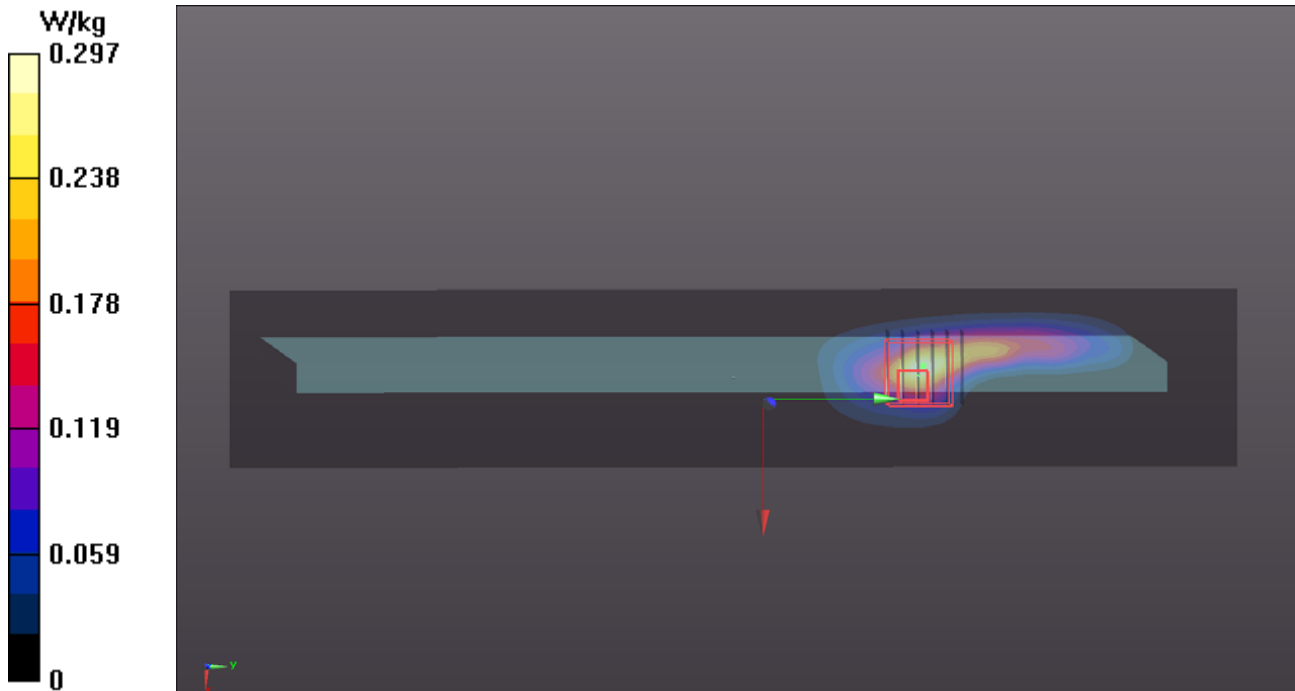

P03 WLAN5.6G_802.11ac VHT160_Top Side_0mm_Ch114_Sample1_Ant1_keyboard_w_o

DUT: 190625C21

Communication System: WLAN_5G; Frequency: 5570 MHz; Duty Cycle: 1:1.01

Medium: H34T60N1_0708 Medium parameters used: $f = 5570$ MHz; $\sigma = 4.931$ S/m; $\epsilon_r = 35.28$; $\rho = 1000$ kg/m³

Ambient Temperature : 23.7 °C ; Liquid Temperature : 23.1 °C

DASY5 Configuration:

- Probe: EX3DV4 - SN3971; ConvF(4.78, 4.78, 4.78); Calibrated: 2019/03/29
- Sensor-Surface: 1.4mm (Mechanical Surface Detection)
- Electronics: DAE4 Sn1431; Calibrated: 2019/03/25
- Phantom: ELI Phantom_1043; Type: QDOVA;
- Measurement SW: DASY52, Version 52.10 (2); SEMCAD X Version 14.6.12 (7470)

- **Area Scan (61x341x1):** Interpolated grid: dx=1.000 mm, dy=1.000 mm

Maximum value of SAR (interpolated) = 0.593 W/kg

- **Zoom Scan (6x6x12)/Cube 0:** Measurement grid: dx=5mm, dy=5mm, dz=2mm

Reference Value = 11.06 V/m; Power Drift = -0.07 dB

Peak SAR (extrapolated) = 9.79 W/kg

SAR(1 g) = 1.12 W/kg; SAR(10 g) = 0.196 W/kg

Maximum value of SAR (measured) = 4.77 W/kg

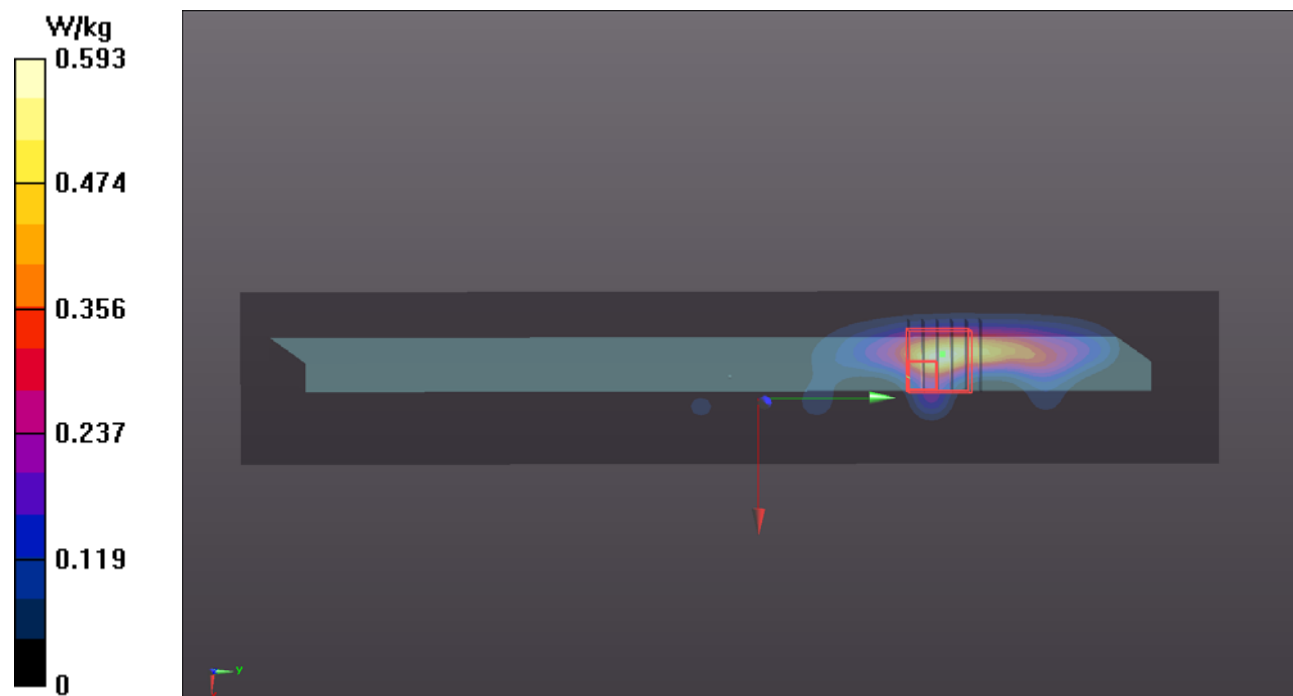

P04 WLAN5.8G_802.11ac VHT80_Top Side_0mm_Ch155_Sample1_Ant1_keyboard_w_o

DUT: 190625C21

Communication System: WLAN_5G; Frequency: 5775 MHz; Duty Cycle: 1:1.01

Medium: H34T60N1_0708 Medium parameters used: $f = 5775$ MHz; $\sigma = 5.15$ S/m; $\epsilon_r = 35.043$; $\rho = 1000$ kg/m³

Ambient Temperature : 23.7 °C ; Liquid Temperature : 23.1 °C

DASY5 Configuration:

- Probe: EX3DV4 - SN3971; ConvF(4.92, 4.92, 4.92); Calibrated: 2019/03/29
- Sensor-Surface: 1.4mm (Mechanical Surface Detection)
- Electronics: DAE4 Sn1431; Calibrated: 2019/03/25
- Phantom: ELI Phantom_1043; Type: QDOVA;
- Measurement SW: DASY52, Version 52.10 (2); SEMCAD X Version 14.6.12 (7470)

- **Area Scan (81x341x1):** Interpolated grid: dx=1.000 mm, dy=1.000 mm

Maximum value of SAR (interpolated) = 2.01 W/kg

- **Zoom Scan (6x6x12)/Cube 0:** Measurement grid: dx=5mm, dy=5mm, dz=2mm

Reference Value = 19.85 V/m; Power Drift = 0.01 dB

Peak SAR (extrapolated) = 5.02 W/kg

SAR(1 g) = 1.15 W/kg; SAR(10 g) = 0.248 W/kg

Maximum value of SAR (measured) = 3.25 W/kg

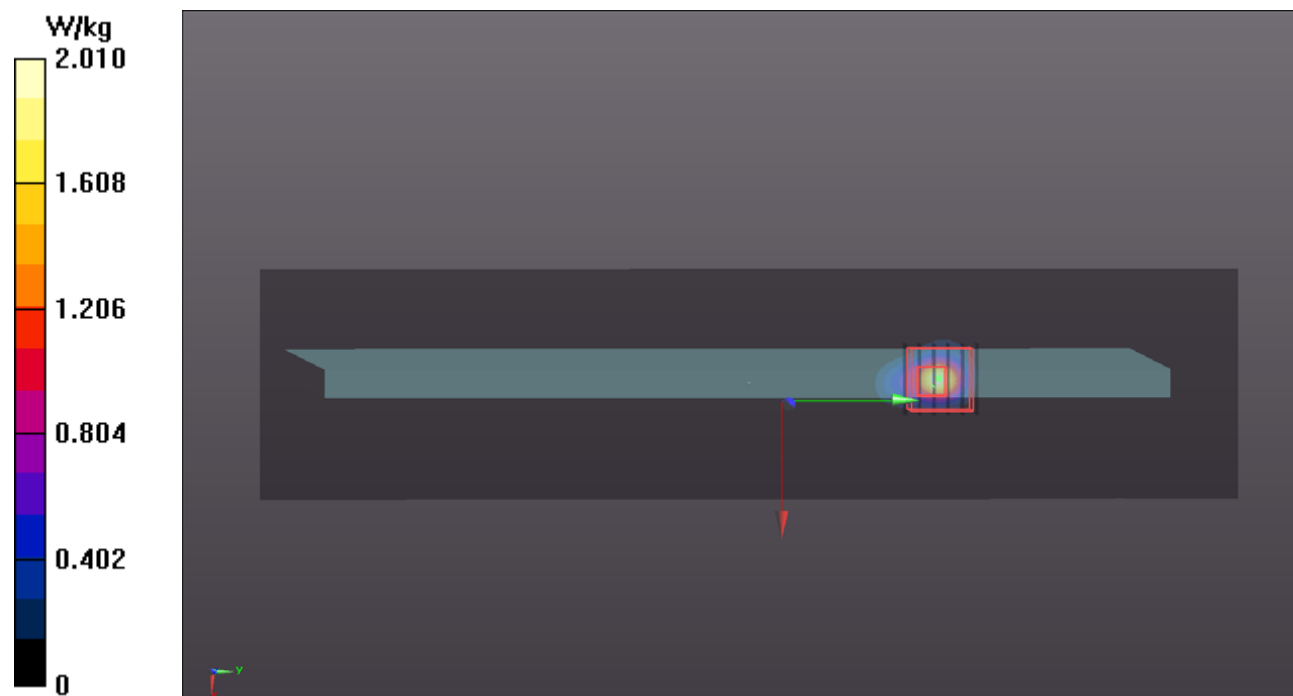

P05 BT_BDR_Rear Face_0mm_Ch78_Sample1_Ant1_keyboard_w_o

DUT: 190625C21

Communication System: BT; Frequency: 2480 MHz; Duty Cycle: 1:1.3

Medium: H19T27N3_0708 Medium parameters used: $f = 2480$ MHz; $\sigma = 1.903$ S/m; $\epsilon_r = 38.844$; $\rho = 1000$ kg/m³

Ambient Temperature : 23.7 °C ; Liquid Temperature : 23.2 °C

DASY5 Configuration:

- Probe: EX3DV4 - SN3971; ConvF(7.65, 7.65, 7.65); Calibrated: 2019/03/29
- Sensor-Surface: 1.4mm (Mechanical Surface Detection)
- Electronics: DAE4 Sn1431; Calibrated: 2019/03/25
- Phantom: ELI Phantom_1043; Type: QDOVA;
- Measurement SW: DASY52, Version 52.10 (2); SEMCAD X Version 14.6.12 (7470)

- **Area Scan (51x291x1):** Interpolated grid: dx=1.200 mm, dy=1.200 mm

Maximum value of SAR (interpolated) = 0.197 W/kg

- **Zoom Scan (5x5x7)/Cube 0:** Measurement grid: dx=8mm, dy=8mm, dz=5mm

Reference Value = 9.142 V/m; Power Drift = 0.11 dB

Peak SAR (extrapolated) = 0.835 W/kg

SAR(1 g) = 0.292 W/kg; SAR(10 g) = 0.099 W/kg

Maximum value of SAR (measured) = 0.446 W/kg

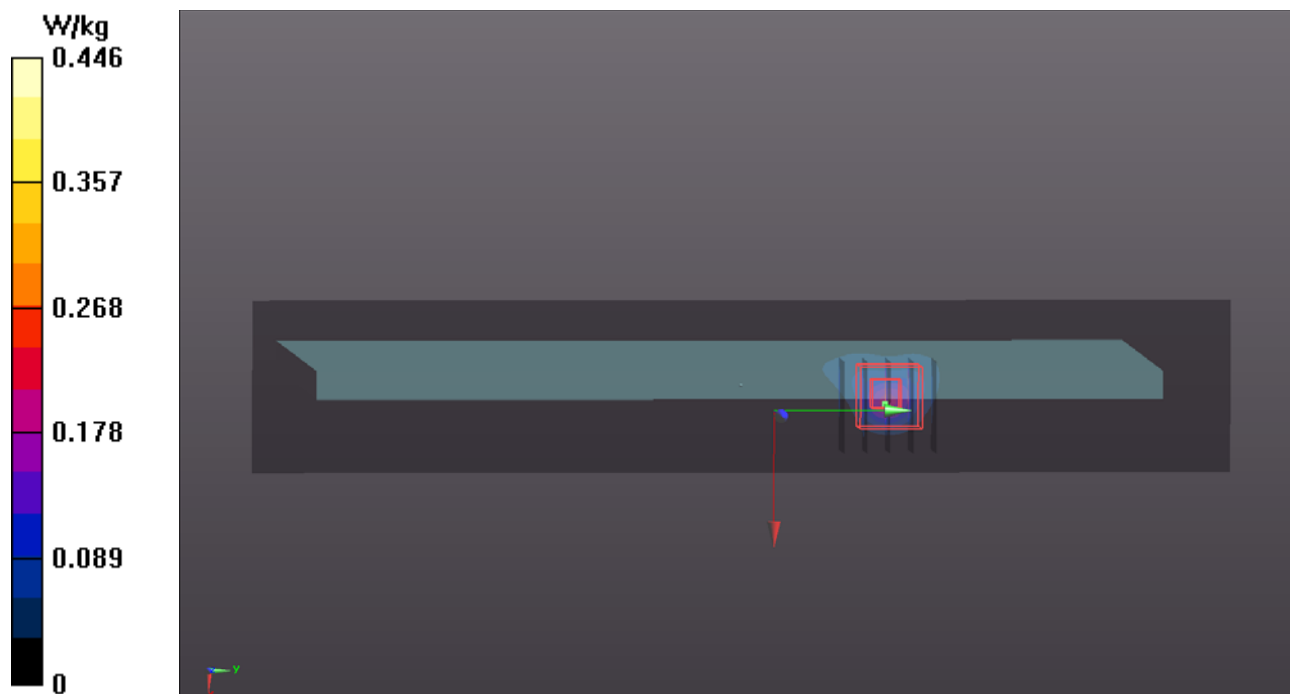

P06 WLAN2.4G_802.11b_Top Side_0mm_Ch12_Sample2_Ant1_keyboard_w_o

DUT: 190625C21

Communication System: WLAN_2.4G; Frequency: 2467 MHz; Duty Cycle: 1:1
Medium: H19T27N1_0710 Medium parameters used: $f = 2467$ MHz; $\sigma = 1.892$ S/m; $\epsilon_r = 38.25$; $\rho = 1000$ kg/m³
Ambient Temperature : 23.7 °C ; Liquid Temperature : 23.3 °C

DASY5 Configuration:

- Probe: EX3DV4 - SN7375; ConvF(7.64, 7.64, 7.64); Calibrated: 2018/12/13
- Sensor-Surface: 1.4mm (Mechanical Surface Detection)
- Electronics: DAE4 Sn1277; Calibrated: 2019/01/24
- Phantom: ELI Phantom_1204; Type: QDOVA;
- Measurement SW: DASY52, Version 52.10 (2); SEMCAD X Version 14.6.12 (7450)

- **Area Scan (71x291x1):** Interpolated grid: dx=1.200 mm, dy=1.200 mm
Maximum value of SAR (interpolated) = 1.09 W/kg

- **Zoom Scan (5x5x7)/Cube 0:** Measurement grid: dx=8mm, dy=8mm, dz=5mm
Reference Value = 24.82 V/m; Power Drift = -0.08 dB
Peak SAR (extrapolated) = 2.16 W/kg
SAR(1 g) = 0.839 W/kg; SAR(10 g) = 0.285 W/kg
Maximum value of SAR (measured) = 1.20 W/kg

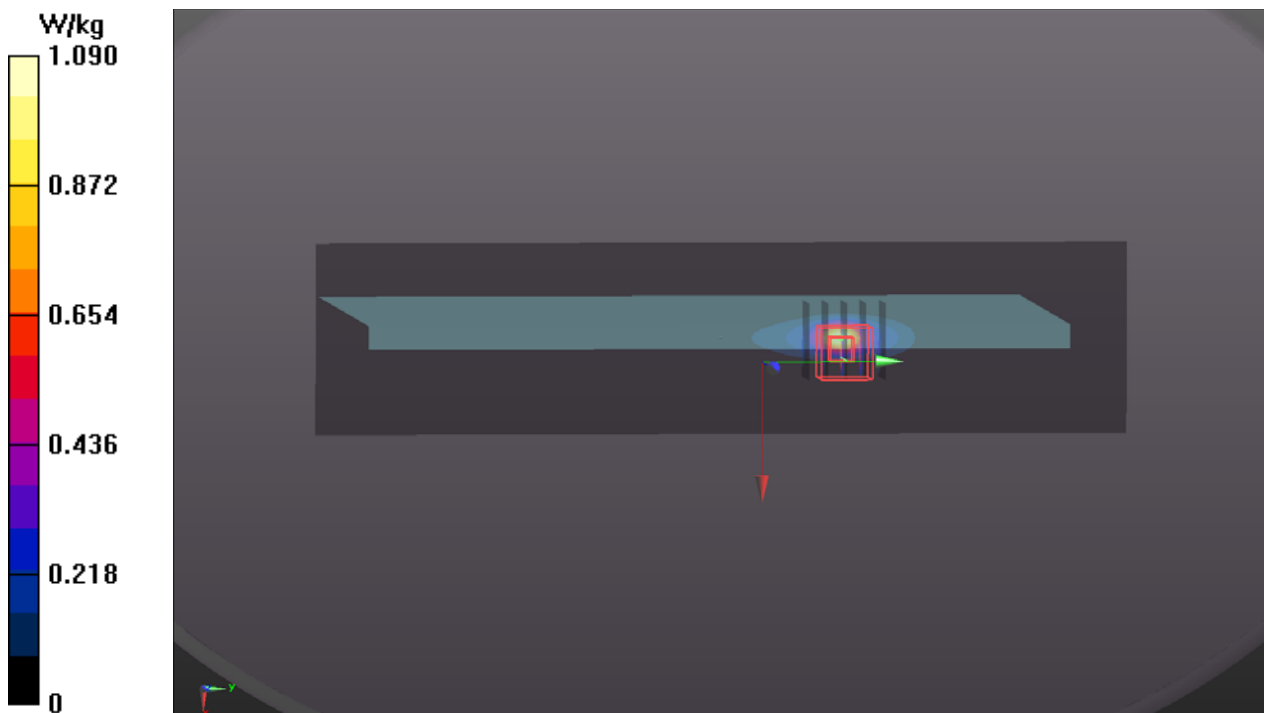

P07 WLAN5.3G_802.11ac VHT160_Top Side_0mm_Ch50_Sample2_Ant1_keyboard_w_o

DUT: 190625C21

Communication System: WLAN_5G; Frequency: 5250 MHz; Duty Cycle: 1:1.01
Medium: H34T60N1_0709 Medium parameters used: $f = 5250$ MHz; $\sigma = 4.606$ S/m; $\epsilon_r = 35.721$; $\rho = 1000$ kg/m³
Ambient Temperature : 23.7 °C ; Liquid Temperature : 23.3 °C

DASY5 Configuration:

- Probe: EX3DV4 - SN7375; ConvF(5.29, 5.29, 5.29); Calibrated: 2018/12/13
- Sensor-Surface: 1.4mm (Mechanical Surface Detection)
- Electronics: DAE4 Sn1277; Calibrated: 2019/01/24
- Phantom: ELI Phantom_1204; Type: QDOVA;
- Measurement SW: DASY52, Version 52.10 (2); SEMCAD X Version 14.6.12 (7450)

- **Area Scan (81x341x1):** Interpolated grid: dx=1.000 mm, dy=1.000 mm
Maximum value of SAR (interpolated) = 0.936 W/kg

- **Zoom Scan (6x6x12)/Cube 0:** Measurement grid: dx=5mm, dy=5mm, dz=2mm
Reference Value = 14.94 V/m; Power Drift = -0.01 dB
Peak SAR (extrapolated) = 5.39 W/kg
SAR(1 g) = 0.929 W/kg; SAR(10 g) = 0.168 W/kg
Maximum value of SAR (measured) = 3.13 W/kg

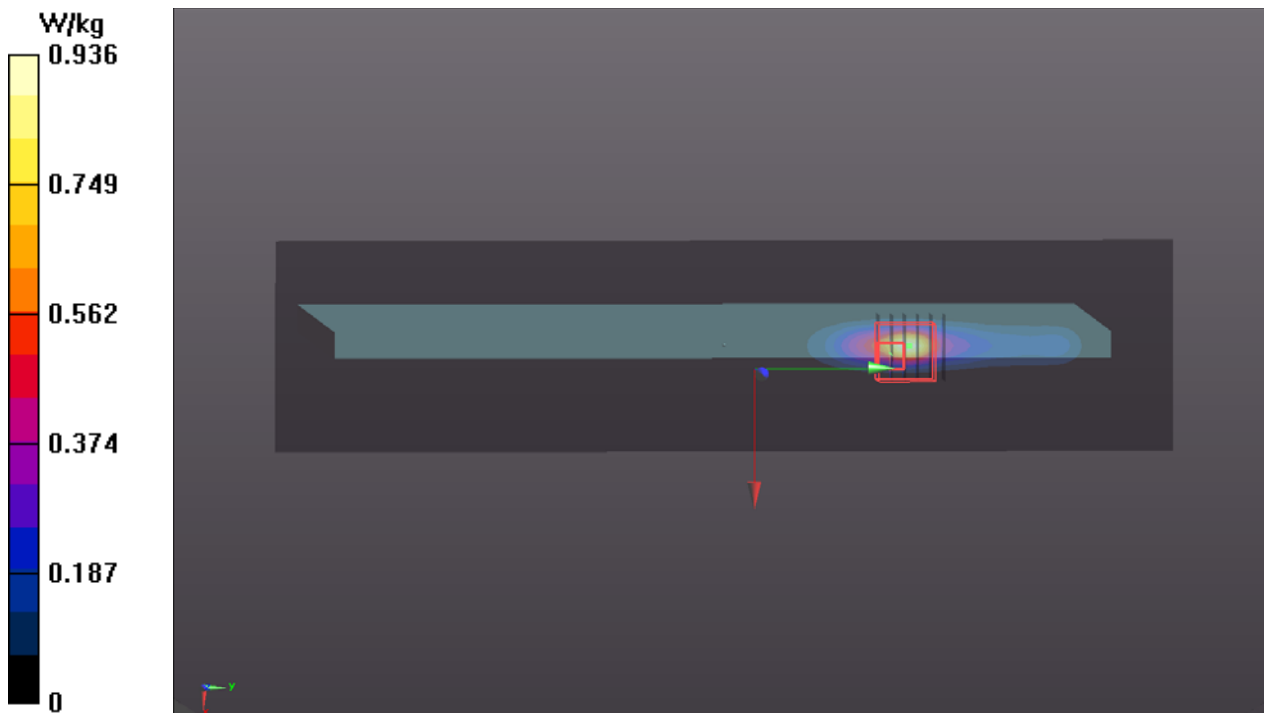

P08 WLAN5.6G_802.11ac VHT160_Top Side_0mm_Ch114_Sample2_Ant1_keyboard_w_o

DUT: 190625C21

Communication System: WLAN_5G; Frequency: 5570 MHz; Duty Cycle: 1:1.01
Medium: H34T60N1_0709 Medium parameters used: $f = 5570 \text{ MHz}$; $\sigma = 4.942 \text{ S/m}$; $\epsilon_r = 35.232$; $\rho = 1000 \text{ kg/m}^3$
Ambient Temperature : $23.7 \text{ }^\circ\text{C}$; Liquid Temperature : $23.3 \text{ }^\circ\text{C}$

DASY5 Configuration:

- Probe: EX3DV4 - SN7375; ConvF(4.69, 4.69, 4.69); Calibrated: 2018/12/13
- Sensor-Surface: 1.4mm (Mechanical Surface Detection)
- Electronics: DAE4 Sn1277; Calibrated: 2019/01/24
- Phantom: ELI Phantom_1204; Type: QDOVA;
- Measurement SW: DASY52, Version 52.10 (2); SEMCAD X Version 14.6.12 (7450)

- **Area Scan (81x341x1):** Interpolated grid: $dx=1.000 \text{ mm}$, $dy=1.000 \text{ mm}$
Maximum value of SAR (interpolated) = 1.28 W/kg

- **Zoom Scan (6x6x12)/Cube 0:** Measurement grid: $dx=5\text{mm}$, $dy=5\text{mm}$, $dz=2\text{mm}$
Reference Value = 17.44 V/m ; Power Drift = -0.03 dB
Peak SAR (extrapolated) = 6.69 W/kg
SAR(1 g) = 1.12 W/kg ; SAR(10 g) = 0.229 W/kg
Maximum value of SAR (measured) = 3.96 W/kg

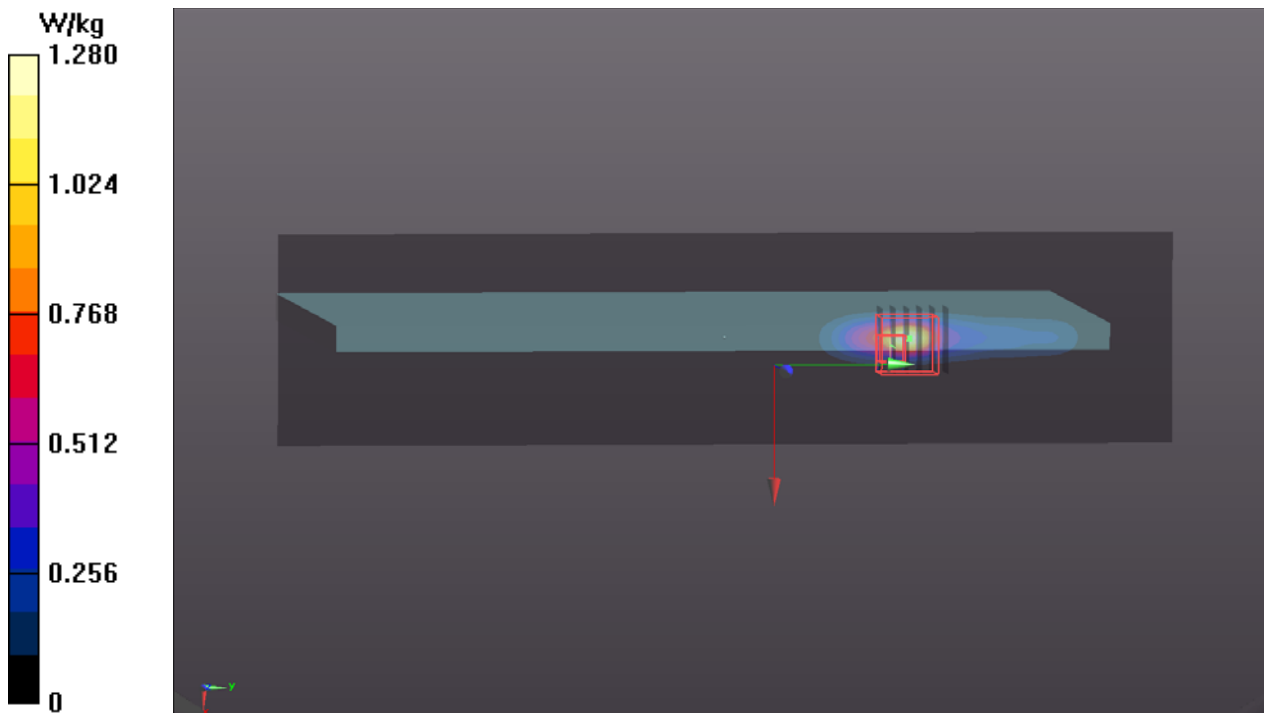

P09 WLAN5.8G_802.11ac VHT80_Top Side_0mm_Ch155_Sample2_Ant1_keyboard_w_o

DUT: 190625C21

Communication System: WLAN_5G; Frequency: 5775 MHz; Duty Cycle: 1:1.01
Medium: H34T60N1_0710 Medium parameters used: $f = 5775$ MHz; $\sigma = 5.157$ S/m; $\epsilon_r = 34.987$; $\rho = 1000$ kg/m³
Ambient Temperature : 23.7 °C ; Liquid Temperature : 23.3 °C

DASY5 Configuration:

- Probe: EX3DV4 - SN7375; ConvF(4.85, 4.85, 4.85); Calibrated: 2018/12/13
- Sensor-Surface: 1.4mm (Mechanical Surface Detection)
- Electronics: DAE4 Sn1277; Calibrated: 2019/01/24
- Phantom: ELI Phantom_1204; Type: QDOVA;
- Measurement SW: DASY52, Version 52.10 (2); SEMCAD X Version 14.6.12 (7450)

- **Area Scan (81x341x1):** Interpolated grid: dx=1.000 mm, dy=1.000 mm
Maximum value of SAR (interpolated) = 1.22 W/kg

- **Zoom Scan (6x6x12)/Cube 0:** Measurement grid: dx=5mm, dy=5mm, dz=2mm
Reference Value = 17.04 V/m; Power Drift = -0.09 dB
Peak SAR (extrapolated) = 5.11 W/kg
SAR(1 g) = 0.906 W/kg; SAR(10 g) = 0.185 W/kg
Maximum value of SAR (measured) = 3.01 W/kg

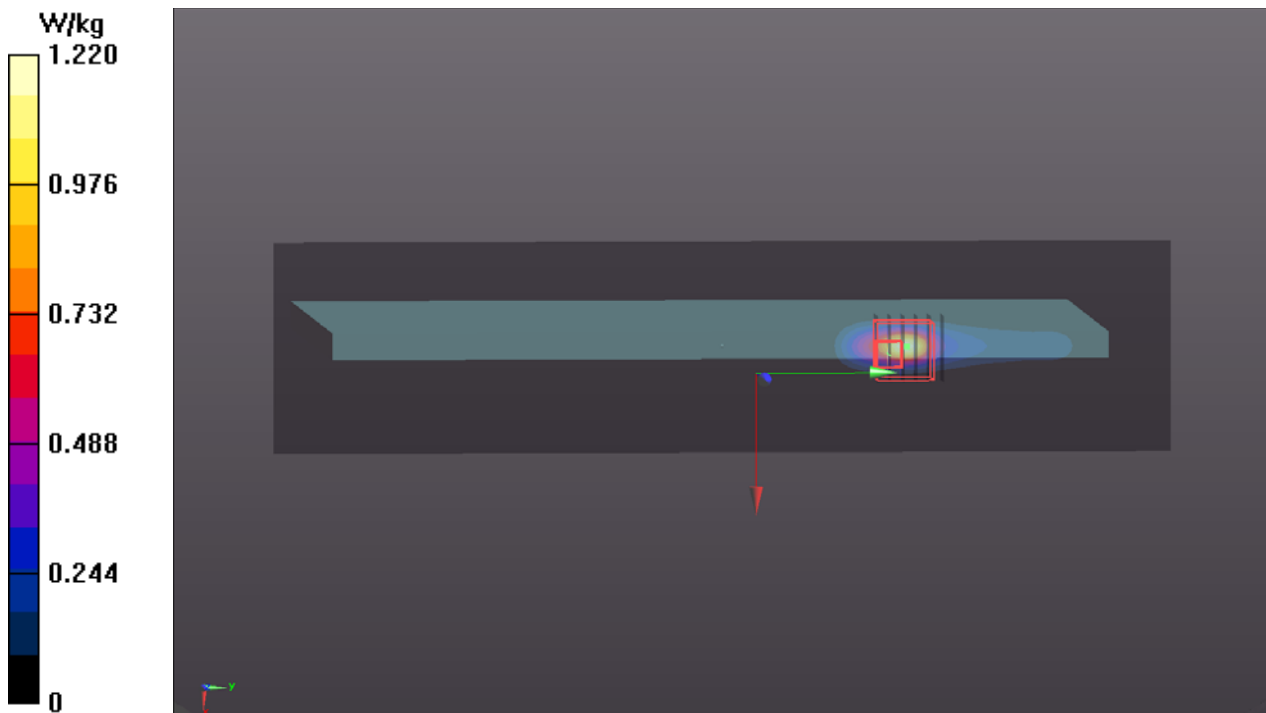

P10 BT_BDR_Top Side_0mm_Ch0_Sample2_Ant1_keyboard_w_o

DUT: 190625C21

Communication System: BT; Frequency: 2402 MHz; Duty Cycle: 1:1.3

Medium: H19T27N1_0709 Medium parameters used: $f = 2402$ MHz; $\sigma = 1.806$ S/m; $\epsilon_r = 38.904$; $\rho = 1000$ kg/m³

Ambient Temperature : 23.8 °C ; Liquid Temperature : 23.4 °C

DASY5 Configuration:

- Probe: EX3DV4 - SN3650; ConvF(7.63, 7.63, 7.63); Calibrated: 2019/05/20
- Sensor-Surface: 1.4mm (Mechanical Surface Detection)
- Electronics: DAE4 Sn861; Calibrated: 2019/05/08
- Phantom: ELI Phantom_1206; Type: QDOVA002AA;
- Measurement SW: DASY52, Version 52.10 (2); SEMCAD X Version 14.6.12 (7470)

- **Area Scan (51x291x1):** Interpolated grid: dx=1.200 mm, dy=1.200 mm

Maximum value of SAR (interpolated) = 0.313 W/kg

- **Zoom Scan (5x5x7)/Cube 0:** Measurement grid: dx=8mm, dy=8mm, dz=5mm

Reference Value = 12.55 V/m; Power Drift = 0.11 dB

Peak SAR (extrapolated) = 0.896 W/kg

SAR(1 g) = 0.316 W/kg; SAR(10 g) = 0.082 W/kg

Maximum value of SAR (measured) = 0.666 W/kg

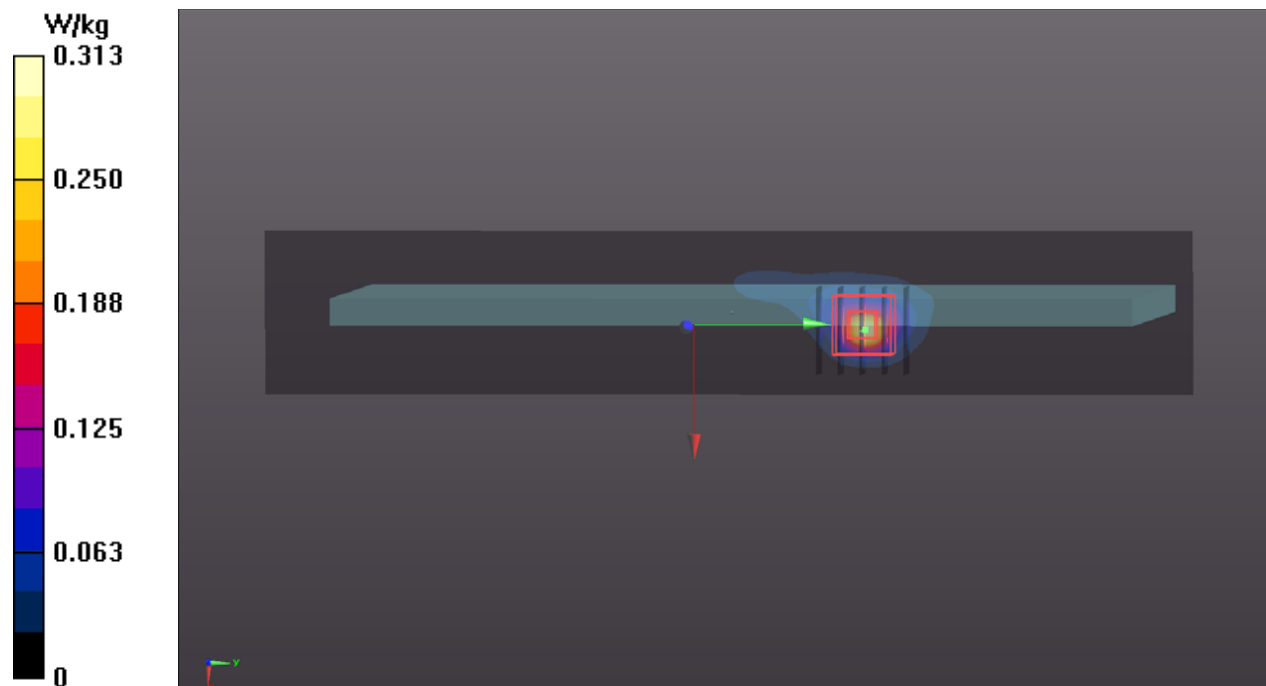

P11 WLAN2.4G_802.11b_Top of Pannel_25mm_Ch6_Sample1_Ant0

DUT: 190625C21

Communication System: WLAN_2.4G; Frequency: 2437 MHz; Duty Cycle: 1:1.01
Medium: H19T27N1_0717 Medium parameters used: $f = 2437$ MHz; $\sigma = 1.816$ S/m; $\epsilon_r = 38.635$; $\rho = 1000$ kg/m³
Ambient Temperature : 23.6 °C ; Liquid Temperature : 23.3 °C

DASY5 Configuration:

- Probe: EX3DV4 - SN7375; ConvF(7.64, 7.64, 7.64); Calibrated: 2018/12/13
- Sensor-Surface: 1.4mm (Mechanical Surface Detection)
- Electronics: DAE4 Sn1277; Calibrated: 2019/01/24
- Phantom: ELI Phantom_1204; Type: QDOVA;
- Measurement SW: DASY52, Version 52.10 (2); SEMCAD X Version 14.6.12 (7450)

- **Area Scan (71x291x1):** Interpolated grid: dx=1.200 mm, dy=1.200 mm
Maximum value of SAR (interpolated) = 0.572 W/kg

- **Zoom Scan (5x5x7)/Cube 0:** Measurement grid: dx=8mm, dy=8mm, dz=5mm
Reference Value = 16.15 V/m; Power Drift = 0.15 dB
Peak SAR (extrapolated) = 0.679 W/kg
SAR(1 g) = 0.399 W/kg; SAR(10 g) = 0.230 W/kg
Maximum value of SAR (measured) = 0.574 W/kg

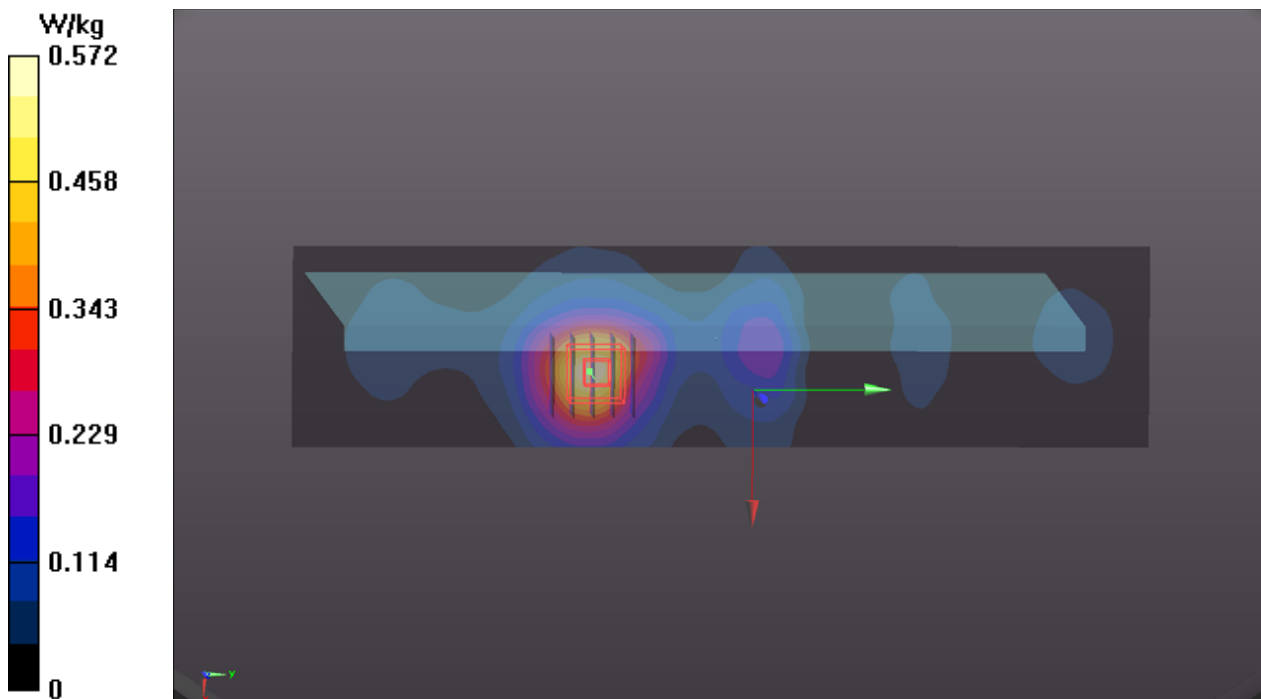

P12 WLAN5.3G_802.11a_Top of Pannel_25mm_Ch52_Sample1_Ant0

DUT: 190625C21

Communication System: WLAN_5G; Frequency: 5260 MHz; Duty Cycle: 1:1.03

Medium: H34T60N1_0718 Medium parameters used: $f = 5260$ MHz; $\sigma = 4.862$ S/m; $\epsilon_r = 35.687$; $\rho = 1000$ kg/m³

Ambient Temperature : 23.6 °C ; Liquid Temperature : 23.3 °C

DASY5 Configuration:

- Probe: EX3DV4 - SN7375; ConvF(5.29, 5.29, 5.29); Calibrated: 2018/12/13
- Sensor-Surface: 1.4mm (Mechanical Surface Detection)
- Electronics: DAE4 Sn1277; Calibrated: 2019/01/24
- Phantom: ELI Phantom_1204; Type: QDOVA;
- Measurement SW: DASY52, Version 52.10 (2); SEMCAD X Version 14.6.12 (7450)

- **Area Scan (81x341x1):** Interpolated grid: dx=1.000 mm, dy=1.000 mm
Maximum value of SAR (interpolated) = 1.54 W/kg

- **Zoom Scan (6x6x12)/Cube 0:** Measurement grid: dx=5mm, dy=5mm, dz=2mm
Reference Value = 19.27 V/m; Power Drift = -0.13 dB
Peak SAR (extrapolated) = 2.21 W/kg
SAR(1 g) = 0.749 W/kg; SAR(10 g) = 0.327 W/kg
Maximum value of SAR (measured) = 1.50 W/kg

- **Zoom Scan (6x6x12)/Cube 1:** Measurement grid: dx=5mm, dy=5mm, dz=2mm
Reference Value = 19.27 V/m; Power Drift = -0.13 dB
Peak SAR (extrapolated) = 1.74 W/kg
SAR(1 g) = 0.529 W/kg; SAR(10 g) = 0.225 W/kg
Maximum value of SAR (measured) = 1.04 W/kg

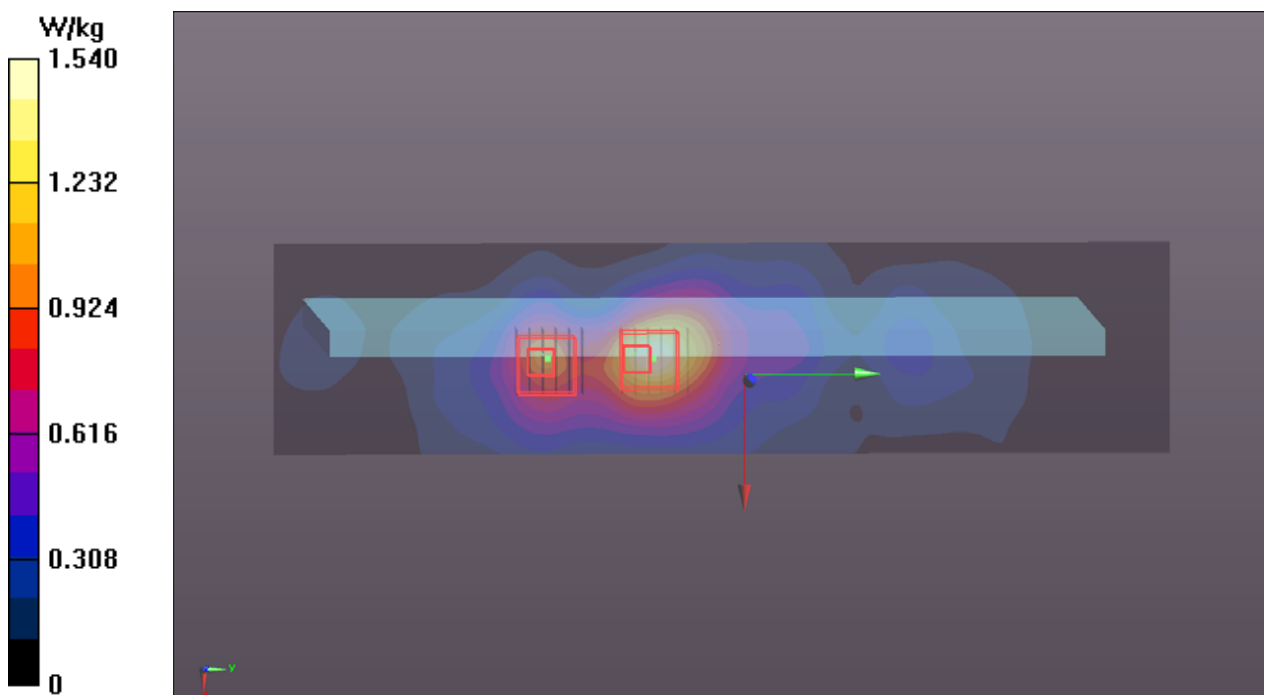

P13 WLAN5.6G_802.11n HT40_Top of Pannel_25mm_Ch110_Sample1_Ant1

DUT: 190625C21

Communication System: WLAN_5G; Frequency: 5550 MHz; Duty Cycle: 1:1.01
Medium: H34T60N1_0719 Medium parameters used: $f = 5550$ MHz; $\sigma = 4.948$ S/m; $\epsilon_r = 36.171$; $\rho = 1000$ kg/m³
Ambient Temperature : 23.6 °C ; Liquid Temperature : 23.2 °C

DASY5 Configuration:

- Probe: EX3DV4 - SN7375; ConvF(4.69, 4.69, 4.69); Calibrated: 2018/12/13
- Sensor-Surface: 1.4mm (Mechanical Surface Detection)
- Electronics: DAE4 Sn1277; Calibrated: 2019/01/24
- Phantom: ELI Phantom_1204; Type: QDOVA;
- Measurement SW: DASY52, Version 52.10 (2); SEMCAD X Version 14.6.12 (7450)

- **Area Scan (81x341x1):** Interpolated grid: dx=1.000 mm, dy=1.000 mm
Maximum value of SAR (interpolated) = 1.66 W/kg

- **Zoom Scan (6x6x12)/Cube 0:** Measurement grid: dx=5mm, dy=5mm, dz=2mm
Reference Value = 19.98 V/m; Power Drift = 0.02 dB
Peak SAR (extrapolated) = 2.86 W/kg
SAR(1 g) = 0.768 W/kg; SAR(10 g) = 0.321 W/kg
Maximum value of SAR (measured) = 1.65 W/kg

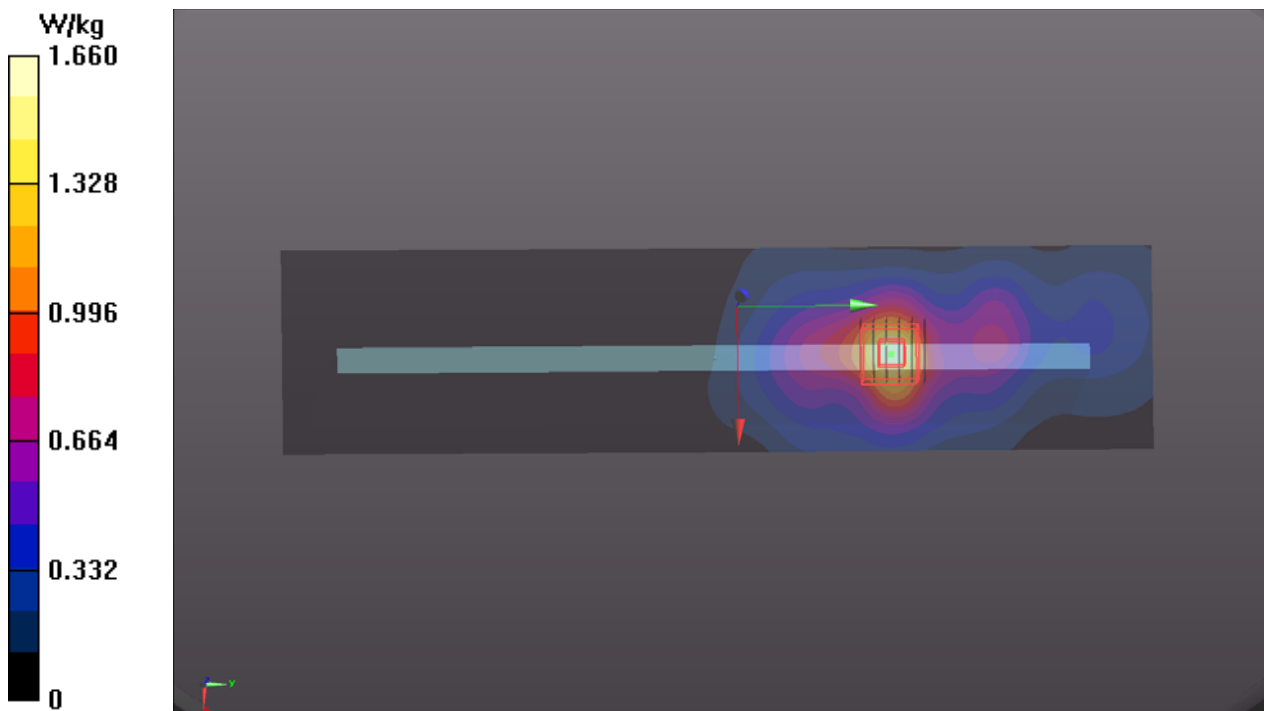

P14 WLAN5.8G_802.11n HT40_Top of Pannel_25mm_Ch151_Sample1_Ant1

DUT: 190625C21

Communication System: WLAN_5G; Frequency: 5755 MHz; Duty Cycle: 1:1.01
Medium: H34T60N1_0720 Medium parameters used : $f = 5755$ MHz; $\sigma = 5.279$ S/m; $\epsilon_r = 34.369$; $\rho = 1000$ kg/m³
Ambient Temperature : 23.6 °C ; Liquid Temperature : 23.2 °C

DASY5 Configuration:

- Probe: EX3DV4 - SN7375; ConvF(4.85, 4.85, 4.85); Calibrated: 2018/12/13
- Sensor-Surface: 1.4mm (Mechanical Surface Detection)
- Electronics: DAE4 Sn1277; Calibrated: 2019/01/24
- Phantom: ELI Phantom_1204; Type: QDOVA;
- Measurement SW: DASY52, Version 52.10 (2); SEMCAD X Version 14.6.12 (7450)

- **Area Scan (81x341x1):** Interpolated grid: dx=1.000 mm, dy=1.000 mm
Maximum value of SAR (interpolated) = 1.92 W/kg

- **Zoom Scan (6x6x12)/Cube 0:** Measurement grid: dx=5mm, dy=5mm, dz=2mm
Reference Value = 20.51 V/m; Power Drift = 0.12 dB
Peak SAR (extrapolated) = 3.76 W/kg
SAR(1 g) = 0.861 W/kg; SAR(10 g) = 0.351 W/kg
Maximum value of SAR (measured) = 1.87 W/kg

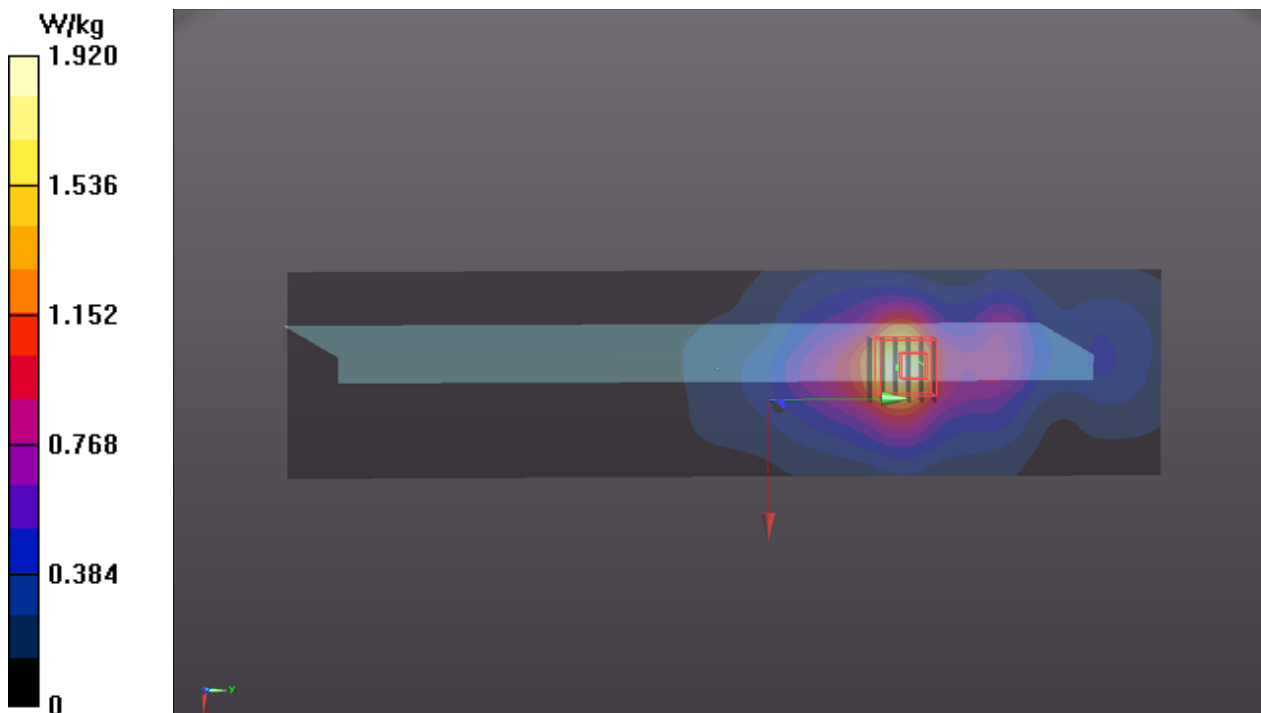

P15 BT_BDR_Top of Pannel_25mm_Ch78_Sample1_Ant1

DUT: 190625C21

Communication System: BT; Frequency: 2480 MHz; Duty Cycle: 1:1.3

Medium: H19T27N1_0717 Medium parameters used: $f = 2480$ MHz; $\sigma = 1.858$ S/m; $\epsilon_r = 38.47$; $\rho = 1000$ kg/m³

Ambient Temperature : 23.6 °C ; Liquid Temperature : 23.3 °C

DASY5 Configuration:

- Probe: EX3DV4 - SN7375; ConvF(7.64, 7.64, 7.64); Calibrated: 2018/12/13
- Sensor-Surface: 1.4mm (Mechanical Surface Detection)
- Electronics: DAE4 Sn1277; Calibrated: 2019/01/24
- Phantom: ELI Phantom_1204; Type: QDOVA;
- Measurement SW: DASY52, Version 52.10 (2); SEMCAD X Version 14.6.12 (7450)

- **Area Scan (71x291x1):** Interpolated grid: dx=1.200 mm, dy=1.200 mm

Maximum value of SAR (interpolated) = 0.0109 W/kg

- **Zoom Scan (5x5x7)/Cube 0:** Measurement grid: dx=8mm, dy=8mm, dz=5mm

Reference Value = 1.692 V/m; Power Drift = -0.15 dB

Peak SAR (extrapolated) = 0.0130 W/kg

SAR(1 g) = 0.00344 W/kg; SAR(10 g) = 0.00113 W/kg

Maximum value of SAR (measured) = 0.00732 W/kg

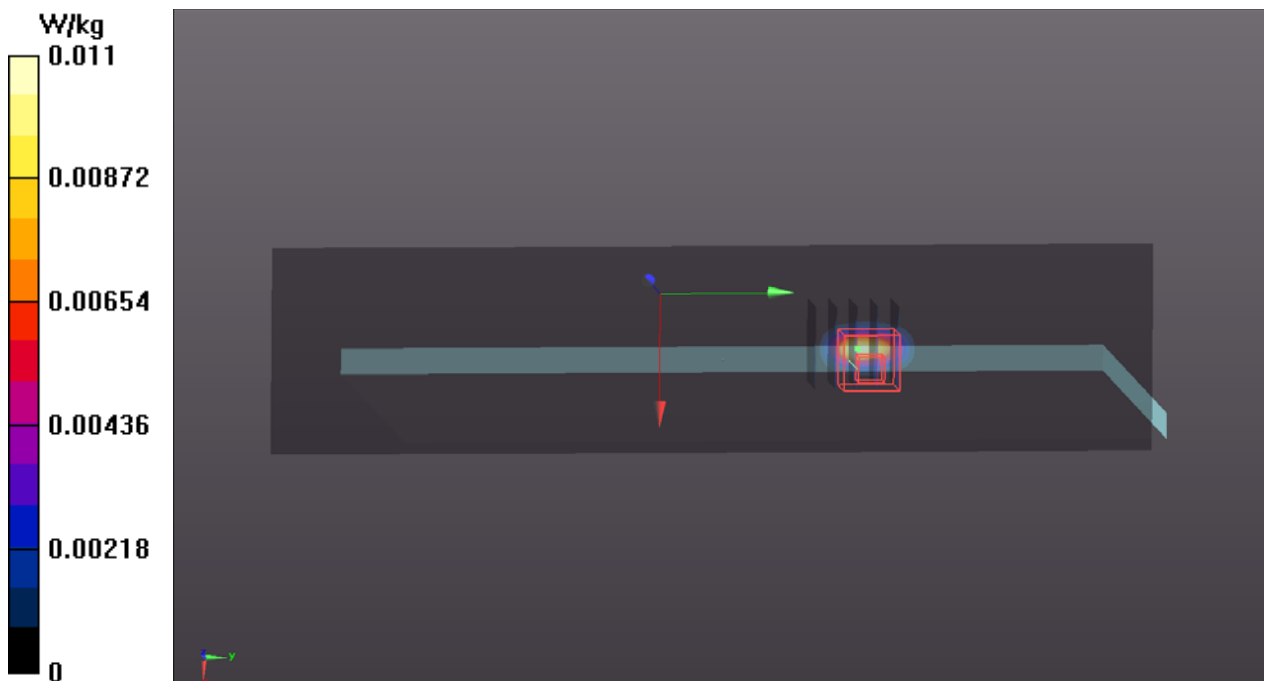

P16 WLAN2.4G_802.11b_Top of Pannel_25mm_Ch6_Sample2_Ant1

DUT: 190625C21

Communication System: WLAN_2.4G; Frequency: 2437 MHz; Duty Cycle: 1:1.01
Medium: H19T27N1_0717 Medium parameters used: $f = 2437$ MHz; $\sigma = 1.816$ S/m; $\epsilon_r = 38.635$; $\rho = 1000$ kg/m³
Ambient Temperature : 23.6 °C ; Liquid Temperature : 23.3 °C

DASY5 Configuration:

- Probe: EX3DV4 - SN7375; ConvF(7.64, 7.64, 7.64); Calibrated: 2018/12/13
- Sensor-Surface: 1.4mm (Mechanical Surface Detection)
- Electronics: DAE4 Sn1277; Calibrated: 2019/01/24
- Phantom: ELI Phantom_1204; Type: QDOVA;
- Measurement SW: DASY52, Version 52.10 (2); SEMCAD X Version 14.6.12 (7450)

- **Area Scan (71x291x1):** Interpolated grid: dx=1.200 mm, dy=1.200 mm
Maximum value of SAR (interpolated) = 0.463 W/kg

- **Zoom Scan (5x5x7)/Cube 0:** Measurement grid: dx=8mm, dy=8mm, dz=5mm
Reference Value = 13.38 V/m; Power Drift = 0.13 dB
Peak SAR (extrapolated) = 0.594 W/kg
SAR(1 g) = 0.332 W/kg; SAR(10 g) = 0.187 W/kg
Maximum value of SAR (measured) = 0.489 W/kg

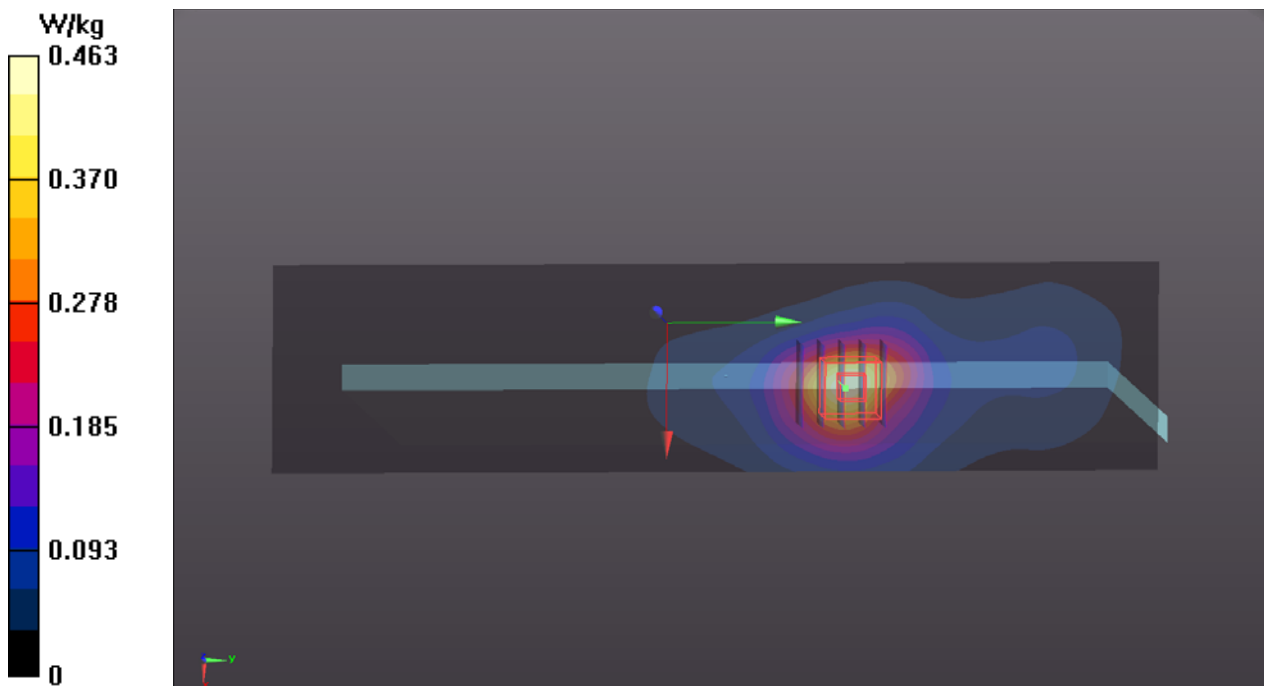

P17 WLAN5.3G_802.11a_Top of Pannel_25mm_Ch52_Sample2_Ant1

DUT: 190625C21

Communication System: WLAN_5G; Frequency: 5260 MHz; Duty Cycle: 1:1.03

Medium: H34T60N1_0718 Medium parameters used: $f = 5260$ MHz; $\sigma = 4.862$ S/m; $\epsilon_r = 35.687$; $\rho = 1000$ kg/m³

Ambient Temperature : 23.6 °C ; Liquid Temperature : 23.3 °C

DASY5 Configuration:

- Probe: EX3DV4 - SN7375; ConvF(5.29, 5.29, 5.29); Calibrated: 2018/12/13
- Sensor-Surface: 1.4mm (Mechanical Surface Detection)
- Electronics: DAE4 Sn1277; Calibrated: 2019/01/24
- Phantom: ELI Phantom_1204; Type: QDOVA;
- Measurement SW: DASY52, Version 52.10 (2); SEMCAD X Version 14.6.12 (7450)

- **Area Scan (81x341x1):** Interpolated grid: dx=1.000 mm, dy=1.000 mm

Maximum value of SAR (interpolated) = 1.70 W/kg

- **Zoom Scan (6x6x12)/Cube 0:** Measurement grid: dx=5mm, dy=5mm, dz=2mm

Reference Value = 11.95 V/m; Power Drift = 0.01 dB

Peak SAR (extrapolated) = 3.19 W/kg

SAR(1 g) = 0.919 W/kg; SAR(10 g) = 0.387 W/kg

Maximum value of SAR (measured) = 1.84 W/kg

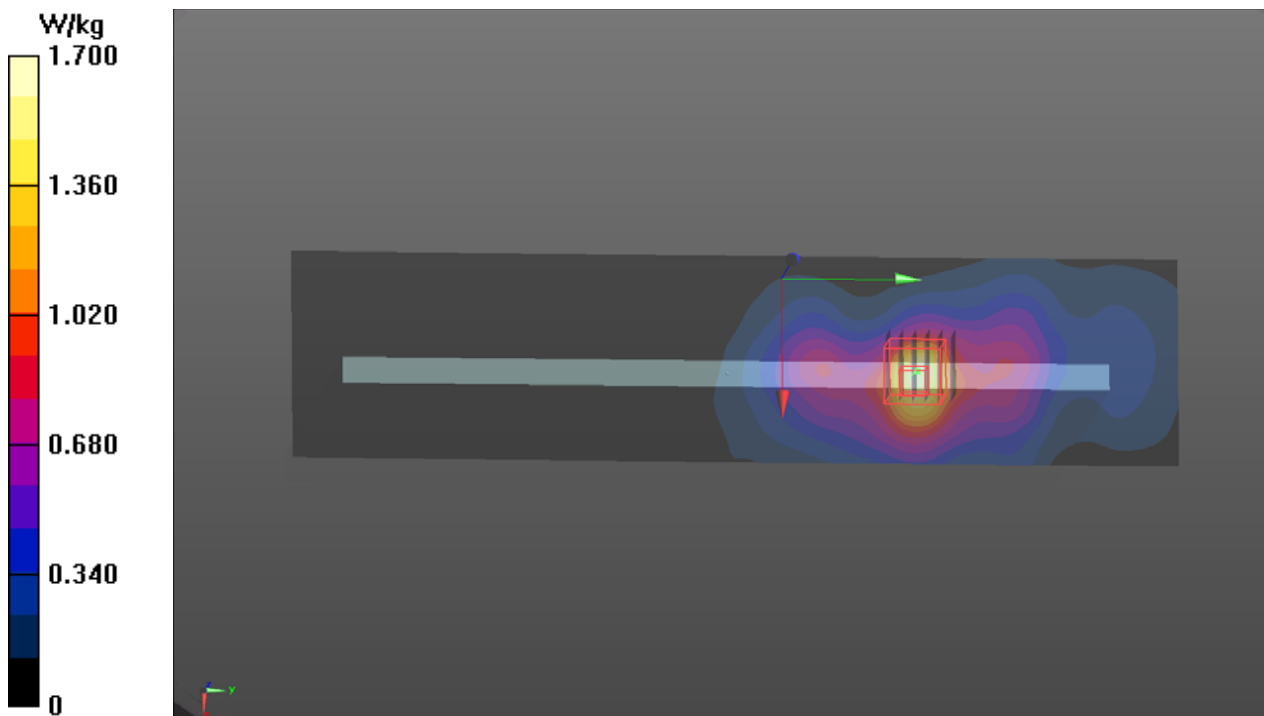

P18 WLAN5.6G_802.11n HT40_Top of Pannel_25mm_Ch110_Sample2_Ant1

DUT: 190625C21

Communication System: WLAN_5G; Frequency: 5550 MHz; Duty Cycle: 1:1.01

Medium: H34T60N1_0719 Medium parameters used: $f = 5550$ MHz; $\sigma = 4.948$ S/m; $\epsilon_r = 36.171$; $\rho = 1000$ kg/m³

Ambient Temperature : 23.6 °C ; Liquid Temperature : 23.2 °C

DASY5 Configuration:

- Probe: EX3DV4 - SN7375; ConvF(4.69, 4.69, 4.69); Calibrated: 2018/12/13
- Sensor-Surface: 1.4mm (Mechanical Surface Detection)
- Electronics: DAE4 Sn1277; Calibrated: 2019/01/24
- Phantom: ELI Phantom_1204; Type: QDOVA;
- Measurement SW: DASY52, Version 52.10 (2); SEMCAD X Version 14.6.12 (7450)

- **Area Scan (81x341x1):** Interpolated grid: dx=1.000 mm, dy=1.000 mm

Maximum value of SAR (interpolated) = 1.49 W/kg

- **Zoom Scan (6x6x12)/Cube 0:** Measurement grid: dx=5mm, dy=5mm, dz=2mm

Reference Value = 18.74 V/m; Power Drift = -0.02 dB

Peak SAR (extrapolated) = 2.86 W/kg

SAR(1 g) = 0.709 W/kg; SAR(10 g) = 0.298 W/kg

Maximum value of SAR (measured) = 1.54 W/kg

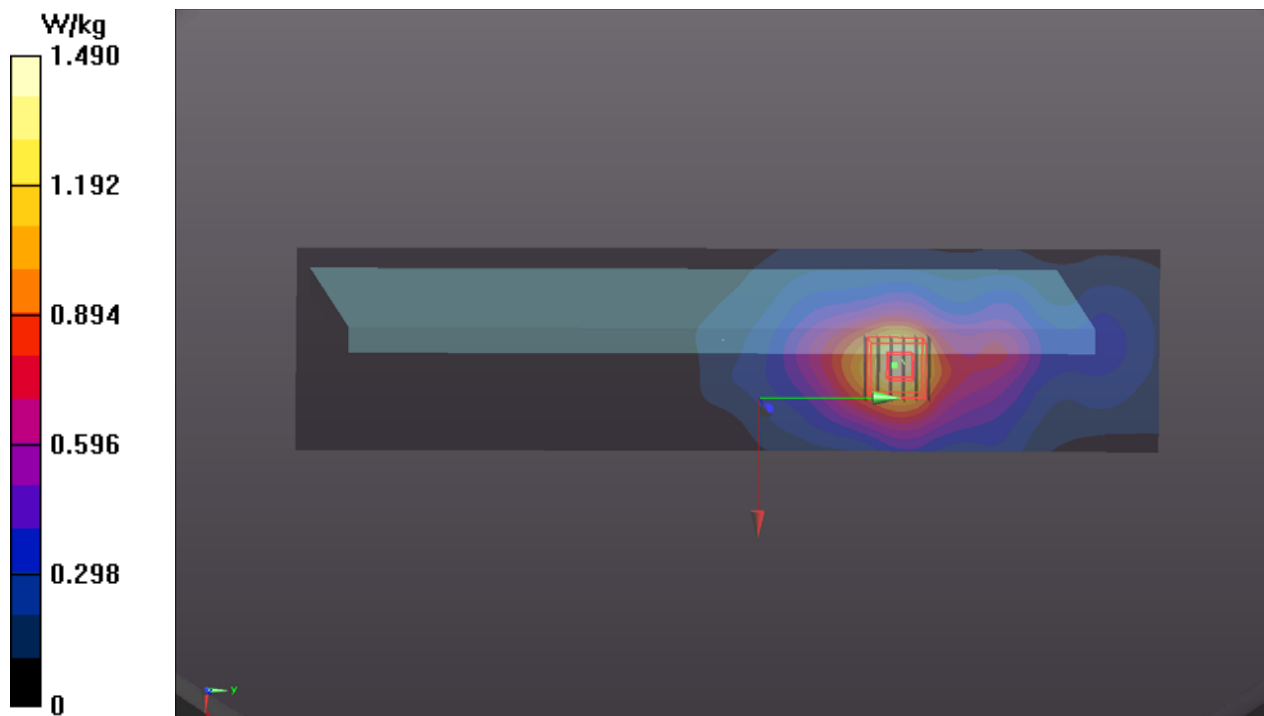

P19 WLAN5.8G_802.11a_Top of Pannel_25mm_Ch149_Sample2_Ant0

DUT: 190625C21

Communication System: WLAN_5G; Frequency: 5745 MHz; Duty Cycle: 1:1.03
Medium: H34T60N1_0720 Medium parameters used: $f = 5745$ MHz; $\sigma = 5.272$ S/m; $\epsilon_r = 34.385$; $\rho = 1000$ kg/m³
Ambient Temperature : 23.8 °C ; Liquid Temperature : 23.3 °C

DASY5 Configuration:

- Probe: EX3DV4 - SN7375; ConvF(4.85, 4.85, 4.85); Calibrated: 2018/12/13
- Sensor-Surface: 1.4mm (Mechanical Surface Detection)
- Electronics: DAE4 Sn1277; Calibrated: 2019/01/24
- Phantom: ELI Phantom_1204; Type: QDOVA;
- Measurement SW: DASY52, Version 52.10 (2); SEMCAD X Version 14.6.12 (7450)

- **Area Scan (81x341x1):** Interpolated grid: dx=1.000 mm, dy=1.000 mm
Maximum value of SAR (interpolated) = 2.07 W/kg

- **Zoom Scan (6x6x12)/Cube 0:** Measurement grid: dx=5mm, dy=5mm, dz=2mm
Reference Value = 21.11 V/m; Power Drift = -0.06 dB
Peak SAR (extrapolated) = 3.66 W/kg
SAR(1 g) = 0.937 W/kg; SAR(10 g) = 0.407 W/kg
Maximum value of SAR (measured) = 2.09 W/kg

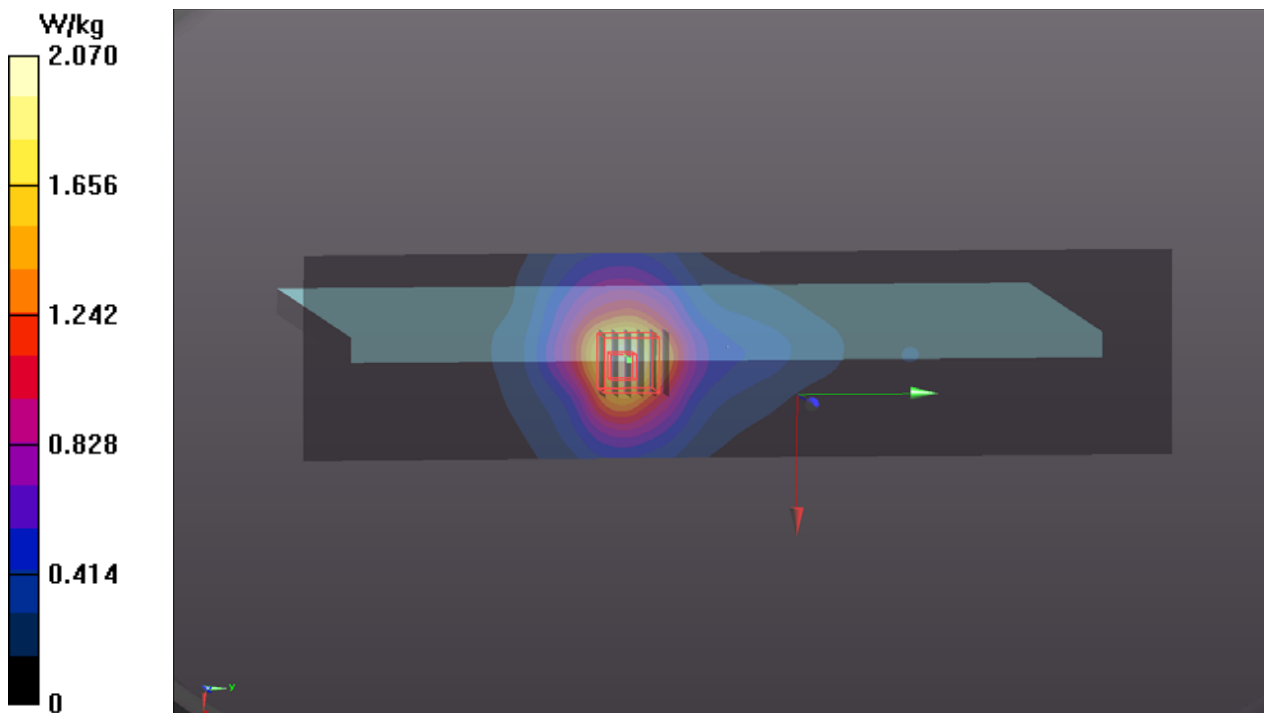

P20 BT_BDR_Top of Pannel_25mm_Ch78_Sample2_Ant1

DUT: 190625C21

Communication System: BT; Frequency: 2480 MHz; Duty Cycle: 1:1.3

Medium: H19T27N1_0717 Medium parameters used: $f = 2480$ MHz; $\sigma = 1.858$ S/m; $\epsilon_r = 38.47$; $\rho = 1000$ kg/m³

Ambient Temperature : 23.6 °C ; Liquid Temperature : 23.3 °C

DASY5 Configuration:

- Probe: EX3DV4 - SN7375; ConvF(7.64, 7.64, 7.64); Calibrated: 2018/12/13
- Sensor-Surface: 1.4mm (Mechanical Surface Detection)
- Electronics: DAE4 Sn1277; Calibrated: 2019/01/24
- Phantom: ELI Phantom_1204; Type: QDOVA;
- Measurement SW: DASY52, Version 52.10 (2); SEMCAD X Version 14.6.12 (7450)

- **Area Scan (71x291x1):** Interpolated grid: dx=1.200 mm, dy=1.200 mm

Maximum value of SAR (interpolated) = 0.0570 W/kg

- **Zoom Scan (5x5x7)/Cube 0:** Measurement grid: dx=8mm, dy=8mm, dz=5mm

Reference Value = 3.697 V/m; Power Drift = 0.18 dB

Peak SAR (extrapolated) = 0.0390 W/kg

SAR(1 g) = 0.016 W/kg; SAR(10 g) = 0.00696 W/kg

Maximum value of SAR (measured) = 0.0261 W/kg

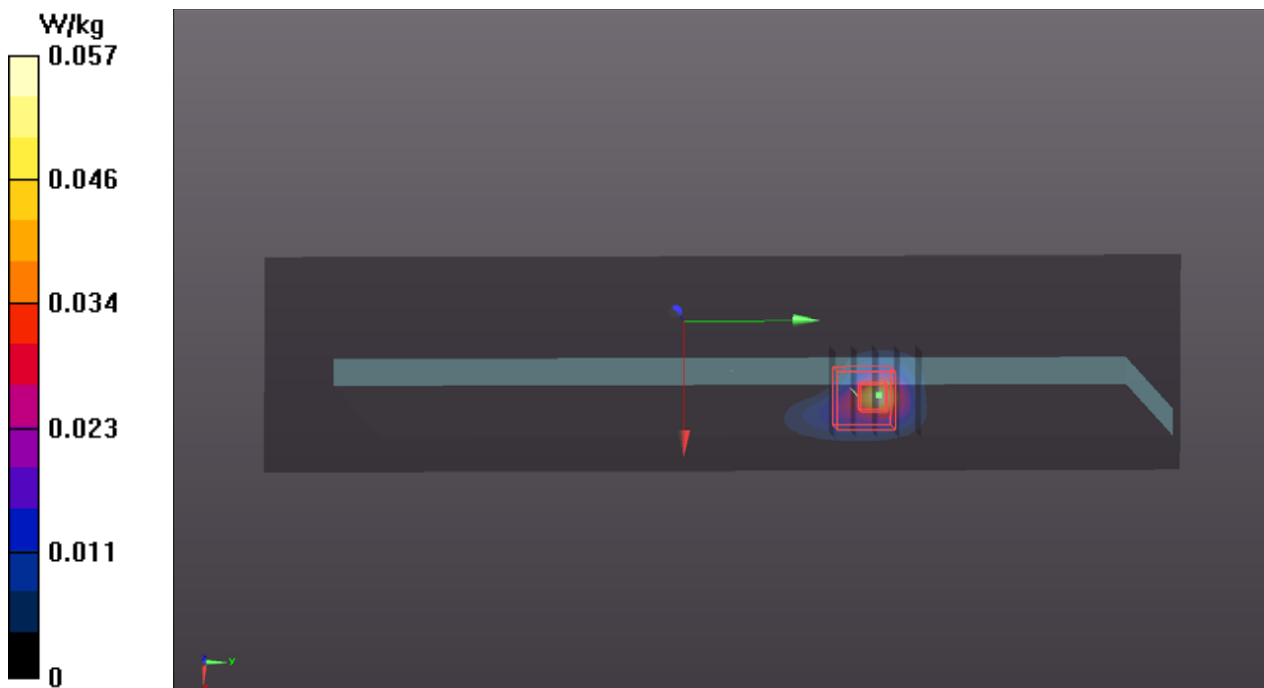



Appendix C. Calibration Certificate for Probe and Dipole

The SPEAG calibration certificates are shown as follows.



Accredited by the Swiss Accreditation Service (SAS)
The Swiss Accreditation Service is one of the signatories to the EA
Multilateral Agreement for the recognition of calibration certificates

Accreditation No.: **SCS 0108**

Client **B.V. ADT (Auden)**

Certificate No: **D2450V2-737_Aug18**

CALIBRATION CERTIFICATE

Object **D2450V2 - SN:737**

Calibration procedure(s) **QA CAL-05.v10
Calibration procedure for dipole validation kits above 700 MHz**

Calibration date: **August 24, 2018**

This calibration certificate documents the traceability to national standards, which realize the physical units of measurements (SI).
The measurements and the uncertainties with confidence probability are given on the following pages and are part of the certificate.

All calibrations have been conducted in the closed laboratory facility: environment temperature (22 ± 3)°C and humidity < 70%.

Calibration Equipment used (M&TE critical for calibration)

Primary Standards	ID #	Cal Date (Certificate No.)	Scheduled Calibration
Power meter NRP	SN: 104778	04-Apr-18 (No. 217-02672/02673)	Apr-19
Power sensor NRP-Z91	SN: 103244	04-Apr-18 (No. 217-02672)	Apr-19
Power sensor NRP-Z91	SN: 103245	04-Apr-18 (No. 217-02673)	Apr-19
Reference 20 dB Attenuator	SN: 5058 (20k)	04-Apr-18 (No. 217-02682)	Apr-19
Type-N mismatch combination	SN: 5047.2 / 06327	04-Apr-18 (No. 217-02683)	Apr-19
Reference Probe EX3DV4	SN: 7349	30-Dec-17 (No. EX3-7349_Dec17)	Dec-18
DAE4	SN: 601	26-Oct-17 (No. DAE4-601_Oct17)	Oct-18
Secondary Standards	ID #	Check Date (in house)	Scheduled Check
Power meter EPM-442A	SN: GB37480704	07-Oct-15 (in house check Oct-16)	In house check: Oct-18
Power sensor HP 8481A	SN: US37292783	07-Oct-15 (in house check Oct-16)	In house check: Oct-18
Power sensor HP 8481A	SN: MY41092317	07-Oct-15 (in house check Oct-16)	In house check: Oct-18
RF generator R&S SMT-06	SN: 100972	15-Jun-15 (in house check Oct-16)	In house check: Oct-18
Network Analyzer Agilent E8358A	SN: US41080477	31-Mar-14 (in house check Oct-17)	In house check: Oct-18

Calibrated by: **Manu Seitz** **Manu Seitz** **Manu Seitz**
Name Function Signature
Laboratory Technician

Approved by: **Katja Pokovic** **Katja Pokovic**
Technical Manager

Issued: August 24, 2018

This calibration certificate shall not be reproduced except in full without written approval of the laboratory.



Accredited by the Swiss Accreditation Service (SAS)

The Swiss Accreditation Service is one of the signatories to the EA
Multilateral Agreement for the recognition of calibration certificates

Accreditation No.: **SCS 0108**

Glossary:

TSL	tissue simulating liquid
ConvF	sensitivity in TSL / NORM x,y,z
N/A	not applicable or not measured

Calibration is Performed According to the Following Standards:

- IEEE Std 1528-2013, "IEEE Recommended Practice for Determining the Peak Spatial-Averaged Specific Absorption Rate (SAR) in the Human Head from Wireless Communications Devices: Measurement Techniques", June 2013
- IEC 62209-1, "Measurement procedure for the assessment of Specific Absorption Rate (SAR) from hand-held and body-mounted devices used next to the ear (frequency range of 300 MHz to 6 GHz)", July 2016
- IEC 62209-2, "Procedure to determine the Specific Absorption Rate (SAR) for wireless communication devices used in close proximity to the human body (frequency range of 30 MHz to 6 GHz)", March 2010
- KDB 865664, "SAR Measurement Requirements for 100 MHz to 6 GHz"

Additional Documentation:

- DASY4/5 System Handbook

Methods Applied and Interpretation of Parameters:

- Measurement Conditions:** Further details are available from the Validation Report at the end of the certificate. All figures stated in the certificate are valid at the frequency indicated.
- Antenna Parameters with TSL:** The dipole is mounted with the spacer to position its feed point exactly below the center marking of the flat phantom section, with the arms oriented parallel to the body axis.
- Feed Point Impedance and Return Loss:** These parameters are measured with the dipole positioned under the liquid filled phantom. The impedance stated is transformed from the measurement at the SMA connector to the feed point. The Return Loss ensures low reflected power. No uncertainty required.
- Electrical Delay:** One-way delay between the SMA connector and the antenna feed point. No uncertainty required.
- SAR measured:** SAR measured at the stated antenna input power.
- SAR normalized:** SAR as measured, normalized to an input power of 1 W at the antenna connector.
- SAR for nominal TSL parameters:** The measured TSL parameters are used to calculate the nominal SAR result.

The reported uncertainty of measurement is stated as the standard uncertainty of measurement multiplied by the coverage factor $k=2$, which for a normal distribution corresponds to a coverage probability of approximately 95%.

Measurement Conditions

DASY system configuration, as far as not given on page 1.

DASY Version	DASY5	V52.10.1
Extrapolation	Advanced Extrapolation	
Phantom	Modular Flat Phantom	
Distance Dipole Center - TSL	10 mm	with Spacer
Zoom Scan Resolution	dx, dy, dz = 5 mm	
Frequency	2450 MHz \pm 1 MHz	

Head TSL parameters

The following parameters and calculations were applied.

	Temperature	Permittivity	Conductivity
Nominal Head TSL parameters	22.0 °C	39.2	1.80 mho/m
Measured Head TSL parameters	(22.0 \pm 0.2) °C	37.7 \pm 6 %	1.86 mho/m \pm 6 %
Head TSL temperature change during test	< 0.5 °C	----	----

SAR result with Head TSL

SAR averaged over 1 cm³ (1 g) of Head TSL	Condition	
SAR measured	250 mW input power	13.2 W/kg
SAR for nominal Head TSL parameters	normalized to 1W	51.5 W/kg \pm 17.0 % (k=2)

SAR averaged over 10 cm³ (10 g) of Head TSL	condition	
SAR measured	250 mW input power	6.13 W/kg
SAR for nominal Head TSL parameters	normalized to 1W	24.2 W/kg \pm 16.5 % (k=2)

Body TSL parameters

The following parameters and calculations were applied.

	Temperature	Permittivity	Conductivity
Nominal Body TSL parameters	22.0 °C	52.7	1.95 mho/m
Measured Body TSL parameters	(22.0 \pm 0.2) °C	51.8 \pm 6 %	2.02 mho/m \pm 6 %
Body TSL temperature change during test	< 0.5 °C	----	----

SAR result with Body TSL

SAR averaged over 1 cm³ (1 g) of Body TSL	Condition	
SAR measured	250 mW input power	12.9 W/kg
SAR for nominal Body TSL parameters	normalized to 1W	50.5 W/kg \pm 17.0 % (k=2)

SAR averaged over 10 cm³ (10 g) of Body TSL	condition	
SAR measured	250 mW input power	6.01 W/kg
SAR for nominal Body TSL parameters	normalized to 1W	23.8 W/kg \pm 16.5 % (k=2)

Appendix (Additional assessments outside the scope of SCS 0108)

Antenna Parameters with Head TSL

Impedance, transformed to feed point	55.6 Ω + 4.1 j Ω
Return Loss	- 23.7 dB

Antenna Parameters with Body TSL

Impedance, transformed to feed point	49.4 Ω + 7.3 j Ω
Return Loss	- 22.7 dB

General Antenna Parameters and Design

Electrical Delay (one direction)	1.162 ns
----------------------------------	----------

After long term use with 100W radiated power, only a slight warming of the dipole near the feedpoint can be measured.

The dipole is made of standard semirigid coaxial cable. The center conductor of the feeding line is directly connected to the second arm of the dipole. The antenna is therefore short-circuited for DC-signals. On some of the dipoles, small end caps are added to the dipole arms in order to improve matching when loaded according to the position as explained in the "Measurement Conditions" paragraph. The SAR data are not affected by this change. The overall dipole length is still according to the Standard.

No excessive force must be applied to the dipole arms, because they might bend or the soldered connections near the feedpoint may be damaged.

Additional EUT Data

Manufactured by	SPEAG
Manufactured on	August 26, 2003

DASY5 Validation Report for Head TSL

Date: 23.08.2018

Test Laboratory: SPEAG, Zurich, Switzerland

DUT: Dipole 2450 MHz; Type: D2450V2; Serial: D2450V2 - SN:737

Communication System: UID 0 - CW; Frequency: 2450 MHz

Medium parameters used: $f = 2450$ MHz; $\sigma = 1.86$ S/m; $\epsilon_r = 37.7$; $\rho = 1000$ kg/m³

Phantom section: Flat Section

Measurement Standard: DASY5 (IEEE/IEC/ANSI C63.19-2011)

DASY52 Configuration:

- Probe: EX3DV4 - SN7349; ConvF(7.88, 7.88, 7.88) @ 2450 MHz; Calibrated: 30.12.2017
- Sensor-Surface: 1.4mm (Mechanical Surface Detection)
- Electronics: DAE4 Sn601; Calibrated: 26.10.2017
- Phantom: Flat Phantom 5.0 (front); Type: QD 000 P50 AA; Serial: 1001
- DASY52 52.10.1(1476); SEMCAD X 14.6.11(7439)

Dipole Calibration for Head Tissue/Pin=250 mW, d=10mm/Zoom Scan (7x7x7)/Cube 0:

Measurement grid: dx=5mm, dy=5mm, dz=5mm

Reference Value = 115.2 V/m; Power Drift = -0.05 dB

Peak SAR (extrapolated) = 26.1 W/kg

SAR(1 g) = 13.2 W/kg; SAR(10 g) = 6.13 W/kg

Maximum value of SAR (measured) = 21.7 W/kg

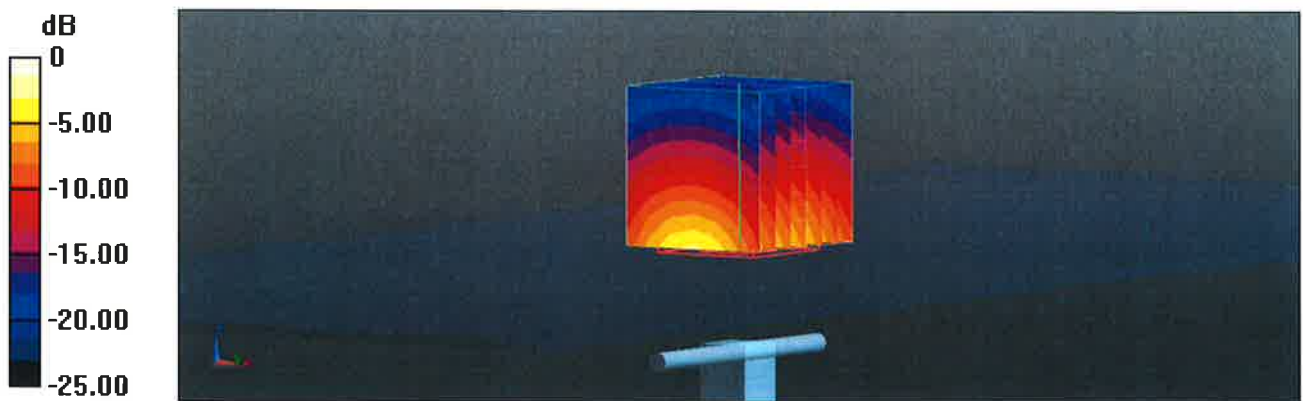

0 dB = 21.7 W/kg = 13.36 dBW/kg

Impedance Measurement Plot for Head TSL

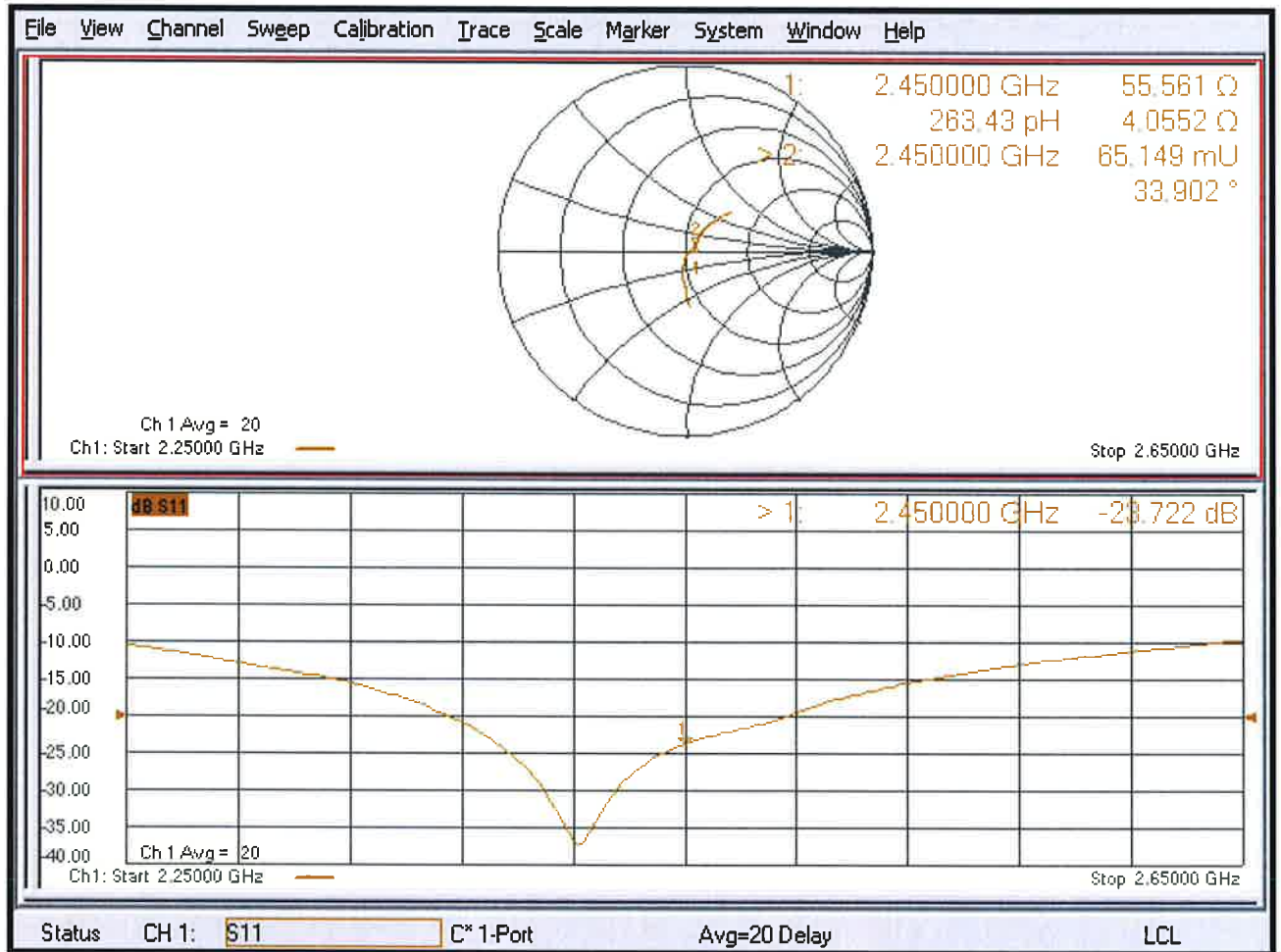

DASY5 Validation Report for Body TSL

Date: 24.08.2018

Test Laboratory: SPEAG, Zurich, Switzerland

DUT: Dipole 2450 MHz; Type: D2450V2; Serial: D2450V2 - SN:737

Communication System: UID 0 - CW; Frequency: 2450 MHz

Medium parameters used: $f = 2450$ MHz; $\sigma = 2.02$ S/m; $\epsilon_r = 51.8$; $\rho = 1000$ kg/m³

Phantom section: Flat Section

Measurement Standard: DASY5 (IEEE/IEC/ANSI C63.19-2011)

DASY52 Configuration:

- Probe: EX3DV4 - SN7349; ConvF(8.01, 8.01, 8.01) @ 2450 MHz; Calibrated: 30.12.2017
- Sensor-Surface: 1.4mm (Mechanical Surface Detection)
- Electronics: DAE4 Sn601; Calibrated: 26.10.2017
- Phantom: Flat Phantom 5.0 (back); Type: QD 000 P50 AA; Serial: 1002
- DASY52 52.10.1(1476); SEMCAD X 14.6.11(7439)

Dipole Calibration for Body Tissue/Pin=250 mW, d=10mm/Zoom Scan (7x7x7)/Cube 0:

Measurement grid: dx=5mm, dy=5mm, dz=5mm

Reference Value = 107.8 V/m; Power Drift = -0.01 dB

Peak SAR (extrapolated) = 25.5 W/kg

SAR(1 g) = 12.9 W/kg; SAR(10 g) = 6.01 W/kg

Maximum value of SAR (measured) = 20.9 W/kg



Impedance Measurement Plot for Body TSL

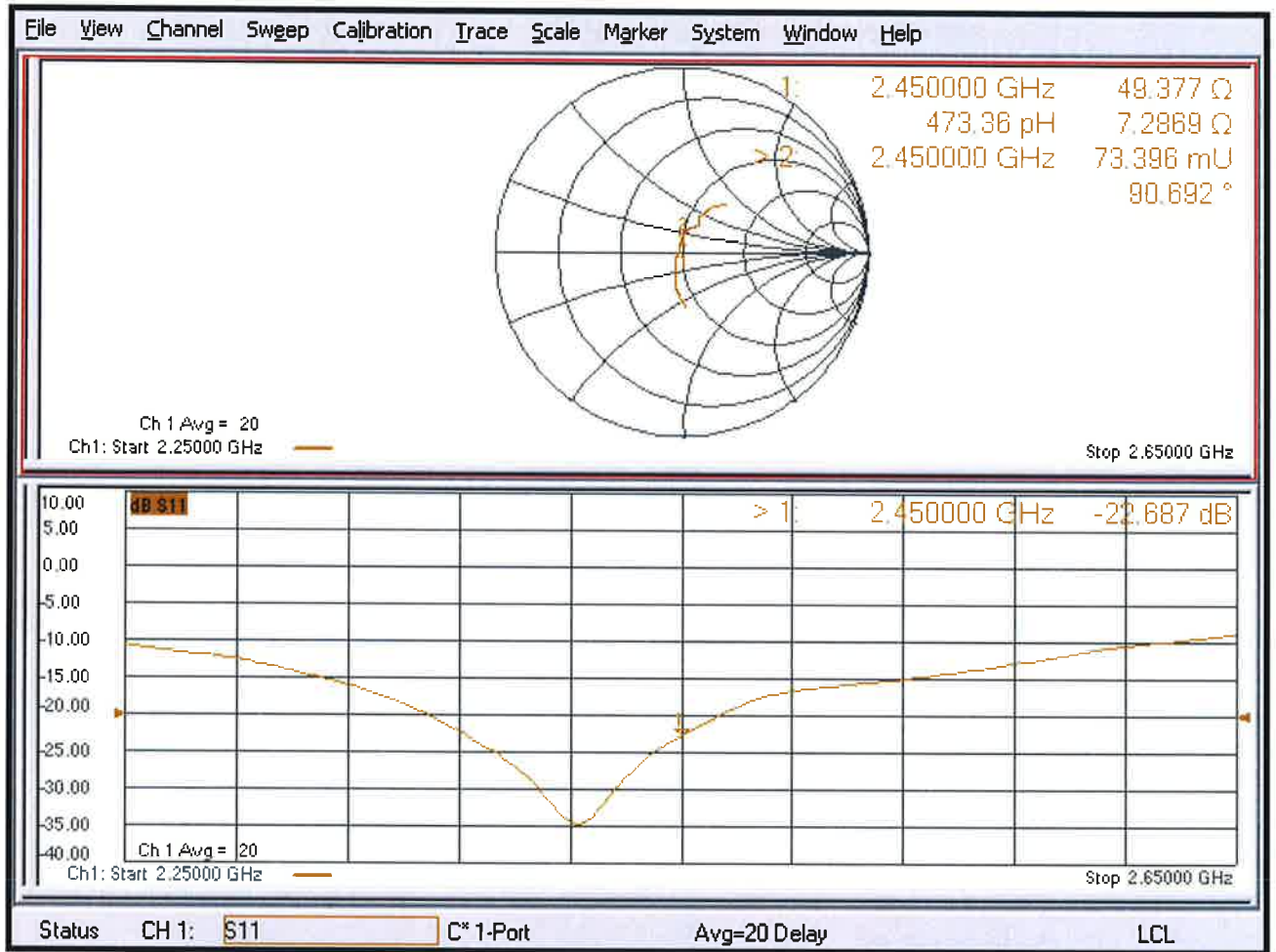



Accredited by the Swiss Accreditation Service (SAS)
The Swiss Accreditation Service is one of the signatories to the EA
Multilateral Agreement for the recognition of calibration certificates

Accreditation No.: **SCS 0108**

Client **B.V. ADT (Auden)**

Certificate No: **D5GHzV2-1019_Mar19**

CALIBRATION CERTIFICATE

Object **D5GHzV2 - SN:1019**

Calibration procedure(s) **QA CAL-22.v4
Calibration Procedure for SAR Validation Sources between 3-6 GHz**

Calibration date: **March 21, 2019**

This calibration certificate documents the traceability to national standards, which realize the physical units of measurements (SI).
The measurements and the uncertainties with confidence probability are given on the following pages and are part of the certificate.

All calibrations have been conducted in the closed laboratory facility: environment temperature (22 ± 3)°C and humidity < 70%.

Calibration Equipment used (M&TE critical for calibration)

Primary Standards	ID #	Cal Date (Certificate No.)	Scheduled Calibration
Power meter NRP	SN: 104778	04-Apr-18 (No. 217-02672/02673)	Apr-19
Power sensor NRP-Z91	SN: 103244	04-Apr-18 (No. 217-02672)	Apr-19
Power sensor NRP-Z91	SN: 103245	04-Apr-18 (No. 217-02673)	Apr-19
Reference 20 dB Attenuator	SN: 5058 (20k)	04-Apr-18 (No. 217-02682)	Apr-19
Type-N mismatch combination	SN: 5047.2 / 06327	04-Apr-18 (No. 217-02683)	Apr-19
Reference Probe EX3DV4	SN: 3503	31-Dec-18 (No. EX3-3503_Dec18)	Dec-19
DAE4	SN: 601	04-Oct-18 (No. DAE4-601_Oct18)	Oct-19
Secondary Standards	ID #	Check Date (in house)	Scheduled Check
Power meter E4419B	SN: GB41293874	06-Apr-16 (in house check Jun-18)	In house check: Jun-20
Power sensor HP 8481A	SN: US37292783	07-Oct-15 (in house check Oct-18)	In house check: Oct-20
Power sensor HP 8481A	SN: MY41092317	07-Oct-15 (in house check Oct-18)	In house check: Oct-20
RF generator R&S SMT-06	SN: 100972	15-Jun-15 (in house check Oct-18)	In house check: Oct-20
Network Analyzer Agilent E8358A	SN: US41080477	31-Mar-14 (in house check Oct-18)	In house check: Oct-19

Calibrated by: **Jeton Kastrati** Function: **Laboratory Technician** Signature:

Approved by: **Katja Pokovic** Technical Manager

Issued: March 25, 2019

This calibration certificate shall not be reproduced except in full without written approval of the laboratory.



Accredited by the Swiss Accreditation Service (SAS)

The Swiss Accreditation Service is one of the signatories to the EA Multilateral Agreement for the recognition of calibration certificates

Accreditation No.: **SCS 0108**

Glossary:

TSL	tissue simulating liquid
ConvF	sensitivity in TSL / NORM x,y,z
N/A	not applicable or not measured

Calibration is Performed According to the Following Standards:

- IEEE Std 1528-2013, "IEEE Recommended Practice for Determining the Peak Spatial-Averaged Specific Absorption Rate (SAR) in the Human Head from Wireless Communications Devices: Measurement Techniques", June 2013
- IEC 62209-1, "Measurement procedure for the assessment of Specific Absorption Rate (SAR) from hand-held and body-mounted devices used next to the ear (frequency range of 300 MHz to 6 GHz)", July 2016
- IEC 62209-2, "Procedure to determine the Specific Absorption Rate (SAR) for wireless communication devices used in close proximity to the human body (frequency range of 30 MHz to 6 GHz)", March 2010
- KDB 865664, "SAR Measurement Requirements for 100 MHz to 6 GHz"

Additional Documentation:

- DASY4/5 System Handbook

Methods Applied and Interpretation of Parameters:

- Measurement Conditions:** Further details are available from the Validation Report at the end of the certificate. All figures stated in the certificate are valid at the frequency indicated.
- Antenna Parameters with TSL:** The dipole is mounted with the spacer to position its feed point exactly below the center marking of the flat phantom section, with the arms oriented parallel to the body axis.
- Feed Point Impedance and Return Loss:** These parameters are measured with the dipole positioned under the liquid filled phantom. The impedance stated is transformed from the measurement at the SMA connector to the feed point. The Return Loss ensures low reflected power. No uncertainty required.
- Electrical Delay:** One-way delay between the SMA connector and the antenna feed point. No uncertainty required.
- SAR measured:** SAR measured at the stated antenna input power.
- SAR normalized:** SAR as measured, normalized to an input power of 1 W at the antenna connector.
- SAR for nominal TSL parameters:** The measured TSL parameters are used to calculate the nominal SAR result.

The reported uncertainty of measurement is stated as the standard uncertainty of measurement multiplied by the coverage factor $k=2$, which for a normal distribution corresponds to a coverage probability of approximately 95%.

Head TSL parameters at 5600 MHz

The following parameters and calculations were applied.

	Temperature	Permittivity	Conductivity
Nominal Head TSL parameters	22.0 °C	35.5	5.07 mho/m
Measured Head TSL parameters	(22.0 ± 0.2) °C	34.7 ± 6 %	4.85 mho/m ± 6 %
Head TSL temperature change during test	< 0.5 °C	----	----

SAR result with Head TSL at 5600 MHz

SAR averaged over 1 cm ³ (1 g) of Head TSL	Condition	
SAR measured	100 mW input power	8.64 W/kg
SAR for nominal Head TSL parameters	normalized to 1W	85.8 W/kg ± 19.9 % (k=2)

SAR averaged over 10 cm ³ (10 g) of Head TSL	condition	
SAR measured	100 mW input power	2.47 W/kg
SAR for nominal Head TSL parameters	normalized to 1W	24.5 W/kg ± 19.5 % (k=2)

Head TSL parameters at 5750 MHz

The following parameters and calculations were applied.

	Temperature	Permittivity	Conductivity
Nominal Head TSL parameters	22.0 °C	35.4	5.22 mho/m
Measured Head TSL parameters	(22.0 ± 0.2) °C	34.5 ± 6 %	5.00 mho/m ± 6 %
Head TSL temperature change during test	< 0.5 °C	----	----

SAR result with Head TSL at 5750 MHz

SAR averaged over 1 cm ³ (1 g) of Head TSL	Condition	
SAR measured	100 mW input power	8.21 W/kg
SAR for nominal Head TSL parameters	normalized to 1W	81.5 W/kg ± 19.9 % (k=2)

SAR averaged over 10 cm ³ (10 g) of Head TSL	condition	
SAR measured	100 mW input power	2.34 W/kg
SAR for nominal Head TSL parameters	normalized to 1W	23.2 W/kg ± 19.5 % (k=2)

Measurement Conditions

DASY system configuration, as far as not given on page 1.

DASY Version	DASY5	V52.10.2
Extrapolation	Advanced Extrapolation	
Phantom	Modular Flat Phantom V5.0	
Distance Dipole Center - TSL	10 mm	with Spacer
Zoom Scan Resolution	dx, dy = 4.0 mm, dz = 1.4 mm	Graded Ratio = 1.4 (Z direction)
Frequency	5250 MHz ± 1 MHz 5600 MHz ± 1 MHz 5750 MHz ± 1 MHz	

Head TSL parameters at 5250 MHz

The following parameters and calculations were applied.

	Temperature	Permittivity	Conductivity
Nominal Head TSL parameters	22.0 °C	35.9	4.71 mho/m
Measured Head TSL parameters	(22.0 ± 0.2) °C	35.2 ± 6 %	4.50 mho/m ± 6 %
Head TSL temperature change during test	< 0.5 °C	----	----

SAR result with Head TSL at 5250 MHz

SAR averaged over 1 cm³ (1 g) of Head TSL	Condition	
SAR measured	100 mW input power	8.12 W/kg
SAR for nominal Head TSL parameters	normalized to 1W	80.7 W/kg ± 19.9 % (k=2)

SAR averaged over 10 cm³ (10 g) of Head TSL	condition	
SAR measured	100 mW input power	2.34 W/kg
SAR for nominal Head TSL parameters	normalized to 1W	23.2 W/kg ± 19.5 % (k=2)

Body TSL parameters at 5250 MHz

The following parameters and calculations were applied.

	Temperature	Permittivity	Conductivity
Nominal Body TSL parameters	22.0 °C	48.9	5.36 mho/m
Measured Body TSL parameters	(22.0 ± 0.2) °C	46.8 ± 6 %	5.45 mho/m ± 6 %
Body TSL temperature change during test	< 0.5 °C	----	----

SAR result with Body TSL at 5250 MHz

SAR averaged over 1 cm ³ (1 g) of Body TSL	Condition	
SAR measured	100 mW input power	7.54 W/kg
SAR for nominal Body TSL parameters	normalized to 1W	74.8 W/kg ± 19.9 % (k=2)

SAR averaged over 10 cm ³ (10 g) of Body TSL	condition	
SAR measured	100 mW input power	2.11 W/kg
SAR for nominal Body TSL parameters	normalized to 1W	20.9 W/kg ± 19.5 % (k=2)

Body TSL parameters at 5600 MHz

The following parameters and calculations were applied.

	Temperature	Permittivity	Conductivity
Nominal Body TSL parameters	22.0 °C	48.5	5.77 mho/m
Measured Body TSL parameters	(22.0 ± 0.2) °C	46.2 ± 6 %	5.92 mho/m ± 6 %
Body TSL temperature change during test	< 0.5 °C	----	----

SAR result with Body TSL at 5600 MHz

SAR averaged over 1 cm ³ (1 g) of Body TSL	Condition	
SAR measured	100 mW input power	7.80 W/kg
SAR for nominal Body TSL parameters	normalized to 1W	77.3 W/kg ± 19.9 % (k=2)

SAR averaged over 10 cm ³ (10 g) of Body TSL	condition	
SAR measured	100 mW input power	2.18 W/kg
SAR for nominal Body TSL parameters	normalized to 1W	21.5 W/kg ± 19.5 % (k=2)

Body TSL parameters at 5750 MHz

The following parameters and calculations were applied.

	Temperature	Permittivity	Conductivity
Nominal Body TSL parameters	22.0 °C	48.3	5.94 mho/m
Measured Body TSL parameters	(22.0 ± 0.2) °C	46.0 ± 6 %	6.13 mho/m ± 6 %
Body TSL temperature change during test	< 0.5 °C	----	----

SAR result with Body TSL at 5750 MHz

SAR averaged over 1 cm ³ (1 g) of Body TSL	Condition	
SAR measured	100 mW input power	7.62 W/kg
SAR for nominal Body TSL parameters	normalized to 1W	75.5 W/kg ± 19.9 % (k=2)

SAR averaged over 10 cm ³ (10 g) of Body TSL	condition	
SAR measured	100 mW input power	2.12 W/kg
SAR for nominal Body TSL parameters	normalized to 1W	21.0 W/kg ± 19.5 % (k=2)

Appendix (Additional assessments outside the scope of SCS 0108)

Antenna Parameters with Head TSL at 5250 MHz

Impedance, transformed to feed point	52.3 Ω - 5.8 j Ω
Return Loss	- 24.3 dB

Antenna Parameters with Head TSL at 5600 MHz

Impedance, transformed to feed point	56.8 Ω - 1.1 j Ω
Return Loss	- 23.8 dB

Antenna Parameters with Head TSL at 5750 MHz

Impedance, transformed to feed point	58.3 Ω + 3.2 j Ω
Return Loss	- 21.7 dB

Antenna Parameters with Body TSL at 5250 MHz

Impedance, transformed to feed point	52.5 Ω - 3.7 j Ω
Return Loss	- 27.3 dB

Antenna Parameters with Body TSL at 5600 MHz

Impedance, transformed to feed point	58.1 Ω - 1.2 j Ω
Return Loss	- 22.4 dB

Antenna Parameters with Body TSL at 5750 MHz

Impedance, transformed to feed point	58.7 Ω + 4.8 j Ω
Return Loss	- 20.8 dB

General Antenna Parameters and Design

Electrical Delay (one direction)	1.204 ns
----------------------------------	----------

After long term use with 100W radiated power, only a slight warming of the dipole near the feedpoint can be measured.

The dipole is made of standard semirigid coaxial cable. The center conductor of the feeding line is directly connected to the second arm of the dipole. The antenna is therefore short-circuited for DC-signals. On some of the dipoles, small end caps are added to the dipole arms in order to improve matching when loaded according to the position as explained in the "Measurement Conditions" paragraph. The SAR data are not affected by this change. The overall dipole length is still according to the Standard.

No excessive force must be applied to the dipole arms, because they might bend or the soldered connections near the feedpoint may be damaged.

Additional EUT Data

Manufactured by	SPEAG
-----------------	-------

DASY5 Validation Report for Head TSL

Date: 21.03.2019

Test Laboratory: SPEAG, Zurich, Switzerland

DUT: Dipole D5GHzV2; Type: D5GHzV2; Serial: D5GHzV2 - SN:1019

Communication System: UID 0 - CW; Frequency: 5250 MHz, Frequency: 5600 MHz, Frequency: 5750 MHz

Medium parameters used: $f = 5250$ MHz; $\sigma = 4.5$ S/m; $\epsilon_r = 35.2$; $\rho = 1000$ kg/m³,

Medium parameters used: $f = 5600$ MHz; $\sigma = 4.85$ S/m; $\epsilon_r = 34.7$; $\rho = 1000$ kg/m³,

Medium parameters used: $f = 5750$ MHz; $\sigma = 5$ S/m; $\epsilon_r = 34.5$; $\rho = 1000$ kg/m³

Phantom section: Flat Section

Measurement Standard: DASY5 (IEEE/IEC/ANSI C63.19-2011)

DASY52 Configuration:

- Probe: EX3DV4 - SN3503; ConvF(5.4, 5.4, 5.4) @ 5250 MHz, ConvF(4.95, 4.95, 4.95) @ 5600 MHz, ConvF(4.98, 4.98, 4.98) @ 5750 MHz; Calibrated: 31.12.2018
- Sensor-Surface: 1.4mm (Mechanical Surface Detection)
- Electronics: DAE4 Sn601; Calibrated: 04.10.2018
- Phantom: Flat Phantom 5.0 (front); Type: QD 000 P50 AA; Serial: 1001
- DASY52 52.10.2(1495); SEMCAD X 14.6.12(7450)

Dipole Calibration for Head Tissue/Pin=100mW, dist=10mm, f=5250 MHz/Zoom Scan, dist=1.4mm (8x8x7)/Cube 0: Measurement grid: dx=4mm, dy=4mm, dz=1.4mm

Reference Value = 78.16 V/m; Power Drift = 0.09 dB

Peak SAR (extrapolated) = 28.1 W/kg

SAR(1 g) = 8.12 W/kg; SAR(10 g) = 2.34 W/kg

Maximum value of SAR (measured) = 18.1 W/kg

Dipole Calibration for Head Tissue/Pin=100mW, dist=10mm, f=5600 MHz/Zoom Scan, dist=1.4mm (8x8x7)/Cube 0: Measurement grid: dx=4mm, dy=4mm, dz=1.4mm

Reference Value = 77.63 V/m; Power Drift = 0.06 dB

Peak SAR (extrapolated) = 32.2 W/kg

SAR(1 g) = 8.64 W/kg; SAR(10 g) = 2.47 W/kg

Maximum value of SAR (measured) = 19.7 W/kg

Dipole Calibration for Head Tissue/Pin=100mW, dist=10mm, f=5750 MHz/Zoom Scan, dist=1.4mm (8x8x7)/Cube 0: Measurement grid: dx=4mm, dy=4mm, dz=1.4mm

Reference Value = 74.85 V/m; Power Drift = 0.07 dB

Peak SAR (extrapolated) = 32.4 W/kg

SAR(1 g) = 8.21 W/kg; SAR(10 g) = 2.34 W/kg

Maximum value of SAR (measured) = 19.1 W/kg

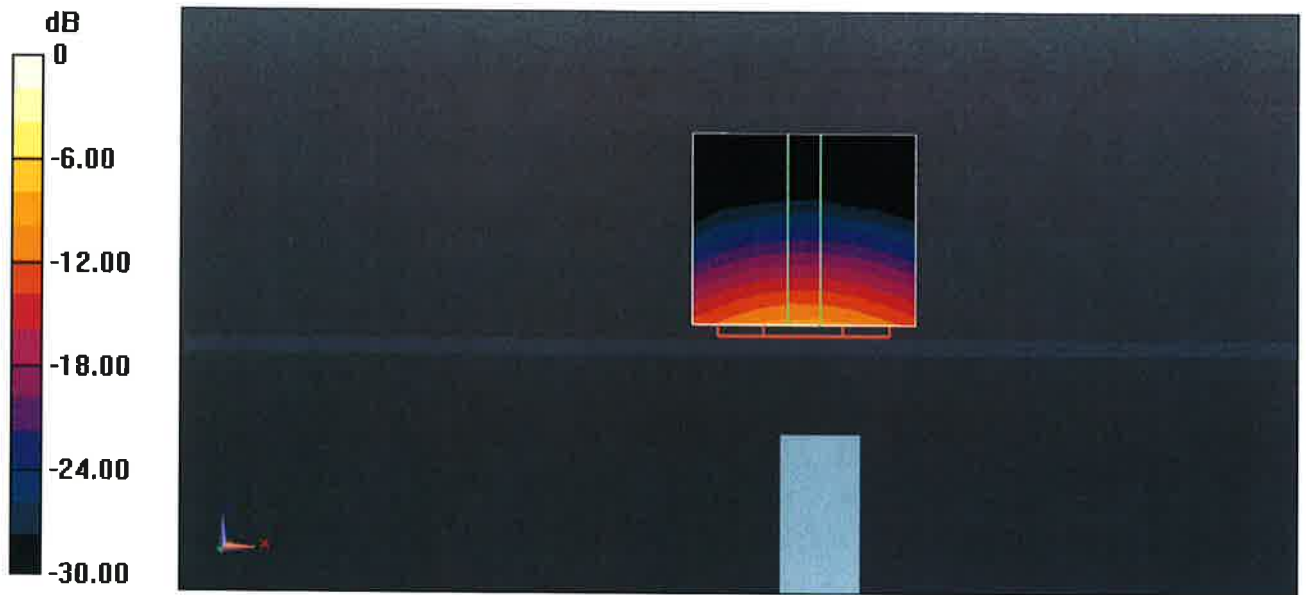

0 dB = 19.1 W/kg = 12.81 dBW/kg

Impedance Measurement Plot for Head TSL

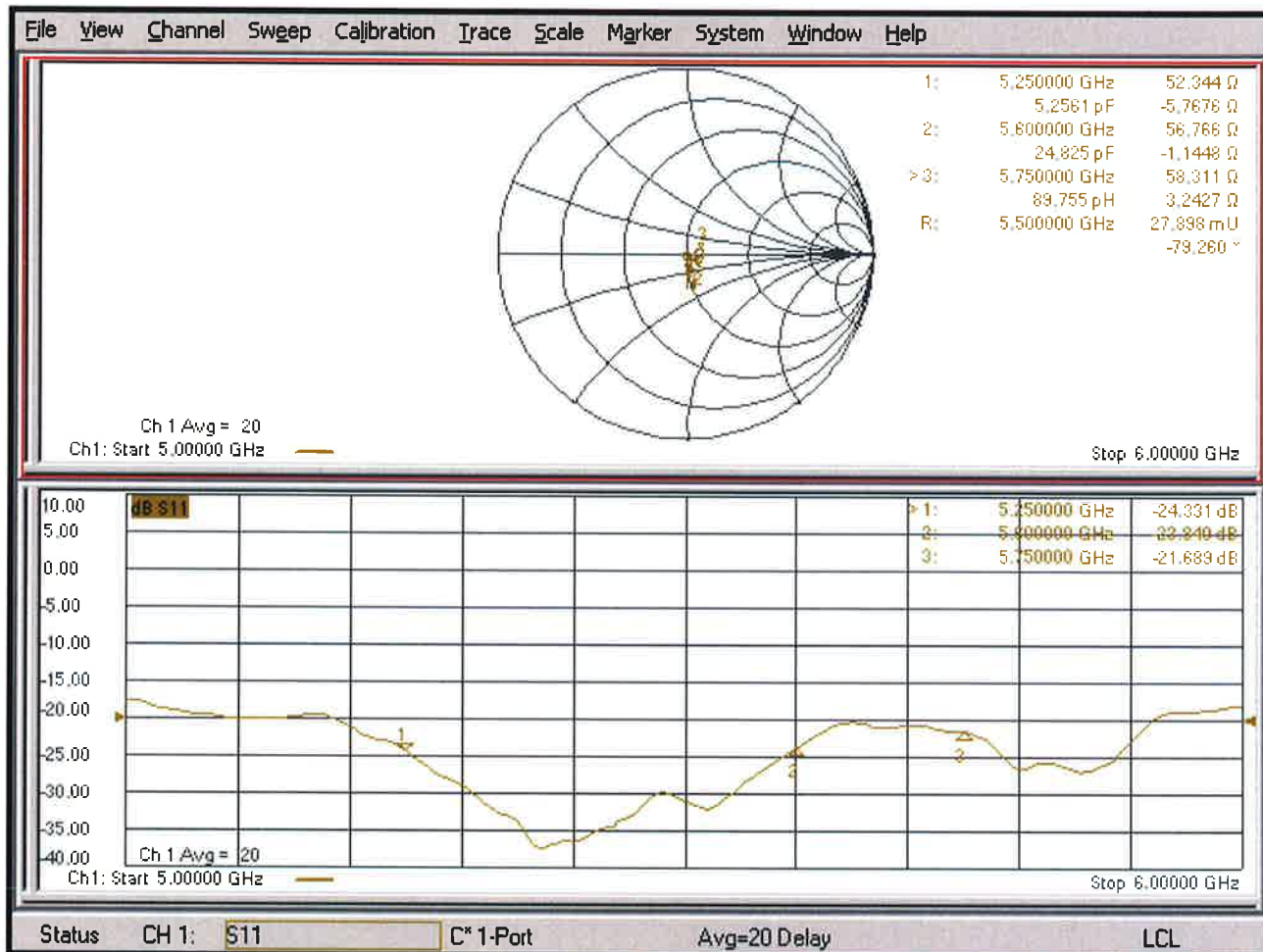

DASY5 Validation Report for Body TSL

Date: 20.03.2019

Test Laboratory: SPEAG, Zurich, Switzerland

DUT: Dipole D5GHzV2; Type: D5GHzV2; Serial: D5GHzV2 - SN:1019

Communication System: UID 0 - CW; Frequency: 5250 MHz, Frequency: 5600 MHz, Frequency: 5750 MHz

Medium parameters used: $f = 5250$ MHz; $\sigma = 5.45$ S/m; $\epsilon_r = 46.8$; $\rho = 1000$ kg/m³,

Medium parameters used: $f = 5600$ MHz; $\sigma = 5.92$ S/m; $\epsilon_r = 46.2$; $\rho = 1000$ kg/m³,

Medium parameters used: $f = 5750$ MHz; $\sigma = 6.13$ S/m; $\epsilon_r = 46$; $\rho = 1000$ kg/m³

Phantom section: Flat Section

Measurement Standard: DASY5 (IEEE/IEC/ANSI C63.19-2011)

DASY52 Configuration:

- Probe: EX3DV4 - SN3503testing; ConvF(5.26, 5.26, 5.26) @ 5250 MHz, ConvF(4.7, 4.7, 4.7) @ 5600 MHz, ConvF(4.59, 4.59, 4.59) @ 5750 MHz; Calibrated: 31.12.2018
- Sensor-Surface: 1.4mm (Mechanical Surface Detection)
- Electronics: DAE4 Sn601; Calibrated: 04.10.2018
- Phantom: Flat Phantom 5.0 (back); Type: QD 000 P50 AA; Serial: 1002
- DASY52 52.10.2(1495); SEMCAD X 14.6.12(7450)

Dipole Calibration for Body Tissue/Pin=100mW, dist=10mm, f=5250 MHz/Zoom Scan,

dist=1.4mm (8x8x7)/Cube 0: Measurement grid: dx=4mm, dy=4mm, dz=1.4mm

Reference Value = 69.09 V/m; Power Drift = -0.05 dB

Peak SAR (extrapolated) = 29.2 W/kg

SAR(1 g) = 7.54 W/kg; SAR(10 g) = 2.11 W/kg

Maximum value of SAR (measured) = 17.2 W/kg

Dipole Calibration for Body Tissue/Pin=100mW, dist=10mm, f=5600 MHz/Zoom Scan,

dist=1.4mm (8x8x7)/Cube 0: Measurement grid: dx=4mm, dy=4mm, dz=1.4mm

Reference Value = 68.10 V/m; Power Drift = -0.00 dB

Peak SAR (extrapolated) = 33.4 W/kg

SAR(1 g) = 7.8 W/kg; SAR(10 g) = 2.18 W/kg

Maximum value of SAR (measured) = 18.5 W/kg

Dipole Calibration for Body Tissue/Pin=100mW, dist=10mm, f=5750 MHz/Zoom Scan,

dist=1.4mm (8x8x7)/Cube 0: Measurement grid: dx=4mm, dy=4mm, dz=1.4mm

Reference Value = 66.59 V/m; Power Drift = 0.03 dB

Peak SAR (extrapolated) = 34.1 W/kg

SAR(1 g) = 7.62 W/kg; SAR(10 g) = 2.12 W/kg

Maximum value of SAR (measured) = 18.3 W/kg

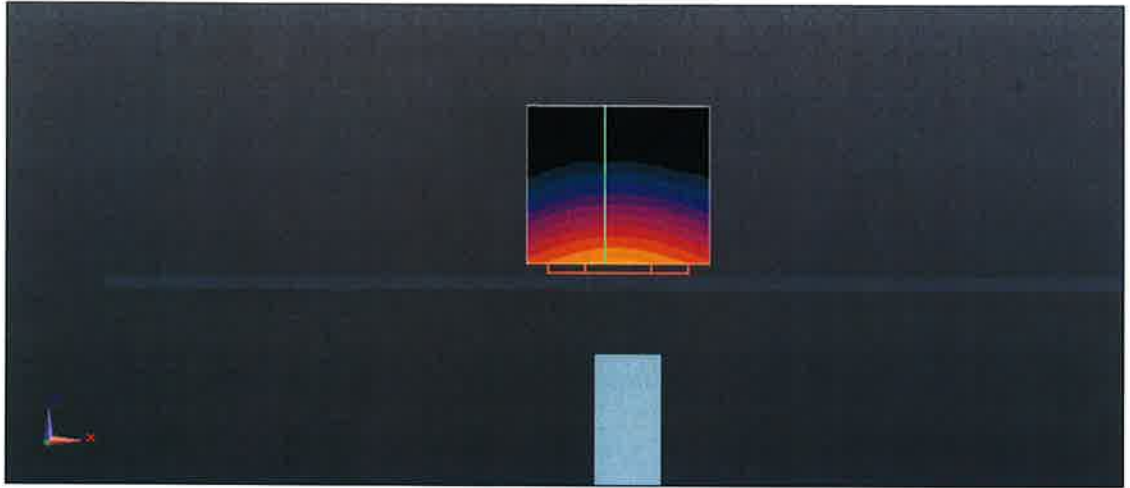
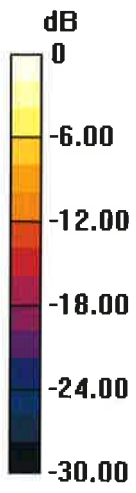

0 dB = 17.2 W/kg = 12.36 dBW/kg

Impedance Measurement Plot for Body TSL

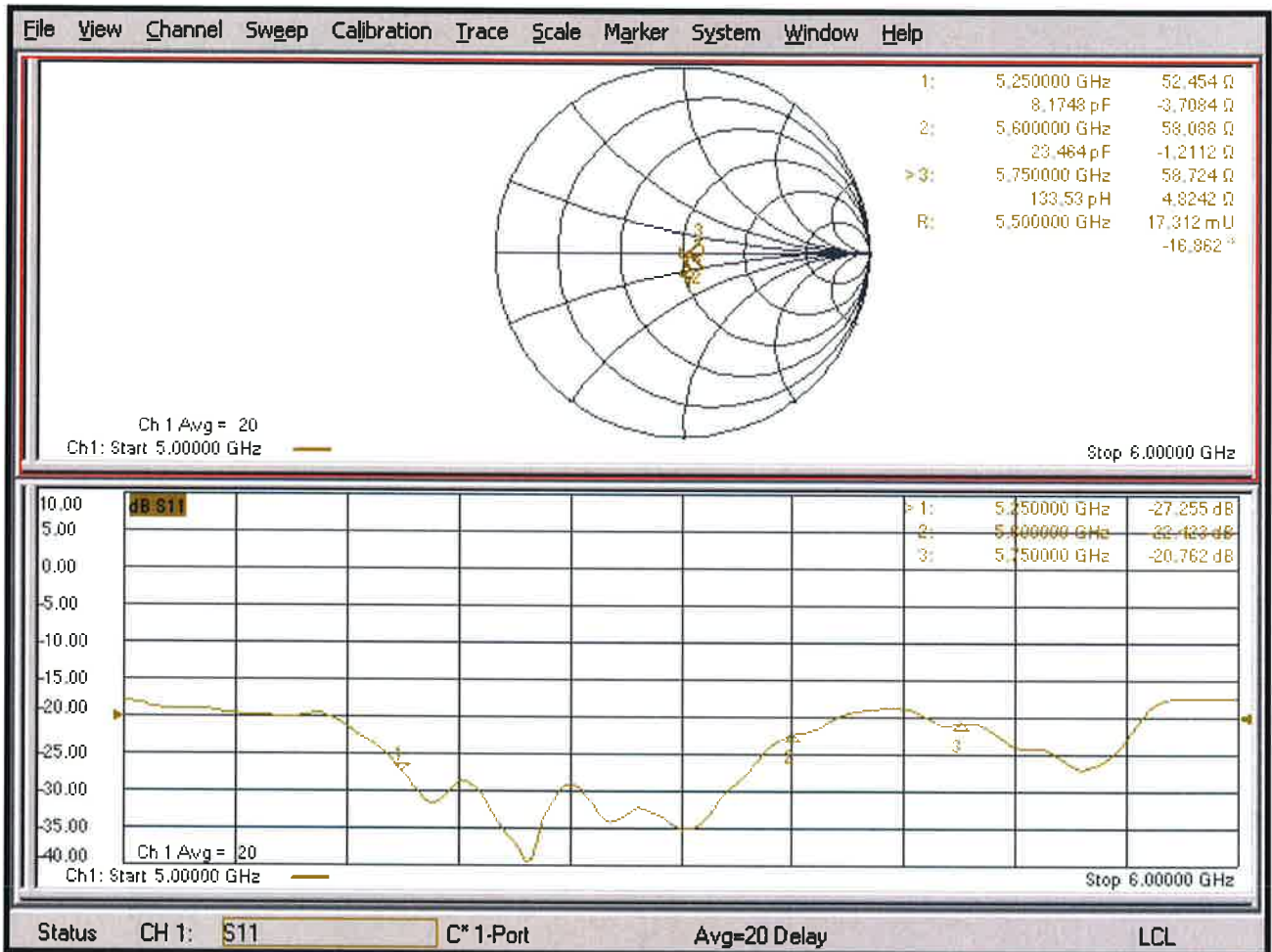



Accredited by the Swiss Accreditation Service (SAS)
The Swiss Accreditation Service is one of the signatories to the EA
Multilateral Agreement for the recognition of calibration certificates

Accreditation No.: **SCS 0108**

Client **BV ADT (Auden)**

Certificate No: **EX3-3650_May19**

CALIBRATION CERTIFICATE

Object **EX3DV4 - SN:3650**

Calibration procedure(s) **QA CAL-01.v9, QA CAL-14.v5, QA CAL-23.v5, QA CAL-25.v7
Calibration procedure for dosimetric E-field probes**

Calibration date: **May 20, 2019**

This calibration certificate documents the traceability to national standards, which realize the physical units of measurements (SI).
The measurements and the uncertainties with confidence probability are given on the following pages and are part of the certificate.

All calibrations have been conducted in the closed laboratory facility: environment temperature (22 ± 3)°C and humidity < 70%.

Calibration Equipment used (M&TE critical for calibration)

Primary Standards	ID	Cal Date (Certificate No.)	Scheduled Calibration
Power meter NRP	SN: 104778	03-Apr-19 (No. 217-02892/02893)	Apr-20
Power sensor NRP-Z91	SN: 103244	03-Apr-19 (No. 217-02892)	Apr-20
Power sensor NRP-Z91	SN: 103245	03-Apr-19 (No. 217-02893)	Apr-20
Reference 20 dB Attenuator	SN: S5277 (20x)	04-Apr-19 (No. 217-02894)	Apr-20
DAE4	SN: 660	19-Dec-18 (No. DAE4-660_Dec18)	Dec-19
Reference Probe ES3DV2	SN: 3013	31-Dec-18 (No. ES3-3013_Dec18)	Dec-19
Secondary Standards	ID	Check Date (in house)	Scheduled Check
Power meter E4419B	SN: GB41293874	06-Apr-16 (in house check Jun-18)	In house check: Jun-20
Power sensor E4412A	SN: MY41498087	06-Apr-16 (in house check Jun-18)	In house check: Jun-20
Power sensor E4412A	SN: 000110210	06-Apr-16 (in house check Jun-18)	In house check: Jun-20
RF generator HP 8648C	SN: US3642U01700	04-Aug-99 (in house check Jun-18)	In house check: Jun-20
Network Analyzer E8358A	SN: US41080477	31-Mar-14 (in house check Oct-18)	In house check: Oct-19

	Name	Function	Signature
Calibrated by:	Jeton Kastrati	Laboratory Technician	
Approved by:	Katja Pokovic	Technical Manager	
			Issued: May 20, 2019

This calibration certificate shall not be reproduced except in full without written approval of the laboratory.



Accredited by the Swiss Accreditation Service (SAS)

Accreditation No.: **SCS 0108**

The Swiss Accreditation Service is one of the signatories to the EA
Multilateral Agreement for the recognition of calibration certificates

Glossary:

TSL	tissue simulating liquid
NORM _{x,y,z}	sensitivity in free space
ConvF	sensitivity in TSL / NORM _{x,y,z}
DCP	diode compression point
CF	crest factor (1/duty_cycle) of the RF signal
A, B, C, D	modulation dependent linearization parameters
Polarization φ	φ rotation around probe axis
Polarization ϑ	ϑ rotation around an axis that is in the plane normal to probe axis (at measurement center), i.e., $\vartheta = 0$ is normal to probe axis
Connector Angle	information used in DASY system to align probe sensor X to the robot coordinate system

Calibration is Performed According to the Following Standards:

- a) IEEE Std 1528-2013, "IEEE Recommended Practice for Determining the Peak Spatial-Averaged Specific Absorption Rate (SAR) in the Human Head from Wireless Communications Devices: Measurement Techniques", June 2013
- b) IEC 62209-1, "Measurement procedure for the assessment of Specific Absorption Rate (SAR) from hand-held and body-mounted devices used next to the ear (frequency range of 300 MHz to 6 GHz)", July 2016
- c) IEC 62209-2, "Procedure to determine the Specific Absorption Rate (SAR) for wireless communication devices used in close proximity to the human body (frequency range of 30 MHz to 6 GHz)", March 2010
- d) KDB 865664, "SAR Measurement Requirements for 100 MHz to 6 GHz"

Methods Applied and Interpretation of Parameters:

- *NORM_{x,y,z}*: Assessed for E-field polarization $\vartheta = 0$ ($f \leq 900$ MHz in TEM-cell; $f > 1800$ MHz: R22 waveguide). *NORM_{x,y,z}* are only intermediate values, i.e., the uncertainties of *NORM_{x,y,z}* does not affect the E^2 -field uncertainty inside TSL (see below *ConvF*).
- *NORM(f)_{x,y,z} = NORM_{x,y,z} * frequency_response* (see Frequency Response Chart). This linearization is implemented in DASY4 software versions later than 4.2. The uncertainty of the frequency response is included in the stated uncertainty of *ConvF*.
- *DCP_{x,y,z}*: DCP are numerical linearization parameters assessed based on the data of power sweep with CW signal (no uncertainty required). DCP does not depend on frequency nor media.
- *PAR*: PAR is the Peak to Average Ratio that is not calibrated but determined based on the signal characteristics
- *A_{x,y,z}; B_{x,y,z}; C_{x,y,z}; D_{x,y,z}; VR_{x,y,z}; A, B, C, D* are numerical linearization parameters assessed based on the data of power sweep for specific modulation signal. The parameters do not depend on frequency nor media. VR is the maximum calibration range expressed in RMS voltage across the diode.
- *ConvF and Boundary Effect Parameters*: Assessed in flat phantom using E-field (or Temperature Transfer Standard for $f \leq 800$ MHz) and inside waveguide using analytical field distributions based on power measurements for $f > 800$ MHz. The same setups are used for assessment of the parameters applied for boundary compensation (alpha, depth) of which typical uncertainty values are given. These parameters are used in DASY4 software to improve probe accuracy close to the boundary. The sensitivity in TSL corresponds to *NORM_{x,y,z} * ConvF* whereby the uncertainty corresponds to that given for *ConvF*. A frequency dependent *ConvF* is used in DASY version 4.4 and higher which allows extending the validity from ± 50 MHz to ± 100 MHz.
- *Spherical isotropy (3D deviation from isotropy)*: in a field of low gradients realized using a flat phantom exposed by a patch antenna.
- *Sensor Offset*: The sensor offset corresponds to the offset of virtual measurement center from the probe tip (on probe axis). No tolerance required.
- *Connector Angle*: The angle is assessed using the information gained by determining the *NORM_x* (no uncertainty required).

DASY/EASY - Parameters of Probe: EX3DV4 - SN:3650

Basic Calibration Parameters

	Sensor X	Sensor Y	Sensor Z	Unc (k=2)
Norm ($\mu\text{V}/(\text{V}/\text{m})^2$) ^A	0.40	0.40	0.41	± 10.1 %
DCP (mV) ^B	105.4	99.2	105.9	

Calibration Results for Modulation Response

UID	Communication System Name		A dB	B dB $\sqrt{\mu\text{V}}$	C	D dB	VR mV	Max dev.	Max Unc ^E (k=2)
0	CW	X	0.00	0.00	1.00	0.00	169.3	± 3.3 %	± 4.7 %
		Y	0.00	0.00	1.00		155.5		
		Z	0.00	0.00	1.00		169.9		
10352-AAA	Pulse Waveform (200Hz, 10%)	X	5.52	73.99	14.03	10.00	60.0	± 2.9 %	± 9.6 %
		Y	12.59	82.85	17.90		60.0		
		Z	15.00	88.44	20.60		60.0		
10353-AAA	Pulse Waveform (200Hz, 20%)	X	15.00	85.13	16.40	6.99	80.0	± 2.1 %	± 9.6 %
		Y	15.00	85.80	17.44		80.0		
		Z	15.00	89.95	20.10		80.0		
10354-AAA	Pulse Waveform (200Hz, 40%)	X	15.00	90.82	17.69	3.98	95.0	± 1.2 %	± 9.6 %
		Y	15.00	84.35	14.90		95.0		
		Z	15.00	96.80	22.00		95.0		
10355-AAA	Pulse Waveform (200Hz, 60%)	X	15.00	125.07	31.80	2.22	120.0	± 1.3 %	± 9.6 %
		Y	0.40	60.68	5.28		120.0		
		Z	15.00	108.39	25.98		120.0		
10387-AAA	QPSK Waveform, 1 MHz	X	0.40	60.00	5.50	0.00	150.0	± 3.1 %	± 9.6 %
		Y	0.62	60.97	8.03		150.0		
		Z	1.18	68.04	13.15		150.0		
10388-AAA	QPSK Waveform, 10 MHz	X	2.67	73.57	18.93	0.00	150.0	± 1.0 %	± 9.6 %
		Y	2.27	68.77	16.00		150.0		
		Z	2.67	71.48	17.65		150.0		
10396-AAA	64-QAM Waveform, 100 kHz	X	2.53	70.36	19.21	3.01	150.0	± 0.9 %	± 9.6 %
		Y	3.20	71.37	19.39		150.0		
		Z	3.76	74.72	20.75		150.0		
10399-AAA	64-QAM Waveform, 40 MHz	X	3.60	68.84	16.97	0.00	150.0	± 2.3 %	± 9.6 %
		Y	3.55	67.48	16.02		150.0		
		Z	3.72	68.39	16.62		150.0		
10414-AAA	WLAN CCDF, 64-QAM, 40MHz	X	4.71	66.59	16.23	0.00	150.0	± 4.3 %	± 9.6 %
		Y	4.96	65.99	15.86		150.0		
		Z	5.01	66.21	15.98		150.0		

Note: For details on UID parameters see Appendix

The reported uncertainty of measurement is stated as the standard uncertainty of measurement multiplied by the coverage factor k=2, which for a normal distribution corresponds to a coverage probability of approximately 95%.

^A The uncertainties of Norm X,Y,Z do not affect the E²-field uncertainty inside TSL (see Page 5).

^B Numerical linearization parameter: uncertainty not required.

^E Uncertainty is determined using the max. deviation from linear response applying rectangular distribution and is expressed for the square of the field value.

DASY/EASY - Parameters of Probe: EX3DV4 - SN:3650

Sensor Model Parameters

	C1 fF	C2 fF	α V ⁻¹	T1 ms.V ⁻²	T2 ms.V ⁻¹	T3 ms	T4 V ⁻²	T5 V ⁻¹	T6
X	28.0	203.57	34.24	7.40	0.27	5.01	0.72	0.18	1.00
Y	47.3	370.03	38.58	9.66	0.85	5.06	0.00	0.62	1.01
Z	49.8	370.45	35.51	13.89	0.57	5.06	1.46	0.32	1.01

Other Probe Parameters

Sensor Arrangement	Triangular
Connector Angle (°)	-21.6
Mechanical Surface Detection Mode	enabled
Optical Surface Detection Mode	disabled
Probe Overall Length	337 mm
Probe Body Diameter	10 mm
Tip Length	9 mm
Tip Diameter	2.5 mm
Probe Tip to Sensor X Calibration Point	1 mm
Probe Tip to Sensor Y Calibration Point	1 mm
Probe Tip to Sensor Z Calibration Point	1 mm
Recommended Measurement Distance from Surface	1.4 mm

DASY/EASY - Parameters of Probe: EX3DV4 - SN:3650

Calibration Parameter Determined in Head Tissue Simulating Media

f (MHz) ^C	Relative Permittivity ^F	Conductivity (S/m) ^F	ConvF X	ConvF Y	ConvF Z	Alpha ^G	Depth ^G (mm)	Unc (k=2)
750	41.9	0.89	10.06	10.06	10.06	0.48	0.87	± 12.0 %
835	41.5	0.90	9.82	9.82	9.82	0.55	0.80	± 12.0 %
900	41.5	0.97	9.61	9.61	9.61	0.49	0.85	± 12.0 %
1450	40.5	1.20	8.91	8.91	8.91	0.41	0.80	± 12.0 %
1750	40.1	1.37	8.44	8.44	8.44	0.38	0.85	± 12.0 %
1900	40.0	1.40	8.25	8.25	8.25	0.33	0.85	± 12.0 %
2000	40.0	1.40	8.17	8.17	8.17	0.38	0.84	± 12.0 %
2300	39.5	1.67	8.00	8.00	8.00	0.30	0.84	± 12.0 %
2450	39.2	1.80	7.63	7.63	7.63	0.38	0.87	± 12.0 %
2600	39.0	1.96	7.50	7.50	7.50	0.44	0.86	± 12.0 %
3300	38.2	2.71	7.16	7.16	7.16	0.32	1.20	± 13.1 %
3500	37.9	2.91	6.93	6.93	6.93	0.30	1.25	± 13.1 %
3700	37.7	3.12	6.71	6.71	6.71	0.35	1.25	± 13.1 %
3900	37.5	3.32	6.50	6.50	6.50	0.30	1.60	± 13.1 %
4100	37.2	3.53	6.30	6.30	6.30	0.40	1.60	± 13.1 %
4200	37.1	3.63	6.16	6.16	6.16	0.40	1.60	± 13.1 %
4400	36.9	3.84	6.13	6.13	6.13	0.40	1.70	± 13.1 %
4600	36.7	4.04	6.11	6.11	6.11	0.45	1.80	± 13.1 %
4800	36.4	4.25	6.08	6.08	6.08	0.45	1.80	± 13.1 %
4950	36.3	4.40	5.79	5.79	5.79	0.45	1.80	± 13.1 %
5250	35.9	4.71	5.40	5.40	5.40	0.40	1.80	± 13.1 %
5600	35.5	5.07	4.90	4.90	4.90	0.40	1.80	± 13.1 %
5750	35.4	5.22	5.17	5.17	5.17	0.40	1.80	± 13.1 %

^C Frequency validity above 300 MHz of ± 100 MHz only applies for DASY v4.4 and higher (see Page 2), else it is restricted to ± 50 MHz. The uncertainty is the RSS of the ConvF uncertainty at calibration frequency and the uncertainty for the indicated frequency band. Frequency validity below 300 MHz is ± 10, 25, 40, 50 and 70 MHz for ConvF assessments at 30, 64, 128, 150 and 220 MHz respectively. Validity of ConvF assessed at 6 MHz is 4-9 MHz, and ConvF assessed at 13 MHz is 9-19 MHz. Above 5 GHz frequency validity can be extended to ± 110 MHz.

^F At frequencies below 3 GHz, the validity of tissue parameters (ϵ and σ) can be relaxed to ± 10% if liquid compensation formula is applied to measured SAR values. At frequencies above 3 GHz, the validity of tissue parameters (ϵ and σ) is restricted to ± 5%. The uncertainty is the RSS of the ConvF uncertainty for indicated target tissue parameters.

^G Alpha/Depth are determined during calibration. SPEAG warrants that the remaining deviation due to the boundary effect after compensation is always less than ± 1% for frequencies below 3 GHz and below ± 2% for frequencies between 3-6 GHz at any distance larger than half the probe tip diameter from the boundary.

Frequency Response of E-Field (TEM-Cell:ifi110 EXX, Waveguide: R22)

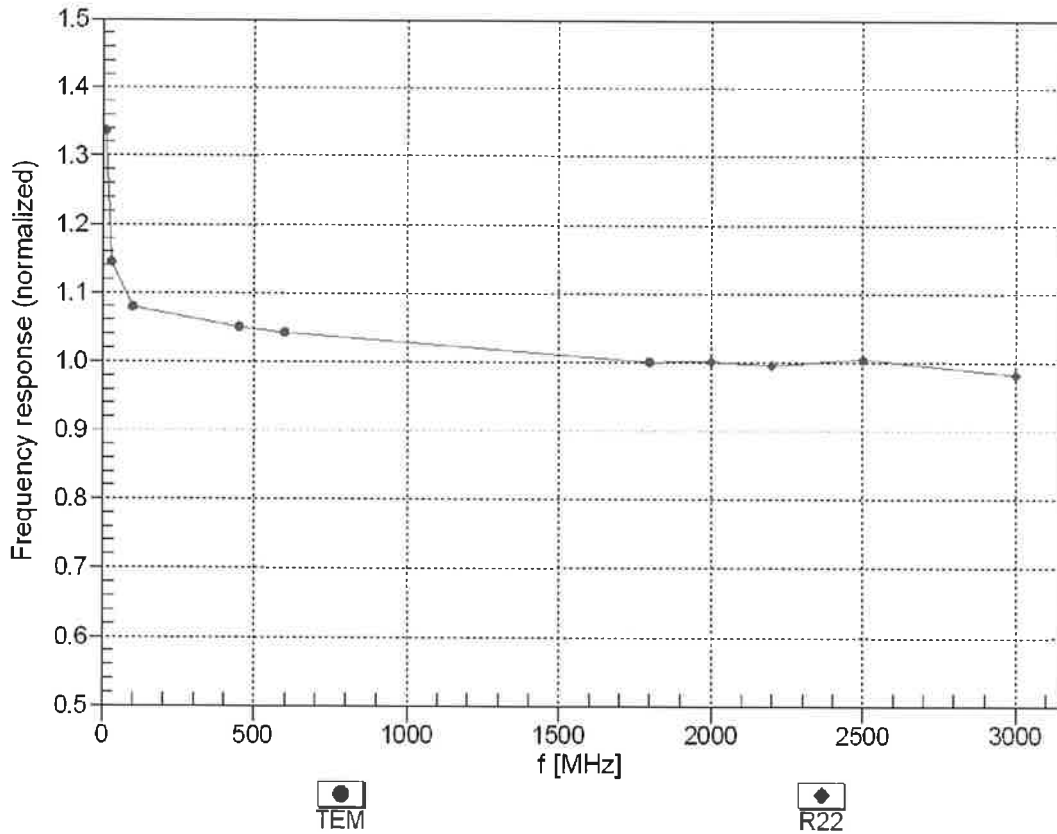

Uncertainty of Frequency Response of E-field: $\pm 6.3\%$ (k=2)

Receiving Pattern (ϕ), $\theta = 0^\circ$

f=600 MHz,TEM

f=1800 MHz,R22

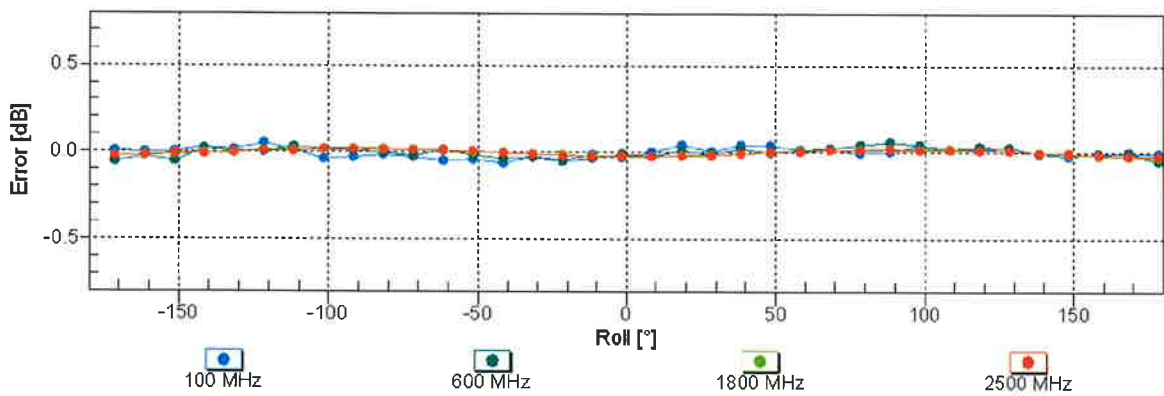
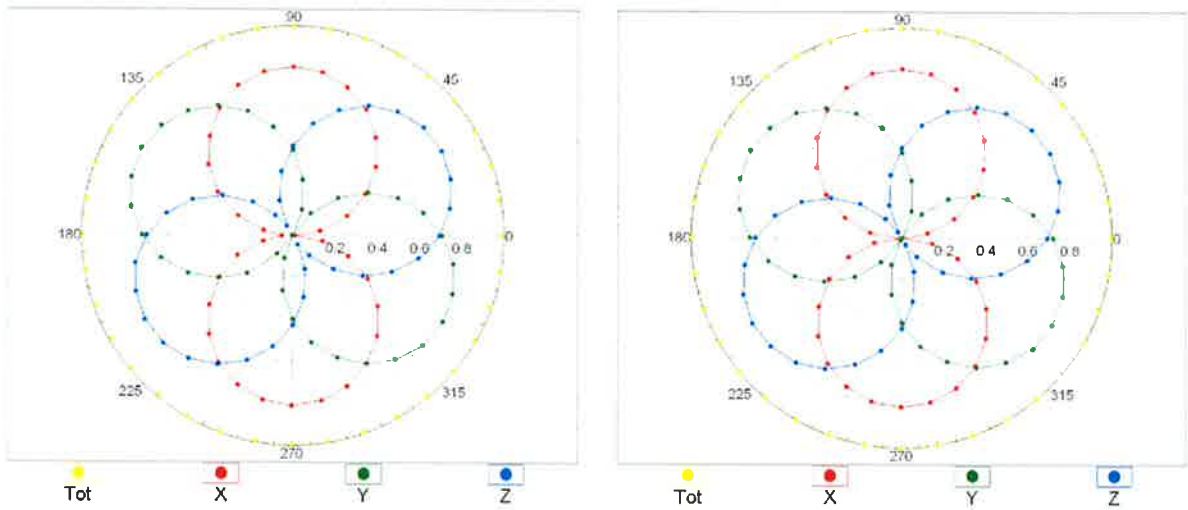

Uncertainty of Axial Isotropy Assessment: $\pm 0.5\%$ (k=2)

Dynamic Range f(SAR_{head}) (TEM cell , f_{eval}= 1900 MHz)

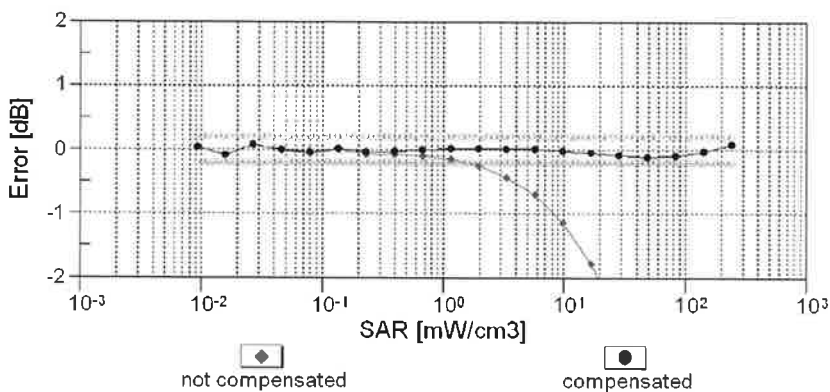
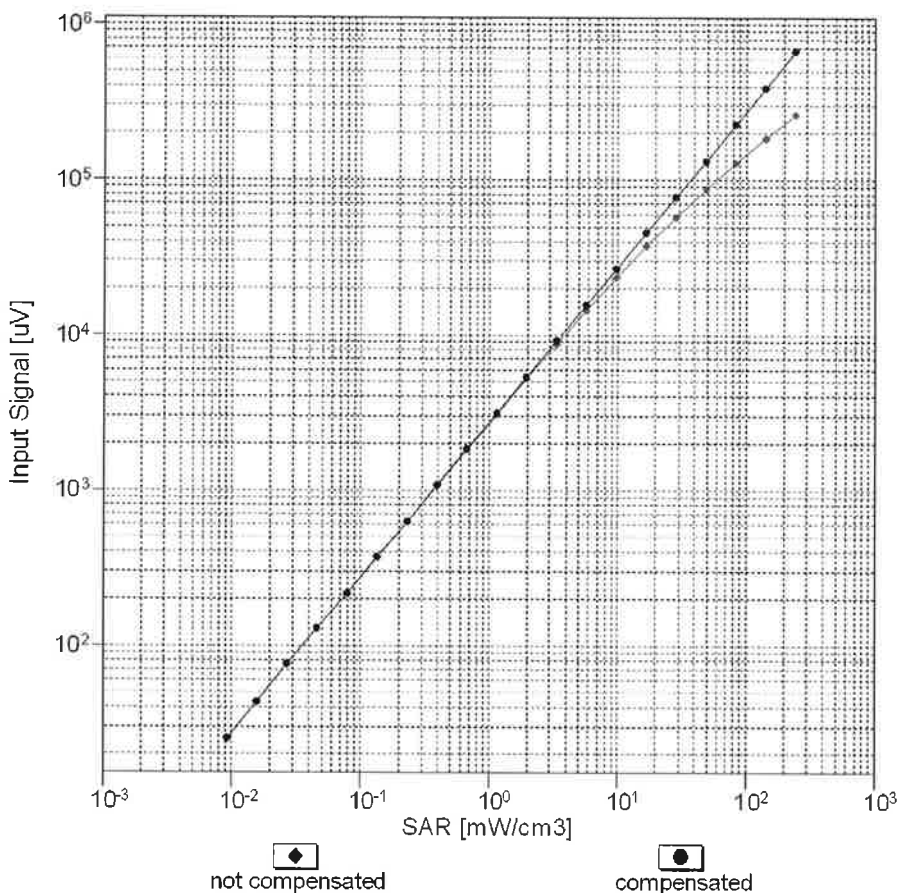

Uncertainty of Linearity Assessment: ± 0.6% (k=2)

Conversion Factor Assessment

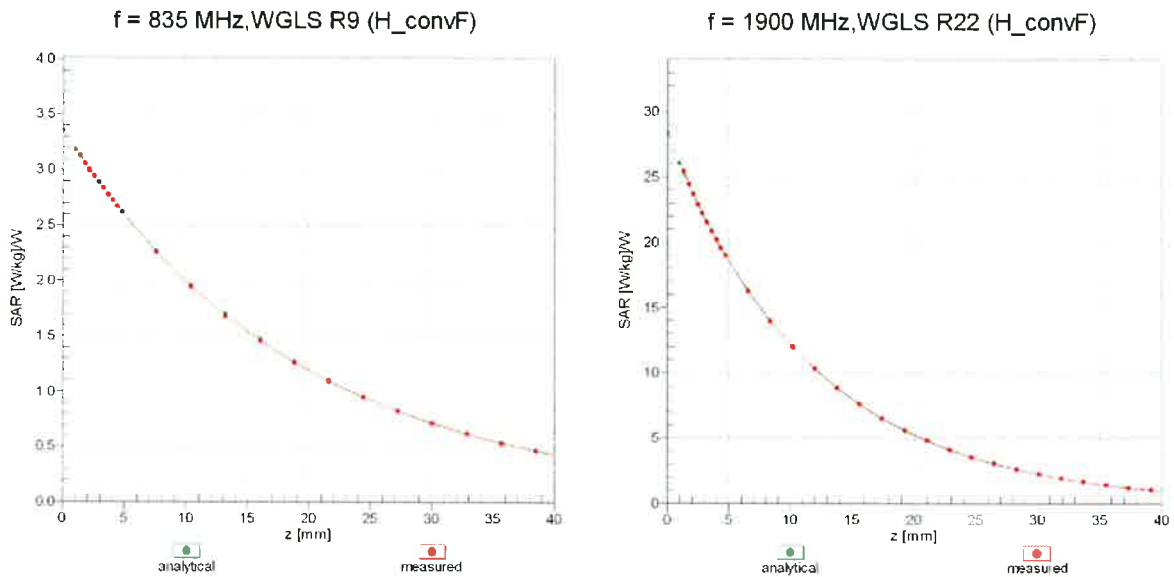

Deviation from Isotropy in Liquid

Error (ϕ, ϑ), f = 900 MHz

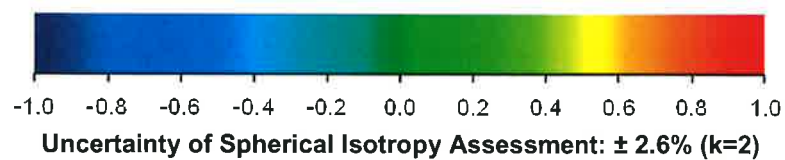
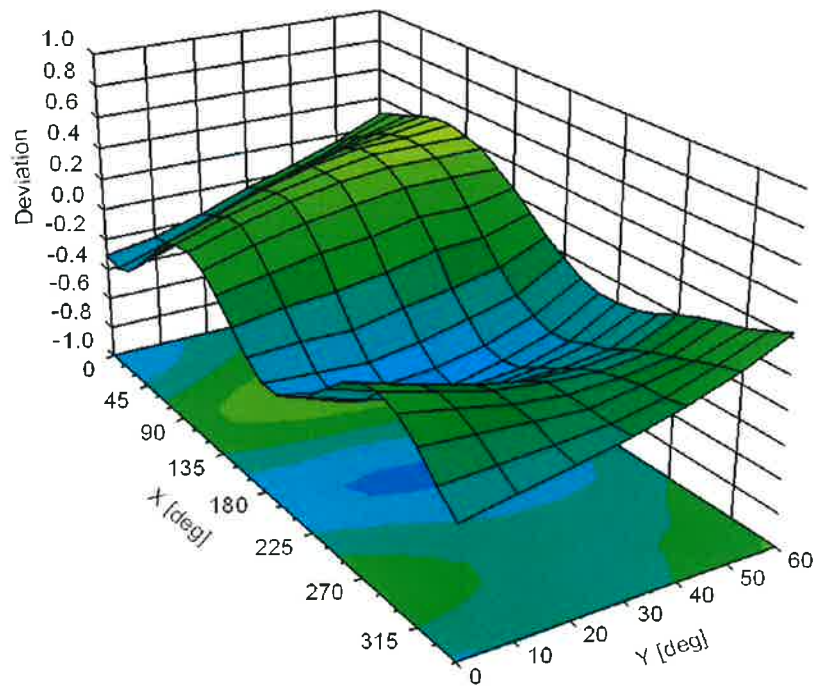

Appendix: Modulation Calibration Parameters

UID	Rev	Communication System Name	Group	PAR (dB)	Unc ^E (k=2)
0		CW	CW	0.00	± 4.7 %
10010	CAA	SAR Validation (Square, 100ms, 10ms)	Test	10.00	± 9.6 %
10011	CAB	UMTS-FDD (WCDMA)	WCDMA	2.91	± 9.6 %
10012	CAB	IEEE 802.11b WiFi 2.4 GHz (DSSS, 1 Mbps)	WLAN	1.87	± 9.6 %
10013	CAB	IEEE 802.11g WiFi 2.4 GHz (DSSS-OFDM, 6 Mbps)	WLAN	9.46	± 9.6 %
10021	DAC	GSM-FDD (TDMA, GMSK)	GSM	9.39	± 9.6 %
10023	DAC	GPRS-FDD (TDMA, GMSK, TN 0)	GSM	9.57	± 9.6 %
10024	DAC	GPRS-FDD (TDMA, GMSK, TN 0-1)	GSM	6.56	± 9.6 %
10025	DAC	EDGE-FDD (TDMA, 8PSK, TN 0)	GSM	12.62	± 9.6 %
10026	DAC	EDGE-FDD (TDMA, 8PSK, TN 0-1)	GSM	9.55	± 9.6 %
10027	DAC	GPRS-FDD (TDMA, GMSK, TN 0-1-2)	GSM	4.80	± 9.6 %
10028	DAC	GPRS-FDD (TDMA, GMSK, TN 0-1-2-3)	GSM	3.55	± 9.6 %
10029	DAC	EDGE-FDD (TDMA, 8PSK, TN 0-1-2)	GSM	7.78	± 9.6 %
10030	CAA	IEEE 802.15.1 Bluetooth (GFSK, DH1)	Bluetooth	5.30	± 9.6 %
10031	CAA	IEEE 802.15.1 Bluetooth (GFSK, DH3)	Bluetooth	1.87	± 9.6 %
10032	CAA	IEEE 802.15.1 Bluetooth (GFSK, DH5)	Bluetooth	1.16	± 9.6 %
10033	CAA	IEEE 802.15.1 Bluetooth (PI/4-DQPSK, DH1)	Bluetooth	7.74	± 9.6 %
10034	CAA	IEEE 802.15.1 Bluetooth (PI/4-DQPSK, DH3)	Bluetooth	4.53	± 9.6 %
10035	CAA	IEEE 802.15.1 Bluetooth (PI/4-DQPSK, DH5)	Bluetooth	3.83	± 9.6 %
10036	CAA	IEEE 802.15.1 Bluetooth (8-DPSK, DH1)	Bluetooth	8.01	± 9.6 %
10037	CAA	IEEE 802.15.1 Bluetooth (8-DPSK, DH3)	Bluetooth	4.77	± 9.6 %
10038	CAA	IEEE 802.15.1 Bluetooth (8-DPSK, DH5)	Bluetooth	4.10	± 9.6 %
10039	CAB	CDMA2000 (1xRTT, RC1)	CDMA2000	4.57	± 9.6 %
10042	CAB	IS-54 / IS-136 FDD (TDMA/FDM, PI/4-DQPSK, Halfrate)	AMPS	7.78	± 9.6 %
10044	CAA	IS-91/EIA/TIA-553 FDD (FDMA, FM)	AMPS	0.00	± 9.6 %
10048	CAA	DECT (TDD, TDMA/FDM, GFSK, Full Slot, 24)	DECT	13.80	± 9.6 %
10049	CAA	DECT (TDD, TDMA/FDM, GFSK, Double Slot, 12)	DECT	10.79	± 9.6 %
10056	CAA	UMTS-TDD (TD-SCDMA, 1.28 Mcps)	TD-SCDMA	11.01	± 9.6 %
10058	DAC	EDGE-FDD (TDMA, 8PSK, TN 0-1-2-3)	GSM	6.52	± 9.6 %
10059	CAB	IEEE 802.11b WiFi 2.4 GHz (DSSS, 2 Mbps)	WLAN	2.12	± 9.6 %
10060	CAB	IEEE 802.11b WiFi 2.4 GHz (DSSS, 5.5 Mbps)	WLAN	2.83	± 9.6 %
10061	CAB	IEEE 802.11b WiFi 2.4 GHz (DSSS, 11 Mbps)	WLAN	3.60	± 9.6 %
10062	CAC	IEEE 802.11a/h WiFi 5 GHz (OFDM, 6 Mbps)	WLAN	8.68	± 9.6 %
10063	CAC	IEEE 802.11a/h WiFi 5 GHz (OFDM, 9 Mbps)	WLAN	8.63	± 9.6 %
10064	CAC	IEEE 802.11a/h WiFi 5 GHz (OFDM, 12 Mbps)	WLAN	9.09	± 9.6 %
10065	CAC	IEEE 802.11a/h WiFi 5 GHz (OFDM, 18 Mbps)	WLAN	9.00	± 9.6 %
10066	CAC	IEEE 802.11a/h WiFi 5 GHz (OFDM, 24 Mbps)	WLAN	9.38	± 9.6 %
10067	CAC	IEEE 802.11a/h WiFi 5 GHz (OFDM, 36 Mbps)	WLAN	10.12	± 9.6 %
10068	CAC	IEEE 802.11a/h WiFi 5 GHz (OFDM, 48 Mbps)	WLAN	10.24	± 9.6 %
10069	CAC	IEEE 802.11a/h WiFi 5 GHz (OFDM, 54 Mbps)	WLAN	10.56	± 9.6 %
10071	CAB	IEEE 802.11g WiFi 2.4 GHz (DSSS/OFDM, 9 Mbps)	WLAN	9.83	± 9.6 %
10072	CAB	IEEE 802.11g WiFi 2.4 GHz (DSSS/OFDM, 12 Mbps)	WLAN	9.62	± 9.6 %
10073	CAB	IEEE 802.11g WiFi 2.4 GHz (DSSS/OFDM, 18 Mbps)	WLAN	9.94	± 9.6 %
10074	CAB	IEEE 802.11g WiFi 2.4 GHz (DSSS/OFDM, 24 Mbps)	WLAN	10.30	± 9.6 %
10075	CAB	IEEE 802.11g WiFi 2.4 GHz (DSSS/OFDM, 36 Mbps)	WLAN	10.77	± 9.6 %
10076	CAB	IEEE 802.11g WiFi 2.4 GHz (DSSS/OFDM, 48 Mbps)	WLAN	10.94	± 9.6 %
10077	CAB	IEEE 802.11g WiFi 2.4 GHz (DSSS/OFDM, 54 Mbps)	WLAN	11.00	± 9.6 %
10081	CAB	CDMA2000 (1xRTT, RC3)	CDMA2000	3.97	± 9.6 %
10082	CAB	IS-54 / IS-136 FDD (TDMA/FDM, PI/4-DQPSK, Fullrate)	AMPS	4.77	± 9.6 %
10090	DAC	GPRS-FDD (TDMA, GMSK, TN 0-4)	GSM	6.56	± 9.6 %
10097	CAB	UMTS-FDD (HSDPA)	WCDMA	3.98	± 9.6 %
10098	CAB	UMTS-FDD (HSUPA, Subtest 2)	WCDMA	3.98	± 9.6 %
10099	DAC	EDGE-FDD (TDMA, 8PSK, TN 0-4)	GSM	9.55	± 9.6 %
10100	CAE	LTE-FDD (SC-FDMA, 100% RB, 20 MHz, QPSK)	LTE-FDD	5.67	± 9.6 %
10101	CAE	LTE-FDD (SC-FDMA, 100% RB, 20 MHz, 16-QAM)	LTE-FDD	6.42	± 9.6 %
10102	CAE	LTE-FDD (SC-FDMA, 100% RB, 20 MHz, 64-QAM)	LTE-FDD	6.60	± 9.6 %
10103	CAG	LTE-TDD (SC-FDMA, 100% RB, 20 MHz, QPSK)	LTE-TDD	9.29	± 9.6 %
10104	CAG	LTE-TDD (SC-FDMA, 100% RB, 20 MHz, 16-QAM)	LTE-TDD	9.97	± 9.6 %
10105	CAG	LTE-TDD (SC-FDMA, 100% RB, 20 MHz, 64-QAM)	LTE-TDD	10.01	± 9.6 %
10108	CAG	LTE-FDD (SC-FDMA, 100% RB, 10 MHz, QPSK)	LTE-FDD	5.80	± 9.6 %

10109	CAG	LTE-FDD (SC-FDMA, 100% RB, 10 MHz, 16-QAM)	LTE-FDD	6.43	± 9.6 %
10110	CAG	LTE-FDD (SC-FDMA, 100% RB, 5 MHz, QPSK)	LTE-FDD	5.75	± 9.6 %
10111	CAG	LTE-FDD (SC-FDMA, 100% RB, 5 MHz, 16-QAM)	LTE-FDD	6.44	± 9.6 %
10112	CAG	LTE-FDD (SC-FDMA, 100% RB, 10 MHz, 64-QAM)	LTE-FDD	6.59	± 9.6 %
10113	CAG	LTE-FDD (SC-FDMA, 100% RB, 5 MHz, 64-QAM)	LTE-FDD	6.62	± 9.6 %
10114	CAC	IEEE 802.11n (HT Greenfield, 13.5 Mbps, BPSK)	WLAN	8.10	± 9.6 %
10115	CAC	IEEE 802.11n (HT Greenfield, 81 Mbps, 16-QAM)	WLAN	8.46	± 9.6 %
10116	CAC	IEEE 802.11n (HT Greenfield, 135 Mbps, 64-QAM)	WLAN	8.15	± 9.6 %
10117	CAC	IEEE 802.11n (HT Mixed, 13.5 Mbps, BPSK)	WLAN	8.07	± 9.6 %
10118	CAC	IEEE 802.11n (HT Mixed, 81 Mbps, 16-QAM)	WLAN	8.59	± 9.6 %
10119	CAC	IEEE 802.11n (HT Mixed, 135 Mbps, 64-QAM)	WLAN	8.13	± 9.6 %
10140	CAE	LTE-FDD (SC-FDMA, 100% RB, 15 MHz, 16-QAM)	LTE-FDD	6.49	± 9.6 %
10141	CAE	LTE-FDD (SC-FDMA, 100% RB, 15 MHz, 64-QAM)	LTE-FDD	6.53	± 9.6 %
10142	CAE	LTE-FDD (SC-FDMA, 100% RB, 3 MHz, QPSK)	LTE-FDD	5.73	± 9.6 %
10143	CAE	LTE-FDD (SC-FDMA, 100% RB, 3 MHz, 16-QAM)	LTE-FDD	6.35	± 9.6 %
10144	CAE	LTE-FDD (SC-FDMA, 100% RB, 3 MHz, 64-QAM)	LTE-FDD	6.65	± 9.6 %
10145	CAF	LTE-FDD (SC-FDMA, 100% RB, 1.4 MHz, QPSK)	LTE-FDD	5.76	± 9.6 %
10146	CAF	LTE-FDD (SC-FDMA, 100% RB, 1.4 MHz, 16-QAM)	LTE-FDD	6.41	± 9.6 %
10147	CAF	LTE-FDD (SC-FDMA, 100% RB, 1.4 MHz, 64-QAM)	LTE-FDD	6.72	± 9.6 %
10149	CAE	LTE-FDD (SC-FDMA, 50% RB, 20 MHz, 16-QAM)	LTE-FDD	6.42	± 9.6 %
10150	CAE	LTE-FDD (SC-FDMA, 50% RB, 20 MHz, 64-QAM)	LTE-FDD	6.60	± 9.6 %
10151	CAG	LTE-TDD (SC-FDMA, 50% RB, 20 MHz, QPSK)	LTE-TDD	9.28	± 9.6 %
10152	CAG	LTE-TDD (SC-FDMA, 50% RB, 20 MHz, 16-QAM)	LTE-TDD	9.92	± 9.6 %
10153	CAG	LTE-TDD (SC-FDMA, 50% RB, 20 MHz, 64-QAM)	LTE-TDD	10.05	± 9.6 %
10154	CAG	LTE-FDD (SC-FDMA, 50% RB, 10 MHz, QPSK)	LTE-FDD	5.75	± 9.6 %
10155	CAG	LTE-FDD (SC-FDMA, 50% RB, 10 MHz, 16-QAM)	LTE-FDD	6.43	± 9.6 %
10156	CAG	LTE-FDD (SC-FDMA, 50% RB, 5 MHz, QPSK)	LTE-FDD	5.79	± 9.6 %
10157	CAG	LTE-FDD (SC-FDMA, 50% RB, 5 MHz, 16-QAM)	LTE-FDD	6.49	± 9.6 %
10158	CAG	LTE-FDD (SC-FDMA, 50% RB, 10 MHz, 64-QAM)	LTE-FDD	6.62	± 9.6 %
10159	CAG	LTE-FDD (SC-FDMA, 50% RB, 5 MHz, 64-QAM)	LTE-FDD	6.56	± 9.6 %
10160	CAE	LTE-FDD (SC-FDMA, 50% RB, 15 MHz, QPSK)	LTE-FDD	5.82	± 9.6 %
10161	CAE	LTE-FDD (SC-FDMA, 50% RB, 15 MHz, 16-QAM)	LTE-FDD	6.43	± 9.6 %
10162	CAE	LTE-FDD (SC-FDMA, 50% RB, 15 MHz, 64-QAM)	LTE-FDD	6.58	± 9.6 %
10166	CAF	LTE-FDD (SC-FDMA, 50% RB, 1.4 MHz, QPSK)	LTE-FDD	5.46	± 9.6 %
10167	CAF	LTE-FDD (SC-FDMA, 50% RB, 1.4 MHz, 16-QAM)	LTE-FDD	6.21	± 9.6 %
10168	CAF	LTE-FDD (SC-FDMA, 50% RB, 1.4 MHz, 64-QAM)	LTE-FDD	6.79	± 9.6 %
10169	CAE	LTE-FDD (SC-FDMA, 1 RB, 20 MHz, QPSK)	LTE-FDD	5.73	± 9.6 %
10170	CAE	LTE-FDD (SC-FDMA, 1 RB, 20 MHz, 16-QAM)	LTE-FDD	6.52	± 9.6 %
10171	AAE	LTE-FDD (SC-FDMA, 1 RB, 20 MHz, 64-QAM)	LTE-FDD	6.49	± 9.6 %
10172	CAG	LTE-TDD (SC-FDMA, 1 RB, 20 MHz, QPSK)	LTE-TDD	9.21	± 9.6 %
10173	CAG	LTE-TDD (SC-FDMA, 1 RB, 20 MHz, 16-QAM)	LTE-TDD	9.48	± 9.6 %
10174	CAG	LTE-TDD (SC-FDMA, 1 RB, 20 MHz, 64-QAM)	LTE-TDD	10.25	± 9.6 %
10175	CAG	LTE-FDD (SC-FDMA, 1 RB, 10 MHz, QPSK)	LTE-FDD	5.72	± 9.6 %
10176	CAG	LTE-FDD (SC-FDMA, 1 RB, 10 MHz, 16-QAM)	LTE-FDD	6.52	± 9.6 %
10177	CAI	LTE-FDD (SC-FDMA, 1 RB, 5 MHz, QPSK)	LTE-FDD	5.73	± 9.6 %
10178	CAG	LTE-FDD (SC-FDMA, 1 RB, 5 MHz, 16-QAM)	LTE-FDD	6.52	± 9.6 %
10179	CAG	LTE-FDD (SC-FDMA, 1 RB, 10 MHz, 64-QAM)	LTE-FDD	6.50	± 9.6 %
10180	CAG	LTE-FDD (SC-FDMA, 1 RB, 5 MHz, 64-QAM)	LTE-FDD	6.50	± 9.6 %
10181	CAE	LTE-FDD (SC-FDMA, 1 RB, 15 MHz, QPSK)	LTE-FDD	5.72	± 9.6 %
10182	CAE	LTE-FDD (SC-FDMA, 1 RB, 15 MHz, 16-QAM)	LTE-FDD	6.52	± 9.6 %
10183	AAD	LTE-FDD (SC-FDMA, 1 RB, 15 MHz, 64-QAM)	LTE-FDD	6.50	± 9.6 %
10184	CAE	LTE-FDD (SC-FDMA, 1 RB, 3 MHz, QPSK)	LTE-FDD	5.73	± 9.6 %
10185	CAE	LTE-FDD (SC-FDMA, 1 RB, 3 MHz, 16-QAM)	LTE-FDD	6.51	± 9.6 %
10186	AAE	LTE-FDD (SC-FDMA, 1 RB, 3 MHz, 64-QAM)	LTE-FDD	6.50	± 9.6 %
10187	CAF	LTE-FDD (SC-FDMA, 1 RB, 1.4 MHz, QPSK)	LTE-FDD	5.73	± 9.6 %
10188	CAF	LTE-FDD (SC-FDMA, 1 RB, 1.4 MHz, 16-QAM)	LTE-FDD	6.52	± 9.6 %
10189	AAF	LTE-FDD (SC-FDMA, 1 RB, 1.4 MHz, 64-QAM)	LTE-FDD	6.50	± 9.6 %
10193	CAC	IEEE 802.11n (HT Greenfield, 6.5 Mbps, BPSK)	WLAN	8.09	± 9.6 %
10194	CAC	IEEE 802.11n (HT Greenfield, 39 Mbps, 16-QAM)	WLAN	8.12	± 9.6 %
10195	CAC	IEEE 802.11n (HT Greenfield, 65 Mbps, 64-QAM)	WLAN	8.21	± 9.6 %
10196	CAC	IEEE 802.11n (HT Mixed, 6.5 Mbps, BPSK)	WLAN	8.10	± 9.6 %
10197	CAC	IEEE 802.11n (HT Mixed, 39 Mbps, 16-QAM)	WLAN	8.13	± 9.6 %
10198	CAC	IEEE 802.11n (HT Mixed, 65 Mbps, 64-QAM)	WLAN	8.27	± 9.6 %
10219	CAC	IEEE 802.11n (HT Mixed, 7.2 Mbps, BPSK)	WLAN	8.03	± 9.6 %

10220	CAC	IEEE 802.11n (HT Mixed, 43.3 Mbps, 16-QAM)	WLAN	8.13	± 9.6 %
10221	CAC	IEEE 802.11n (HT Mixed, 72.2 Mbps, 64-QAM)	WLAN	8.27	± 9.6 %
10222	CAC	IEEE 802.11n (HT Mixed, 15 Mbps, BPSK)	WLAN	8.06	± 9.6 %
10223	CAC	IEEE 802.11n (HT Mixed, 90 Mbps, 16-QAM)	WLAN	8.48	± 9.6 %
10224	CAC	IEEE 802.11n (HT Mixed, 150 Mbps, 64-QAM)	WLAN	8.08	± 9.6 %
10225	CAB	UMTS-FDD (HSPA+)	WCDMA	5.97	± 9.6 %
10226	CAA	LTE-TDD (SC-FDMA, 1 RB, 1.4 MHz, 16-QAM)	LTE-TDD	9.49	± 9.6 %
10227	CAA	LTE-TDD (SC-FDMA, 1 RB, 1.4 MHz, 64-QAM)	LTE-TDD	10.26	± 9.6 %
10228	CAA	LTE-TDD (SC-FDMA, 1 RB, 1.4 MHz, QPSK)	LTE-TDD	9.22	± 9.6 %
10229	CAC	LTE-TDD (SC-FDMA, 1 RB, 3 MHz, 16-QAM)	LTE-TDD	9.48	± 9.6 %
10230	CAC	LTE-TDD (SC-FDMA, 1 RB, 3 MHz, 64-QAM)	LTE-TDD	10.25	± 9.6 %
10231	CAC	LTE-TDD (SC-FDMA, 1 RB, 3 MHz, QPSK)	LTE-TDD	9.19	± 9.6 %
10232	CAF	LTE-TDD (SC-FDMA, 1 RB, 5 MHz, 16-QAM)	LTE-TDD	9.48	± 9.6 %
10233	CAF	LTE-TDD (SC-FDMA, 1 RB, 5 MHz, 64-QAM)	LTE-TDD	10.25	± 9.6 %
10234	CAF	LTE-TDD (SC-FDMA, 1 RB, 5 MHz, QPSK)	LTE-TDD	9.21	± 9.6 %
10235	CAF	LTE-TDD (SC-FDMA, 1 RB, 10 MHz, 16-QAM)	LTE-TDD	9.48	± 9.6 %
10236	CAF	LTE-TDD (SC-FDMA, 1 RB, 10 MHz, 64-QAM)	LTE-TDD	10.25	± 9.6 %
10237	CAF	LTE-TDD (SC-FDMA, 1 RB, 10 MHz, QPSK)	LTE-TDD	9.21	± 9.6 %
10238	CAF	LTE-TDD (SC-FDMA, 1 RB, 15 MHz, 16-QAM)	LTE-TDD	9.48	± 9.6 %
10239	CAF	LTE-TDD (SC-FDMA, 1 RB, 15 MHz, 64-QAM)	LTE-TDD	10.25	± 9.6 %
10240	CAF	LTE-TDD (SC-FDMA, 1 RB, 15 MHz, QPSK)	LTE-TDD	9.21	± 9.6 %
10241	CAA	LTE-TDD (SC-FDMA, 50% RB, 1.4 MHz, 16-QAM)	LTE-TDD	9.82	± 9.6 %
10242	CAA	LTE-TDD (SC-FDMA, 50% RB, 1.4 MHz, 64-QAM)	LTE-TDD	9.86	± 9.6 %
10243	CAA	LTE-TDD (SC-FDMA, 50% RB, 1.4 MHz, QPSK)	LTE-TDD	9.46	± 9.6 %
10244	CAC	LTE-TDD (SC-FDMA, 50% RB, 3 MHz, 16-QAM)	LTE-TDD	10.06	± 9.6 %
10245	CAC	LTE-TDD (SC-FDMA, 50% RB, 3 MHz, 64-QAM)	LTE-TDD	10.06	± 9.6 %
10246	CAC	LTE-TDD (SC-FDMA, 50% RB, 3 MHz, QPSK)	LTE-TDD	9.30	± 9.6 %
10247	CAF	LTE-TDD (SC-FDMA, 50% RB, 5 MHz, 16-QAM)	LTE-TDD	9.91	± 9.6 %
10248	CAF	LTE-TDD (SC-FDMA, 50% RB, 5 MHz, 64-QAM)	LTE-TDD	10.09	± 9.6 %
10249	CAF	LTE-TDD (SC-FDMA, 50% RB, 5 MHz, QPSK)	LTE-TDD	9.29	± 9.6 %
10250	CAF	LTE-TDD (SC-FDMA, 50% RB, 10 MHz, 16-QAM)	LTE-TDD	9.81	± 9.6 %
10251	CAF	LTE-TDD (SC-FDMA, 50% RB, 10 MHz, 64-QAM)	LTE-TDD	10.17	± 9.6 %
10252	CAF	LTE-TDD (SC-FDMA, 50% RB, 10 MHz, QPSK)	LTE-TDD	9.24	± 9.6 %
10253	CAF	LTE-TDD (SC-FDMA, 50% RB, 15 MHz, 16-QAM)	LTE-TDD	9.90	± 9.6 %
10254	CAF	LTE-TDD (SC-FDMA, 50% RB, 15 MHz, 64-QAM)	LTE-TDD	10.14	± 9.6 %
10255	CAF	LTE-TDD (SC-FDMA, 50% RB, 15 MHz, QPSK)	LTE-TDD	9.20	± 9.6 %
10256	CAA	LTE-TDD (SC-FDMA, 100% RB, 1.4 MHz, 16-QAM)	LTE-TDD	9.96	± 9.6 %
10257	CAA	LTE-TDD (SC-FDMA, 100% RB, 1.4 MHz, 64-QAM)	LTE-TDD	10.08	± 9.6 %
10258	CAA	LTE-TDD (SC-FDMA, 100% RB, 1.4 MHz, QPSK)	LTE-TDD	9.34	± 9.6 %
10259	CAC	LTE-TDD (SC-FDMA, 100% RB, 3 MHz, 16-QAM)	LTE-TDD	9.98	± 9.6 %
10260	CAC	LTE-TDD (SC-FDMA, 100% RB, 3 MHz, 64-QAM)	LTE-TDD	9.97	± 9.6 %
10261	CAC	LTE-TDD (SC-FDMA, 100% RB, 3 MHz, QPSK)	LTE-TDD	9.24	± 9.6 %
10262	CAF	LTE-TDD (SC-FDMA, 100% RB, 5 MHz, 16-QAM)	LTE-TDD	9.83	± 9.6 %
10263	CAF	LTE-TDD (SC-FDMA, 100% RB, 5 MHz, 64-QAM)	LTE-TDD	10.16	± 9.6 %
10264	CAF	LTE-TDD (SC-FDMA, 100% RB, 5 MHz, QPSK)	LTE-TDD	9.23	± 9.6 %
10265	CAF	LTE-TDD (SC-FDMA, 100% RB, 10 MHz, 16-QAM)	LTE-TDD	9.92	± 9.6 %
10266	CAF	LTE-TDD (SC-FDMA, 100% RB, 10 MHz, 64-QAM)	LTE-TDD	10.07	± 9.6 %
10267	CAF	LTE-TDD (SC-FDMA, 100% RB, 10 MHz, QPSK)	LTE-TDD	9.30	± 9.6 %
10268	CAF	LTE-TDD (SC-FDMA, 100% RB, 15 MHz, 16-QAM)	LTE-TDD	10.06	± 9.6 %
10269	CAF	LTE-TDD (SC-FDMA, 100% RB, 15 MHz, 64-QAM)	LTE-TDD	10.13	± 9.6 %
10270	CAF	LTE-TDD (SC-FDMA, 100% RB, 15 MHz, QPSK)	LTE-TDD	9.58	± 9.6 %
10274	CAB	UMTS-FDD (HSUPA, Subtest 5, 3GPP Rel8.10)	WCDMA	4.87	± 9.6 %
10275	CAB	UMTS-FDD (HSUPA, Subtest 5, 3GPP Rel8.4)	WCDMA	3.96	± 9.6 %
10277	CAA	PHS (QPSK)	PHS	11.81	± 9.6 %
10278	CAA	PHS (QPSK, BW 884MHz, Rolloff 0.5)	PHS	11.81	± 9.6 %
10279	CAA	PHS (QPSK, BW 884MHz, Rolloff 0.38)	PHS	12.18	± 9.6 %
10290	AAB	CDMA2000, RC1, SO55, Full Rate	CDMA2000	3.91	± 9.6 %
10291	AAB	CDMA2000, RC3, SO55, Full Rate	CDMA2000	3.46	± 9.6 %
10292	AAB	CDMA2000, RC3, SO32, Full Rate	CDMA2000	3.39	± 9.6 %
10293	AAB	CDMA2000, RC3, SO3, Full Rate	CDMA2000	3.50	± 9.6 %
10295	AAB	CDMA2000, RC1, SO3, 1/8th Rate 25 fr.	CDMA2000	12.49	± 9.6 %
10297	AAD	LTE-FDD (SC-FDMA, 50% RB, 20 MHz, QPSK)	LTE-FDD	5.81	± 9.6 %
10298	AAD	LTE-FDD (SC-FDMA, 50% RB, 3 MHz, QPSK)	LTE-FDD	5.72	± 9.6 %
10299	AAD	LTE-FDD (SC-FDMA, 50% RB, 3 MHz, 16-QAM)	LTE-FDD	6.39	± 9.6 %

10300	AAD	LTE-FDD (SC-FDMA, 50% RB, 3 MHz, 64-QAM)	LTE-FDD	6.60	± 9.6 %
10301	AAA	IEEE 802.16e WiMAX (29:18, 5ms, 10MHz, QPSK, PUSC)	WiMAX	12.03	± 9.6 %
10302	AAA	IEEE 802.16e WiMAX (29:18, 5ms, 10MHz, QPSK, PUSC, 3 CTRL symbols)	WiMAX	12.57	± 9.6 %
10303	AAA	IEEE 802.16e WiMAX (31:15, 5ms, 10MHz, 64QAM, PUSC)	WiMAX	12.52	± 9.6 %
10304	AAA	IEEE 802.16e WiMAX (29:18, 5ms, 10MHz, 64QAM, PUSC)	WiMAX	11.86	± 9.6 %
10305	AAA	IEEE 802.16e WiMAX (31:15, 10ms, 10MHz, 64QAM, PUSC, 15 symbols)	WiMAX	15.24	± 9.6 %
10306	AAA	IEEE 802.16e WiMAX (29:18, 10ms, 10MHz, 64QAM, PUSC, 18 symbols)	WiMAX	14.67	± 9.6 %
10307	AAA	IEEE 802.16e WiMAX (29:18, 10ms, 10MHz, QPSK, PUSC, 18 symbols)	WiMAX	14.49	± 9.6 %
10308	AAA	IEEE 802.16e WiMAX (29:18, 10ms, 10MHz, 16QAM, PUSC)	WiMAX	14.46	± 9.6 %
10309	AAA	IEEE 802.16e WiMAX (29:18, 10ms, 10MHz, 16QAM, AMC 2x3, 18 symbols)	WiMAX	14.58	± 9.6 %
10310	AAA	IEEE 802.16e WiMAX (29:18, 10ms, 10MHz, QPSK, AMC 2x3, 18 symbols)	WiMAX	14.57	± 9.6 %
10311	AAD	LTE-FDD (SC-FDMA, 100% RB, 15 MHz, QPSK)	LTE-FDD	6.06	± 9.6 %
10313	AAA	iDEN 1:3	iDEN	10.51	± 9.6 %
10314	AAA	iDEN 1:6	iDEN	13.48	± 9.6 %
10315	AAB	IEEE 802.11b WiFi 2.4 GHz (DSSS, 1 Mbps, 96pc duty cycle)	WLAN	1.71	± 9.6 %
10316	AAB	IEEE 802.11g WiFi 2.4 GHz (ERP-OFDM, 6 Mbps, 96pc duty cycle)	WLAN	8.36	± 9.6 %
10317	AAC	IEEE 802.11a WiFi 5 GHz (OFDM, 6 Mbps, 96pc duty cycle)	WLAN	8.36	± 9.6 %
10352	AAA	Pulse Waveform (200Hz, 10%)	Generic	10.00	± 9.6 %
10353	AAA	Pulse Waveform (200Hz, 20%)	Generic	6.99	± 9.6 %
10354	AAA	Pulse Waveform (200Hz, 40%)	Generic	3.98	± 9.6 %
10355	AAA	Pulse Waveform (200Hz, 60%)	Generic	2.22	± 9.6 %
10356	AAA	Pulse Waveform (200Hz, 80%)	Generic	0.97	± 9.6 %
10387	AAA	QPSK Waveform, 1 MHz	Generic	5.10	± 9.6 %
10388	AAA	QPSK Waveform, 10 MHz	Generic	5.22	± 9.6 %
10396	AAA	64-QAM Waveform, 100 kHz	Generic	6.27	± 9.6 %
10399	AAA	64-QAM Waveform, 40 MHz	Generic	6.27	± 9.6 %
10400	AAD	IEEE 802.11ac WiFi (20MHz, 64-QAM, 99pc duty cycle)	WLAN	8.37	± 9.6 %
10401	AAD	IEEE 802.11ac WiFi (40MHz, 64-QAM, 99pc duty cycle)	WLAN	8.60	± 9.6 %
10402	AAD	IEEE 802.11ac WiFi (80MHz, 64-QAM, 99pc duty cycle)	WLAN	8.53	± 9.6 %
10403	AAB	CDMA2000 (1xEV-DO, Rev. 0)	CDMA2000	3.76	± 9.6 %
10404	AAB	CDMA2000 (1xEV-DO, Rev. A)	CDMA2000	3.77	± 9.6 %
10406	AAB	CDMA2000, RC3, SO32, SCH0, Full Rate	CDMA2000	5.22	± 9.6 %
10410	AAF	LTE-TDD (SC-FDMA, 1 RB, 10 MHz, QPSK, UL Subframe=2,3,4,7,8,9, Subframe Conf=4)	LTE-TDD	7.82	± 9.6 %
10414	AAA	WLAN CCDF, 64-QAM, 40MHz	Generic	8.54	± 9.6 %
10415	AAA	IEEE 802.11b WiFi 2.4 GHz (DSSS, 1 Mbps, 99pc duty cycle)	WLAN	1.54	± 9.6 %
10416	AAA	IEEE 802.11g WiFi 2.4 GHz (ERP-OFDM, 6 Mbps, 99pc duty cycle)	WLAN	8.23	± 9.6 %
10417	AAB	IEEE 802.11a/h WiFi 5 GHz (OFDM, 6 Mbps, 99pc duty cycle)	WLAN	8.23	± 9.6 %
10418	AAA	IEEE 802.11g WiFi 2.4 GHz (DSSS-OFDM, 6 Mbps, 99pc duty cycle, Long preamble)	WLAN	8.14	± 9.6 %
10419	AAA	IEEE 802.11g WiFi 2.4 GHz (DSSS-OFDM, 6 Mbps, 99pc duty cycle, Short preamble)	WLAN	8.19	± 9.6 %
10422	AAB	IEEE 802.11n (HT Greenfield, 7.2 Mbps, BPSK)	WLAN	8.32	± 9.6 %
10423	AAB	IEEE 802.11n (HT Greenfield, 43.3 Mbps, 16-QAM)	WLAN	8.47	± 9.6 %
10424	AAB	IEEE 802.11n (HT Greenfield, 72.2 Mbps, 64-QAM)	WLAN	8.40	± 9.6 %
10425	AAB	IEEE 802.11n (HT Greenfield, 15 Mbps, BPSK)	WLAN	8.41	± 9.6 %
10426	AAB	IEEE 802.11n (HT Greenfield, 90 Mbps, 16-QAM)	WLAN	8.45	± 9.6 %
10427	AAB	IEEE 802.11n (HT Greenfield, 150 Mbps, 64-QAM)	WLAN	8.41	± 9.6 %
10430	AAD	LTE-FDD (OFDMA, 5 MHz, E-TM 3.1)	LTE-FDD	8.28	± 9.6 %
10431	AAD	LTE-FDD (OFDMA, 10 MHz, E-TM 3.1)	LTE-FDD	8.38	± 9.6 %
10432	AAC	LTE-FDD (OFDMA, 15 MHz, E-TM 3.1)	LTE-FDD	8.34	± 9.6 %
10433	AAC	LTE-FDD (OFDMA, 20 MHz, E-TM 3.1)	LTE-FDD	8.34	± 9.6 %
10434	AAA	W-CDMA (BS Test Model 1, 64 DPCH)	WCDMA	8.60	± 9.6 %
10435	AAF	LTE-TDD (SC-FDMA, 1 RB, 20 MHz, QPSK, UL Subframe=2,3,4,7,8,9)	LTE-TDD	7.82	± 9.6 %
10447	AAD	LTE-FDD (OFDMA, 5 MHz, E-TM 3.1, Clipping 44%)	LTE-FDD	7.56	± 9.6 %
10448	AAD	LTE-FDD (OFDMA, 10 MHz, E-TM 3.1, Clipping 44%)	LTE-FDD	7.53	± 9.6 %
10449	AAC	LTE-FDD (OFDMA, 15 MHz, E-TM 3.1, Clipping 44%)	LTE-FDD	7.51	± 9.6 %
10450	AAC	LTE-FDD (OFDMA, 20 MHz, E-TM 3.1, Clipping 44%)	LTE-FDD	7.48	± 9.6 %

10451	AAA	W-CDMA (BS Test Model 1, 64 DPCH, Clipping 44%)	WCDMA	7.59	± 9.6 %
10456	AAB	IEEE 802.11ac WiFi (160MHz, 64-QAM, 99pc duty cycle)	WLAN	8.63	± 9.6 %
10457	AAA	UMTS-FDD (DC-HSDPA)	WCDMA	6.62	± 9.6 %
10458	AAA	CDMA2000 (1xEV-DO, Rev. B, 2 carriers)	CDMA2000	6.55	± 9.6 %
10459	AAA	CDMA2000 (1xEV-DO, Rev. B, 3 carriers)	CDMA2000	8.25	± 9.6 %
10460	AAA	UMTS-FDD (WCDMA, AMR)	WCDMA	2.39	± 9.6 %
10461	AAA	LTE-TDD (SC-FDMA, 1 RB, 1.4 MHz, QPSK, UL Subframe=2,3,4,7,8,9)	LTE-TDD	7.82	± 9.6 %
10462	AAA	LTE-TDD (SC-FDMA, 1 RB, 1.4 MHz, 16-QAM, UL Subframe=2,3,4,7,8,9)	LTE-TDD	8.30	± 9.6 %
10463	AAA	LTE-TDD (SC-FDMA, 1 RB, 1.4 MHz, 64-QAM, UL Subframe=2,3,4,7,8,9)	LTE-TDD	8.56	± 9.6 %
10464	AAB	LTE-TDD (SC-FDMA, 1 RB, 3 MHz, QPSK, UL Subframe=2,3,4,7,8,9)	LTE-TDD	7.82	± 9.6 %
10465	AAB	LTE-TDD (SC-FDMA, 1 RB, 3 MHz, 16-QAM, UL Subframe=2,3,4,7,8,9)	LTE-TDD	8.32	± 9.6 %
10466	AAB	LTE-TDD (SC-FDMA, 1 RB, 3 MHz, 64-QAM, UL Subframe=2,3,4,7,8,9)	LTE-TDD	8.57	± 9.6 %
10467	AAE	LTE-TDD (SC-FDMA, 1 RB, 5 MHz, QPSK, UL Subframe=2,3,4,7,8,9)	LTE-TDD	7.82	± 9.6 %
10468	AAE	LTE-TDD (SC-FDMA, 1 RB, 5 MHz, 16-QAM, UL Subframe=2,3,4,7,8,9)	LTE-TDD	8.32	± 9.6 %
10469	AAE	LTE-TDD (SC-FDMA, 1 RB, 5 MHz, 64-QAM, UL Subframe=2,3,4,7,8,9)	LTE-TDD	8.56	± 9.6 %
10470	AAE	LTE-TDD (SC-FDMA, 1 RB, 10 MHz, QPSK, UL Subframe=2,3,4,7,8,9)	LTE-TDD	7.82	± 9.6 %
10471	AAE	LTE-TDD (SC-FDMA, 1 RB, 10 MHz, 16-QAM, UL Subframe=2,3,4,7,8,9)	LTE-TDD	8.32	± 9.6 %
10472	AAE	LTE-TDD (SC-FDMA, 1 RB, 10 MHz, 64-QAM, UL Subframe=2,3,4,7,8,9)	LTE-TDD	8.57	± 9.6 %
10473	AAE	LTE-TDD (SC-FDMA, 1 RB, 15 MHz, QPSK, UL Subframe=2,3,4,7,8,9)	LTE-TDD	7.82	± 9.6 %
10474	AAE	LTE-TDD (SC-FDMA, 1 RB, 15 MHz, 16-QAM, UL Subframe=2,3,4,7,8,9)	LTE-TDD	8.32	± 9.6 %
10475	AAE	LTE-TDD (SC-FDMA, 1 RB, 15 MHz, 64-QAM, UL Subframe=2,3,4,7,8,9)	LTE-TDD	8.57	± 9.6 %
10477	AAF	LTE-TDD (SC-FDMA, 1 RB, 20 MHz, 16-QAM, UL Subframe=2,3,4,7,8,9)	LTE-TDD	8.32	± 9.6 %
10478	AAF	LTE-TDD (SC-FDMA, 1 RB, 20 MHz, 64-QAM, UL Subframe=2,3,4,7,8,9)	LTE-TDD	8.57	± 9.6 %
10479	AAA	LTE-TDD (SC-FDMA, 50% RB, 1.4 MHz, QPSK, UL Subframe=2,3,4,7,8,9)	LTE-TDD	7.74	± 9.6 %
10480	AAA	LTE-TDD (SC-FDMA, 50% RB, 1.4 MHz, 16-QAM, UL Subframe=2,3,4,7,8,9)	LTE-TDD	8.18	± 9.6 %
10481	AAA	LTE-TDD (SC-FDMA, 50% RB, 1.4 MHz, 64-QAM, UL Subframe=2,3,4,7,8,9)	LTE-TDD	8.45	± 9.6 %
10482	AAB	LTE-TDD (SC-FDMA, 50% RB, 3 MHz, QPSK, UL Subframe=2,3,4,7,8,9)	LTE-TDD	7.71	± 9.6 %
10483	AAB	LTE-TDD (SC-FDMA, 50% RB, 3 MHz, 16-QAM, UL Subframe=2,3,4,7,8,9)	LTE-TDD	8.39	± 9.6 %
10484	AAB	LTE-TDD (SC-FDMA, 50% RB, 3 MHz, 64-QAM, UL Subframe=2,3,4,7,8,9)	LTE-TDD	8.47	± 9.6 %
10485	AAE	LTE-TDD (SC-FDMA, 50% RB, 5 MHz, QPSK, UL Subframe=2,3,4,7,8,9)	LTE-TDD	7.59	± 9.6 %
10486	AAE	LTE-TDD (SC-FDMA, 50% RB, 5 MHz, 16-QAM, UL Subframe=2,3,4,7,8,9)	LTE-TDD	8.38	± 9.6 %
10487	AAE	LTE-TDD (SC-FDMA, 50% RB, 5 MHz, 64-QAM, UL Subframe=2,3,4,7,8,9)	LTE-TDD	8.60	± 9.6 %
10488	AAE	LTE-TDD (SC-FDMA, 50% RB, 10 MHz, QPSK, UL Subframe=2,3,4,7,8,9)	LTE-TDD	7.70	± 9.6 %
10489	AAE	LTE-TDD (SC-FDMA, 50% RB, 10 MHz, 16-QAM, UL Subframe=2,3,4,7,8,9)	LTE-TDD	8.31	± 9.6 %
10490	AAE	LTE-TDD (SC-FDMA, 50% RB, 10 MHz, 64-QAM, UL Subframe=2,3,4,7,8,9)	LTE-TDD	8.54	± 9.6 %
10491	AAE	LTE-TDD (SC-FDMA, 50% RB, 15 MHz, QPSK, UL Subframe=2,3,4,7,8,9)	LTE-TDD	7.74	± 9.6 %

10492	AAE	LTE-TDD (SC-FDMA, 50% RB, 15 MHz, 16-QAM, UL Subframe=2,3,4,7,8,9)	LTE-TDD	8.41	± 9.6 %
10493	AAE	LTE-TDD (SC-FDMA, 50% RB, 15 MHz, 64-QAM, UL Subframe=2,3,4,7,8,9)	LTE-TDD	8.55	± 9.6 %
10494	AAF	LTE-TDD (SC-FDMA, 50% RB, 20 MHz, QPSK, UL Subframe=2,3,4,7,8,9)	LTE-TDD	7.74	± 9.6 %
10495	AAF	LTE-TDD (SC-FDMA, 50% RB, 20 MHz, 16-QAM, UL Subframe=2,3,4,7,8,9)	LTE-TDD	8.37	± 9.6 %
10496	AAF	LTE-TDD (SC-FDMA, 50% RB, 20 MHz, 64-QAM, UL Subframe=2,3,4,7,8,9)	LTE-TDD	8.54	± 9.6 %
10497	AAA	LTE-TDD (SC-FDMA, 100% RB, 1.4 MHz, QPSK, UL Subframe=2,3,4,7,8,9)	LTE-TDD	7.67	± 9.6 %
10498	AAA	LTE-TDD (SC-FDMA, 100% RB, 1.4 MHz, 16-QAM, UL Subframe=2,3,4,7,8,9)	LTE-TDD	8.40	± 9.6 %
10499	AAA	LTE-TDD (SC-FDMA, 100% RB, 1.4 MHz, 64-QAM, UL Subframe=2,3,4,7,8,9)	LTE-TDD	8.68	± 9.6 %
10500	AAB	LTE-TDD (SC-FDMA, 100% RB, 3 MHz, QPSK, UL Subframe=2,3,4,7,8,9)	LTE-TDD	7.67	± 9.6 %
10501	AAB	LTE-TDD (SC-FDMA, 100% RB, 3 MHz, 16-QAM, UL Subframe=2,3,4,7,8,9)	LTE-TDD	8.44	± 9.6 %
10502	AAB	LTE-TDD (SC-FDMA, 100% RB, 3 MHz, 64-QAM, UL Subframe=2,3,4,7,8,9)	LTE-TDD	8.52	± 9.6 %
10503	AAE	LTE-TDD (SC-FDMA, 100% RB, 5 MHz, QPSK, UL Subframe=2,3,4,7,8,9)	LTE-TDD	7.72	± 9.6 %
10504	AAE	LTE-TDD (SC-FDMA, 100% RB, 5 MHz, 16-QAM, UL Subframe=2,3,4,7,8,9)	LTE-TDD	8.31	± 9.6 %
10505	AAE	LTE-TDD (SC-FDMA, 100% RB, 5 MHz, 64-QAM, UL Subframe=2,3,4,7,8,9)	LTE-TDD	8.54	± 9.6 %
10506	AAE	LTE-TDD (SC-FDMA, 100% RB, 10 MHz, QPSK, UL Subframe=2,3,4,7,8,9)	LTE-TDD	7.74	± 9.6 %
10507	AAE	LTE-TDD (SC-FDMA, 100% RB, 10 MHz, 16-QAM, UL Subframe=2,3,4,7,8,9)	LTE-TDD	8.36	± 9.6 %
10508	AAE	LTE-TDD (SC-FDMA, 100% RB, 10 MHz, 64-QAM, UL Subframe=2,3,4,7,8,9)	LTE-TDD	8.55	± 9.6 %
10509	AAE	LTE-TDD (SC-FDMA, 100% RB, 15 MHz, QPSK, UL Subframe=2,3,4,7,8,9)	LTE-TDD	7.99	± 9.6 %
10510	AAE	LTE-TDD (SC-FDMA, 100% RB, 15 MHz, 16-QAM, UL Subframe=2,3,4,7,8,9)	LTE-TDD	8.49	± 9.6 %
10511	AAE	LTE-TDD (SC-FDMA, 100% RB, 15 MHz, 64-QAM, UL Subframe=2,3,4,7,8,9)	LTE-TDD	8.51	± 9.6 %
10512	AAF	LTE-TDD (SC-FDMA, 100% RB, 20 MHz, QPSK, UL Subframe=2,3,4,7,8,9)	LTE-TDD	7.74	± 9.6 %
10513	AAF	LTE-TDD (SC-FDMA, 100% RB, 20 MHz, 16-QAM, UL Subframe=2,3,4,7,8,9)	LTE-TDD	8.42	± 9.6 %
10514	AAF	LTE-TDD (SC-FDMA, 100% RB, 20 MHz, 64-QAM, UL Subframe=2,3,4,7,8,9)	LTE-TDD	8.45	± 9.6 %
10515	AAA	IEEE 802.11b WiFi 2.4 GHz (DSSS, 2 Mbps, 99pc duty cycle)	WLAN	1.58	± 9.6 %
10516	AAA	IEEE 802.11b WiFi 2.4 GHz (DSSS, 5.5 Mbps, 99pc duty cycle)	WLAN	1.57	± 9.6 %
10517	AAA	IEEE 802.11b WiFi 2.4 GHz (DSSS, 11 Mbps, 99pc duty cycle)	WLAN	1.58	± 9.6 %
10518	AAB	IEEE 802.11a/h WiFi 5 GHz (OFDM, 9 Mbps, 99pc duty cycle)	WLAN	8.23	± 9.6 %
10519	AAB	IEEE 802.11a/h WiFi 5 GHz (OFDM, 12 Mbps, 99pc duty cycle)	WLAN	8.39	± 9.6 %
10520	AAB	IEEE 802.11a/h WiFi 5 GHz (OFDM, 18 Mbps, 99pc duty cycle)	WLAN	8.12	± 9.6 %
10521	AAB	IEEE 802.11a/h WiFi 5 GHz (OFDM, 24 Mbps, 99pc duty cycle)	WLAN	7.97	± 9.6 %
10522	AAB	IEEE 802.11a/h WiFi 5 GHz (OFDM, 36 Mbps, 99pc duty cycle)	WLAN	8.45	± 9.6 %
10523	AAB	IEEE 802.11a/h WiFi 5 GHz (OFDM, 48 Mbps, 99pc duty cycle)	WLAN	8.08	± 9.6 %
10524	AAB	IEEE 802.11a/h WiFi 5 GHz (OFDM, 54 Mbps, 99pc duty cycle)	WLAN	8.27	± 9.6 %
10525	AAB	IEEE 802.11ac WiFi (20MHz, MCS0, 99pc duty cycle)	WLAN	8.36	± 9.6 %
10526	AAB	IEEE 802.11ac WiFi (20MHz, MCS1, 99pc duty cycle)	WLAN	8.42	± 9.6 %
10527	AAB	IEEE 802.11ac WiFi (20MHz, MCS2, 99pc duty cycle)	WLAN	8.21	± 9.6 %
10528	AAB	IEEE 802.11ac WiFi (20MHz, MCS3, 99pc duty cycle)	WLAN	8.36	± 9.6 %
10529	AAB	IEEE 802.11ac WiFi (20MHz, MCS4, 99pc duty cycle)	WLAN	8.36	± 9.6 %
10531	AAB	IEEE 802.11ac WiFi (20MHz, MCS6, 99pc duty cycle)	WLAN	8.43	± 9.6 %
10532	AAB	IEEE 802.11ac WiFi (20MHz, MCS7, 99pc duty cycle)	WLAN	8.29	± 9.6 %
10533	AAB	IEEE 802.11ac WiFi (20MHz, MCS8, 99pc duty cycle)	WLAN	8.38	± 9.6 %
10534	AAB	IEEE 802.11ac WiFi (40MHz, MCS0, 99pc duty cycle)	WLAN	8.45	± 9.6 %

10535	AAB	IEEE 802.11ac WiFi (40MHz, MCS1, 99pc duty cycle)	WLAN	8.45	± 9.6 %
10536	AAB	IEEE 802.11ac WiFi (40MHz, MCS2, 99pc duty cycle)	WLAN	8.32	± 9.6 %
10537	AAB	IEEE 802.11ac WiFi (40MHz, MCS3, 99pc duty cycle)	WLAN	8.44	± 9.6 %
10538	AAB	IEEE 802.11ac WiFi (40MHz, MCS4, 99pc duty cycle)	WLAN	8.54	± 9.6 %
10540	AAB	IEEE 802.11ac WiFi (40MHz, MCS6, 99pc duty cycle)	WLAN	8.39	± 9.6 %
10541	AAB	IEEE 802.11ac WiFi (40MHz, MCS7, 99pc duty cycle)	WLAN	8.46	± 9.6 %
10542	AAB	IEEE 802.11ac WiFi (40MHz, MCS8, 99pc duty cycle)	WLAN	8.65	± 9.6 %
10543	AAB	IEEE 802.11ac WiFi (40MHz, MCS9, 99pc duty cycle)	WLAN	8.65	± 9.6 %
10544	AAB	IEEE 802.11ac WiFi (80MHz, MCS0, 99pc duty cycle)	WLAN	8.47	± 9.6 %
10545	AAB	IEEE 802.11ac WiFi (80MHz, MCS1, 99pc duty cycle)	WLAN	8.55	± 9.6 %
10546	AAB	IEEE 802.11ac WiFi (80MHz, MCS2, 99pc duty cycle)	WLAN	8.35	± 9.6 %
10547	AAB	IEEE 802.11ac WiFi (80MHz, MCS3, 99pc duty cycle)	WLAN	8.49	± 9.6 %
10548	AAB	IEEE 802.11ac WiFi (80MHz, MCS4, 99pc duty cycle)	WLAN	8.37	± 9.6 %
10550	AAB	IEEE 802.11ac WiFi (80MHz, MCS6, 99pc duty cycle)	WLAN	8.38	± 9.6 %
10551	AAB	IEEE 802.11ac WiFi (80MHz, MCS7, 99pc duty cycle)	WLAN	8.50	± 9.6 %
10552	AAB	IEEE 802.11ac WiFi (80MHz, MCS8, 99pc duty cycle)	WLAN	8.42	± 9.6 %
10553	AAB	IEEE 802.11ac WiFi (80MHz, MCS9, 99pc duty cycle)	WLAN	8.45	± 9.6 %
10554	AAC	IEEE 802.11ac WiFi (160MHz, MCS0, 99pc duty cycle)	WLAN	8.48	± 9.6 %
10555	AAC	IEEE 802.11ac WiFi (160MHz, MCS1, 99pc duty cycle)	WLAN	8.47	± 9.6 %
10556	AAC	IEEE 802.11ac WiFi (160MHz, MCS2, 99pc duty cycle)	WLAN	8.50	± 9.6 %
10557	AAC	IEEE 802.11ac WiFi (160MHz, MCS3, 99pc duty cycle)	WLAN	8.52	± 9.6 %
10558	AAC	IEEE 802.11ac WiFi (160MHz, MCS4, 99pc duty cycle)	WLAN	8.61	± 9.6 %
10560	AAC	IEEE 802.11ac WiFi (160MHz, MCS6, 99pc duty cycle)	WLAN	8.73	± 9.6 %
10561	AAC	IEEE 802.11ac WiFi (160MHz, MCS7, 99pc duty cycle)	WLAN	8.56	± 9.6 %
10562	AAC	IEEE 802.11ac WiFi (160MHz, MCS8, 99pc duty cycle)	WLAN	8.69	± 9.6 %
10563	AAC	IEEE 802.11ac WiFi (160MHz, MCS9, 99pc duty cycle)	WLAN	8.77	± 9.6 %
10564	AAA	IEEE 802.11g WiFi 2.4 GHz (DSSS-OFDM, 9 Mbps, 99pc duty cycle)	WLAN	8.25	± 9.6 %
10565	AAA	IEEE 802.11g WiFi 2.4 GHz (DSSS-OFDM, 12 Mbps, 99pc duty cycle)	WLAN	8.45	± 9.6 %
10566	AAA	IEEE 802.11g WiFi 2.4 GHz (DSSS-OFDM, 18 Mbps, 99pc duty cycle)	WLAN	8.13	± 9.6 %
10567	AAA	IEEE 802.11g WiFi 2.4 GHz (DSSS-OFDM, 24 Mbps, 99pc duty cycle)	WLAN	8.00	± 9.6 %
10568	AAA	IEEE 802.11g WiFi 2.4 GHz (DSSS-OFDM, 36 Mbps, 99pc duty cycle)	WLAN	8.37	± 9.6 %
10569	AAA	IEEE 802.11g WiFi 2.4 GHz (DSSS-OFDM, 48 Mbps, 99pc duty cycle)	WLAN	8.10	± 9.6 %
10570	AAA	IEEE 802.11g WiFi 2.4 GHz (DSSS-OFDM, 54 Mbps, 99pc duty cycle)	WLAN	8.30	± 9.6 %
10571	AAA	IEEE 802.11b WiFi 2.4 GHz (DSSS, 1 Mbps, 90pc duty cycle)	WLAN	1.99	± 9.6 %
10572	AAA	IEEE 802.11b WiFi 2.4 GHz (DSSS, 2 Mbps, 90pc duty cycle)	WLAN	1.99	± 9.6 %
10573	AAA	IEEE 802.11b WiFi 2.4 GHz (DSSS, 5.5 Mbps, 90pc duty cycle)	WLAN	1.98	± 9.6 %
10574	AAA	IEEE 802.11b WiFi 2.4 GHz (DSSS, 11 Mbps, 90pc duty cycle)	WLAN	1.98	± 9.6 %
10575	AAA	IEEE 802.11g WiFi 2.4 GHz (DSSS-OFDM, 6 Mbps, 90pc duty cycle)	WLAN	8.59	± 9.6 %
10576	AAA	IEEE 802.11g WiFi 2.4 GHz (DSSS-OFDM, 9 Mbps, 90pc duty cycle)	WLAN	8.60	± 9.6 %
10577	AAA	IEEE 802.11g WiFi 2.4 GHz (DSSS-OFDM, 12 Mbps, 90pc duty cycle)	WLAN	8.70	± 9.6 %
10578	AAA	IEEE 802.11g WiFi 2.4 GHz (DSSS-OFDM, 18 Mbps, 90pc duty cycle)	WLAN	8.49	± 9.6 %
10579	AAA	IEEE 802.11g WiFi 2.4 GHz (DSSS-OFDM, 24 Mbps, 90pc duty cycle)	WLAN	8.36	± 9.6 %
10580	AAA	IEEE 802.11g WiFi 2.4 GHz (DSSS-OFDM, 36 Mbps, 90pc duty cycle)	WLAN	8.76	± 9.6 %
10581	AAA	IEEE 802.11g WiFi 2.4 GHz (DSSS-OFDM, 48 Mbps, 90pc duty cycle)	WLAN	8.35	± 9.6 %
10582	AAA	IEEE 802.11g WiFi 2.4 GHz (DSSS-OFDM, 54 Mbps, 90pc duty cycle)	WLAN	8.67	± 9.6 %
10583	AAB	IEEE 802.11a/h WiFi 5 GHz (OFDM, 6 Mbps, 90pc duty cycle)	WLAN	8.59	± 9.6 %
10584	AAB	IEEE 802.11a/h WiFi 5 GHz (OFDM, 9 Mbps, 90pc duty cycle)	WLAN	8.60	± 9.6 %
10585	AAB	IEEE 802.11a/h WiFi 5 GHz (OFDM, 12 Mbps, 90pc duty cycle)	WLAN	8.70	± 9.6 %
10586	AAB	IEEE 802.11a/h WiFi 5 GHz (OFDM, 18 Mbps, 90pc duty cycle)	WLAN	8.49	± 9.6 %
10587	AAB	IEEE 802.11a/h WiFi 5 GHz (OFDM, 24 Mbps, 90pc duty cycle)	WLAN	8.36	± 9.6 %

10588	AAB	IEEE 802.11a/h WiFi 5 GHz (OFDM, 36 Mbps, 90pc duty cycle)	WLAN	8.76	± 9.6 %
10589	AAB	IEEE 802.11a/h WiFi 5 GHz (OFDM, 48 Mbps, 90pc duty cycle)	WLAN	8.35	± 9.6 %
10590	AAB	IEEE 802.11a/h WiFi 5 GHz (OFDM, 54 Mbps, 90pc duty cycle)	WLAN	8.67	± 9.6 %
10591	AAB	IEEE 802.11n (HT Mixed, 20MHz, MCS0, 90pc duty cycle)	WLAN	8.63	± 9.6 %
10592	AAB	IEEE 802.11n (HT Mixed, 20MHz, MCS1, 90pc duty cycle)	WLAN	8.79	± 9.6 %
10593	AAB	IEEE 802.11n (HT Mixed, 20MHz, MCS2, 90pc duty cycle)	WLAN	8.64	± 9.6 %
10594	AAB	IEEE 802.11n (HT Mixed, 20MHz, MCS3, 90pc duty cycle)	WLAN	8.74	± 9.6 %
10595	AAB	IEEE 802.11n (HT Mixed, 20MHz, MCS4, 90pc duty cycle)	WLAN	8.74	± 9.6 %
10596	AAB	IEEE 802.11n (HT Mixed, 20MHz, MCS5, 90pc duty cycle)	WLAN	8.71	± 9.6 %
10597	AAB	IEEE 802.11n (HT Mixed, 20MHz, MCS6, 90pc duty cycle)	WLAN	8.72	± 9.6 %
10598	AAB	IEEE 802.11n (HT Mixed, 20MHz, MCS7, 90pc duty cycle)	WLAN	8.50	± 9.6 %
10599	AAB	IEEE 802.11n (HT Mixed, 40MHz, MCS0, 90pc duty cycle)	WLAN	8.79	± 9.6 %
10600	AAB	IEEE 802.11n (HT Mixed, 40MHz, MCS1, 90pc duty cycle)	WLAN	8.88	± 9.6 %
10601	AAB	IEEE 802.11n (HT Mixed, 40MHz, MCS2, 90pc duty cycle)	WLAN	8.82	± 9.6 %
10602	AAB	IEEE 802.11n (HT Mixed, 40MHz, MCS3, 90pc duty cycle)	WLAN	8.94	± 9.6 %
10603	AAB	IEEE 802.11n (HT Mixed, 40MHz, MCS4, 90pc duty cycle)	WLAN	9.03	± 9.6 %
10604	AAB	IEEE 802.11n (HT Mixed, 40MHz, MCS5, 90pc duty cycle)	WLAN	8.76	± 9.6 %
10605	AAB	IEEE 802.11n (HT Mixed, 40MHz, MCS6, 90pc duty cycle)	WLAN	8.97	± 9.6 %
10606	AAB	IEEE 802.11n (HT Mixed, 40MHz, MCS7, 90pc duty cycle)	WLAN	8.82	± 9.6 %
10607	AAB	IEEE 802.11ac WiFi (20MHz, MCS0, 90pc duty cycle)	WLAN	8.64	± 9.6 %
10608	AAB	IEEE 802.11ac WiFi (20MHz, MCS1, 90pc duty cycle)	WLAN	8.77	± 9.6 %
10609	AAB	IEEE 802.11ac WiFi (20MHz, MCS2, 90pc duty cycle)	WLAN	8.57	± 9.6 %
10610	AAB	IEEE 802.11ac WiFi (20MHz, MCS3, 90pc duty cycle)	WLAN	8.78	± 9.6 %
10611	AAB	IEEE 802.11ac WiFi (20MHz, MCS4, 90pc duty cycle)	WLAN	8.70	± 9.6 %
10612	AAB	IEEE 802.11ac WiFi (20MHz, MCS5, 90pc duty cycle)	WLAN	8.77	± 9.6 %
10613	AAB	IEEE 802.11ac WiFi (20MHz, MCS6, 90pc duty cycle)	WLAN	8.94	± 9.6 %
10614	AAB	IEEE 802.11ac WiFi (20MHz, MCS7, 90pc duty cycle)	WLAN	8.59	± 9.6 %
10615	AAB	IEEE 802.11ac WiFi (20MHz, MCS8, 90pc duty cycle)	WLAN	8.82	± 9.6 %
10616	AAB	IEEE 802.11ac WiFi (40MHz, MCS0, 90pc duty cycle)	WLAN	8.82	± 9.6 %
10617	AAB	IEEE 802.11ac WiFi (40MHz, MCS1, 90pc duty cycle)	WLAN	8.81	± 9.6 %
10618	AAB	IEEE 802.11ac WiFi (40MHz, MCS2, 90pc duty cycle)	WLAN	8.58	± 9.6 %
10619	AAB	IEEE 802.11ac WiFi (40MHz, MCS3, 90pc duty cycle)	WLAN	8.86	± 9.6 %
10620	AAB	IEEE 802.11ac WiFi (40MHz, MCS4, 90pc duty cycle)	WLAN	8.87	± 9.6 %
10621	AAB	IEEE 802.11ac WiFi (40MHz, MCS5, 90pc duty cycle)	WLAN	8.77	± 9.6 %
10622	AAB	IEEE 802.11ac WiFi (40MHz, MCS6, 90pc duty cycle)	WLAN	8.68	± 9.6 %
10623	AAB	IEEE 802.11ac WiFi (40MHz, MCS7, 90pc duty cycle)	WLAN	8.82	± 9.6 %
10624	AAB	IEEE 802.11ac WiFi (40MHz, MCS8, 90pc duty cycle)	WLAN	8.96	± 9.6 %
10625	AAB	IEEE 802.11ac WiFi (40MHz, MCS9, 90pc duty cycle)	WLAN	8.96	± 9.6 %
10626	AAB	IEEE 802.11ac WiFi (80MHz, MCS0, 90pc duty cycle)	WLAN	8.83	± 9.6 %
10627	AAB	IEEE 802.11ac WiFi (80MHz, MCS1, 90pc duty cycle)	WLAN	8.88	± 9.6 %
10628	AAB	IEEE 802.11ac WiFi (80MHz, MCS2, 90pc duty cycle)	WLAN	8.71	± 9.6 %
10629	AAB	IEEE 802.11ac WiFi (80MHz, MCS3, 90pc duty cycle)	WLAN	8.85	± 9.6 %
10630	AAB	IEEE 802.11ac WiFi (80MHz, MCS4, 90pc duty cycle)	WLAN	8.72	± 9.6 %
10631	AAB	IEEE 802.11ac WiFi (80MHz, MCS5, 90pc duty cycle)	WLAN	8.81	± 9.6 %
10632	AAB	IEEE 802.11ac WiFi (80MHz, MCS6, 90pc duty cycle)	WLAN	8.74	± 9.6 %
10633	AAB	IEEE 802.11ac WiFi (80MHz, MCS7, 90pc duty cycle)	WLAN	8.83	± 9.6 %
10634	AAB	IEEE 802.11ac WiFi (80MHz, MCS8, 90pc duty cycle)	WLAN	8.80	± 9.6 %
10635	AAB	IEEE 802.11ac WiFi (80MHz, MCS9, 90pc duty cycle)	WLAN	8.81	± 9.6 %
10636	AAC	IEEE 802.11ac WiFi (160MHz, MCS0, 90pc duty cycle)	WLAN	8.83	± 9.6 %
10637	AAC	IEEE 802.11ac WiFi (160MHz, MCS1, 90pc duty cycle)	WLAN	8.79	± 9.6 %
10638	AAC	IEEE 802.11ac WiFi (160MHz, MCS2, 90pc duty cycle)	WLAN	8.86	± 9.6 %
10639	AAC	IEEE 802.11ac WiFi (160MHz, MCS3, 90pc duty cycle)	WLAN	8.85	± 9.6 %
10640	AAC	IEEE 802.11ac WiFi (160MHz, MCS4, 90pc duty cycle)	WLAN	8.98	± 9.6 %
10641	AAC	IEEE 802.11ac WiFi (160MHz, MCS5, 90pc duty cycle)	WLAN	9.06	± 9.6 %
10642	AAC	IEEE 802.11ac WiFi (160MHz, MCS6, 90pc duty cycle)	WLAN	9.06	± 9.6 %
10643	AAC	IEEE 802.11ac WiFi (160MHz, MCS7, 90pc duty cycle)	WLAN	8.89	± 9.6 %
10644	AAC	IEEE 802.11ac WiFi (160MHz, MCS8, 90pc duty cycle)	WLAN	9.05	± 9.6 %
10645	AAC	IEEE 802.11ac WiFi (160MHz, MCS9, 90pc duty cycle)	WLAN	9.11	± 9.6 %
10646	AAF	LTE-TDD (SC-FDMA, 1 RB, 5 MHz, QPSK, UL Subframe=2,7)	LTE-TDD	11.96	± 9.6 %
10647	AAF	LTE-TDD (SC-FDMA, 1 RB, 20 MHz, QPSK, UL Subframe=2,7)	LTE-TDD	11.96	± 9.6 %
10648	AAA	CDMA2000 (1x Advanced)	CDMA2000	3.45	± 9.6 %
10652	AAD	LTE-TDD (OFDMA, 5 MHz, E-TM 3.1, Clipping 44%)	LTE-TDD	6.91	± 9.6 %
10653	AAD	LTE-TDD (OFDMA, 10 MHz, E-TM 3.1, Clipping 44%)	LTE-TDD	7.42	± 9.6 %
10654	AAD	LTE-TDD (OFDMA, 15 MHz, E-TM 3.1, Clipping 44%)	LTE-TDD	6.96	± 9.6 %