



CERTIFICATION TEST REPORT

Report Number. : 11600175-E1V1

Applicant : MICROSOFT CORP
ONE MICROSOFT WAY
REDMOND, WA 98052, U.S.A.

Model : 1796

FCC ID : C3K1796

IC : 3048A-1796

EUT Description : PORTABLE COMPUTING DEVICE

Test Standard(s) : FCC 47 CFR PART 15 SUBPART C
INDUSTRY CANADA RSS - 247 ISSUE 2

Date Of Issue:

May 02, 2017

Prepared by:

UL Verification Services Inc.
47173 Benicia Street
Fremont, CA 94538, U.S.A.
TEL: (510) 771-1000
FAX: (510) 661-0888



NVLAP LAB CODE 200065-0

Revision History

<u>Rev.</u>	<u>Issue Date</u>	<u>Revisions</u>	<u>Revised By</u>
V1	03/14/2017	Initial Issue	---
V2	05/02/2017	Updated Sections 5.5 and 8.1	F. de Anda

TABLE OF CONTENTS

1. ATTESTATION OF TEST RESULTS	5
2. TEST METHODOLOGY	6
3. FACILITIES AND ACCREDITATION	6
4. CALIBRATION AND UNCERTAINTY	7
4.1. MEASURING INSTRUMENT CALIBRATION	7
4.2. SAMPLE CALCULATION	7
4.3. MEASUREMENT UNCERTAINTY.....	7
5. EQUIPMENT UNDER TEST	8
5.1. DESCRIPTION OF EUT	8
5.2. MAXIMUM OUTPUT POWER.....	8
5.3. DESCRIPTION OF AVAILABLE ANTENNAS	8
5.4. SOFTWARE AND FIRMWARE.....	8
5.5. WORST-CASE CONFIGURATION AND MODE.....	8
5.6. DESCRIPTION OF TEST SETUP.....	9
6. TEST AND MEASUREMENT EQUIPMENT	13
7. ANTENNA PORT TEST RESULTS	14
7.1. MEASUREMENT METHODS	14
7.2. ON TIME, DUTY CYCLE	15
7.4. BLE.....	16
7.4.1. 6 dB BANDWIDTH.....	16
7.4.2. 99% BANDWIDTH.....	20
7.4.3. AVERAGE POWER.....	24
7.4.4. OUTPUT POWER	26
7.4.5. POWER SPECTRAL DENSITY	27
7.4.6. CONDUCTED BANDEDGE AND SPURIOUS EMISSIONS.....	30
8. RADIATED TEST RESULTS.....	34
8.1. LIMITS AND PROCEDURE	34
8.2. BLE.....	35
8.2.1. RESTRICTED BANDEDGE (LOW CHANNEL).....	35
8.2.2. AUTHORIZED BANDEDGE (HIGH CHANNEL).....	38
8.2.3. HARMONICS AND SPURIOUS EMISSIONS	40
8.3. WORST-CASE BELOW 1 GHz.....	46
8.4. WORST-CASE ABOVE 18 GHz	48

8.5. AC POWER LINE CONDUCTED EMISSIONS50

9. SETUP PHOTOS.....54

1. ATTESTATION OF TEST RESULTS

COMPANY NAME: MICROSOFT CORP
ONE MICROSOFT WAY
REDMOND, WA 98052, U.S.A.

EUT DESCRIPTION: PORTABLE COMPUTING DEVICE

MODEL: 1796

SERIAL NUMBER: 035885670353 (Conducted); 035828270353 (Radiated)

DATE TESTED: March 2nd 2017 – March 10th 2017

APPLICABLE STANDARDS	
STANDARD	TEST RESULTS
CFR 47 Part 15 Subpart C	Pass
INDUSTRY CANADA RSS-247 Issue 2	Pass
INDUSTRY CANADA RSS-GEN Issue 4	Pass

UL Verification Services Inc. tested the above equipment in accordance with the requirements set forth in the above standards. All indications of Pass/Fail in this report are opinions expressed by UL Verification Services Inc. based on interpretations and/or observations of test results. Measurement Uncertainties were not taken into account and are published for informational purposes only. The test results show that the equipment tested is capable of demonstrating compliance with the requirements as documented in this report.

Note: The results documented in this report apply only to the tested sample, under the conditions and modes of operation as described herein. This document may not be altered or revised in any way unless done so by UL Verification Services Inc. and all revisions are duly noted in the revisions section. Any alteration of this document not carried out by UL Verification Services Inc. will constitute fraud and shall nullify the document. This report must not be used by the client to claim product certification, approval, or endorsement by NVLAP, NIST, any agency of the Federal Government, or any agency of the U.S. government.

Approved & Released For
UL Verification Services Inc. By:



Francisco de Anda
CONSUMER TECHNOLOGY DIVISION
Program Manager
UL Verification Services Inc.

Prepared By:



Clifford Susa
CONSUMER TECHNOLOGY DIVISION
Engineer
UL Verification Services Inc.

2. TEST METHODOLOGY

The tests documented in this report were performed in accordance with FCC CFR 47 Part 2, FCC CFR 47 Part 15, ANSI C63.10-2013, RSS-GEN Issue 4, and RSS-247 Issue 2.

3. FACILITIES AND ACCREDITATION

The test sites and measurement facilities used to collect data are located at 47173 and 47266 Benicia Street, Fremont, California, USA. Line conducted emissions are measured only at the 47173 address. The following table identifies which facilities were utilized for radiated emission measurements documented in this report. Specific facilities are also identified in the test results sections.

47173 Benicia Street	47266 Benicia Street
<input checked="" type="checkbox"/> Chamber A	<input type="checkbox"/> Chamber D
<input checked="" type="checkbox"/> Chamber B	<input type="checkbox"/> Chamber E
<input checked="" type="checkbox"/> Chamber C	<input type="checkbox"/> Chamber F
	<input type="checkbox"/> Chamber G
	<input type="checkbox"/> Chamber H

The above test sites and facilities are covered under FCC Test Firm Registration # 208313. Chambers A through C are covered under Industry Canada company address code 2324B with site numbers 2324B -1 through 2324B-3, respectively. Chambers D through H are covered under Industry Canada company address code 22541 with site numbers 22541 -1 through 22541-5, respectively.

UL Verification Services Inc. is accredited by NVLAP, Laboratory Code 200065-0. The full scope of accreditation can be viewed at <http://ts.nist.gov/standards/scopes/2000650.htm>.

4. CALIBRATION AND UNCERTAINTY

4.1. MEASURING INSTRUMENT CALIBRATION

The measuring equipment utilized to perform the tests documented in this report has been calibrated in accordance with the manufacturer's recommendations, and is traceable to recognized national standards.

4.2. SAMPLE CALCULATION

Where relevant, the following sample calculation is provided:

$$\begin{aligned} \text{Field Strength (dBuV/m)} &= \text{Measured Voltage (dBuV)} + \text{Antenna Factor (dB/m)} + \\ &\text{Cable Loss (dB)} - \text{Preamp Gain (dB)} \\ 36.5 \text{ dBuV} + 18.7 \text{ dB/m} + 0.6 \text{ dB} - 26.9 \text{ dB} &= 28.9 \text{ dBuV/m} \end{aligned}$$

4.3. MEASUREMENT UNCERTAINTY

Where relevant, the following measurement uncertainty levels have been estimated for tests performed on the apparatus:

Parameter	Uncertainty
Worst Case Conducted Disturbance, 9KHz to 0.15 MHz	3.84 dB
Worst Case Conducted Disturbance, 0.15 to 30 MHz	3.65 dB
Worst Case Radiated Disturbance, 9KHz to 30 MHz	3.15 dB
Worst Case Radiated Disturbance, 30 to 1000 MHz	5.36 dB
Worst Case Radiated Disturbance, 1000 to 18000 MHz	4.32 dB
Worst Case Radiated Disturbance, 18000 to 26000 MHz	4.45 dB
Worst Case Radiated Disturbance, 26000 to 40000 MHz	5.24 dB

Uncertainty figures are valid to a confidence level of 95%.

5. EQUIPMENT UNDER TEST

5.1. DESCRIPTION OF EUT

The EUT is a handheld computing device with 802.11 2x2, a/b/g/n/ac WLAN, Bluetooth, Bluetooth LE.

5.2. MAXIMUM OUTPUT POWER

The transmitter has a maximum peak conducted output power as follows:

Frequency Range (MHz)	Mode	Output Power (dBm)	Output Power (mW)
2402 - 2480	BLE	2.76	1.89

The transmitter has a maximum average conducted output power as follows:

Frequency Range (MHz)	Mode	Output Power (dBm)	Output Power (mW)
2402 - 2480	BLE	2.28	1.69

5.3. DESCRIPTION OF AVAILABLE ANTENNAS

The radio utilizes an integrated antenna, with a maximum gain of 3.2 dBi.

5.4. SOFTWARE AND FIRMWARE

The EUT firmware installed during testing was 14.2.201.157

The test utility software used during testing was WiFi tool v2.7.6.

5.5. WORST-CASE CONFIGURATION AND MODE

Radiated emission below 1GHz and 18-26GHz and power line conducted emission were performed with the EUT set to transmit at the channel with highest output power as worst-case scenario.

The fundamental of the EUT was investigated in three orthogonal orientations X/Y/Z, it was determined that Y orientation was worst-case orientation. Therefore, all final radiated testing was performed with the EUT in Y orientation.

Worst-case data rates as provided by the client were:

BLE: 1 Mbps.

5.6. DESCRIPTION OF TEST SETUP

SUPPORT EQUIPMENT

Support Equipment List				
Description	Manufacturer	Model	Serial Number	FCC ID
Laptop AC/DC adapter	Lenovo	ADLX45NCC2A	11S36200281ZZ20059W0H5	NA
Laptop	Lenovo	11e	LR-04N7BL	NA
USB Ethernet Adapter	Linksys	USB3GIGV1	15710S08406242	NA

I/O CABLES

I/O Cable List						
Cable No	Port	# of identical ports	Connector Type	Cable Type	Cable Length (m)	Remarks
1	USB	1	USB	Un-Shielded	0.17	
2	DC	1	Proprietary	Un-Shielded	1.75	
3	AC	1	2-prong	Un-Shielded	0.5	
4	Ethernet	1	RJ45	Un-Shielded	2	

TEST SETUP

The EUT was tested connected to a host Laptop via RJ45/USB cable for antenna port and AC tests. Radiated tests were performed with EUT connected to AC adapter and remote laptop. Test software exercised the radio card.

SETUP DIAGRAM FOR ANTENNA PORT CONDUCTED TESTS

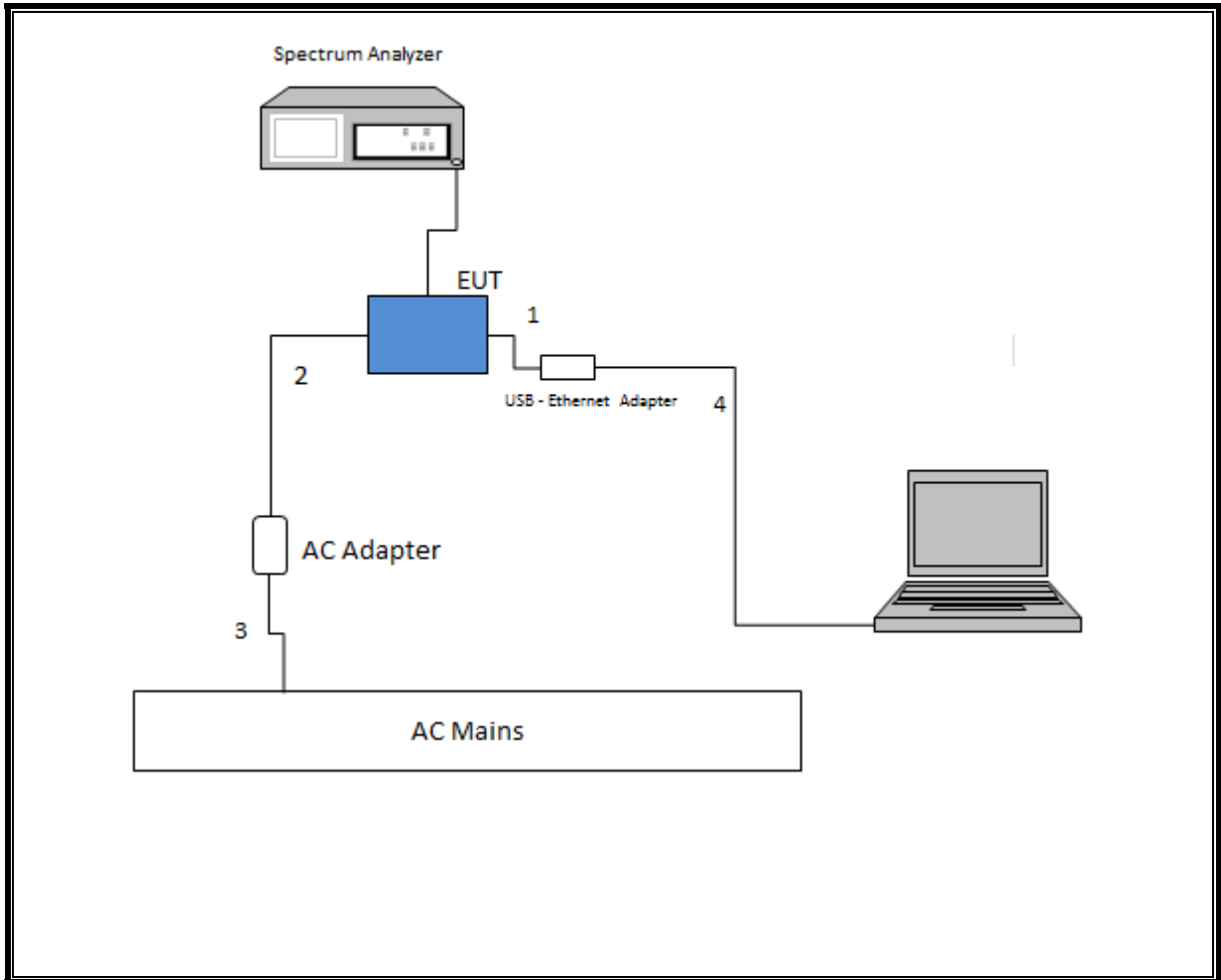

SETUP DIAGRAM FOR RADIATED TESTS

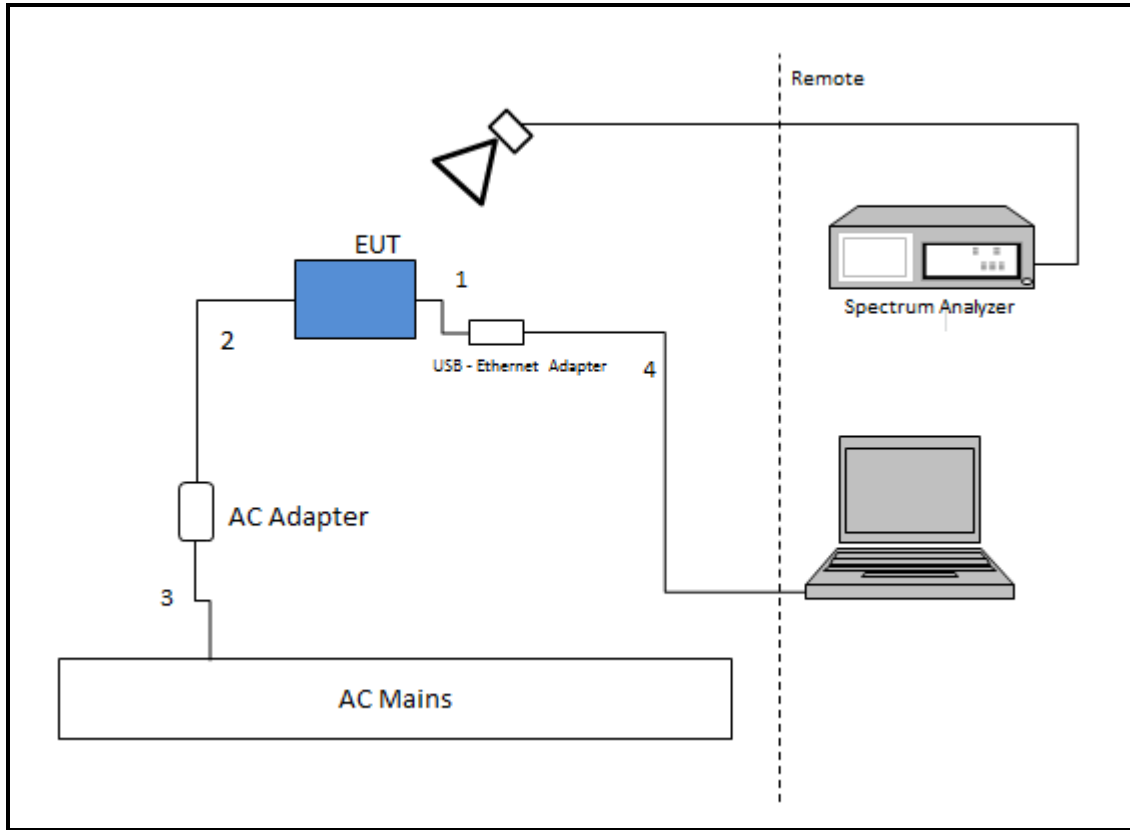

SETUP DIAGRAM FOR AC LINE CONDUCTED TESTS

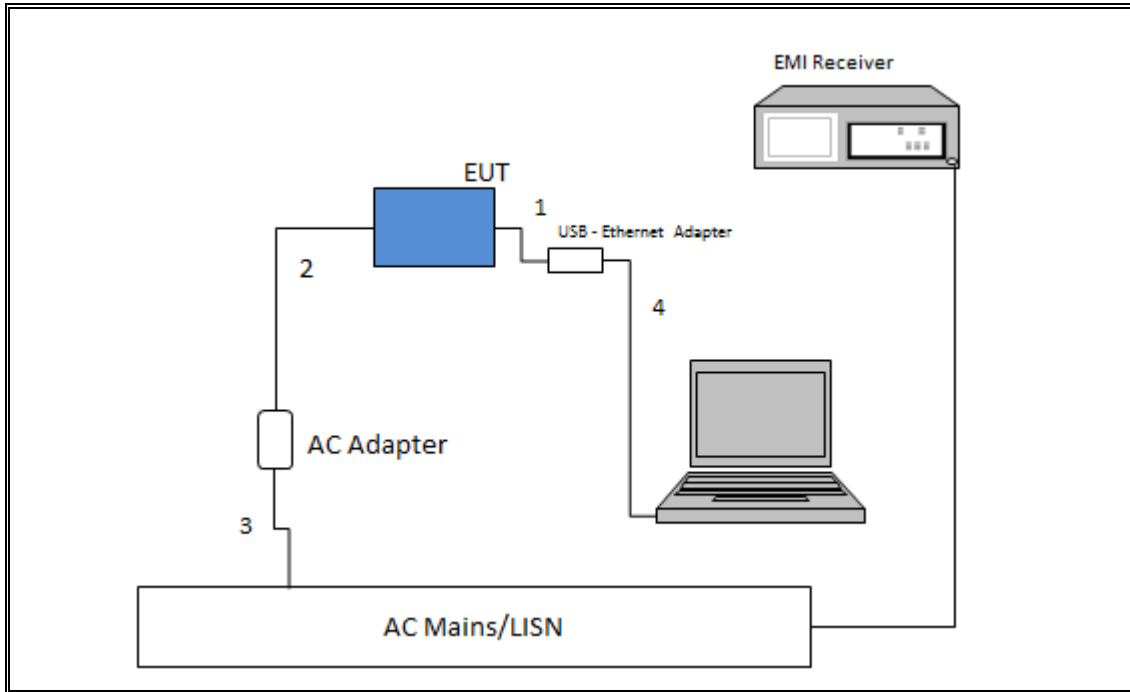

6. TEST AND MEASUREMENT EQUIPMENT

The following test and measurement equipment was utilized for the tests documented in this report:

TEST EQUIPMENT LIST				
Description	Manufacturer	Model	Asset	Cal Due
Antenna, Biconolog, 30MHz-1 GHz	Sunol Sciences Corp.	JB3	T408	11/10/17
Antenna, Horn 1-18GHz	ETS-Lindgren	3117	T711	01/30/18
High Pass Filter 3GHz	Micro-Tronics	HPM17543	T486	8/1/17
RF Preamplifier, 1 - 18GHz	MITEQ	AFS42-00101800-25-S-42	T1165	8/1/17
RF Preamplifier, 1 - 7GHz	Amplical	AMP1G6-10-27	T1370	04/15/17
RF Preamplifier, 10kHz - 1GHz	Sonoma	310N	T15	08/26/17
Spectrum Analyzer	Agilent (Keysight) Technologies	N9030A	T908	04/13/17
Spectrum Analyzer	Agilent (Keysight) Technologies	E4440A	T199	7/22/17
Antenna, Horn, 18-26 GHz	ARA	MWH-1826/B	T449	05/26/17
RF Preamplifier, 1 - 26GHz	Agilent	8449B	T404	07/05/17
Spectrum Analyzer	HP	8564E	T106	09/07/17
EMI Receiver	Rohde & Schwarz	ESR	T1436	1/6/2018
LISN	Fischer Custom Communications	FCC-LISN-50/250-25-2-01	T1310	6/8/2017
Power Meter	Keysight	N1911A	T229	7/28/17
Power Sensor	Keysight	N1921A	T413	6/20/17

7. ANTENNA PORT TEST RESULTS

7.1. MEASUREMENT METHODS

On Time and Duty Cycle: KDB 558074 D01 v03r05, Section 6.

6 dB BW: KDB 558074 D01 v03r05, Section 8.1.

Output Power: KDB 558074 D01 v03r05, Section 9.1.2.

Power Spectral Density: KDB 558074 D01 v03r05, Section 10.2.

Out-of-band emissions in non-restricted bands: KDB 558074 D01 v03r05, Section 11.0.

Out-of-band emissions in restricted bands: KDB 558074 D01 v03r05, Section 12.1.

Band-edge: KDB 558074 D01 v03r05, Section 12.1.

AC Power Line Conducted Emissions: ANSI C63.10-2009, Section 6.2.

7.2. ON TIME, DUTY CYCLE

LIMITS

None; for reporting purposes only.

PROCEDURE

KDB 558074 Zero-Span Spectrum Analyzer Method.

ON TIME AND DUTY CYCLE RESULTS

Mode	ON Time B (msec)	Period (msec)	Duty Cycle x (linear)	Duty Cycle (%)	Duty Cycle Correction Factor (dB)	1/B Minimum VBW (kHz)
BLE	0.386	0.624	0.618	61.858	2.085	2.59

DUTY CYCLE PLOTS

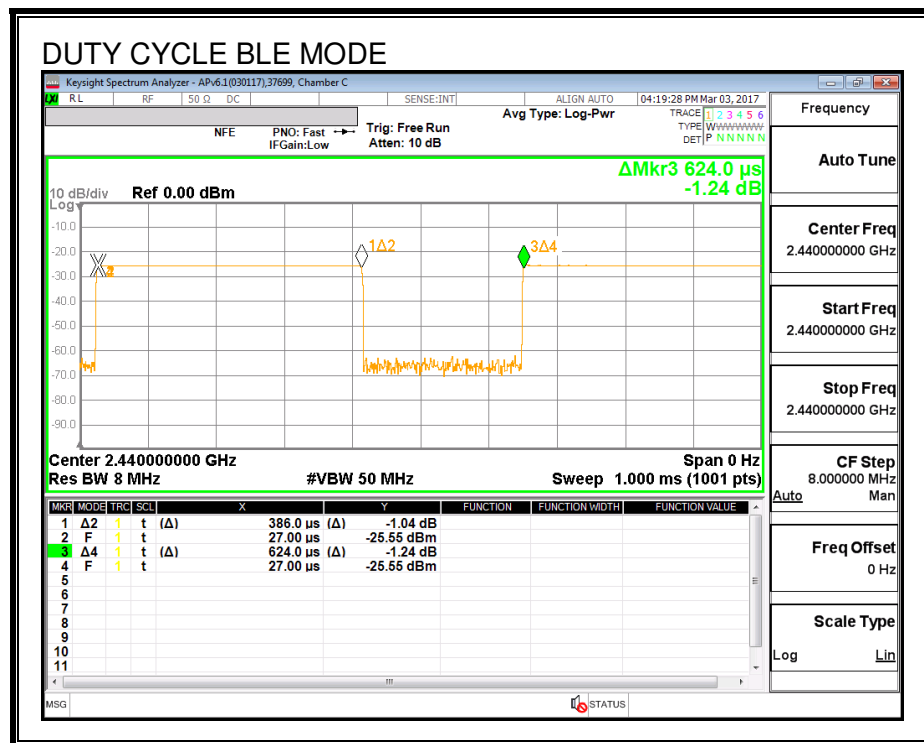

7.4. BLE

7.4.1. 6 dB BANDWIDTH

LIMITS

FCC §15.247 (a) (2)

IC RSS-247 (5.2) (a)

The minimum 6 dB bandwidth shall be at least 500 kHz.

RESULTS

Channel	Frequency	6 dB Bandwidth (MHz)	Minimum Limit (MHz)
Low	2402	0.648	0.5
Middle	2440	0.670	0.5
High	2480	0.690	0.5

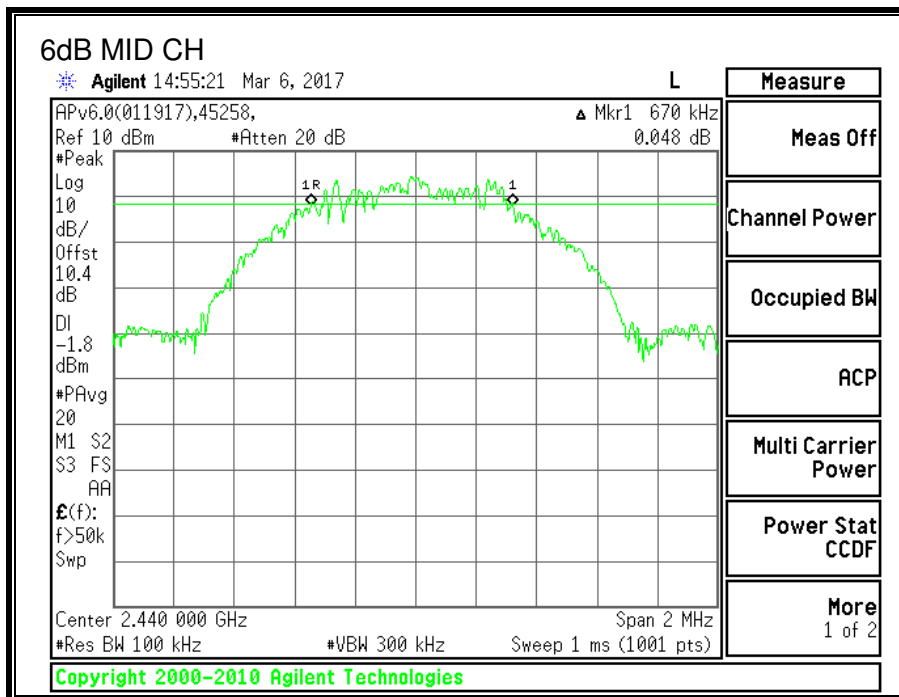
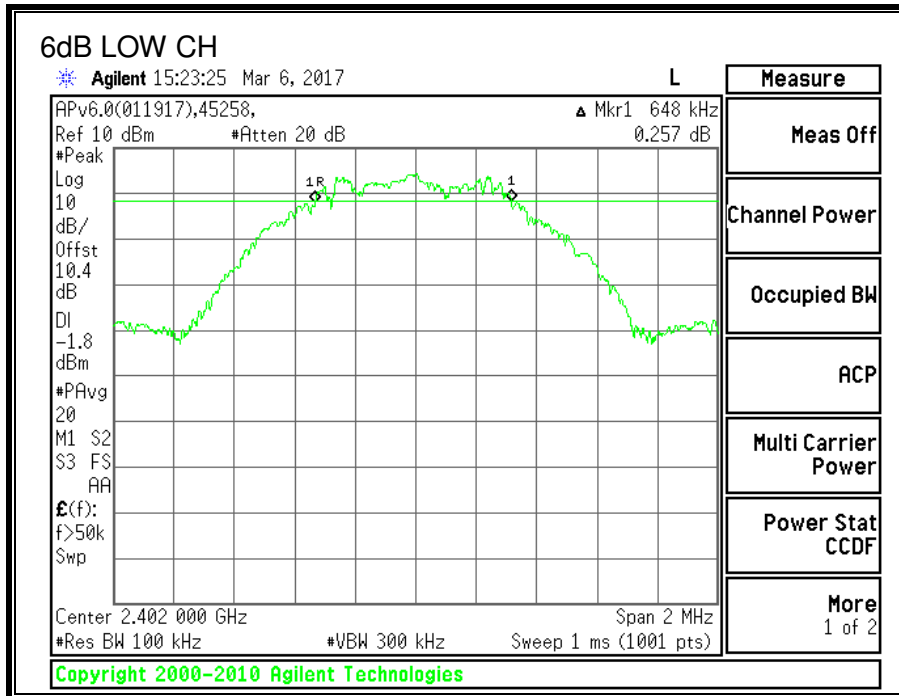

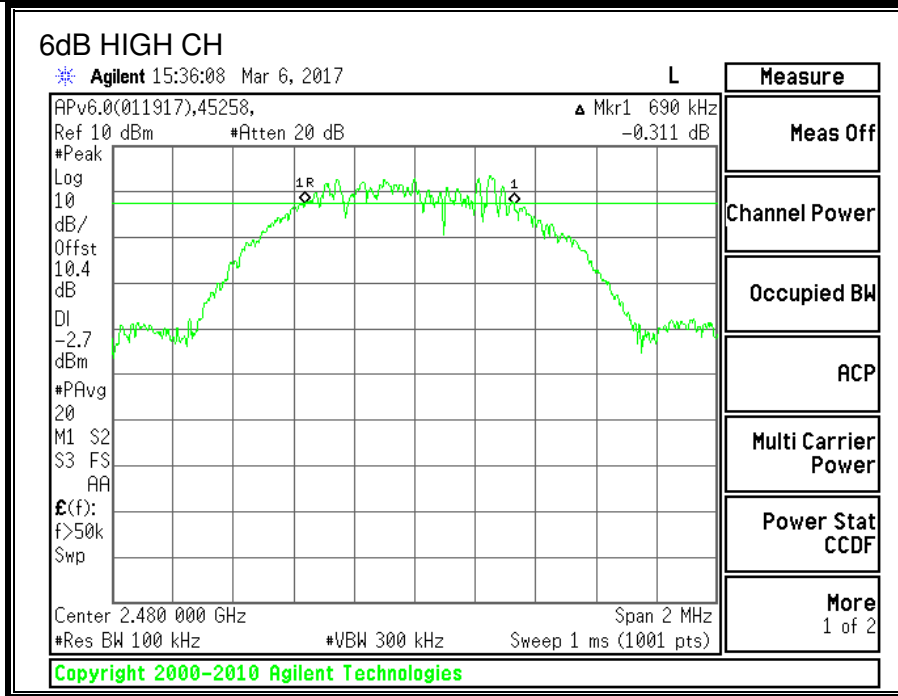

7.4.2. 99% BANDWIDTH

LIMITS

None; for reporting purposes only.

Test Procedure

The transmitter output is connected to the spectrum analyzer. The RBW is set to 1% to 3% of the 99 % bandwidth and to 1% of the span. The VBW is set to 3 times the RBW. The sweep time is coupled. The spectrum analyzer internal 99% bandwidth function is utilized.

RESULTS

Channel	Frequency (MHz)	99% Bandwidth (MHz)
Low	2402	1.0213
Middle	2440	1.0198
High	2480	1.0206

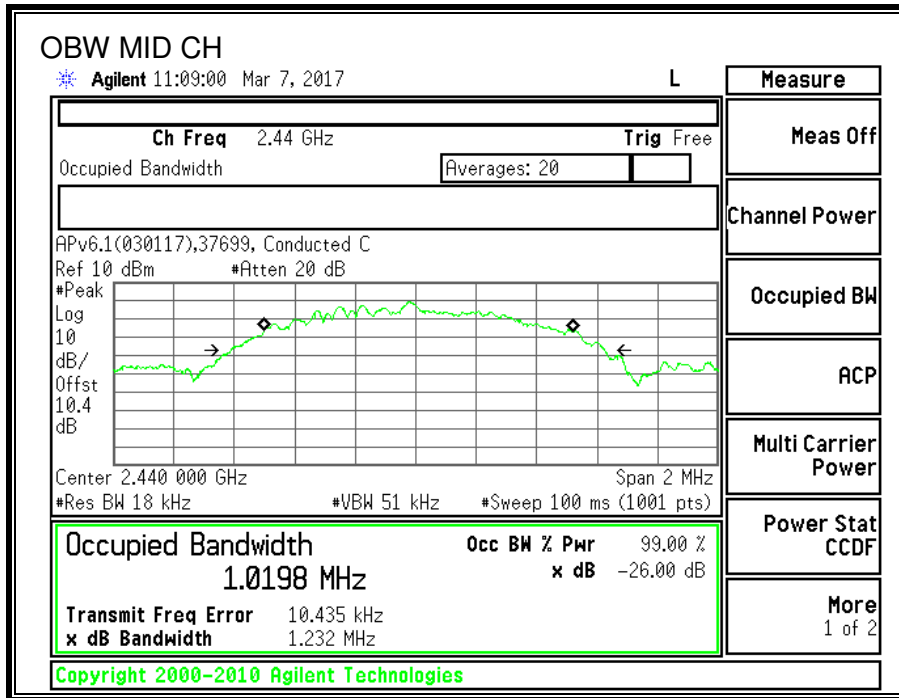
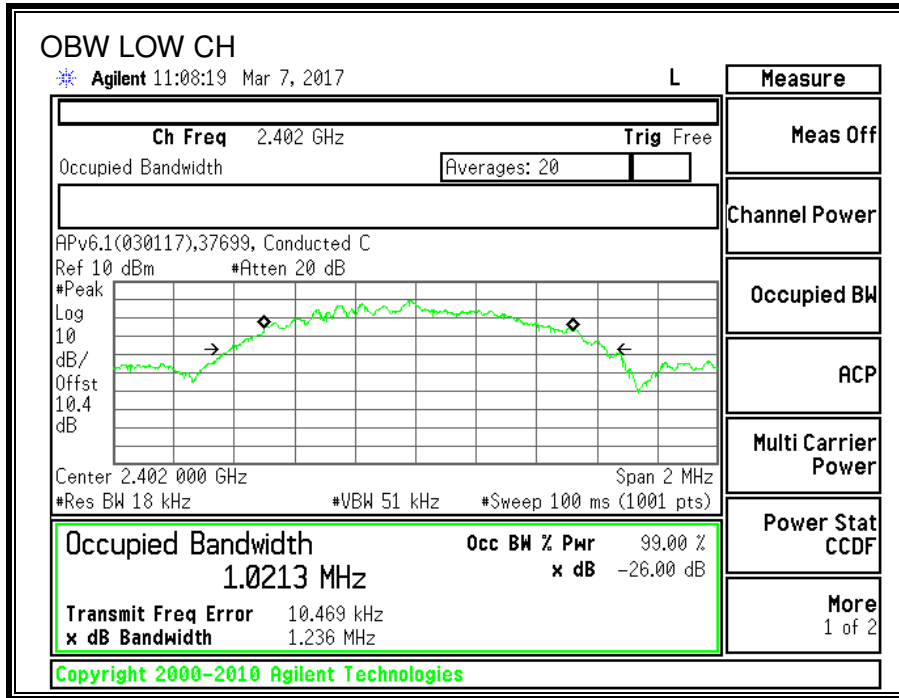

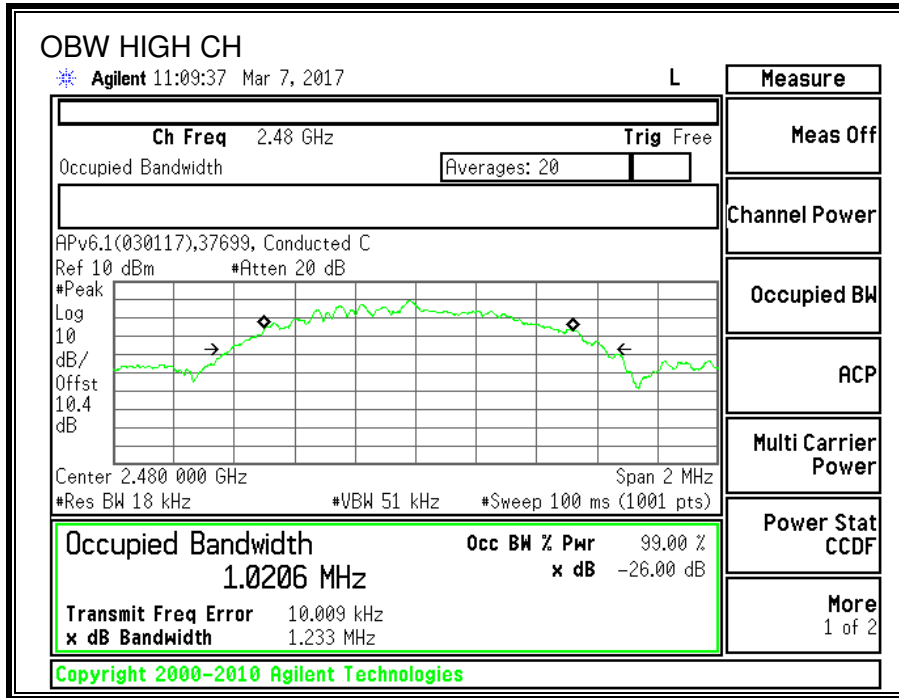

7.4.3. AVERAGE POWER

LIMITS

None; for reporting purposes only.

RESULTS

ID:	45258 JL	Date:	3/6/17
------------	----------	--------------	--------

Channel	Frequency (MHz)	AV Power (dBm)
Low	2402	2.24
Middle	2440	2.25
High	2480	2.28

7.4.4. OUTPUT POWER

LIMITS

FCC §15.247 (b)

IC RSS-247 (5.4) (d)

The maximum antenna gain is less than or equal to 6 dBi, therefore the limit is 30 dBm.

RESULTS

Tested By:	45258 JL
Date:	3/6/2017

Channel	Frequency (MHz)	Peak Power Reading (dBm)	Limit (dBm)	Margin (dB)
Low	2402	2.67	30	-27.33
Middle	2440	2.73	30	-27.27
High	2480	2.76	30	-27.24

7.4.5. POWER SPECTRAL DENSITY

LIMITS

FCC §15.247 (e)

IC RSS-247 (5.2) (b)

The power spectral density conducted from the transmitter to the antenna shall not be greater than 8 dBm in any 3 kHz band during any time interval of continuous transmission.

RESULTS

Channel	Frequency (MHz)	PSD (dBm)	Limit (dBm)	Margin (dB)
Low	2402	-11.83	8	-19.83
Middle	2440	-11.88	8	-19.88
High	2480	-11.81	8	-19.81

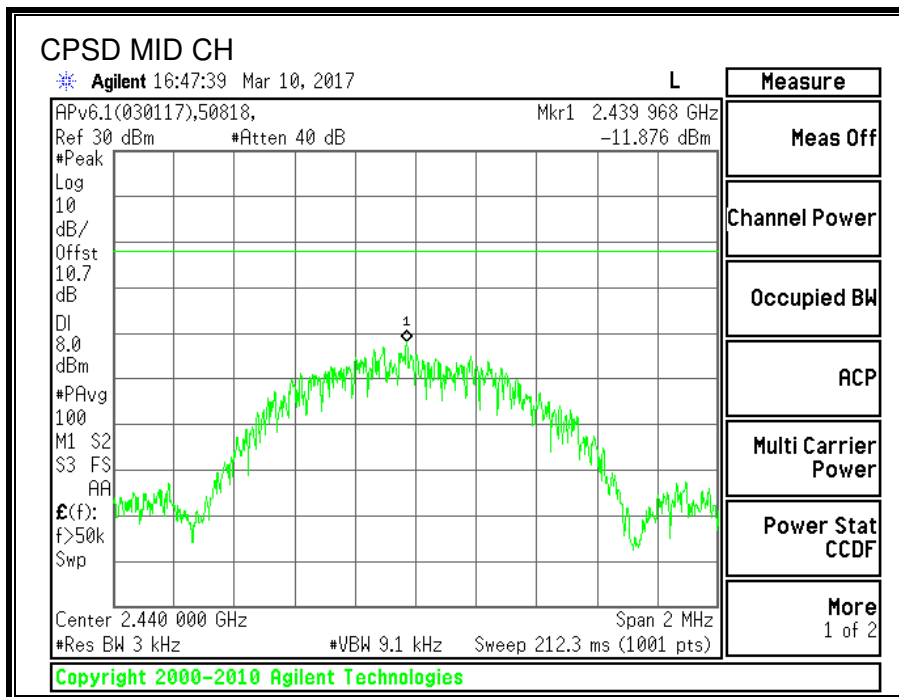
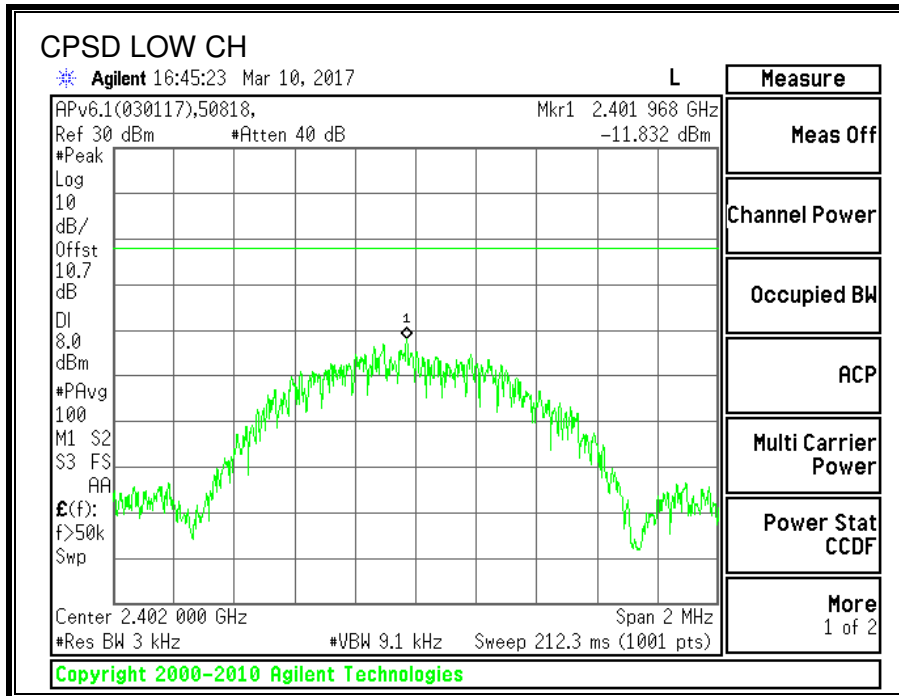

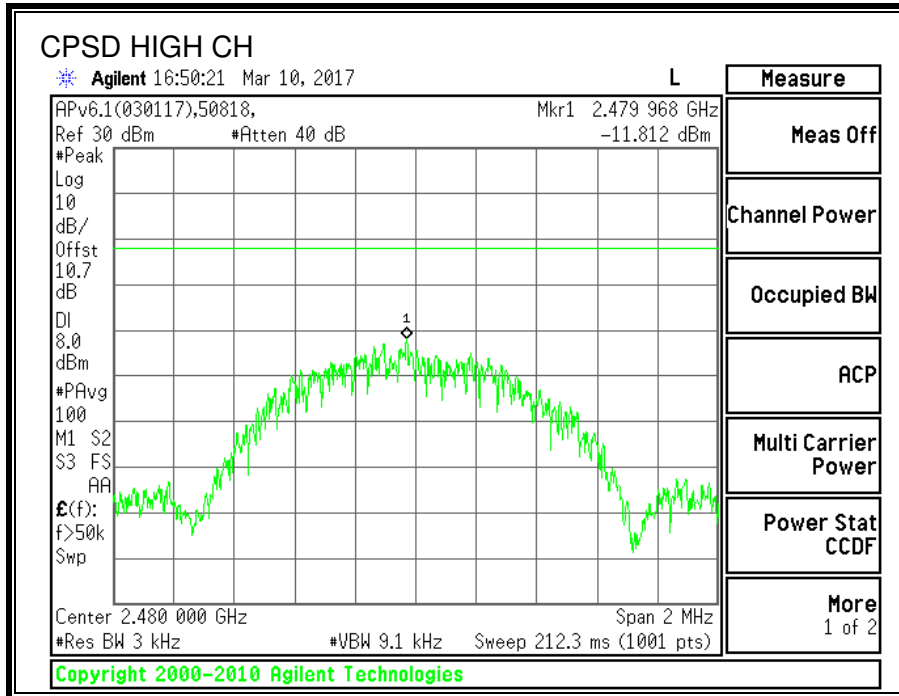

7.4.6. CONDUCTED BANDEDGE AND SPURIOUS EMISSIONS

LIMITS

FCC §15.247 (d)

IC RSS-247 (5.5)

Output power was measured based on the use of a peak measurement, therefore the required attenuation is 20 dB.

RESULTS

BANDEDGE

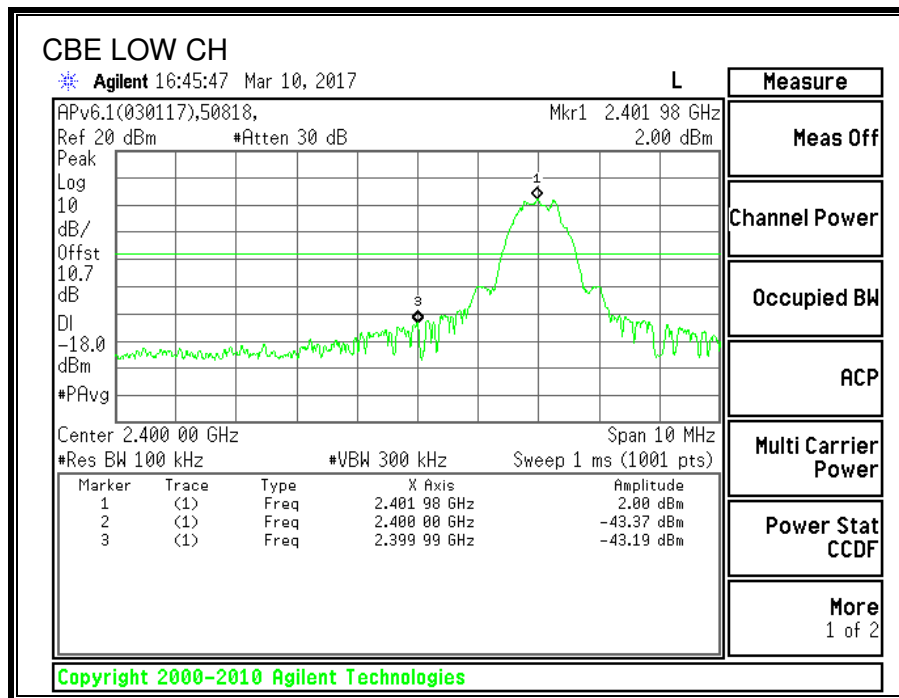

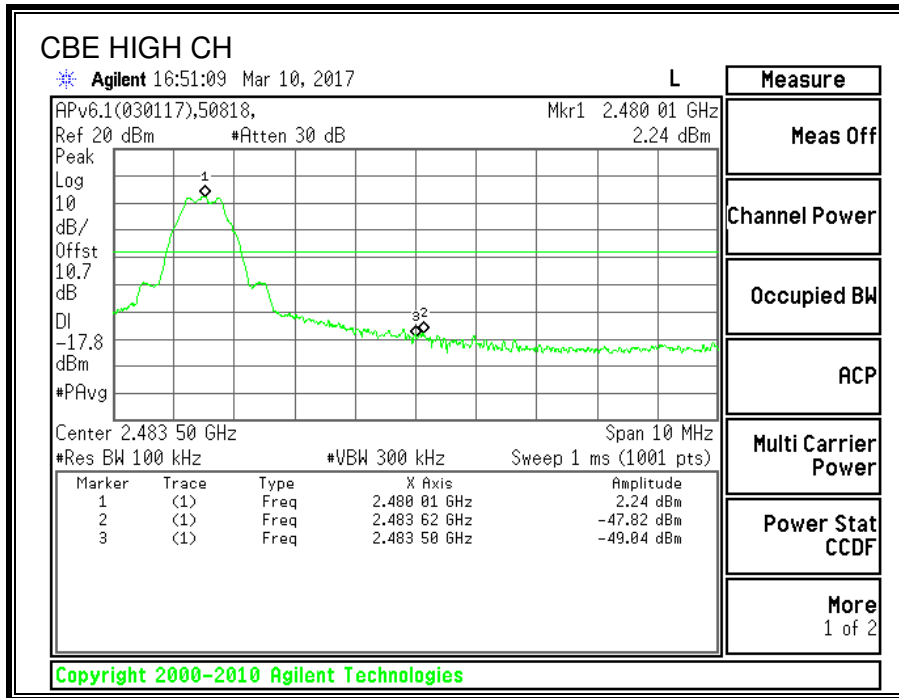
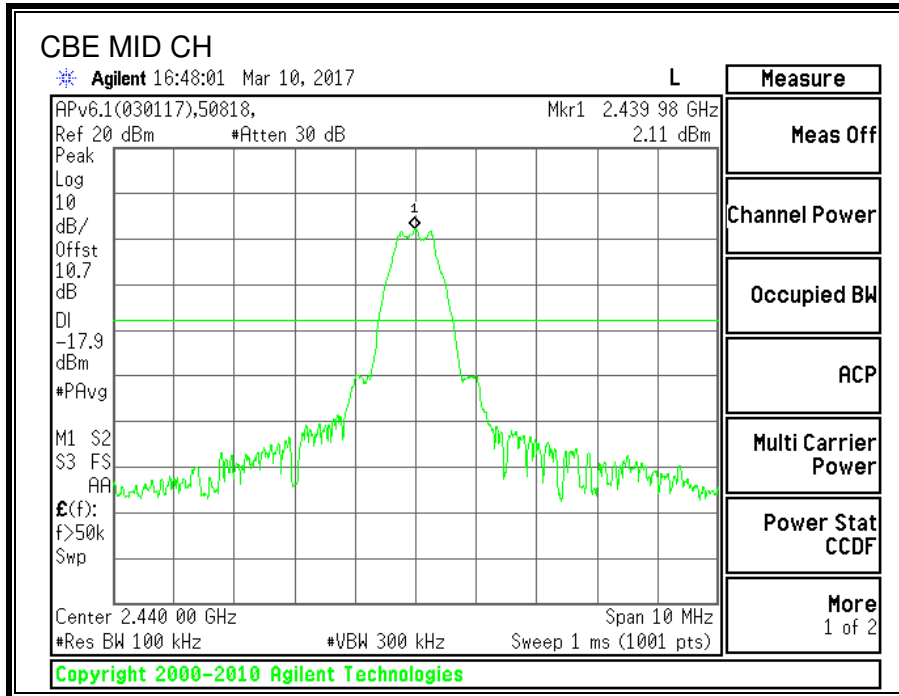

SPURIOUS EMISSIONS

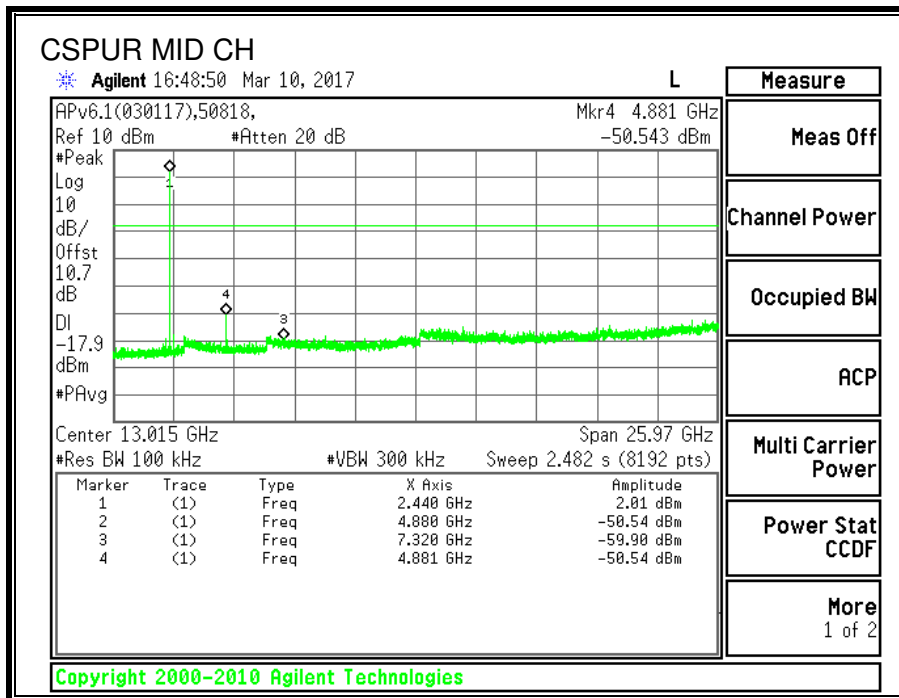
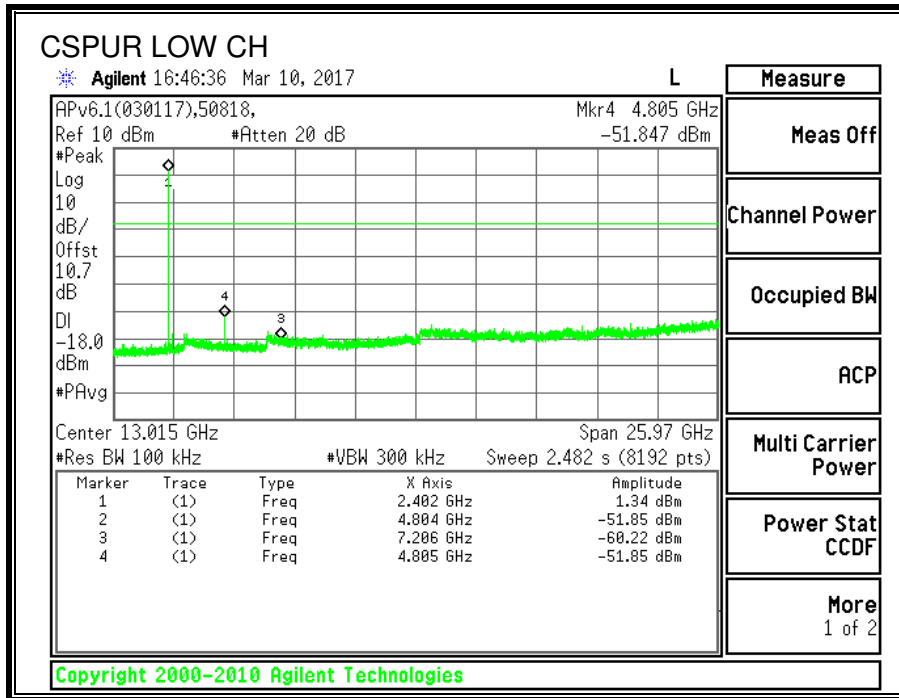

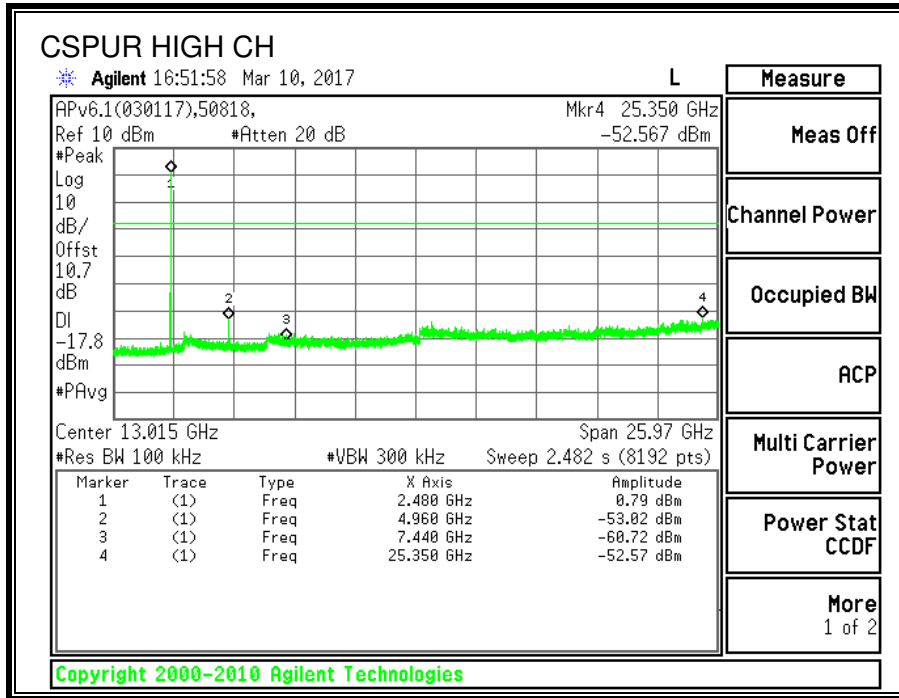

8. RADIATED TEST RESULTS

8.1. LIMITS AND PROCEDURE

LIMITS

FCC §15.205 and §15.209

IC RSS-GEN, Section 8.9 and 8.10.

Frequency Range (MHz)	Field Strength Limit (uV/m) at 3 m	Field Strength Limit (dBuV/m) at 3 m
30 - 88	100	40
88 - 216	150	43.5
216 - 960	200	46
Above 960	500	54

TEST PROCEDURE

The EUT is placed on a non-conducting table 80 cm above the ground plane for measurement below 1GHz; 1.5 m above the ground plane for measurement above 1GHz. The antenna to EUT distance is 3 meters. The EUT is configured in accordance with ANSI C63.10. The EUT is set to transmit in a continuous mode.

For measurements below 1 GHz the resolution bandwidth is set to 100 kHz for peak detection measurements or 120 kHz for quasi-peak detection measurements. Peak detection is used unless otherwise noted as quasi-peak.

For pre-scans above 1 GHz the resolution bandwidth is set to 1 MHz; the video bandwidth is set to 30 KHz for peak measurements.

For final measurements above 1 GHz the resolution bandwidth was set to 1 MHz; the video bandwidth is set to 3 MHz for peak measurements and as applicable for average measurements.

The spectrum from 30 MHz to 1GHz and 18GHz to 26 GHz is investigated with the transmitter set to transmit at the channel with highest output power as worst-case scenario. 1GHz to 18GHz was set to the lowest, middle, and highest channels in the 2.4 GHz band

The frequency range of interest is monitored at a fixed antenna height and EUT azimuth. The EUT is rotated through 360 degrees to maximize emissions received. The antenna is scanned from 1 to 4 meters above the ground plane to further maximize the emission. Measurements are made with the antenna polarized in both the vertical and the horizontal positions.

8.2. BLE

8.2.1. RESTRICTED BANDEGE (LOW CHANNEL)

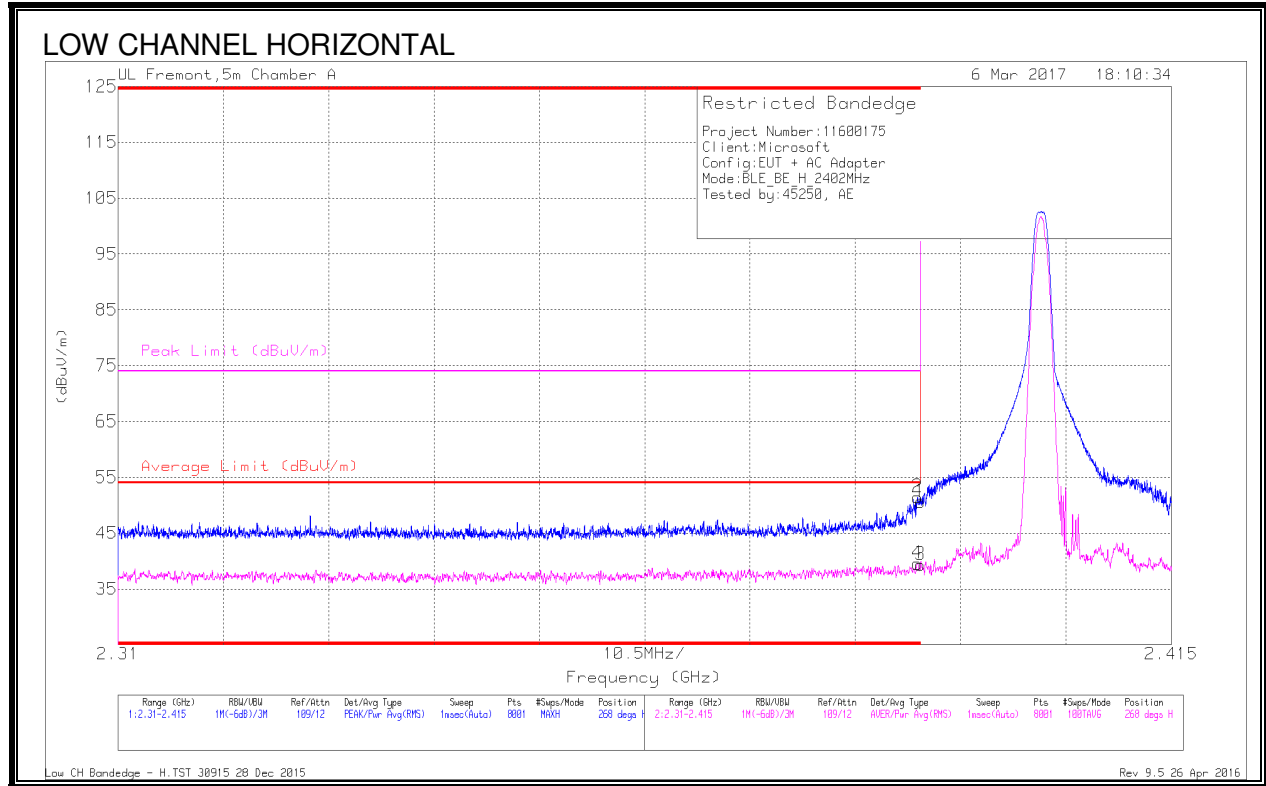

Marker	Frequency (GHz)	Meter Reading (dBuV)	Det	AF T711 (dBm)	Amp/Cbl/Filtr/Pad (dB)	DC Corr (dB)	Corrected Reading (dBuV/m)	Average Limit (dBuV/m)	Margin (dB)	Peak Limit (dBuV/m)	PK Margin (dB)	Azimuth (Degs)	Height (cm)	Polarity
1	* 2.39	42.24	Pk	32.1	-23.7	0	50.64	-	-	74	-23.36	268	166	H
2	* 2.39	43.04	Pk	32.1	-23.7	0	51.44	-	-	74	-22.56	268	166	H
3	* 2.39	28.86	RMS	32.1	-23.7	2.09	39.35	54	-14.65	-	-	268	166	H
4	* 2.39	29.05	RMS	32.1	-23.7	2.09	39.54	54	-14.46	-	-	268	166	H

* - indicates frequency in CFR47 Pt 15 / IC RSS-Restricted Band

Pk - Peak detector

RMS - RMS detection

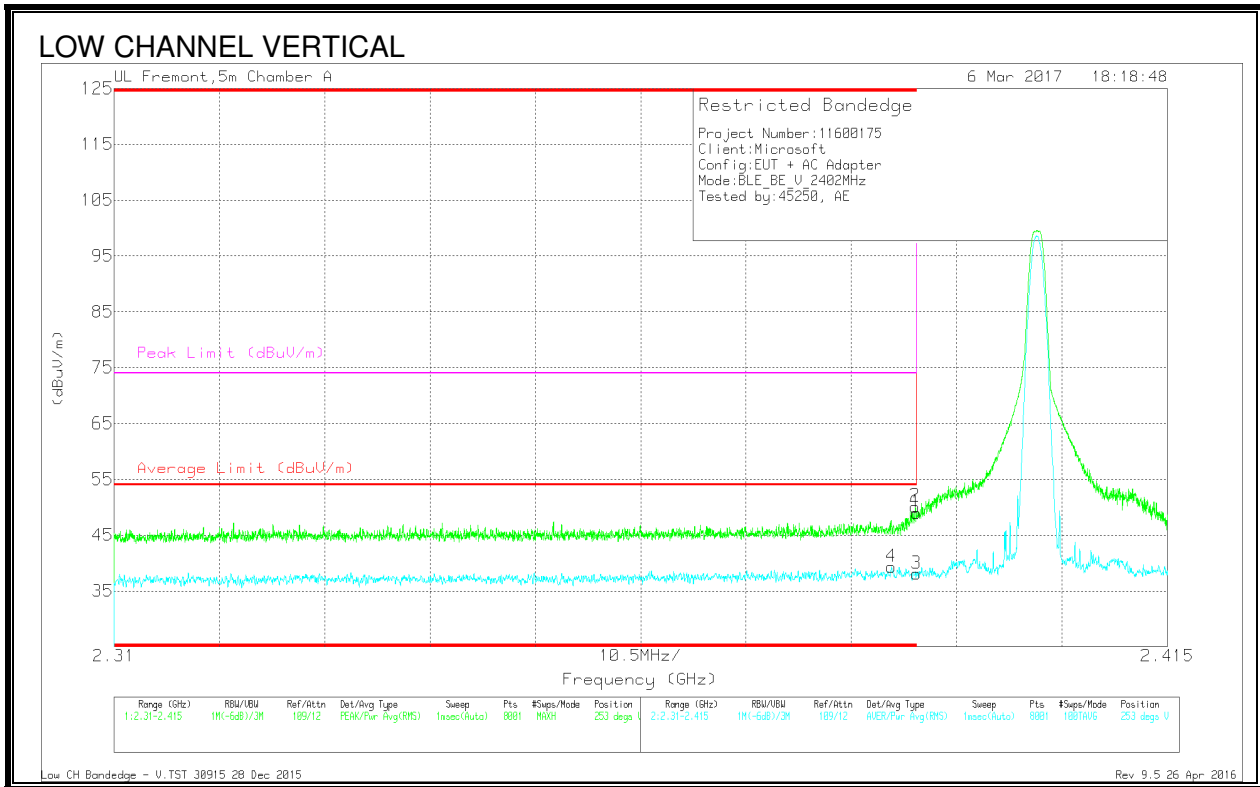

Marker	Frequency (GHz)	Meter Reading (dBuV)	Det	AF T711 (dBm)	Amp/Cbi/Fitr/Pad (dB)	DC Corr (dB)	Corrected Reading (dBuV/m)	Average Limit (dBuV/m)	Margin (dB)	Peak Limit (dBuV/m)	PK Margin (dB)	Azimuth (Degs)	Height (cm)	Polarity
4	* 2.387	28.83	RMS	32.1	-23.7	2.09	39.32	54	-14.68	-	-	253	107	V
1	* 2.39	40.64	Pk	32.1	-23.7	0	49.04	-	-	74	-24.96	253	107	V
2	* 2.39	41.73	Pk	32.1	-23.7	0	50.13	-	-	74	-23.87	253	107	V
3	* 2.39	27.61	RMS	32.1	-23.7	2.09	38.1	54	-15.9	-	-	253	107	V

* - indicates frequency in CFR47 Pt 15 / IC RSS-Restricted Band

Pk - Peak detector
 RMS - RMS detection

8.2.2. AUTHORIZED BANDEDGE (HIGH CHANNEL)

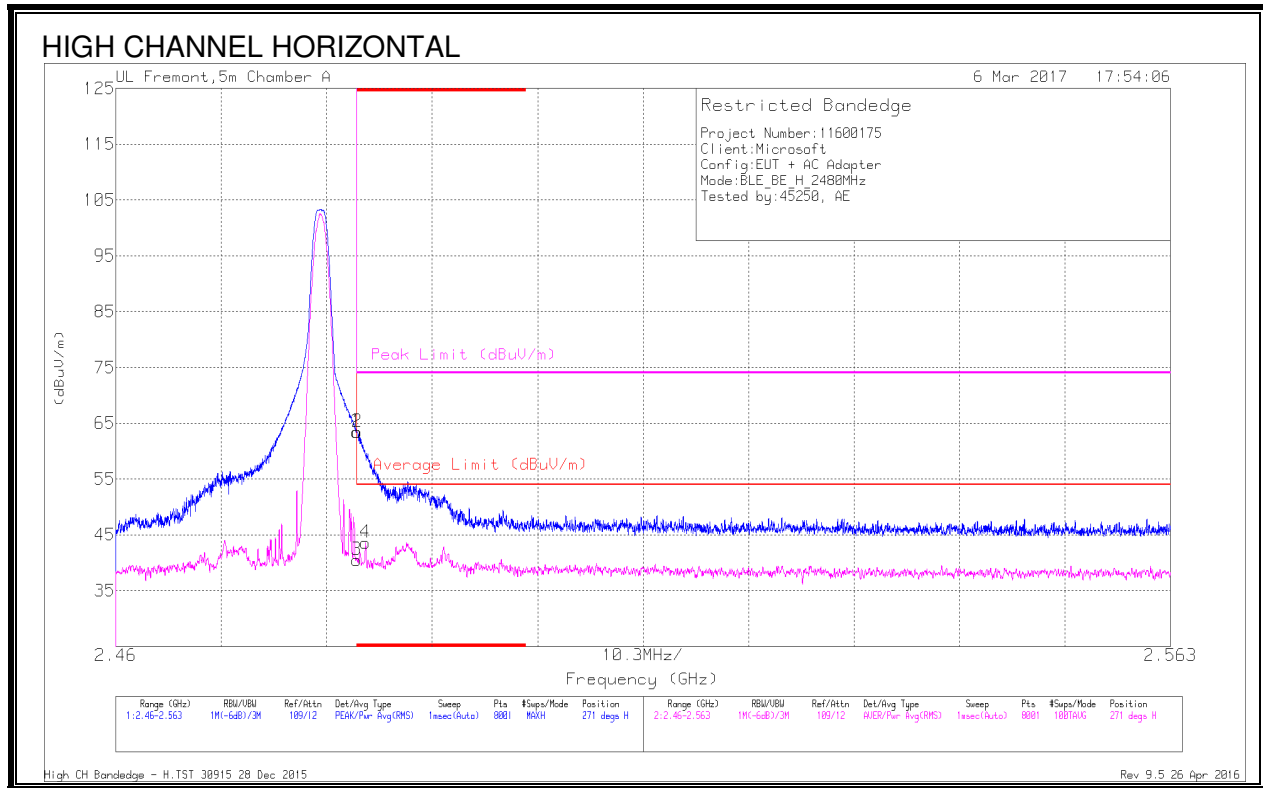

Marker	Frequency (GHz)	Meter Reading (dBuV)	Det	AF T711 (dBm)	Amp/Cb/Filtr/Pad (dB)	DC Corr (dB)	Corrected Reading (dBuV/m)	Average Limit (dBuV/m)	Margin (dB)	Peak Limit (dBuV/m)	PK Margin (dB)	Azimuth (Degs)	Height (cm)	Polarity
1	* 2.484	54.6	Pk	32.5	-23.6	0	63.5	-	-	74	-10.5	271	136	H
2	* 2.484	54.53	Pk	32.5	-23.6	0	63.43	-	-	74	-10.57	271	136	H
3	* 2.484	29.5	RMS	32.5	-23.6	2.09	40.49	54	-13.51	-	-	271	136	H
4	* 2.484	32.46	RMS	32.6	-23.6	2.09	43.55	54	-10.45	-	-	271	136	H

* - indicates frequency in CFR47 Pt 15 / IC RSS-Restricted Band

Pk - Peak detector

RMS - RMS detection

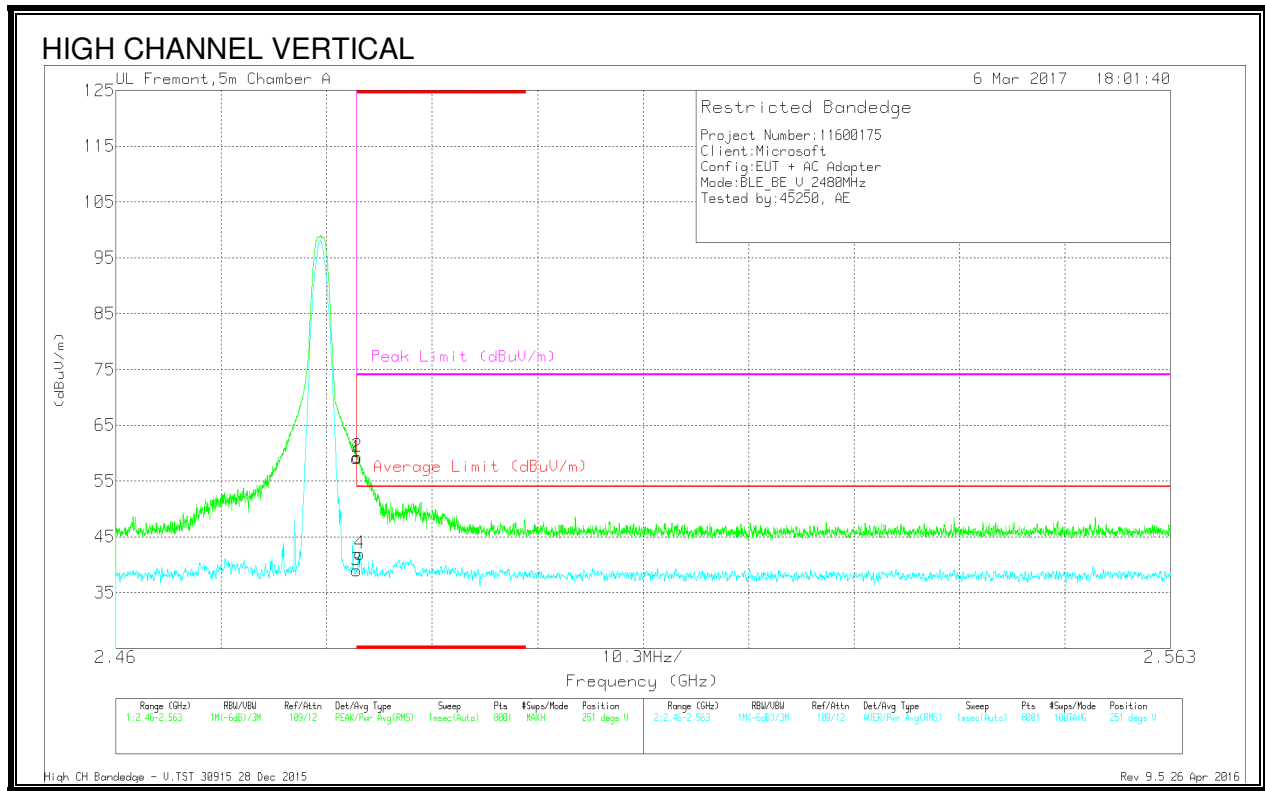

Marker	Frequency (GHz)	Meter Reading (dBuV)	Det	AF T711 (dBm)	Amp/Cb/Filt/Pd (dB)	DC Corr (dB)	Corrected Reading (dBuV/m)	Average Limit (dBuV/m)	Margin (dB)	Peak Limit (dBuV/m)	PK Margin (dB)	Azimuth (Degs)	Height (cm)	Polarity
1	* 2.484	50.25	Pk	32.5	-23.6	0	59.15	-	-	74	-14.85	251	103	V
2	* 2.484	50.41	Pk	32.5	-23.6	0	59.31	-	-	74	-14.69	251	103	V
3	* 2.484	27.97	RMS	32.5	-23.6	2.09	38.96	54	-15.04	-	-	251	103	V
4	* 2.484	30.99	RMS	32.5	-23.6	2.09	41.98	54	-12.02	-	-	251	103	V

* - indicates frequency in CFR47 Pt 15 / IC RSS-Restricted Band
 Pk - Peak detector
 RMS - RMS detection

8.2.3. HARMONICS AND SPURIOUS EMISSIONS

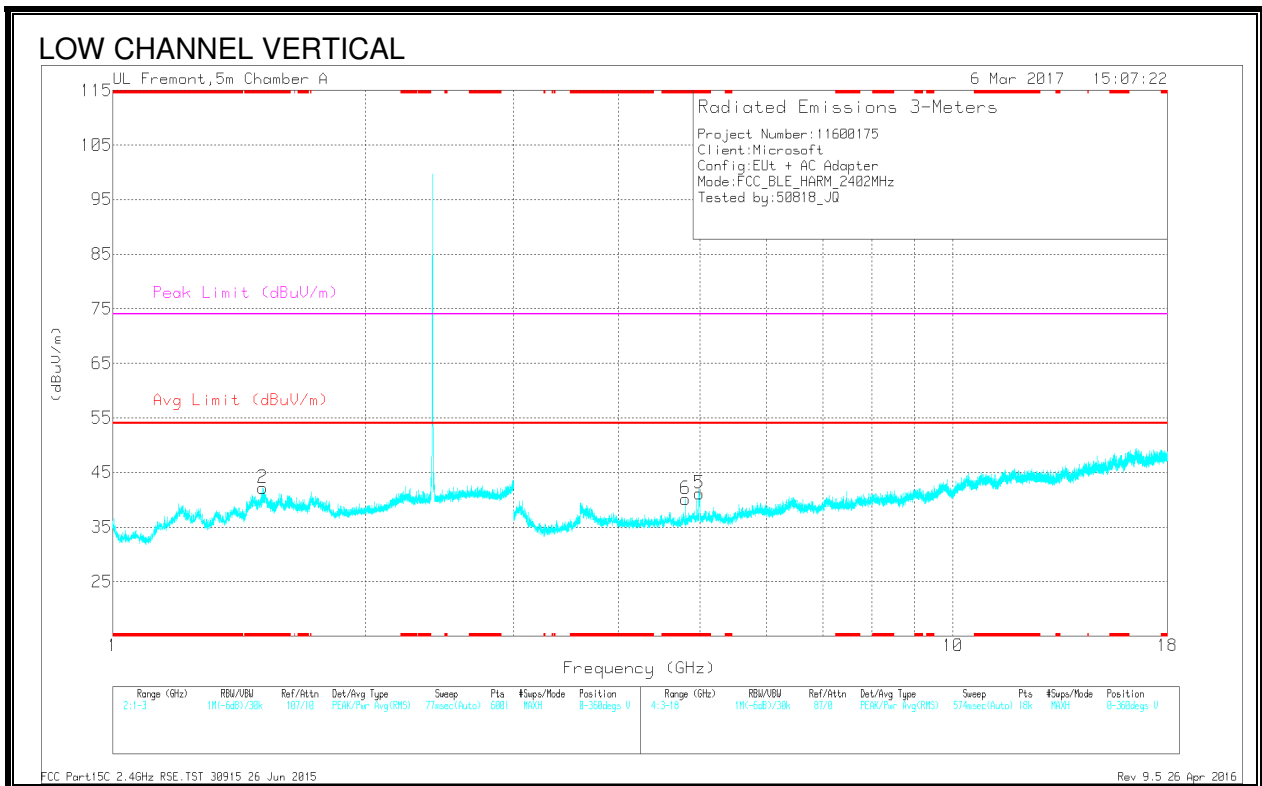
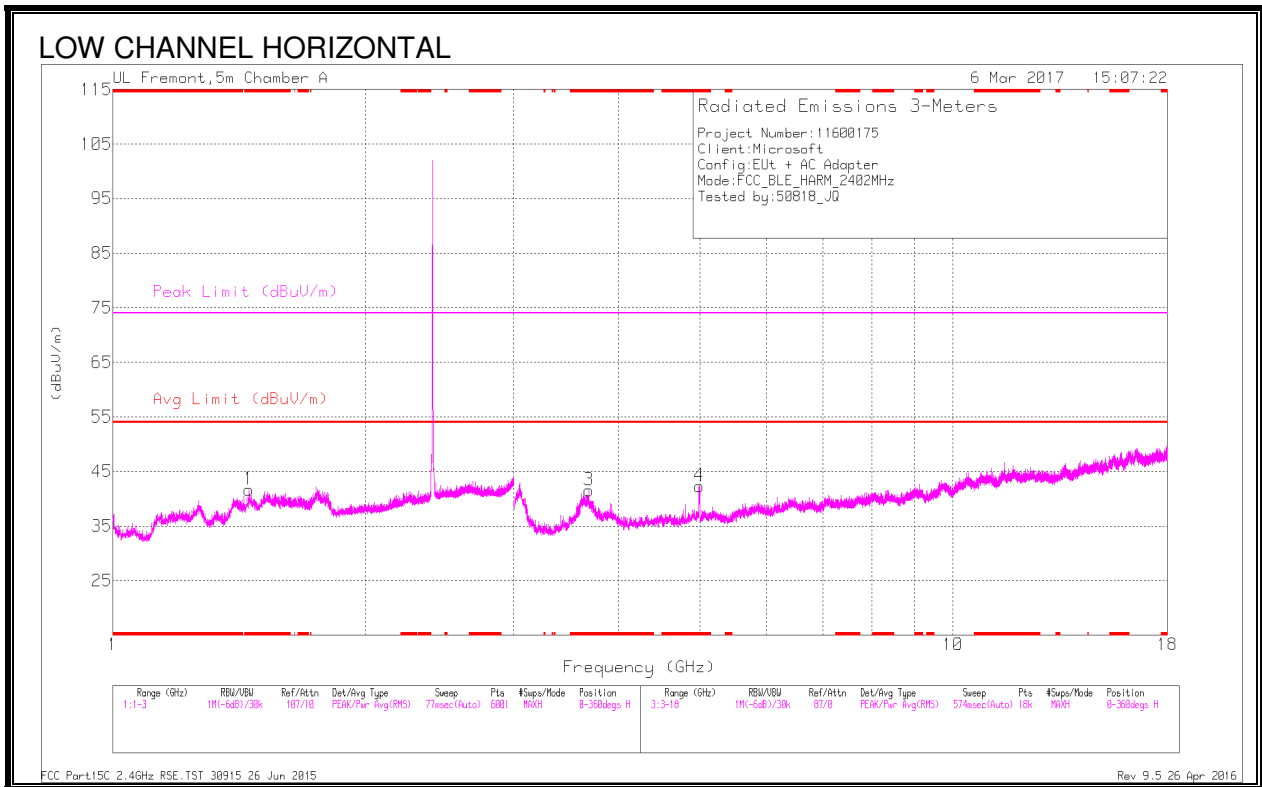

Marker	Frequency (GHz)	Meter Reading (dBuV)	Det	AF T711 (dB/m)	Amp/Cbl/Filtr/Pad (dB)	DC Corr (dB)	Corrected Reading (dBuV/m)	Avg Limit (dBuV/m)	Margin (dB)	Peak Limit (dBuV/m)	PK Margin (dB)	Azimuth (Degs)	Height (cm)	Polarity
1	* 1.455	43.05	PK2	28.6	-23.7	0	47.95	-	-	74	-26.05	233	192	H
	* 1.455	31.99	MAv1	28.6	-23.7	2.09	38.98	54	-15.02	-	-	233	192	H
2	* 1.511	43.38	PK2	28.1	-23.6	0	47.88	-	-	74	-26.12	258	254	V
	* 1.504	32.6	MAv1	28.1	-23.6	2.09	39.19	54	-14.81	-	-	258	254	V
3	* 3.686	45.25	PK2	33	-29.9	0	48.35	-	-	74	-25.65	89	268	H
	* 3.684	34.82	MAv1	33	-29.9	2.09	40.01	54	-13.99	-	-	89	268	H
4	* 5	44.2	PK2	34.1	-29.2	0	49.1	-	-	74	-24.9	300	140	H
	* 4.997	32.46	MAv1	34.1	-29.1	2.09	39.55	54	-14.45	-	-	300	140	H
5	* 4.986	43.35	PK2	34.1	-28.8	0	48.65	-	-	74	-25.35	254	101	V
	* 4.986	31.12	MAv1	34.1	-28.8	2.09	38.51	54	-15.49	-	-	254	101	V
6	* 4.804	40.57	PK2	34	-28.5	0	46.07	-	-	74	-27.93	235	101	V
	* 4.804	31.67	MAv1	34	-28.6	2.09	39.16	54	-14.84	-	-	235	101	V

* - indicates frequency in CFR47 Pt 15 / IC RSS-Restricted Band
 PK2 - KDB558074 Method: Maximum Peak
 MAv1 - KDB558074 Option 1 Maximum RMS Average

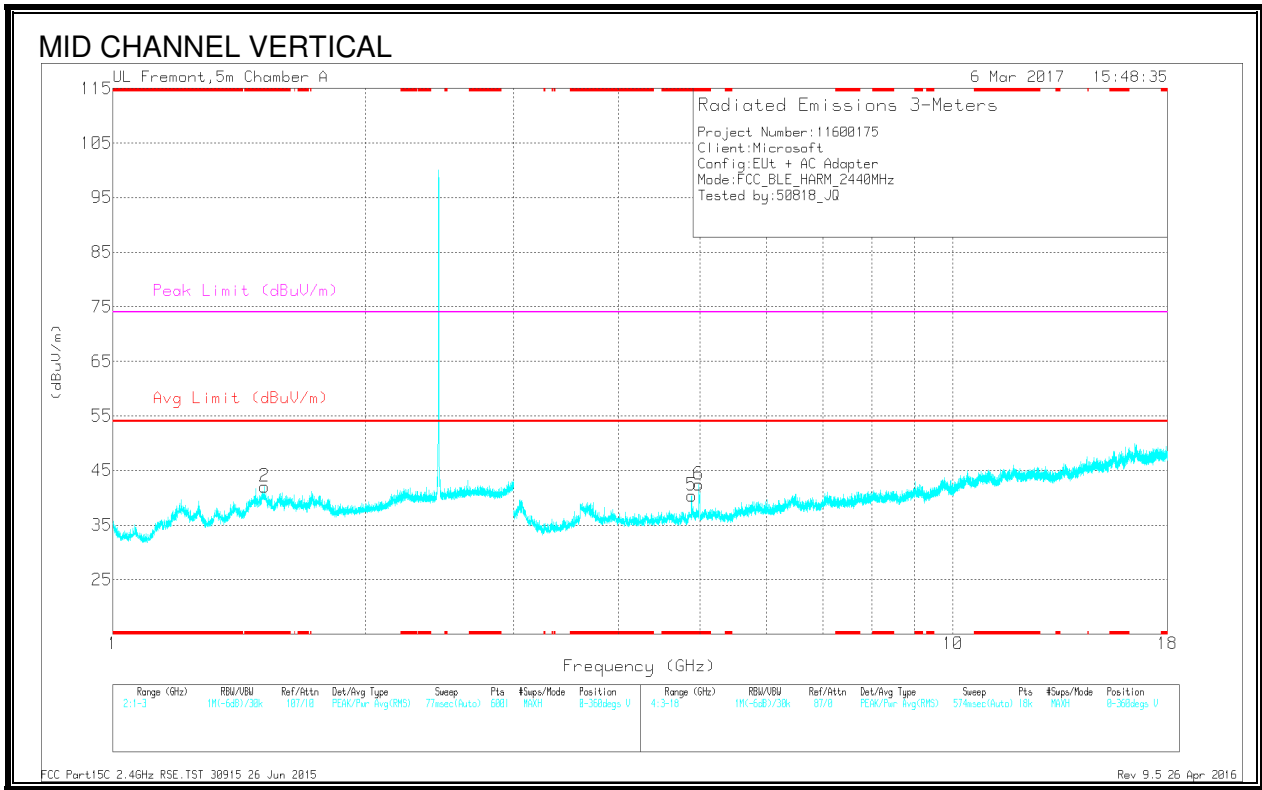
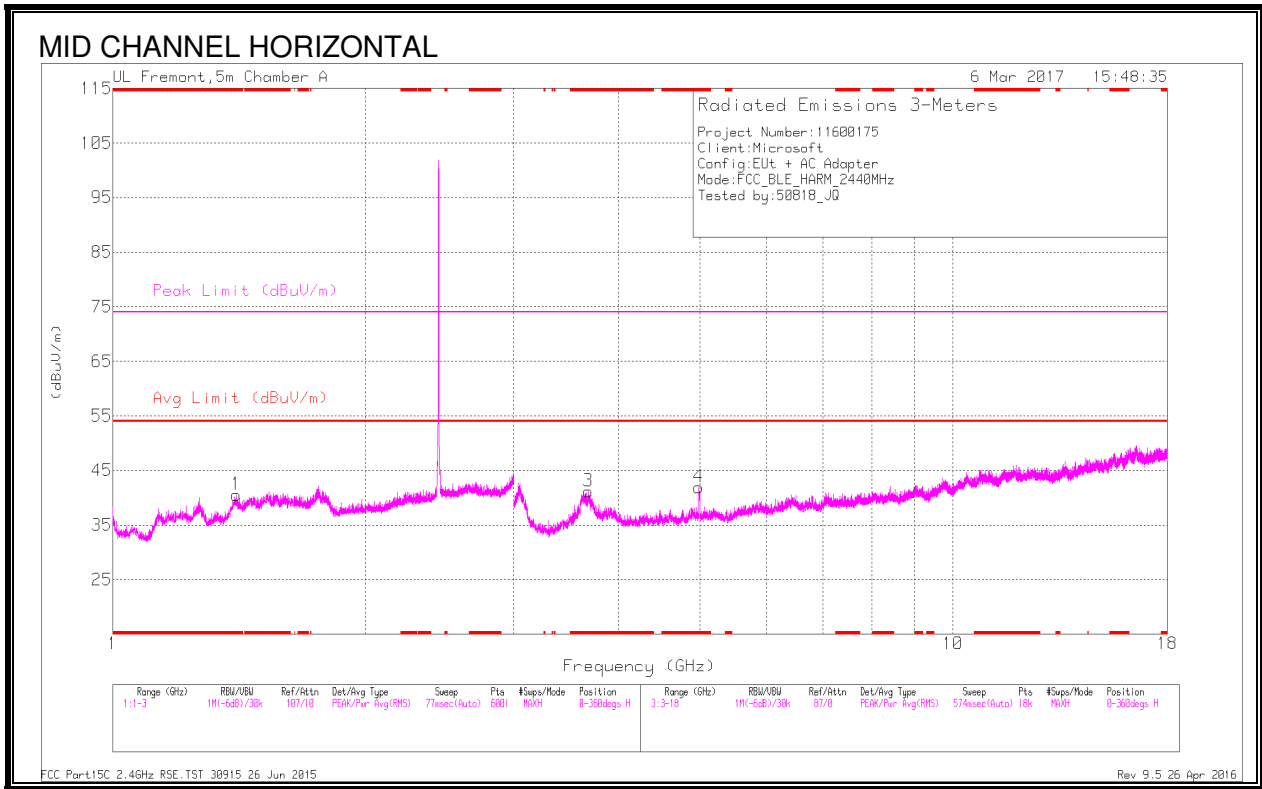

Marker	Frequency (GHz)	Meter Reading (dBuV)	Det	AF T711 (dB/m)	Amp/Cbl/Filtr/Pad (dB)	DC Corr (dB)	Corrected Reading (dBuV/m)	Avg Limit (dBuV/m)	Margin (dB)	Peak Limit (dBuV/m)	PK Margin (dB)	Azimuth (Degs)	Height (cm)	Polarity
1	* 1.4	41.77	PK2	29.2	-23.7	0	47.27	-	-	74	-26.73	95	194	H
	* 1.402	30.35	MAv1	29.2	-23.7	2.09	37.94	54	-16.06	-	-	95	194	H
2	* 1.518	45.36	PK2	28.1	-23.7	0	49.76	-	-	74	-24.24	265	188	V
	* 1.52	34.31	MAv1	28.1	-23.6	2.09	40.9	54	-13.1	-	-	265	188	V
3	* 3.683	45.4	PK2	33	-29.8	0	48.6	-	-	74	-25.4	85	260	H
	* 3.686	34.01	MAv1	33	-29.9	2.09	39.2	54	-14.8	-	-	85	260	H
4	* 4.988	43.89	PK2	34.1	-28.9	0	49.09	-	-	74	-24.91	300	146	H
	* 4.98	31.88	MAv1	34.1	-28.7	2.09	39.37	54	-14.63	-	-	300	146	H
5	* 4.884	39.7	PK2	34	-27.8	0	45.9	-	-	74	-28.1	235	101	V
	* 4.884	30.24	MAv1	34	-27.8	2.09	38.53	54	-15.47	-	-	235	101	V
6	* 4.986	43.85	PK2	34.1	-28.8	0	49.15	-	-	74	-24.85	257	140	V
	* 4.993	31.32	MAv1	34.1	-29	2.09	38.51	54	-15.49	-	-	257	140	V

* - indicates frequency in CFR47 Pt 15 / IC RSS-Restricted Band
 PK2 - KDB558074 Method: Maximum Peak
 MAv1 - KDB558074 Option 1 Maximum RMS Average

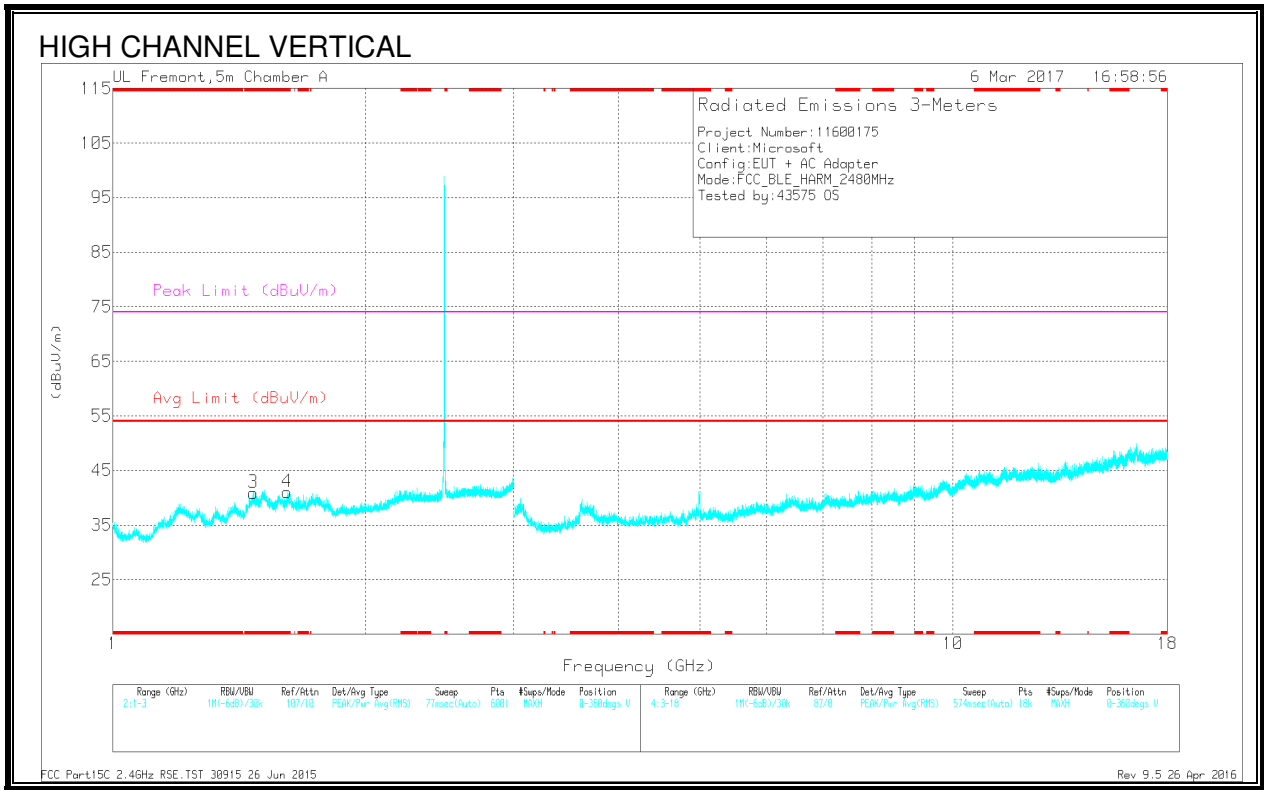
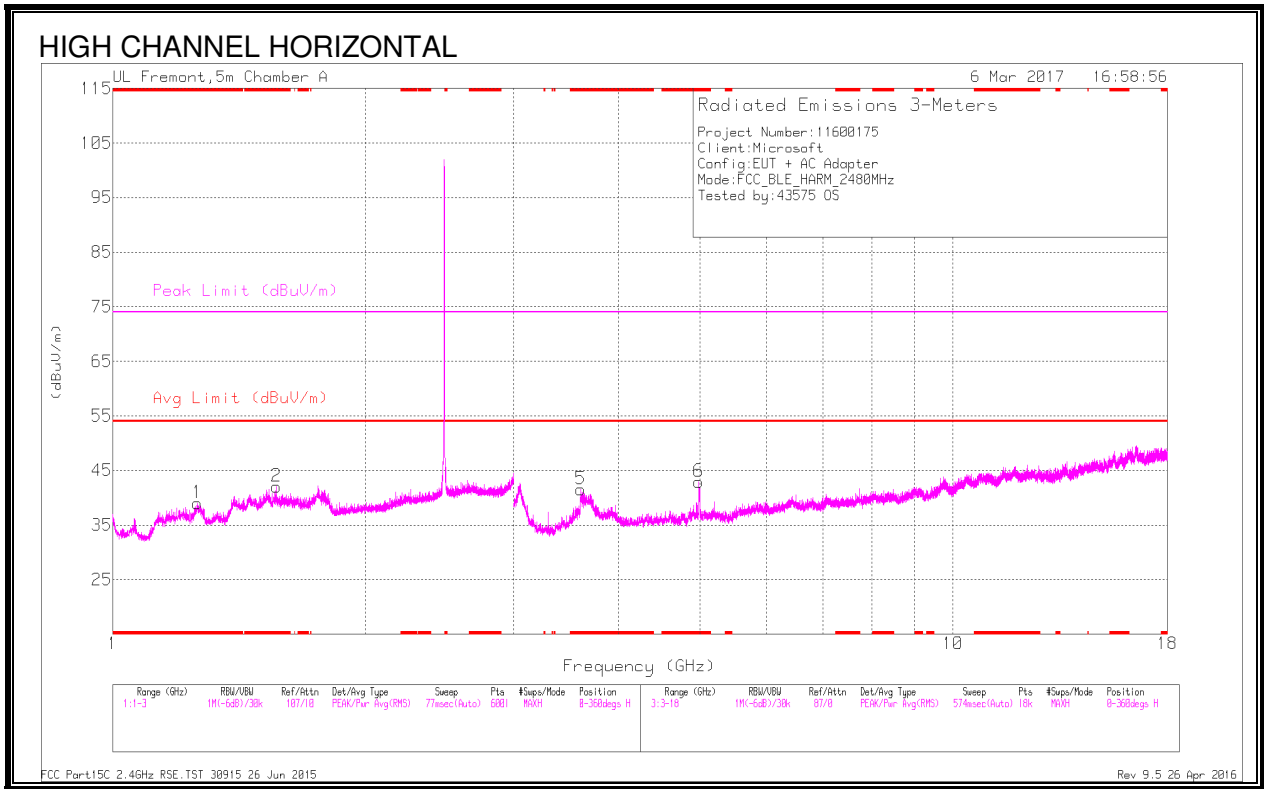

Marker	Frequency (GHz)	Meter Reading (dBuV)	Det	AF T711 (dB/m)	Amp/Cbl/Filtr/Pad (dB)	DC Corr (dB)	Corrected Reading (dBuV/m)	Avg Limit (dBuV/m)	Margin (dB)	Peak Limit (dBuV/m)	PK Margin (dB)	Azimuth (Degs)	Height (cm)	Polarity
1	* 1.26	41.23	PK2	29.2	-24	0	46.43	-	-	74	-27.57	236	161	H
	* 1.259	30.43	MAv1	29.2	-24	2.09	37.72	54	-16.28	-	-	236	161	H
2	* 1.568	43.49	PK2	28.2	-23.7	0	47.99	-	-	74	-26.01	236	201	H
	* 1.564	32.67	MAv1	28.2	-23.6	2.09	39.36	54	-14.64	-	-	236	201	H
3	* 1.469	43.41	PK2	28.5	-23.7	0	48.21	-	-	74	-25.79	267	264	V
	* 1.467	33.05	MAv1	28.5	-23.8	2.09	39.84	54	-14.16	-	-	267	264	V
4	* 1.611	43.34	PK2	28.3	-23.6	0	48.04	-	-	74	-25.96	274	301	V
	* 1.611	32.74	MAv1	28.3	-23.6	2.09	39.53	54	-14.47	-	-	274	301	V
5	* 3.607	45.5	PK2	33.1	-30.7	0	47.9	-	-	74	-26.1	89	257	H
	* 3.609	35.53	MAv1	33.1	-30.6	2.09	40.12	54	-13.88	-	-	89	257	H
6	* 4.984	43.56	PK2	34.1	-28.7	0	48.96	-	-	74	-25.04	303	143	H
	* 4.984	30.95	MAv1	34.1	-28.7	2.09	38.44	54	-15.56	-	-	303	143	H

* - indicates frequency in CFR47 Pt 15 / IC RSS-Restricted Band
 PK2 - KDB558074 Method: Maximum Peak
 MAv1 - KDB558074 Option 1 Maximum RMS Average

8.3. WORST-CASE BELOW 1 GHz

SPURIOUS EMISSIONS 30 TO 1000 MHz (WORST-CASE CONFIGURATION)

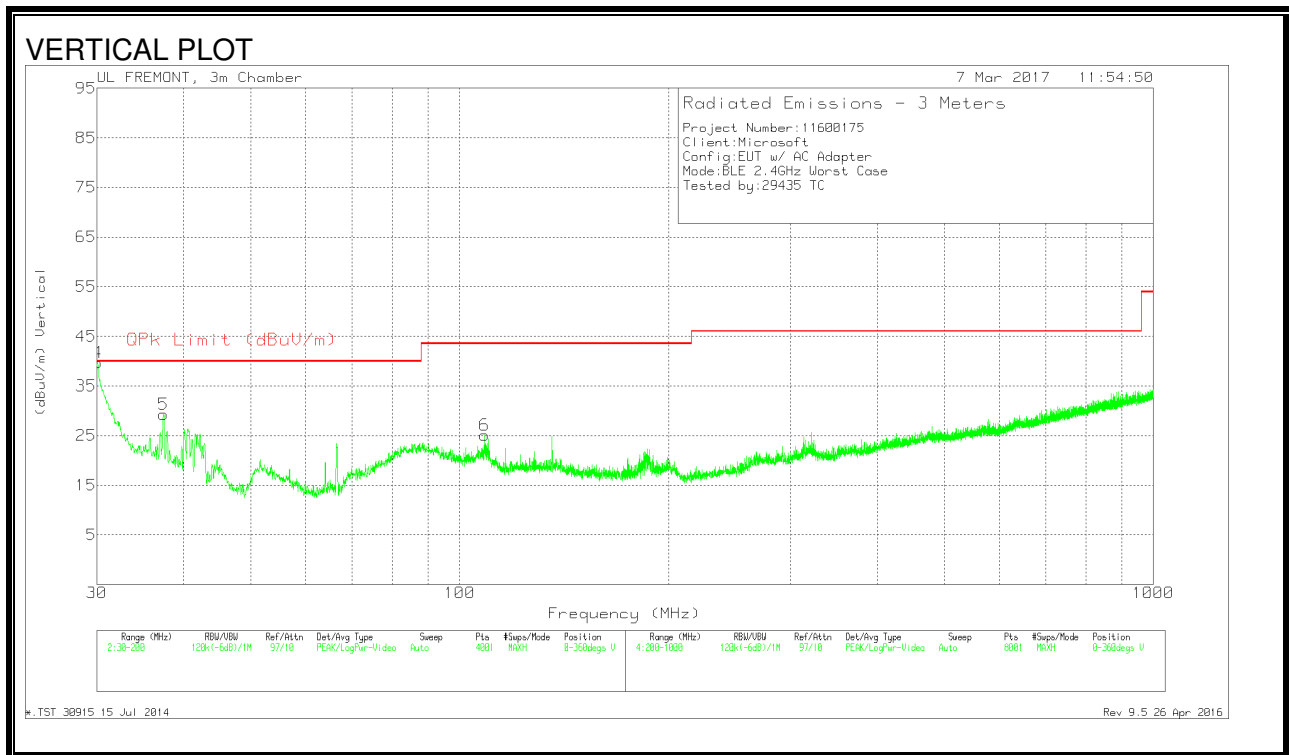
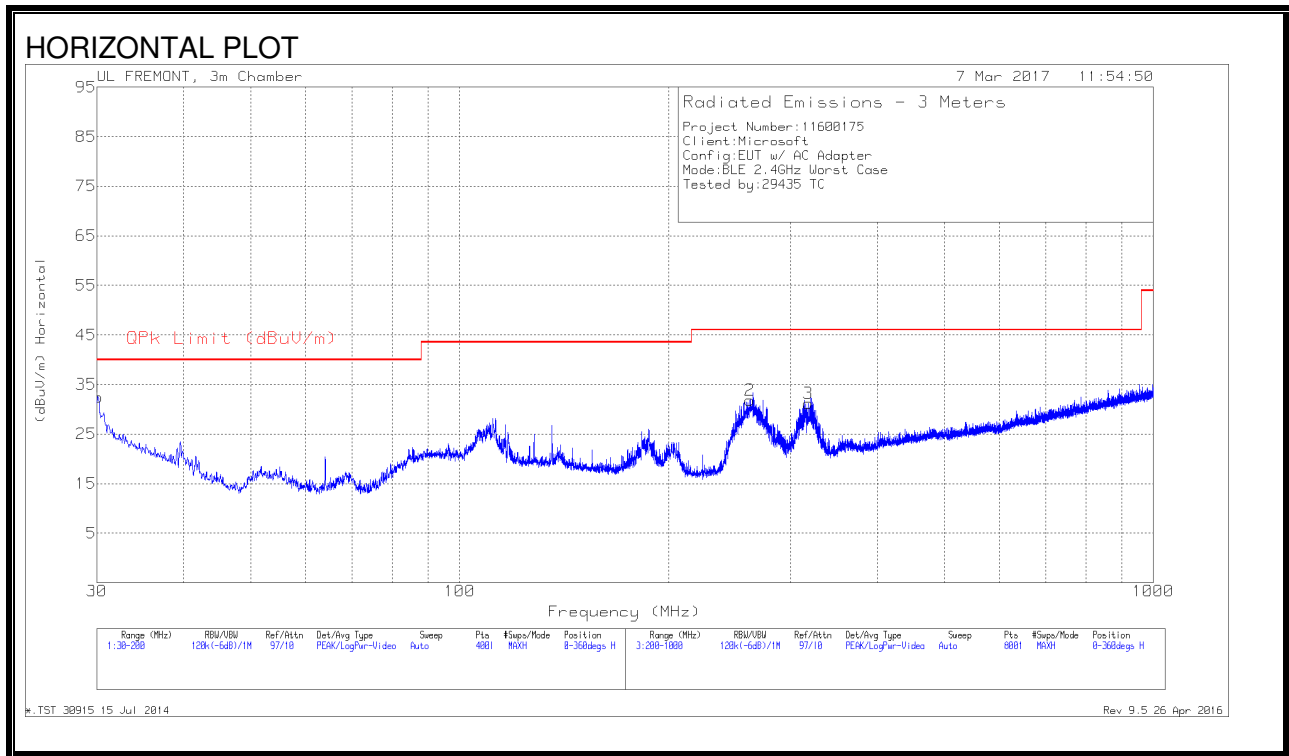

DATA

Marker	Frequency (MHz)	Meter Reading (dBuV)	Det	AF T408 (dB/m)	Amp/Cbl (dB)	Corrected Reading (dBuV/m)	QPk Limit (dBuV/m)	Margin (dB)	Azimuth (Degs)	Height (cm)	Polarity
4	30.0989	29.41	Qp	25.3	-27.3	27.41	40	-12.59	217	196	V
1	30.1275	34.5	Pk	25.3	-27.3	32.5	40	-7.5	0-360	100	H
5	37.4375	36.59	Pk	19.9	-27.2	29.29	40	-10.71	0-360	100	V
6	108.5825	34.99	Pk	16.3	-26.2	25.09	43.52	-18.43	0-360	100	V
2	261.8	39.87	Pk	16.3	-24.4	31.77	46.02	-14.25	0-360	100	H
3	318	37.44	Pk	17.9	-24.2	31.14	46.02	-14.88	0-360	100	H

Qp - Quasi-Peak detector

Pk - Peak detector

8.4. WORST-CASE ABOVE 18 GHz

SPURIOUS EMISSIONS 18 TO 26 GHz (WORST-CASE CONFIGURATION)

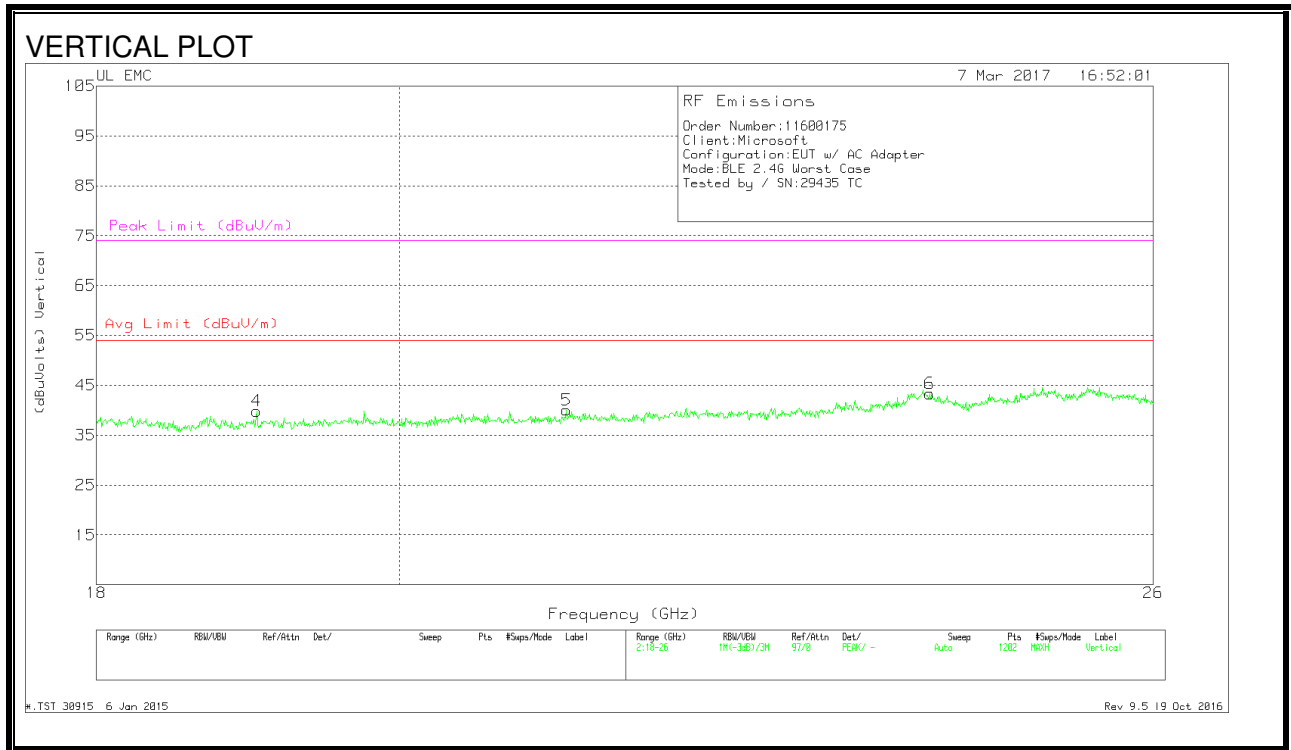
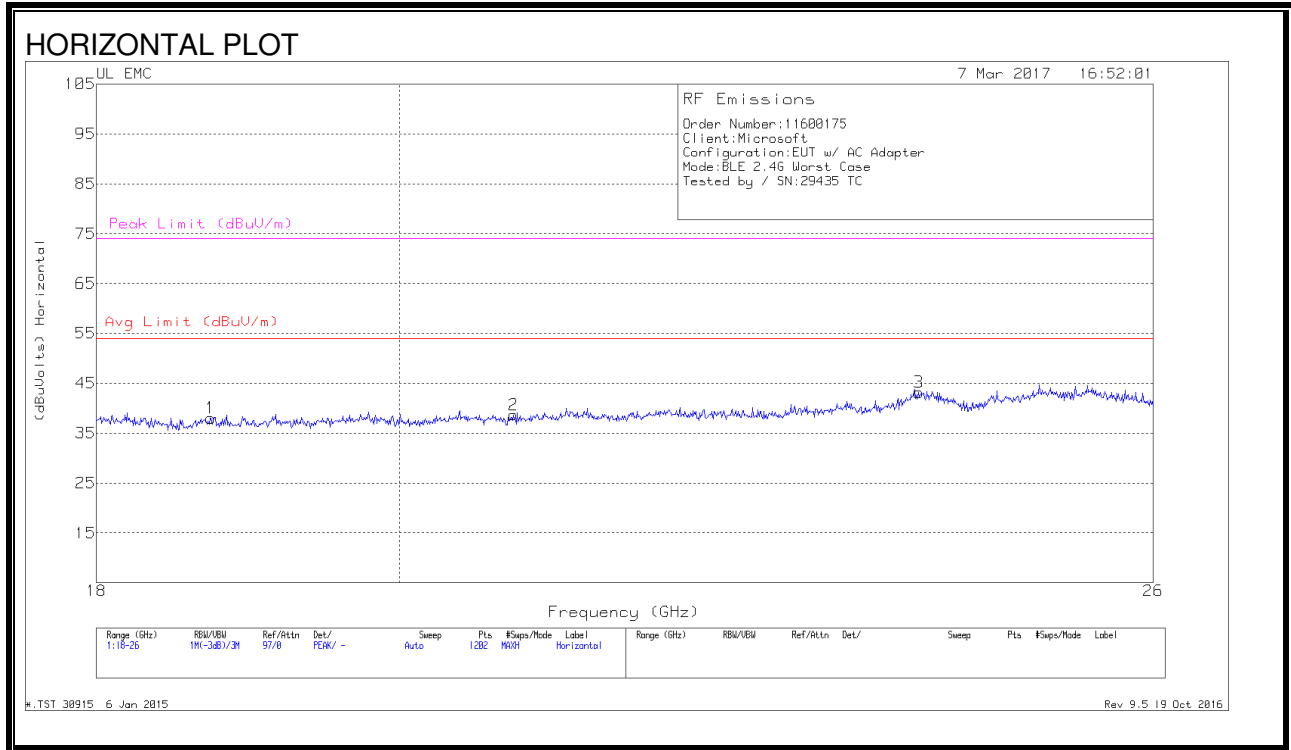

Data

Marker	Frequency (GHz)	Meter Reading (dBuV)	Det	AF T449 (dB/m)	Amp/Cbl (dB)	Dist Corr (dB)	Corrected Reading (dBuVolts)	Avg Limit (dBuV/m)	Margin (dB)	Peak Limit (dBuV/m)	PK Margin (dB)
1	18.729	39.8	Pk	32.4	-24.7	-9.5	38	54	-16	74	-36
2	20.811	40.47	Pk	33	-25.3	-9.5	38.67	54	-15.33	74	-35.33
3	23.962	42.87	Pk	34	-24.2	-9.5	43.17	54	-10.83	74	-30.83
4	19.032	41.53	Pk	32.6	-24.8	-9.5	39.83	54	-14.17	74	-34.17
5	21.197	41.2	Pk	33.1	-24.8	-9.5	40	54	-14	74	-34
6	24.055	43.23	Pk	34	-24.4	-9.5	43.33	54	-10.67	74	-30.67

Pk - Peak detector

8.5. AC POWER LINE CONDUCTED EMISSIONS

LIMITS

FCC §15.207 (a)

RSS-Gen 8.8

Frequency of Emission (MHz)	Conducted Limit (dB μ V)	
	Quasi-peak	Average
0.15-0.5	66 to 56 *	56 to 46 *
0.5-5	56	46
5-30	60	50

*Decreases with the logarithm of the frequency.

TEST PROCEDURE

The EUT is placed on a non-conducting table 40 cm from the vertical ground plane and 80 cm above the horizontal ground plane. The EUT is configured in accordance with ANSI C63.10.

The receiver is set to a resolution bandwidth of 9 kHz. Peak detection is used unless otherwise noted as quasi-peak or average.

Line conducted data is recorded for both NEUTRAL and HOT lines.

LINE 1 RESULTS

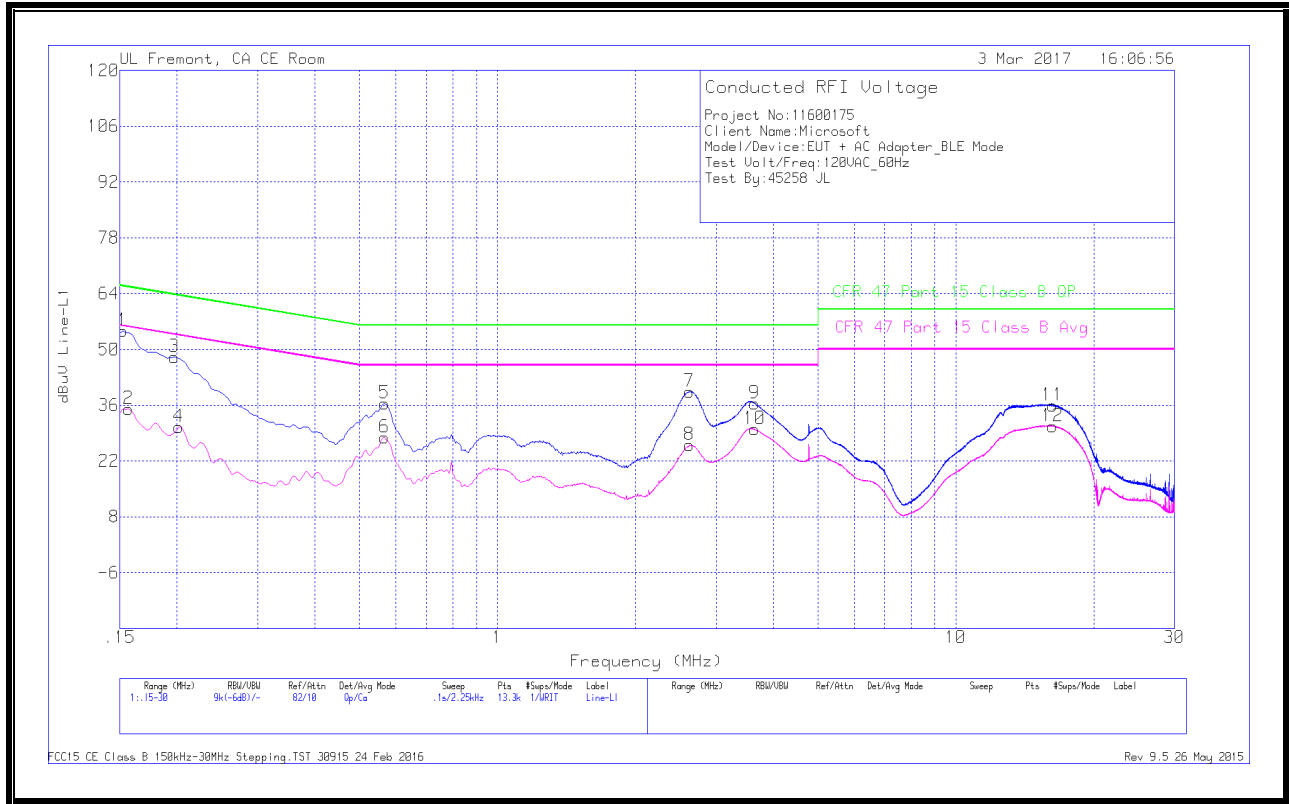

Marker	Frequency (MHz)	Meter Reading (dBuV)	Det	LISN L1	LC Cables C1&C3	Limiter (dB)	Corrected Reading dBuV	CFR 47 Part 15 Class B QP	QP Margin (dB)	CFR 47 Part 15 Class B Avg	Av(CISPR) Margin (dB)
1	.15225	44.33	Qp	.1	.1	10.1	54.63	65.88	-11.25	-	-
2	.15675	24.88	Ca	0	.1	10.1	35.08	-	-	55.63	-20.55
3	.19725	37.85	Qp	0	.1	10.1	48.05	63.73	-15.68	-	-
4	.20175	20.3	Ca	0	.1	10.1	30.5	-	-	53.54	-23.04
5	.56625	26.17	Qp	0	.1	10.1	36.37	56	-19.63	-	-
6	.56625	17.65	Ca	0	.1	10.1	27.85	-	-	46	-18.15
7	2.6205	29.25	Qp	0	.1	10.1	39.45	56	-16.55	-	-
8	2.625	15.74	Ca	0	.1	10.1	25.94	-	-	46	-20.06
9	3.64313	26.31	Qp	0	.1	10.1	36.51	56	-19.49	-	-
10	3.64425	19.79	Ca	0	.1	10.1	29.99	-	-	46	-16.01
11	16.25775	25.45	Qp	0	.2	10.3	35.95	60	-24.05	-	-
12	16.2735	20.26	Ca	0	.2	10.3	30.76	-	-	50	-19.24

LINE 2 RESULTS

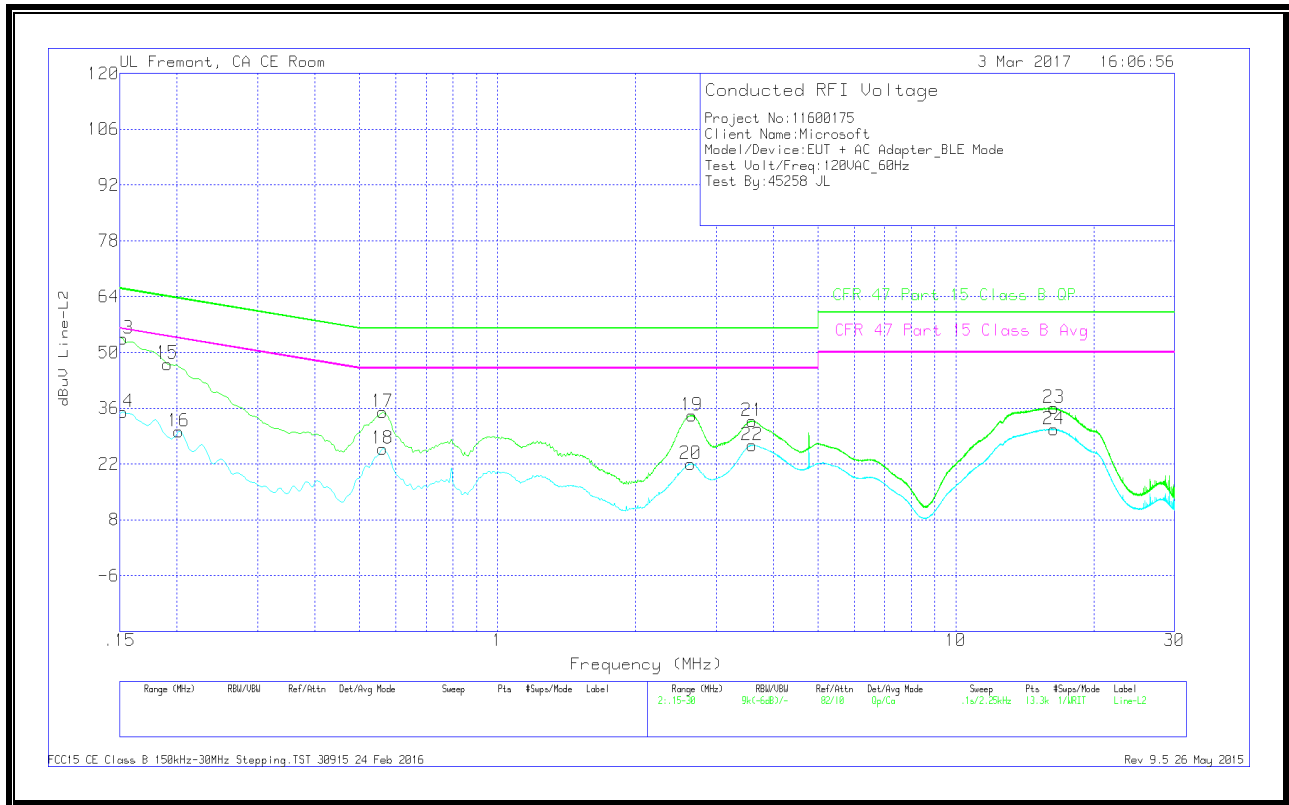

Marker	Frequency (MHz)	Meter Reading (dBuV)	Det	LISN L2	LC Cables C2&C3	Limiter (dB)	Corrected Reading dBuV	CFR 47 Part 15 Class B QP	QP Margin (dB)	CFR 47 Part 15 Class B Avg	Av(CISPR) Margin (dB)
13	.15225	43.31	Qp	0	0	10.1	53.41	65.88	-12.47	-	-
14	.15225	24.96	Ca	0	0	10.1	35.06	-	-	55.88	-20.82
15	.1905	36.93	Qp	0	.1	10.1	47.13	64.01	-16.88	-	-
16	.20175	19.92	Ca	0	.1	10.1	30.12	-	-	53.54	-23.42
17	.56175	24.83	Qp	0	.1	10.1	35.03	56	-20.97	-	-
18	.56175	15.61	Ca	0	.1	10.1	25.81	-	-	46	-20.19
19	2.65875	24.04	Qp	0	.1	10.1	34.24	56	-21.76	-	-
20	2.64075	11.87	Ca	0	.1	10.1	22.07	-	-	46	-23.93
21	3.597	22.6	Qp	0	.1	10.1	32.8	56	-23.2	-	-
22	3.59925	16.57	Ca	0	.1	10.1	26.77	-	-	46	-19.23
23	16.38375	25.52	Qp	0	.2	10.3	36.02	60	-23.98	-	-
24	16.3815	20.25	Ca	0	.2	10.3	30.75	-	-	50	-19.25