

FCC Test Report (WLAN)

Report No.: RF150803E06-1

FCC ID: C3K1682

Test Model: 1682

Received Date: Aug. 03, 2015

Test Date: Sep. 16 to Oct. 08, 2015

Issued Date: Nov. 11, 2015

Applicant: Microsoft Corporation

Address: One Microsoft Way Redmond WA 98052

Issued By: Bureau Veritas Consumer Products Services (H.K.) Ltd., Taoyuan Branch
Hsin Chu Laboratory

Lab Address: No. 81-1, Lu Liao Keng, 9th Ling, Wu Lung Tsuen, Chiung Lin Hsiang, Hsin
Chu Hsien 307, Taiwan R.O.C.

Test Location (1): No. 81-1, Lu Liao Keng, 9th Ling, Wu Lung Tsuen, Chiung Lin Hsiang, Hsin
Chu Hsien 307, Taiwan R.O.C.

Test Location (2): No. 49, Ln. 206, Wende Rd., Shangshan Tsuen, Chiung Lin Hsiang, Hsin
Chu Hsien 307, Taiwan R.O.C.

Test Location (3): E-2, No.1, Li Hsin 1st Road, Hsinchu Science Park, Hsinchu City 300,
Taiwan R.O.C.



This report is for your exclusive use. Any copying or replication of this report to or for any other person or entity, or use of our name or trademark, is permitted only with our prior written permission. This report sets forth our findings solely with respect to the test samples identified herein. The results set forth in this report are not indicative or representative of the quality or characteristics of the lot from which a test sample was taken or any similar or identical product unless specifically and expressly noted. Our report includes all of the tests requested by you and the results thereof based upon the information that you provided to us. You have 60 days from date of issuance of this report to notify us of any material error or omission caused by our negligence, provided, however, that such notice shall be in writing and shall specifically address the issue you wish to raise. A failure to raise such issue within the prescribed time shall constitute your unqualified acceptance of the completeness of this report, the tests conducted and the correctness of the report contents. Unless specific mention, the uncertainty of measurement has been explicitly taken into account to declare the compliance or non-compliance to the specification. The report must not be used by the client to claim product certification, approval, or endorsement by TAF or any government agencies.

Table of Contents

Release Control Record **4**

1 Certificate of Conformity **5**

2 Summary of Test Results **6**

 2.1 Measurement Uncertainty 6

 2.2 Modification Record 6

3 General Information **7**

 3.1 General Description of EUT (WLAN) 7

 3.2 Description of Test Modes 9

 3.2.1 Test Mode Applicability and Tested Channel Detail 10

 3.3 Duty Cycle of Test Signal 12

 3.4 Description of Support Units 13

 3.4.1 Configuration of System under Test 13

 3.5 General Description of Applied Standard 14

4 Test Types and Results **15**

 4.1 Radiated Emission and Bandedge Measurement 15

 4.1.1 Limits of Radiated Emission and Bandedge Measurement 15

 4.1.2 Test Instruments 16

 4.1.3 Test Procedure 18

 4.1.4 Deviation from Test Standard 18

 4.1.5 Test Setup 19

 4.1.6 EUT Operating Condition 19

 4.1.7 Test Results (Bandedge) 20

 4.1.8 Test Results (Spurious emission) 32

 4.2 Conducted Emission Measurement 39

 4.2.1 Limits of Conducted Emission Measurement 39

 4.2.2 Test Instruments 39

 4.2.3 Test Procedure 40

 4.2.4 Deviation from Test Standard 40

 4.2.5 Test Setup 40

 4.2.6 EUT Operating Condition 40

 4.2.7 Test Results 41

 4.3 Transmit Power Measurement 43

 4.3.1 Limits of Transmit Power Measurement 43

 4.3.2 Test Setup 43

 4.3.3 Test Instruments 43

 4.3.4 Test Procedure 43

 4.3.5 Deviation from Test Standard 44

 4.3.6 EUT Operating Condition 44

 4.3.7 Test Result 44

 4.4 Peak Power Spectral Density Measurement 45

 4.4.1 Limits of Peak Power Spectral Density Measurement 45

 4.4.2 Test Setup 45

 4.4.3 Test Instruments 45

 4.4.4 Test Procedure 45

 4.4.5 Deviation from Test Standard 46

 4.4.6 EUT Operating Condition 46

 4.4.7 Test Results 47

 4.5 Frequency Stability Measurement 49

 4.5.1 Limits of Frequency Stability Measurement 49

 4.5.2 Test Setup 49

 4.5.3 Test Instruments 49

 4.5.4 Test Procedure 49

 4.5.5 Deviation from Test Standard 49



4.5.6 EUT Operating Condition	49
4.5.7 Test Results	50
4.6 6dB Bandwidth Measurement	51
4.6.1 Limits of 6dB Bandwidth Measurement	51
4.6.2 Test Setup	51
4.6.3 Test Instruments	51
4.6.4 Test Procedure	51
4.6.5 Deviation from Test Standard	51
4.6.6 EUT Operating Condition	51
4.6.7 Test Results	52
5 Pictures of Test Arrangements	53
Appendix – Information on the Testing Laboratories	54



A D T

Release Control Record

Issue No.	Description	Date Issued
RF150803E06-1	Original release.	Nov. 11, 2015



1 Certificate of Conformity

Product: dual-band wireless accessory radio
Brand: Microsoft
Test Model: 1682
Sample Status: ENGINEERING SAMPLE
Applicant: Microsoft Corporation
Test Date: Sep. 16 to Oct. 08, 2015
Standard: 47 CFR FCC Part 15, Subpart E (Section 15.407)
ANSI C63.10: 2013

The above equipment has been tested by **Bureau Veritas Consumer Products Services (H.K.) Ltd., Taoyuan Branch**, and found compliance with the requirement of the above standards. The test record, data evaluation & Equipment Under Test (EUT) configurations represented herein are true and accurate accounts of the measurements of the sample's EMC characteristics under the conditions specified in this report.

Prepared by : Midoli Peng , **Date:** Nov. 11, 2015
Midoli Peng / Specialist

Approved by : May Chen , **Date:** Nov. 11, 2015
May Chen / Manager

2 Summary of Test Results

47 CFR FCC Part 15, Subpart E (SECTION 15.407)			
FCC Clause	Test Item	Result	Remarks
15.407(b)(6)	AC Power Conducted Emissions	PASS	Meet the requirement of limit. Minimum passing margin is -20.04dB at 0.45859MHz.
15.407(b)(1/2/3/4/6)	Radiated Emissions & Band Edge Measurement	PASS	Meet the requirement of limit. Minimum passing margin is -0.3dB at 5725.00MHz.
15.407(a)(1/2/3)	Max Average Transmit Power	PASS	Meet the requirement of limit.
15.407(a)(1/2/3)	Peak Power Spectral Density	PASS	Meet the requirement of limit.
15.407(e)	6dB bandwidth	PASS	Meet the requirement of limit. (U-NII-3 Band only)
15.407(g)	Frequency Stability	PASS	Meet the requirement of limit.
15.203	Antenna Requirement	PASS	No antenna connector is used.

NOTE: The EUT was operating in 2400 ~ 2483.5MHz, 5150~5250MHz and 5725~5850MHz frequencies band. This report was recorded the RF parameters including 5150~5250MHz and 5725~5850MHz. For the 2400 ~ 2483.5MHz RF parameters was recorded in another test report.

2.1 Measurement Uncertainty

Where relevant, the following measurement uncertainty levels have been estimated for tests performed on the EUT as specified in CISPR 16-4-2:

Measurement	Frequency	Expanded Uncertainty (k=2) (±)
Conducted Emissions at mains ports	150kHz ~ 30MHz	2.86 dB
Radiated Emissions up to 1 GHz	30MHz ~ 1GHz	5.37 dB
Radiated Emissions above 1 GHz	1GHz ~ 6GHz	3.65 dB
	6GHz ~ 18GHz	3.88 dB
	18GHz ~ 40GHz	4.11 dB

2.2 Modification Record

There were no modifications required for compliance.

3 General Information

3.1 General Description of EUT (WLAN)

Product	dual-band wireless accessory radio
Brand	Microsoft
Test Model	1682
Status of EUT	ENGINEERING SAMPLE
Power Supply Rating	3.3Vdc from host equipment
Modulation Type	64QAM, 16QAM, QPSK, BPSK for OFDM
Modulation Technology	OFDM
Transfer Rate	802.11n : up to 72.2Mbps
Operating Frequency	For 15.407 5.18 ~ 5.24GHz, 5.745 ~ 5.825GHz For 15.247 2.412 ~ 2.462GHz
Number of Channel	For 15.407 9 for 802.11n (HT20) For 15.247 11 for 802.11n (HT20)
Output Power	For 15.407 802.11n (HT20): 49.659mW For 15.247 802.11n (HT20): 415.911mW
Antenna Type	Refer to Note
Antenna Connector	Refer to Note
Accessory Device	NA
Data Cable Supplied	NA

Note:

1. The EUT has two layout designs as following table:

Type	Config name	Config label	MS PN	Difference
Type 1	Base	CBEV2DSBase-03	X907054-003	Without Audio IC
Type 2	Premium	CBEV2DSBase-05	X907055-003	With Audio IC

Note: From the above types, Type 1 was selected as representative model for the test and its data was recorded in this report.

2. The antennas provided to the EUT, please refer to the following table:

Antenna No.	Brand	Model	Gain (dBi)	Antenna Type	Connector Type	Frequency range (GHz to GHz)	Function
Ant. 1 (for WLAN 2.4GHz)	Microsoft	NA	2.7	PCB	NA	2.4~2.4835	TX/RX
Ant. 2 (for BT)			0.12			2.4~2.4835	TX/RX
Ant. 3 (for WLAN 5GHz) Chan (0)			2.2			5.15~5.85	TX/RX
Ant. 4 (for WLAN 5GHz) Chan (1)			2.2			5.15~5.85	RX

3. The EUT incorporates a SISO function.

2.4GHz Band			
MODULATION MODE	DATA RATE (MCS)	TX & RX CONFIGURATION	
802.11n (HT20)	MCS 0~7	1TX	1RX
5GHz Band			
MODULATION MODE	DATA RATE (MCS)	TX & RX CONFIGURATION	
802.11n (HT20)	MCS 0~7	1TX (Fixed Chan 0)	1RX (diversity)

4. The emission of the simultaneous operation (WLAN & Bluetooth) has been evaluated and no non-compliance was found.
5. The above EUT information is declared by manufacturer and for more detailed features description, please refer to the manufacturer's specifications or user's manual.

3.2 Description of Test Modes

FOR 5180 ~ 5240MHz

4 channels are provided for 802.11n (HT20):

Channel	Frequency	Channel	Frequency
36	5180 MHz	44	5220 MHz
40	5200 MHz	48	5240 MHz

FOR 5745 ~ 5825MHz:

5 channels are provided for 802.11n (HT20):

Channel	Frequency	Channel	Frequency
149	5745MHz	161	5805MHz
153	5765MHz	165	5825MHz
157	5785MHz		

3.2.1 Test Mode Applicability and Tested Channel Detail

EUT CONFIGURE MODE	APPLICABLE TO				DESCRIPTION
	RE≥1G	RE<1G	PLC	APCM	
-	√	√	√	√	-

Where **RE≥1G**: Radiated Emission above 1GHz **RE<1G**: Radiated Emission below 1GHz
PLC: Power Line Conducted Emission **APCM**: Antenna Port Conducted Measurement

NOTE:

1. The EUT had been pre-tested on the positioned of each 3 axis. The worst case was found when positioned on **Y-plane**.

Radiated Emission Test (Above 1GHz):

- Pre-Scan has been conducted to determine the worst-case mode from all possible combinations between available modulations, data rates and antenna ports (if EUT with antenna diversity architecture).
- Following channel(s) was (were) selected for the final test as listed below.

MODE	FREQ. BAND (MHz)	AVAILABLE CHANNEL	TESTED CHANNEL	MODULATION TECHNOLOGY	MODULATION TYPE	DATA RATE (Mbps)
802.11n (HT20)	5180-5240	36 to 48	36, 40, 48	OFDM	BPSK	6.5
802.11n (HT20)	5745-5825	149 to 165	149, 157, 165	OFDM	BPSK	6.5

Radiated Emission Test (Below 1GHz):

- Pre-Scan has been conducted to determine the worst-case mode from all possible combinations between available modulations, data rates and antenna ports (if EUT with antenna diversity architecture).
- Following channel(s) was (were) selected for the final test as listed below.

MODE	FREQ. BAND (MHz)	AVAILABLE CHANNEL	TESTED CHANNEL	MODULATION TECHNOLOGY	MODULATION TYPE	DATA RATE (Mbps)
802.11n (HT20)	5180-5240, 5745-5825	36 to 48, 149 to 165	149	OFDM	BPSK	6.5

Power Line Conducted Emission Test:

- Pre-Scan has been conducted to determine the worst-case mode from all possible combinations between available modulations, data rates and antenna ports (if EUT with antenna diversity architecture).
- Following channel(s) was (were) selected for the final test as listed below.

MODE	FREQ. BAND (MHz)	AVAILABLE CHANNEL	TESTED CHANNEL	MODULATION TECHNOLOGY	MODULATION TYPE	DATA RATE (Mbps)
802.11n (HT20)	5180-5240, 5745-5825	36 to 48, 149 to 165	149	OFDM	BPSK	6.5

Antenna Port Conducted Measurement:

- This item includes all test value of each mode, but only includes spectrum plot of worst value of each mode.
- Pre-Scan has been conducted to determine the worst-case mode from all possible combinations between available modulations, data rates and antenna ports (if EUT with antenna diversity architecture).
- Following channel(s) was (were) selected for the final test as listed below.

MODE	FREQ. BAND (MHz)	AVAILABLE CHANNEL	TESTED CHANNEL	MODULATION TECHNOLOGY	MODULATION TYPE	DATA RATE (Mbps)
802.11n (HT20)	5180-5240	36 to 48	36, 40, 48	OFDM	BPSK	6.5
802.11n (HT20)	5745-5825	149 to 165	149, 157, 165	OFDM	BPSK	6.5

Test Condition:

APPLICABLE TO	ENVIRONMENTAL CONDITIONS	INPUT POWER (System)	TESTED BY
RE≥1G	25deg. C, 65%RH	120Vac, 60Hz	Nelson Teng
RE<1G	24deg. C, 68%RH	120Vac, 60Hz	Weiwei Lo
PLC	25deg. C, 64%RH	120Vac, 60Hz	Timmy Hu
APCM	25deg. C, 60%RH	120Vac, 60Hz	Anderson Chen

3.3 Duty Cycle of Test Signal

Duty cycle of test signal is 100 %, duty factor is not required.

802.11n (HT20)

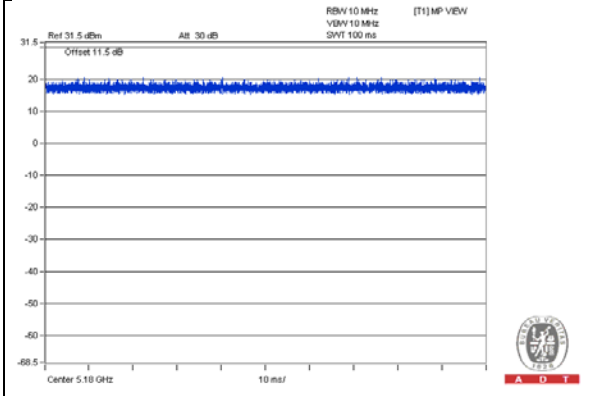

3.4 Description of Support Units

The EUT has been tested as an independent unit together with other necessary accessories or support units. The following support units or accessories were used to form a representative test configuration during the tests.

ID	Product	Brand	Model No.	Serial No.	FCC ID	Remarks
A.	NOTEBOOK COMPUTER	DELL	E5430	HYV4VY1	FCC DoC	Provided by Lab
B.	Test Tool	NA	NA	NA	NA	Supplied by Client
C.	Adapter	AMIG	AMS3-050200FU	NA	NA	Supplied by Client

Note:

1. All power cords of the above support units are non-shielded (1.8m).

ID	Descriptions	Qty.	Length (m)	Shielding (Yes/No)	Cores (Qty.)	Remarks
1.	USB	1	1.7	Yes	0	Supplied by Client
2.	DC	1	1.5	No	0	Supplied by Client

3.4.1 Configuration of System under Test

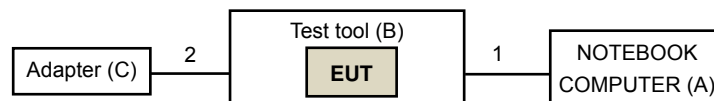

3.5 General Description of Applied Standard

The EUT is a RF Product. According to the specifications of the manufacturer, it must comply with the requirements of the following standards:

FCC Part 15, Subpart E (15.407)

KDB 789033 D02 General UNII Test Procedure New Rules v01r01

ANSI C63.10-2013

All test items have been performed and recorded as per the above standards.

4 Test Types and Results

4.1 Radiated Emission and Bandedge Measurement

4.1.1 Limits of Radiated Emission and Bandedge Measurement

Radiated emissions which fall in the restricted bands must comply with the radiated emission limits specified as below table.

Frequencies (MHz)	Field Strength (microvolts/meter)	Measurement Distance (meters)
0.009 ~ 0.490	2400/F(kHz)	300
0.490 ~ 1.705	24000/F(kHz)	30
1.705 ~ 30.0	30	30
30 ~ 88	100	3
88 ~ 216	150	3
216 ~ 960	200	3
Above 960	500	3

NOTE:

1. The lower limit shall apply at the transition frequencies.
2. Emission level (dBuV/m) = 20 log Emission level (uV/m).
3. For frequencies above 1000MHz, the field strength limits are based on average detector, however, the peak field strength of any emission shall not exceed the maximum permitted average limits, specified above by more than 20dB under any condition of modulation.

LIMITS OF UNWANTED EMISSION OUT OF THE RESTRICTED BANDS

APPLICABLE TO	LIMIT	
KDB 789033 D02 General UNII Test Procedure New Rules v01r01	FIELD STRENGTH AT 3m	
	PK:74 (dBμV/m)	AV:54 (dBμV/m)
APPLICABLE TO	EIRP LIMIT	EQUIVALENT FIELD STRENGTH AT 3m
15.407(b)(1)	PK:-27 (dBm/MHz)	PK:68.2(dBμV/m)
15.407(b)(2)		
15.407(b)(3)		
15.407(b)(4)	PK:-27 (dBm/MHz) ^{*1} PK:-17 (dBm/MHz) ^{*2}	PK: 68.2(dBμV/m) ^{*1} PK:78.2 (dBμV/m) ^{*2}

NOTE: ^{*1} beyond 10MHz of the band edge ^{*2} within 10 MHz of band edge

The following formula is used to convert the equipment isotropic radiated power (eirp) to field strength:

$$E = \frac{1000000\sqrt{30P}}{3} \mu\text{V/m, where P is the eirp (Watts).$$

4.1.2 Test Instruments

For Bandedge test:

DESCRIPTION & MANUFACTURER	MODEL NO.	SERIAL NO.	CALIBRATED DATE	CALIBRATED UNTIL
Test Receiver Agilent	N9038A	MY51210105	July 24, 2015	July 23, 2016
Horn_Antenna AISI	AIH.8018	000032009111 0	Feb. 09, 2015	Feb. 08, 2016
Pre-Amplifier Agilent	8449B	3008A02578	June 23, 2015	June 22, 2016
RF Cable	NA	131205 131216 131217 SNMY23684/ 4	Jan. 16, 2015	Jan. 15, 2016
Spectrum Analyzer R&S	FSV40	100964	June 26, 2015	June 25, 2016
Pre-Amplifier SPACEK LABS	SLKKa-48-6	9K16	Dec. 12, 2014	Dec. 11, 2015
Horn_Antenna SCHWARZBECK	BBHA 9170	9170-424	Feb. 05, 2015	Feb. 04, 2016
RF Cable	NA	329751/4 RF104-204	Dec. 11, 2014	Dec. 10, 2015
Software	ADT_Radiated _V8.7.07	NA	NA	NA
Antenna Tower & Turn Table CT	NA	NA	NA	NA

Note:

1. The calibration interval of the above test instruments is 12 months and the calibrations are traceable to NML/ROC and NIST/USA.
2. The test was performed in 966 Chamber No. G.
3. The FCC Site Registration No. is 966073.
4. The VCCI Site Registration No. is G-137.
5. The CANADA Site Registration No. is IC 7450H-2.
7. Tested Date: Oct. 08, 2015

For other test items:

DESCRIPTION & MANUFACTURER	MODEL NO.	SERIAL NO.	CALIBRATED DATE	CALIBRATED UNTIL
Test Receiver Agilent	N9038A	MY51210105	July 24, 2015	July 23, 2016
Pre-Amplifier Mini-Circuits	ZFL-1000VH2 B	AMP-ZFL-03	Nov. 12, 2014	Nov. 11, 2015
Trilog Broadband Antenna SCHWARZBECK	VULB 9168	9168-360	Feb. 06, 2015	Feb. 05, 2016
RF Cable	8D-FB	CHGCAB-001 -1 CHGCAB-001 -2	Oct. 04, 2014	Oct. 03, 2015
	RF-141	CHGCAB-004	Oct. 04, 2014	Oct. 03, 2015
Horn_Antenna AISI	AIH.8018	000032009111 0	Feb. 09, 2015	Feb. 08, 2016
Pre-Amplifier Agilent	8449B	3008A02578	June 23, 2015	June 22, 2016
RF Cable	NA	131205 131216 131217 SNMY23684/ 4	Jan. 16, 2015	Jan. 15, 2016
Spectrum Analyzer R&S	FSV40	100964	June 26, 2015	June 25, 2016
Pre-Amplifier SPACEK LABS	SLKka-48-6	9K16	Dec. 12, 2014	Dec. 11, 2015
Horn_Antenna SCHWARZBECK	BBHA 9170	9170-424	Feb. 05, 2015	Feb. 04, 2016
RF Cable	NA	329751/4 RF104-204	Dec. 11, 2014	Dec. 10, 2015
Software	ADT_Radiated _V8.7.07	NA	NA	NA
Antenna Tower & Turn Table CT	NA	NA	NA	NA
Spectrum Analyzer R&S	FSP40	100060	May 08, 2015	May 07, 2016
Power meter Anritsu	ML2495A	1014008	Apr. 28, 2015	Apr. 27, 2016
Power sensor Anritsu	MA2411B	0917122	Apr. 28, 2015	Apr. 27, 2016
Temperature & Humidity Chamber GIANTFORCE	GTH-150-40-S P-AR	MAA0812-00 8	Jan. 12, 2015	Jan. 11, 2016

Note:

1. The calibration interval of the above test instruments is 12 months and the calibrations are traceable to NML/ROC and NIST/USA.
2. The test was performed in 966 Chamber No. G.
3. The FCC Site Registration No. is 966073.
4. The VCCI Site Registration No. is G-137.
5. The CANADA Site Registration No. is IC 7450H-2.
6. Tested Date: Sep. 16 to 18, 2015

4.1.3 Test Procedure

- a. The EUT was placed on the top of a rotating table 0.8 meters (for below 1GHz) / 1.5 meters (for above 1GHz) above the ground at 3 meter chamber room for test. The table was rotated 360 degrees to determine the position of the highest radiation.
- b. The EUT was set 3 meters away from the interference-receiving antenna, which was mounted on the top of a variable-height antenna tower.
- c. The height of antenna is varied from one meter to four meters above the ground to determine the maximum value of the field strength. Both horizontal and vertical polarizations of the antenna are set to make the measurement.
- d. For each suspected emission, the EUT was arranged to its worst case and then the antenna was tuned to heights from 1 meter to 4 meters and the rotatable table was turned from 0 degrees to 360 degrees to find the maximum reading.
- e. The test-receiver system was set to quasi-peak detect function and specified bandwidth with maximum hold mode when the test frequency is below 1 GHz.
- f. The test-receiver system was set to peak and average detect function and specified bandwidth with maximum hold mode when the test frequency is above 1 GHz. If the peak reading value also meets average limit, measurement with the average detector is unnecessary.

Note:

1. The resolution bandwidth and video bandwidth of test receiver/spectrum analyzer is 120kHz for Quasi-peak detection (QP) at frequency below 1GHz.
2. The resolution bandwidth of test receiver/spectrum analyzer is 1 MHz and the video bandwidth is 3 MHz for Peak detection (PK) at frequency above 1GHz.
3. The resolution bandwidth of test receiver/spectrum analyzer is 1MHz and the video bandwidth is 3MHz for RMS Average (Duty cycle < 98%) for Average detection (AV) at frequency above 1GHz, then the measurement results was added to a correction factor ($10 \log(1/\text{duty cycle})$).
4. The resolution bandwidth of test receiver/spectrum analyzer is 1MHz and the video bandwidth is 10Hz (Duty cycle \geq 98%) for Average detection (AV) at frequency above 1GHz.
5. All modes of operation were investigated and the worst-case emissions are reported.

4.1.4 Deviation from Test Standard

No deviation.

4.1.5 Test Setup

<Frequency Range below 1GHz>

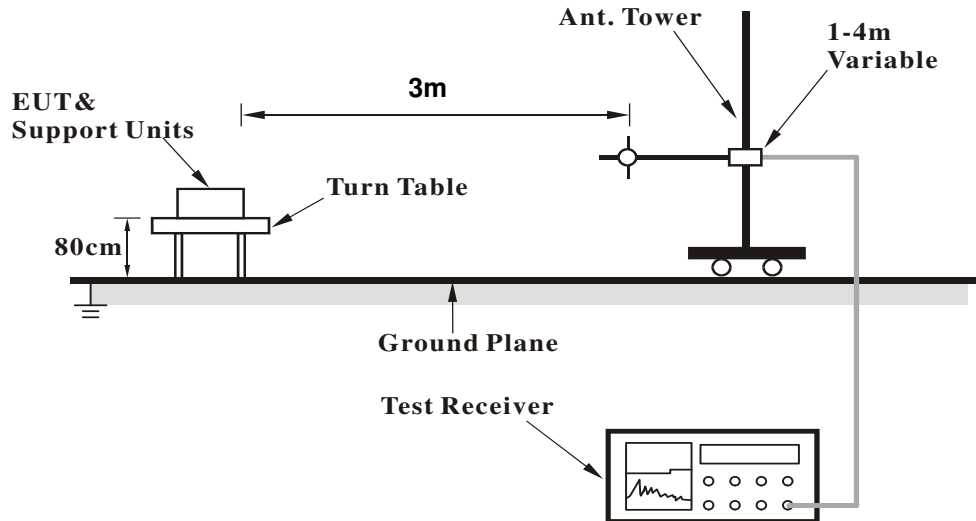

<Frequency Range above 1GHz>

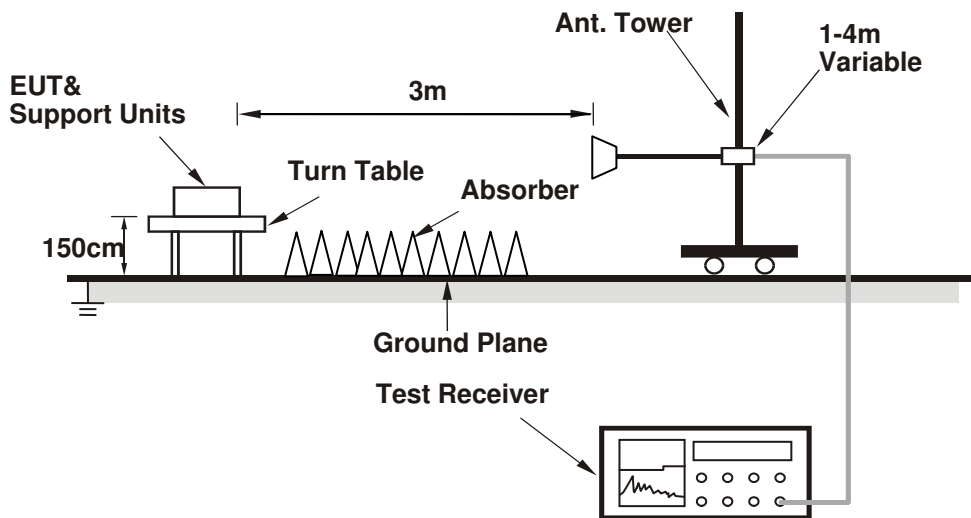

For the actual test configuration, please refer to the attached file (Test Setup Photo).

4.1.6 EUT Operating Condition

1. Connect the EUT with the support unit A (Notebook Computer) which is placed on test table.
2. The communication partner run test program "MT7662UQA.exe_V1.0.3.13" to enable EUT under transmission/receiving condition continuously at specific channel frequency.

4.1.7 Test Results (Bandedge)

CHANNEL	TX Channel 36	DETECTOR FUNCTION	Peak (PK)
FREQUENCY RANGE	1GHz ~ 40GHz		Average (AV)

ANTENNA POLARITY & TEST DISTANCE: HORIZONTAL AT 3 M								
NO.	FREQ. (MHz)	EMISSION LEVEL (dBuV/m)	LIMIT (dBuV/m)	MARGIN (dB)	ANTENNA HEIGHT (m)	TABLE ANGLE (Degree)	RAW VALUE (dBuV)	CORRECTION FACTOR (dB/m)
1	5150.00	48.7 PK	74.0	-25.3	1.56 H	205	9.99	38.71
2	5150.00	36.0 AV	54.0	-18.0	1.56 H	205	-2.71	38.71
3	*5180.00	103.1 PK			1.56 H	205	64.34	38.76
4	*5180.00	92.8 AV			1.56 H	205	54.04	38.76

REMARKS:

1. Emission Level(dBuV/m) = Raw Value(dBuV) + Correction Factor(dB/m)
2. Correction Factor(dB/m) = Antenna Factor(dB/m) + Cable Factor(dB) – Pre-Amplifier Factor(dB)
3. The other emission levels were very low against the limit.
4. Margin value = Emission Level – Limit value
5. " * ": Fundamental frequency.

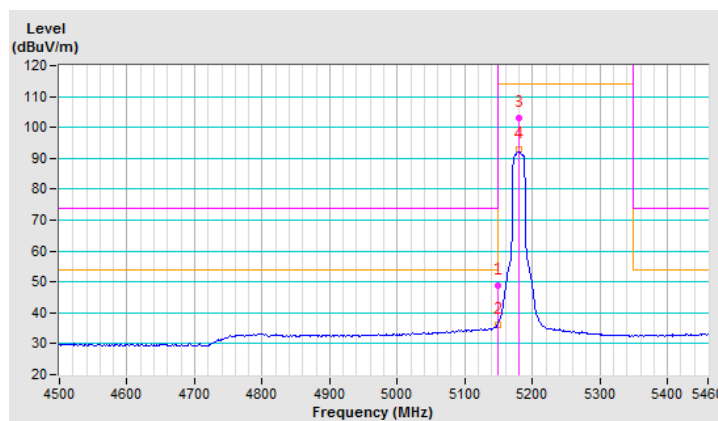

CHANNEL	TX Channel 36	DETECTOR FUNCTION	Peak (PK)
FREQUENCY RANGE	1GHz ~ 40GHz		Average (AV)

ANTENNA POLARITY & TEST DISTANCE: VERTICAL AT 3 M								
NO.	FREQ. (MHz)	EMISSION LEVEL (dBuV/m)	LIMIT (dBuV/m)	MARGIN (dB)	ANTENNA HEIGHT (m)	TABLE ANGLE (Degree)	RAW VALUE (dBuV)	CORRECTION FACTOR (dB/m)
1	5150.00	64.1 PK	74.0	-9.9	1.79 V	180	25.39	38.71
2	5150.00	51.3 AV	54.0	-2.7	1.79 V	180	12.59	38.71
3	*5180.00	106.4 PK			1.79 V	180	67.64	38.76
4	*5180.00	96.6 AV			1.79 V	180	57.84	38.76

REMARKS:

1. Emission Level(dBuV/m) = Raw Value(dBuV) + Correction Factor(dB/m)
2. Correction Factor(dB/m) = Antenna Factor(dB/m) + Cable Factor(dB) – Pre-Amplifier Factor(dB)
3. The other emission levels were very low against the limit.
4. Margin value = Emission Level – Limit value
5. " * ": Fundamental frequency.

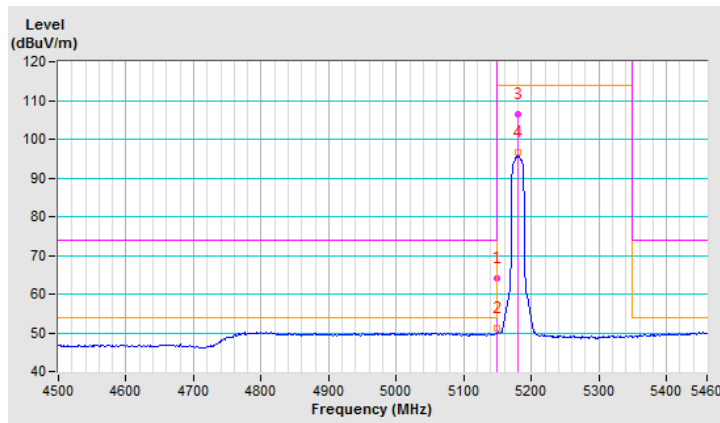

CHANNEL	TX Channel 40	DETECTOR FUNCTION	Peak (PK)
FREQUENCY RANGE	1GHz ~ 40GHz		Average (AV)

ANTENNA POLARITY & TEST DISTANCE: HORIZONTAL AT 3 M								
NO.	FREQ. (MHz)	EMISSION LEVEL (dBuV/m)	LIMIT (dBuV/m)	MARGIN (dB)	ANTENNA HEIGHT (m)	TABLE ANGLE (Degree)	RAW VALUE (dBuV)	CORRECTION FACTOR (dB/m)
1	*5200.00	103.7 PK			1.55 H	210	64.90	38.80
2	*5200.00	93.5 AV			1.55 H	210	54.70	38.80

REMARKS:

1. Emission Level(dBuV/m) = Raw Value(dBuV) + Correction Factor(dB/m)
2. Correction Factor(dB/m) = Antenna Factor(dB/m) + Cable Factor(dB) – Pre-Amplifier Factor(dB)
3. The other emission levels were very low against the limit.
4. Margin value = Emission Level – Limit value
5. " * ": Fundamental frequency.

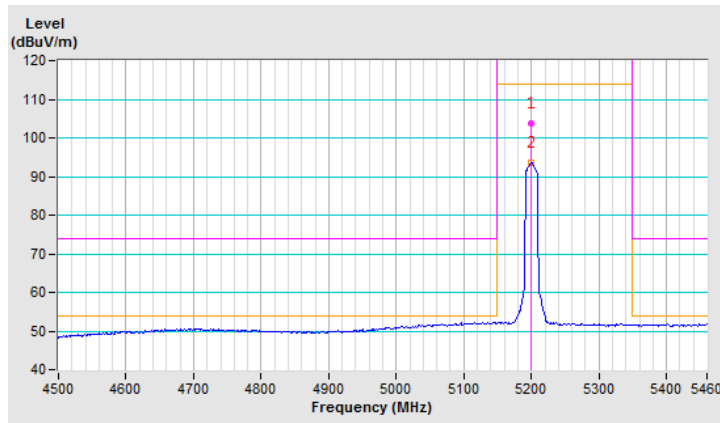

CHANNEL	TX Channel 40	DETECTOR FUNCTION	Peak (PK)
FREQUENCY RANGE	1GHz ~ 40GHz		Average (AV)

ANTENNA POLARITY & TEST DISTANCE: VERTICAL AT 3 M								
NO.	FREQ. (MHz)	EMISSION LEVEL (dBuV/m)	LIMIT (dBuV/m)	MARGIN (dB)	ANTENNA HEIGHT (m)	TABLE ANGLE (Degree)	RAW VALUE (dBuV)	CORRECTION FACTOR (dB/m)
1	*5200.00	103.2 PK			1.88 V	171	64.40	38.80
2	*5200.00	95.3 AV			1.88 V	171	56.50	38.80

REMARKS:

1. Emission Level(dBuV/m) = Raw Value(dBuV) + Correction Factor(dB/m)
2. Correction Factor(dB/m) = Antenna Factor(dB/m) + Cable Factor(dB) – Pre-Amplifier Factor(dB)
3. The other emission levels were very low against the limit.
4. Margin value = Emission Level – Limit value
5. " * ": Fundamental frequency.

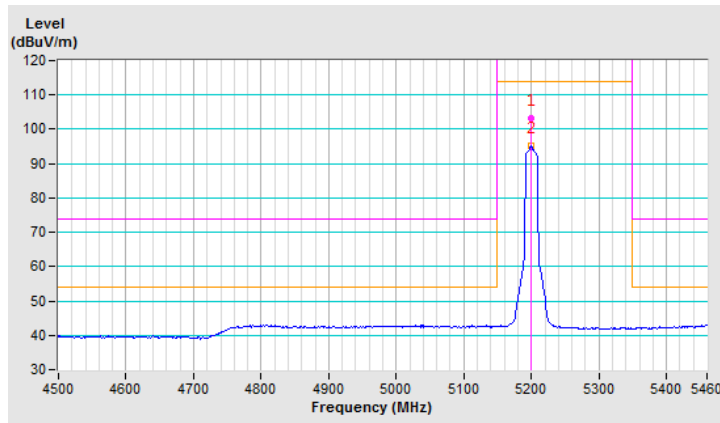

CHANNEL	TX Channel 48	DETECTOR FUNCTION	Peak (PK)
FREQUENCY RANGE	1GHz ~ 40GHz		Average (AV)

ANTENNA POLARITY & TEST DISTANCE: HORIZONTAL AT 3 M								
NO.	FREQ. (MHz)	EMISSION LEVEL (dBuV/m)	LIMIT (dBuV/m)	MARGIN (dB)	ANTENNA HEIGHT (m)	TABLE ANGLE (Degree)	RAW VALUE (dBuV)	CORRECTION FACTOR (dB/m)
1	*5240.00	103.9 PK			1.09 H	206	65.03	38.87
2	*5240.00	93.7 AV			1.09 H	206	54.83	38.87
3	5350.00	48.4 PK	74.0	-25.6	1.09 H	206	9.40	39.00
4	5350.00	35.8 AV	54.0	-18.2	1.09 H	206	-3.20	39.00

REMARKS:

1. Emission Level(dBuV/m) = Raw Value(dBuV) + Correction Factor(dB/m)
2. Correction Factor(dB/m) = Antenna Factor(dB/m) + Cable Factor(dB) – Pre-Amplifier Factor(dB)
3. The other emission levels were very low against the limit.
4. Margin value = Emission Level – Limit value
5. " * ": Fundamental frequency.

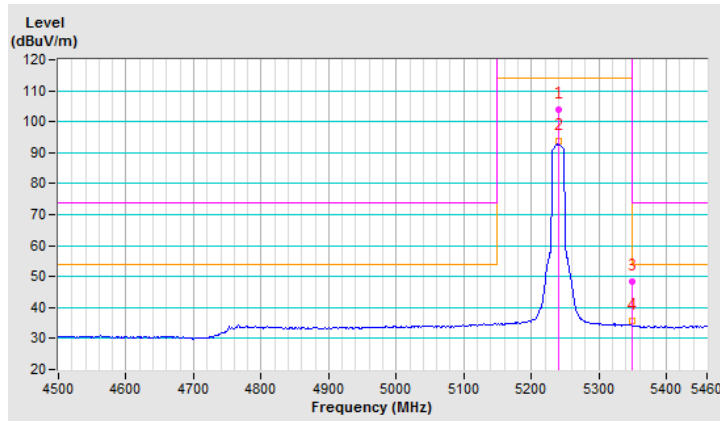

CHANNEL	TX Channel 48	DETECTOR FUNCTION	Peak (PK)
FREQUENCY RANGE	1GHz ~ 40GHz		Average (AV)

ANTENNA POLARITY & TEST DISTANCE: VERTICAL AT 3 M								
NO.	FREQ. (MHz)	EMISSION LEVEL (dBuV/m)	LIMIT (dBuV/m)	MARGIN (dB)	ANTENNA HEIGHT (m)	TABLE ANGLE (Degree)	RAW VALUE (dBuV)	CORRECTION FACTOR (dB/m)
1	*5240.00	105.1 PK			1.86 V	173	66.23	38.87
2	*5240.00	95.9 AV			1.86 V	173	57.03	38.87
3	5350.00	48.3 PK	74.0	-25.7	1.86 V	173	9.30	39.00
4	5350.00	36.9 AV	54.0	-17.1	1.86 V	173	-2.10	39.00

REMARKS:

1. Emission Level(dBuV/m) = Raw Value(dBuV) + Correction Factor(dB/m)
2. Correction Factor(dB/m) = Antenna Factor(dB/m) + Cable Factor(dB) – Pre-Amplifier Factor(dB)
3. The other emission levels were very low against the limit.
4. Margin value = Emission Level – Limit value
5. " * ": Fundamental frequency.

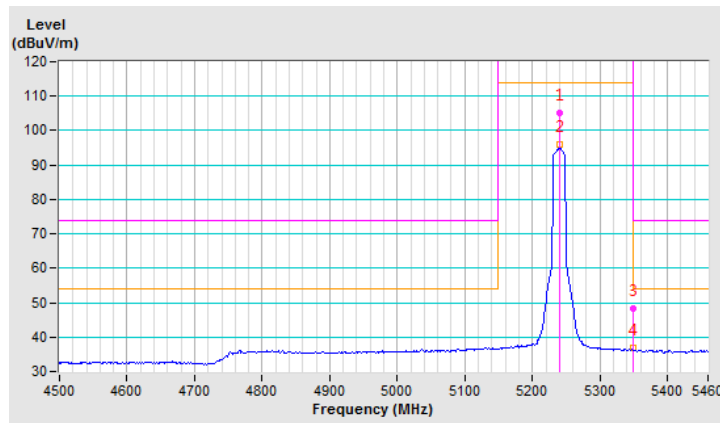

CHANNEL	TX Channel 149	DETECTOR FUNCTION	Peak (PK)
FREQUENCY RANGE	1GHz ~ 40GHz		Average (AV)

ANTENNA POLARITY & TEST DISTANCE: HORIZONTAL AT 3 M								
NO.	FREQ. (MHz)	EMISSION LEVEL (dBuV/m)	LIMIT (dBuV/m)	MARGIN (dB)	ANTENNA HEIGHT (m)	TABLE ANGLE (Degree)	RAW VALUE (dBuV)	CORRECTION FACTOR (dB/m)
1	#5715.00	51.9 PK	74.0	-22.1	1.75 H	196	12.30	39.60
2	#5715.00	45.8 AV	54.0	-8.2	1.75 H	196	6.20	39.60
3	#5725.00	74.8 PK	78.2	-3.4	1.76 H	179	35.17	39.63
4	*5745.00	104.1 PK			1.48 H	209	64.43	39.67
5	*5745.00	93.6 AV			1.48 H	209	53.93	39.67

REMARKS:

1. Emission Level(dBuV/m) = Raw Value(dBuV) + Correction Factor(dB/m)
2. Correction Factor(dB/m) = Antenna Factor(dB/m) + Cable Factor(dB) – Pre-Amplifier Factor(dB)
3. The other emission levels were very low against the limit.
4. Margin value = Emission Level – Limit value
5. " * ": Fundamental frequency.
6. " # ": The radiated frequency is out of the restricted band.

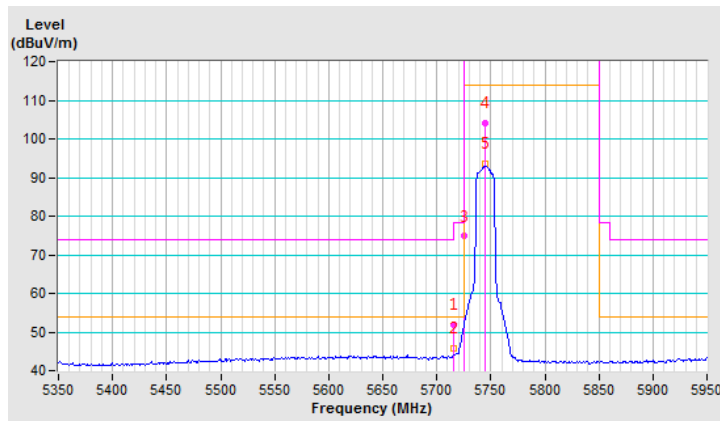

CHANNEL	TX Channel 157	DETECTOR FUNCTION	Peak (PK)
FREQUENCY RANGE	1GHz ~ 40GHz		Average (AV)

ANTENNA POLARITY & TEST DISTANCE: HORIZONTAL AT 3 M								
NO.	FREQ. (MHz)	EMISSION LEVEL (dBuV/m)	LIMIT (dBuV/m)	MARGIN (dB)	ANTENNA HEIGHT (m)	TABLE ANGLE (Degree)	RAW VALUE (dBuV)	CORRECTION FACTOR (dB/m)
1	#5725.00	50.7 PK	78.2	-27.5	1.76 H	189	11.07	39.63
2	*5785.00	103.7 PK			1.55 H	226	63.94	39.76
3	*5785.00	93.4 AV			1.55 H	226	53.64	39.76
4	#5850.00	49.6 PK	78.2	-28.6	1.71 H	175	9.75	39.85

REMARKS:

1. Emission Level(dBuV/m) = Raw Value(dBuV) + Correction Factor(dB/m)
2. Correction Factor(dB/m) = Antenna Factor(dB/m) + Cable Factor(dB) – Pre-Amplifier Factor(dB)
3. The other emission levels were very low against the limit.
4. Margin value = Emission Level – Limit value
5. " * ": Fundamental frequency.
6. " # ": The radiated frequency is out of the restricted band.

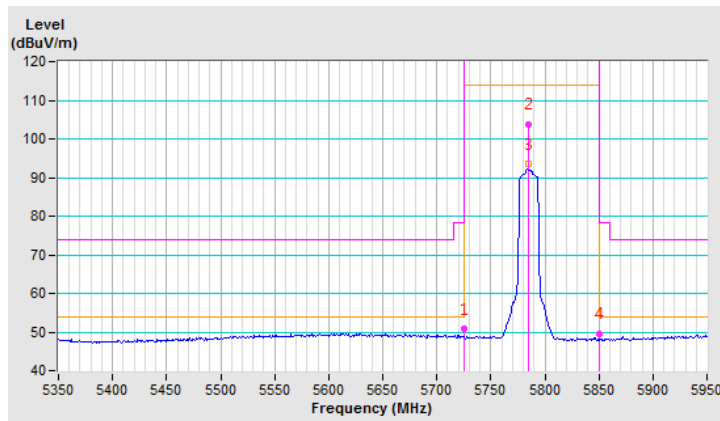

CHANNEL	TX Channel 157	DETECTOR FUNCTION	Peak (PK)
FREQUENCY RANGE	1GHz ~ 40GHz		Average (AV)

ANTENNA POLARITY & TEST DISTANCE: VERTICAL AT 3 M								
NO.	FREQ. (MHz)	EMISSION LEVEL (dBuV/m)	LIMIT (dBuV/m)	MARGIN (dB)	ANTENNA HEIGHT (m)	TABLE ANGLE (Degree)	RAW VALUE (dBuV)	CORRECTION FACTOR (dB/m)
1	#5725.00	51.1 PK	78.2	-27.1	1.84 V	178	11.47	39.63
2	*5785.00	105.3 PK			1.84 V	178	65.54	39.76
3	*5785.00	97.8 AV			1.84 V	178	58.04	39.76
4	#5850.00	49.3 PK	78.2	-28.9	1.84 V	178	9.45	39.85

REMARKS:

1. Emission Level(dBuV/m) = Raw Value(dBuV) + Correction Factor(dB/m)
2. Correction Factor(dB/m) = Antenna Factor(dB/m) + Cable Factor(dB) – Pre-Amplifier Factor(dB)
3. The other emission levels were very low against the limit.
4. Margin value = Emission Level – Limit value
5. " * ": Fundamental frequency.
6. " # ": The radiated frequency is out of the restricted band.

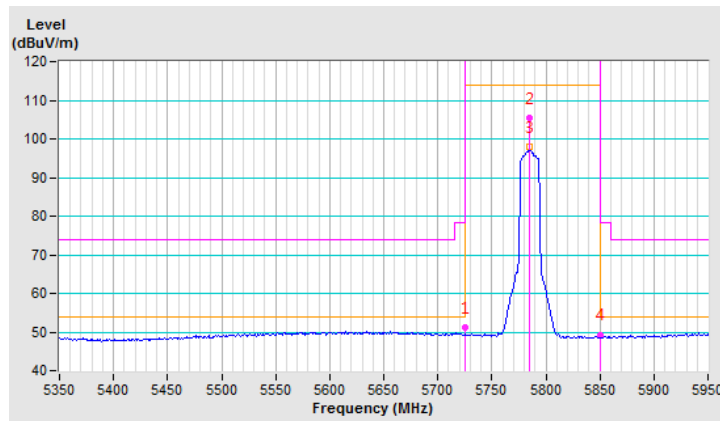

CHANNEL	TX Channel 165	DETECTOR FUNCTION	Peak (PK)
FREQUENCY RANGE	1GHz ~ 40GHz		Average (AV)

ANTENNA POLARITY & TEST DISTANCE: HORIZONTAL AT 3 M								
NO.	FREQ. (MHz)	EMISSION LEVEL (dBuV/m)	LIMIT (dBuV/m)	MARGIN (dB)	ANTENNA HEIGHT (m)	TABLE ANGLE (Degree)	RAW VALUE (dBuV)	CORRECTION FACTOR (dB/m)
1	*5825.00	103.8 PK			1.50 H	217	63.99	39.81
2	*5825.00	93.5 AV			1.50 H	217	53.69	39.81
3	#5850.00	60.5 PK	78.2	-17.7	1.76 H	209	20.65	39.85
4	#5860.00	50.8 PK	74.0	-23.2	1.77 H	167	10.94	39.86
5	#5860.00	43.7 AV	54.0	-10.3	1.77 H	167	3.84	39.86

REMARKS:

1. Emission Level(dBuV/m) = Raw Value(dBuV) + Correction Factor(dB/m)
2. Correction Factor(dB/m) = Antenna Factor(dB/m) + Cable Factor(dB) – Pre-Amplifier Factor(dB)
3. The other emission levels were very low against the limit.
4. Margin value = Emission Level – Limit value
5. " * ": Fundamental frequency.
6. " # ": The radiated frequency is out of the restricted band.

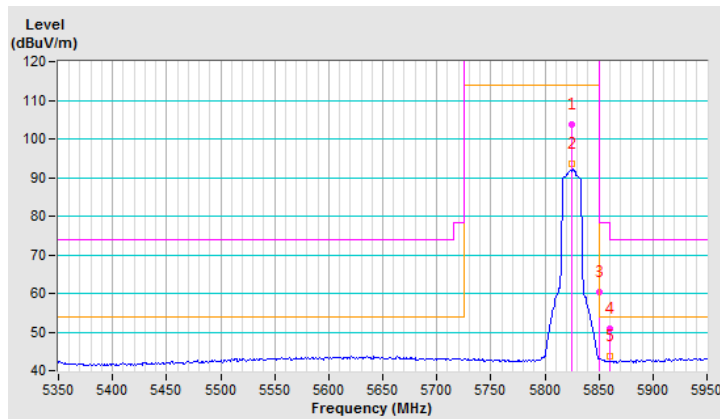

CHANNEL	TX Channel 165	DETECTOR FUNCTION	Peak (PK)
FREQUENCY RANGE	1GHz ~ 40GHz		Average (AV)

ANTENNA POLARITY & TEST DISTANCE: VERTICAL AT 3 M								
NO.	FREQ. (MHz)	EMISSION LEVEL (dBuV/m)	LIMIT (dBuV/m)	MARGIN (dB)	ANTENNA HEIGHT (m)	TABLE ANGLE (Degree)	RAW VALUE (dBuV)	CORRECTION FACTOR (dB/m)
1	*5825.00	106.6 PK			1.80 V	189	66.79	39.81
2	*5825.00	97.8 AV			1.80 V	189	57.99	39.81
3	#5850.00	66.4 PK	78.2	-11.8	1.80 V	189	26.55	39.85
4	#5860.00	65.5 PK	74.0	-8.5	1.80 V	189	25.64	39.86
5	#5860.00	53.4 AV	54.0	-0.6	1.80 V	189	13.54	39.86

REMARKS:

1. Emission Level(dBuV/m) = Raw Value(dBuV) + Correction Factor(dB/m)
2. Correction Factor(dB/m) = Antenna Factor(dB/m) + Cable Factor(dB) – Pre-Amplifier Factor(dB)
3. The other emission levels were very low against the limit.
4. Margin value = Emission Level – Limit value
5. " * ": Fundamental frequency.
6. " # ": The radiated frequency is out of the restricted band.

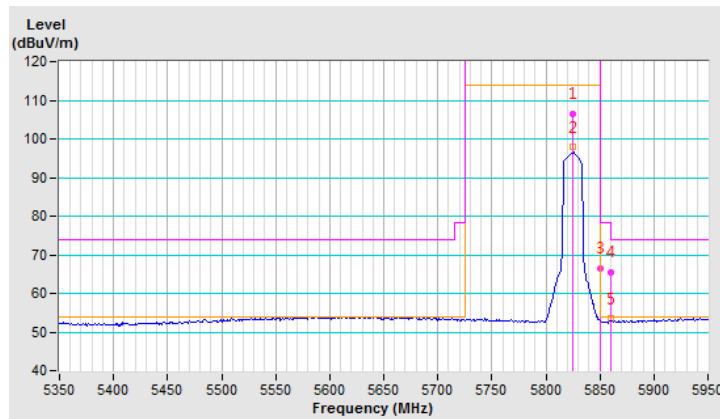

4.1.8 Test Results (Spurious emission)

Above 1GHz Data

802.11n (HT20)

CHANNEL	TX Channel 36	DETECTOR FUNCTION	Peak (PK)
FREQUENCY RANGE	1GHz ~ 40GHz		Average (AV)

ANTENNA POLARITY & TEST DISTANCE: HORIZONTAL AT 3 M

NO.	FREQ. (MHz)	EMISSION LEVEL (dBuV/m)	LIMIT (dBuV/m)	MARGIN (dB)	ANTENNA HEIGHT (m)	TABLE ANGLE (Degree)	RAW VALUE (dBuV)	CORRECTION FACTOR (dB/m)
1	#10360.00	48.7 PK	74.0	-25.3	1.00 H	155	34.20	14.50
2	#10360.00	37.4 AV	54.0	-16.6	1.00 H	155	22.90	14.50
3	15540.00	55.8 PK	74.0	-18.2	1.72 H	162	37.12	18.68
4	15540.00	43.7 AV	54.0	-10.3	1.72 H	162	25.02	18.68

ANTENNA POLARITY & TEST DISTANCE: VERTICAL AT 3 M

NO.	FREQ. (MHz)	EMISSION LEVEL (dBuV/m)	LIMIT (dBuV/m)	MARGIN (dB)	ANTENNA HEIGHT (m)	TABLE ANGLE (Degree)	RAW VALUE (dBuV)	CORRECTION FACTOR (dB/m)
1	#10360.00	53.7 PK	74.0	-20.3	1.02 V	65	39.20	14.50
2	#10360.00	43.2 AV	54.0	-10.8	1.02 V	65	28.70	14.50
3	15540.00	57.2 PK	74.0	-16.8	1.06 V	121	38.52	18.68
4	15540.00	44.7 AV	54.0	-9.3	1.06 V	121	26.02	18.68

REMARKS:

1. Emission Level(dBuV/m) = Raw Value(dBuV) + Correction Factor(dB/m)
2. Correction Factor(dB/m) = Antenna Factor(dB/m) + Cable Factor(dB) – Pre-Amplifier Factor(dB)
3. The other emission levels were very low against the limit.
4. Margin value = Emission Level – Limit value
5. "#": The radiated frequency is out of the restricted band.

CHANNEL	TX Channel 40	DETECTOR FUNCTION	Peak (PK)
FREQUENCY RANGE	1GHz ~ 40GHz		Average (AV)

ANTENNA POLARITY & TEST DISTANCE: HORIZONTAL AT 3 M

NO.	FREQ. (MHz)	EMISSION LEVEL (dBuV/m)	LIMIT (dBuV/m)	MARGIN (dB)	ANTENNA HEIGHT (m)	TABLE ANGLE (Degree)	RAW VALUE (dBuV)	CORRECTION FACTOR (dB/m)
1	#10400.00	48.6 PK	74.0	-25.4	1.00 H	156	34.00	14.60
2	#10400.00	37.0 AV	54.0	-17.0	1.00 H	156	22.40	14.60
3	15600.00	55.2 PK	74.0	-18.8	1.66 H	156	36.30	18.90
4	15600.00	43.3 AV	54.0	-10.7	1.66 H	156	24.40	18.90

ANTENNA POLARITY & TEST DISTANCE: VERTICAL AT 3 M

NO.	FREQ. (MHz)	EMISSION LEVEL (dBuV/m)	LIMIT (dBuV/m)	MARGIN (dB)	ANTENNA HEIGHT (m)	TABLE ANGLE (Degree)	RAW VALUE (dBuV)	CORRECTION FACTOR (dB/m)
1	#10400.00	54.0 PK	74.0	-20.0	1.08 V	70	39.40	14.60
2	#10400.00	43.5 AV	54.0	-10.5	1.08 V	70	28.90	14.60
3	15600.00	57.1 PK	74.0	-16.9	1.03 V	126	38.20	18.90
4	15600.00	44.9 AV	54.0	-9.1	1.03 V	126	26.00	18.90

REMARKS:

1. Emission Level(dBuV/m) = Raw Value(dBuV) + Correction Factor(dB/m)
2. Correction Factor(dB/m) = Antenna Factor(dB/m) + Cable Factor(dB) – Pre-Amplifier Factor(dB)
3. The other emission levels were very low against the limit.
4. Margin value = Emission Level – Limit value
5. "#": The radiated frequency is out of the restricted band.

CHANNEL	TX Channel 48	DETECTOR FUNCTION	Peak (PK)
FREQUENCY RANGE	1GHz ~ 40GHz		Average (AV)

ANTENNA POLARITY & TEST DISTANCE: HORIZONTAL AT 3 M

NO.	FREQ. (MHz)	EMISSION LEVEL (dBuV/m)	LIMIT (dBuV/m)	MARGIN (dB)	ANTENNA HEIGHT (m)	TABLE ANGLE (Degree)	RAW VALUE (dBuV)	CORRECTION FACTOR (dB/m)
1	#10480.00	48.4 PK	74.0	-25.6	1.00 H	159	33.93	14.47
2	#10480.00	37.1 AV	54.0	-16.9	1.00 H	159	22.63	14.47
3	15720.00	56.3 PK	74.0	-17.7	1.70 H	176	37.26	19.04
4	15720.00	44.1 AV	54.0	-9.9	1.70 H	176	25.06	19.04

ANTENNA POLARITY & TEST DISTANCE: VERTICAL AT 3 M

NO.	FREQ. (MHz)	EMISSION LEVEL (dBuV/m)	LIMIT (dBuV/m)	MARGIN (dB)	ANTENNA HEIGHT (m)	TABLE ANGLE (Degree)	RAW VALUE (dBuV)	CORRECTION FACTOR (dB/m)
1	#10480.00	54.0 PK	74.0	-20.0	1.02 V	71	39.53	14.47
2	#10480.00	43.4 AV	54.0	-10.6	1.02 V	71	28.93	14.47
3	15720.00	57.3 PK	74.0	-16.7	1.07 V	131	38.26	19.04
4	15720.00	44.8 AV	54.0	-9.2	1.07 V	131	25.76	19.04

REMARKS:

1. Emission Level(dBuV/m) = Raw Value(dBuV) + Correction Factor(dB/m)
2. Correction Factor(dB/m) = Antenna Factor(dB/m) + Cable Factor(dB) – Pre-Amplifier Factor(dB)
3. The other emission levels were very low against the limit.
4. Margin value = Emission Level – Limit value
5. "#": The radiated frequency is out of the restricted band.

CHANNEL	TX Channel 149	DETECTOR FUNCTION	Peak (PK)
FREQUENCY RANGE	1GHz ~ 40GHz		Average (AV)

ANTENNA POLARITY & TEST DISTANCE: HORIZONTAL AT 3 M

NO.	FREQ. (MHz)	EMISSION LEVEL (dBuV/m)	LIMIT (dBuV/m)	MARGIN (dB)	ANTENNA HEIGHT (m)	TABLE ANGLE (Degree)	RAW VALUE (dBuV)	CORRECTION FACTOR (dB/m)
1	11490.00	48.6 PK	74.0	-25.4	1.03 H	176	33.74	14.86
2	11490.00	37.0 AV	54.0	-17.0	1.03 H	176	22.14	14.86
3	#17235.00	56.1 PK	74.0	-17.9	1.70 H	178	32.87	23.23
4	#17235.00	43.8 AV	54.0	-10.2	1.70 H	178	20.57	23.23

ANTENNA POLARITY & TEST DISTANCE: VERTICAL AT 3 M

NO.	FREQ. (MHz)	EMISSION LEVEL (dBuV/m)	LIMIT (dBuV/m)	MARGIN (dB)	ANTENNA HEIGHT (m)	TABLE ANGLE (Degree)	RAW VALUE (dBuV)	CORRECTION FACTOR (dB/m)
1	11490.00	53.9 PK	74.0	-20.1	1.06 V	59	39.04	14.86
2	11490.00	43.5 AV	54.0	-10.5	1.06 V	59	28.64	14.86
3	#17235.00	57.0 PK	74.0	-17.0	1.11 V	132	33.77	23.23
4	#17235.00	44.4 AV	54.0	-9.6	1.11 V	132	21.17	23.23

REMARKS:

1. Emission Level(dBuV/m) = Raw Value(dBuV) + Correction Factor(dB/m)
2. Correction Factor(dB/m) = Antenna Factor(dB/m) + Cable Factor(dB) – Pre-Amplifier Factor(dB)
3. The other emission levels were very low against the limit.
4. Margin value = Emission Level – Limit value
5. "#": The radiated frequency is out of the restricted band.

CHANNEL	TX Channel 157	DETECTOR FUNCTION	Peak (PK)
FREQUENCY RANGE	1GHz ~ 40GHz		Average (AV)

ANTENNA POLARITY & TEST DISTANCE: HORIZONTAL AT 3 M

NO.	FREQ. (MHz)	EMISSION LEVEL (dBuV/m)	LIMIT (dBuV/m)	MARGIN (dB)	ANTENNA HEIGHT (m)	TABLE ANGLE (Degree)	RAW VALUE (dBuV)	CORRECTION FACTOR (dB/m)
1	11570.00	48.7 PK	74.0	-25.3	1.02 H	173	33.50	15.20
2	11570.00	36.7 AV	54.0	-17.3	1.02 H	173	21.50	15.20
3	#17355.00	56.0 PK	74.0	-18.0	1.78 H	167	32.44	23.56
4	#17355.00	43.5 AV	54.0	-10.5	1.78 H	167	19.94	23.56

ANTENNA POLARITY & TEST DISTANCE: VERTICAL AT 3 M

NO.	FREQ. (MHz)	EMISSION LEVEL (dBuV/m)	LIMIT (dBuV/m)	MARGIN (dB)	ANTENNA HEIGHT (m)	TABLE ANGLE (Degree)	RAW VALUE (dBuV)	CORRECTION FACTOR (dB/m)
1	11570.00	54.0 PK	74.0	-20.0	1.05 V	58	38.80	15.20
2	11570.00	43.6 AV	54.0	-10.4	1.05 V	58	28.40	15.20
3	#17355.00	57.3 PK	74.0	-16.7	1.07 V	126	33.74	23.56
4	#17355.00	45.1 AV	54.0	-8.9	1.07 V	126	21.54	23.56

REMARKS:

1. Emission Level(dBuV/m) = Raw Value(dBuV) + Correction Factor(dB/m)
2. Correction Factor(dB/m) = Antenna Factor(dB/m) + Cable Factor(dB) – Pre-Amplifier Factor(dB)
3. The other emission levels were very low against the limit.
4. Margin value = Emission Level – Limit value
5. "#": The radiated frequency is out of the restricted band.

CHANNEL	TX Channel 165	DETECTOR FUNCTION	Peak (PK)
FREQUENCY RANGE	1GHz ~ 40GHz		Average (AV)

ANTENNA POLARITY & TEST DISTANCE: HORIZONTAL AT 3 M

NO.	FREQ. (MHz)	EMISSION LEVEL (dBuV/m)	LIMIT (dBuV/m)	MARGIN (dB)	ANTENNA HEIGHT (m)	TABLE ANGLE (Degree)	RAW VALUE (dBuV)	CORRECTION FACTOR (dB/m)
1	11650.00	48.8 PK	74.0	-25.2	1.01 H	146	33.40	15.40
2	11650.00	36.7 AV	54.0	-17.3	1.01 H	146	21.30	15.40
3	#17475.00	56.1 PK	74.0	-17.9	1.78 H	160	32.01	24.09
4	#17475.00	43.6 AV	54.0	-10.4	1.78 H	160	19.51	24.09

ANTENNA POLARITY & TEST DISTANCE: VERTICAL AT 3 M

NO.	FREQ. (MHz)	EMISSION LEVEL (dBuV/m)	LIMIT (dBuV/m)	MARGIN (dB)	ANTENNA HEIGHT (m)	TABLE ANGLE (Degree)	RAW VALUE (dBuV)	CORRECTION FACTOR (dB/m)
1	11650.00	53.7 PK	74.0	-20.3	1.02 V	71	38.30	15.40
2	11650.00	43.4 AV	54.0	-10.6	1.02 V	71	28.00	15.40
3	#17475.00	57.3 PK	74.0	-16.7	1.05 V	113	33.21	24.09
4	#17475.00	44.9 AV	54.0	-9.1	1.05 V	113	20.81	24.09

REMARKS:

1. Emission Level(dBuV/m) = Raw Value(dBuV) + Correction Factor(dB/m)
2. Correction Factor(dB/m) = Antenna Factor(dB/m) + Cable Factor(dB) – Pre-Amplifier Factor(dB)
3. The other emission levels were very low against the limit.
4. Margin value = Emission Level – Limit value
5. "#": The radiated frequency is out of the restricted band.

Below 1GHz Data
802.11n (HT20)

CHANNEL	TX Channel 149	DETECTOR FUNCTION	Quasi-Peak (QP)
FREQUENCY RANGE	Below 1GHz		

ANTENNA POLARITY & TEST DISTANCE: HORIZONTAL AT 3 M

NO.	FREQ. (MHz)	EMISSION LEVEL (dBuV/m)	LIMIT (dBuV/m)	MARGIN (dB)	ANTENNA HEIGHT (m)	TABLE ANGLE (Degree)	RAW VALUE (dBuV)	CORRECTION FACTOR (dB/m)
1	63.95	29.3 QP	40.0	-10.7	1.00 H	299	43.48	-14.15
2	206.30	29.9 QP	43.5	-13.6	1.00 H	253	45.96	-16.10
3	250.68	29.1 QP	46.0	-16.9	1.00 H	277	43.08	-13.99
4	299.85	24.1 QP	46.0	-21.9	1.00 H	276	36.10	-12.04
5	399.86	28.5 QP	46.0	-17.5	1.00 H	279	37.85	-9.39
6	817.79	28.9 QP	46.0	-17.1	1.00 H	313	29.17	-0.25

ANTENNA POLARITY & TEST DISTANCE: VERTICAL AT 3 M

NO.	FREQ. (MHz)	EMISSION LEVEL (dBuV/m)	LIMIT (dBuV/m)	MARGIN (dB)	ANTENNA HEIGHT (m)	TABLE ANGLE (Degree)	RAW VALUE (dBuV)	CORRECTION FACTOR (dB/m)
1	64.05	34.5 QP	40.0	-5.5	1.00 V	154	48.69	-14.16
2	133.64	25.8 QP	43.5	-17.7	1.00 V	303	39.47	-13.70
3	204.26	22.3 QP	43.5	-21.2	1.00 V	321	38.37	-16.09
4	366.54	23.5 QP	46.0	-22.6	1.20 V	190	33.69	-10.24
5	499.82	25.9 QP	46.0	-20.2	1.20 V	164	32.68	-6.83
6	834.08	30.7 QP	46.0	-15.3	1.20 V	194	30.89	-0.15

REMARKS:

1. Emission Level(dBuV/m) = Raw Value(dBuV) + Correction Factor(dB/m)
2. Correction Factor(dB/m) = Antenna Factor(dB/m) + Cable Factor(dB) – Pre-Amplifier Factor(dB)
3. The other emission levels were very low against the limit.
4. Margin value = Emission Level – Limit value

4.2 Conducted Emission Measurement

4.2.1 Limits of Conducted Emission Measurement

Frequency (MHz)	Conducted Limit (dBuV)	
	Quasi-peak	Average
0.15 - 0.5	66 - 56	56 - 46
0.50 - 5.0	56	46
5.0 - 30.0	60	50

Note: 1. The lower limit shall apply at the transition frequencies.

2. The limit decreases in line with the logarithm of the frequency in the range of 0.15 to 0.50MHz.

4.2.2 Test Instruments

DESCRIPTION & MANUFACTURER	MODEL NO.	SERIAL NO.	CALIBRATED DATE	CALIBRATED UNTIL
Test Receiver R&S	ESCS 30	100375	May 06, 2015	May 05, 2016
Line-Impedance Stabilization Network (for EUT) SCHWARZBECK	NSLK-8127	8127-522	Sep. 01, 2015	Aug. 31, 2016
Line-Impedance Stabilization Network (for Peripheral) R&S	ENV216	100072	June 11, 2015	June 10, 2016
RF Cable	5D-FB	COCCAB-001	Mar. 09, 2015	Mar. 08, 2016
50 ohms Terminator	E1-011311	09	Nov. 27, 2014	Nov. 26, 2015
50 ohms Terminator	N/A	EMC-02	Sep. 30, 2014	Sep. 29, 2015
Software BVADT	BVADT_Cond_ V7.3.7.3	NA	NA	NA

Note:

1. The calibration interval of the above test instruments are 12 months and the calibrations are traceable to NML/ROC and NIST/USA.
2. The test was performed in Shielded Room No. C.
- 3 The VCCI Con C Registration No. is C-3611.
- 4 Tested Date: Sep. 17, 2015

4.2.3 Test Procedure

- a. The EUT was placed 0.4 meters from the conducting wall of the shielded room with EUT being connected to the power mains through a line impedance stabilization network (LISN). Other support units were connected to the power mains through another LISN. The two LISNs provide 50 ohm/ 50uH of coupling impedance for the measuring instrument.
- b. Both lines of the power mains connected to the EUT were checked for maximum conducted interference.
- c. The frequency range from 150kHz to 30MHz was searched. Emission levels under (Limit - 20dB) was not recorded.

NOTE: All modes of operation were investigated and the worst-case emissions are reported.

4.2.4 Deviation from Test Standard

No deviation.

4.2.5 Test Setup

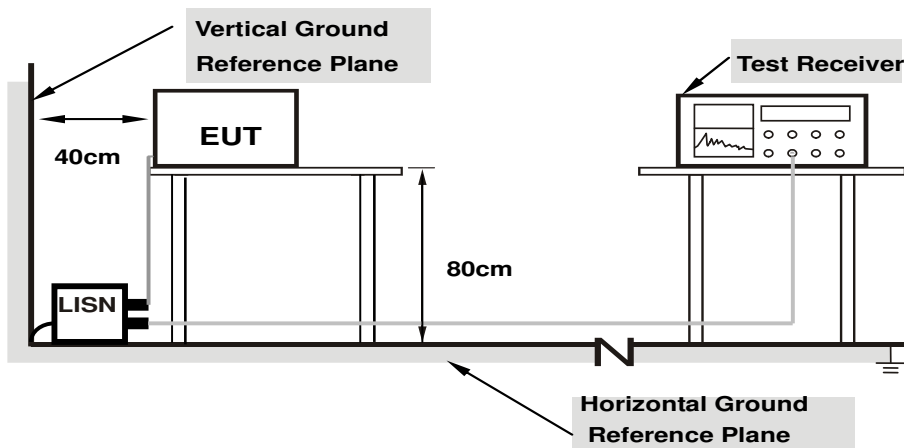

- Note:**
- 1.Support units were connected to second LISN.
 - 2.Both of LISNs (AMN) are 80 cm from EUT and at least 80 from other units and other metal planes

For the actual test configuration, please refer to the attached file (Test Setup Photo).

4.2.6 EUT Operating Condition

Same as 4.1.6.

4.2.7 Test Results

Phase	Line (L)	Detector Function	Quasi-Peak (QP) / Average (AV)
-------	----------	-------------------	--------------------------------

Phase Of Power : Line (L)										
No	Frequency (MHz)	Correction Factor (dB)	Reading Value (dBuV)		Emission Level (dBuV)		Limit (dBuV)		Margin (dB)	
			Q.P.	AV.	Q.P.	AV.	Q.P.	AV.	Q.P.	AV.
1	0.45859	0.14	33.78	26.54	33.92	26.68	56.72	46.72	-22.80	-20.04
2	0.58750	0.15	32.79	23.92	32.94	24.07	56.00	46.00	-23.06	-21.93
3	0.67344	0.15	32.91	24.60	33.06	24.75	56.00	46.00	-22.94	-21.25
4	0.80234	0.16	27.91	20.58	28.07	20.74	56.00	46.00	-27.93	-25.26
5	7.46094	0.42	26.34	19.88	26.76	20.30	60.00	50.00	-33.24	-29.70
6	18.76563	0.78	31.22	24.76	32.00	25.54	60.00	50.00	-28.00	-24.46

Remarks:

1. Q.P. and AV. are abbreviations of quasi-peak and average individually.
2. The emission levels of other frequencies were very low against the limit.
3. Margin value = Emission level – Limit value
4. Correction factor = Insertion loss + Cable loss
5. Emission Level = Correction Factor + Reading Value

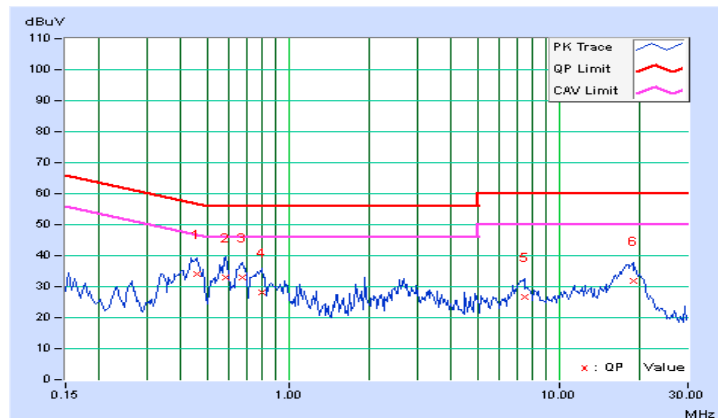

Phase	Neutral (N)	Detector Function	Quasi-Peak (QP) / Average (AV)
-------	-------------	-------------------	--------------------------------

Phase Of Power : Neutral (N)										
No	Frequency (MHz)	Correction Factor (dB)	Reading Value (dBuV)		Emission Level (dBuV)		Limit (dBuV)		Margin (dB)	
			Q.P.	AV.	Q.P.	AV.	Q.P.	AV.	Q.P.	AV.
1	0.45469	0.12	33.38	26.44	33.50	26.56	56.79	46.79	-23.29	-20.23
2	0.57969	0.13	33.58	25.42	33.71	25.55	56.00	46.00	-22.29	-20.45
3	0.65391	0.14	32.82	21.41	32.96	21.55	56.00	46.00	-23.04	-24.45
4	0.79453	0.15	28.19	19.21	28.34	19.36	56.00	46.00	-27.66	-26.64
5	7.59766	0.43	26.18	20.10	26.61	20.53	60.00	50.00	-33.39	-29.47
6	17.57422	0.77	33.09	26.84	33.86	27.61	60.00	50.00	-26.14	-22.39

Remarks:

1. Q.P. and AV. are abbreviations of quasi-peak and average individually.
2. The emission levels of other frequencies were very low against the limit.
3. Margin value = Emission level – Limit value
4. Correction factor = Insertion loss + Cable loss
5. Emission Level = Correction Factor + Reading Value

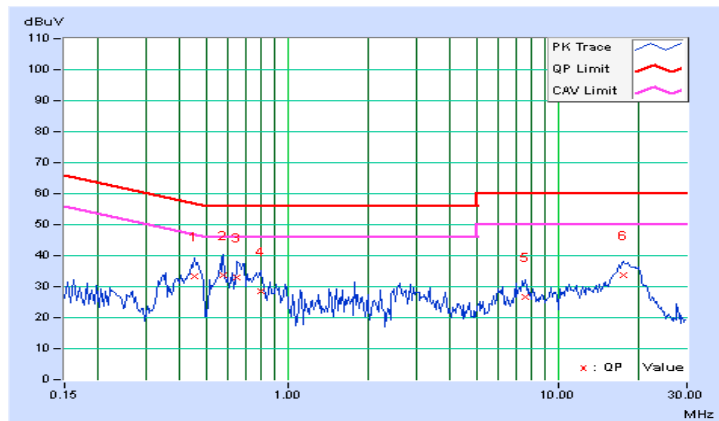

4.3 Transmit Power Measurement

4.3.1 Limits of Transmit Power Measurement

Operation Band	EUT Category		LIMIT
U-NII-1		Outdoor Access Point	1 Watt (30 dBm) (Max. e.i.r.p \leq 125mW(21 dBm) at any elevation angle above 30 degrees as measured from the horizon)
		Fixed point-to-point Access Point	1 Watt (30 dBm)
	√	Indoor Access Point	1 Watt (30 dBm)
		Mobile and Portable client device	250mW (24 dBm)
U-NII-2A	---		250mW (24 dBm) or 11 dBm+10 log B*
U-NII-2C	---		250mW (24 dBm) or 11 dBm+10 log B*
U-NII-3	√		1 Watt (30 dBm)

*B is the 26 dB emission bandwidth in megahertz

4.3.2 Test Setup

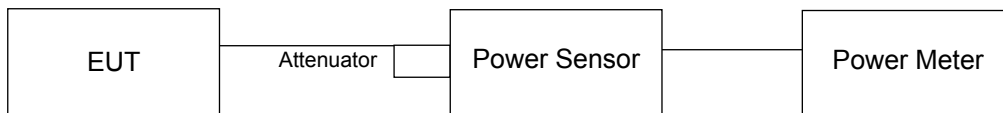

4.3.3 Test Instruments

Refer to section 4.1.2 to get information of above instrument.

4.3.4 Test Procedure

Method PM is used to perform output power measurement, trigger and gating function of wide band power meter is enabled to measure max output power of TX on burst. Duty factor is not added to measured value.

4.3.5 Deviation from Test Standard

No deviation.

4.3.6 EUT Operating Condition

The software provided by client to enable the EUT under transmission condition continuously at lowest, middle and highest channel frequencies individually.

4.3.7 Test Result

802.11n (HT20)

Chan.	Chan. Freq. (MHz)	Average Power (mW)	Average Power (dBm)	Limit (dBm)	Pass / Fail
36	5180	26.915	14.30	30	Pass
40	5200	24.547	13.90	30	Pass
48	5240	24.547	13.90	30	Pass
149	5745	49.659	16.96	30	Pass
157	5785	44.668	16.50	30	Pass
165	5825	41.687	16.20	30	Pass

4.4 Peak Power Spectral Density Measurement

4.4.1 Limits of Peak Power Spectral Density Measurement

Operation Band	EUT Category		LIMIT
U-NII-1		Outdoor Access Point	17dBm/ MHz
		Fixed point-to-point Access Point	
	√	Indoor Access Point	
		Mobile and Portable client device	11dBm/ MHz
U-NII-2A	---		11dBm/ MHz
U-NII-2C	---		11dBm/ MHz
U-NII-3	√		30dBm/ 500kHz

4.4.2 Test Setup

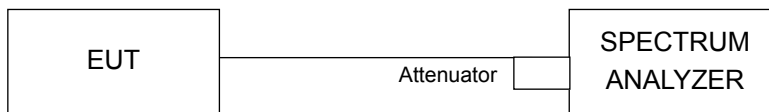

4.4.3 Test Instruments

Refer to section 4.1.2 to get information of above instrument.

4.4.4 Test Procedure

For U-NII-1 band:

Using method SA-1

1. Set span to encompass the entire emission bandwidth (EBW) of the signal.
2. Set RBW = 1 MHz, Set VBW ≥ 3 MHz, Detector = RMS
3. Sweep time = auto, trigger set to “free run”.
4. Trace average at least 100 traces in power averaging mode.
5. Record the max value

For U-NII-3 band:

1. Set span to encompass the entire emission bandwidth (EBW) of the signal.
2. Set RBW = 300 kHz, Set VBW ≥ 1 MHz, Detector = RMS
3. Use the peak marker function to determine the maximum power level in any 300 kHz band segment within the fundamental EBW.
4. Scale the observed power level to an equivalent value in 500 kHz by adjusting (reducing) the measured power by a bandwidth correction factor (BWCF) where $BWCF = 10\log(500\text{ kHz}/300\text{kHz})$
5. Sweep time = auto, trigger set to “free run”.
6. Trace average at least 100 traces in power averaging mode.
7. Record the max value

4.4.5 Deviation from Test Standard

No deviation.

4.4.6 EUT Operating Condition

Same as Item 4.3.6.

**For U-NII-3 Band
802.11n (HT20)**

Chan.	Chan. Freq. (MHz)	PSD		Total PSD (dBm/500kHz)	Limit (dBm/500kHz)	Pass /Fail
		(dBm/300kHz)	(dBm/500kHz)			
149	5745	-4.54	-2.32	-2.32	30	Pass
157	5785	-4.84	-2.62	-2.62	30	Pass
165	5825	-4.75	-2.53	-2.53	30	Pass

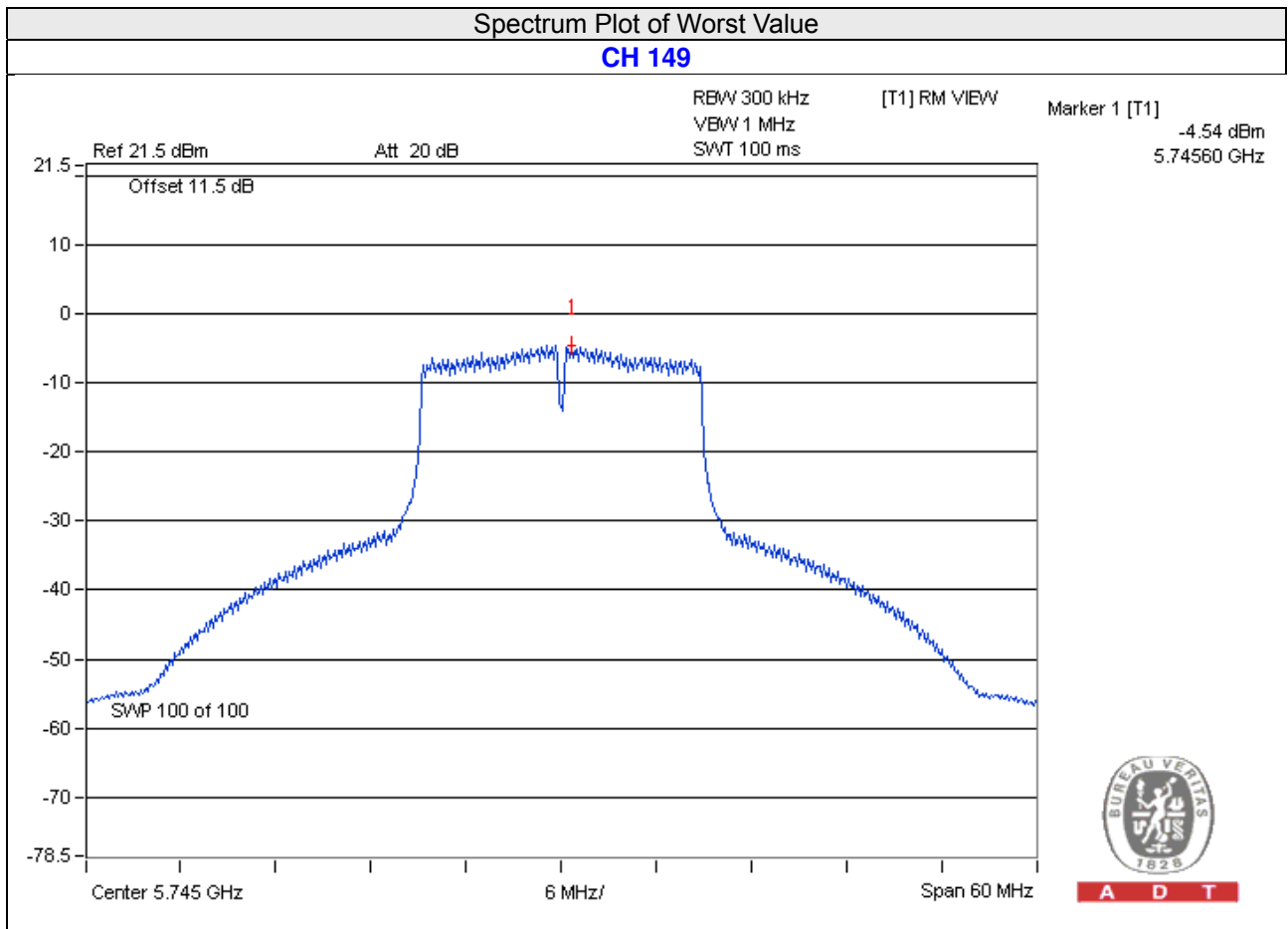

4.5 Frequency Stability Measurement

4.5.1 Limits of Frequency Stability Measurement

The frequency of the carrier signal shall be maintained within band of operation

4.5.2 Test Setup

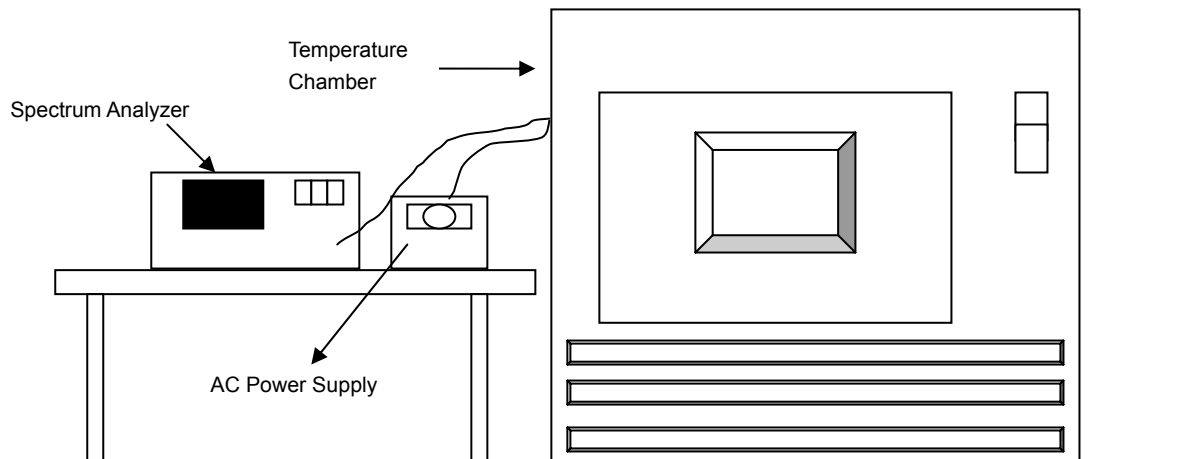

4.5.3 Test Instruments

Refer to section 4.1.2 to get information of above instrument.

4.5.4 Test Procedure

- The EUT was placed inside the environmental test chamber and powered by nominal AC voltage.
- Turn the EUT on and couple its output to a spectrum analyzer.
- Turn the EUT off and set the chamber to the highest temperature specified.
- Allow sufficient time (approximately 30 min) for the temperature of the chamber to stabilize, turn the EUT on and measure the operating frequency after 2, 5, and 10 minutes.
- Repeat step 2 and 3 with the temperature chamber set to the lowest temperature.
- The test chamber was allowed to stabilize at +20 degree C for a minimum of 30 minutes. The supply voltage was then adjusted on the EUT from 85% to 115% and the frequency record.

4.5.5 Deviation from Test Standard

No deviation.

4.5.6 EUT Operating Condition

Set the EUT transmit at un-modulation mode to test frequency stability.

4.5.7 Test Results

FREQUENCY STABILITY VERSUS TEMP.									
OPERATING FREQUENCY: 5180MHz									
TEMP. (°C)	POWER SUPPLY (Vac)	0 MINUTE		2 MINUTE		5 MINUTE		10 MINUTE	
		Measured Frequency (MHz)	Frequency Drift (%)	Measured Frequency (MHz)	Frequency Drift (%)	Measured Frequency (MHz)	Frequency Drift (%)	Measured Frequency (MHz)	Frequency Drift (%)
50	120	5179.9842	-0.00031	5179.9839	-0.00031	5179.9827	-0.00033	5179.9858	-0.00027
40	120	5179.9773	-0.00044	5179.9785	-0.00042	5179.9803	-0.00038	5179.9792	-0.00040
30	120	5180.0196	0.00038	5180.0163	0.00031	5180.0159	0.00031	5180.0178	0.00034
20	120	5180.0009	0.00002	5179.998	-0.00004	5179.9972	-0.00005	5179.9989	-0.00002
10	120	5180.0096	0.00019	5180.0087	0.00017	5180.0068	0.00013	5180.0085	0.00016
0	120	5180.009	0.00017	5180.009	0.00017	5180.0062	0.00012	5180.0074	0.00014
-10	120	5180.0204	0.00039	5180.02	0.00039	5180.0182	0.00035	5180.023	0.00044
-20	120	5179.9768	-0.00045	5179.9755	-0.00047	5179.9735	-0.00051	5179.9735	-0.00051
-30	120	5179.9969	-0.00006	5179.996	-0.00008	5179.9994	-0.00001	5179.9959	-0.00008

FREQUENCY STABILITY VERSUS VOLTAGE									
OPERATING FREQUENCY: 5180MHz									
TEMP. (°C)	POWER SUPPLY (Vac)	0 MINUTE		2 MINUTE		5 MINUTE		10 MINUTE	
		Measured Frequency (MHz)	Frequency Drift (%)	Measured Frequency (MHz)	Frequency Drift (%)	Measured Frequency (MHz)	Frequency Drift (%)	Measured Frequency (MHz)	Frequency Drift (%)
20	138	5179.9999	0.00000	5179.9985	-0.00003	5179.9963	-0.00007	5179.998	-0.00004
	120	5180.0009	0.00002	5179.998	-0.00004	5179.9972	-0.00005	5179.9989	-0.00002
	102	5180.0007	0.00001	5179.9971	-0.00006	5179.9969	-0.00006	5179.9996	-0.00001

4.6 6dB Bandwidth Measurement

4.6.1 Limits of 6dB Bandwidth Measurement

The minimum of 6dB Bandwidth Measurement is 0.5MHz.

4.6.2 Test Setup

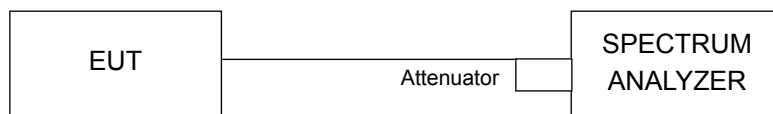

4.6.3 Test Instruments

Refer to section 4.1.2 to get information of above instrument.

4.6.4 Test Procedure

MEASUREMENT PROCEDURE REF

- a. Set resolution bandwidth (RBW) = 100kHz
- b. Set the video bandwidth (VBW) $\geq 3 \times$ RBW, Detector = Peak.
- c. Trace mode = max hold.
- d. Sweep = auto couple.
- e. Measure the maximum width of the emission that is constrained by the frequencies associated with the two amplitude points (upper and lower) that are attenuated by 6 dB relative to the maximum level measured in the fundamental emission

4.6.5 Deviation from Test Standard

No deviation.

4.6.6 EUT Operating Condition

The software provided by client to enable the EUT under transmission condition continuously at lowest, middle and highest channel frequencies individually.

4.6.7 Test Results

802.11n (HT20)

Channel	Frequency (MHz)	6dB Bandwidth (MHz)	Minimum Limit (MHz)	Pass / Fail
149	5745	17.09	0.5	PASS
157	5785	17.09	0.5	PASS
165	5825	17.07	0.5	PASS

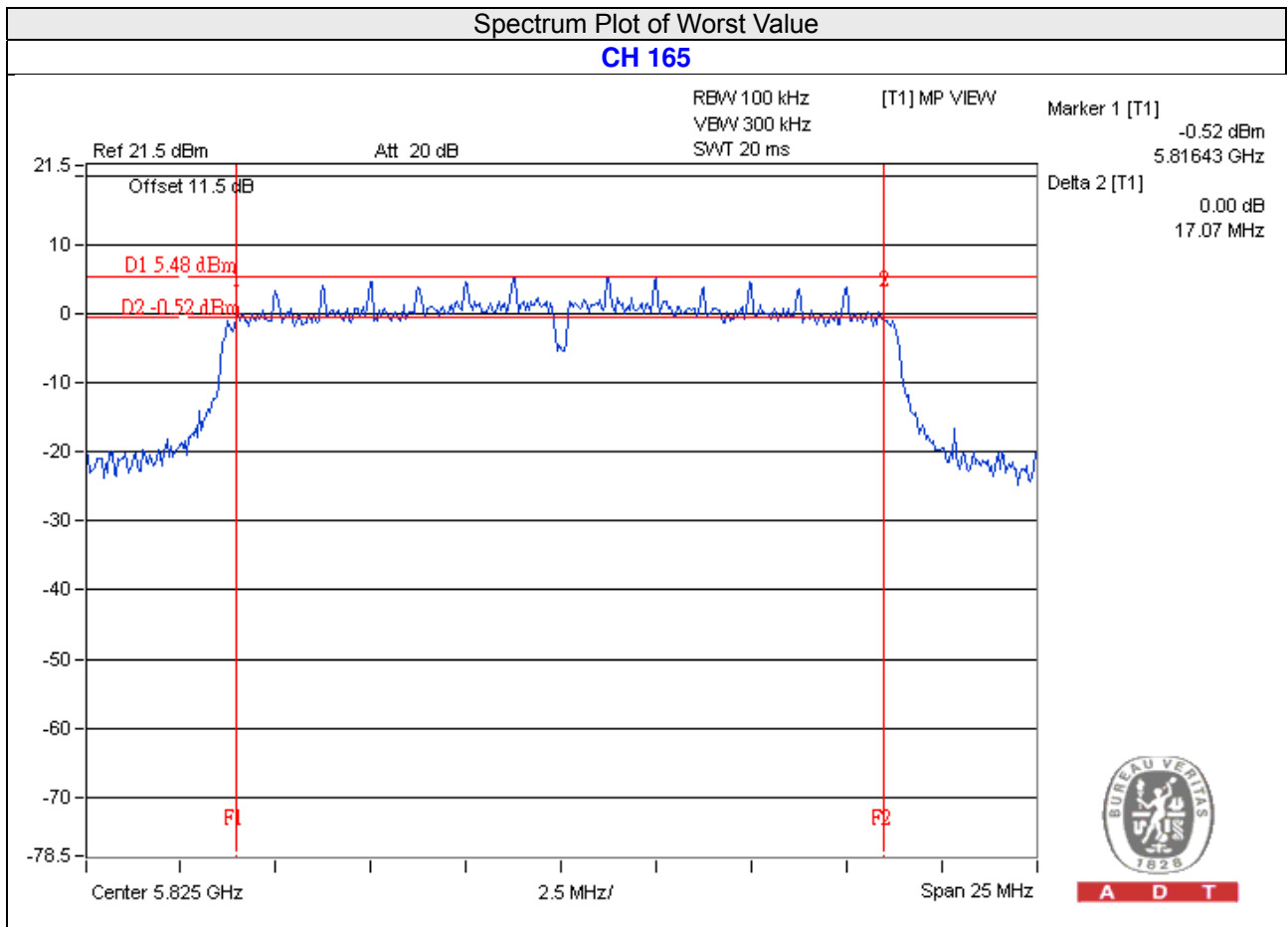

5 Pictures of Test Arrangements

Please refer to the attached file (Test Setup Photo).



Appendix – Information on the Testing Laboratories

We, Bureau Veritas Consumer Products Services (H.K.) Ltd., Taoyuan Branch, were founded in 1988 to provide our best service in EMC, Radio, Telecom and Safety consultation. Our laboratories are accredited and approved according to ISO/IEC 17025.

If you have any comments, please feel free to contact us at the following:

Linko EMC/RF Lab

Tel: 886-2-26052180

Fax: 886-2-26051924

Hsin Chu EMC/RF Lab/Telecom Lab

Tel: 886-3-5935343

Fax: 886-3-5935342

Hwa Ya EMC/RF/Safety

Tel: 886-3-3183232

Fax: 886-3-3270892

Email: service.adt@tw.bureauveritas.com

Web Site: www.bureauveritas-adt.com

The address and road map of all our labs can be found in our web site also.

--- END ---