



FCC 47 CFR PART 15 SUBPART C AND ANSI C63.4 : 2003

TEST REPORT

For

Microsoft Office Communicator USB Earbud

Model : 1107

Trade Name : Microsoft

Issued for

Microsoft Corporation

One Microsoft Way, Redmond, WA 98052-6399, United States

Issued by

Compliance Certification Services Inc.

Hsinchu Lab.

Rm. 258, Bldg. 17, NO.195, Sec.4 Chung Hsing Rd.,
ChuTung Chen, Hsinchu, Taiwan 310, R.O.C

TEL: (03) 591-0068

FAX: (03) 582-5720



Note: This report shall not be reproduced except in full, without the written approval of Compliance Certification Services Inc. Ltd. This document may be altered or revised by Compliance Certification Services Inc. personnel only, and shall be noted in the revision section of the document.



TABLE OF CONTENTS

| TITLE | PAGE NO. |
|--|--------------|
| 1. TEST REPORT CERTIFICATION | 3 |
| 2. EUT DESCRIPTION | 4 |
| 2.1 DESCRIPTION OF EUT & POWER..... | 4 |
| 3. DESCRIPTION OF TEST MODES | 5 |
| 4. TEST METHODOLOGY | 6 |
| 5. FACILITIES AND ACCREDITATIONS | 7 |
| 5.1 FACILITIES | 7 |
| 5.2 EQUIPMENT | 7 |
| 5.3 LABORATORY ACCREDITATIONS LISTINGS..... | 7 |
| 5.4 TABLE OF ACCREDITATIONS AND LISTINGS | 8 |
| 6. CALIBRATION AND UNCERTAINTY | 9 |
| 6.1 MEASURING INSTRUMENT CALIBRATION | 9 |
| 6.2 MEASUREMENT UNCERTAINTY..... | 9 |
| 7. SETUP OF EQUIPMENT UNDER TEST | 10-11 |
| 8. APPLICABLE LIMITS AND TEST RESULTS | 12 |
| 8.1 20dB BANDWIDTH FOR HOPPING..... | 12-19 |
| 8.2 MAXIMUM PEAK OUTPUT POWER | 20-27 |
| 8.3 HOPPING CHANNEL SEPARATION..... | 28-29 |
| 8.4 NUMBER OF HOPPING FREQUENCY USED | 30-31 |
| 8.5 DWELL TIME ON EACH CHANNEL | 32-35 |
| 8.6 CONDUCTED SPURIOUS EMISSION..... | 36-39 |
| 8.7 RADIATED EMISSIONS | 40 |
| 8.7.1 TRANSMITTER RADIATED SUPURIOUS EMSSIONS..... | 40-43 |
| 8.7.2 WORST-CASE RADIATED EMISSION BELOW 1 GHz | 44 |
| 8.7.3 TRANSMITTER RADIATED EMISSION ABOVE 1 GHz..... | 45-47 |
| 8.7.4 RESTRICTED BAND EDGES..... | 48-51 |
| 8.9 POWERLINE CONDUCTED EMISSIONS | 52-55 |
| 9. ANTENNA REQUIREMENT | 56 |
| 9.1 STANDARD APPLICABLE..... | 56 |
| 9.2 ANTENNA CONNECTED CONSTRUCTION..... | 56 |
| APPENDIX SETUP PHOTOS | 57-62 |



1. TEST REPORT CERTIFICATION

Applicant : Microsoft Corporation
Address : One Microsoft Way, Redmond, WA 98052-6399, United States
Equipment Under Test : Microsoft Office Communicator USB Earbud
Model : 1107
Trade Name : Microsoft
Tested Date : November 16 ~ 26, 2006

| APPLICABLE STANDARD | |
|---|-------------------------|
| STANDARD | TEST RESULT |
| FCC Part 15 Subpart C:2004 AND ANSI C63.4:2003 | No non-compliance noted |

Approved by:

Reviewed by:

C. F. Wu



S. B. Lu auth

C. F. Wu
 Manager of Hsinchu Laboratory
 Compliance Certification Services Inc.

Alan Fan
 Test Engineer of Hsinchu Laboratory
 Compliance Certification Services Inc.

WE HEREBY CERTIFY THAT: The measurements shown in the attachment were made in accordance with the procedures indicated, and the energy emitted by the equipment was found to be within the limits applicable. We assume full responsibility for the accuracy and completeness of these measurements and vouch for the qualifications of all persons taking them.



2. EUT DESCRIPTION

2.1 DESCRIPTION OF EUT & POWER

| | |
|-----------------------------------|--|
| Product Name | Microsoft Office Communicator USB Earbud |
| Model Number | 1107 |
| Frequency Range | 2402MHz to 2480MHz $f = 2402 + n\text{MHz}$, $n = 0, \dots, 78$ |
| Transmit Power | 3.88dBm |
| Channel Spacing | 1MHz |
| Channel Number | 79 |
| Air Data Rate | GFSK (1Mbps) |
| Type of Modulation | Frequency Hopping Spread Spectrum |
| Frequency Selection | by software / firmware |
| Transmitter Classification | portable device |
| Antenna Type | PCB Antenna, Antenna Gain : 2.88dBi |
| Power Source | Normal Mode: 3.7VDC(Battery Powered) Charging Mode: 5.0VDC (From Notebook PC, Powered From Host Device) |
| RF Exposure Evaluation | Since the EUT is classed portable device, and the maximum peak power is 3.88dBm (<13.6dBm), the MPE evaluation is not required and no SAR consideration applied. |

Remark:

- 1. The sample selected for test was engineering sample that approximated to production product and was provided by manufacturer.*
- 2. This submittal(s) (test report) is intended for FCC ID: C3K1107 filing to comply with Section 15.207,15.209 and 15.247 of the FCC Part 15, Subpart C Rules.*
- 3. For more details, please refer to the User's manual of the EUT.*



3. DESCRIPTION OF TEST MODES

Radiated Emission Test (Below 1 GHz):

- Pre-Scan has been conducted to determine the worst-case mode from all possible combinations between available modulations, data rates and antenna ports (if EUT with antenna diversity architecture).
- Following channel(s) was (were) selected for the final test as listed below.

| Tested Channel | Modulation Technology | Modulation Type | Packet Type |
|----------------|-----------------------|-----------------|-------------|
| Low | FHSS | GFSK | DH1 |

Radiated Emission Test (Above 1 GHz):

- Pre-Scan has been conducted to determine the worst-case mode from all possible combinations between available modulations, data rates and antenna ports (if EUT with antenna diversity architecture).
- Following channel(s) was (were) selected for the final test as listed below.

| Tested Channel | Modulation Technology | Modulation Type | Packet Type |
|----------------|-----------------------|-----------------|-------------|
| Low, Mid, High | FHSS | GFSK | DH1 |

Bandedge Measurement :

- Pre-Scan has been conducted to determine the worst-case mode from all possible combinations between available modulations, data rates and antenna ports (if EUT with antenna diversity architecture).
- Following channel(s) was (were) selected for the final test as listed below.

| Tested Channel | Modulation Technology | Modulation Type | Packet Type |
|----------------|-----------------------|-----------------|-------------|
| Low, High | FHSS | GFSK | DH1 |

**Antenna Port Conducted Measurement :**

- Pre-Scan has been conducted to determine the worst-case mode from all possible combinations between available modulations, data rates and antenna ports (if EUT with antenna diversity architecture).
- Following channel(s) was (were) selected for the final test as listed below.

| Tested Channel | Modulation Technology | Modulation Type | Packet Type |
|----------------|-----------------------|-----------------|-------------|
| Low, Mid, High | FHSS | GFSK | DH1 |

Note : The field strength of spurious emission was measured in the following position: EUT stand-up position (Z axis), lie-down position (X,Y axis). The worst emission was found in lie-down position (Z axis) and the worst case was recorded.

4. TEST METHODOLOGY

The tests documented in this report were performed in accordance with ANSI C63.4 and FCC CFR 47 2.1046, 2046, 2.1047, 2.1049, 2.1051, 2.1053, 2.1055, 2.1057, 15.207, 15.209 and 15.247.



5. FACILITIES AND ACCREDITATIONS

5.1 FACILITIES

All measurement facilities used to collect the measurement data are located at Rm.258, Bldg.17, NO.195 , Sec. 4, Chung Hsing Rd., Chu-Tung Chen. Hsin-Chu, Taiwan 310 R.O.C.

The sites are constructed in conformance with the requirements of ANSI C63.7, ANSI C63.4 and CISPR Publication 22.

5.2 EQUIPMENT

Radiated emissions are measured with one or more of the following types of linearly polarized antennas: tuned dipole, biconical, log periodic, bi-log, and/or ridged waveguide, horn. Spectrum analyzers with preselectors and quasi-peak detectors are used to perform radiated measurements.

Conducted emissions are measured with Line Impedance Stabilization Networks and EMI Test Receivers.







Calibrated wideband preamplifiers, coaxial cables, and coaxial attenuators are also used for making measurements.

All receiving equipment conforms to CISPR Publication 16-1, "Radio Interference Measuring Apparatus and Measurement Methods."

5.3 LABORATORY ACCREDITATIONS LISTINGS

The test facilities used to perform radiated and conducted emissions tests are accredited by National Voluntary Laboratory Accreditation Program for the specific scope of accreditation under Lab Code: 200118-0 to perform Electromagnetic Interference tests according to FCC PART 15 AND CISPR 22 requirements. No part of this report may be used to claim or imply product endorsement by NVLAP or any agency of the US Government. In addition, the test facilities are listed with Federal Communications Commission (registration no: 90585 and 90584).

5.4 TABLE OF ACCREDITATIONS AND LISTINGS

| Country | Agency | Scope of Accreditation | Logo |
|---------|-----------------|---|---|
| USA | NVLAP | EN 55014-1, AS/NZS 1044, CNS 13783-1, IEC/CISPR 14-1, IEC/CISPR 22, EN 55022, EN 61000-3-2, EN 61000-3-3, ANSI C63.4, AS/NZS CISPR 22, AS/NZS 3548, IEC 61000-4-2/3/4/5/6/8/11 |  200118-0 |
| USA | FCC | 3/10 meter Open Area Test Sites to perform FCC Part 15/18 measurements |  90585, 90584 |
| Japan | VCCI | 3/10 meter Open Area Test Sites to perform conducted/radiated measurements |  R-1229/1189 C-1250/1294 |
| Taiwan | TAF | FCC Method-47 CFR Part 15 Subpart C,D,E CISPR 11, FCC METHOD-47 CFR Part 18, EN 55011, CNS 13803, CISPR 13, CNS 13439, FCC Method-47 CFR Part 15 Subpart B, CISPR 14-1, EN 55014-1, CNS 13783-1, EN 55015, CNS 14115, CISPR 22, EN 55022, VCCI CNS 13438, EN 61000-4-2/3/4/5/6/8/11 |  Testing Laboratory 0240 |
| Taiwan | BSMI | CNS 13803, CNS 13438, CNS 13439, CNS 13783-1, CNS 14115 |  SL2-IS-E-0002 SL2-IN-E-0002 SL2-A1-E-0002 SL2-R1-E-0002 SL2-R2-E-0002 SL2-L1-E-0002 |
| Canada | Industry Canada | RSS212, Issue 1 |  IC 4417-1 |

* No part of this report may be used to claim or imply product endorsement by NVLAP or any agency of the US Government.



6. CALIBRATION AND UNCERTAINTY

6.1 MEASURING INSTRUMENT CALIBRATION

The measuring equipment utilized to perform the tests documented in this report has been calibrated in accordance with the manufacturer's recommendations, and is traceable to recognized national standards.

6.2 MEASUREMENT UNCERTAINTY

Where relevant, the following measurement uncertainty levels have been estimated for tests performed on the apparatus:

| PARAMETER | UNCERTAINTY |
|-----------------------------------|-------------|
| Radiated Emission, 30 to 1000 MHz | +/- 3.2 dB |
| Radiated Emission, 1 to 26.5GHz | +/- 3.2 dB |
| Power Line Conducted Emission | +/- 2.1 dB |

Uncertainty figures are valid to a confidence level of 95%



7. SETUP OF EQUIPMENT UNDER TEST

SUPPORT EQUIPMENT

| No. | Product | Manufacturer | Model No. | Serial No. | FCC ID |
|-----|-------------|--------------|---------------|--------------------------|-----------|
| 1 | Notebook PC | DELL | Latitude D610 | CN-0C4708-48643-625-5565 | E2K24BNHM |
| 2 | Printer | HP | Deskjet 948c | CN19T6S011 | FCC DoC |
| 3 | Mouse | Logitech | M-BJ58 | LNA14607307 | FCC DoC |

SETUP DIAGRAM FOR TESTS

RF Mode :

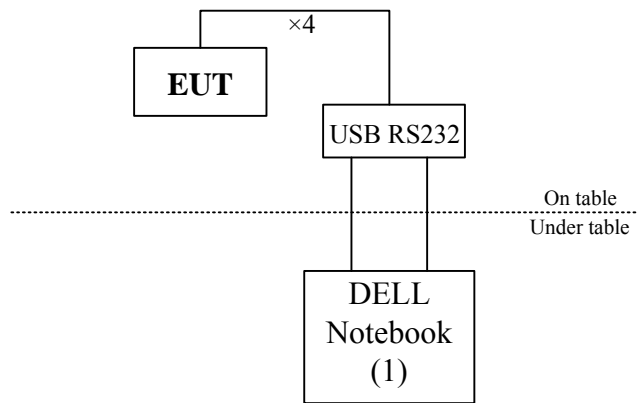

Normal Mode :

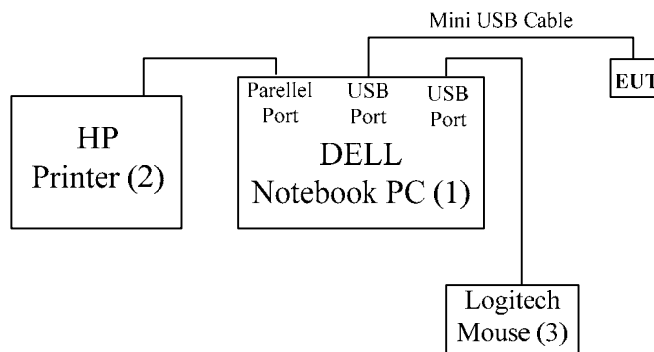



EUT OPERATING CONDITION

RF Mode :

1. Setup all computers like the setup diagram.
2. Run CSR Blue Test software (ver1.22).
3. Select the following settings,
 - Transport type: BCSP
 - USB Device: csm1
 - Baud rate: 57600
4. TX mode (GFSK)
 - TXSTART
 - LO Freq: 2402, 2441, 2480
 - Power (EXT, Int): 255, 61
 - Modulation Freq: 0
 - CFG PKT, Packet Type: 4
 - Packet Size: 27
5. RX mode (GFSK)
 - RXSTART1
 - LO Freq: 2402, 2441, 2480
 - RX Attenuation 0
 - CFG PKT, Packet Type: 4
 - Packet Size: 27
6. All of the function are under run.
7. Start test.

Normal Mode:

1. Setup all computers like the setup diagram.
2. All of the function are under run.
3. Start test.



8. APPLICABLE LIMITS AND TEST RESULTS

8.1 20dB BANDWIDTH FOR HOPPING

LIMIT

Limit : N/A

TEST EQUIPMENTS

| Description & Manufacturer | Model No. | Serial No. | Date of Calibration |
|-----------------------------------|-----------|-------------|---------------------|
| ROHDE & SCHWARZ SPECTRUM ANALYZER | FSEK30 | 835253/002 | October 18, 2006 |
| AGILENT SPECTRUM ANALYZER | E4446A | MY433601.32 | March 22, 2006 |

TEST SETUP

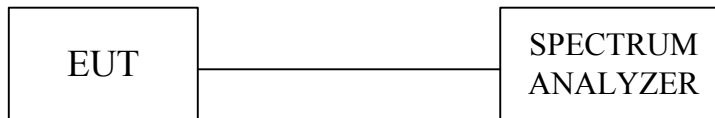

TEST PROCEDURE

The 20dB band width was measured with a spectrum analyzer connected to RF antenna connector(conducted measurement) while EUT was operating in transmit mode at the appropriate center frequency. The analyzer center frequency was set to the EUT carrier frequency, using the analyzer. Display Line and Marker Delta functions, the 20dB band width of the emission was determined.

**TEST RESULTS**

No non-compliance noted

Modulation Type: GFSK, CFG PKT Packet Type: 4 Packet Size: 27 (DH1)

| Channel | Channel Frequency (MHz) | 20dB Bandwidth (kHz) | Pass / Fail |
|---------|-------------------------|----------------------|-------------|
| Low | 2402 | 886.73 | N/A |
| Middle | 2441 | 886.76 | N/A |
| High | 2480 | 886.77 | N/A |

Modulation Type: GFSK, CFG PKT Packet Type: 11 Packet Size: 183 (DH3)

| Channel | Channel Frequency (MHz) | 20dB Bandwidth (kHz) | Pass / Fail |
|---------|-------------------------|----------------------|-------------|
| Low | 2402 | 936.87 | N/A |
| Middle | 2441 | 936.87 | N/A |
| High | 2480 | 936.87 | N/A |

Modulation Type: GFSK, CFG PKT Packet Type: 15 Packet Size: 339 (DH5)

| Channel | Channel Frequency (MHz) | 20dB Bandwidth (kHz) | Pass / Fail |
|---------|-------------------------|----------------------|-------------|
| Low | 2402 | 936.87 | N/A |
| Middle | 2441 | 936.87 | N/A |
| High | 2480 | 936.87 | N/A |



20dB BANDWIDTH

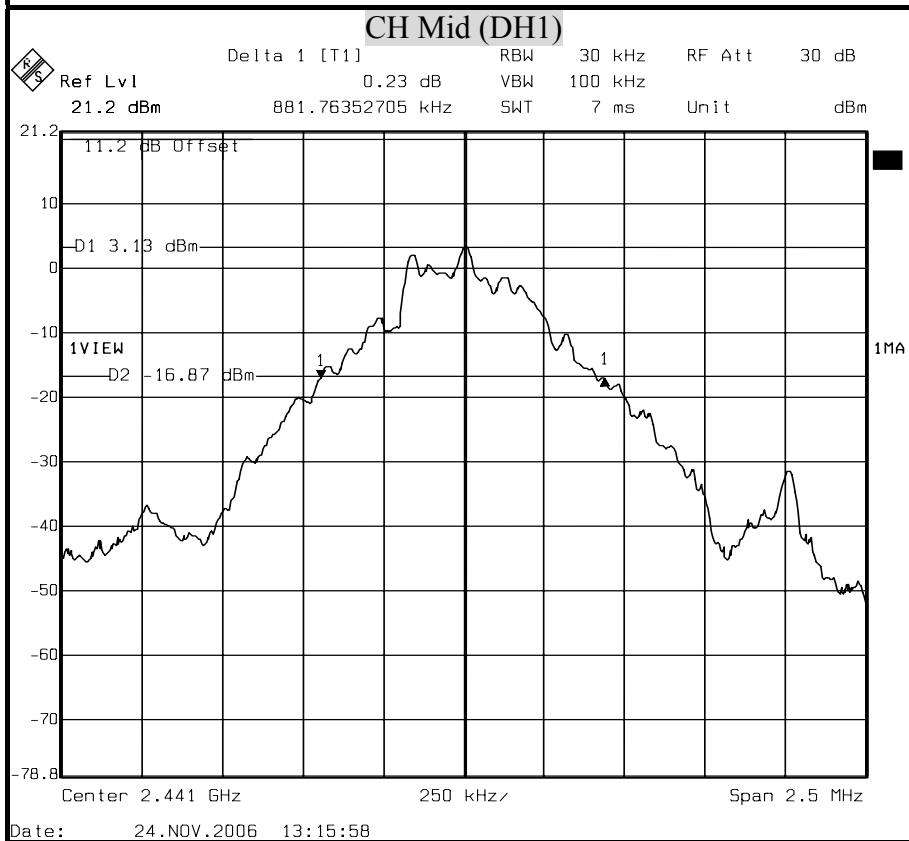
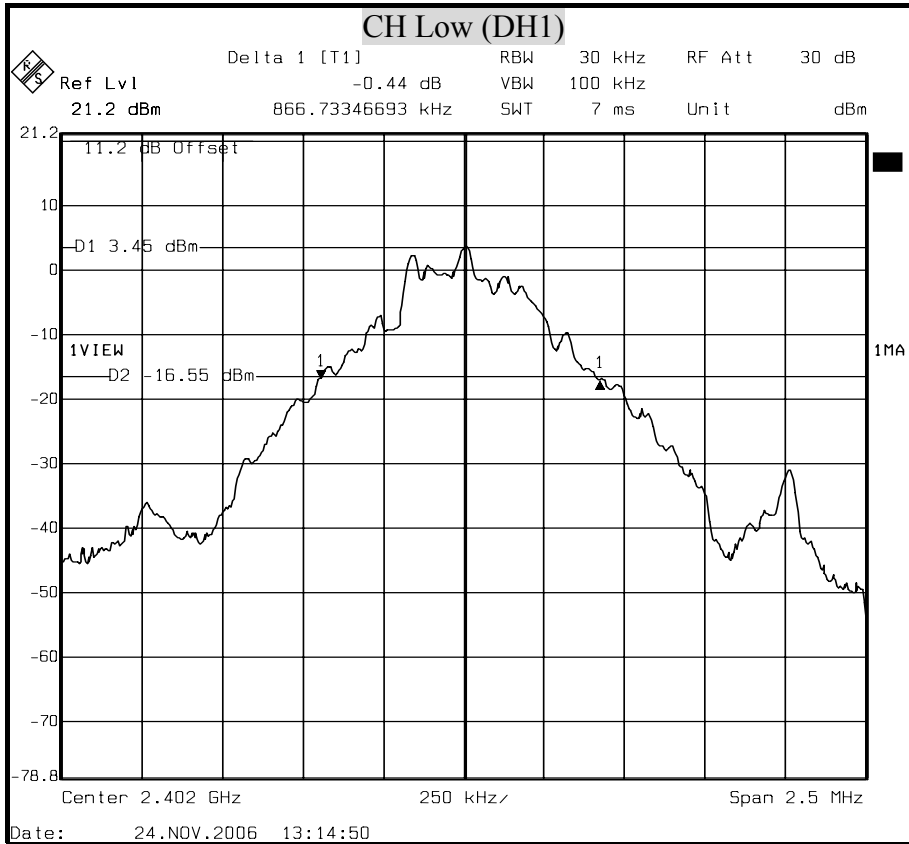

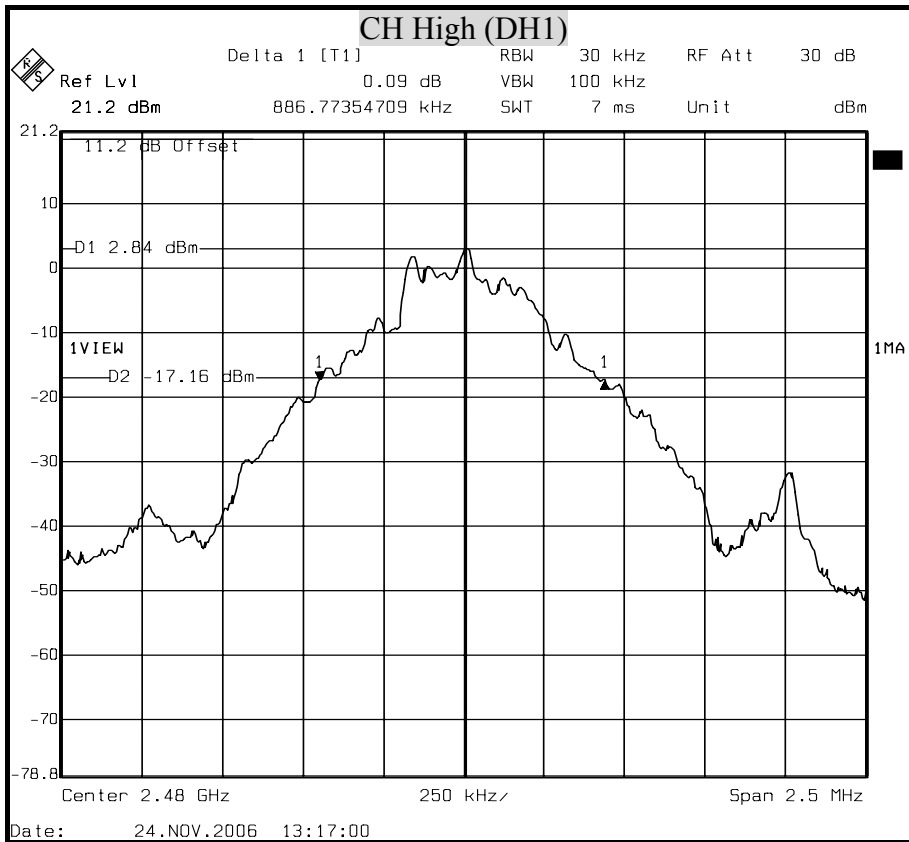

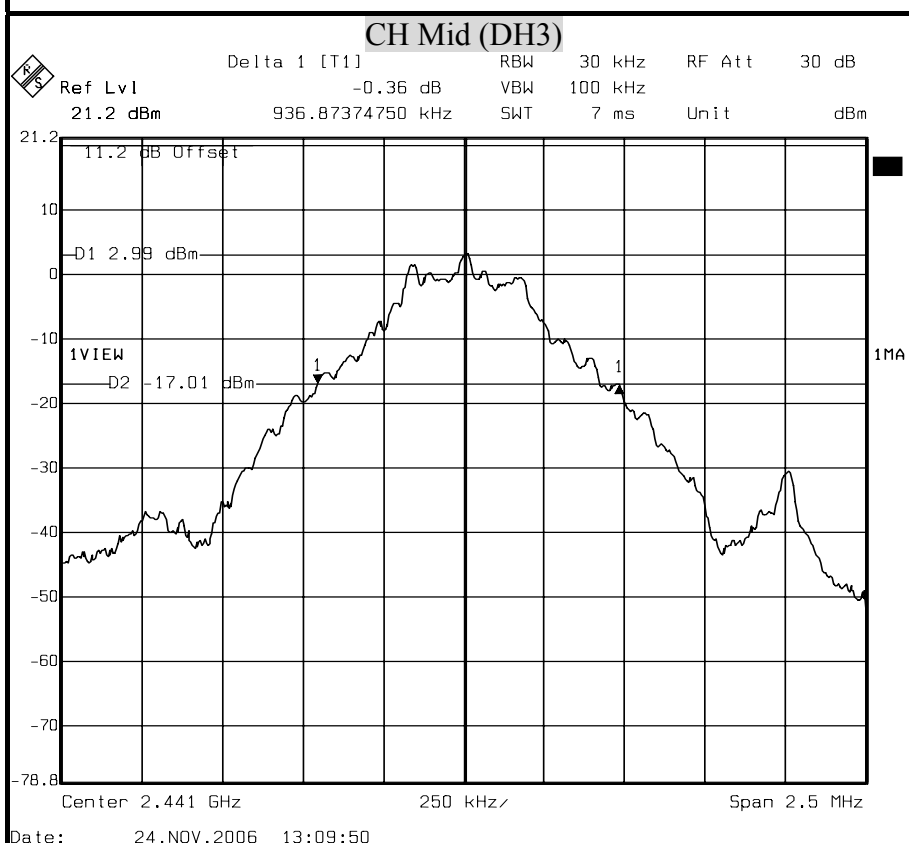
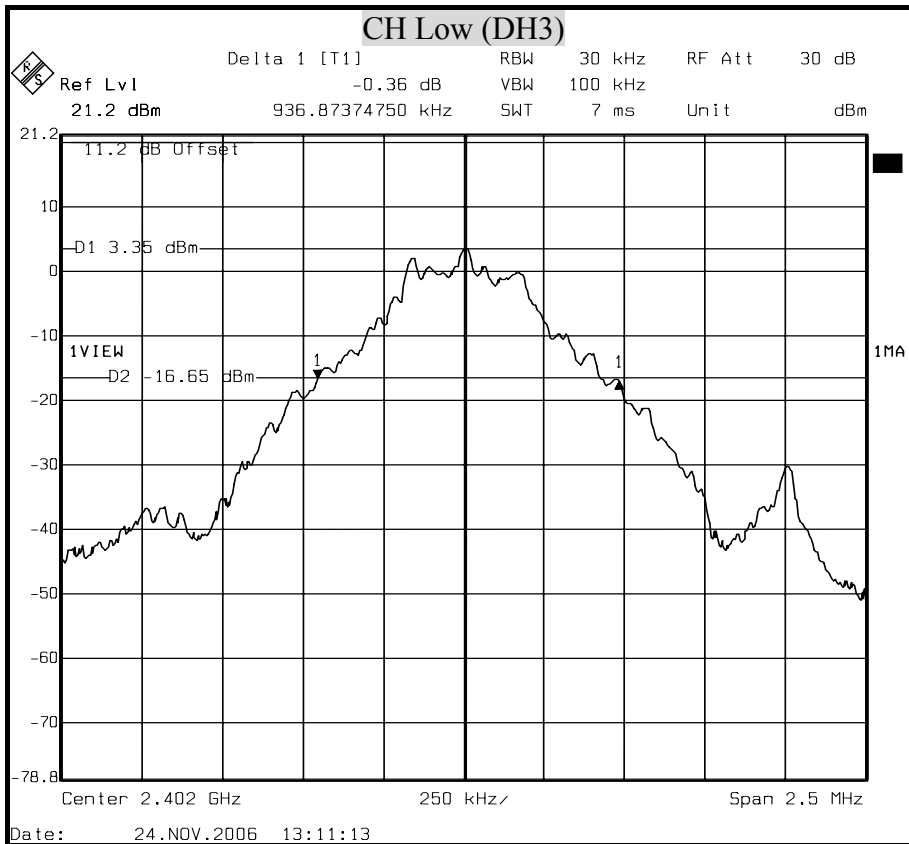

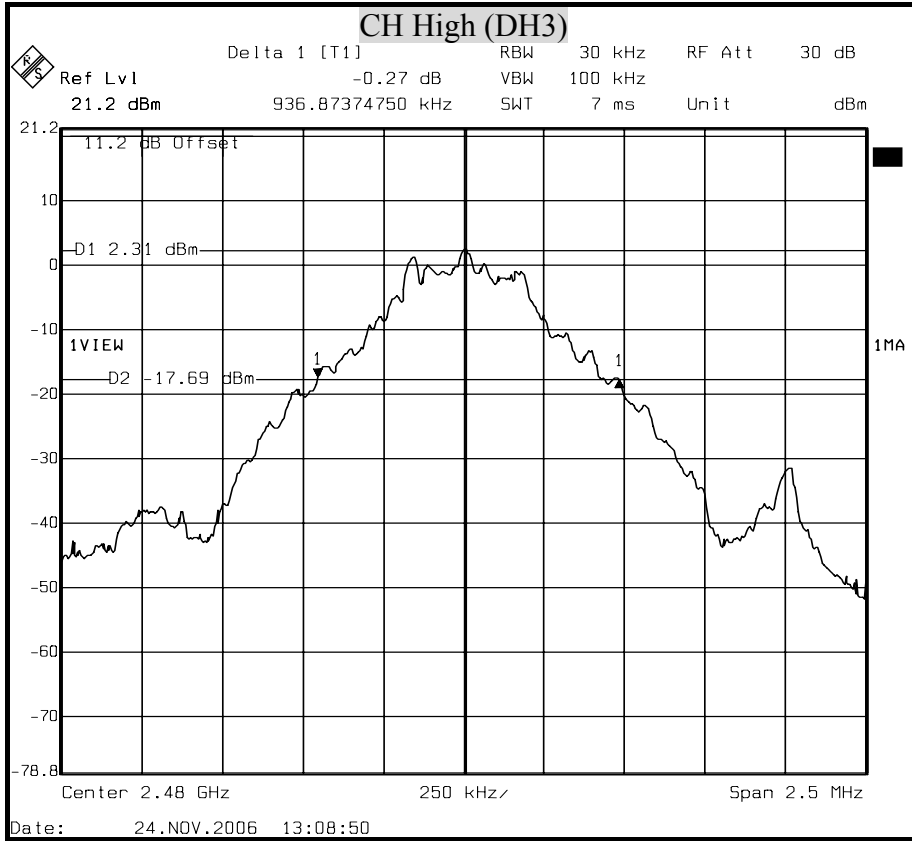

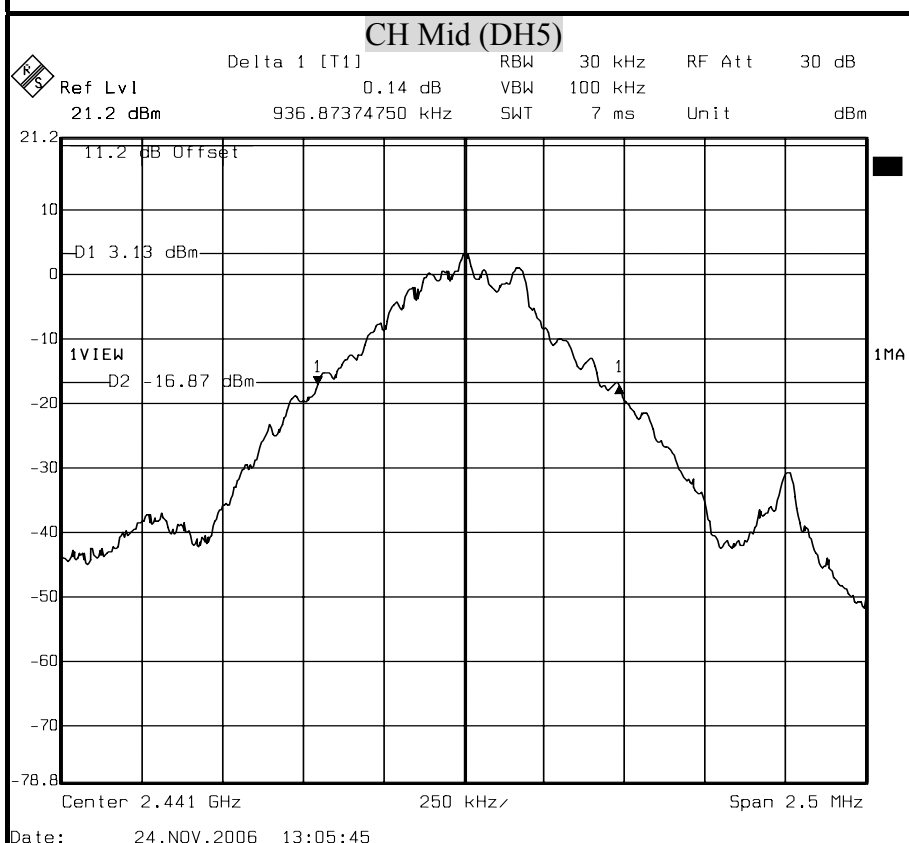
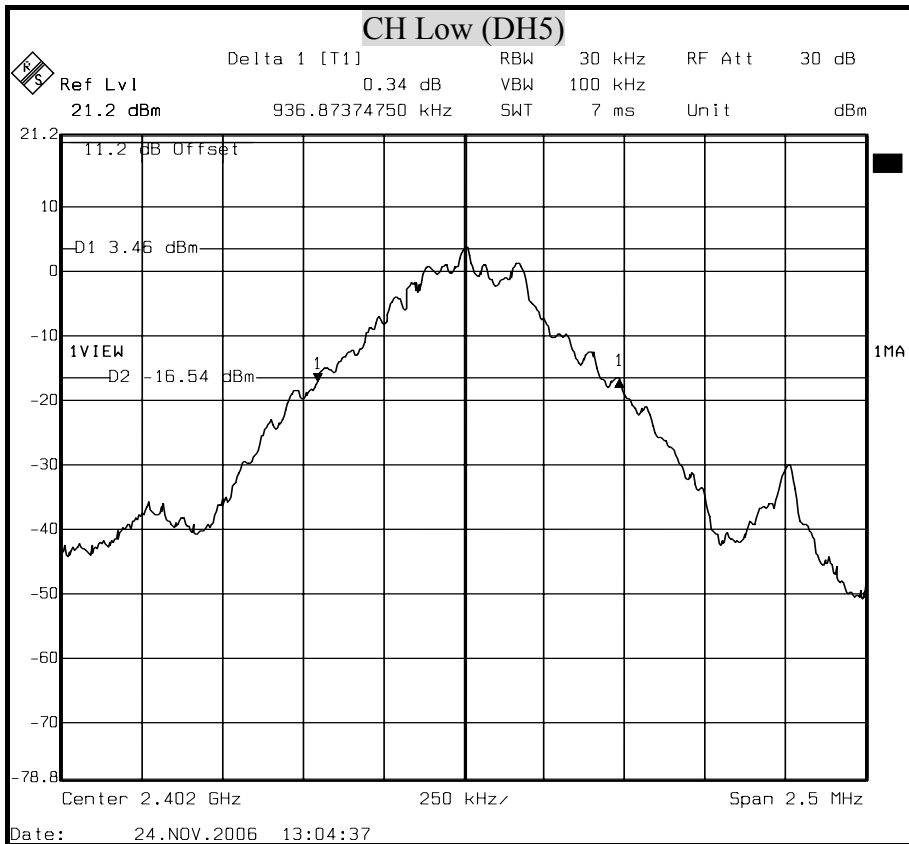

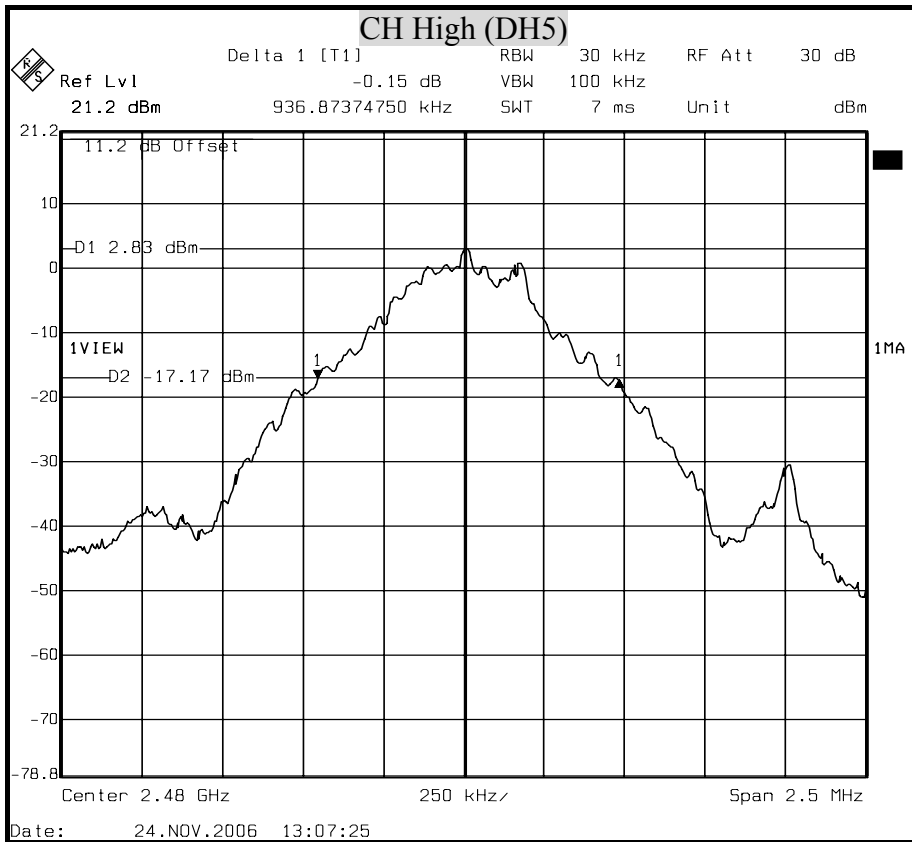



8.2 MAXIMUM PEAK OUTPUT POWER

LIMIT

§15.247(b)(1) The Maximum Peak Output Power Measurement is 125mW for frequency hopping systems operating in 2400~2483.5 MHz employing at least 15 hopping channels.

TEST EQUIPMENTS

| Description & Manufacturer | Model No. | Serial No. | Date of Calibration |
|-----------------------------------|-----------|-------------|---------------------|
| ROHDE & SCHWARZ SPECTRUM ANALYZER | FSEK30 | 835253/002 | October 18, 2006 |
| AGILENT SPECTRUM ANALYZER | E4446A | MY433601.32 | March 22, 2006 |

TEST SETUP

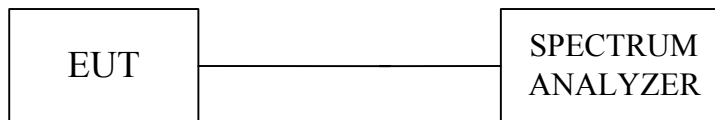

TEST PROCEDURE

The RF power output was measured with a Spectrum analyzer connected to the RF Antenna connector (conducted measurement) while EUT was operating in transmit mode at the appropriate center frequency, A spectrum analyzer was used to record the shape of the transmit signal.

**TEST RESULTS**

No non-compliance noted

Modulation Type: GFSK, CFG PKT Packet Type: 4 Packet Size: 27 (DH1)

| Channel | Channel Frequency (MHz) | Peak Power Output (dBm) | Peak Power Limit (dBm) | Pass / Fail |
|---------|-------------------------|-------------------------|------------------------|-------------|
| Low | 2402 | 3.88 | 20.97 | PASS |
| Middle | 2441 | 3.56 | 20.97 | PASS |
| High | 2480 | 3.28 | 20.97 | PASS |

Remark:

1. The cable assembly insertion loss of 11.2dB (including 10 dB pad and 1.2 dB cable) was Entered as an offset in the spectrum analyzer to allow for direct reading of power.

Modulation Type: GFSK, CFG PKT Packet Type: 11 Packet Size: 183 (DH3)

| Channel | Channel Frequency (MHz) | Peak Power Output (dBm) | Peak Power Limit (dBm) | Pass / Fail |
|---------|-------------------------|-------------------------|------------------------|-------------|
| Low | 2402 | 3.82 | 20.97 | PASS |
| Middle | 2441 | 3.50 | 20.97 | PASS |
| High | 2480 | 3.28 | 20.97 | PASS |

Remark:

1. The cable assembly insertion loss of 11.2dB (including 10 dB pad and 1 dB cable) was Entered as an offset in the spectrum analyzer to allow for direct reading of power.

Modulation Type: GFSK, CFG PKT Packet Type: 15 Packet Size: 339 (DH5)

| Channel | Channel Frequency (MHz) | Peak Power Output (dBm) | Peak Power Limit (dBm) | Pass / Fail |
|---------|-------------------------|-------------------------|------------------------|-------------|
| Low | 2402 | 3.82 | 20.97 | PASS |
| Middle | 2441 | 3.51 | 20.97 | PASS |
| High | 2480 | 3.26 | 20.97 | PASS |

Remark:

1. The cable assembly insertion loss of 11.2dB (including 10 dB pad and 1 dB cable) was Entered as an offset in the spectrum analyzer to allow for direct reading of power.



MAXIMUM PEAK OUTPUT POWER

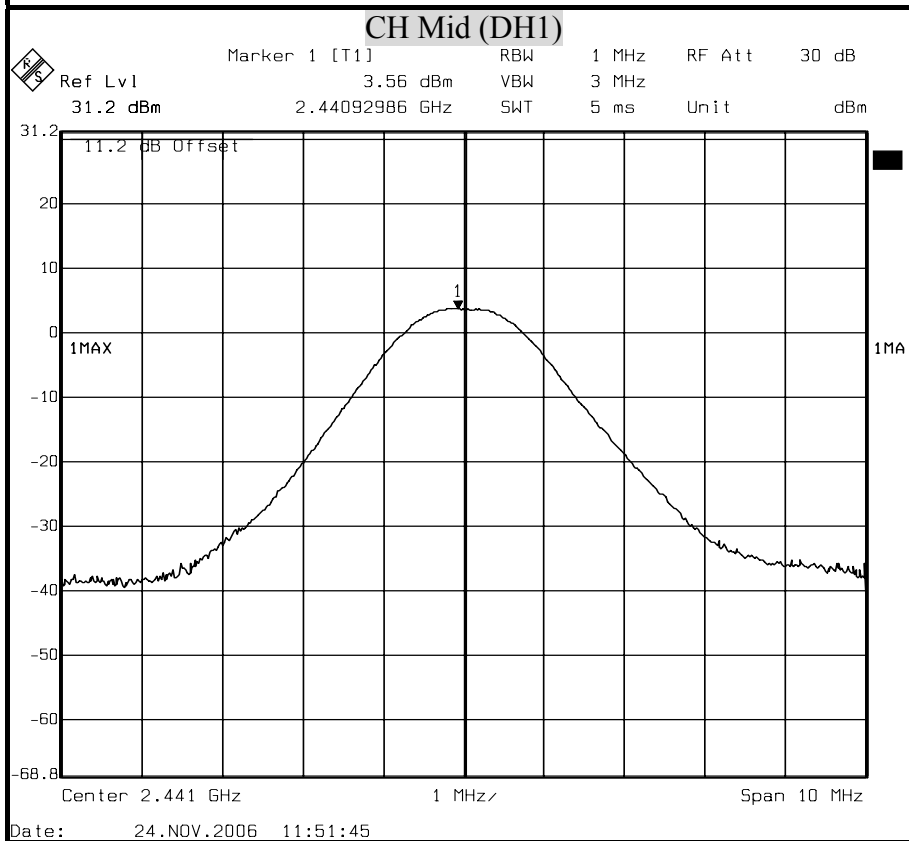
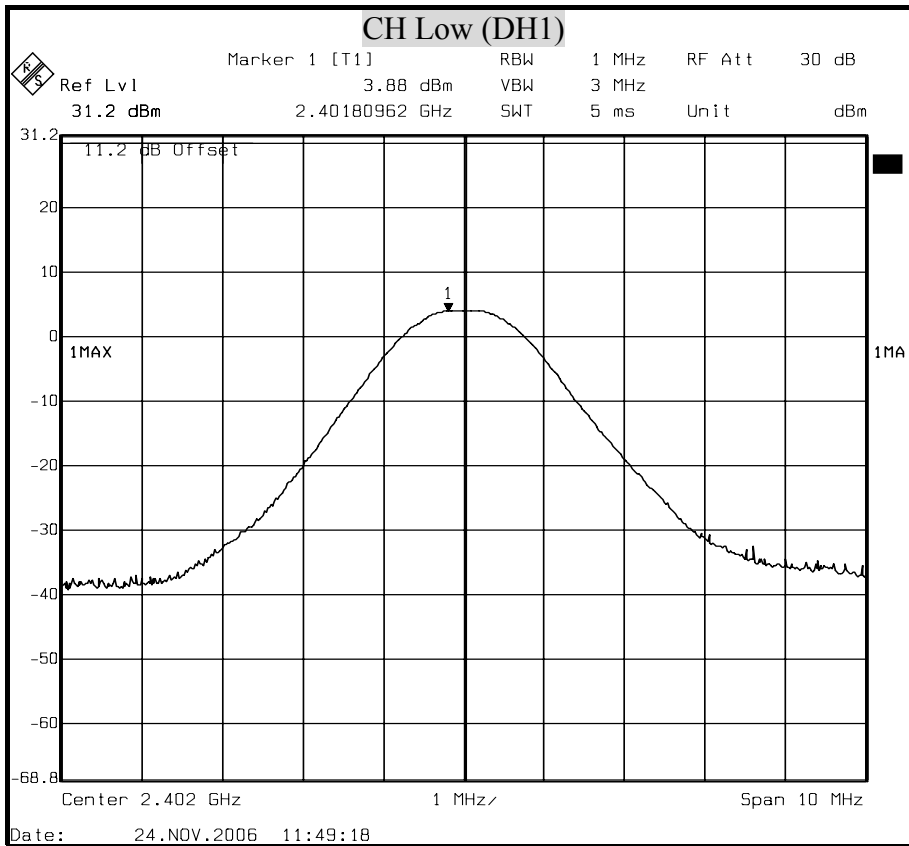

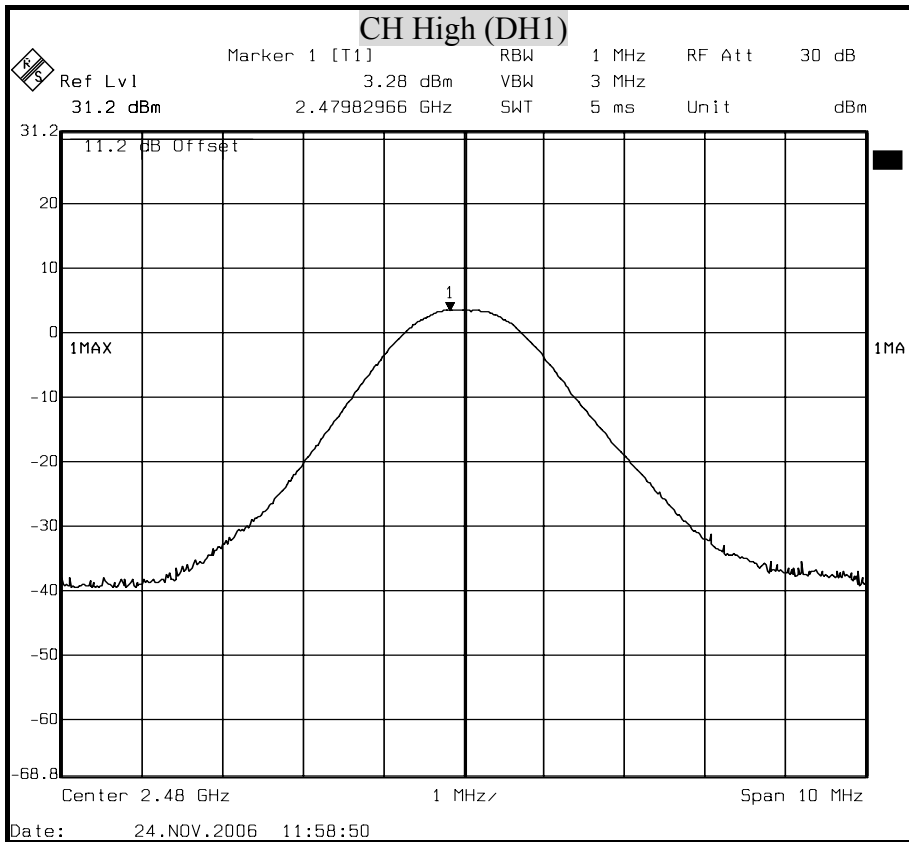

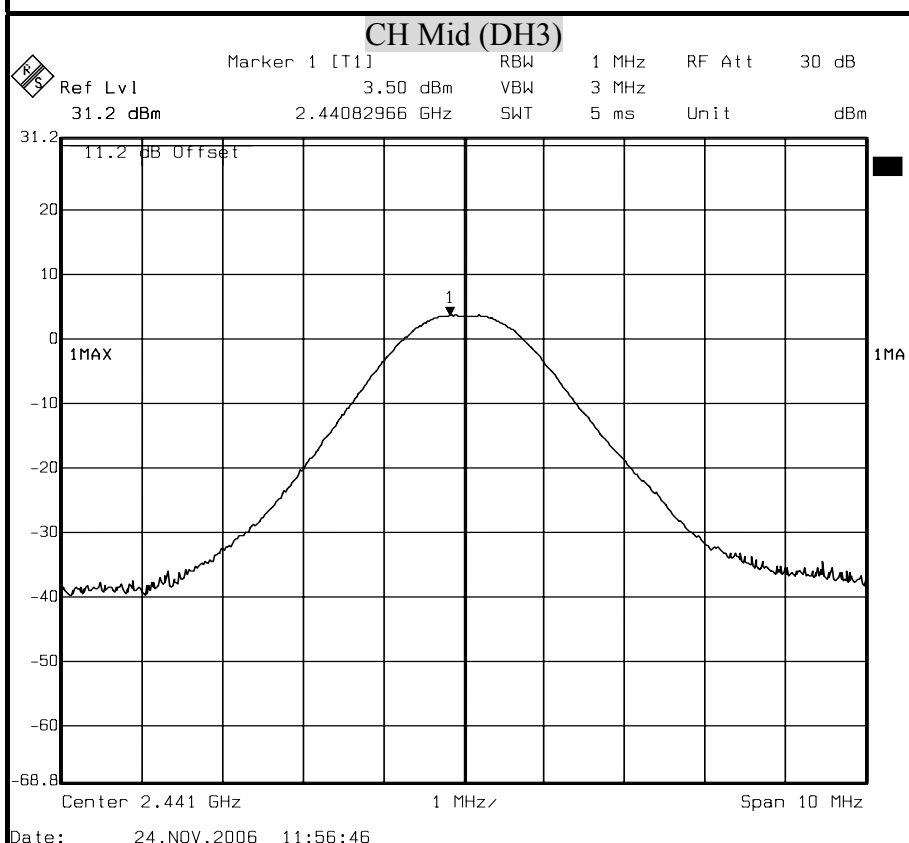
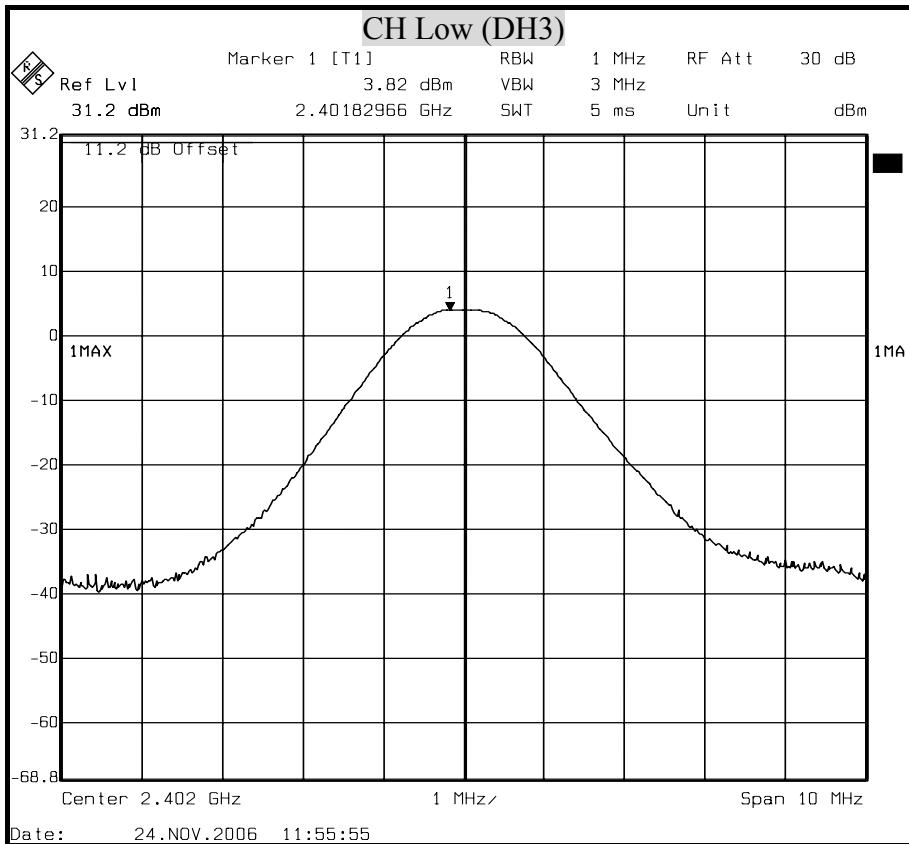

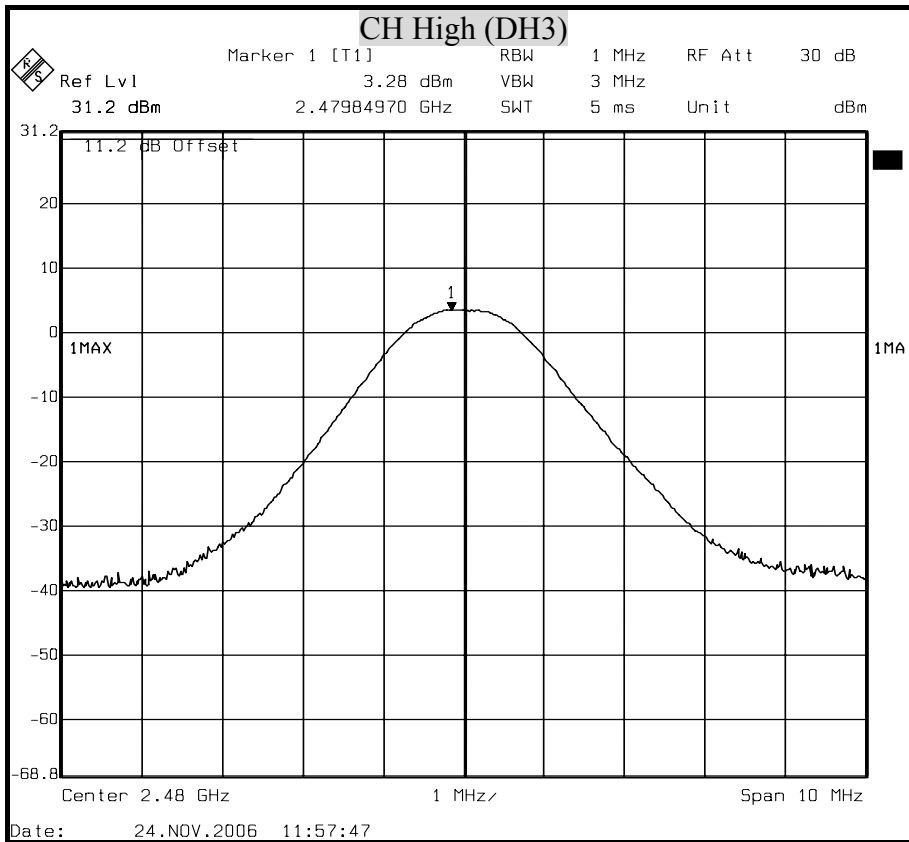

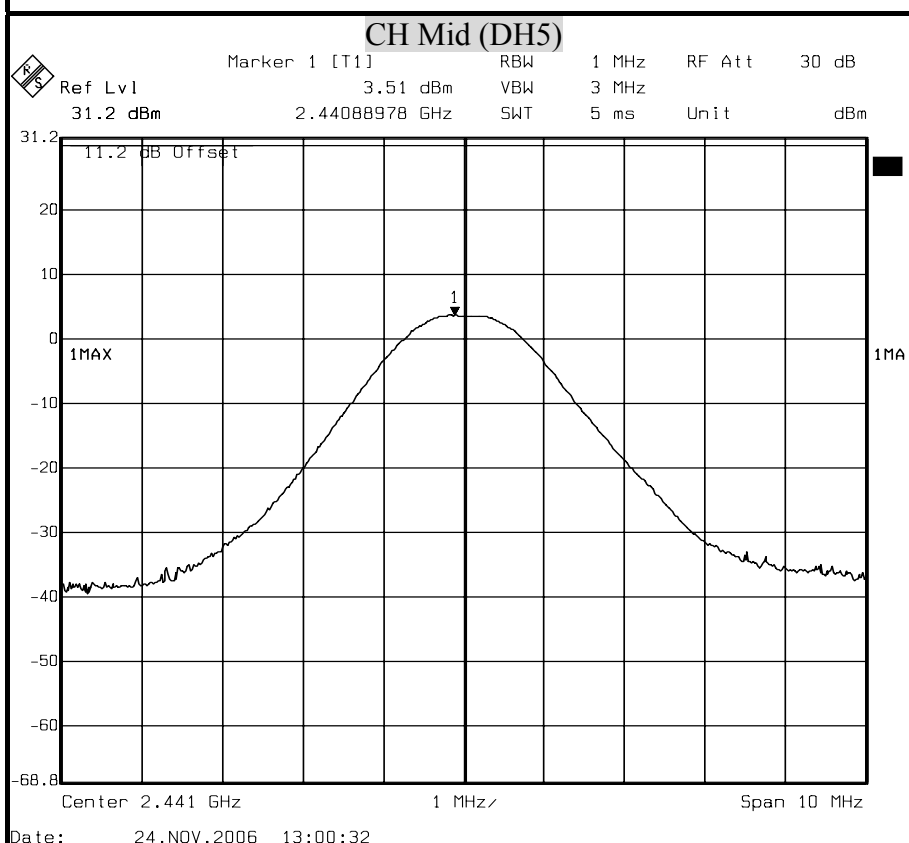
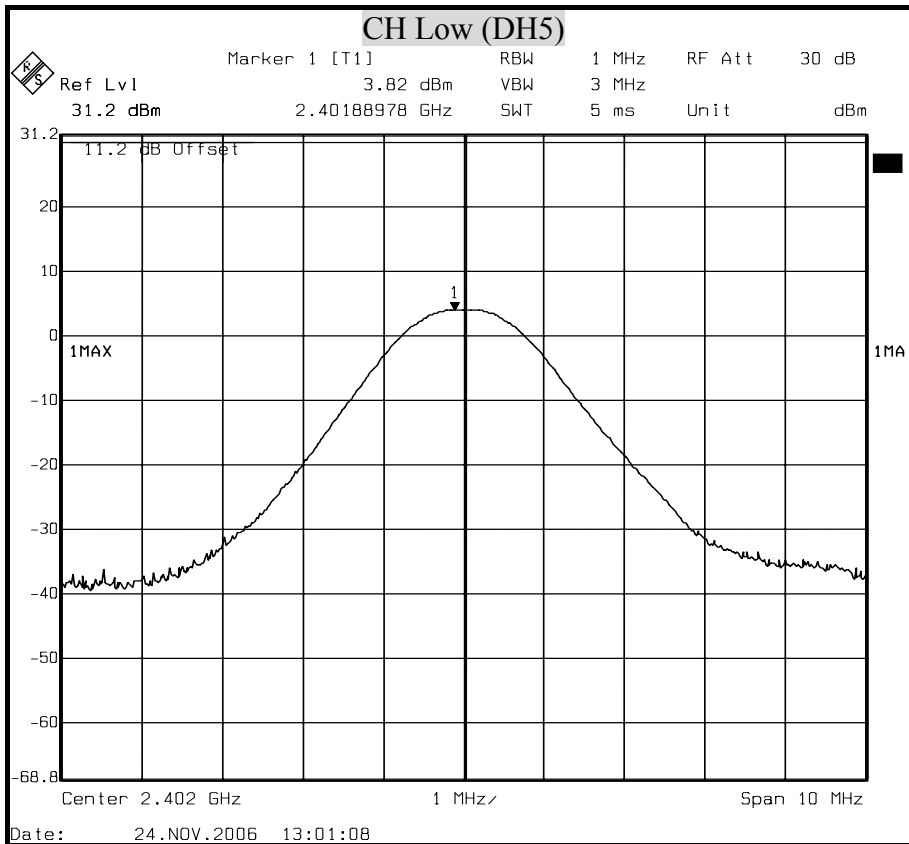

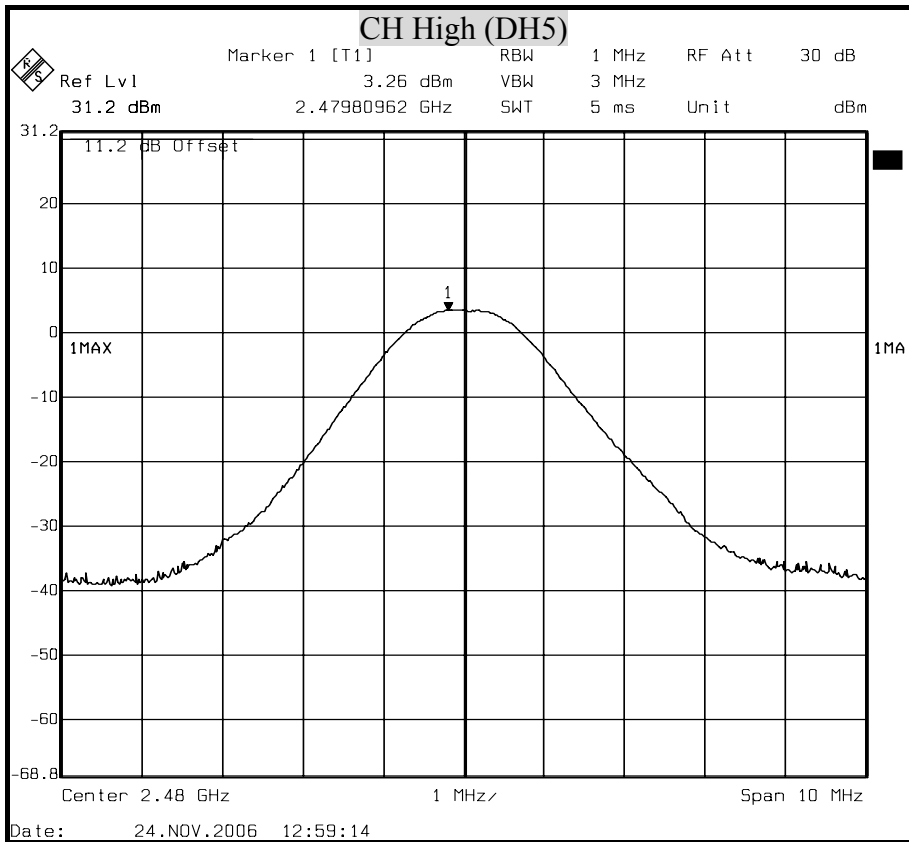



8.3 HOPPING CHANNEL SEPARATION

LIMIT

§15.247(a)(1) Frequency hopping system operating in 2400-2483.5MHz. Band may have hopping channel carrier frequencies that are separated by 25kHz or two-third of 20dB bandwidth of the hopping channel, whichever is greater, provided the systems operate with an output power no greater than 125mW.

TEST EQUIPMENTS

| Description & Manufacturer | Model No. | Serial No. | Date of Calibration |
|---------------------------------------|------------------|-------------------|----------------------------|
| ROHDE & SCHWARZ SPECTRUM ANALYZER | FSEK30 | 835253/002 | October 18, 2006 |
| AGILENT SPECTRUM ANALYZER | E4446A | MY433601.32 | March 22, 2006 |

TEST SETUP

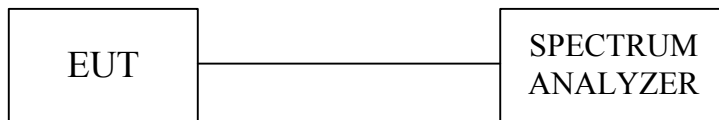

TEST PROCEDURE

1. Check the calibration of the measuring instrument using either an internal calibrator or a known signal from an external generator.
2. Position the EUT as shown in test setup without connection to measurement instrument. Turn on the EUT and connect it to measurement instrument. Then set it to any one convenient frequency within its operating range.
3. By using the MaxHold function record the separation of adjacent channels.
4. Measure the frequency difference of these two adjacent channels by spectrum analyzer MARK function. And then plot the result on spectrum analyzer screen.
5. Repeat above procedures until all frequencies measured were complete.



8.4 NUMBER OF HOPPING FREQUENCY USED

LIMIT

§15.247(a)(1)(iii) For frequency hopping system operating in the 2400-2483.5MHz bands shall use at least 15 hopping frequencies

TEST EQUIPMENTS

| Description & Manufacturer | Model No. | Serial No. | Date of Calibration |
|-----------------------------------|-----------|-------------|---------------------|
| ROHDE & SCHWARZ SPECTRUM ANALYZER | FSEK30 | 835253/002 | October 18, 2006 |
| AGILENT SPECTRUM ANALYZER | E4446A | MY433601.32 | March 22, 2006 |

TEST SETUP

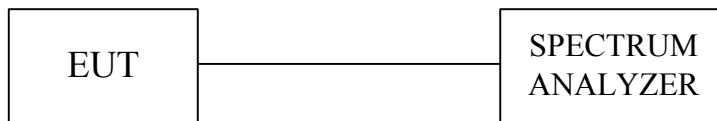

TEST PROCEDURE

- 1 Check the calibration of the measuring instrument (spectrum analyzer) using either an internal calibrator or a known signal from an external generator.
- 2 Position the EUT as shown in test setup without connection to measurement instrument. Turn on the EUT and connect its antenna terminal to measurement instrument via a low loss cable. Then set it to any one measured frequency within its operating range and make sure the instrument is operated in its linear range.
- 3 Set the spectrum analyzer on MaxHold Mode, and then keep the EUT in hopping mode. Record all the signals from each channel until each one has been recorded.
- 4 Set the spectrum analyzer on View mode and then plot the result on spectrum analyzer screen.
- 5 Repeat above procedures until all frequencies measured were complete.

TEST RESULTS

No non-compliance noted

Refer to the attached plot.

There are 79 hopping frequencies in a hopping sequence.



NUMBER OF HOPPING FREQUENCY USED

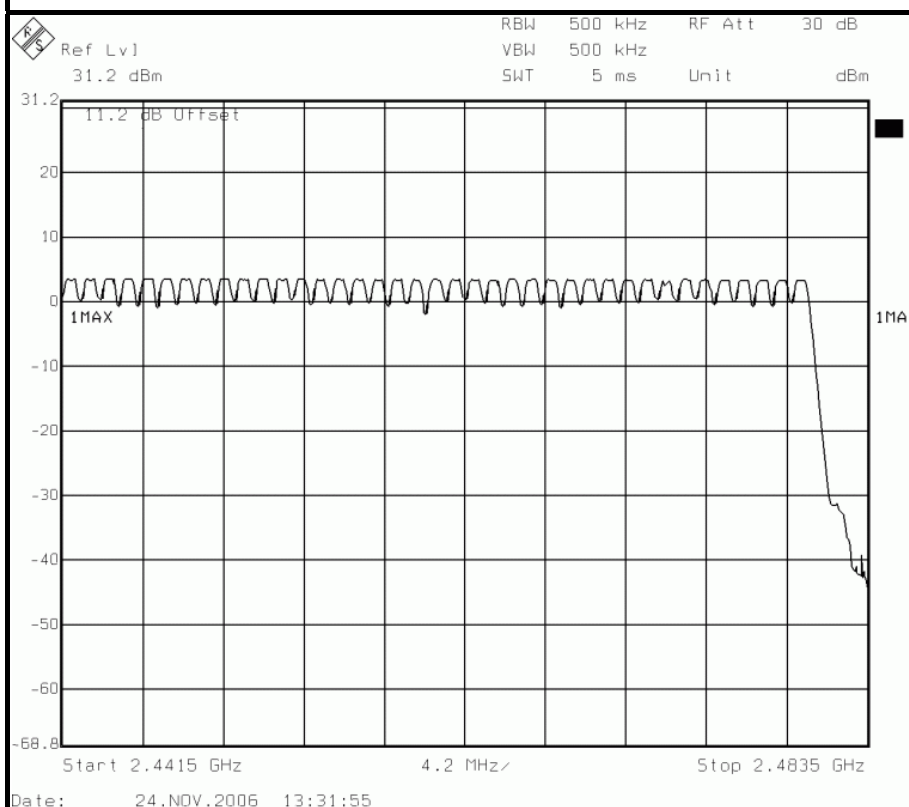
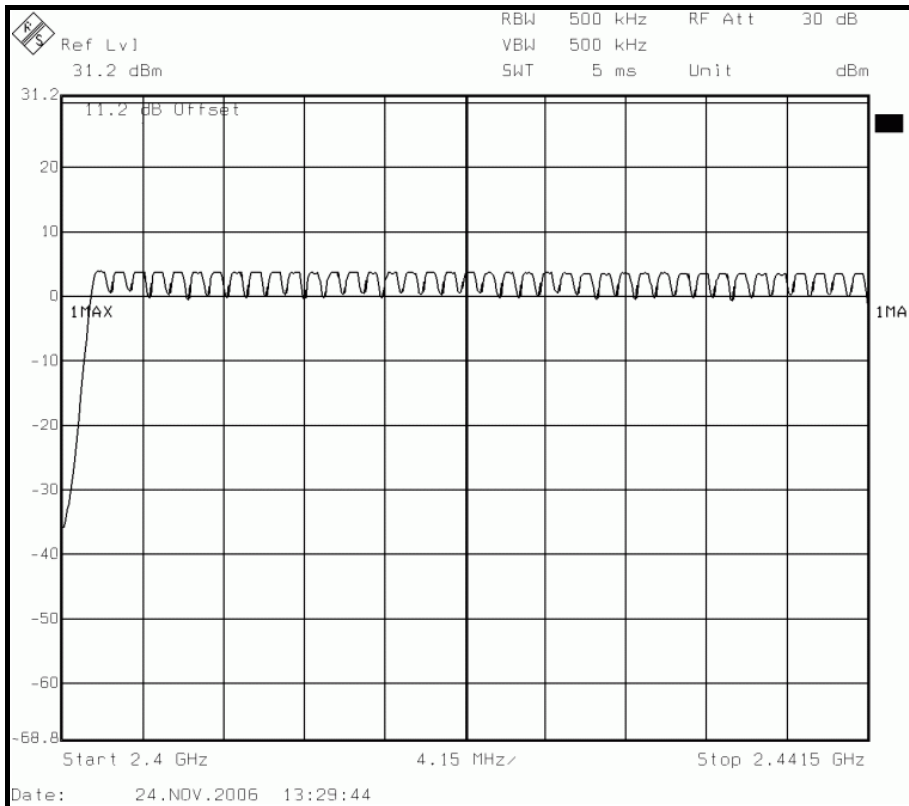



8.5 DWELL TIME ON EACH CHANNEL

LIMIT

§15.247(a)(1)(iii) For frequency hopping system operating in the 2400-2483.5MHz band, the average time of occupancy on any frequency shall not be greater than 0.4 second within a 31.6 second period.

TEST EQUIPMENTS

| Description & Manufacturer | Model No. | Serial No. | Date of Calibration |
|-----------------------------------|-----------|-------------|---------------------|
| ROHDE & SCHWARZ SPECTRUM ANALYZER | FSEK30 | 835253/002 | October 18, 2006 |
| AGILENT SPECTRUM ANALYZER | E4446A | MY433601.32 | March 22, 2006 |

TEST SETUP

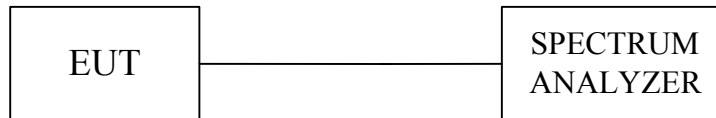

TEST PROCEDURE

1. Check the calibration of the measuring instrument using either an internal calibrator or a known signal from an external generator.
2. Position the EUT as shown in test setup without connection to measurement instrument. Turn on the EUT and connect its antenna terminal to measurement instrument via a low loss cable. Then set it to any one measured frequency within its operating range and make sure the instrument is operated in its linear range.
3. Adjust the center frequency of spectrum analyzer on any frequency be measured and set spectrum analyzer to zero span mode. And then, set RBW and VBW of spectrum analyzer to proper value.
4. Measure the time duration of one transmission on the measured frequency. And then plot the result with time difference of this time duration.
5. Repeat above procedures until all frequencies measured were complete.
6. The Microsoft Office Communicator USB Earbud has 3 type of payload, DH1, DH3, DH5. The hopping rate is 1600 per second.
The longer the payload is, the slower the hopping rate is.

**TEST RESULTS**

No non-compliance noted

Time of occupancy on the TX channel in 31.6sec = time domain slot length × hop rate ÷ number of hop per channel × 31.6

Refer to the attached graph.

The hopping rates of Bluetooth devices change with different types of payload. The longer the payload is, the slower the hopping rate. The hopping rate scenario is defined in Bluetooth core specification.

Modulation Type: GFSK

| Transmitting Frequency | Packet type | Dwell time (ms) | Time of occupancy on the TX channel in 31.6sec (ms) | Limit for Time of occupancy on the TX channel in 31.6sec (ms) | Results |
|------------------------|-------------|-----------------|---|---|---------|
| 2441MHz | DH1 | 0.4208 | 134.66 | 400 | PASS |
| 2441MHz | DH3 | 1.6833 | 269.33 | 400 | PASS |
| 2441MHz | DH5 | 2.9259 | 312.10 | 400 | PASS |

DH1 Dwell time = $0.4208 \text{ ms} \times (1600 \div 2) \div 79 \times 31.6 = 134.66 \text{ (ms)}$

DH3 Dwell time = $1.6833 \text{ ms} \times (1600 \div 4) \div 79 \times 31.6 = 269.33 \text{ (ms)}$

DH5 Dwell time = $2.9259 \text{ ms} \times (1600 \div 6) \div 79 \times 31.6 = 312.10 \text{ (ms)}$



DWELL TIME ON EACH PAYLOAD

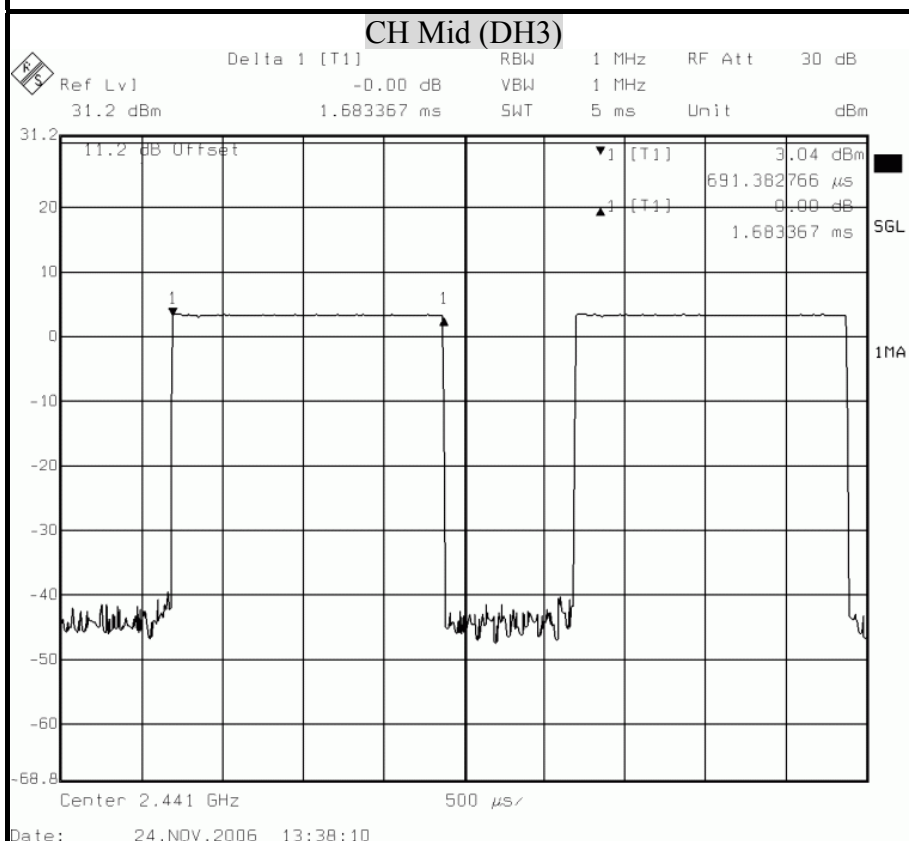
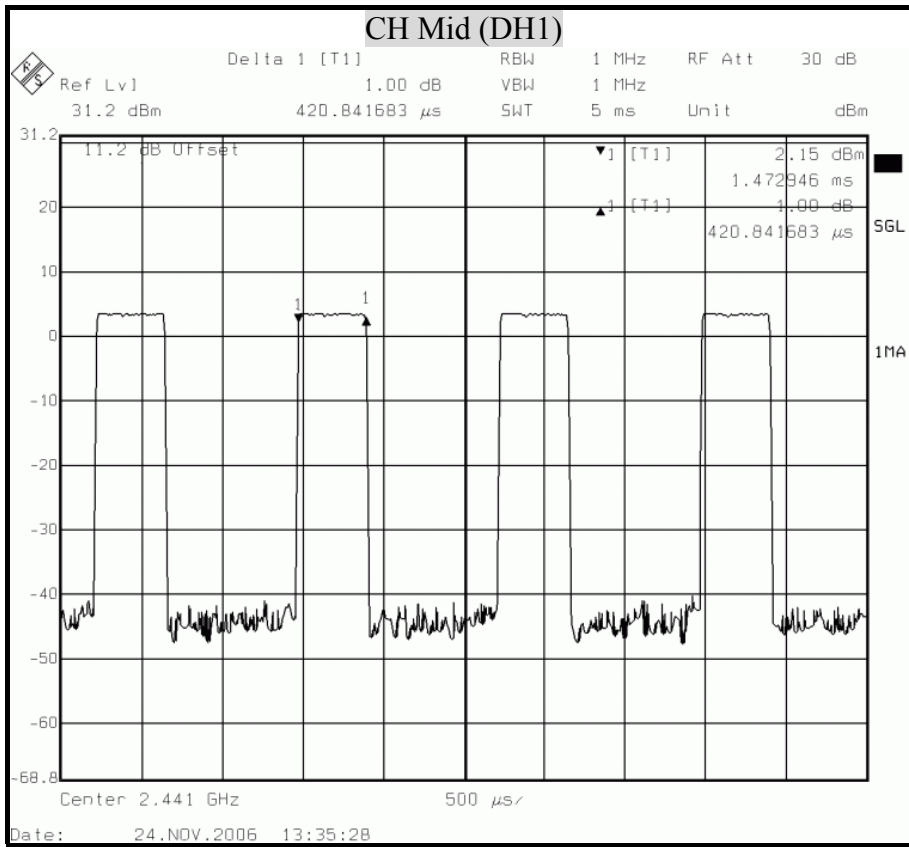

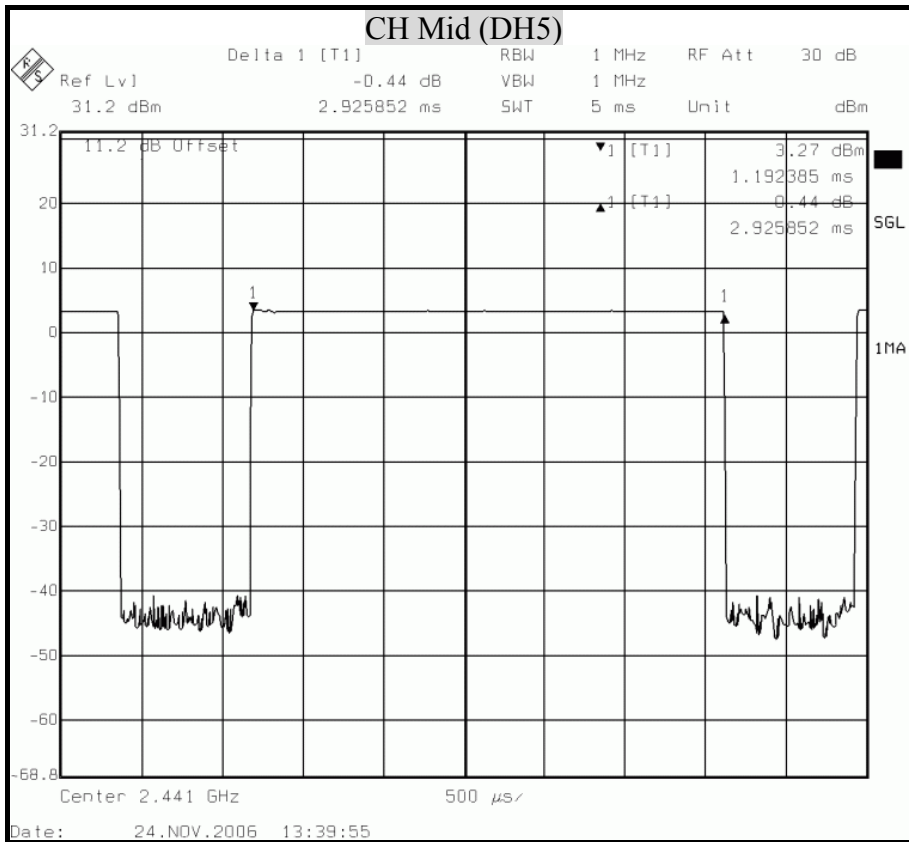



8.6 CONDUCTED SPURIOUS EMISSION

LIMITS

§ 15.247(d) In any 100 kHz bandwidth outside the frequency band in which the spread spectrum intentional radiator is operating, the radio frequency power that is produced by the intentional radiator shall be at least 20 dB below that in the 100 kHz bandwidth within the and that contains the highest level of the desired power, based on either an RF conducted or a radiated measurement. Attenuation below the general limits specified in § 15.209(a) is not required. In addition, radiated emissions which fall in the restricted bands, as defined in § 15.205(a), must also comply with the radiated emission limits specified in § 15.209(a) (see § 15.205(c)).

TEST PROCEDURE

The transmitter output is connected to a spectrum analyzer. The resolution bandwidth is set to 100 kHz. The video bandwidth is set to 300 kHz.

The spectrum from 30 MHz to 26.5 GHz is investigated with the transmitter set to the lowest, middle, and highest channels in the 2.4 GHz band.

TEST RESULTS

No non-compliance noted



BAND EDGE COMPLIANCE OF RF CONDUCTED EMISSIONS

OUT-OF-BAND SPURIOUS EMISSIONS-CONDUCTED MEASUREMENT

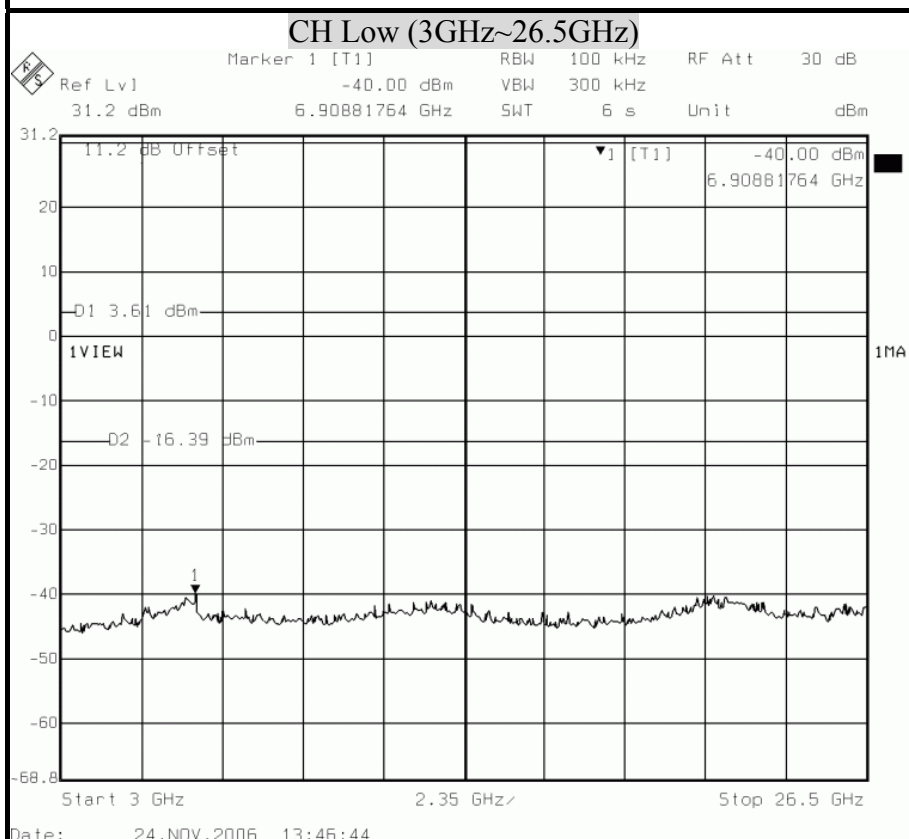
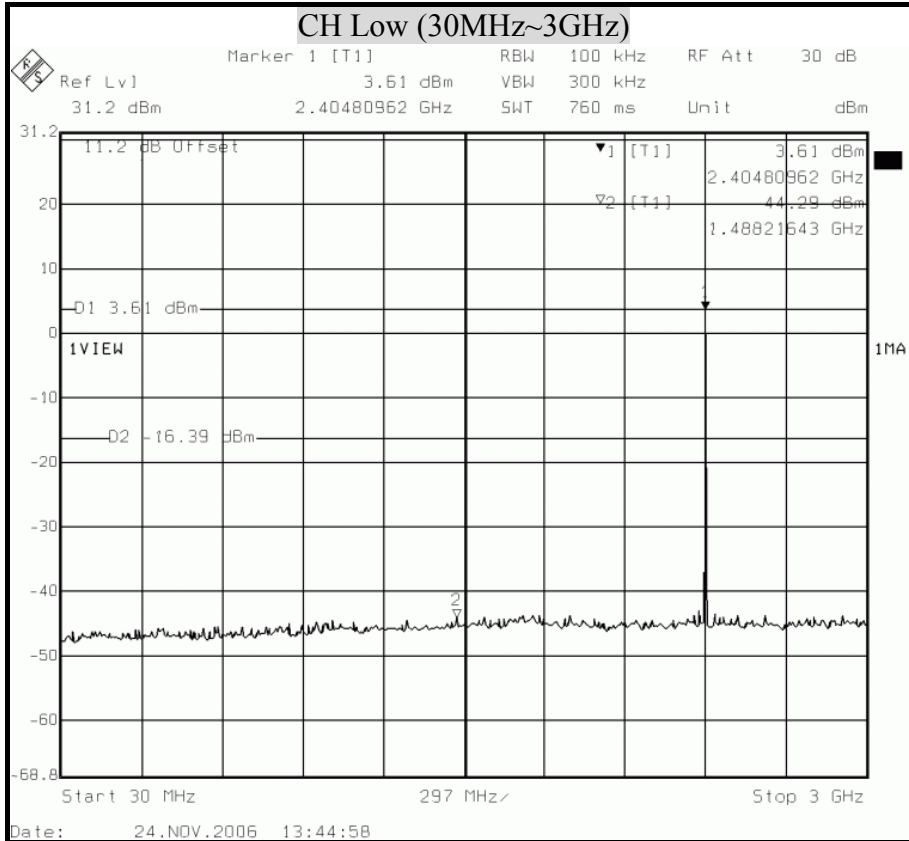

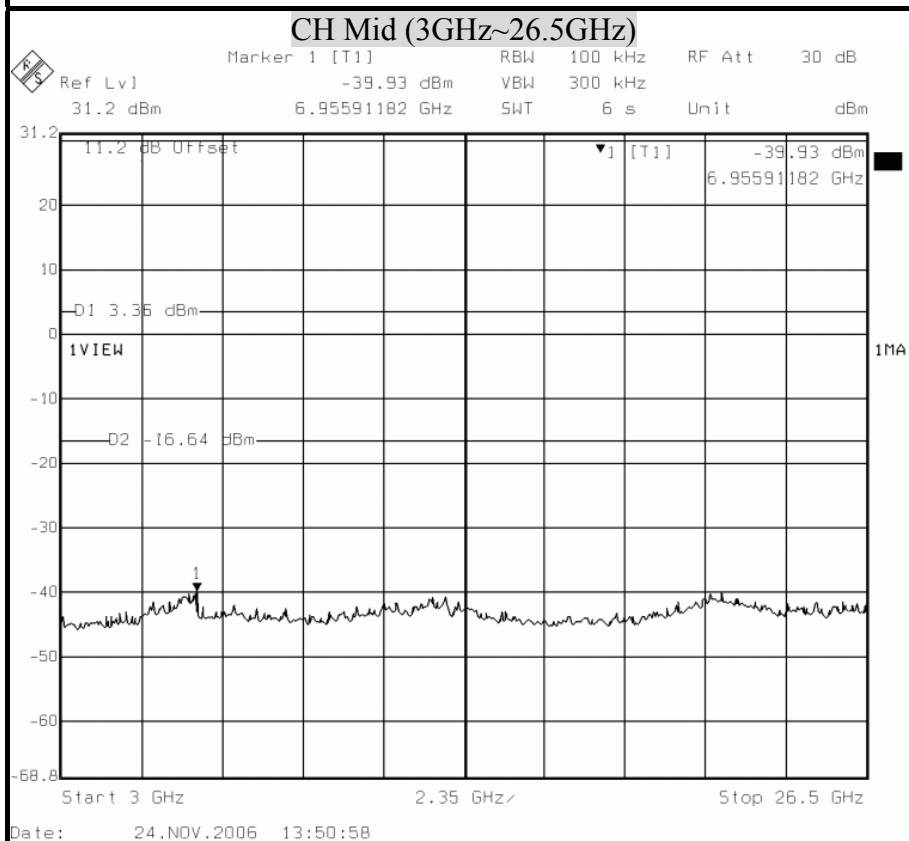
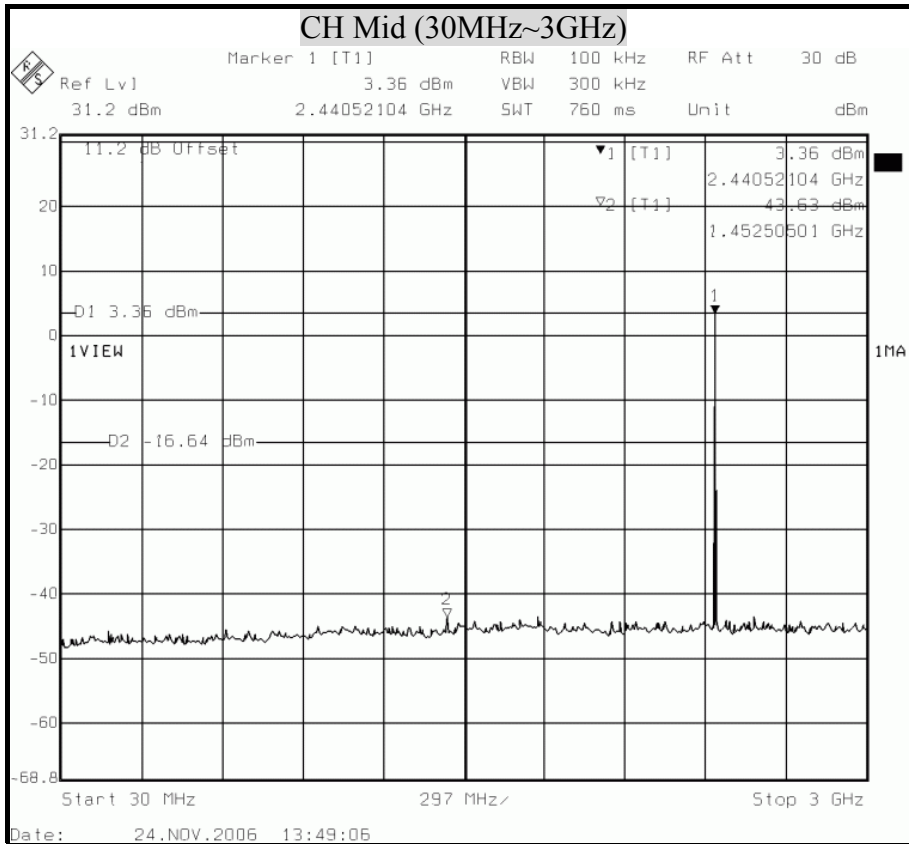

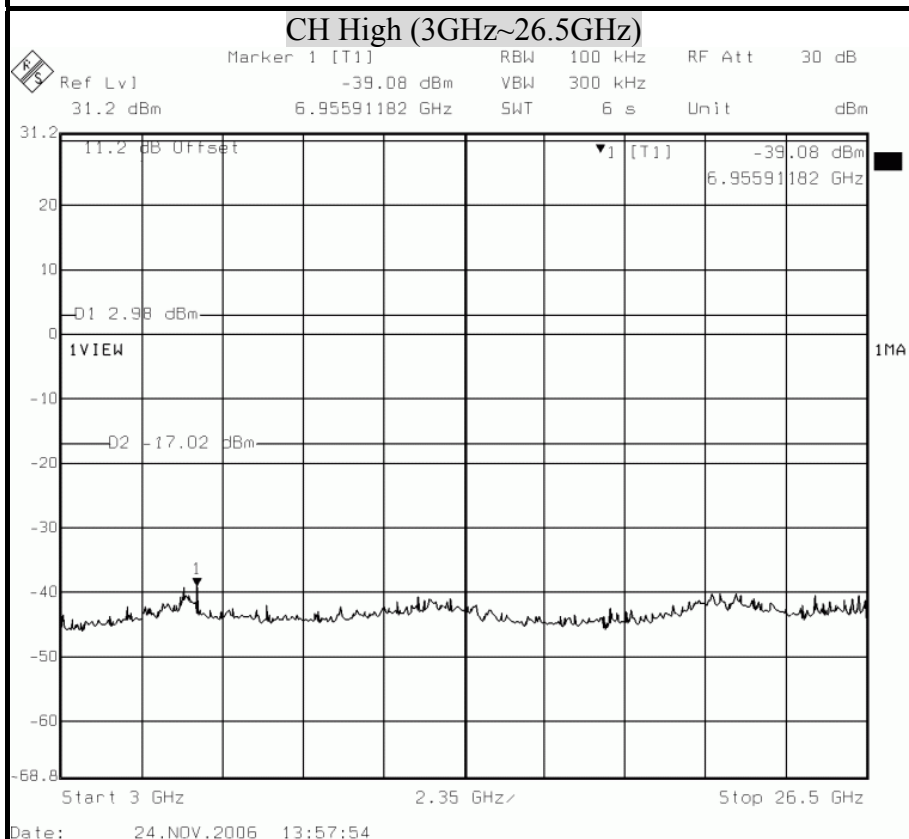
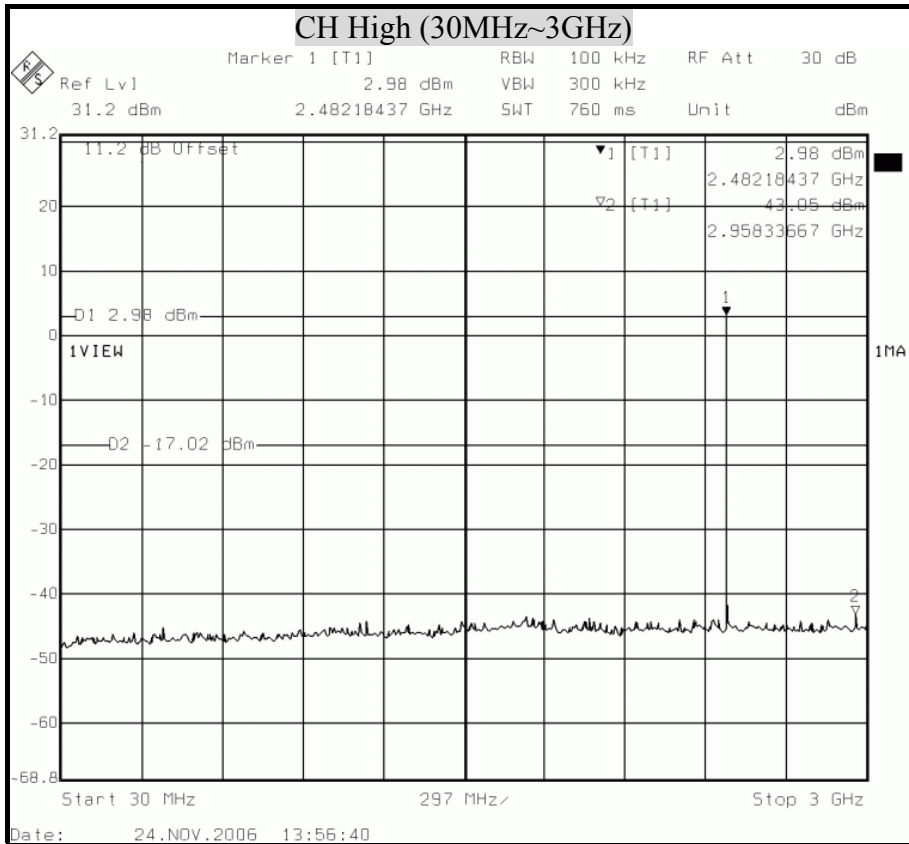



8.7 RADIATED EMISSIONS

8.7.1 TRANSMITTER RADIATED SUPURIOUS EMSSIONS

LIMITS

§ 15.205 (a) Except as shown in paragraph (d) of this section, only spurious emissions are permitted in any of the frequency bands listed below:

| MHz | MHz | MHz | GHz |
|----------------------------|-----------------------|-----------------|------------------|
| 0.090 - 0.110 | 16.42 - 16.423 | 399.9 - 410 | 4.5 - 5.15 |
| ¹ 0.495 - 0.505 | 16.69475 - 16.69525 | 608 - 614 | 5.35 - 5.46 |
| 2.1735 - 2.1905 | 16.80425 - 16.80475 | 960 - 1240 | 7.25 - 7.75 |
| 4.125 - 4.128 | 25.5 - 25.67 | 1300 - 1427 | 8.025 - 8.5 |
| 4.17725 - 4.17775 | 37.5 - 38.25 | 1435 - 1626.5 | 9.0 - 9.2 |
| 4.20725 - 4.20775 | 73 - 74.6 | 1645.5 - 1646.5 | 9.3 - 9.5 |
| 6.215 - 6.218 | 74.8 - 75.2 | 1660 - 1710 | 10.6 - 12.7 |
| 6.26775 - 6.26825 | 108 - 121.94 | 1718.8 - 1722.2 | 13.25 - 13.4 |
| 6.31175 - 6.31225 | 123 - 138 | 2200 - 2300 | 14.47 - 14.5 |
| 8.291 - 8.294 | 149.9 - 150.05 | 2310 - 2390 | 15.35 - 16.2 |
| 8.362 - 8.366 | 156.52475 - 156.52525 | 2483.5 - 2500 | 17.7 - 21.4 |
| 8.37625 - 8.38675 | 156.7 - 156.9 | 2655 - 2900 | 22.01 - 23.12 |
| 8.41425 - 8.41475 | 162.0125 - 167.17 | 3260 - 3267 | 23.6 - 24.0 |
| 12.29 - 12.293 | 167.72 - 173.2 | 3332 - 3339 | 31.2 - 31.8 |
| 12.51975 - 12.52025 | 240 - 285 | 3345.8 - 3338 | 36.43 - 36.5 |
| 12.57675 - 12.57725 | 322 - 335.4 | 3600 - 4400 | (²) |
| 13.36 - 13.41 | | | |

¹ Until February 1, 1999, this restricted band shall be 0.490-0.510 MHz.

² Above 38.6

§ 15.205 (b) Except as provided in paragraphs (d) and (e), the field strength of emissions appearing within these frequency bands shall not exceed the limits shown in Section 15.209. At frequencies equal to or less than 1000 MHz, compliance with the limits in Section 15.209 shall be demonstrated using measurement instrumentation employing a CISPR quasi-peak detector. Above 1000 MHz, compliance with the emission limits in Section 15.209 shall be demonstrated based on the average value of the measured emissions. The provisions in Section 15.35 apply to these measurements.



§ 15.209 (a) Except as provided elsewhere in this Subpart, the emissions from an intentional radiator shall not exceed the field strength levels specified in the following table :

| Frequency (MHz) | Field Strength (microvolts/meter) | Measurement Distance (meters) |
|-----------------|-----------------------------------|-------------------------------|
| 30 - 88 | 100 ** | 3 |
| 88 - 216 | 150 ** | 3 |
| 216 - 960 | 200 ** | 3 |
| Above 960 | 500 | 3 |

** Except as provided in paragraph (g), fundamental emissions from intentional radiators operating under this Section shall not be located in the frequency bands 54-72 MHz, 76-88 MHz, 174-216 MHz or 470-806 MHz, However, operation within these frequency bands is permitted under other sections of this Part, e-g, Sections 15.231 and 15.241.

§ 15.209 (b) In the emission table above, the tighter limit applies at the band edges.

TEST EQUIPMENTS

The following test equipments are utilized in making the measurements contained in this report.

| Manufacturer or Type | Model No. | Serial No. | Date of Calibration | Calibration Period | Remark |
|----------------------------|-------------|-------------|---------------------|--------------------|--------|
| CHASE BI-LOG ANTENNA | CBL6112B | 2817 | August 28, 2006 | 1 Year | FINAL |
| R/S SPECTRUM ANALYZER | FSEK30 | 835253/002 | October 18, 2006 | 1 Year | FINAL |
| AGILENT SPECTRUM ANALYZER | E4446A | MY433601.32 | March 22, 2006 | 1 Year | FINAL |
| R/S EMI TEST RECEIVER | ESCS30 | 835418/008 | September 02, 2006 | 1 Year | FINAL |
| OPEN SITE | ----- | No.2 | May 07, 2006 | 1 Year | FINAL |
| N TYPE COAXIAL CABLE | 9913-30M | 001 | August 21, 2006 | 1 Year | FINAL |
| Horn Antenna | AH-118 | 10089 | August 30, 2006 | 1 Year | FINAL |
| Horn Antenna | AH-840 | 03077 | February 25, 2006 | 1 Year | FINAL |
| Agilent Pre-amplifier | 8449B | 3008A01471 | December 07, 2005 | 1 Year | FINAL |
| HP Amplifier | 8447D | 1937A02748 | December 07, 2005 | 1 Year | FINAL |
| HP High pass filter | 84300/80038 | 002 | CAL. ON USE | 1 Year | FINAL |
| HP High pass filter | 84300/80039 | 003 | CAL. ON USE | 1 Year | FINAL |
| Micro-Tronics Notch Filter | BRM50702-01 | 015 | CAL. ON USE | 1 Year | FINAL |
| Loop Antenna ETS-LINDGREN | 6502 | 2356 | June 15, 2006 | 1 Year | FINAL |

TEST SETUP

The diagram below shows the test setup that is utilized to make the measurements for emission from 30 to 1GHz.

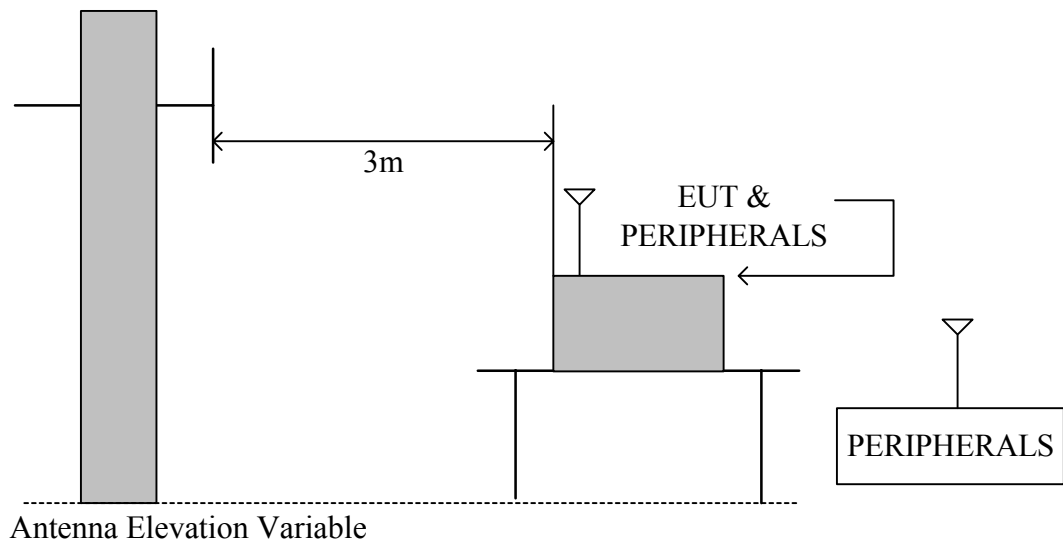

The diagram below shows the test setup that is utilized to make the measurements for emission above 1GHz.

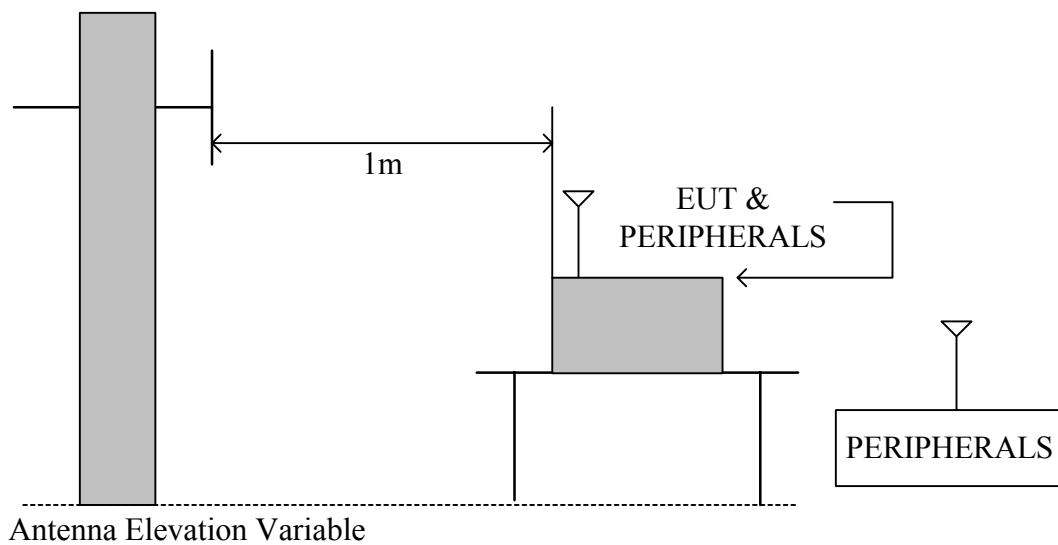



TEST PROCEDURE

- a. The EUT was placed on the top of a rotating table 0.8 meters above the ground at a 10 meter open area test site. The table was rotated 360 degrees to determine the position of the highest radiation.
- b. While measuring the radiated emission below 1GHz, the EUT was set 3 meters away from the interference-receiving antenna, which was mounted on the top of a variable-height antenna tower. While measuring the radiated emission above 1GHz, the EUT was set 1 meters away from the interference-receiving antenna
- c. The antenna is a broadband antenna, and its height is varied from one meter to four meters above the ground to determine the maximum value of the field strength. Both horizontal and vertical polarization of the antenna are set to make the measurement.
- d. For each suspected emission, the EUT was arranged to its worst case and then the antenna was tuned to heights from 1 meter to 4 meters and the table was turned from 0 degrees to 360 degrees to find the maximum reading.
- e. The test-receiver system was set to Peak Detect Function and Specified Bandwidth with Maximum Hold Mode.
- f. If the emission level of the EUT in peak mode was 10 dB lower than the limit specified, then testing could be stopped and the peak values of the EUT would be reported. Otherwise the emissions that did not have 10 dB margin would be re-tested one by one using peak, quasi-peak or average method as specified and then reported in a data sheet.

Note :

1. The resolution bandwidth and video bandwidth of test receiver/spectrum analyzer is 120 KHz for Peak detection (PK) and Quasi-peak detection (QP) at frequency below 1GHz.
2. The resolution bandwidth and video bandwidth of test receiver/spectrum analyzer is 1 MHz for Peak detection and frequency above 1GHz.
3. The resolution bandwidth of test receiver/spectrum analyzer is 1 MHz and the video bandwidth is 10 Hz for Average detection (AV) at frequency above 1GHz.

TEST RESULTS

No non-compliance noted

**8.7.2 WORST-CASE RADIATED EMISSION BELOW 1 GHz**

| | | | |
|---------------------|--|----------------------------|------------|
| Product Name | Microsoft Office Communicator USB Earbud | Test Date | 2006/11/19 |
| Model Name | 1107 | Test By | Alan Fan |
| Test Mode | Electrify Mode (worst case) | TEMP & Humidity | 29°C, 68% |

| Frequency (MHz) | Antenna Factor (dB/m) | Cable Loss (dB) | Meter Reading at 3m(dBμV) | | Limits (dBμV/m) | Emission Level at 3m(dBμV/m) | |
|-----------------|-----------------------|-----------------|---------------------------|----------|-----------------|------------------------------|----------|
| | | | Horizontal | Vertical | | Horizontal | Vertical |
| 250.00 | 12.70 | 2.16 | 20.70 | 20.50 | 46.00 | 35.56 | 35.36 |
| 336.00 | 14.91 | 2.53 | 12.00 | 9.00 | 46.00 | 29.44 | 26.44 |
| 399.99 | 16.70 | 2.81 | 15.00 | 13.00 | 46.00 | 34.51 | 32.51 |
| 432.00 | 17.05 | 2.92 | 7.00 | 10.00 | 46.00 | 26.97 | 29.97 |
| 480.00 | 17.58 | 3.09 | 6.50 | 8.00 | 46.00 | 27.17 | 28.67 |
| 528.00 | 18.11 | 3.27 | 3.60 | 7.60 | 46.00 | 24.98 | 28.98 |
| 576.00 | 18.64 | 3.46 | 2.80 | 3.00 | 46.00 | 24.89 | 25.09 |
| 750.00 | 20.20 | 4.05 | 7.80 | 3.50 | 46.00 | 32.05 | 27.75 |
| 799.98 | 20.70 | 4.23 | 3.30 | 3.70 | 46.00 | 28.23 | 28.63 |

Remark:

1. Emission level (dBμV/m) = Antenna Factor (dB/m) + Cable loss (dB) + Meter Reading (dBμV).
2. According to technical experience, all spurious emission at channel Low, Middle and High are almost the same below 1GHz, so the spurious emission test result of the channel Low was chosen as representative in final test.

**8.7.3 TRANSMITTER RADIATED EMISSION ABOVE 1 GHz**

| | | | |
|---------------------|--|----------------------------|-------------|
| Product Name | Microsoft Office Communicator USB Earbud | Test Date | 2006/11/24 |
| Model Name | 1107 | Test By | Alan Fan |
| Test Mode | CH Low TX | TEMP & Humidity | 23.9°C, 65% |

| Measurement Distance at 1m Horizontal polarity | | | | | | | | | | | |
|--|----------------|-----------|------------|--------------|-----------|-------------|-------------------|----------------|-------------|--------------|----------------|
| Freq. (MHz) | Reading (dBμV) | AF (dBμV) | Cable (dB) | Pre-amp (dB) | Dist (dB) | Filter (dB) | Level 1m (dBμV/m) | Limit (dBμV/m) | Margin (dB) | Mark (P/Q/A) | Height (Meter) |
| 1602.22 | 48.92 | 27.30 | 3.76 | 35.06 | 9.50 | 0.00 | 35.42 | 74.00 | -38.58 | P | 1.00 |
| 1602.22 | 38.17 | 27.30 | 3.76 | 35.06 | 9.50 | 0.00 | 24.67 | 54.00 | -29.33 | A | 1.00 |
| 3201.55 | 46.98 | 30.80 | 5.62 | 35.14 | 9.50 | 0.00 | 38.76 | 74.00 | -35.24 | P | 1.00 |
| 3201.55 | 34.14 | 30.80 | 5.62 | 35.14 | 9.50 | 0.00 | 25.92 | 54.00 | -28.08 | A | 1.00 |
| 4803.61 | 49.46 | 34.49 | 6.32 | 35.30 | 9.50 | 0.37 | 45.83 | 74.00 | -28.17 | P | 1.00 |
| 4803.61 | 34.42 | 34.49 | 6.32 | 35.30 | 9.50 | 0.37 | 30.79 | 54.00 | -23.21 | A | 1.00 |
| 9608.50 | 47.08 | 40.41 | 9.28 | 35.92 | 9.50 | 0.53 | 51.87 | 74.00 | -22.13 | P | 1.00 |
| 9608.50 | 32.61 | 40.41 | 9.28 | 35.92 | 9.50 | 0.53 | 37.40 | 54.00 | -16.60 | A | 1.00 |
| 12010.00 | 46.60 | 41.72 | 10.58 | 35.29 | 9.50 | 0.45 | 54.55 | 74.00 | -19.45 | P | 1.00 |
| 12010.00 | 32.42 | 41.72 | 10.58 | 35.29 | 9.50 | 0.45 | 40.37 | 54.00 | -13.63 | A | 1.00 |

| Measurement Distance at 1m Vertical polarity | | | | | | | | | | | |
|--|----------------|-----------|------------|--------------|-----------|-------------|-------------------|----------------|-------------|--------------|----------------|
| Freq. (MHz) | Reading (dBμV) | AF (dBμV) | Cable (dB) | Pre-amp (dB) | Dist (dB) | Filter (dB) | Level 1m (dBμV/m) | Limit (dBμV/m) | Margin (dB) | Mark (P/Q/A) | Height (Meter) |
| 1601.89 | 51.68 | 27.29 | 3.76 | 35.06 | 9.50 | 0.00 | 38.18 | 74.00 | -35.82 | P | 1.00 |
| 1601.89 | 45.35 | 27.29 | 3.76 | 35.06 | 9.50 | 0.00 | 31.85 | 54.00 | -22.15 | A | 1.00 |
| 3201.83 | 51.76 | 30.80 | 5.62 | 35.14 | 9.50 | 0.00 | 43.54 | 74.00 | -30.46 | P | 1.00 |
| 3201.83 | 43.84 | 30.80 | 5.62 | 35.14 | 9.50 | 0.00 | 35.62 | 54.00 | -18.38 | A | 1.00 |
| 4804.11 | 53.31 | 34.49 | 6.32 | 35.30 | 9.50 | 0.37 | 49.68 | 74.00 | -24.32 | P | 1.00 |
| 4804.11 | 36.77 | 34.49 | 6.32 | 35.30 | 9.50 | 0.37 | 33.14 | 54.00 | -20.86 | A | 1.00 |
| 9608.12 | 47.63 | 40.41 | 9.28 | 35.92 | 9.50 | 0.53 | 52.42 | 74.00 | -21.58 | P | 1.00 |
| 9608.12 | 32.83 | 40.41 | 9.28 | 35.92 | 9.50 | 0.53 | 37.62 | 54.00 | -16.38 | A | 1.00 |
| 12010.00 | 46.72 | 41.72 | 10.58 | 35.29 | 9.50 | 0.45 | 54.67 | 74.00 | -19.33 | P | 1.00 |
| 12010.00 | 32.71 | 41.72 | 10.58 | 35.29 | 9.50 | 0.45 | 40.66 | 54.00 | -13.34 | A | 1.00 |

Remark:

- The measurement was searched to 10th harmonic.
- AF: Antenna Factor, Cable: Cable Loss, Pre-Amp: Preamplifier gain, Filter: High Pass Filter Insertion Loss (3.5GHz)
- Spectrum analyzer setting P(Peak): RBW=1MHz, VBW=1MHz, A(Average): RBW=1MHz, VBW=10Hz
- Dist : correction to extra plate reading to 3m specification distance 1m measurement distance = -9.5dB
- The result basic equation calculation is as follow:
Level = Reading + AF + Cable - Preamp + Filter - Dist, Margin = Level-Limit
- The other emission levels were 20dB below the limit
- The test limit distance is 3M limit.



| | | | |
|---------------------|--|----------------------------|-------------|
| Product Name | Microsoft Office Communicator USB Earbud | Test Date | 2006/11/24 |
| Model Name | 1107 | Test By | Alan Fan |
| Test Mode | CH Middle TX | TEMP & Humidity | 23.9°C, 65% |

| Measurement Distance at 1m Horizontal polarity | | | | | | | | | | | |
|--|----------------|-----------|------------|--------------|-----------|-------------|-------------------|----------------|-------------|--------------|----------------|
| Freq. (MHz) | Reading (dBμV) | AF (dBμV) | Cable (dB) | Pre-amp (dB) | Dist (dB) | Filter (dB) | Level 1m (dBμV/m) | Limit (dBμV/m) | Margin (dB) | Mark (P/Q/A) | Height (Meter) |
| 1627.96 | 49.09 | 27.50 | 3.80 | 35.05 | 9.50 | 0.00 | 35.84 | 74.00 | -38.16 | P | 1.00 |
| 1627.96 | 32.15 | 27.50 | 3.80 | 35.05 | 9.50 | 0.00 | 18.90 | 54.00 | -35.10 | A | 1.00 |
| 3256.04 | 48.15 | 30.80 | 5.65 | 35.15 | 9.50 | 0.00 | 39.95 | 74.00 | -34.05 | P | 1.00 |
| 3256.04 | 34.36 | 30.80 | 5.65 | 35.15 | 9.50 | 0.00 | 26.16 | 54.00 | -27.84 | A | 1.00 |
| 4882.06 | 48.41 | 34.61 | 6.32 | 35.30 | 9.50 | 0.29 | 44.83 | 74.00 | -29.17 | P | 1.00 |
| 4882.06 | 32.97 | 34.61 | 6.32 | 35.30 | 9.50 | 0.29 | 29.39 | 54.00 | -24.61 | A | 1.00 |
| 9764.20 | 46.88 | 40.29 | 9.57 | 35.95 | 9.50 | 0.58 | 51.87 | 74.00 | -22.13 | P | 1.00 |
| 9764.20 | 32.99 | 40.29 | 9.57 | 35.95 | 9.50 | 0.58 | 37.98 | 54.00 | -16.02 | A | 1.00 |
| 12205.21 | 46.48 | 42.03 | 10.52 | 35.18 | 9.50 | 0.38 | 54.73 | 74.00 | -19.27 | P | 1.00 |
| 12205.21 | 32.68 | 42.03 | 10.52 | 35.18 | 9.50 | 0.38 | 40.93 | 54.00 | -13.07 | A | 1.00 |

| Measurement Distance at 1m Vertical polarity | | | | | | | | | | | |
|--|----------------|-----------|------------|--------------|-----------|-------------|-------------------|----------------|-------------|--------------|----------------|
| Freq. (MHz) | Reading (dBμV) | AF (dBμV) | Cable (dB) | Pre-amp (dB) | Dist (dB) | Filter (dB) | Level 1m (dBμV/m) | Limit (dBμV/m) | Margin (dB) | Mark (P/Q/A) | Height (Meter) |
| 1627.97 | 51.95 | 27.50 | 3.80 | 35.05 | 9.50 | 0.00 | 38.70 | 74.00 | -35.30 | P | 1.00 |
| 1627.97 | 46.99 | 27.50 | 3.80 | 35.05 | 9.50 | 0.00 | 33.74 | 54.00 | -20.26 | A | 1.00 |
| 3255.76 | 51.34 | 30.80 | 5.65 | 35.15 | 9.50 | 0.00 | 43.14 | 74.00 | -30.86 | P | 1.00 |
| 3255.76 | 43.37 | 30.80 | 5.65 | 35.15 | 9.50 | 0.00 | 35.17 | 54.00 | -18.83 | A | 1.00 |
| 4881.98 | 50.33 | 34.61 | 6.32 | 35.30 | 9.50 | 0.29 | 46.75 | 74.00 | -27.25 | P | 1.00 |
| 4881.98 | 34.94 | 34.61 | 6.32 | 35.30 | 9.50 | 0.29 | 31.36 | 54.00 | -22.64 | A | 1.00 |
| 9764.20 | 46.65 | 40.29 | 9.57 | 35.95 | 9.50 | 0.58 | 51.64 | 74.00 | -22.36 | P | 1.00 |
| 9764.20 | 33.00 | 40.29 | 9.57 | 35.95 | 9.50 | 0.58 | 37.99 | 54.00 | -16.01 | A | 1.00 |
| 12205.21 | 46.81 | 42.03 | 10.52 | 35.18 | 9.50 | 0.38 | 55.06 | 74.00 | -18.94 | P | 1.00 |
| 12205.21 | 32.66 | 42.03 | 10.52 | 35.18 | 9.50 | 0.38 | 40.91 | 54.00 | -13.09 | A | 1.00 |

Remark:

1. The measurement was searched to 10th harmonic.
2. AF: Antenna Factor, Cable: Cable Loss, Pre-Amp: Preamplifier gain, Filter: High Pass Filter Insertion Loss (3.5GHz)
3. Spectrum analyzer setting P(Peak): RBW=1MHz, VBW=1MHz, A(Average): RBW=1MHz, VBW=10Hz
4. Dist : correction to extra plate reading to 3m specification distance 1m measurement distance = -9.5dB
5. The result basic equation calculation is as follow:
Level = Reading + AF + Cable – Preamp + Filter – Dist, Margin = Level-Limit
6. The other emission levels were 20dB below the limit
7. The test limit distance is 3M limit.



| | | | |
|---------------------|--|----------------------------|-------------|
| Product Name | Microsoft Office Communicator USB Earbud | Test Date | 2006/11/24 |
| Model Name | 1107 | Test By | Alan Fan |
| Test Mode | CH High TX | TEMP & Humidity | 23.9°C, 65% |

| Measurement Distance at 1m Horizontal polarity | | | | | | | | | | | |
|--|----------------|-----------|------------|--------------|-----------|-------------|-------------------|----------------|-------------|--------------|----------------|
| Freq. (MHz) | Reading (dBμV) | AF (dBμV) | Cable (dB) | Pre-amp (dB) | Dist (dB) | Filter (dB) | Level 1m (dBμV/m) | Limit (dBμV/m) | Margin (dB) | Mark (P/Q/A) | Height (Meter) |
| 1654.11 | 49.70 | 27.70 | 3.84 | 35.04 | 9.50 | 0.00 | 36.71 | 74.00 | -37.29 | P | 1.00 |
| 1654.11 | 42.26 | 27.70 | 3.84 | 35.04 | 9.50 | 0.00 | 29.27 | 54.00 | -24.73 | A | 1.00 |
| 3307.84 | 49.76 | 30.80 | 5.68 | 35.16 | 9.50 | 0.00 | 41.58 | 74.00 | -32.42 | P | 1.00 |
| 3307.84 | 37.61 | 30.80 | 5.68 | 35.16 | 9.50 | 0.00 | 29.43 | 54.00 | -24.57 | A | 1.00 |
| 4960.11 | 48.78 | 34.74 | 6.32 | 35.30 | 9.50 | 0.21 | 45.25 | 74.00 | -28.75 | P | 1.00 |
| 4960.11 | 33.42 | 34.74 | 6.32 | 35.30 | 9.50 | 0.21 | 29.89 | 54.00 | -24.11 | A | 1.00 |
| 9920.32 | 46.69 | 40.16 | 9.87 | 35.98 | 9.50 | 0.63 | 51.87 | 74.00 | -22.13 | P | 1.00 |
| 9920.32 | 32.65 | 40.16 | 9.87 | 35.98 | 9.50 | 0.63 | 37.83 | 54.00 | -16.17 | A | 1.00 |
| 12400.20 | 47.35 | 42.34 | 10.46 | 35.06 | 9.50 | 0.32 | 55.91 | 74.00 | -18.09 | P | 1.00 |
| 12400.20 | 33.10 | 42.34 | 10.46 | 35.06 | 9.50 | 0.32 | 41.66 | 54.00 | -12.34 | A | 1.00 |

| Measurement Distance at 1m Vertical polarity | | | | | | | | | | | |
|--|----------------|-----------|------------|--------------|-----------|-------------|-------------------|----------------|-------------|--------------|----------------|
| Freq. (MHz) | Reading (dBμV) | AF (dBμV) | Cable (dB) | Pre-amp (dB) | Dist (dB) | Filter (dB) | Level 1m (dBμV/m) | Limit (dBμV/m) | Margin (dB) | Mark (P/Q/A) | Height (Meter) |
| 1654.18 | 52.87 | 27.70 | 3.84 | 35.04 | 9.50 | 0.00 | 39.88 | 74.00 | -34.12 | P | 1.00 |
| 1654.18 | 47.09 | 27.70 | 3.84 | 35.04 | 9.50 | 0.00 | 34.10 | 54.00 | -19.90 | A | 1.00 |
| 3307.98 | 50.64 | 30.80 | 5.68 | 35.16 | 9.50 | 0.00 | 42.46 | 74.00 | -31.54 | P | 1.00 |
| 3307.98 | 39.15 | 30.80 | 5.68 | 35.16 | 9.50 | 0.00 | 30.97 | 54.00 | -23.03 | A | 1.00 |
| 4960.05 | 49.69 | 34.74 | 6.32 | 35.30 | 9.50 | 0.21 | 46.16 | 74.00 | -27.84 | P | 1.00 |
| 4960.05 | 33.81 | 34.74 | 6.32 | 35.30 | 9.50 | 0.21 | 30.28 | 54.00 | -23.72 | A | 1.00 |
| 9920.32 | 46.65 | 40.16 | 9.87 | 35.98 | 9.50 | 0.63 | 51.83 | 74.00 | -22.17 | P | 1.00 |
| 9920.32 | 32.45 | 40.16 | 9.87 | 35.98 | 9.50 | 0.63 | 37.63 | 54.00 | -16.37 | A | 1.00 |
| 12400.20 | 47.19 | 42.34 | 10.46 | 35.06 | 9.50 | 0.32 | 55.75 | 74.00 | -18.25 | P | 1.00 |
| 12400.20 | 33.09 | 42.34 | 10.46 | 35.06 | 9.50 | 0.32 | 41.65 | 54.00 | -12.35 | A | 1.00 |

Remark:

1. The measurement was searched to 10th harmonic.
2. AF: Antenna Factor, Cable: Cable Loss, Pre-Amp: Preamplifier gain, Filter: High Pass Filter Insertion Loss (3.5GHz)
3. Spectrum analyzer setting P(Peak): RBW=1MHz, VBW=1MHz, A(Average): RBW=1MHz, VBW=10Hz
4. Dist : correction to extra plate reading to 3m specification distance 1m measurement distance = -9.5dB
5. The result basic equation calculation is as follow:

$$\text{Level} = \text{Reading} + \text{AF} + \text{Cable} - \text{Preamp} + \text{Filter} - \text{Dist}, \text{Margin} = \text{Level} - \text{Limit}$$
6. The other emission levels were 20dB below the limit
7. The test limit distance is 3M limit.



8.7.4 RESTRICTED BAND EDGES

Detector mode : Peak

Polarity : Horizontal

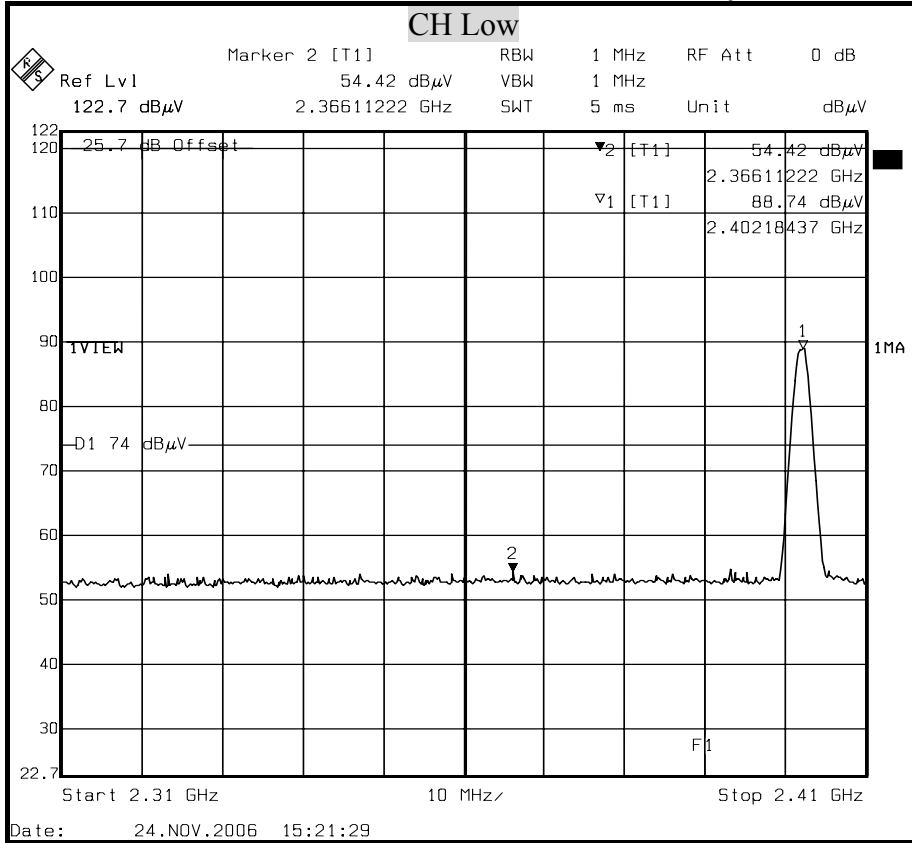

Detector mode : Average

Polarity : Horizontal

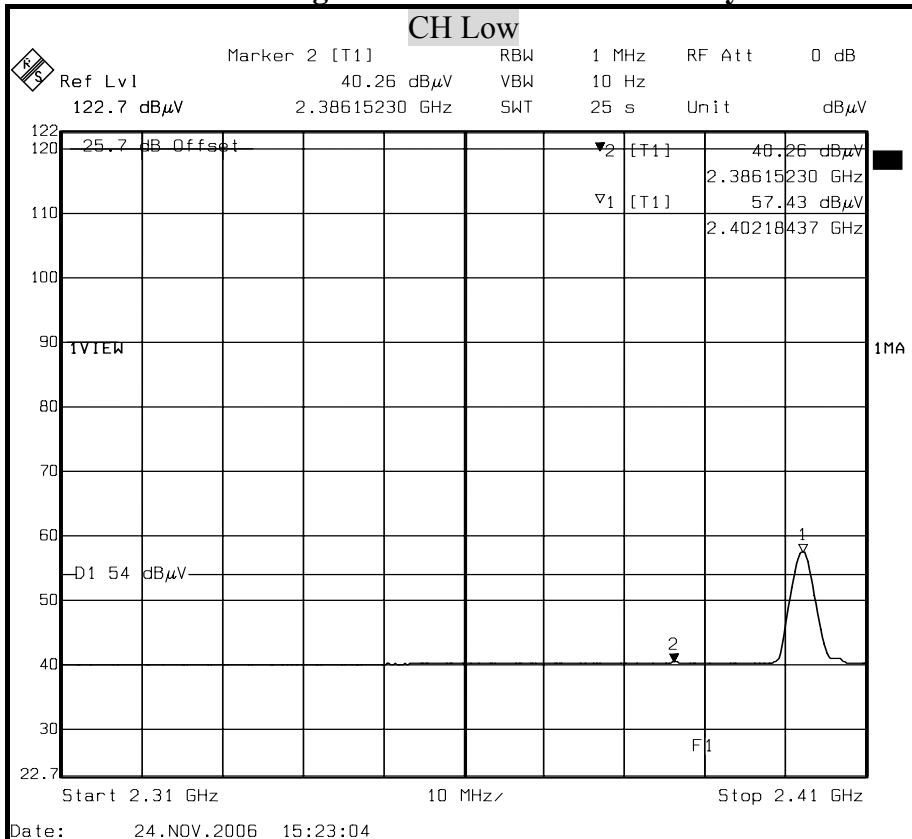



Detector mode : Peak

Polarity : Vertical

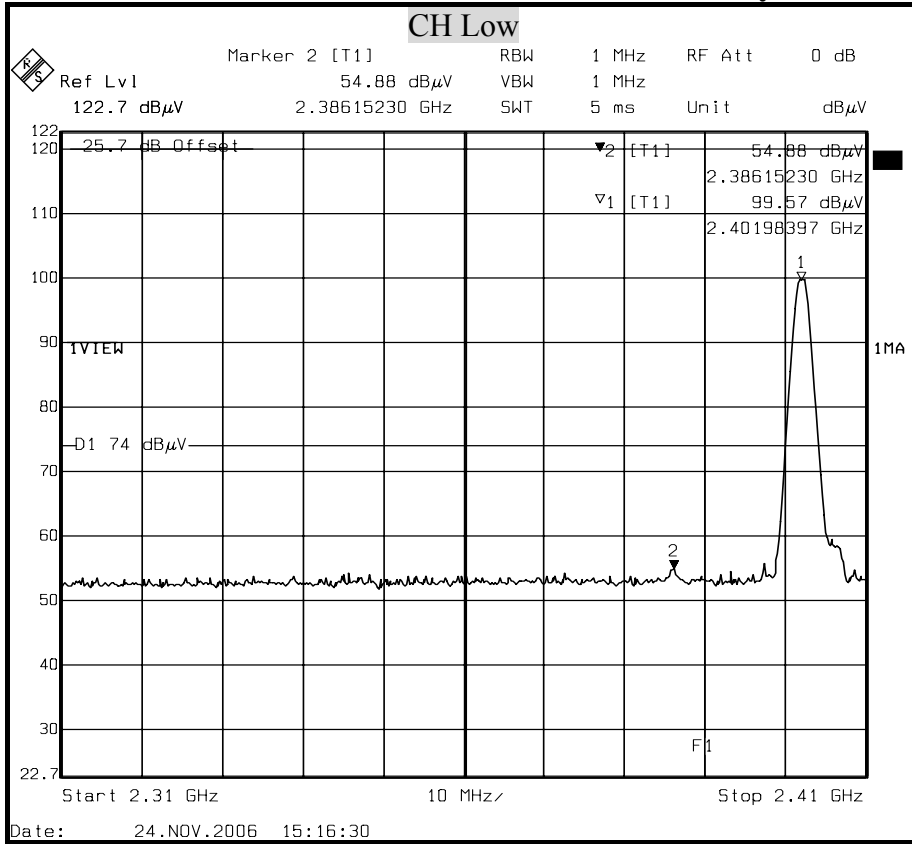

Detector mode : Average

Polarity : Vertical

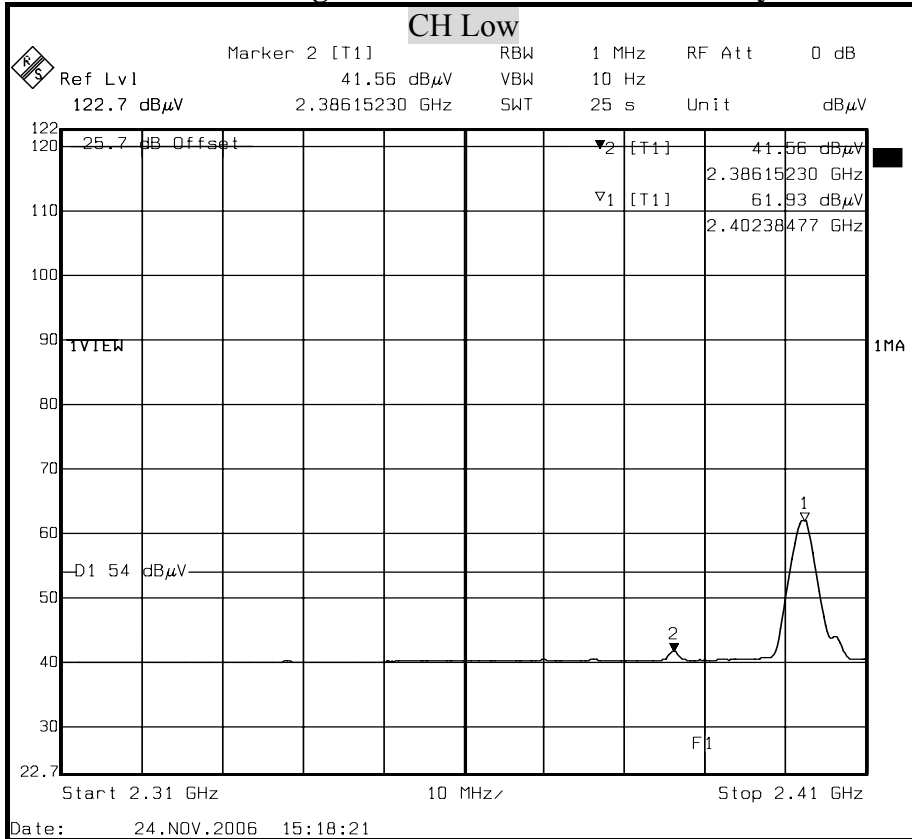



Detector mode : Peak

Polarity : Horizontal

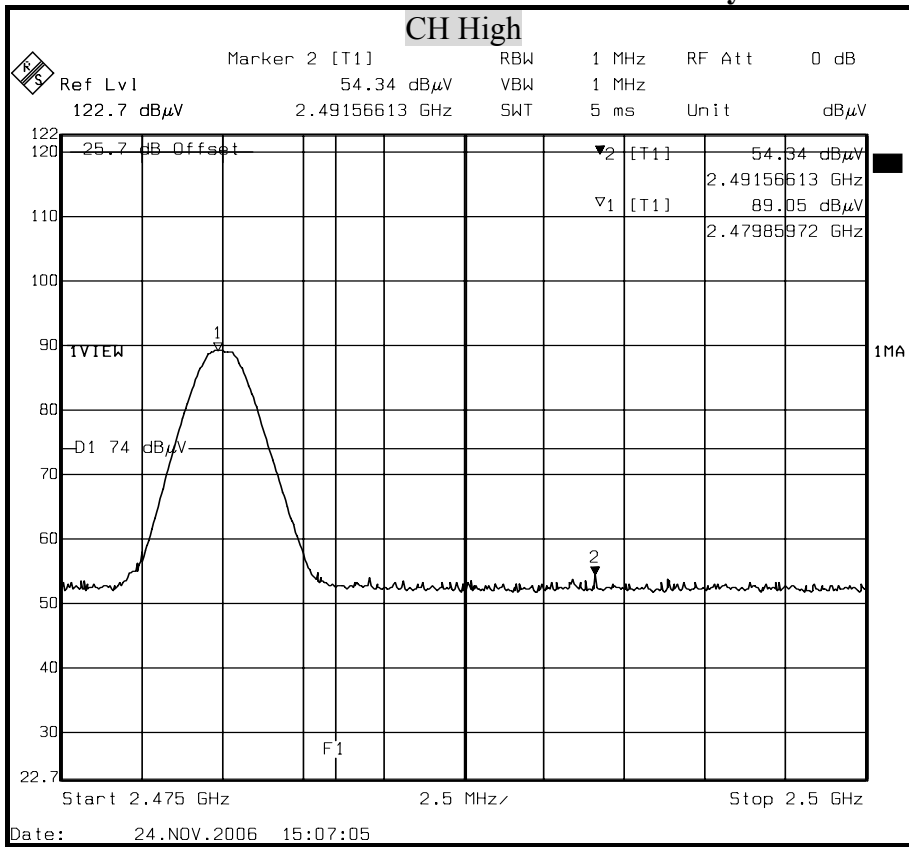

Detector mode : Average

Polarity : Horizontal

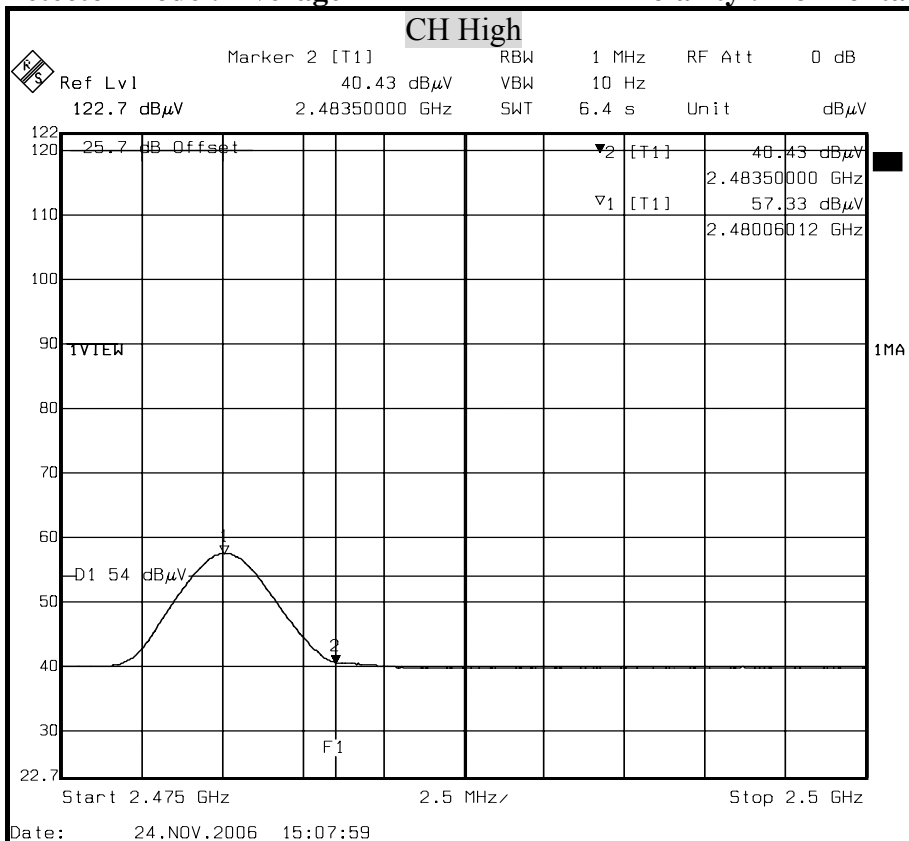



Detector mode : Peak

Polarity : Vertical

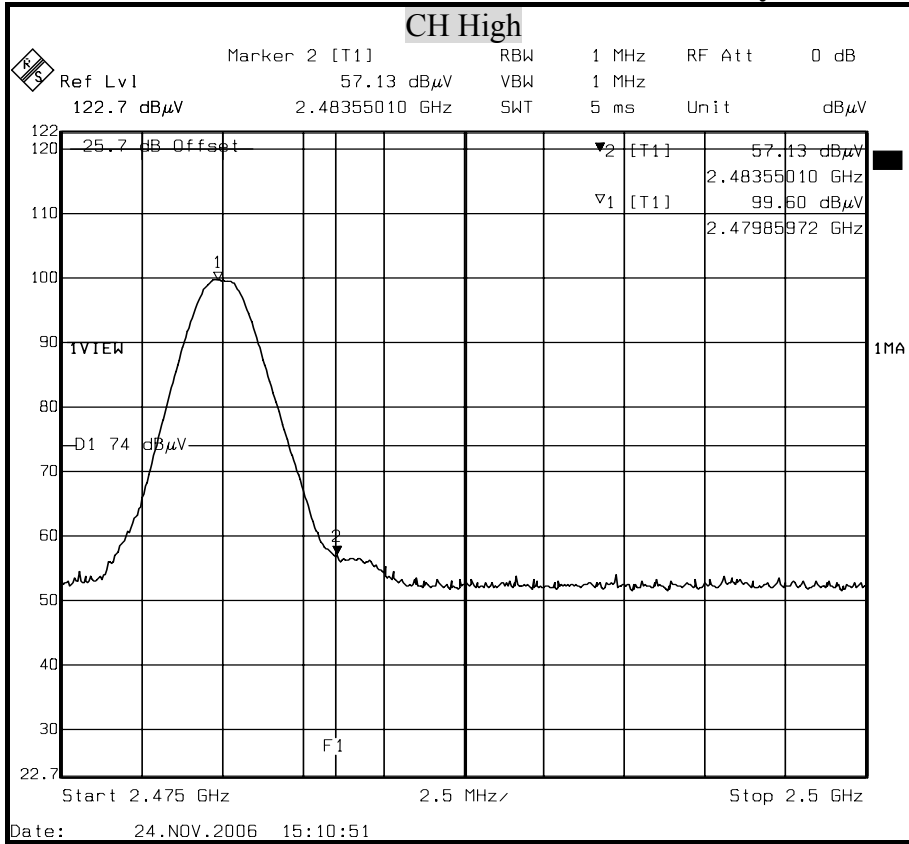

Detector mode : Average

Polarity : Vertical

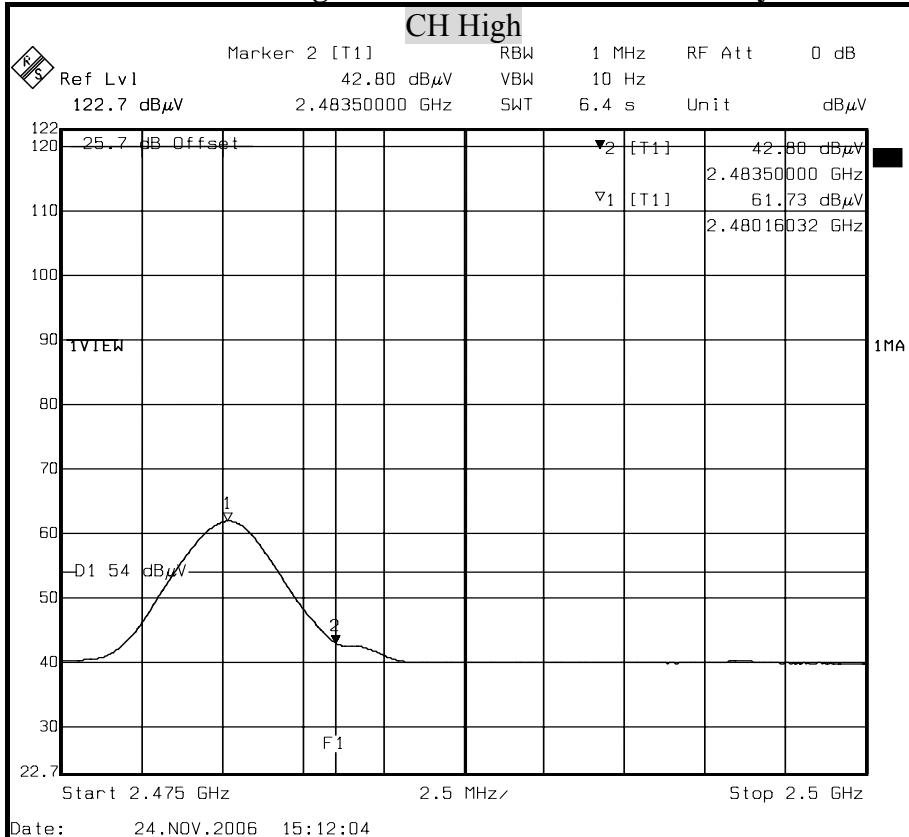



8.9 POWERLINE CONDUCTED EMISSIONS

LIMITS

§ 15.207 (a) Except as shown in paragraph (b) and (c) this section, for an intentional radiator that is designed to be connected to the public utility (AC) power line, the radio frequency voltage that is conducted back onto the AC power line on any frequency or frequencies within the band 150 kHz to 30 MHz shall not exceed the limits in the following table, as measured using a 50 μ H/50 ohms line impedance stabilization network (LISN). Compliance with the provisions of this paragraph shall be based on the measurement of the radio frequency voltage between each power line and ground at the power terminal.

The lower limit applies at the boundary between the frequency ranges.

| Frequency of Emission (MHz) | Conducted limit (dB μ v) | |
|-----------------------------|------------------------------|----------|
| | Quasi-peak | Average |
| 0.15 - 0.5 | 66 to 56 | 56 to 46 |
| 0.5 - 5 | 56 | 46 |
| 5 - 30 | 60 | 50 |

TEST EQUIPMENTS

The following test equipments are used during the conducted powerline tests :

| Manufacturer or Type | Model No. | Serial No. | Date of Calibration | Calibration Period | Remark |
|------------------------|-----------|-------------|---------------------|--------------------|--------|
| EMCO L.I.S.N. | 3850/2 | 9311-1025 | January 16, 2006 | 1 Year | FINAL |
| CHASE L.I.S.N | NNLK 8129 | 8129118 | January 16, 2006 | 1 Year | FINAL |
| R & S TEST RECEIVER | ESHS30 | 838550/003 | February 27, 2006 | 1 Year | FINAL |
| KEENE SHIELDED ROOM | 5983 | No.1 | N/A | N/A | FINAL |
| R & S PULSE LIMIT | EHS3Z2 | 357.8810.52 | July 10, 2006 | 1 Year | FINAL |
| N TYPE COAXIAL CABLE | ----- | ----- | August 21, 2006 | 1 Year | FINAL |
| 50 Ω TERMINATOR | ----- | ----- | July 10, 2006 | 1 Year | FINAL |

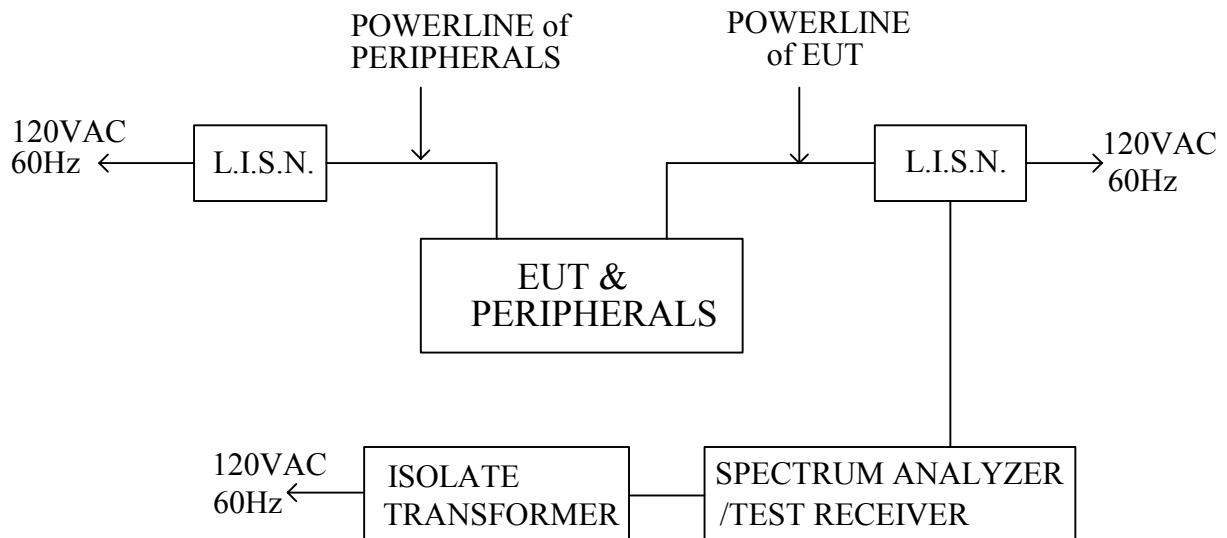
**TEST SETUP****TEST PROCEDURE**

The EUT is placed on a non-conducting table 40 cm from the vertical ground plane and 80cm above the horizontal ground plane. The EUT IS CONFIGURED IN ACCORDANCE WITH ANSI C63.4.

The resolution bandwidth is set to 9 kHz for both quasi-peak detection and average detection measurements.

Line conducted data is recorded for both NEUTRAL and LINE.

TEST RESULTS

No non-compliance noted



CONDUCTED RF VOLTAGE MEASUREMENT

| | | | |
|---------------------|--|----------------------------|--------------|
| Product Name | Microsoft Office Communicator USB Earbud | Test Date | 2006/11/18 |
| Model | 1107 | Test By | Alan Fan |
| Test Mode | Electrify Mode (worst case) | TEMP & Humidity | 26.5 °C, 55% |

LINE

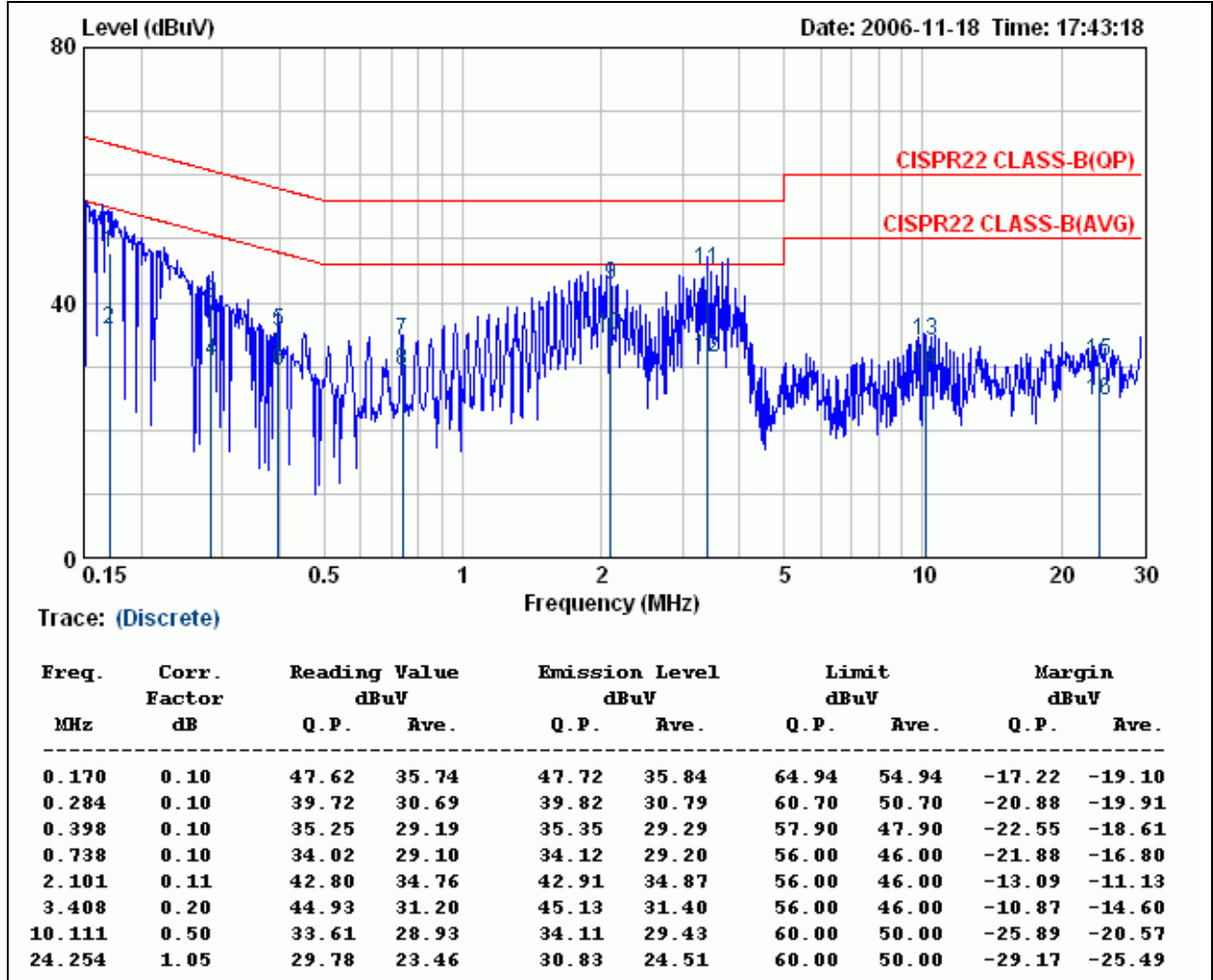

Remark:

1. Correction Factor = Insertion loss + cable loss
2. Margin value = Emission level – Limit value



| | | | |
|---------------------|--|----------------------------|-------------|
| Product Name | Microsoft Office Communicator USB Earbud | Test Date | 2006/11/18 |
| Model | 1107 | Test By | Alan Fan |
| Test Mode | Electrify Mode (worst case) | TEMP & Humidity | 26.5°C, 55% |

NEUTRAL

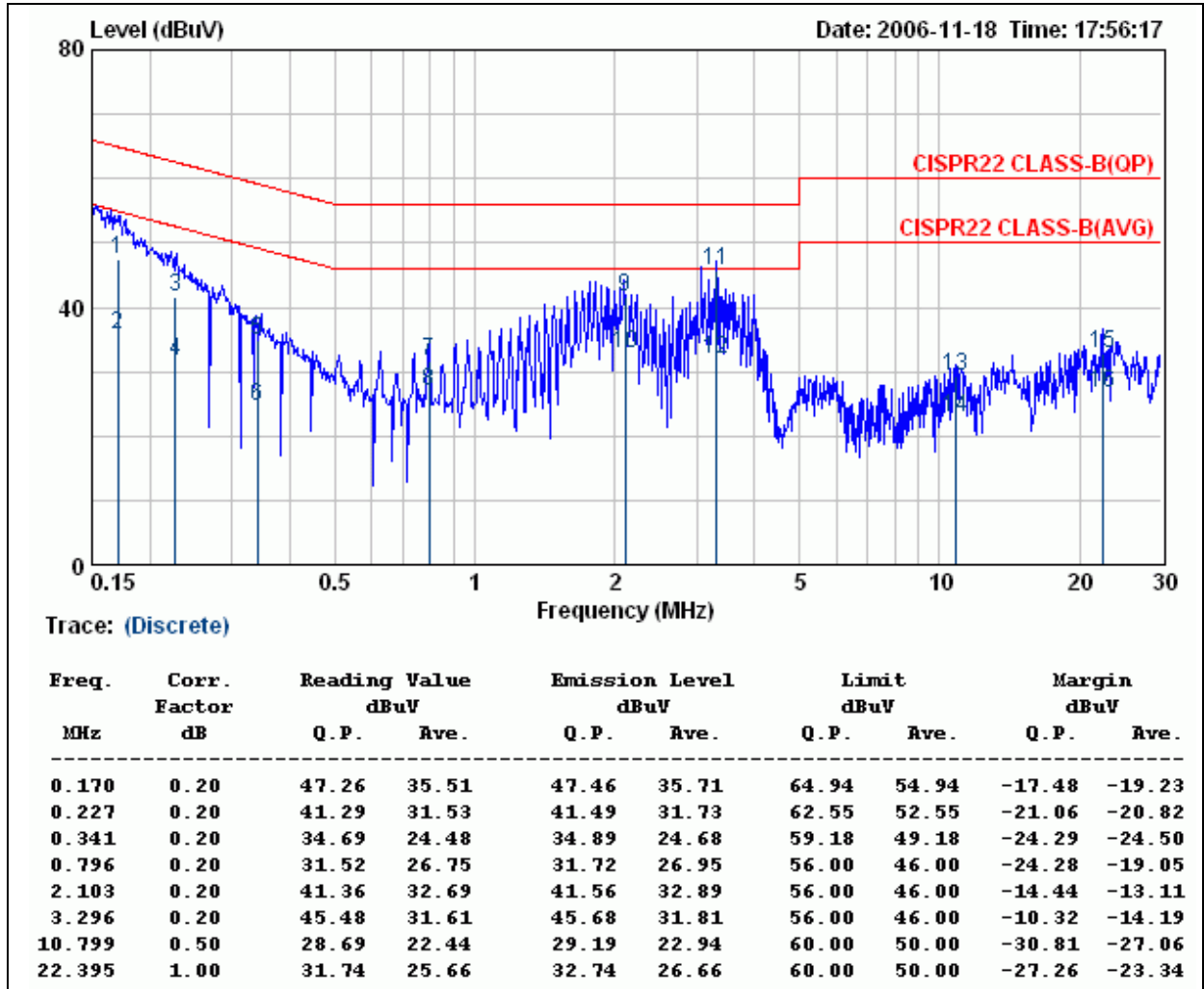

Remark:

1. Correction Factor = Insertion loss + cable loss
2. Margin value = Emission level - Limit value



9. ANTENNA REQUIREMENT

9.1 STANDARD APPLICABLE

For intentional device, according to FCC 47 CFR Section 15.203, an intentional radiator shall be designed to ensure that no antenna other than that furnished by the responsible party shall be used with the device.

And according to FCC 47 CFR Section 15.247 (b), if transmitting antennas of directional gain greater than 6dBi are used, the power shall be reduced by the amount in dB that the directional gain of the antenna exceeds 6dBi.

9.2 ANTENNA CONNECTED CONSTRUCTION

The antenna used in this product is PCB antenna. The maximum Gain of the antenna only 2.88dBi.



APPENDIX SETUP PHOTOS

RADIATED EMISSION MEASUREMENT SETUP







RADIATED RF MEASUREMENT SETUP





RF PORT COUNTED MEASURE SETUP

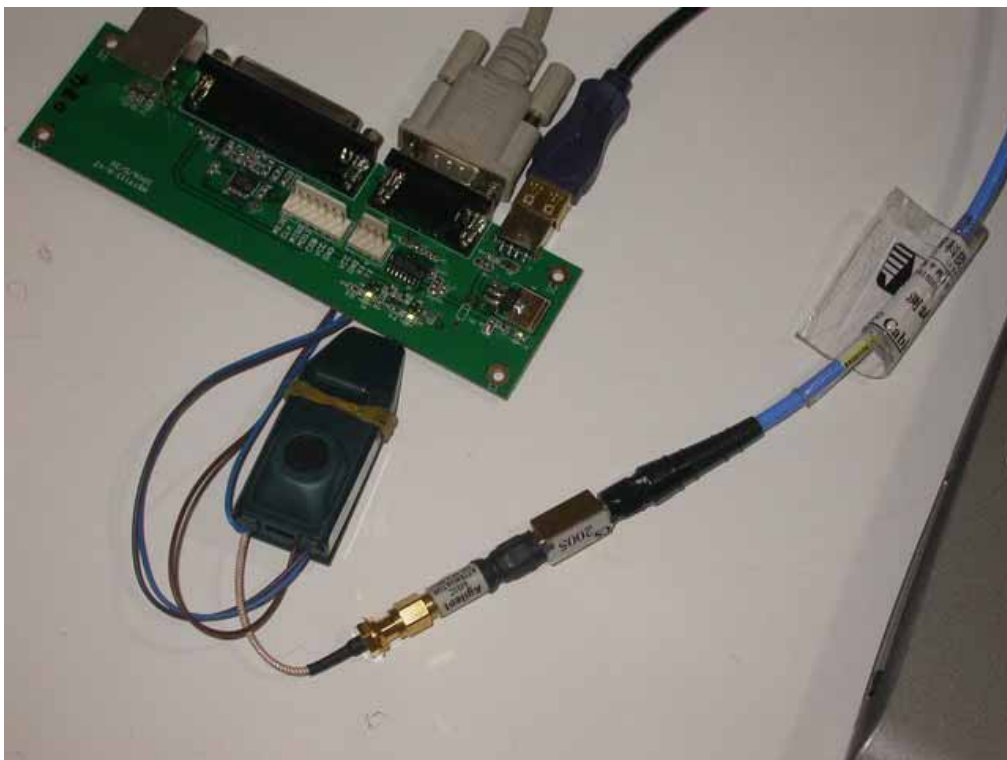



POWERLINE CONDUCTED EMISSIONS MEASUREMENT SETUP

