

TEST REPORT

CERTIFICATE OF CONFORMITY

Standard: 47 CFR FCC Part 15, Subpart C (Section 15.247)

Report No.: RFBEOA-WTW-P22040911

FCC ID: BYG-ADRM13

Model No.: ADRM13

Received Date: 2022/3/28

Test Date: 2022/5/12 ~ 2022/5/23

Issued Date: 2022/6/22

Applicant: Sangean Electronics Inc.

Address: No. 18, Lane 7, Li-De Street, Chung Ho District, New Taipei City, 235, Taiwan

Issued By: Bureau Veritas Consumer Products Services (H.K.) Ltd., Taoyuan Branch
Lin Kou Laboratories

Lab Address: No. 47-2, 14th Ling, Chia Pau Vil., Lin Kou Dist., New Taipei City, Taiwan

Test Location: No. 47-2, 14th Ling, Chia Pau Vil., Lin Kou Dist., New Taipei City, Taiwan

FCC Registration / 198487 / TW2021

Designation Number:

Approved by: Jeremy Lin , **Date:** 2022/6/22
Jeremy Lin / Project Engineer

This test report consists of 46 pages in total. It may be duplicated completely for legal use with the approval of the applicant. It should not be reproduced except in full, without the written approval of our laboratory. The test results in the report only apply to the tested sample. The test results in this report are traceable to the national or international standards.

Prepared by : Annie Chang / Senior Specialist



This report is governed by, and incorporates by reference, the Conditions of Testing as posted at the date of issuance of this report at <http://www.bureauveritas.com/home/about-us/our-business/cps/about-us/terms-conditions/> and is intended for your exclusive use. Any copying or replication of this report to or for any other person or entity, or use of our name or trademark, is permitted only with our prior written permission. This report sets forth our findings solely with respect to the test samples identified herein. The results set forth in this report are not indicative or representative of the quality or characteristics of the lot from which a test sample was taken or any similar or identical product unless specifically and expressly noted. Our report includes all of the tests requested by you and the results thereof based upon the information that you provided to us. Measurement uncertainty is only provided upon request for accredited tests. Statements of conformity are based on simple acceptance criteria without taking measurement uncertainty into account, unless otherwise requested in writing. You have 60 days from date of issuance of this report to notify us of any material error or omission caused by our negligence or if you require measurement uncertainty; provided, however, that such notice shall be in writing and shall specifically address the issue you wish to raise. A failure to raise such issue within the prescribed time shall constitute your unqualified acceptance of the completeness of this report, the tests conducted and the correctness of the report contents.

Table of Contents

Release Control Record	4
1 Certificate	5
2 Summary of Test Results	6
2.1 Measurement Uncertainty	6
2.2 Supplementary Information	6
3 General Information	7
3.1 General Description	7
3.2 Antenna Description of EUT	7
3.3 Channel List	8
3.4 Test Mode Applicability and Tested Channel Detail	9
3.5 Duty Cycle of Test Signal	9
3.6 Test Program Used and Operation Descriptions	10
3.7 Connection Diagram of EUT and Peripheral Devices	10
3.8 Configuration of Peripheral Devices and Cable Connections	10
4 Test Instruments	11
4.1 RF Output Power	11
4.2 Number of Hopping Frequency Used	11
4.3 Dwell Time on Each Channel	11
4.4 Hopping Channel Separation	11
4.5 20 dB Bandwidth	11
4.6 Conducted Out of Band Emissions	11
4.7 Unwanted Emissions below 1 GHz	12
4.8 Unwanted Emissions above 1 GHz	13
5 Limits of Test Items	14
5.1 RF Output Power	14
5.2 Number of Hopping Frequency Used	14
5.3 Dwell Time on Each Channel	14
5.4 Hopping Channel Separation	14
5.5 20 dB Bandwidth	14
5.6 Conducted Out of Band Emissions	14
5.7 Unwanted Emissions below 1 GHz	14
5.8 Unwanted Emissions above 1 GHz	15
6 Test Arrangements	16
6.1 RF Output Power	16
6.1.1 Test Setup	16
6.1.2 Test Procedure	16
6.2 Number of Hopping Frequency Used	16
6.2.1 Test Setup	16
6.2.2 Test Procedure	16
6.3 Dwell Time on Each Channel	17
6.3.1 Test Setup	17
6.3.2 Test Procedure	17
6.4 Hopping Channel Separation	17
6.4.1 Test Setup	17
6.4.2 Test Procedure	17
6.5 20 dB Bandwidth	18
6.5.1 Test Setup	18
6.5.2 Test Procedure	18
6.6 Conducted Out of Band Emissions	18
6.6.1 Test Setup	18
6.6.2 Test Procedure	18
6.7 Unwanted Emissions below 1 GHz	19
6.7.1 Test Setup	19
6.7.2 Test Procedure	20



6.8	Unwanted Emissions above 1 GHz.....	21
6.8.1	Test Setup	21
6.8.2	Test Procedure.....	21
7	Test Results of Test Item	22
7.1	RF Output Power.....	22
7.2	Number of Hopping Frequency Used.....	23
7.3	Dwell Time on Each Channel	24
7.4	Hopping Channel Separation	26
7.5	20 dB Bandwidth	27
7.6	Conducted Out of Band Emissions	28
7.7	Unwanted Emissions below 1 GHz	30
7.8	Unwanted Emissions above 1 GHz.....	32
8	Pictures of Test Arrangements	45
9	Information of the Testing Laboratories	46



Release Control Record

Issue No.	Description	Date Issued
RFBEOA-WTW-P22040911	Original release.	2022/6/22

1 Certificate

Product: Cordless Radio with Lantern

Brand: Makita

Test Model: ADRM13

Sample Status: Engineering sample

Applicant: Sangean Electronics Inc.

Test Date: 2022/5/12 ~ 2022/5/23

Standard: 47 CFR FCC Part 15, Subpart C (Section 15.247)

Measurement ANSI C63.10-2013

procedure: KDB 558074 D01 15.247 Meas Guidance v05r02

The above equipment has been tested by **Bureau Veritas Consumer Products Services (H.K.) Ltd., Taoyuan Branch**, and found compliance with the requirement of the above standards. The test record, data evaluation & Equipment Under Test (EUT) configurations represented herein are true and accurate accounts of the measurements of the sample's RF characteristics under the conditions specified in this report.

2 Summary of Test Results

47 CFR FCC Part 15, Subpart C (Section 15.247)			
Standard / Clause	Test Item	Result	Remark
15.247 (a)(1)	RF Output Power	Pass	Meet the requirement of limit.
15.247(a)(1) (iii)	Number of Hopping Frequency Used	Pass	Meet the requirement of limit.
15.247(a)(1) (iii)	Dwell Time on Each Channel	Pass	Meet the requirement of limit.
15.247(a)(1)	Hopping Channel Separation	Pass	Meet the requirement of limit.
15.247(a)(1)	20 dB Bandwidth	Pass	Refer to note 1
15.247(d)	Conducted Out of Band Emissions	Pass	Meet the requirement of limit.
15.205 / 15.209 / 15.247(d)	Unwanted Emissions below 1 GHz	Pass	Minimum passing margin is -17.6 dB at 208.00 MHz
15.205 / 15.209 / 15.247(d)	Unwanted Emissions above 1 GHz	Pass	Minimum passing margin is -12.7 dB at 2390.00 MHz
15.203	Antenna Requirement	Pass	No antenna connector is used.

Notes:

1. If the Frequency Hopping System operating in 2400-2483.5 MHz band and the output power less than 125 mW. The hopping channel carrier frequencies separated by a minimum of 25 kHz or two-thirds of the 20 dB bandwidth of hopping channel whichever is greater.
2. Determining compliance based on the results of the compliance measurement, not taking into account measurement instrumentation uncertainty.

2.1 Measurement Uncertainty

Where relevant, the following measurement uncertainty levels have been estimated for tests performed on the EUT as specified in CISPR 16-4-2:

Parameter	Specification	Uncertainty
Conducted Out of Band Emissions	9 kHz ~ 40 GHz	2.63 dB
Unwanted Emissions below 1 GHz	9 kHz ~ 30 MHz	2.38 dB
	30 MHz ~ 1 GHz	5.62 dB
Unwanted Emissions above 1 GHz	1 GHz ~ 6 GHz	4.61 dB
	6 GHz ~ 18 GHz	5.41 dB
	18 GHz ~ 40 GHz	5.14 dB

The other instruments specified are routine verified to remain within the calibrated levels, no measurement uncertainty is required to be calculated.

2.2 Supplementary Information

There is not any deviation from the test standards for the test method, and no modifications required for compliance.

3 General Information

3.1 General Description

Product	Cordless Radio with Lantern
Brand	Makita
Test Model	ADRM13
Status of EUT	Engineering sample
Power Supply Rating	14.4Vdc & 18Vdc from battery
Modulation Type	GFSK, $\pi/4$ -DQPSK, 8DPSK
Modulation Technology	FHSS
Transfer Rate	Up to 3 Mbps
Operating Frequency	2402 ~ 2480 MHz
Number of Channel	79
Output Power	Peak: 1.517 mW (1.81 dBm) Average: 1.455 mW (1.63 dBm)

Note:

1. The EUT is a Cordless Radio with Lantern with Bluetooth technology.
2. The EUT consumes power from the following battery. (For support unit only)

Battery	
Battery 1	Makita, BL1860B (18Vdc, 6000mAh, 108Wh)
Battery 2	Makita, BL1830B (18Vdc, 3.0Ah, 54Wh)
Battery 3	Makita, BL1815N (18Vdc, 1.5Ah, 27Wh)
Battery 4	Makita, BL1460B (14.4Vdc, 6.0Ah, 87Wh)
Battery 5	Makita, BL1430B (14.4Vdc, 3000mAh, 44Wh)
Battery 6	Makita, BL1415N (14.4Vdc, 1.5Ah, 22Wh)

3. The above EUT information is declared by manufacturer and for more detailed features description, please refer to the manufacturer's specifications or User's Manual.

3.2 Antenna Description of EUT

The antenna information is listed as below.

Antenna Type	Gain (dBi)	Connector Type
PCB	1.927	N/A

*The above Antenna information is declared by manufacturer and for more detailed features description, please refer to the manufacturer's specifications, the laboratory shall not be held responsible.

3.3 Channel List

79 channels are provided for BT-EDR:

Channel	Frequency (MHz)	Channel	Frequency (MHz)	Channel	Frequency (MHz)	Channel	Frequency (MHz)
0	2402	20	2422	40	2442	60	2462
1	2403	21	2423	41	2443	61	2463
2	2404	22	2424	42	2444	62	2464
3	2405	23	2425	43	2445	63	2465
4	2406	24	2426	44	2446	64	2466
5	2407	25	2427	45	2447	65	2467
6	2408	26	2428	46	2448	66	2468
7	2409	27	2429	47	2449	67	2469
8	2410	28	2430	48	2450	68	2470
9	2411	29	2431	49	2451	69	2471
10	2412	30	2432	50	2452	70	2472
11	2413	31	2433	51	2453	71	2473
12	2414	32	2434	52	2454	72	2474
13	2415	33	2435	53	2455	73	2475
14	2416	34	2436	54	2456	74	2476
15	2417	35	2437	55	2457	75	2477
16	2418	36	2438	56	2458	76	2478
17	2419	37	2439	57	2459	77	2479
18	2420	38	2440	58	2460	78	2480
19	2421	39	2441	59	2461		

3.4 Test Mode Applicability and Tested Channel Detail

Pre-Scan:	EUT can be used in the following ways: XYZ 3-axis. Pre-scan in these ways and find the worst case as a representative test condition.
Worst Case:	X/ Y/ Z Worst Condition: Z Axis for Unwanted Emission above 1GHz and Unwanted Emission below 1GHz.

Following channel(s) was (were) selected for the final test as listed below:

Test Item	Tested Channel	Modulation	Data Rate Parameter
Unwanted Emissions below 1 GHz	78	GFSK	DH5
Unwanted Emissions above 1 GHz	0, 39, 78	GFSK	DH5
		8DPSK	3DH5
RF Output Power	0, 39, 78	GFSK	DH5
		8DPSK	3DH5
Hopping Channel Separation / 20 dB Bandwidth	0, 39, 78	GFSK	DH5
		8DPSK	3DH5
Number of Hopping Frequency Used / Conducted Out of Band Emissions	0, 39, 78	GFSK	DH5
		8DPSK	3DH5
Dwell Time on Each Channel	Hopping mode	GFSK	DH1, DH3, DH5
	Hopping mode	8DPSK	3HD1, 3DH3, 3DH5

3.5 Duty Cycle of Test Signal

GFSK: Duty cycle = 2.889 ms / 100 ms x 100% = 2.9%

8DPSK: Duty cycle = 2.889 ms / 100 ms x 100% = 2.9%

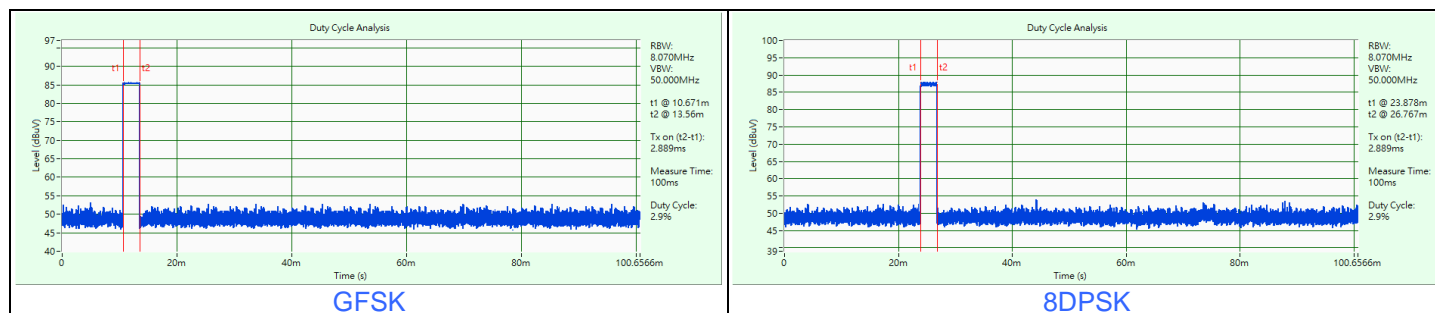

3.6 Test Program Used and Operation Descriptions

Controlling software (ISRT v2.1.26.4422) has been activated to set the EUT under transmission condition continuously at specific channel frequency.

3.7 Connection Diagram of EUT and Peripheral Devices

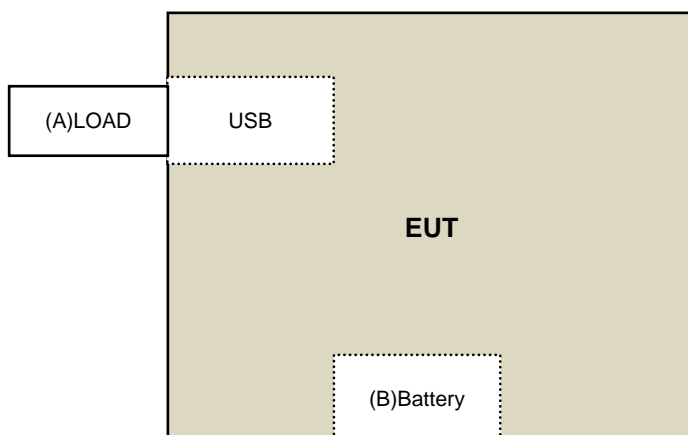

3.8 Configuration of Peripheral Devices and Cable Connections

ID	Product	Brand	Model No.	Serial No.	FCC ID	Remarks
A	LOAD	N/A	N/A	N/A	N/A	Provided by Lab
B	Battery	Makita	BL1860B	N/A	N/A	Supplied by applicant

4 Test Instruments

The calibration interval of the all test instruments are 12 months and the calibrations are traceable to NML/ROC and NIST/USA.

4.1 RF Output Power

Description Manufacturer	Model No.	Serial No.	Calibrated Date	Calibrated Until
MIMO Powermeasurement Test set (4X4) KEYSIGHT	U2021XA	U2021XA_001	2021/6/16	2022/6/15
MXG Vector Signal Generator KEYSIGHT	N5182B	MY53052658	2022/5/9	2023/5/8
Power Meter Anritsu	ML2495A	1232003	2022/1/9	2023/1/8
Power Sensor Anritsu	MA2411B	1207333	2022/1/9	2023/1/8
Spectrum Analyzer R&S	FSV40	101544	2022/5/9	2023/5/8
		101042	2021/9/9	2022/9/8
Spectrum Analyzer KEYSIGHT	N9030A	MY54490260	2021/7/23	2022/7/22
Temperature & Humidity Chamber TERCHY	MHU-225AU	920409	2021/7/2	2022/7/1
True RMS Clamp Meter Fluke	325	31130711WS	2021/6/2	2022/6/1

Notes:

1. The test was performed in LK - Oven
2. Tested Date: 2022/5/23

4.2 Number of Hopping Frequency Used

Refer to section 4.1 to get information of the instruments.

4.3 Dwell Time on Each Channel

Refer to section 4.1 to get information of the instruments.

4.4 Hopping Channel Separation

Refer to section 4.1 to get information of the instruments.

4.5 20 dB Bandwidth

Refer to section 4.1 to get information of the instruments.

4.6 Conducted Out of Band Emissions

Refer to section 4.1 to get information of the instruments.

4.7 Unwanted Emissions below 1 GHz

Description Manufacturer	Model No.	Serial No.	Calibrated Date	Calibrated Until
* LOOP ANTENNA EMCI	LPA600	270	2021/9/2	2023/9/1
Bi_Log Antenna Schwarzbeck	VULB 9168	137	2021/10/27	2022/10/26
Pre_Amplifier EMCI	EMC001340	980269	2021/6/29	2022/6/28
Pre_Amplifier HP	8447D	2432A03504	2022/2/17	2023/2/16
RF Coaxial Cable Pacific	8D-FB	Cable-CH6-02	2021/7/13	2022/7/12
Software BVADT	Radiated_V8.7.08	N/A	N/A	N/A
Spectrum Analyzer R&S	FSV40	101544	2022/5/9	2023/5/8
Test Receiver Agilent	N9038A	MY51210129	2022/4/8	2023/4/7
		MY51210137	2021/6/16	2022/6/15
Tower ADT	AT100	0306	N/A	N/A
Turn Table ADT	TT100	0306	N/A	N/A

Notes:

- * The calibration interval of the above test instruments is 24 months and the calibrations are traceable to NML/ROC and NIST/USA
- The test was performed in Linkou 966 Chamber 6 (CH 6).
- Tested Date: 2022/5/13

4.8 Unwanted Emissions above 1 GHz

Description Manufacturer	Model No.	Serial No.	Calibrated Date	Calibrated Until
BandPass Filter MICRO-TRONICS	BRM17690	005	2021/5/28	2022/5/27
Boresight antenna tower fixture BV	BAF-02	6	N/A	N/A
Highpass filter Wainwright Instruments	WHK 3.1/18G-10SS	SN 8	2021/5/28	2022/5/27
Horn Antenna ETS-Lindgren	3117-PA	00215857	2021/11/14	2022/11/13
Horn Antenna EMCO	3115	00028257	2021/11/14	2022/11/13
		00027024	2021/11/14	2022/11/13
Horn Antenna Schwarzbeck	BBHA 9170	212	2021/10/13	2022/10/12
Notch filter MICRO-TRONICS	BRC50703-01	010	2021/5/28	2022/5/27
Pre_Amplifier EMCI	EMC0126545 EMC184045B	980076	2022/2/17	2023/2/16
		980235	2022/2/17	2023/2/16
Pre-amplifier HP	8449B	3008A01201	2022/2/17	2023/2/16
Pre-amplifier (18GHz-40GHz) EMCI	EMC184045B	980175	2021/9/4	2022/9/3
RF Coaxial Cable HUBER SUHNER	SF-102	Cable-CH6-01	2021/7/8	2022/7/7
RF Coaxial Cable EM	EM102-KMKM-3.5+1M	EM102-KMKM-3.5+1M-01	2021/7/8	2022/7/7
RF Coaxial Cable WOKEN	WC01	Cable-CH10-03	2021/7/8	2022/7/7
RF Coaxial Cable Rosnol	K1K50-UP0279-K1K50-3000	Cable-CH10(3m)-04	2021/7/8	2022/7/7
Software BVADT	Radiated_V8.7.08	N/A	N/A	N/A
Spectrum Analyzer Agilent	E4446A	MY51100009	2021/6/29	2022/6/28
Spectrum Analyzer KEYSIGHT	N9030A	MY54490260	2021/7/23	2022/7/22
Spectrum Analyzer R&S	FSV40	101544	2022/5/9	2023/5/8
		101042	2021/9/9	2022/9/8
Test Receiver Agilent	N9038A	MY51210129	2022/4/8	2023/4/7
		MY51210137	2021/6/16	2022/6/15
Tower ADT	AT100	0306	N/A	N/A
Turn Table ADT	TT100	0306	N/A	N/A

Notes:

1. The test was performed in Linkou 966 Chamber 6 (CH 6).
2. Tested Date: 2022/5/12

5 Limits of Test Items

5.1 RF Output Power

The Maximum Output Power Measurement is 125 mW (21 dBm).

5.2 Number of Hopping Frequency Used

At least 15 channels frequencies, and should be equally spaced.

5.3 Dwell Time on Each Channel

The average time of occupancy on any channel shall not be greater than 0.4 seconds within a period of 0.4 seconds multiplied by the number of hopping channels employed.

5.4 Hopping Channel Separation

At least 25 kHz or two-third of 20 dB hopping channel bandwidth (whichever is greater).

5.5 20 dB Bandwidth

Maximum bandwidth is not specified.

5.6 Conducted Out of Band Emissions

Below 20 dB of the highest emission level of operating band (in 100 kHz Resolution Bandwidth).

5.7 Unwanted Emissions below 1 GHz

Radiated emissions up to 1 GHz which fall in the restricted bands must comply with the radiated emission limits specified as below table. Other emissions shall be at least 20 dB below the highest level of the desired power:

Frequencies (MHz)	Field Strength (microvolts/meter)	Measurement Distance (meters)
0.009 ~ 0.490	2400/F(kHz)	300
0.490 ~ 1.705	24000/F(kHz)	30
1.705 ~ 30.0	30	30
30 ~ 88	100	3
88 ~ 216	150	3
216 ~ 960	200	3
Above 960	500	3

Notes:

1. The lower limit shall apply at the transition frequencies.
2. Emission level (dBuV/m) = 20 log Emission level (uV/m).

5.8 Unwanted Emissions above 1 GHz

Radiated emissions above 1 GHz which fall in the restricted bands must comply with the radiated emission limits specified as below table. Other emissions shall be at least 20 dB below the highest level of the desired power:

Frequencies (MHz)	Field Strength (microvolts/meter)	Measurement Distance (meters)
Above 960	500	3

Notes:

1. The lower limit shall apply at the transition frequencies.
2. Emission level (dBuV/m) = 20 log Emission level (uV/m).
3. For frequencies above 1000 MHz, the field strength limits are based on average detector, however, the peak field strength of any emission shall not exceed the maximum permitted average limits, specified above by more than 20 dB under any condition of modulation.

6 Test Arrangements

6.1 RF Output Power

6.1.1 Test Setup

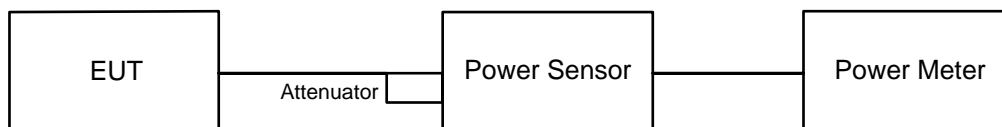

6.1.2 Test Procedure

Peak Power:

A peak power sensor was used on the output port of the EUT. A power meter was used to read the response of the peak power sensor. Record the power level.

Average Power:

Average power sensor was used to perform output power measurement, trigger and gating function of wide band power meter is enabled to measure max output power of TX on burst. Duty factor is not added to measured value.

6.2 Number of Hopping Frequency Used

6.2.1 Test Setup

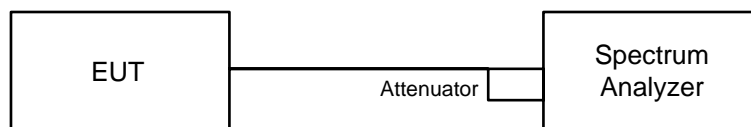

6.2.2 Test Procedure

- Check the calibration of the measuring instrument (SA) using either an internal calibrator or a known signal from an external generator.
- Turn on the EUT and connect its antenna terminal to measurement via a low loss cable. Then set it to any one measured frequency within its operating range and make sure the instrument is operated in its linear range.
- Set the SA on MaxHold Mode, and then keep the EUT in hopping mode. Record all the signals from each channel until each one has been recorded.
- Set the SA on View mode and then plot the result on SA screen.
- Repeat above procedures until all frequencies measured were complete.

6.3 Dwell Time on Each Channel

6.3.1 Test Setup

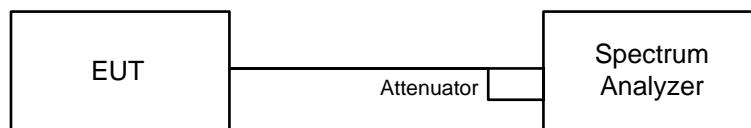

6.3.2 Test Procedure

- Check the calibration of the measuring instrument (SA) using either an internal calibrator or a known signal from an external generator.
- Turn on the EUT and connect its antenna terminal to measurement via a low loss cable. Then set it to any one measured frequency within its operating range and make sure the instrument is operated in its linear range.
- Adjust the center frequency of SA on any frequency be measured and set SA to zero span mode. And then, set RBW and VBW of spectrum analyzer to proper value.
- Measure the time duration of one transmission on the measured frequency. And then plot the result with time difference of this time duration.
- Repeat above procedures until all different time-slot modes have been completed.

6.4 Hopping Channel Separation

6.4.1 Test Setup

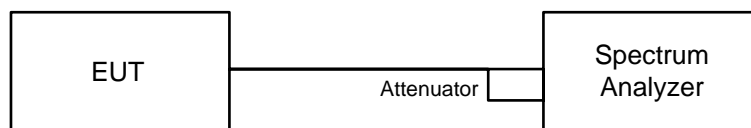

6.4.2 Test Procedure

- Check the calibration of the measuring instrument using either an internal calibrator or a known signal from an external generator.
- Turn on the EUT and connect it to measurement instrument. Then set it to any one convenient frequency within its operating range.
- By using the MaxHold function record the separation of two adjacent channels.
- Measure the frequency difference of these two adjacent channels by SA MARK function. And then plot the result on SA screen.
- Repeat above procedures until all frequencies measured were complete.

6.5 20 dB Bandwidth

6.5.1 Test Setup

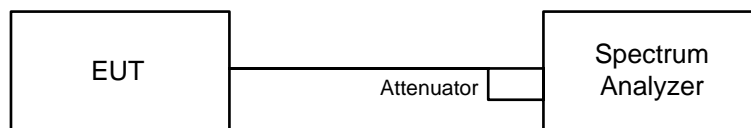

6.5.2 Test Procedure

- Check the calibration of the measuring instrument using either an internal calibrator or a known signal from an external generator.
- Turn on the EUT and connect it to measurement instrument. Then set it to any one convenient frequency within its operating range. Set a reference level on the measuring instrument equal to the highest peak value.
- Measure the frequency difference of two frequencies that were attenuated 20 dB from the reference level. Record the frequency difference as the emission bandwidth.
- Repeat above procedures until all frequencies measured were complete.

6.6 Conducted Out of Band Emissions

6.6.1 Test Setup

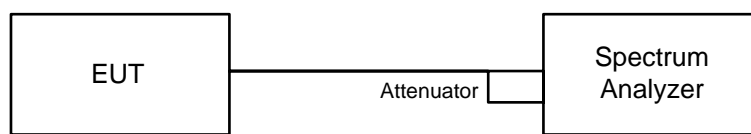

6.6.2 Test Procedure

MEASUREMENT PROCEDURE REF

- Set the RBW = 100 kHz.
- Set the VBW \geq 300 kHz.
- Detector = peak.
- Sweep time = auto couple.
- Trace mode = max hold.
- Allow trace to fully stabilize.
- Use the peak marker function to determine the maximum power level in any 100 kHz band segment within the fundamental EBW.

MEASUREMENT PROCEDURE OOB

- Set RBW = 100 kHz.
- Set VBW \geq 300 kHz.
- Detector = peak.
- Sweep = auto couple.
- Trace Mode = max hold.
- Allow trace to fully stabilize.
- Use the peak marker function to determine the maximum amplitude level.

6.7 Unwanted Emissions below 1 GHz

6.7.1 Test Setup

For Radiated emission below 30 MHz

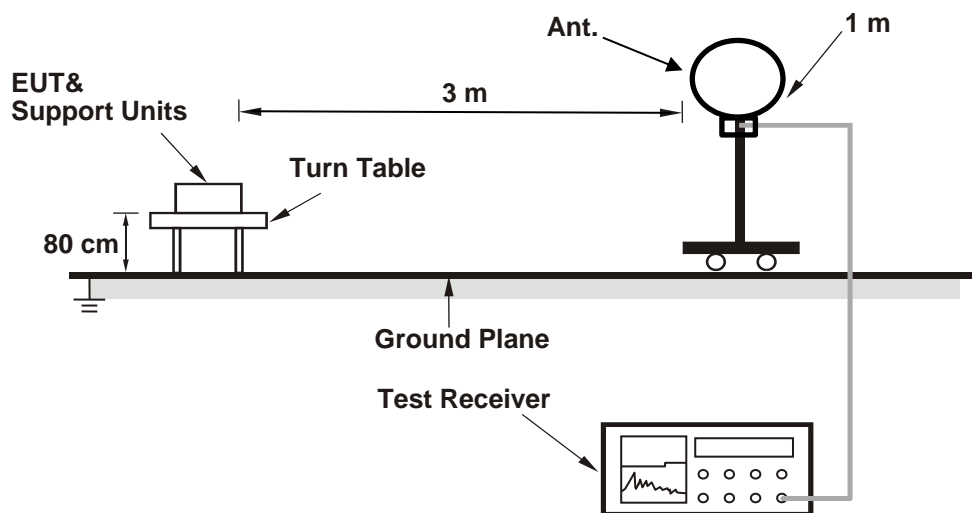

For Radiated emission above 30 MHz

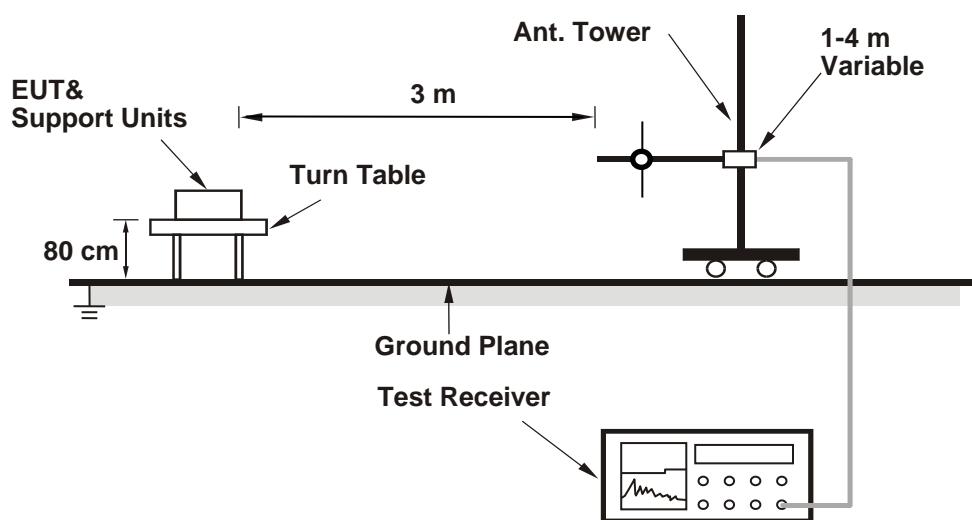

6.7.2 Test Procedure

For Radiated emission below 30 MHz

- a. The EUT was placed on the top of a rotating table 0.8 meters above the ground at 3 meter chamber room for test. The table was rotated 360 degrees to determine the position of the highest radiation.
- b. The EUT was set 3 meters away from the interference-receiving antenna, which was mounted on the top of a variable-height antenna tower.
- c. Parallel, perpendicular, and ground-parallel orientations of the antenna are set to make the measurement.
- d. For each suspected emission, the EUT was arranged to its worst case and the rotatable table was turned from 0 degrees to 360 degrees to find the maximum reading.
- e. The test-receiver system was set to Quasi-Peak Detect Function and Specified Bandwidth with Maximum Hold Mode.

Notes:

1. The resolution bandwidth and video bandwidth of test receiver/spectrum analyzer is 9 kHz at frequency below 30 MHz.
2. All modes of operation were investigated and the worst-case emissions are reported.

For Radiated emission above 30 MHz

- a. The EUT was placed on the top of a rotating table 0.8 meters above the ground at 3 meter chamber room for test. The table was rotated 360 degrees to determine the position of the highest radiation.
- b. The EUT was set 3 meters away from the interference-receiving antenna, which was mounted on the top of a variable-height antenna tower.
- c. The height of antenna is varied from one meter to four meters above the ground to determine the maximum value of the field strength. Both horizontal and vertical polarizations of the antenna are set to make the measurement.
- d. For each suspected emission, the EUT was arranged to its worst case and then the antenna was tuned to heights from 1 meter to 4 meters and the rotatable table was turned from 0 degrees to 360 degrees to find the maximum reading.
- e. The test-receiver system was set to quasi-peak detect function and specified bandwidth with maximum hold mode when the test frequency is below 1 GHz.

Notes:

1. The resolution bandwidth and video bandwidth of test receiver/spectrum analyzer is 120 kHz for Quasi-peak detection (QP) at frequency below 1 GHz.
2. All modes of operation were investigated and the worst-case emissions are reported.

6.8 Unwanted Emissions above 1 GHz

6.8.1 Test Setup

For Radiated emission above 1 GHz

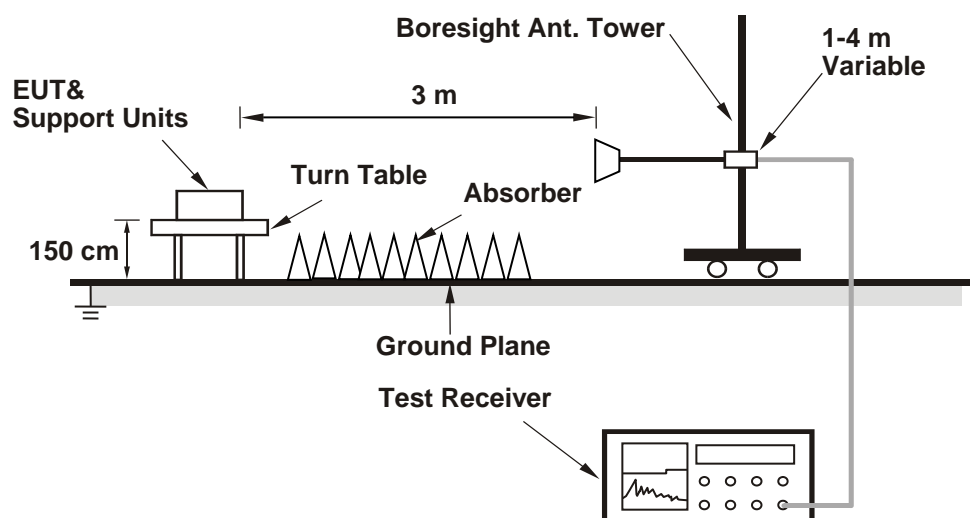

For the actual test configuration, please refer to the attached file (Test Setup Photo).

6.8.2 Test Procedure

- The EUT was placed on the top of a rotating table 1.5 meters above the ground at 3 meter chamber room for test. The table was rotated 360 degrees to determine the position of the highest radiation.
- The EUT was set 3 meters away from the interference-receiving antenna, which was mounted on the top of a variable-height antenna tower.
- The height of antenna is varied from one meter to four meters above the ground to determine the maximum value of the field strength. Both horizontal and vertical polarizations of the antenna are set to make the measurement.
- For each suspected emission, the EUT was arranged to its worst case and then the antenna was tuned to heights from 1 meter to 4 meters and the rotatable table was turned from 0 degrees to 360 degrees to find the maximum reading.
- The test-receiver system was set to peak and average detects function and specified bandwidth with maximum hold mode when the test frequency is above 1 GHz. If the peak reading value also meets average limit, measurement with the average detector is unnecessary.

Notes:

- The resolution bandwidth of test receiver/spectrum analyzer is 1 MHz and the video bandwidth is 3 MHz for Peak detection (PK) and Average detection (AV) at frequency above 1 GHz.
- All modes of operation were investigated and the worst-case emissions are reported.

7 Test Results of Test Item

7.1 RF Output Power

Input Power:	18 Vdc	Environmental Conditions:	25°C, 76% RH	Tested By:	Dalen Dai
--------------	--------	---------------------------	--------------	------------	-----------

For Peak Power

GFSK

Chan.	Chan. Freq. (MHz)	Peak Power (mW)	Peak Power (dBm)	Power Limit (dBm)	Test Result
0	2402	1.435	1.57	21	Pass
39	2441	1.486	1.72	21	Pass
78	2480	1.517	1.81	21	Pass

Note: The antenna gain is 1.927 dBi < 6 dBi, so the output power limit shall not be reduced.

8DPSK

Chan.	Chan. Freq. (MHz)	Peak Power (mW)	Peak Power (dBm)	Power Limit (dBm)	Test Result
0	2402	1.406	1.48	21	Pass
39	2441	1.435	1.57	21	Pass
78	2480	1.507	1.78	21	Pass

Note: The antenna gain is 1.927 dBi < 6 dBi, so the output power limit shall not be reduced.

For Average Power

GFSK

Chan.	Chan. Freq. (MHz)	Average Power (mW)	Average Power (dBm)
0	2402	1.371	1.37
39	2441	1.409	1.49
78	2480	1.455	1.63

8DPSK

Chan.	Chan. Freq. (MHz)	Average Power (mW)	Average Power (dBm)
0	2402	1.352	1.31
39	2441	1.380	1.40
78	2480	1.435	1.57



7.2 Number of Hopping Frequency Used

Input Power:	18 Vdc	Environmental Conditions:	25°C, 76% RH	Tested By:	Dalen Dai
--------------	--------	---------------------------	--------------	------------	-----------

GFSK

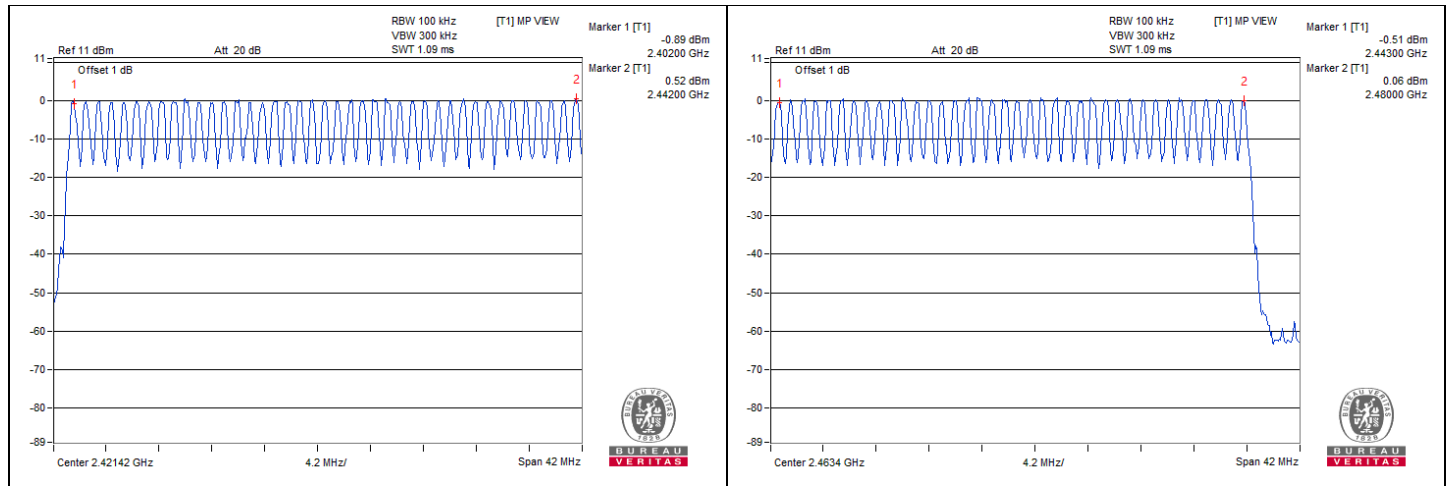

Note: There are 79 hopping frequencies in the hopping mode. On the plots, it shows that the hopping frequencies are equally spaced.

8DPSK

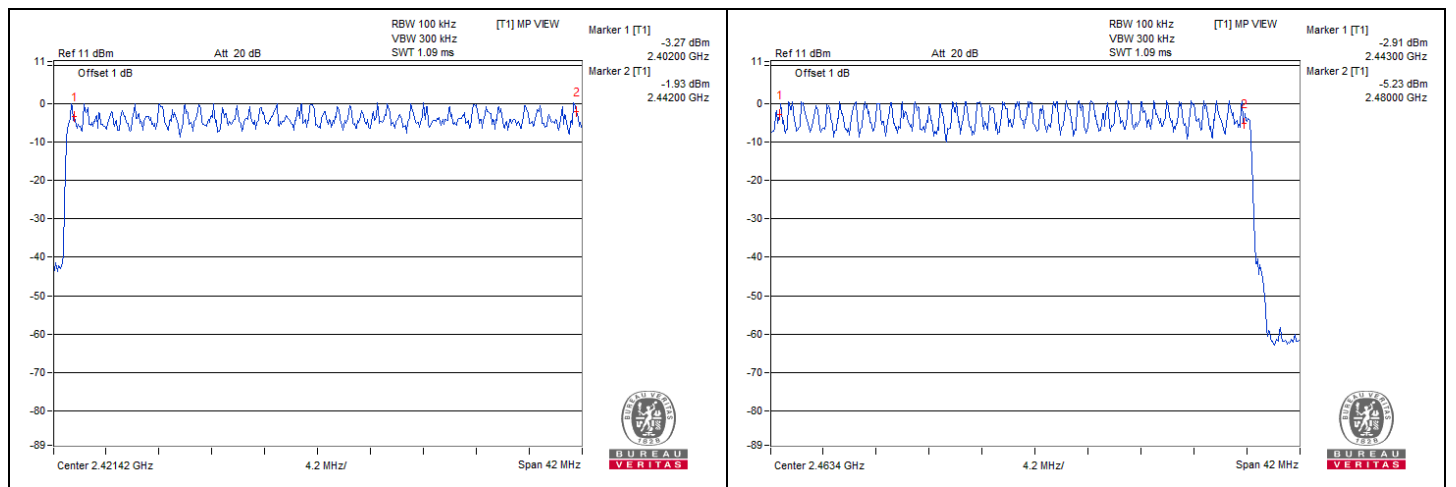

Note: There are 79 hopping frequencies in the hopping mode. On the plots, it shows that the hopping frequencies are equally spaced.



7.3 Dwell Time on Each Channel

Input Power:	18 Vdc	Environmental Conditions:	25°C, 76% RH	Tested By:	Dalen Dai
--------------	--------	---------------------------	--------------	------------	-----------

GFSK

Mode	Number of transmission in 31.6 sec	Length of transmission time (msec)	Result (msec)	Limit (msec)	Test Result
DH1	51 (times / 5 sec) * 6.32 = 323 times	0.456	147.29	400	Pass
DH3	25 (times / 5 sec) * 6.32 = 158 times	1.73	273.34	400	Pass
DH5	18 (times / 5 sec) * 6.32 = 114 times	3.072	350.21	400	Pass

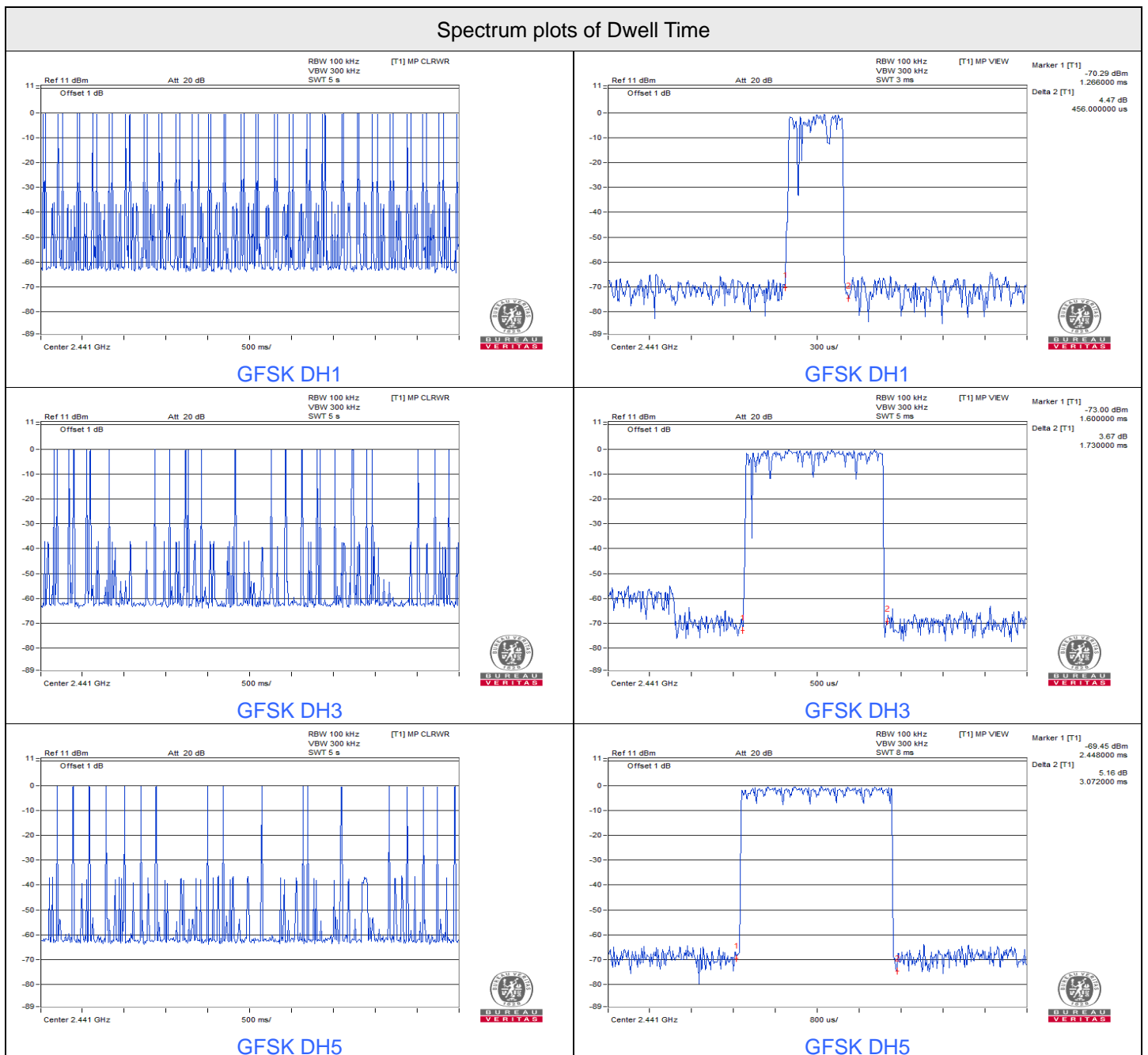

8DPSK

Mode	Number of transmission in 31.6 sec	Length of transmission time (msec)	Result (msec)	Limit (msec)	Test Result
3DH1	50 (times / 5 sec) * 6.32 = 316 times	0.432	136.51	400	Pass
3DH3	27 (times / 5 sec) * 6.32 = 171 times	1.74	297.54	400	Pass
3DH5	17 (times / 5 sec) * 6.32 = 108 times	2.976	321.41	400	Pass

Spectrum plots of Dwell Time



7.4 Hopping Channel Separation

Input Power:	18 Vdc	Environmental Conditions:	25°C, 76% RH	Tested By:	Dalen Dai
--------------	--------	---------------------------	--------------	------------	-----------

GFSK

Channel	Frequency (MHz)	Hopping Channel Separation (MHz)	Minimum Limit (MHz)	Test Result
0	2402	1	0.63	Pass
39	2441	1	0.64	Pass
78	2480	1	0.63	Pass

Note: The minimum limit is two-third 20dB bandwidth.

8DPSK

Channel	Frequency (MHz)	Hopping Channel Separation (MHz)	Minimum Limit (MHz)	Test Result
0	2402	1	0.84	Pass
39	2441	1	0.84	Pass
78	2480	1	0.85	Pass

Note: The minimum limit is two-third 20dB bandwidth.

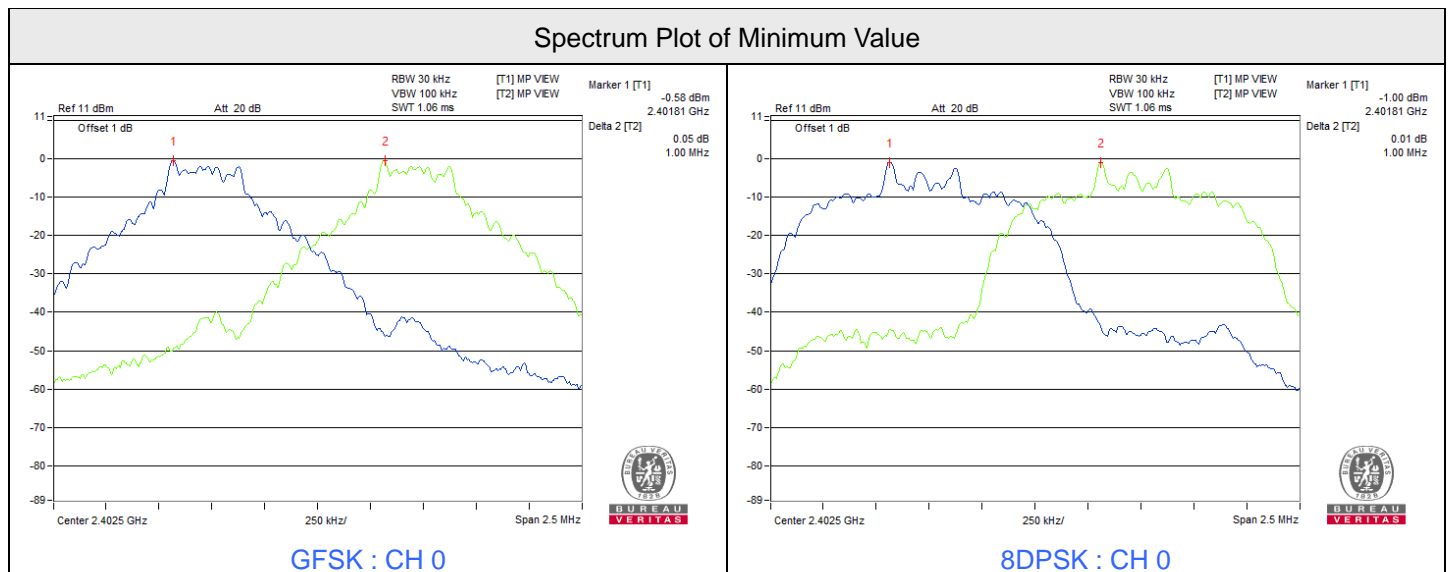

7.5 20 dB Bandwidth

Input Power:	18 Vdc	Environmental Conditions:	25°C, 76% RH	Tested By:	Dalen Dai
--------------	--------	---------------------------	--------------	------------	-----------

GFSK

Channel	Frequency (MHz)	20dB Bandwidth (MHz)
0	2402	0.94
39	2441	0.95
78	2480	0.94

8DPSK

Channel	Frequency (MHz)	20dB Bandwidth (MHz)
0	2402	1.26
39	2441	1.26
78	2480	1.27

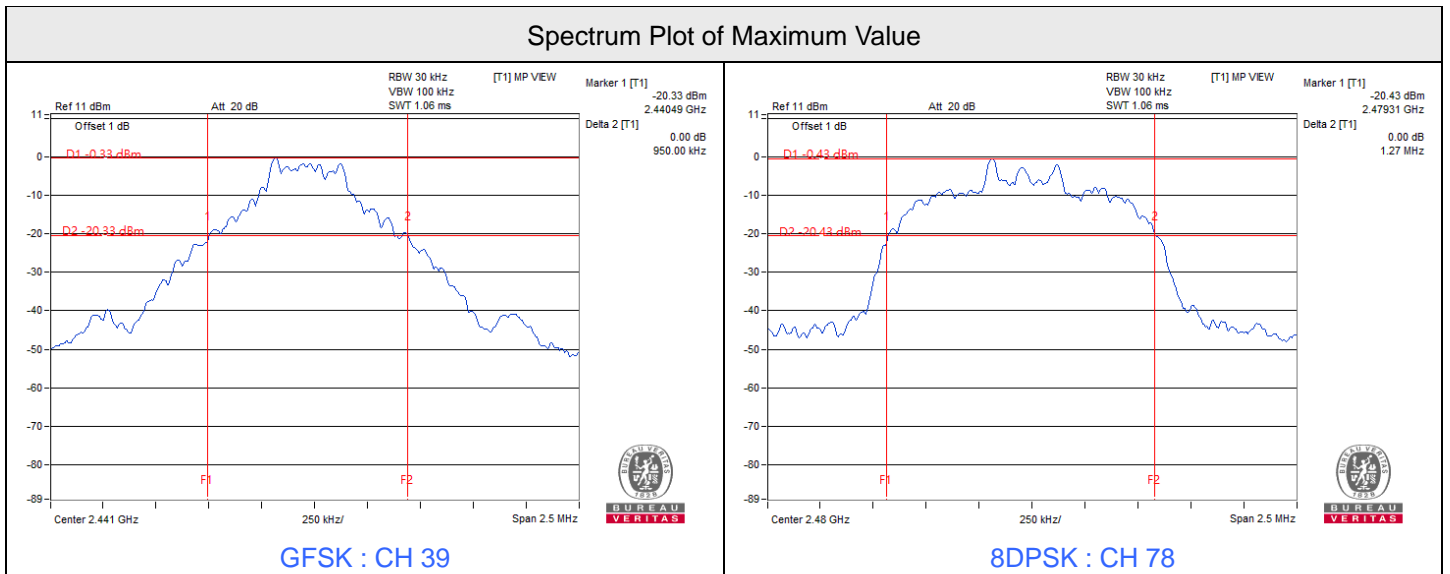



7.6 Conducted Out of Band Emissions

Input Power:	18 Vdc	Environmental Conditions:	25°C, 76% RH	Tested By:	Dalen Dai
--------------	--------	---------------------------	--------------	------------	-----------

GFSK





8DPSK

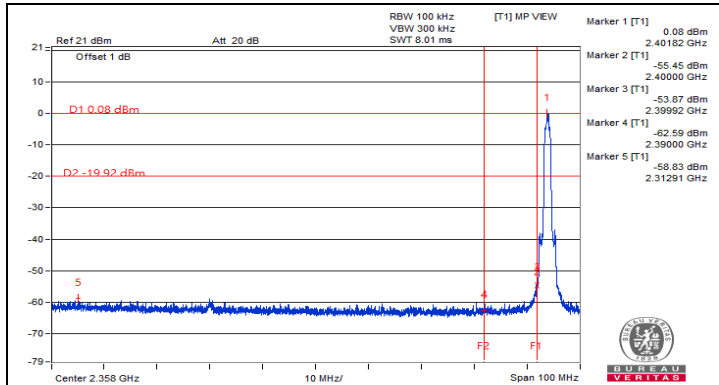

Hopping disabled (Low Channel)

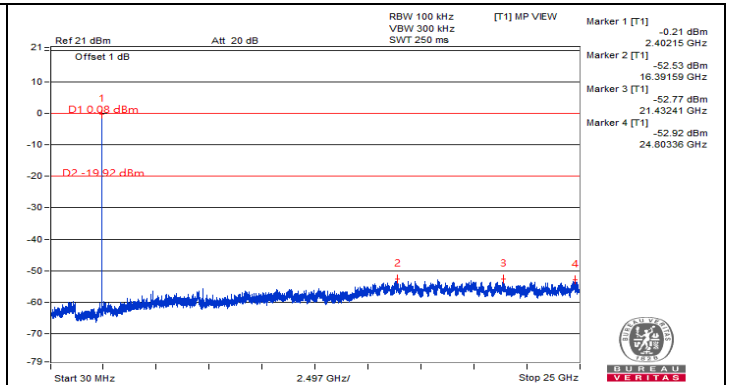

Hopping disabled (Low Channel)

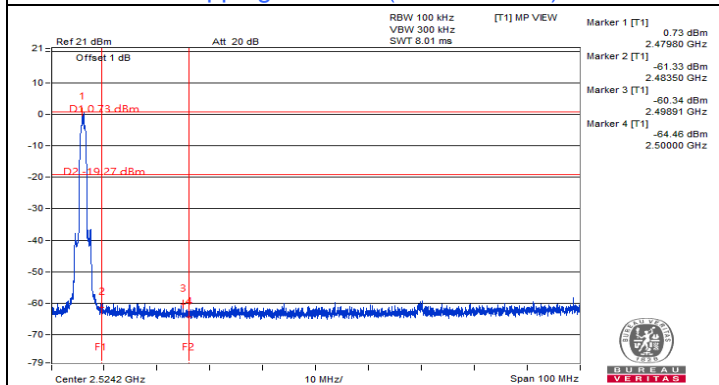

Hopping disabled (High Channel)

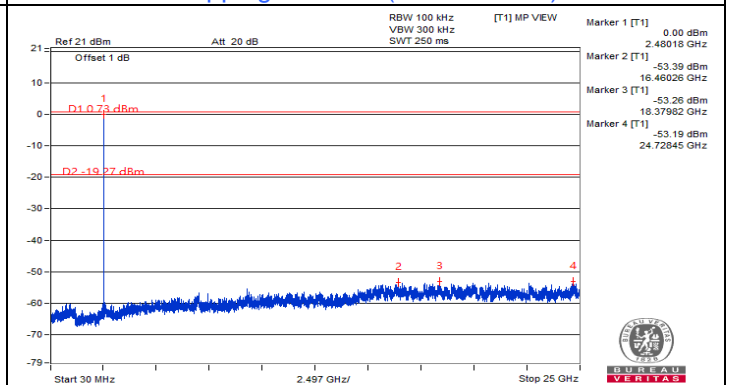

Hopping disabled (High Channel)

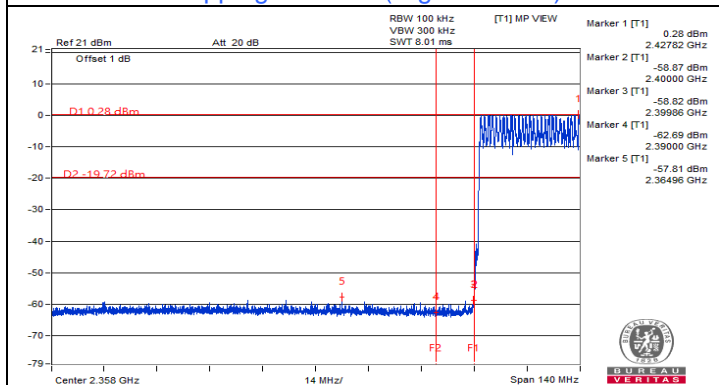

Hopping enabled (Low Channel)

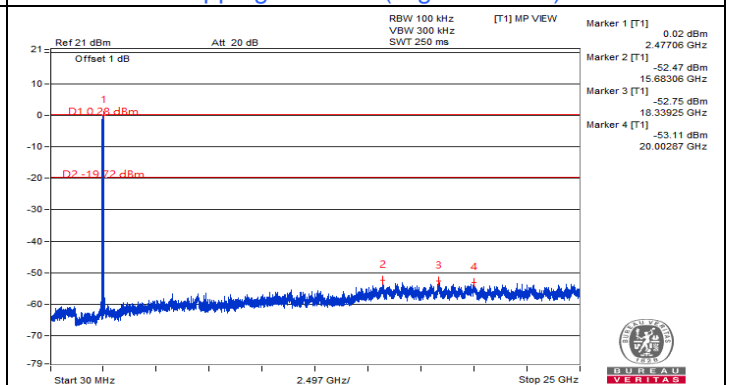

Hopping enabled (Low Channel)

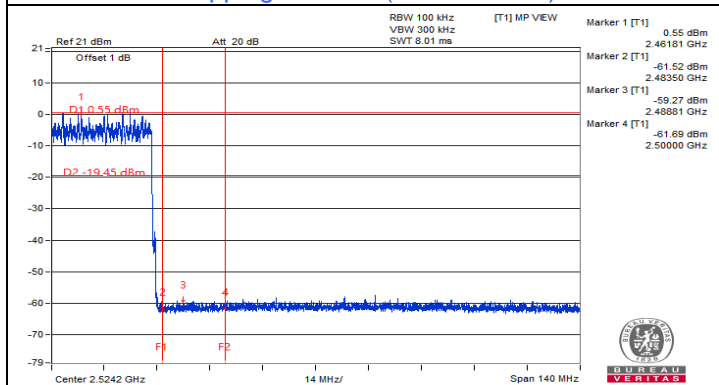

Hopping enabled (High Channel)

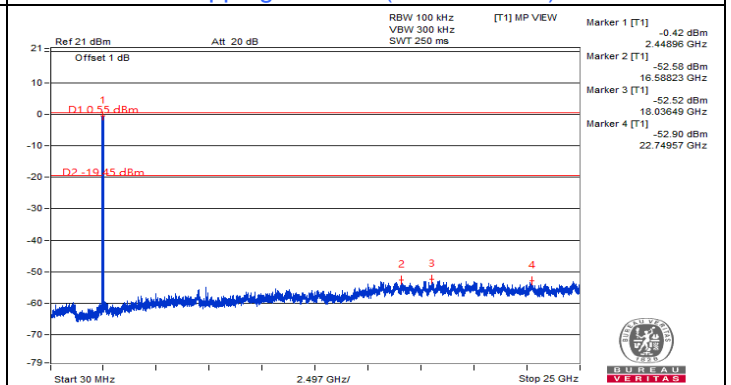

Hopping enabled (High Channel)

7.7 Unwanted Emissions below 1 GHz

RF Mode	TX BT GFSK	Channel	CH 78 : 2480 MHz
Frequency Range	9 kHz ~ 1 GHz	Detector Function & Bandwidth	(QP) RB = 120kHz
Input Power	18 Vdc	Environmental Conditions	22°C, 60% RH
Tested By	Jed Wu		

Antenna Polarity & Test Distance : Horizontal at 3 m								
No	Frequency (MHz)	Emission Level (dBuV/m)	Limit (dBuV/m)	Margin (dB)	Antenna Height (m)	Table Angle (Degree)	Raw Value (dBuV)	Correction Factor (dB/m)
1	42.80	18.7 QP	40.0	-21.3	1.05 H	97	27.6	-8.9
2	191.99	21.0 QP	43.5	-22.5	1.48 H	276	31.3	-10.3
3	224.00	21.8 QP	46.0	-24.2	1.53 H	295	32.1	-10.3
4	256.01	23.4 QP	46.0	-22.6	1.73 H	104	31.1	-7.7
5	319.98	25.3 QP	46.0	-20.7	1.96 H	7	30.4	-5.1
6	389.09	24.6 QP	46.0	-21.4	1.22 H	360	28.4	-3.8

Remarks:

1. Emission Level(dBuV/m) = Raw Value(dBuV) + Correction Factor(dB/m)
2. Correction Factor(dB/m) = Antenna Factor(dB/m) + Cable Factor(dB) – Pre-Amplifier Factor(dB)
3. Margin value = Emission Level – Limit value
4. The other emission levels were very low against the limit of frequency range 30 MHz ~ 1 GHz.
5. The emission levels were very low against the limit of frequency range 9 kHz ~ 30 MHz: the amplitude of spurious emissions attenuated more than 20 dB below the permissible value to be report.

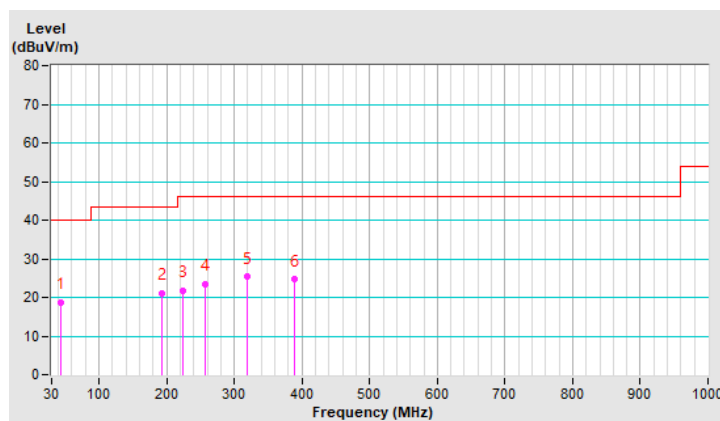

RF Mode	TX BT GFSK	Channel	CH 78 : 2480 MHz
Frequency Range	9 kHz ~ 1 GHz	Detector Function & Bandwidth	(QP) RB = 120kHz
Input Power	18 Vdc	Environmental Conditions	22°C, 60% RH
Tested By	Jed Wu		

Antenna Polarity & Test Distance : Vertical at 3 m								
No	Frequency (MHz)	Emission Level (dBuV/m)	Limit (dBuV/m)	Margin (dB)	Antenna Height (m)	Table Angle (Degree)	Raw Value (dBuV)	Correction Factor (dB/m)
1	30.58	21.3 QP	40.0	-18.7	1.35 V	131	31.7	-10.4
2	159.98	23.7 QP	43.5	-19.8	1.46 V	359	31.6	-7.9
3	208.00	25.9 QP	43.5	-17.6	1.87 V	22	36.2	-10.3
4	256.01	23.5 QP	46.0	-22.5	1.96 V	337	31.2	-7.7
5	335.99	25.8 QP	46.0	-20.2	1.22 V	99	30.7	-4.9
6	383.56	24.4 QP	46.0	-21.6	1.08 V	199	28.4	-4.0

Remarks:

1. Emission Level(dBuV/m) = Raw Value(dBuV) + Correction Factor(dB/m)
2. Correction Factor(dB/m) = Antenna Factor(dB/m) + Cable Factor(dB) – Pre-Amplifier Factor(dB)
3. Margin value = Emission Level – Limit value
4. The other emission levels were very low against the limit of frequency range 30 MHz ~ 1 GHz.
5. The emission levels were very low against the limit of frequency range 9 kHz ~ 30 MHz: the amplitude of spurious emissions attenuated more than 20 dB below the permissible value to be report.

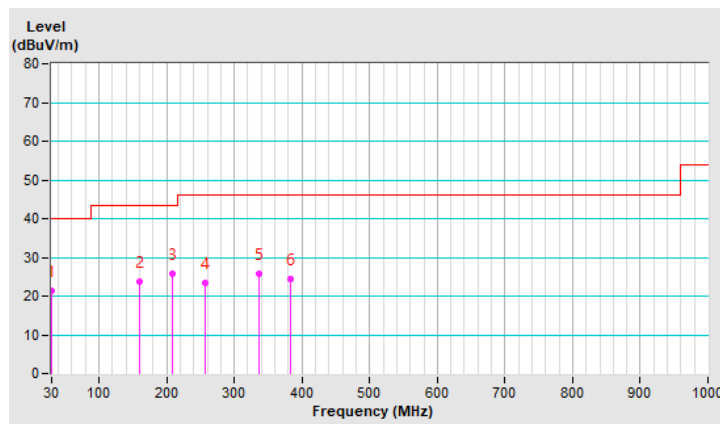

7.8 Unwanted Emissions above 1 GHz

RF Mode	TX BT GFSK	Channel	CH 0 : 2402 MHz
Frequency Range	1 GHz ~ 25 GHz	Detector Function & Bandwidth	(PK) RB = 1 MHz, VB = 3 MHz (AV) RB = 1 MHz, VB = 3 MHz (RMS)
Input Power	18 Vdc	Environmental Conditions	22°C, 60% RH
Tested By	Jed Wu		

Antenna Polarity & Test Distance : Horizontal at 3 m								
No	Frequency (MHz)	Emission Level (dBuV/m)	Limit (dBuV/m)	Margin (dB)	Antenna Height (m)	Table Angle (Degree)	Raw Value (dBuV)	Correction Factor (dB/m)
1	2390.00	51.3 PK	74.0	-22.7	1.06 H	260	53.6	-2.3
2	2390.00	40.0 AV	54.0	-14.0	1.06 H	260	42.3	-2.3
3	*2402.00	96.8 PK			1.06 H	260	99.1	-2.3
4	*2402.00	66.0 AV			1.06 H	260	68.3	-2.3
5	4804.00	47.6 PK	74.0	-26.4	3.11 H	192	42.1	5.5
6	4804.00	16.8 AV	54.0	-37.2	3.11 H	192	11.3	5.5

Remarks:

- Emission Level(dBuV/m) = Raw Value(dBuV) + Correction Factor(dB/m)
- Correction Factor(dB/m) = Antenna Factor(dB/m) + Cable Factor(dB) – Pre-Amplifier Factor(dB)
- Margin value = Emission Level – Limit value
- The other emission levels were very low against the limit.
- " * " : Fundamental frequency.
- The average value of fundamental and harmonic frequency is: Average = Peak value + 20 log(Duty cycle) Where the duty cycle correction factor is calculated from following formula:
 $20 \log(\text{Duty cycle}) = 20 \log(2.889 \text{ ms} / 100 \text{ ms}) = -30.8 \text{ dB}$

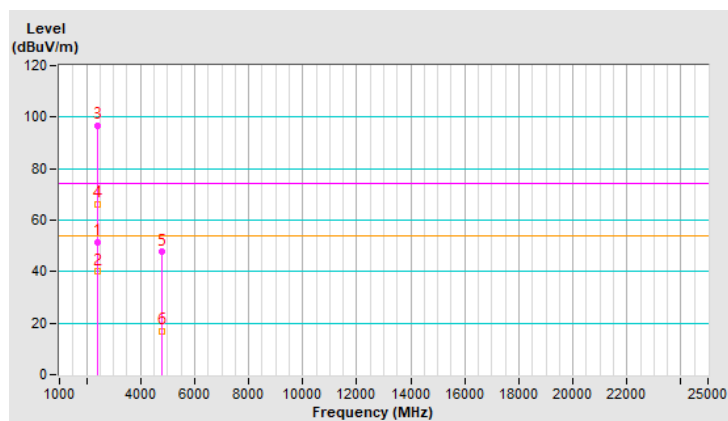

RF Mode	TX BT GFSK	Channel	CH 0 : 2402 MHz
Frequency Range	1 GHz ~ 25 GHz	Detector Function & Bandwidth	(PK) RB = 1 MHz, VB = 3 MHz (AV) RB = 1 MHz, VB = 3 MHz (RMS)
Input Power	18 Vdc	Environmental Conditions	22°C, 60% RH
Tested By	Jed Wu		

Antenna Polarity & Test Distance : Vertical at 3 m								
No	Frequency (MHz)	Emission Level (dBuV/m)	Limit (dBuV/m)	Margin (dB)	Antenna Height (m)	Table Angle (Degree)	Raw Value (dBuV)	Correction Factor (dB/m)
1	2390.00	52.2 PK	74.0	-21.8	1.48 V	204	54.5	-2.3
2	2390.00	41.2 AV	54.0	-12.8	1.48 V	204	43.5	-2.3
3	*2402.00	98.9 PK			1.48 V	204	101.2	-2.3
4	*2402.00	68.1 AV			1.48 V	204	70.4	-2.3
5	4804.00	48.0 PK	74.0	-26.0	1.51 V	48	42.5	5.5
6	4804.00	17.2 AV	54.0	-36.8	1.51 V	48	11.7	5.5

Remarks:

1. Emission Level(dBuV/m) = Raw Value(dBuV) + Correction Factor(dB/m)
2. Correction Factor(dB/m) = Antenna Factor(dB/m) + Cable Factor(dB) – Pre-Amplifier Factor(dB)
3. Margin value = Emission Level – Limit value
4. The other emission levels were very low against the limit.
5. " * " : Fundamental frequency.
6. The average value of fundamental and harmonic frequency is: Average = Peak value + 20 log(Duty cycle) Where the duty cycle correction factor is calculated from following formula:
 $20 \log(\text{Duty cycle}) = 20 \log(2.889 \text{ ms} / 100 \text{ ms}) = -30.8 \text{ dB}$

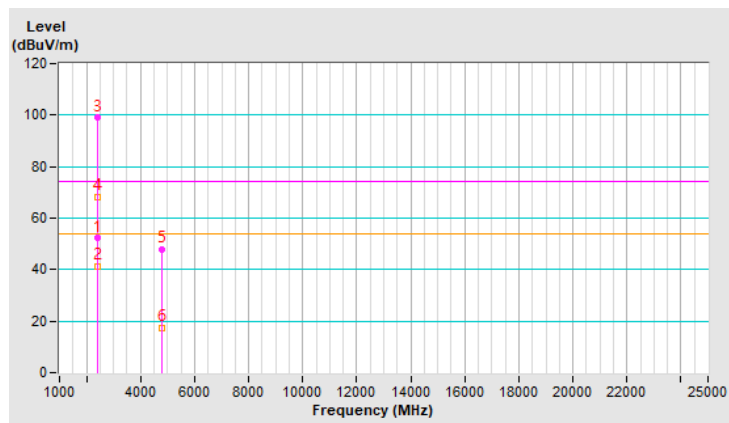

RF Mode	TX BT GFSK	Channel	CH 39 : 2441 MHz
Frequency Range	1 GHz ~ 25 GHz	Detector Function & Bandwidth	(PK) RB = 1 MHz, VB = 3 MHz (AV) RB = 1 MHz, VB = 3 MHz (RMS)
Input Power	18 Vdc	Environmental Conditions	22°C, 60% RH
Tested By	Jed Wu		

Antenna Polarity & Test Distance : Horizontal at 3 m

No	Frequency (MHz)	Emission Level (dBuV/m)	Limit (dBuV/m)	Margin (dB)	Antenna Height (m)	Table Angle (Degree)	Raw Value (dBuV)	Correction Factor (dB/m)
1	*2441.00	96.2 PK			1.04 H	265	98.4	-2.2
2	*2441.00	65.4 AV			1.04 H	265	67.6	-2.2
3	4882.00	47.1 PK	74.0	-26.9	3.03 H	189	41.5	5.6
4	4882.00	16.3 AV	54.0	-37.7	3.03 H	189	10.7	5.6

Remarks:

1. Emission Level(dBuV/m) = Raw Value(dBuV) + Correction Factor(dB/m)
2. Correction Factor(dB/m) = Antenna Factor(dB/m) + Cable Factor(dB) – Pre-Amplifier Factor(dB)
3. Margin value = Emission Level – Limit value
4. The other emission levels were very low against the limit.
5. " * " : Fundamental frequency.
6. The average value of fundamental and harmonic frequency is: Average = Peak value + 20 log(Duty cycle) Where the duty cycle correction factor is calculated from following formula:
 $20 \log(\text{Duty cycle}) = 20 \log(2.889 \text{ ms} / 100 \text{ ms}) = -30.8 \text{ dB}$

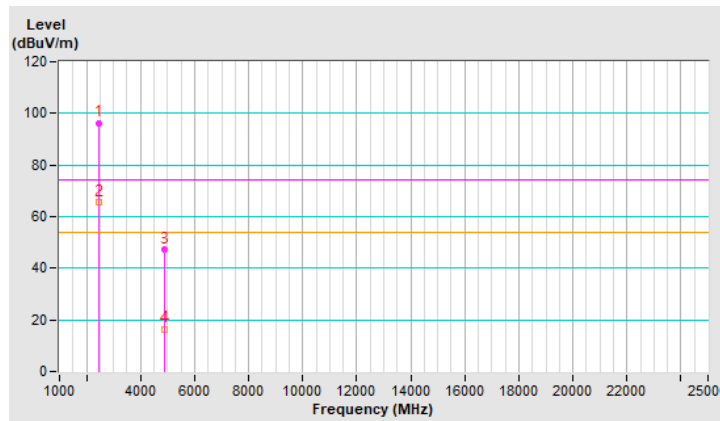

RF Mode	TX BT GFSK	Channel	CH 39 : 2441 MHz
Frequency Range	1 GHz ~ 25 GHz	Detector Function & Bandwidth	(PK) RB = 1 MHz, VB = 3 MHz (AV) RB = 1 MHz, VB = 3 MHz (RMS)
Input Power	18 Vdc	Environmental Conditions	22°C, 60% RH
Tested By	Jed Wu		

Antenna Polarity & Test Distance : Vertical at 3 m								
No	Frequency (MHz)	Emission Level (dBuV/m)	Limit (dBuV/m)	Margin (dB)	Antenna Height (m)	Table Angle (Degree)	Raw Value (dBuV)	Correction Factor (dB/m)
1	*2441.00	98.0 PK			1.45 V	203	100.2	-2.2
2	*2441.00	67.2 AV			1.45 V	203	69.4	-2.2
3	4882.00	47.6 PK	74.0	-26.4	1.58 V	53	42.0	5.6
4	4882.00	16.8 AV	54.0	-37.2	1.58 V	53	11.2	5.6

Remarks:

1. Emission Level(dBuV/m) = Raw Value(dBuV) + Correction Factor(dB/m)
2. Correction Factor(dB/m) = Antenna Factor(dB/m) + Cable Factor(dB) – Pre-Amplifier Factor(dB)
3. Margin value = Emission Level – Limit value
4. The other emission levels were very low against the limit.
5. " * " : Fundamental frequency.
6. The average value of fundamental and harmonic frequency is: Average = Peak value + 20 log(Duty cycle) Where the duty cycle correction factor is calculated from following formula:
 $20 \log(\text{Duty cycle}) = 20 \log(2.889 \text{ ms} / 100 \text{ ms}) = -30.8 \text{ dB}$

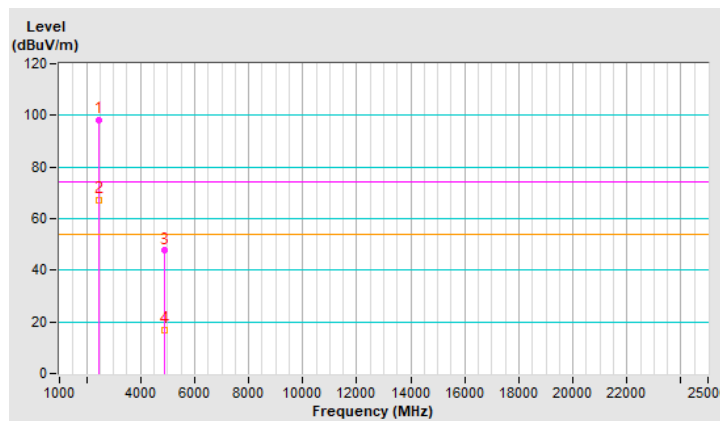

RF Mode	TX BT GFSK	Channel	CH 78 : 2480 MHz
Frequency Range	1 GHz ~ 25 GHz	Detector Function & Bandwidth	(PK) RB = 1 MHz, VB = 3 MHz (AV) RB = 1 MHz, VB = 3 MHz (RMS)
Input Power	18 Vdc	Environmental Conditions	22°C, 60% RH
Tested By	Jed Wu		

Antenna Polarity & Test Distance : Horizontal at 3 m								
No	Frequency (MHz)	Emission Level (dBuV/m)	Limit (dBuV/m)	Margin (dB)	Antenna Height (m)	Table Angle (Degree)	Raw Value (dBuV)	Correction Factor (dB/m)
1	*2480.00	96.1 PK			1.08 H	265	98.2	-2.1
2	*2480.00	65.3 AV			1.08 H	265	67.4	-2.1
3	2483.50	51.9 PK	74.0	-22.1	1.08 H	265	54.0	-2.1
4	2483.50	21.1 AV	54.0	-32.9	1.08 H	265	23.2	-2.1
5	4960.00	46.7 PK	74.0	-27.3	2.99 H	201	41.0	5.7
6	4960.00	15.9 AV	54.0	-38.1	2.99 H	201	10.2	5.7

Remarks:

1. Emission Level(dBuV/m) = Raw Value(dBuV) + Correction Factor(dB/m)
2. Correction Factor(dB/m) = Antenna Factor(dB/m) + Cable Factor(dB) – Pre-Amplifier Factor(dB)
3. Margin value = Emission Level – Limit value
4. The other emission levels were very low against the limit.
5. " * " : Fundamental frequency.
6. The average value of fundamental and harmonic frequency is: Average = Peak value + 20 log(Duty cycle) Where the duty cycle correction factor is calculated from following formula:
 $20 \log(\text{Duty cycle}) = 20 \log(2.889 \text{ ms} / 100 \text{ ms}) = -30.8 \text{ dB}$

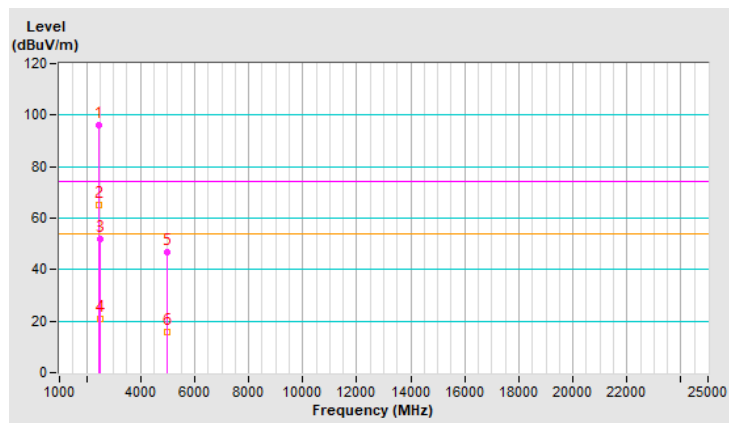

RF Mode	TX BT GFSK	Channel	CH 78 : 2480 MHz
Frequency Range	1 GHz ~ 25 GHz	Detector Function & Bandwidth	(PK) RB = 1 MHz, VB = 3 MHz (AV) RB = 1 MHz, VB = 3 MHz (RMS)
Input Power	18 Vdc	Environmental Conditions	22°C, 60% RH
Tested By	Jed Wu		

Antenna Polarity & Test Distance : Vertical at 3 m								
No	Frequency (MHz)	Emission Level (dBuV/m)	Limit (dBuV/m)	Margin (dB)	Antenna Height (m)	Table Angle (Degree)	Raw Value (dBuV)	Correction Factor (dB/m)
1	*2480.00	96.9 PK			1.29 V	213	99.0	-2.1
2	*2480.00	66.1 AV			1.29 V	213	68.2	-2.1
3	2483.50	51.9 PK	74.0	-22.1	1.29 V	213	54.0	-2.1
4	2483.50	21.1 AV	54.0	-32.9	1.29 V	213	23.2	-2.1
5	4960.00	47.3 PK	74.0	-26.7	1.53 V	39	41.6	5.7
6	4960.00	16.5 AV	54.0	-37.5	1.53 V	39	10.8	5.7

Remarks:

1. Emission Level(dBuV/m) = Raw Value(dBuV) + Correction Factor(dB/m)
2. Correction Factor(dB/m) = Antenna Factor(dB/m) + Cable Factor(dB) – Pre-Amplifier Factor(dB)
3. Margin value = Emission Level – Limit value
4. The other emission levels were very low against the limit.
5. " * " : Fundamental frequency.
6. The average value of fundamental and harmonic frequency is: Average = Peak value + 20 log(Duty cycle) Where the duty cycle correction factor is calculated from following formula:
 $20 \log(\text{Duty cycle}) = 20 \log(2.889 \text{ ms} / 100 \text{ ms}) = -30.8 \text{ dB}$

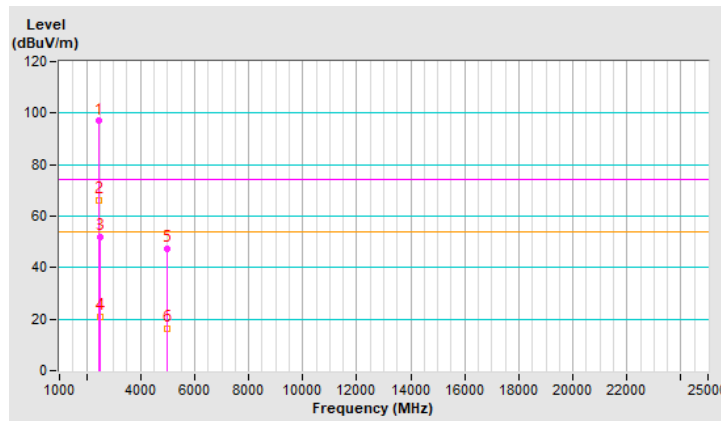

RF Mode	TX BT 8DPSK	Channel	CH 0 : 2402 MHz
Frequency Range	1 GHz ~ 25 GHz	Detector Function & Bandwidth	(PK) RB = 1 MHz, VB = 3 MHz (AV) RB = 1 MHz, VB = 3 MHz (RMS)
Input Power	18 Vdc	Environmental Conditions	22°C, 60% RH
Tested By	Jed Wu		

Antenna Polarity & Test Distance : Horizontal at 3 m								
No	Frequency (MHz)	Emission Level (dBuV/m)	Limit (dBuV/m)	Margin (dB)	Antenna Height (m)	Table Angle (Degree)	Raw Value (dBuV)	Correction Factor (dB/m)
1	2390.00	51.4 PK	74.0	-22.6	1.70 H	276	53.7	-2.3
2	2390.00	40.8 AV	54.0	-13.2	1.70 H	276	43.1	-2.3
3	*2402.00	96.3 PK			1.70 H	276	98.6	-2.3
4	*2402.00	65.5 AV			1.70 H	276	67.8	-2.3
5	4804.00	46.8 PK	74.0	-27.2	3.09 H	286	41.3	5.5
6	4804.00	16.0 AV	54.0	-38.0	3.09 H	286	10.5	5.5

Remarks:

1. Emission Level(dBuV/m) = Raw Value(dBuV) + Correction Factor(dB/m)
2. Correction Factor(dB/m) = Antenna Factor(dB/m) + Cable Factor(dB) – Pre-Amplifier Factor(dB)
3. Margin value = Emission Level – Limit value
4. The other emission levels were very low against the limit.
5. " * " : Fundamental frequency.
6. The average value of fundamental and harmonic frequency is: Average = Peak value + 20 log(Duty cycle) Where the duty cycle correction factor is calculated from following formula:
 $20 \log(\text{Duty cycle}) = 20 \log(2.889 \text{ ms} / 100 \text{ ms}) = -30.8 \text{ dB}$

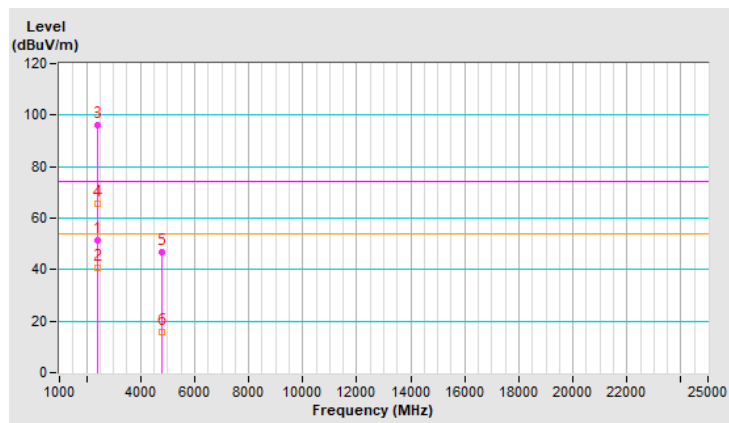

RF Mode	TX BT 8DPSK	Channel	CH 0 : 2402 MHz
Frequency Range	1 GHz ~ 25 GHz	Detector Function & Bandwidth	(PK) RB = 1 MHz, VB = 3 MHz (AV) RB = 1 MHz, VB = 3 MHz (RMS)
Input Power	18 Vdc	Environmental Conditions	22°C, 60% RH
Tested By	Jed Wu		

Antenna Polarity & Test Distance : Vertical at 3 m								
No	Frequency (MHz)	Emission Level (dBuV/m)	Limit (dBuV/m)	Margin (dB)	Antenna Height (m)	Table Angle (Degree)	Raw Value (dBuV)	Correction Factor (dB/m)
1	2390.00	52.0 PK	74.0	-22.0	1.00 V	213	54.3	-2.3
2	2390.00	41.3 AV	54.0	-12.7	1.00 V	213	43.6	-2.3
3	*2402.00	98.7 PK			1.00 V	213	101.0	-2.3
4	*2402.00	67.9 AV			1.00 V	213	70.2	-2.3
5	4804.00	47.3 PK	74.0	-26.7	1.51 V	157	41.8	5.5
6	4804.00	16.5 AV	54.0	-37.5	1.51 V	157	11.0	5.5

Remarks:

1. Emission Level(dBuV/m) = Raw Value(dBuV) + Correction Factor(dB/m)
2. Correction Factor(dB/m) = Antenna Factor(dB/m) + Cable Factor(dB) – Pre-Amplifier Factor(dB)
3. Margin value = Emission Level – Limit value
4. The other emission levels were very low against the limit.
5. " * " : Fundamental frequency.
6. The average value of fundamental and harmonic frequency is: Average = Peak value + 20 log(Duty cycle) Where the duty cycle correction factor is calculated from following formula:
 $20 \log(\text{Duty cycle}) = 20 \log(2.889 \text{ ms} / 100 \text{ ms}) = -30.8 \text{ dB}$

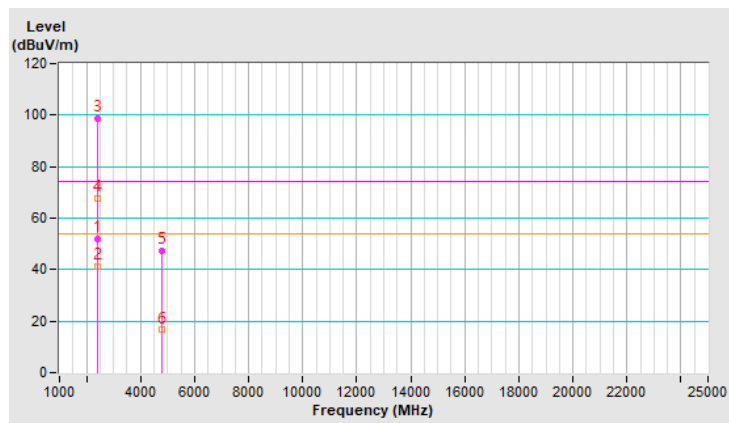

RF Mode	TX BT 8DPSK	Channel	CH 39 : 2441 MHz
Frequency Range	1 GHz ~ 25 GHz	Detector Function & Bandwidth	(PK) RB = 1 MHz, VB = 3 MHz (AV) RB = 1 MHz, VB = 3 MHz (RMS)
Input Power	18 Vdc	Environmental Conditions	22°C, 60% RH
Tested By	Jed Wu		

Antenna Polarity & Test Distance : Horizontal at 3 m								
No	Frequency (MHz)	Emission Level (dBuV/m)	Limit (dBuV/m)	Margin (dB)	Antenna Height (m)	Table Angle (Degree)	Raw Value (dBuV)	Correction Factor (dB/m)
1	*2441.00	96.5 PK			1.68 H	271	98.7	-2.2
2	*2441.00	65.7 AV			1.68 H	271	67.9	-2.2
3	4882.00	46.4 PK	74.0	-27.6	3.10 H	281	40.8	5.6
4	4882.00	15.6 AV	54.0	-38.4	3.10 H	281	10.0	5.6

Remarks:

1. Emission Level(dBuV/m) = Raw Value(dBuV) + Correction Factor(dB/m)
2. Correction Factor(dB/m) = Antenna Factor(dB/m) + Cable Factor(dB) – Pre-Amplifier Factor(dB)
3. Margin value = Emission Level – Limit value
4. The other emission levels were very low against the limit.
5. " * " : Fundamental frequency.
6. The average value of fundamental and harmonic frequency is: Average = Peak value + 20 log(Duty cycle) Where the duty cycle correction factor is calculated from following formula:
 $20 \log(\text{Duty cycle}) = 20 \log(2.889 \text{ ms} / 100 \text{ ms}) = -30.8 \text{ dB}$

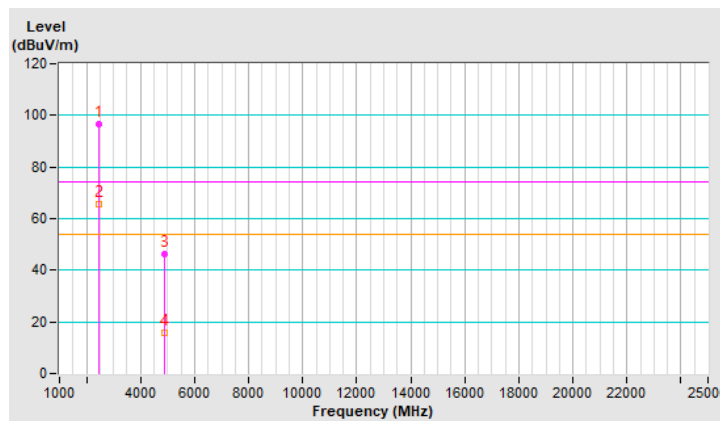

RF Mode	TX BT 8DPSK	Channel	CH 39 : 2441 MHz
Frequency Range	1 GHz ~ 25 GHz	Detector Function & Bandwidth	(PK) RB = 1 MHz, VB = 3 MHz (AV) RB = 1 MHz, VB = 3 MHz (RMS)
Input Power	18 Vdc	Environmental Conditions	22°C, 60% RH
Tested By	Jed Wu		

Antenna Polarity & Test Distance : Vertical at 3 m								
No	Frequency (MHz)	Emission Level (dBuV/m)	Limit (dBuV/m)	Margin (dB)	Antenna Height (m)	Table Angle (Degree)	Raw Value (dBuV)	Correction Factor (dB/m)
1	*2441.00	97.8 PK			1.45 V	202	100.0	-2.2
2	*2441.00	67.0 AV			1.45 V	202	69.2	-2.2
3	4882.00	47.1 PK	74.0	-26.9	1.52 V	159	41.5	5.6
4	4882.00	16.3 AV	54.0	-37.7	1.52 V	159	10.7	5.6

Remarks:

1. Emission Level(dBuV/m) = Raw Value(dBuV) + Correction Factor(dB/m)
2. Correction Factor(dB/m) = Antenna Factor(dB/m) + Cable Factor(dB) – Pre-Amplifier Factor(dB)
3. Margin value = Emission Level – Limit value
4. The other emission levels were very low against the limit.
5. " * " : Fundamental frequency.
6. The average value of fundamental and harmonic frequency is: Average = Peak value + 20 log(Duty cycle) Where the duty cycle correction factor is calculated from following formula:
 $20 \log(\text{Duty cycle}) = 20 \log(2.889 \text{ ms} / 100 \text{ ms}) = -30.8 \text{ dB}$

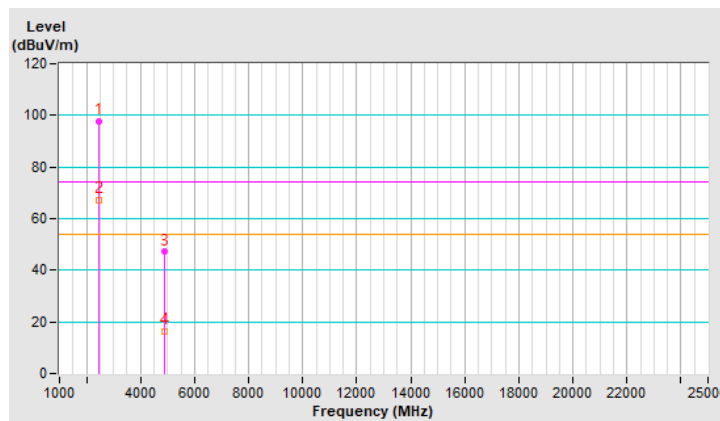

RF Mode	TX BT 8DPSK	Channel	CH 78 : 2480 MHz
Frequency Range	1 GHz ~ 25 GHz	Detector Function & Bandwidth	(PK) RB = 1 MHz, VB = 3 MHz (AV) RB = 1 MHz, VB = 3 MHz (RMS)
Input Power	18 Vdc	Environmental Conditions	22°C, 60% RH
Tested By	Jed Wu		

Antenna Polarity & Test Distance : Horizontal at 3 m								
No	Frequency (MHz)	Emission Level (dBuV/m)	Limit (dBuV/m)	Margin (dB)	Antenna Height (m)	Table Angle (Degree)	Raw Value (dBuV)	Correction Factor (dB/m)
1	*2480.00	96.6 PK			1.67 H	257	98.7	-2.1
2	*2480.00	65.8 AV			1.67 H	257	67.9	-2.1
3	2483.50	51.4 PK	74.0	-22.6	1.67 H	257	53.5	-2.1
4	2483.50	20.6 AV	54.0	-33.4	1.67 H	257	22.7	-2.1
5	4960.00	46.6 PK	74.0	-27.4	3.06 H	288	40.9	5.7
6	4960.00	15.8 AV	54.0	-38.2	3.06 H	288	10.1	5.7

Remarks:

1. Emission Level(dBuV/m) = Raw Value(dBuV) + Correction Factor(dB/m)
2. Correction Factor(dB/m) = Antenna Factor(dB/m) + Cable Factor(dB) – Pre-Amplifier Factor(dB)
3. Margin value = Emission Level – Limit value
4. The other emission levels were very low against the limit.
5. " * " : Fundamental frequency.
6. The average value of fundamental and harmonic frequency is: Average = Peak value + 20 log(Duty cycle) Where the duty cycle correction factor is calculated from following formula:
 $20 \log(\text{Duty cycle}) = 20 \log(2.889 \text{ ms} / 100 \text{ ms}) = -30.8 \text{ dB}$

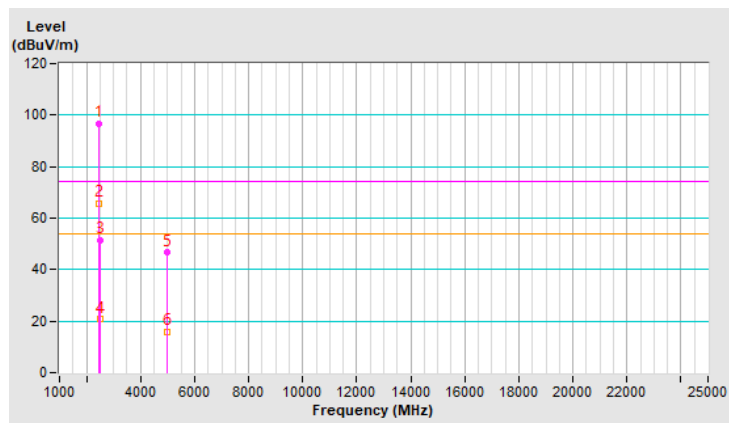

RF Mode	TX BT 8DPSK	Channel	CH 78 : 2480 MHz
Frequency Range	1 GHz ~ 25 GHz	Detector Function & Bandwidth	(PK) RB = 1 MHz, VB = 3 MHz (AV) RB = 1 MHz, VB = 3 MHz (RMS)
Input Power	18 Vdc	Environmental Conditions	22°C, 60% RH
Tested By	Jed Wu		

Antenna Polarity & Test Distance : Vertical at 3 m								
No	Frequency (MHz)	Emission Level (dBuV/m)	Limit (dBuV/m)	Margin (dB)	Antenna Height (m)	Table Angle (Degree)	Raw Value (dBuV)	Correction Factor (dB/m)
1	*2480.00	97.7 PK			1.12 V	203	99.8	-2.1
2	*2480.00	66.9 AV			1.12 V	203	69.0	-2.1
3	2483.50	51.8 PK	74.0	-22.2	1.12 V	203	53.9	-2.1
4	2483.50	21.0 AV	54.0	-33.0	1.12 V	203	23.1	-2.1
5	4960.00	47.3 PK	74.0	-26.7	1.49 V	155	41.6	5.7
6	4960.00	16.5 AV	54.0	-37.5	1.49 V	155	10.8	5.7

Remarks:

1. Emission Level(dBuV/m) = Raw Value(dBuV) + Correction Factor(dB/m)
2. Correction Factor(dB/m) = Antenna Factor(dB/m) + Cable Factor(dB) – Pre-Amplifier Factor(dB)
3. Margin value = Emission Level – Limit value
4. The other emission levels were very low against the limit.
5. " * " : Fundamental frequency.
6. The average value of fundamental and harmonic frequency is: Average = Peak value + 20 log(Duty cycle) Where the duty cycle correction factor is calculated from following formula:
 $20 \log(\text{Duty cycle}) = 20 \log(2.889 \text{ ms} / 100 \text{ ms}) = -30.8 \text{ dB}$

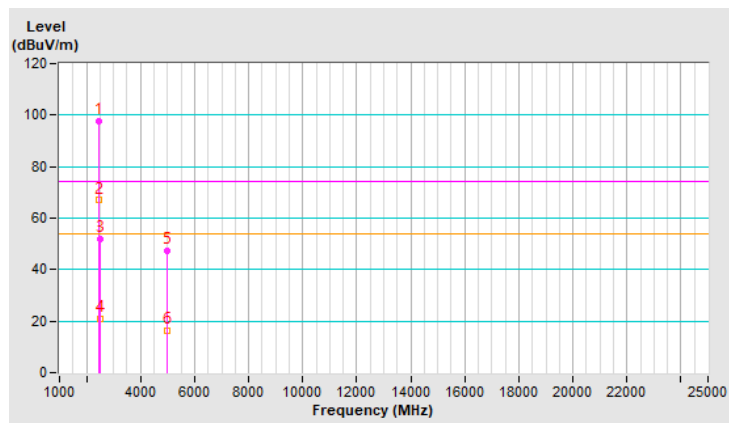

Plot of Band Edge

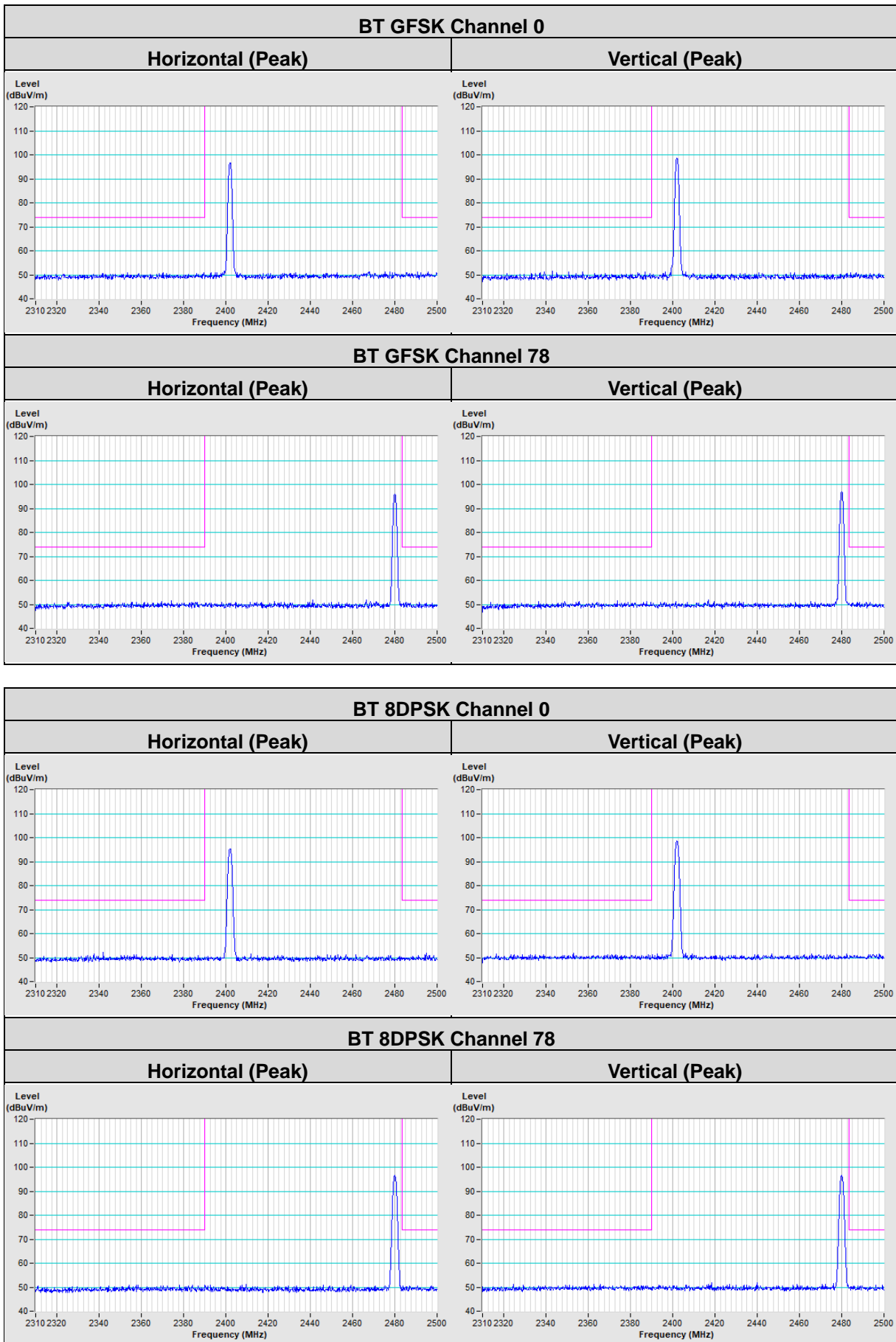

8 Pictures of Test Arrangements

Please refer to the attached file (Test Setup Photo)

9 Information of the Testing Laboratories

We, Bureau Veritas Consumer Products Services (H.K.) Ltd., Taoyuan Branch, were founded in 1988 to provide our best service in EMC, Radio, Telecom and Safety consultation. Our laboratories are FCC recognized accredited test firms and accredited according to ISO/IEC 17025.

If you have any comments, please feel free to contact us at the following:

Lin Kou EMC/RF Lab

Tel: 886-2-26052180

Fax: 886-2-26051924

Hsin Chu EMC/RF/Telecom Lab

Tel: 886-3-6668565

Fax: 886-3-6668323

Hwa Ya EMC/RF/Safety Lab

Tel: 886-3-3183232

Fax: 886-3-3270892

Email: service.adt@bureauveritas.com

Web Site: <http://ee.bureauveritas.com.tw>

The address and road map of all our labs can be found in our web site also.

--- END ---