



Test report No. : 4790186595-US-R1-V0
Page : 1 of 88
Issued date : 2022/1/12
FCC ID : BY4WFD1500PRO

RADIO TEST REPORT

Product : Full-HD Wireless Presentation Receiver
Model Name : WFD-1500 PRO
FCC ID : BY4WFD1500PRO
Test Regulation : FCC 47 CFR Part 15 Subpart E (Section 15.407)
Received Date : 2021/8/18
Test Date : 2021/8/18 ~ 2021/12/2
Issued Date : 2022/1/12

Applicant : Trans Electric Co., Ltd
771 Sec.2 Chungsan Rd, Huatang, Changhua, Taiwan

Issued By : Underwriters Laboratories Taiwan Co., Ltd.
Building B and Building E, No. 372-7, Sec. 4, Zhongxing Rd.,
Zhudong Township, Hsinchu County, Taiwan



The results reported herein have been performed in accordance with the laboratory's terms of accreditation. This report shall not be reproduced except in full without the written approval of the Laboratory. The results in this report are responsible of the test sample(s) provided by the client only and are not to be used to indicate applicability to other similar products.

Underwriters Laboratories Taiwan Co., Ltd.

Building B and Building E, No. 372-7, Sec. 4, Zhongxing Rd., Zhudong Township, Hsinchu County, Taiwan
Telephone :+886-2-7737-3000
Facsimile (FAX) :+886-3-583-7948

Doc No: 17-EM-F0878 / 6.0



Table of Contents

1. Attestation of Test Results	4
2. Summary of Test Results	5
3. Test Methodology and Reference Procedures.....	6
4. Facilities and Accreditation.....	6
5. Measurement Uncertainty	7
6. Equipment under Test	8
6.1. Description of EUT.....	8
6.2. Channel List.....	10
6.3. Test Condition.....	11
6.4. Description of Available Antennas.....	11
6.5. Test Mode Applicability and Tested Channel Detail.....	12
6.6. Duty cycle	13
7. Test Equipment.....	14
8. Description of Test Setup.....	16
9. Test Results.....	18
9.1. 6dB Bandwidth	18
9.2. 26dB Bandwidth	21
9.3. Occupied Bandwidth.....	24
9.4. Conducted output power	28
9.5. Power Spectral Density.....	32
9.6. Frequency Stability	39
9.7. Radiated Spurious Emission	41
9.8. AC Power Line Conducted Emission	68
Appendix I Radiated Band Edge and OOB Measurement.....	72
Appendix II Radiated Spurious Emission Measurement	82

Underwriters Laboratories Taiwan Co., Ltd.

Building B and Building E, No. 372-7, Sec. 4, Zhongxing Rd., Zhudong Township, Hsinchu County, Taiwan

Telephone :+886-2-7737-3000

Facsimile (FAX) :+886-3-583-7948

Doc No: 17-EM-F0878 / 6.0



Test report No. : 4790186595-US-R1-V0
Page : 4 of 88
Issued date : 2022/1/12
FCC ID : BY4WFD1500PRO

1. Attestation of Test Results

APPLICANT: Trans Electric Co., Ltd
771 Sec.2 Chungsan Rd, Huatang, Changhua, Taiwan

MANUFACTURER: Trans Electric Co., Ltd
771 Sec.2 Chungsan Rd, Huatang, Changhua, Taiwan

EUT DESCRIPTION: Full-HD Wireless Presentation Receiver

BRAND: PX

MODEL: WFD-1500 PRO

SAMPLE STAGE: Engineering Verification Test sample

DATE of TESTED: 2021/8/18 ~ 2021/12/2

APPLICABLE STANDARDS	
STANDARD	Test Results
FCC 47 CFR PART 15 Subpart E (Section 15.407)	PASS

Underwriters Laboratories Taiwan Co., Ltd. tested the above equipment in accordance with the requirements set forth in the above standards. All indications of Pass/Fail in this report are opinions expressed by Underwriters Laboratories Taiwan Co., Ltd. based on interpretations and/or observations of test results. The test results show that the equipment tested is capable of demonstrating compliance with the requirements as documented in this report.

Note: The results documented in this report apply only to the tested sample, under the conditions and modes of operation as described herein. This document may not be altered or revised in any way unless done so by Underwriters Laboratories Taiwan Co., Ltd. and all revisions are duly noted in the revisions section. Any alteration of this document not carried out by Underwriters Laboratories Taiwan Co., Ltd. will constitute fraud and shall nullify the document. This report must not be used by the client to claim product certification, approval, or endorsement by NVLAP, NIST, any agency of the Federal Government, or any agency of any government.

Prepared By:

Sally Lu
Project Handler

Date : 2022/1/12

Approved and Authorized By:

Waternil Guan
Engineer

Date : 2022/1/12

Underwriters Laboratories Taiwan Co., Ltd.

Building B and Building E, No. 372-7, Sec. 4, Zhongxing Rd., Zhudong Township, Hsinchu County, Taiwan
Telephone : +886-2-7737-3000
Facsimile (FAX) : +886-3-583-7948

Doc No: 17-EM-F0878 / 6.0



2. Summary of Test Results

Summary of Test Results		
FCC Clause	Test Items	Result
15.407(e)	6dB Bandwidth	PASS
15.403(i)	26dB Bandwidth	PASS
2.1049	Occupied Bandwidth	See Note2
15.407(a)(1/3)	Conducted Output Power	PASS
15.407(a)(1/3)	Power Spectral Density	PASS
15.407(g)	Frequency Stability	PASS
15.407(b) (1/4(i/ii)/9)	Radiated Emissions and Band Edge Measurement	PASS
15.407(b)(9)	AC Power Conducted Emission	PASS
15.203	Antenna Requirement	PASS
15.407(h)	Dynamic Frequency Selection	N/A

Note:

1. For the Radiated Band Edge and OOB test plots were recorded in Appendix I, the Radiated Emissions test plots were recorded in Appendix II.
2. The Occupied Bandwidth was reference only.

Underwriters Laboratories Taiwan Co., Ltd.

Building B and Building E, No. 372-7, Sec. 4, Zhongxing Rd., Zhudong Township, Hsinchu County, Taiwan

Telephone :+886-2-7737-3000

Facsimile (FAX) :+886-3-583-7948

Doc No: 17-EM-F0878 / 6.0



3. Test Methodology and Reference Procedures

The tests documented in this report were performed in accordance with 47 CFR FCC Part 2, KDB 789033 D02 General UNII Test Procedure New Rules v02r01, KDB414788 D01 Radiated Test Site v01r01, ANSI C63.10-2013.

4. Facilities and Accreditation

Test Location	Underwriters Laboratories Taiwan Co., Ltd.
Address	Building B and Building E, No. 372-7, Sec. 4, Zhongxing Rd., Zhudong Township, Hsinchu County, Taiwan
Accreditation Certificate	Underwriters Laboratories Taiwan Co., Ltd. is accredited by TAF, Laboratory Code 3398.

Underwriters Laboratories Taiwan Co., Ltd.

Building B and Building E, No. 372-7, Sec. 4, Zhongxing Rd., Zhudong Township, Hsinchu County, Taiwan

Telephone :+886-2-7737-3000

Facsimile (FAX) :+886-3-583-7948



5. Measurement Uncertainty

For statement of conformity, accuracy method (Section 8.2.4 and 8.2.5 of ISO Guide 98-4) was applied as decision rule for measurement in this test report.

The following uncertainties have been calculated to provide a confidence level of 95 % using a coverage factor $k=2$.

Measurement	Frequency	Uncertainty
Conducted disturbance at mains terminals ports	150kHz ~ 30MHz	± 3.1 dB
RF Conducted	9 kHz - 40GHz	± 1.9 dB
Radiated disturbance below 30MHz	9 kHz - 30 MHz	± 1.9 dB
Radiated disturbance below 1 GHz	30MHz ~ 1GHz	± 5.4 dB
Radiated disturbance above 1 GHz	1GHz ~ 40GHz	± 4.7 dB

Underwriters Laboratories Taiwan Co., Ltd.

Building B and Building E, No. 372-7, Sec. 4, Zhongxing Rd., Zhudong Township, Hsinchu County, Taiwan

Telephone :+886-2-7737-3000

Facsimile (FAX) :+886-3-583-7948

Doc No: 17-EM-F0878 / 6.0



6. Equipment under Test

6.1. Description of EUT

Product	Full-HD Wireless Presentation Receiver	
Brand Name	PX	
Model Name	WFD-1500 PRO	
Operating Frequency	5180 ~ 5240 MHz 5745 ~ 5825 MHz	
Modulation	256QAM, 64QAM, 16QAM, QPSK, BPSK	
Transfer Rate	802.11a: up to 54 Mbps 802.11n: up to MCS7 802.11ac: up to MCS9	
Number of Channel	5180 ~ 5240 MHz	4 for 802.11a, 802.11n (HT20), 802.11ac (VHT20)
		2 for 802.11n (HT40), 802.11ac (VHT40)
		1 for 802.11ac (VHT80)
	5745 ~ 5825 MHz	5 for 802.11a, 802.11n (HT20), 802.11ac (VHT20)
		2 for 802.11n (HT40), 802.11ac (VHT40)
		1 for 802.11ac (VHT80)
Maximum Output Power	5180 ~ 5240 MHz: 14.94 dBm 5745 ~ 5825 MHz: 15.01 dBm	
Normal Voltage	5Vdc from adapter	
Sample ID	Conducted Test: 4160488, 4423808 Radiated Test: 4148229, 4423808	
Software Version	00.0003.07.20190211	

Underwriters Laboratories Taiwan Co., Ltd.

Building B and Building E, No. 372-7, Sec. 4, Zhongxing Rd., Zhudong Township, Hsinchu County, Taiwan

Telephone :+886-2-7737-3000

Facsimile (FAX) :+886-3-583-7948

Doc No: 17-EM-F0878 / 6.0



Note:

1. The EUT incorporates a SISO function. Physically, the EUT provides one completed transmitter and one receiver.

Modulation Mode	Tx,Rx Function
802.11a	1TX,1RX
802.11n (HT20)	1TX,1RX
802.11n (HT40)	1TX,1RX
802.11ac (VHT20)	1TX,1RX
802.11ac (VHT40)	1TX,1RX
802.11ac (VHT80)	1TX,1RX

* The modulation and bandwidth are similar for 802.11n mode for HT20 / HT40 and 802.11ac mode for VHT20 / VHT40, therefore investigated worst case to representative mode in test report.

2. The EUT contains following accessory devices.

Product	Brand	Model	Description
Type C USB Cable	PX	F1563G	Length: 1m

3. The above EUT information is declared by manufacturer and for more detailed features description, please refer the manufacturer's or user's manual.

Underwriters Laboratories Taiwan Co., Ltd.

Building B and Building E, No. 372-7, Sec. 4, Zhongxing Rd., Zhudong Township, Hsinchu County, Taiwan

Telephone :+886-2-7737-3000

Facsimile (FAX) :+886-3-583-7948

Doc No: 17-EM-F0878 / 6.0



6.2. Channel List

FOR 5180 ~ 5240MHz

4 channels are provided for 802.11a, 802.11n (HT20), 802.11ac (VHT20):

Channel	Frequency	Channel	Frequency
36	5180 MHz	44	5220 MHz
40	5200 MHz	48	5240 MHz

2 channels are provided for 802.11n (HT40), 802.11ac (VHT40):

Channel	Frequency	Channel	Frequency
38	5190 MHz	46	5230 MHz

1 channel is provided for 802.11ac (VHT80):

Channel	Frequency
42	5210MHz

FOR 5745 ~ 5825MHz:

5 channels are provided for 802.11a, 802.11n (HT20), 802.11ac (VHT20):

Channel	Frequency	Channel	Frequency
149	5745MHz	161	5805MHz
153	5765MHz	165	5825MHz
157	5785MHz	-	-

2 channels are provided for 802.11n (HT40), 802.11ac (VHT40):

Channel	Frequency	Channel	Frequency
151	5755MHz	159	5795MHz

1 channel is provided for 802.11ac (VHT80):

Channel	Frequency
155	5775MHz

Underwriters Laboratories Taiwan Co., Ltd.

Building B and Building E, No. 372-7, Sec. 4, Zhongxing Rd., Zhudong Township, Hsinchu County, Taiwan

Telephone :+886-2-7737-3000

Facsimile (FAX) :+886-3-583-7948

Doc No: 17-EM-F0878 / 6.0



6.3. Test Condition

Test Item	Test Site No.	Environmental Condition	Input Power	Test Date	Tested by
Antenna Port Conducted Measurement	SR4	22~26°C/ 62~68%RH	5Vdc	2021/08/18~ 2021/12/02	Mike Cai
Radiated Spurious Emission	966-2	22~26°C/ 62~68%RH	5Vdc	2021/08/18~ 2021/12/02	Mike Cai
AC power Line Conducted Emission	SR1	22~26°C/ 62~68%RH	5Vdc	2021/12/02~ 2021/12/02	Mike Cai

FCC Test Firm Registration Number: 498077

6.4. Description of Available Antennas

Ant. No.	Transmitter Circuit	Brand Name	Model Name	Ant. Type	Maximum Gain (dBi)
1	Chain (0)	PX	PX_Wifi	PCB PIFA	2.4GHz: -7 5GHz: -7

Note: The above antenna information was provided from customer and for more detailed features description, please refer the manufacturer's specification or user's manual.

Underwriters Laboratories Taiwan Co., Ltd.

Building B and Building E, No. 372-7, Sec. 4, Zhongxing Rd., Zhudong Township, Hsinchu County, Taiwan

Telephone :+886-2-7737-3000

Facsimile (FAX) :+886-3-583-7948

Doc No: 17-EM-F0878 / 6.0



6.5. Test Mode Applicability and Tested Channel Detail

- The fundamental of the EUT was investigated in three orthogonal X-Y/Y-Z/X-Z, it was determined that X-Y was worst-case. Therefore, all final radiated testing was performed with the EUT in X-Y.
- For AC power line conducted emissions, the pre-scan has been determined by AC power 120Vac/60Hz (worst case)
- For Antenna Port Conducted Measurement, this item includes all test value of each mode, but only includes spectrum plot of worst value of each mode.
- For below 30MHz testing, investigation was done on three antenna orientations (parallel, perpendicular, and ground-parallel), parallel and perpendicular are the worst orientations, therefore testing was performed on these two orientations only.
- For below 1 GHz radiated emission and AC power line conducted emission have performed all modes of operation were investigated and the worst-case emissions are reported.
- Pre-Scan has been conducted to determine the worst-case mode from all possible combinations between available modulations, data rates and antenna ports (if EUT with antenna diversity architecture).

Test item	Mode	Frequency Band (MHz)	Modulation Technology	Available Channel	Test Channel	Data Rate
Radiated Emissions (Above 1GHz)	802.11a	5180-5240	OFDM	36 to 48	36, 44, 48	6Mbps
	802.11ac20			36 to 48	36, 44, 48	VHT0
	802.11ac40			38 to 46	38, 46	VHT0
	802.11ac80			42	42	VHT0
	802.11a	5745-5825	OFDM	149 to 165	149, 157, 165	6Mbps
	802.11ac20			149 to 165	149, 157, 165	VHT0
	802.11ac40			151 to 159	151, 159	VHT0
	802.11ac80			155	155	VHT0
Radiated Emissions (Below 1GHz)	802.11a	5180-5240	OFDM	36 to 48	44	6Mbps
AC Power Line Conducted Emission	802.11a	5180-5240	OFDM	36 to 48	44	6Mbps
Antenna Port Conducted Measurement	802.11a	5180-5240	OFDM	36 to 48	36, 44, 48	6Mbps
	802.11ac20			36 to 48	36, 44, 48	VHT0
	802.11ac40			38 to 46	38, 46	VHT0
	802.11ac80			42	42	VHT0
	802.11a	5745-5825	OFDM	149 to 165	149, 157, 165	6Mbps
	802.11ac20			149 to 165	149, 157, 165	VHT0
	802.11ac40			151 to 159	151, 159	VHT0
	802.11ac80			155	155	VHT0

Underwriters Laboratories Taiwan Co., Ltd.

Building B and Building E, No. 372-7, Sec. 4, Zhongxing Rd., Zhudong Township, Hsinchu County, Taiwan
Telephone :+886-2-7737-3000
Facsimile (FAX) :+886-3-583-7948



6.6. Duty cycle

802.11a: Duty cycle = $1.35/2.37 = 0.57$, Duty factor(dB) = $10 * \log(1/0.57) = 2.45$

802.11ac(VHT20): Duty cycle = $1.25/2.28 = 0.548$, Duty factor(dB) = $10 * \log(1/0.548) = 2.62$

802.11ac(VHT40): Duty cycle = $0.59/1.63 = 0.362$, Duty factor(dB) = $10 * \log(1/0.362) = 4.42$

802.11ac(VHT80): Duty cycle = $0.28/1.32 = 0.212$, Duty factor(dB) = $10 * \log(1/0.212) = 6.74$

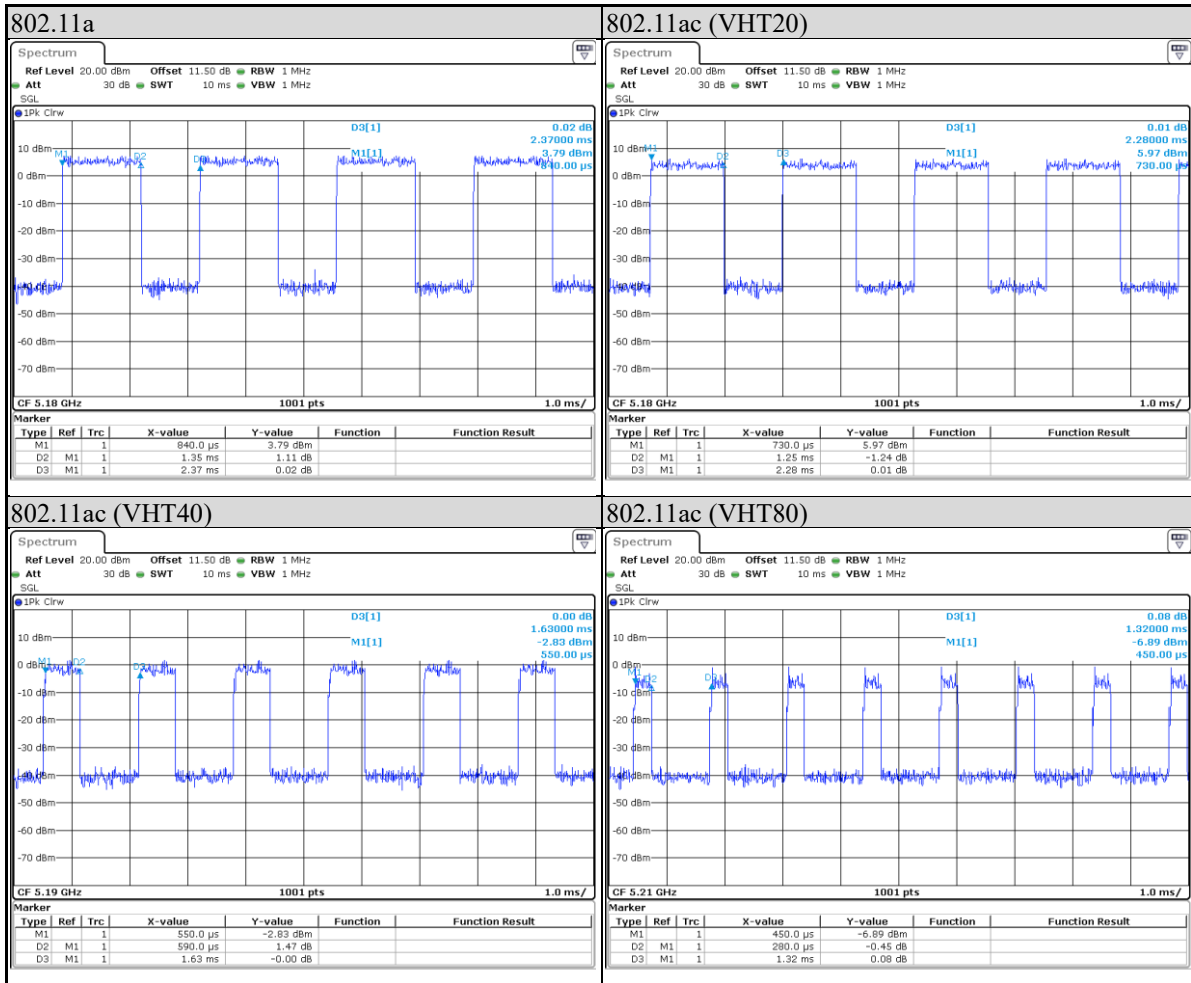



7. Test Equipment

Test Equipment List					
Equipment	Manufacturer	Model No.	Serial No.	Cal. Date	Expired date
Radiated Spurious Emission					
Spectrum Analyzer	Keysight	N9010A	MY56070827	2020/11/11	2021/11/10
				2021/11/9	2022/11/8
EMI Test Receiver	Rohde & Schwarz	ESR7	101754	2020/12/11	2021/12/10
Loop Antenna	ETS lindgren	6502	00213440	2020/12/25	2021/12/24
Trilog-Broadband Antenna with 5dB Attenuator	Schwarzbeck & EMCI	VULB 9168 & N-6-05	774 & AT-N0538	2021/1/13	2022/1/12
Horn Antenna (1-18 GHz)	Schwarzbeck	BBHA 9120 D	01690	2020/12/30	2021/12/29
Horn Antenna (18-40 GHz)	Schwarzbeck	BBHA 9170	781	2020/12/30	2021/12/29
Preamplifier (30-1000 MHz)	EMCI	EMC330E	980405	2021/6/8	2022/6/7
Preamplifier (1-18 GHz)	EMCI	EMC051835BE	980406	2021/2/3	2022/2/2
Preamplifier (18-40GHz)	EMCI	EMC184040SEE	980426	2021/5/19	2022/5/18
Cables	Hanyitek	K1K50-UP0264-K1K50-2500	170214-4 & 170425-2	2021/1/22	2022/1/21
Cables	Hanyitek	K1K50-UP0264-K1K50-2500	170214-1 & 170214-2	2021/1/22	2022/1/21

Underwriters Laboratories Taiwan Co., Ltd.

Building B and Building E, No. 372-7, Sec. 4, Zhongxing Rd., Zhudong Township, Hsinchu County, Taiwan

Telephone :+886-2-7737-3000

Facsimile (FAX) :+886-3-583-7948

Doc No: 17-EM-F0878 / 6.0



Test report No. : 4790186595-US-R1-V0
Page : 15 of 88
Issued date : 2022/1/12
FCC ID : BY4WFD1500PRO

Test Equipment List					
Equipment	Manufacturer	Model No.	Serial No.	Cal. Date	Expired date
Antenna Port Conducted Measurement					
Spectrum Analyzer	Keysight	N9010A	MY56070834	2020/11/6	2021/11/5
				2021/10/29	2022/10/28
Pulse Power Sensor	Anritsu	MA2411B	1531202	2020/12/21	2021/12/20
Power Meter	Anritsu	ML2495A	1645002	2020/12/21	2021/12/20
Temperature & Humidity Test Chamber	GIANT FORCE	GTH-150-40-CP-AR	MAA1701-010	2021/3/22	2022/3/21
AC power Line Conducted Emission					
EMI Test Receiver	Rohde & Schwarz	ESR7	101753	2020/11/17	2021/11/16
Two-Line V-Network	Rohde & Schwarz	ENV216	102136	2021/8/30	2022/8/29
Impuls-Begrenzer Pulse Limiter	Rohde & Schwarz	ESH3-Z2	102219-Qt	2021/8/26	2022/8/25
Cables	TITAN	CFD200	T0732ACFD20 020A300-1	2021/3/2	2022/3/1

UL Software		
Description	Name	Version
Radiated measurement	e3	6.191211 (V6)
Conducted measurement	RF Conducted Test Tools	ver 2.4.0.620b
AC power Line Conducted Emission	EZ_EMG	UL-3A1.2

Underwriters Laboratories Taiwan Co., Ltd.

Building B and Building E, No. 372-7, Sec. 4, Zhongxing Rd., Zhudong Township, Hsinchu County, Taiwan

Telephone :+886-2-7737-3000

Facsimile (FAX) :+886-3-583-7948

Doc No: 17-EM-F0878 / 6.0



8. Description of Test Setup

Support Equipment

ID	Equipment	Brand Name	Model Name	S/N	Remark
A	Adapter	HTC	TC P900-US	79H00130-01M	Provide by Lab
B	Monitor	LG	22MP58VQ	802NTZN6V197	Provide by Lab

I/O Cables

ID	Equipment	Brand Name	Model Name	Length (m)	Remark
1	Type C USB Cable	PX	F1563G	1	Provide by Client
2	HDMI Cable	PX	HD2-1.5MX	1.5	Provide by Lab

Test Setup

Controlled using a bespoke application (Realtek 11ac 8822B USB WLAN MP_00.0003.07.20190211) on a test Notebook. The application was used to enable a continuous transmission mode and to select the test channels, data rates, modulation schemes and power setting as required.

Underwriters Laboratories Taiwan Co., Ltd.

Building B and Building E, No. 372-7, Sec. 4, Zhongxing Rd., Zhudong Township, Hsinchu County, Taiwan

Telephone :+886-2-7737-3000

Facsimile (FAX) :+886-3-583-7948

Doc No: 17-EM-F0878 / 6.0



Setup Diagram for Test

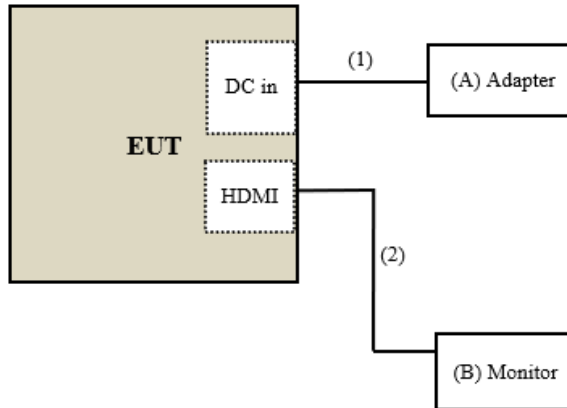

Under Table

Remote Site

Underwriters Laboratories Taiwan Co., Ltd.

Building B and Building E, No. 372-7, Sec. 4, Zhongxing Rd., Zhudong Township, Hsinchu County, Taiwan

Telephone :+886-2-7737-3000

Facsimile (FAX) :+886-3-583-7948

Doc No: 17-EM-F0878 / 6.0



9. Test Results

9.1. 6dB Bandwidth

Requirements

The minimum 6 dB bandwidth shall be at least 500 kHz.

Test procedure

- a. Set resolution bandwidth (RBW) = 100kHz
- b. Set the video bandwidth (VBW) $\geq 3 \times$ RBW, Detector = Peak.
- c. Trace mode = max hold.
- d. Sweep = auto couple.
- e. Measure the maximum width of the emission that is constrained by the frequencies associated with the two amplitude points (upper and lower) that are attenuated by 6 dB relative to the maximum level measured in the fundamental emission

Test Setup

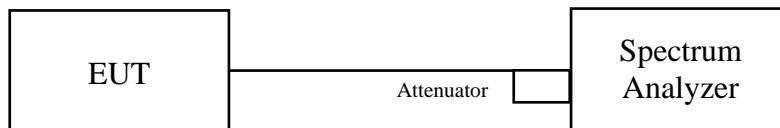

The loss between RF output port of the EUT and the input port of the Spectrum Analyzer has been taken into consideration.

Underwriters Laboratories Taiwan Co., Ltd.

Building B and Building E, No. 372-7, Sec. 4, Zhongxing Rd., Zhudong Township, Hsinchu County, Taiwan

Telephone :+886-2-7737-3000

Facsimile (FAX) :+886-3-583-7948

Doc No: 17-EM-F0878 / 6.0



Test Data

802.11a

Channel	Frequency (MHz)	6 dB Bandwidth (MHz)	Minimum Limit (MHz)	Pass / Fail
149	5745	16.30	0.5	PASS
157	5785	16.26	0.5	PASS
165	5825	16.06	0.5	PASS

802.11ac (VHT20)

Channel	Frequency (MHz)	6 dB Bandwidth (MHz)	Minimum Limit (MHz)	Pass / Fail
149	5745	16.66	0.5	PASS
157	5785	16.66	0.5	PASS
165	5825	16.66	0.5	PASS

802.11ac (VHT40)

Channel	Frequency (MHz)	6 dB Bandwidth (MHz)	Minimum Limit (MHz)	Pass / Fail
151	5755	35.17	0.5	PASS
159	5795	35.09	0.5	PASS

802.11ac (VHT80)

Channel	Frequency (MHz)	6 dB Bandwidth (MHz)	Minimum Limit (MHz)	Pass / Fail
155	5775	75.12	0.5	PASS

Underwriters Laboratories Taiwan Co., Ltd.

Building B and Building E, No. 372-7, Sec. 4, Zhongxing Rd., Zhudong Township, Hsinchu County, Taiwan

Telephone :+886-2-7737-3000

Facsimile (FAX) :+886-3-583-7948

Doc No: 17-EM-F0878 / 6.0

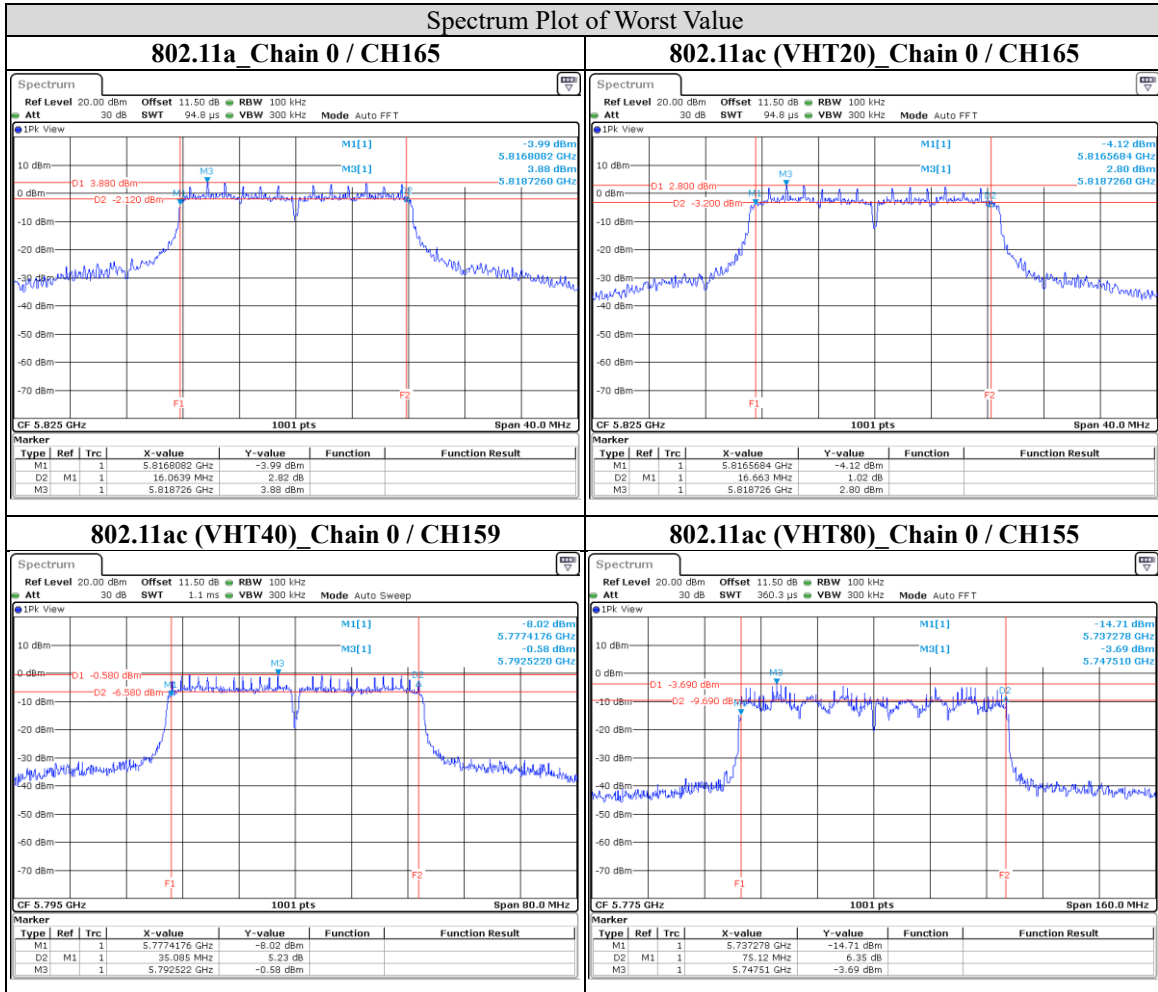



9.2. 26dB Bandwidth

Test procedure

- Set RBW = approximately 1% of the emission bandwidth.
- Set the VBW > RBW.
- Detector = Peak.
- Trace mode = max hold.
- Measure the maximum width of the emission that is 26 dB down from the peak of the emission. Compare this with the RBW setting of the analyzer. Readjust RBW and repeat measurement as needed until the RBW/EBW ratio is approximately 1%.

Test Setup

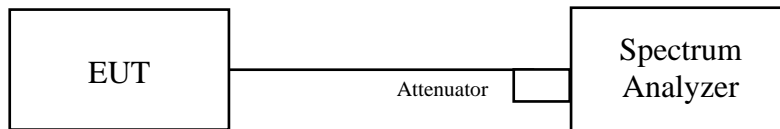

The loss between RF output port of the EUT and the input port of the Spectrum Analyzer has been taken into consideration.

Underwriters Laboratories Taiwan Co., Ltd.

Building B and Building E, No. 372-7, Sec. 4, Zhongxing Rd., Zhudong Township, Hsinchu County, Taiwan

Telephone :+886-2-7737-3000

Facsimile (FAX) :+886-3-583-7948

Doc No: 17-EM-F0878 / 6.0



Test Data

802.11a

Channel	Channel Frequency (MHz)	26 dB Bandwidth (MHz)
36	5180	38.92
44	5220	41.08
48	5240	33.57

802.11ac (VHT20)

Channel	Channel Frequency (MHz)	26 dB Bandwidth (MHz)
36	5180	34.69
44	5220	39.58
48	5240	34.77

802.11ac (VHT40)

Channel	Channel Frequency (MHz)	26 dB Bandwidth (MHz)
38	5190	73.21
46	5230	73.65

802.11ac (VHT80)

Channel	Channel Frequency (MHz)	26 dB Bandwidth (MHz)
42	5210	143.54

Underwriters Laboratories Taiwan Co., Ltd.

Building B and Building E, No. 372-7, Sec. 4, Zhongxing Rd., Zhudong Township, Hsinchu County, Taiwan

Telephone :+886-2-7737-3000

Facsimile (FAX) :+886-3-583-7948

Doc No: 17-EM-F0878 / 6.0

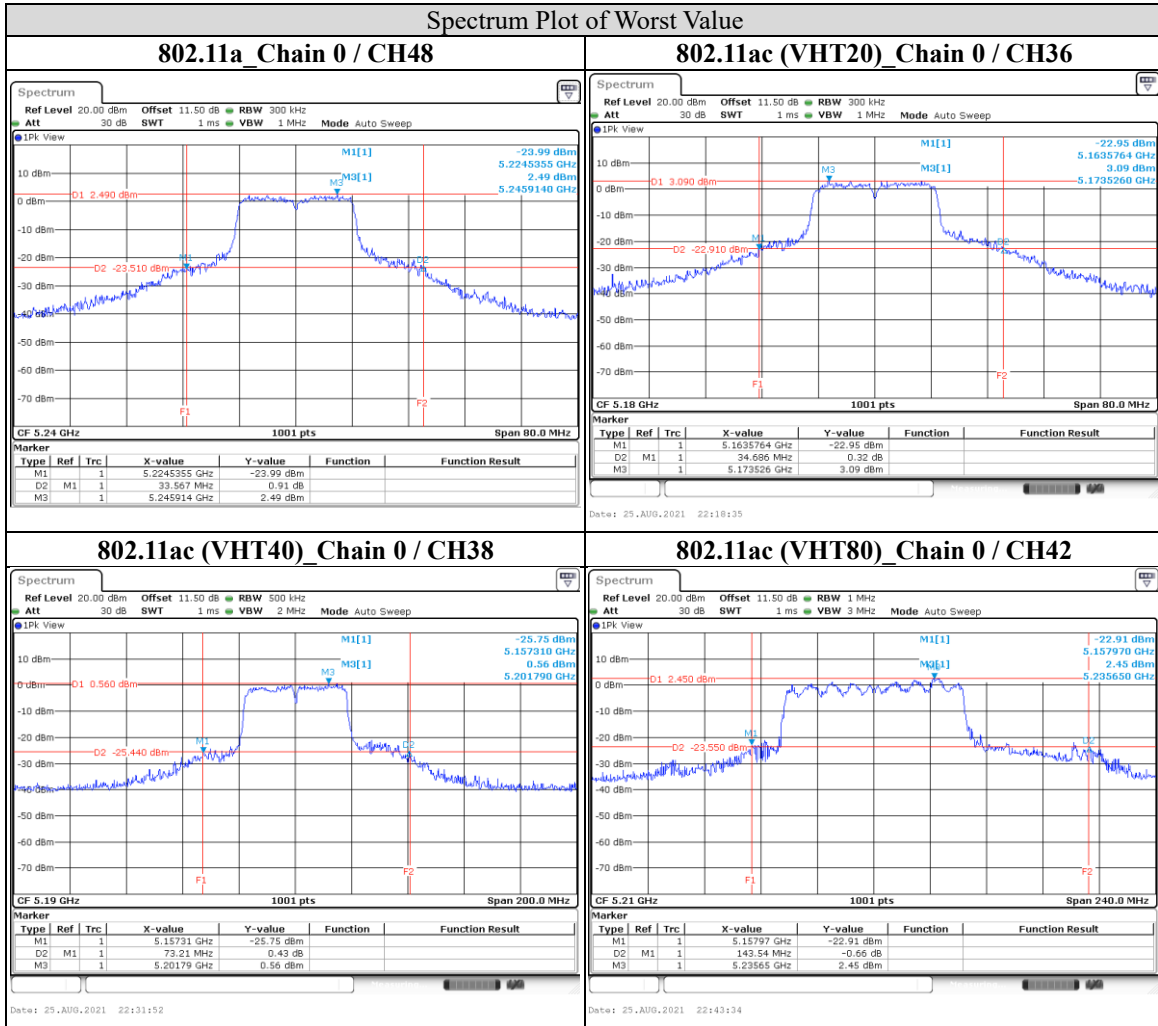



9.3. Occupied Bandwidth

Test procedure

- a. Set center frequency to the nominal EUT channel center frequency.
- b. Set span = 1.5 times to 5.0 times the OBW.
- c. Set RBW = 1% to 5% of the OBW
- d. Set VBW $\geq 3 \times$ RBW
- e. Video averaging is not permitted. Where practical, a sample detection and single sweep mode shall be used. Otherwise, peak detection and max hold mode (until the trace stabilizes) shall be used.
- f. Use the 99% power bandwidth function of the instrument (if available).
- g. If the instrument does not have a 99% power bandwidth function, the trace data points are recovered and directly summed in power units. The recovered amplitude data points, beginning at the lowest frequency, are placed in a running sum until 0.5% of the total is reached; that frequency is recorded as the lower frequency. The process is repeated until 99.5% of the total is reached; that frequency is recorded as the upper frequency. The 99% occupied bandwidth is the difference between these two frequencies.

Test Setup

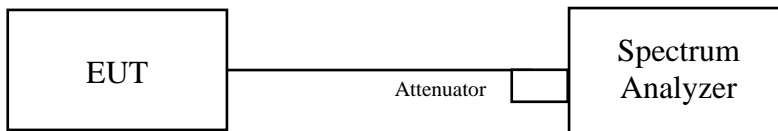

The loss between RF output port of the EUT and the input port of the Spectrum Analyzer has been taken into consideration.



Test Data

802.11a

Channel	Channel Frequency (MHz)	Occupied Bandwidth (MHz)
36	5180	18.78
44	5220	24.54
48	5240	17.30
149	5745	16.90
157	5785	16.90
165	5825	16.90

802.11ac (VHT20)

Channel	Channel Frequency (MHz)	Occupied Bandwidth (MHz)
36	5180	18.50
44	5220	21.06
48	5240	18.22
149	5745	17.90
157	5785	17.82
165	5825	17.82

802.11ac (VHT40)

Channel	Channel Frequency (MHz)	Occupied Bandwidth (MHz)
38	5190	37.08
46	5230	38.04
151	5755	36.68
159	5795	36.52

802.11ac (VHT80)

Channel	Channel Frequency (MHz)	Occupied Bandwidth (MHz)
42	5210	76.56
155	5775	75.44

Underwriters Laboratories Taiwan Co., Ltd.

Building B and Building E, No. 372-7, Sec. 4, Zhongxing Rd., Zhudong Township, Hsinchu County, Taiwan

Telephone :+886-2-7737-3000

Facsimile (FAX) :+886-3-583-7948

Doc No: 17-EM-F0878 / 6.0

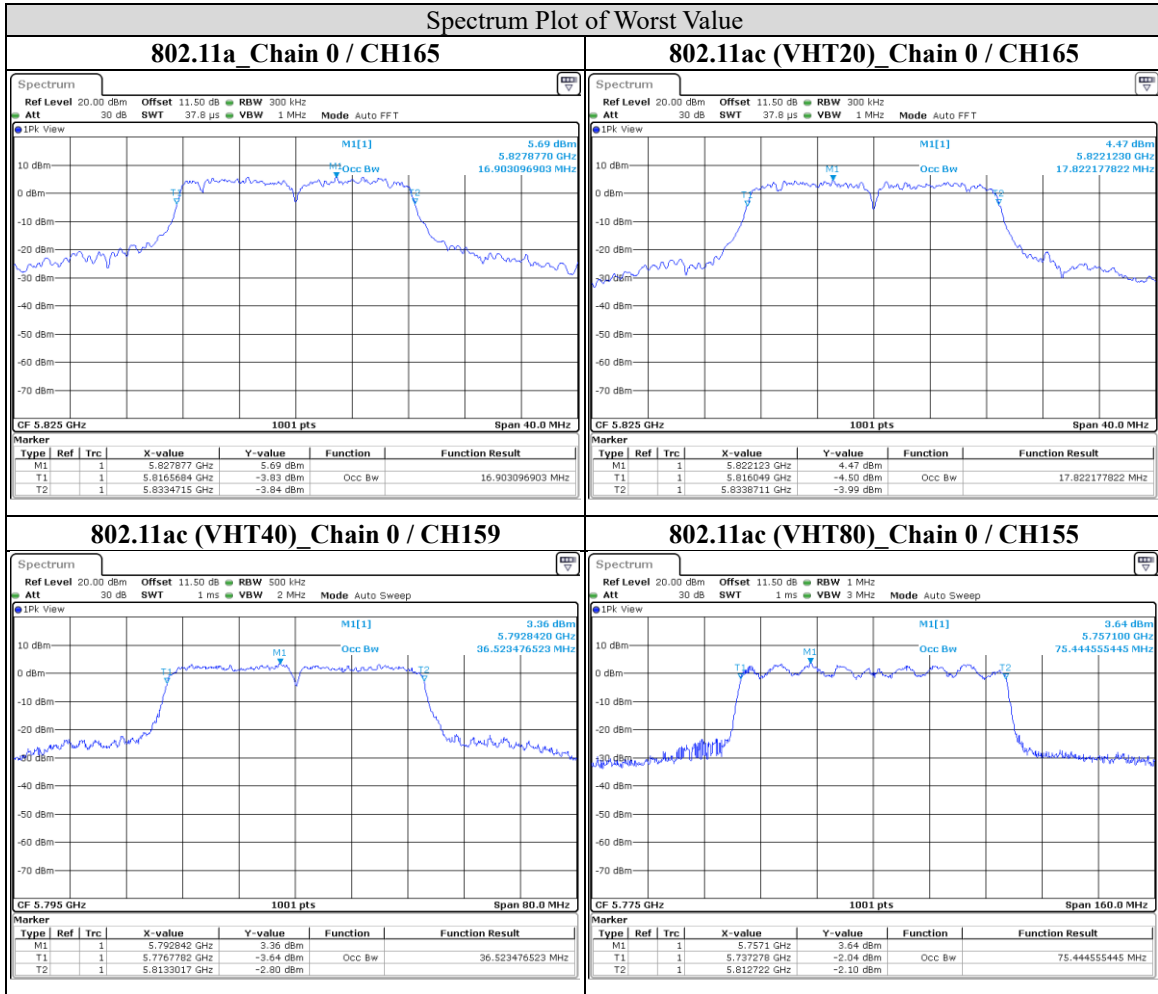

Underwriters Laboratories Taiwan Co., Ltd.

Building B and Building E, No. 372-7, Sec. 4, Zhongxing Rd., Zhudong Township, Hsinchu County, Taiwan

Telephone : +886-2-7737-3000

Facsimile (FAX) : +886-3-583-7948

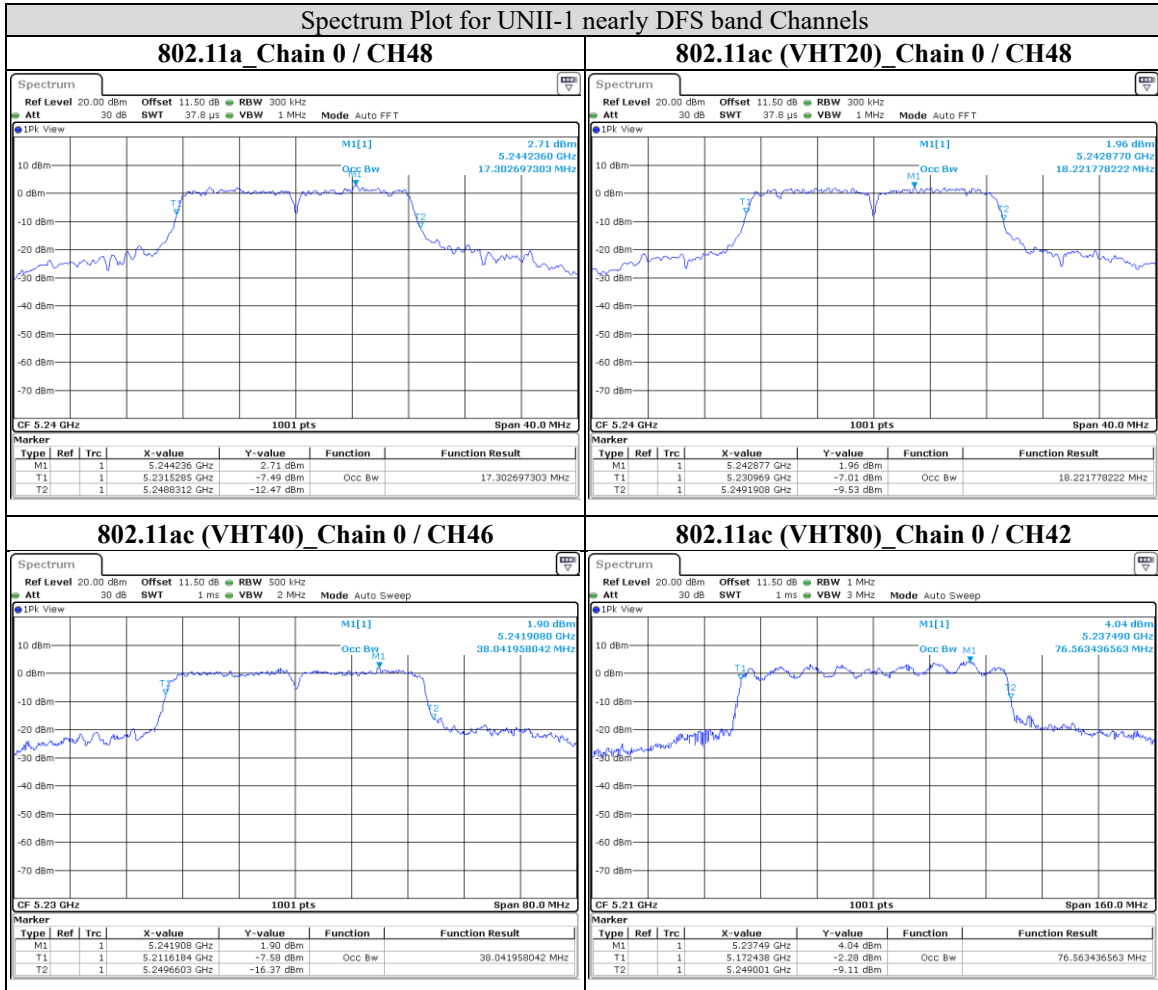

Note: The observed T2 is all <5250 MHz, so UNII-1 band channels which in nearly DFS band no need for DFS function.



9.4. Conducted output power

Requirements

Operation Band	EUT Category		Limit
U-NII-1		Outdoor Access Point	1 Watt (30 dBm) Max. e.i.r.p \leq 125mW(21 dBm) at any elevation angle above 30 degrees as measured from the horizon If $G_{TX} > 6$ dBi, then $P_{Out} = 30 - (G_{TX} - 6)$
		Fixed point-to-point Access Point	1 Watt (30 dBm) If $G_{TX} > 23$ dBi, then $P_{Out} = 30 - (G_{TX} - 23)$
		Indoor Access Point	1 Watt (30 dBm) If $G_{TX} > 6$ dBi, then $P_{Out} = 30 - (G_{TX} - 6)$
	√	Client device	250mW (24 dBm) If $G_{TX} > 6$ dBi, then $P_{Out} = 23.98 - (G_{TX} - 6)$
U-NII-2A	---		250mW (24 dBm) or 11 dBm+10 log B* If $G_{TX} > 6$ dBi, then $P_{Out} = 23.98 - (G_{TX} - 6)$
U-NII-2C	---		250mW (24 dBm) or 11 dBm+10 log B* If $G_{TX} > 6$ dBi, then $P_{Out} = 23.98 - (G_{TX} - 6)$
U-NII-3	√		For Point-to-multipoint systems (P2M): 1 Watt (30 dBm). If $G_{TX} > 6$ dBi, then $P_{Out} = 30 - (G_{TX} - 6)$ For Point-to-point systems (P2P): 1 Watt (30 dBm)

Note:

1. P_{Out} = maximum conducted output power in dBm,
2. G_{TX} = the maximum transmitting antenna directional gain in dBi.
3. B is the 26 dB emission bandwidth in megahertz

Underwriters Laboratories Taiwan Co., Ltd.

Building B and Building E, No. 372-7, Sec. 4, Zhongxing Rd., Zhudong Township, Hsinchu County, Taiwan

Telephone :+886-2-7737-3000

Facsimile (FAX) :+886-3-583-7948

Doc No: 17-EM-F0878 / 6.0



Test Procedure

For Average Power Measurement

Test method PM-G

For 802.11a, 802.11ac (VHT20), 802.11ac (VHT40)

Method PM is used to perform output power measurement, trigger and gating function of wide band power meter is enabled to measure max output power of TX on burst and set the detector to AVERAGE. Duty factor is not added to measured value.

Test method SA-1

For 802.11ac (VHT80)

- a. Set span to encompass the entire 26 dB EBW (or, alternatively, the entire 99% occupied bandwidth) of the signal.
- b. Set sweep trigger*.
- c. Set RBW = 1 MHz.
- d. Set VBW \geq 3 MHz
- e. Number of points in sweep \geq 2 Span / RBW.
- f. Sweep time \leq (number of points in sweep) * T
- g. Using emission bandwidth to determine the frequency span for integration the channel bandwidth.
- h. Detector = RMS.
- i. Trace mode = max hold.
- j. Allow max hold to run for at least 60 seconds, or longer as needed to allow the trace to stabilize.

* If transmit duty cycle < 98%, use a video trigger with the trigger level set to enable triggering only on full power pulses. Transmitter must operate at maximum power control level for the entire duration of every sweep. If the EUT transmits continuously (i.e., with no off intervals) or at duty cycle \geq 98%, and if each transmission is entirely at the maximum power control level, then the trigger shall be set to "free run."

Underwriters Laboratories Taiwan Co., Ltd.

Building B and Building E, No. 372-7, Sec. 4, Zhongxing Rd., Zhudong Township, Hsinchu County, Taiwan

Telephone :+886-2-7737-3000

Facsimile (FAX) :+886-3-583-7948

Doc No: 17-EM-F0878 / 6.0



Test Setup

For Average Power Measurement

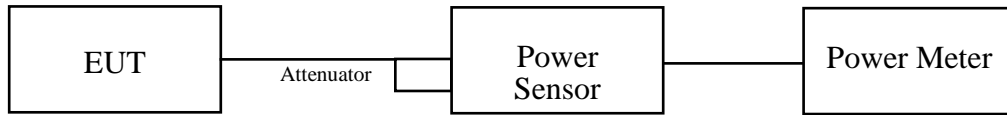

The loss between RF output port of the EUT and the input port of the Power Meter has been taken into consideration.

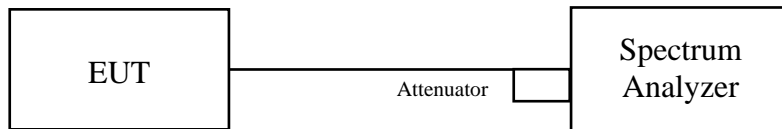

The loss between RF output port of the EUT and the input port of the Spectrum Analyzer has been taken into consideration.

Underwriters Laboratories Taiwan Co., Ltd.

Building B and Building E, No. 372-7, Sec. 4, Zhongxing Rd., Zhudong Township, Hsinchu County, Taiwan

Telephone :+886-2-7737-3000

Facsimile (FAX) :+886-3-583-7948

Doc No: 17-EM-F0878 / 6.0



Test Data

802.11a

Channel	Channel Frequency (MHz)	Maximum Conducted Power (mW)	Maximum Conducted Power (dBm)	Power Limit (dBm)	Pass/Fail
36	5180	19.953	13.00	23.98	PASS
44	5220	31.189	14.94	23.98	PASS
48	5240	16.904	12.28	23.98	PASS
149	5745	31.696	15.01	30	PASS
157	5785	30.69	14.87	30	PASS
165	5825	30.409	14.83	30	PASS

802.11ac (VHT20)

Channel	Channel Frequency (MHz)	Maximum Conducted Power (mW)	Maximum Conducted Power (dBm)	Power Limit (dBm)	Pass/Fail
36	5180	19.634	12.93	23.98	PASS
44	5220	24.491	13.89	23.98	PASS
48	5240	18.45	12.66	23.98	PASS
149	5745	23.55	13.72	30	PASS
157	5785	24.889	13.96	30	PASS
165	5825	24.604	13.91	30	PASS

802.11ac (VHT40)

Channel	Channel Frequency (MHz)	Maximum Conducted Power (mW)	Maximum Conducted Power (dBm)	Power Limit (dBm)	Pass/Fail
38	5190	12.445	10.95	23.98	PASS
46	5230	14.825	11.71	23.98	PASS
151	5755	25.235	14.02	30	PASS
159	5795	25.293	14.03	30	PASS

802.11ac (VHT80)

Channel	Channel Frequency (MHz)	Maximum Conducted Power (mW)	Maximum Conducted Power (dBm)	Power Limit (dBm)	Pass/Fail
42	5210	11.482	10.60	23.98	PASS
155	5775	16.069	12.06	30	PASS

Underwriters Laboratories Taiwan Co., Ltd.

Building B and Building E, No. 372-7, Sec. 4, Zhongxing Rd., Zhudong Township, Hsinchu County, Taiwan

Telephone :+886-2-7737-3000

Facsimile (FAX) :+886-3-583-7948

Doc No: 17-EM-F0878 / 6.0



9.5. Power Spectral Density

Requirements

Operation Band	EUT Category		Limit
U-NII-1		Outdoor Access Point	17dBm/ MHz If $G_{TX} > 6$ dBi, then $PSD = 17 - (G_{TX} - 6)$
		Fixed point-to-point Access Point	17dBm/ MHz If $G_{TX} > 23$ dBi, then $PSD = 17 - (G_{TX} - 23)$
		Indoor Access Point	17dBm/ MHz If $G_{TX} > 6$ dBi, then $PSD = 17 - (G_{TX} - 6)$
	√	Client device	11dBm/ MHz If $G_{TX} > 6$ dBi, then $PSD = 11 - (G_{TX} - 6)$
U-NII-2A	---		11dBm/ MHz If $G_{TX} > 6$ dBi, then $PSD = 11 - (G_{TX} - 6)$
U-NII-2C	---		11dBm/ MHz If $G_{TX} > 6$ dBi, then $PSD = 11 - (G_{TX} - 6)$
U-NII-3	√		For Point-to-multipoint systems (P2M): 30dBm/ 500kHz. If $G_{TX} > 6$ dBi, then $PSD = 30 - (G_{TX} - 6)$ For Point-to-point systems (P2P): 30dBm/ 500kHz

Note:

1. PSD = power spectral density that he same method as used to determine the conducted output power shall be used to determine the power spectral density. And power spectral density in dBm/MHz
2. G_{TX} = the maximum transmitting antenna directional gain in dBi.

Underwriters Laboratories Taiwan Co., Ltd.

Building B and Building E, No. 372-7, Sec. 4, Zhongxing Rd., Zhudong Township, Hsinchu County, Taiwan

Telephone :+886-2-7737-3000

Facsimile (FAX) :+886-3-583-7948

Doc No: 17-EM-F0878 / 6.0



Test procedure

For U-NII-1 band:

Using method as below:

- Set span to encompass the entire emission bandwidth (EBW) of the signal.
- Set RBW = 1 MHz, Set VBW \geq 3 RBW, Detector = RMS
- Sweep time = auto, trigger set to “free run”.
- Trace average at least 100 traces in power averaging mode.
- Record the max value. (if Duty cycle <98 %, add 10 log (1/duty cycle))

For U-NII-3 band:

Using method as below:

- Set span to encompass the entire emission bandwidth (EBW) of the signal.
- Set RBW = 300 kHz, Set VBW \geq 1 MHz, Detector = RMS
- Use the peak marker function to determine the maximum power level in any 300 kHz band segment within the fundamental EBW.
- Scale the observed power level to an equivalent value in 500 kHz by adjusting (reducing) the measured power by a bandwidth correction factor (BWCF) where $BWCF = 10 \log (500 \text{ kHz}/300\text{kHz})$
- Sweep time = auto, trigger set to “free run”.
- Trace average at least 100 traces in power averaging mode.
- Record the max value. (if Duty cycle <98 %, add 10 log (1/duty cycle))

Test Setup

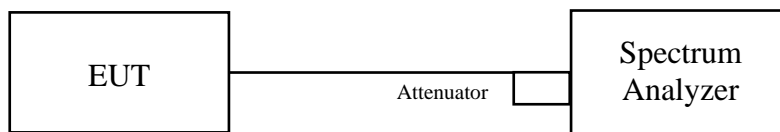

The loss between RF output port of the EUT and the input port of the Spectrum Analyzer has been taken into consideration.

Underwriters Laboratories Taiwan Co., Ltd.

Building B and Building E, No. 372-7, Sec. 4, Zhongxing Rd., Zhudong Township, Hsinchu County, Taiwan

Telephone :+886-2-7737-3000

Facsimile (FAX) :+886-3-583-7948

Doc No: 17-EM-F0878 / 6.0



Test Data

For U-NII-1 band

802.11a

Channel	Frequency (MHz)	PSD w/o duty factor (dBm/MHz)	Total PSD with duty factor (dBm/MHz)	PSD Maximum Limit (dBm/MHz)	Pass/Fail
36	5180	-1.18	1.27	11	PASS
44	5220	1.30	3.75	11	PASS
48	5240	-1.65	0.8	11	PASS

NOTE: Refer to section 6.6 for duty cycle spectrum plot.

802.11ac (VHT20)

Channel	Frequency (MHz)	PSD w/o duty factor (dBm/MHz)	Total PSD with duty factor (dBm/MHz)	PSD Maximum Limit (dBm/MHz)	Pass/Fail
36	5180	0.39	3.01	11	PASS
44	5220	-1.07	1.55	11	PASS
48	5240	-0.92	1.7	11	PASS

NOTE: Refer to section 6.6 for duty cycle spectrum plot.

802.11ac (VHT40)

Channel	Frequency (MHz)	PSD w/o duty factor (dBm/MHz)	Total PSD with duty factor (dBm/MHz)	PSD Maximum Limit (dBm/MHz)	Pass/Fail
38	5190	-7.17	-2.75	11	PASS
46	5230	-6.05	-1.63	11	PASS

NOTE: Refer to section 6.6 for duty cycle spectrum plot.

802.11ac (VHT80)

Channel	Frequency (MHz)	PSD w/o duty factor (dBm/MHz)	Total PSD with duty factor (dBm/MHz)	PSD Maximum Limit (dBm/MHz)	Pass/Fail
42	5210	-9.68	-2.94	11	PASS

NOTE: Refer to section 6.6 for duty cycle spectrum plot.

Underwriters Laboratories Taiwan Co., Ltd.

Building B and Building E, No. 372-7, Sec. 4, Zhongxing Rd., Zhudong Township, Hsinchu County, Taiwan

Telephone :+886-2-7737-3000

Facsimile (FAX) :+886-3-583-7948

Doc No: 17-EM-F0878 / 6.0

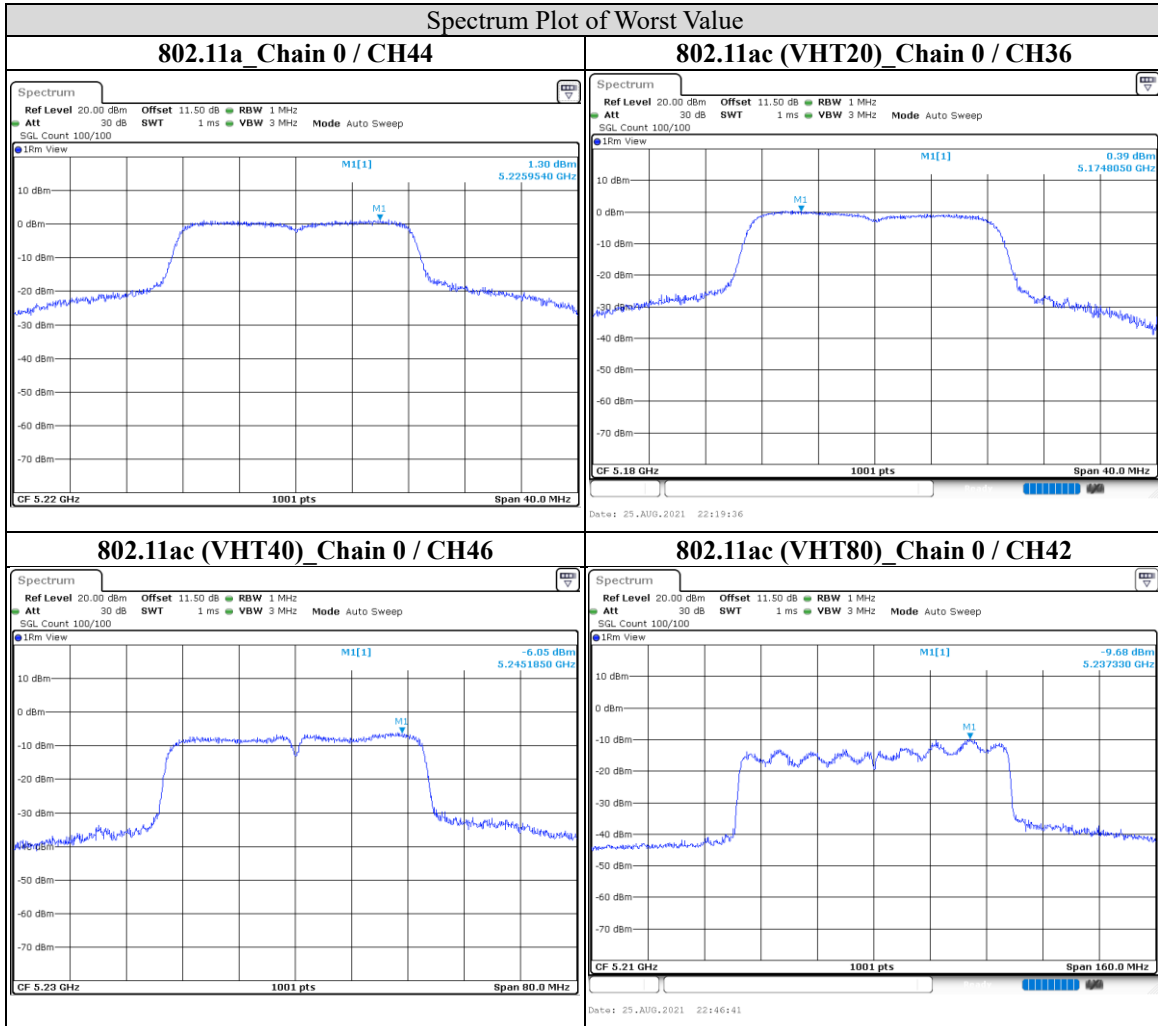

Underwriters Laboratories Taiwan Co., Ltd.

Building B and Building E, No. 372-7, Sec. 4, Zhongxing Rd., Zhudong Township, Hsinchu County, Taiwan

Telephone : +886-2-7737-3000

Facsimile (FAX) : +886-3-583-7948



For U-NII-3 Band

802.11a

Channel	Frequency (MHz)	PSD w/o duty factor (dBm/300 kHz)	PSD with BWCF (dBm/500 kHz)	PSD with duty factor (dBm/500 kHz)	Limit (dBm/500 kHz)	Pass / Fail
149	5745	-4.16	-1.94	0.51	30	PASS
157	5785	-3.55	-1.33	1.12	30	PASS
165	5825	-3.46	-1.24	1.21	30	PASS

Note:

1. Refer to section 6.6 for duty cycle spectrum plot.
2. Scale the observed power level to an equivalent value in 500 kHz by adjusting (reducing) the measured power by a bandwidth correction factor (BWCF) where $BWCF = 10\log(500\text{ kHz}/300\text{ kHz})$.

802.11ac (VHT20)

Channel	Frequency (MHz)	PSD w/o duty factor (dBm/300 kHz)	PSD with BWCF (dBm/500 kHz)	PSD with duty factor (dBm/500 kHz)	Limit (dBm/500 kHz)	Pass / Fail
149	5745	-5.39	-3.17	-0.55	30	PASS
157	5785	-4.82	-2.60	0.02	30	PASS
165	5825	-5.32	-3.10	-0.48	30	PASS

Note:

1. Refer to section 6.6 for duty cycle spectrum plot.
2. Scale the observed power level to an equivalent value in 500 kHz by adjusting (reducing) the measured power by a bandwidth correction factor (BWCF) where $BWCF = 10\log(500\text{ kHz}/300\text{ kHz})$.

Underwriters Laboratories Taiwan Co., Ltd.

Building B and Building E, No. 372-7, Sec. 4, Zhongxing Rd., Zhudong Township, Hsinchu County, Taiwan

Telephone : +886-2-7737-3000

Facsimile (FAX) : +886-3-583-7948

Doc No: 17-EM-F0878 / 6.0



802.11ac (VHT40)

Channel	Frequency (MHz)	PSD w/o duty factor (dBm/300 kHz)	PSD with BWCF (dBm/500 kHz)	PSD with duty factor (dBm/500 kHz)	Limit (dBm/500 kHz)	Pass / Fail
151	5755	-9.63	-7.41	-2.99	30	PASS
159	5795	-9.56	-7.34	-2.92	30	PASS

Note:

1. Refer to section 6.6 for duty cycle spectrum plot.
2. Scale the observed power level to an equivalent value in 500 kHz by adjusting (reducing) the measured power by a bandwidth correction factor (BWCF) where $BWCF = 10\log(500\text{ kHz}/300\text{ kHz})$.

802.11ac (VHT80)

Channel	Frequency (MHz)	PSD w/o duty factor (dBm/300 kHz)	PSD with BWCF (dBm/500 kHz)	PSD with duty factor (dBm/500 kHz)	Limit (dBm/500 kHz)	Pass / Fail
155	5775	-14.35	-12.13	-5.39	30	PASS

Note:

1. Refer to section 6.6 for duty cycle spectrum plot.
2. Scale the observed power level to an equivalent value in 500 kHz by adjusting (reducing) the measured power by a bandwidth correction factor (BWCF) where $BWCF = 10\log(500\text{ kHz}/300\text{ kHz})$.

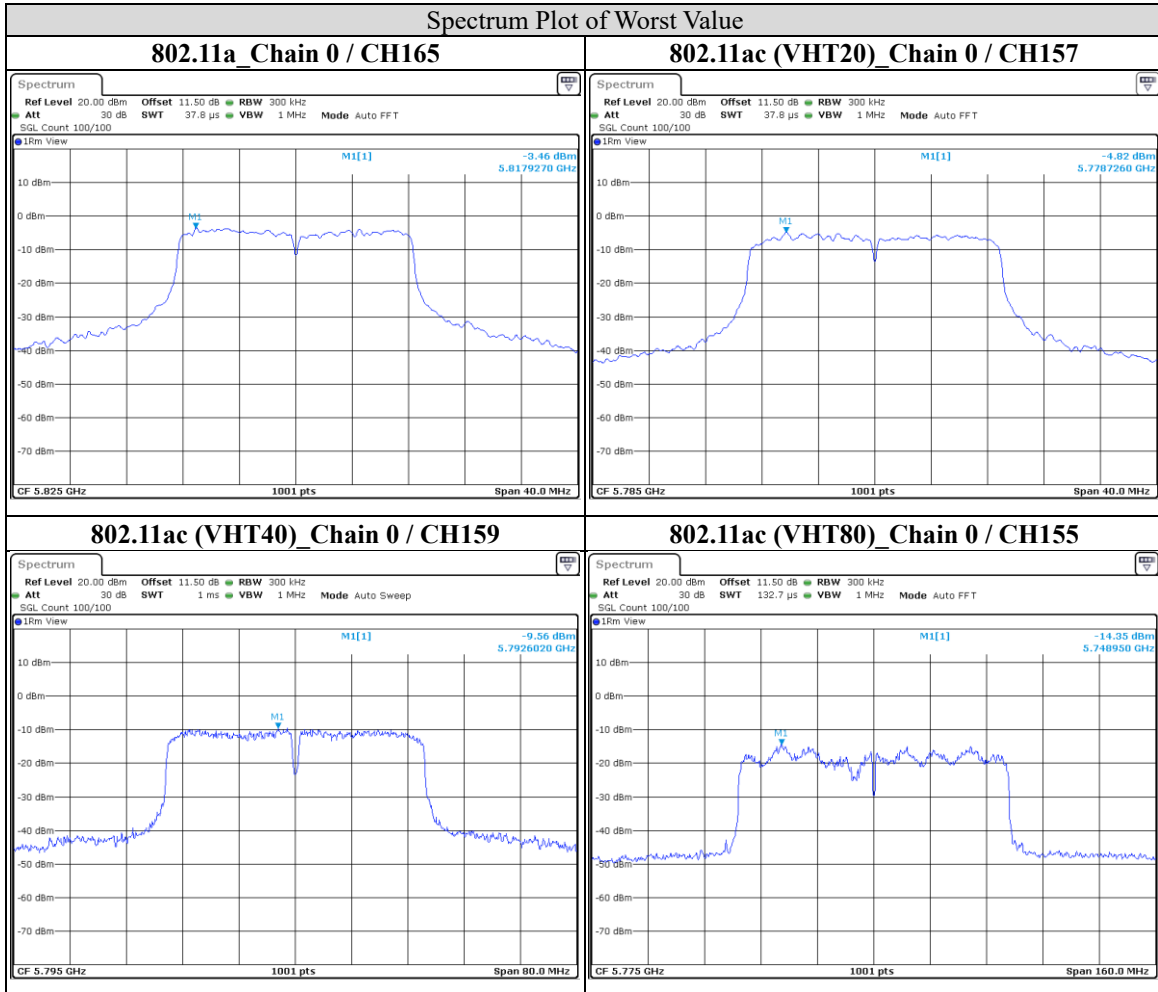

Underwriters Laboratories Taiwan Co., Ltd.

Building B and Building E, No. 372-7, Sec. 4, Zhongxing Rd., Zhudong Township, Hsinchu County, Taiwan

Telephone : +886-2-7737-3000

Facsimile (FAX) : +886-3-583-7948

9.6. Frequency Stability

Requirements

The frequency of the carrier signal shall be maintained within band of operation.

Test procedure

- The EUT was placed inside the environmental test chamber and powered by nominal DC voltage.
- Turn the EUT on and couple its output to a spectrum analyzer.
- Turn the EUT off and set the chamber to the highest temperature specified.
- Allow sufficient time (approximately 30 min) for the temperature of the chamber to stabilize, turn the EUT on and measure the operating frequency after 2, 5, and 10 Minutes.
- Repeat step 2 and 3 with the temperature chamber set to the lowest temperature.
- The test chamber was allowed to stabilize at +20 degree C for a minimum of 30 Minutes. The supply voltage was then adjusted on the EUT from 85% to 115% and the frequency record.

Test Setup

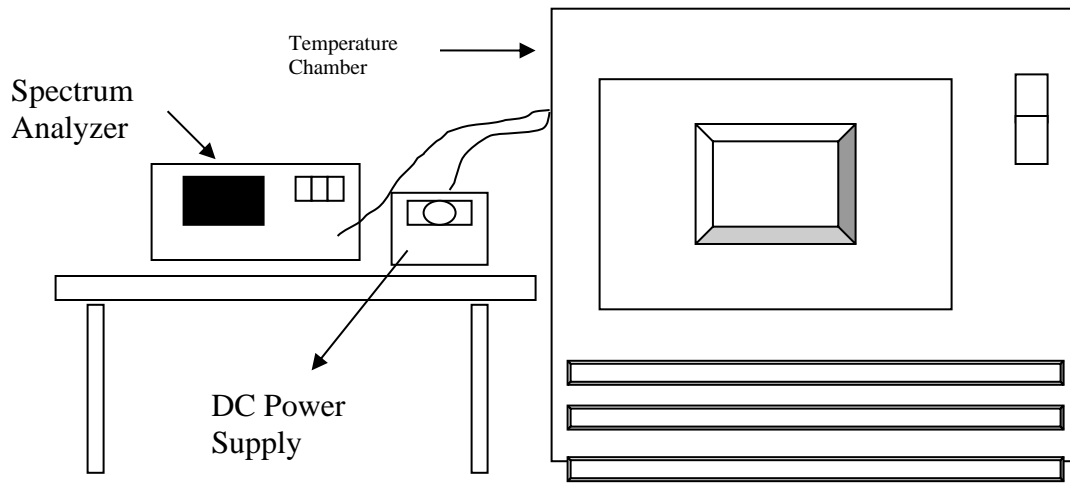



Test Data

Frequency Stability Versus Temp.									
Operating Frequency: 5180 MHz									
TEMP. (°C)	Power Supply (Vdc)	0 Minute		2 Minute		5 Minute		10 Minute	
		Measured Frequency (MHz)	Freq. Drift (ppm)	Measured Frequency (MHz)	Freq. Drift (ppm)	Measured Frequency (MHz)	Freq. Drift (ppm)	Measured Frequency (MHz)	Freq. Drift (ppm)
50	5	5180.0028	0.54	5179.9985	-0.29	5180.0031	0.60	5180.0019	0.37
40	5	5179.9755	-4.73	5179.9757	-4.69	5179.9729	-5.23	5179.9768	-4.48
30	5	5180.0009	0.17	5180.0016	0.31	5180.0013	0.25	5179.9981	-0.37
20	5	5180.0233	4.50	5180.0216	4.17	5180.0231	4.46	5180.022	4.25
10	5	5180.0148	2.86	5180.0124	2.39	5180.0142	2.74	5180.013	2.51
0	5	5179.9951	-0.95	5179.9936	-1.24	5179.9981	-0.37	5179.9948	-1.00
-10	5	5180.008	1.54	5180.0041	0.79	5180.0042	0.81	5180.0086	1.66
-20	5	5179.9808	-3.71	5179.9796	-3.94	5179.9827	-3.34	5179.982	-3.47
-30	5	5180.0224	4.32	5180.0221	4.27	5180.0174	3.36	5180.0205	3.96
TEMP. (°C)	Power Supply (Vac)	0 Minute		2 Minute		5 Minute		10 Minute	
		Measured Frequency (MHz)	Freq. Drift (ppm)	Measured Frequency (MHz)	Freq. Drift (ppm)	Measured Frequency (MHz)	Freq. Drift (ppm)	Measured Frequency (MHz)	Freq. Drift (ppm)
20	5.75	5180.0224	4.32	5180.0214	4.13	5180.0221	4.27	5180.0221	4.27
20	5	5180.0233	4.50	5180.0216	4.17	5180.0231	4.46	5180.022	4.25
20	4.25	5180.0224	4.32	5180.021	4.05	5180.0241	4.65	5180.0215	4.15

Underwriters Laboratories Taiwan Co., Ltd.

Building B and Building E, No. 372-7, Sec. 4, Zhongxing Rd., Zhudong Township, Hsinchu County, Taiwan

Telephone :+886-2-7737-3000

Facsimile (FAX) :+886-3-583-7948

Doc No: 17-EM-F0878 / 6.0



9.7. Radiated Spurious Emission

Requirements

Radiated emissions which fall in the restricted bands must comply with the radiated emission limits specified as below table.

Frequency(MHz)	Field strength (microvolts/meter)	Measurement distance (meters)
0.009-0.490	2400/F(kHz)	300
0.490-1.705	24000/F(kHz)	30
1.705-30.0	30	30
30-88	100	3
88-216	150	3
216-960	200	3
Above 960	500	3

NOTE:

1. The lower limit shall apply at the transition frequencies.
2. Emission level (dBuV/m) = 20 log Emission level (uV/m).
3. For frequencies above 1000MHz, the field strength limits are based on average detector, however, the peak field strength of any emission shall not exceed the maximum permitted average limits, specified above by more than 20dB under any condition of modulation.

Underwriters Laboratories Taiwan Co., Ltd.

Building B and Building E, No. 372-7, Sec. 4, Zhongxing Rd., Zhudong Township, Hsinchu County, Taiwan

Telephone :+886-2-7737-3000

Facsimile (FAX) :+886-3-583-7948

Doc No: 17-EM-F0878 / 6.0



Limits of unwanted emission out of the restricted bands

Applicable To		Limit	
789033 D02 General UNII Test Procedure New Rules v02r01		Field Strength at 3m	
		PK:74 (dBμV/m)	AV:54 (dBμV/m)
Frequency Band	Applicable To	EIRP Limit	Equivalent Field Strength at 3m
5150~5250 MHz	15.407(b)(1)	PK:-27 (dBm/MHz)	PK:68.2(dBμV/m)
5250~5350 MHz	15.407(b)(2)		
5470~5725 MHz	15.407(b)(3)		
5725~5850 MHz	15.407(b)(4)(i)	PK:-27 (dBm/MHz) *1 PK:10 (dBm/MHz) *2 PK:15.6 (dBm/MHz) *3 PK:27 (dBm/MHz) *4	PK: 68.2(dBμV/m) *1 PK:105.2 (dBμV/m) *2 PK: 110.8(dBμV/m) *3 PK:122.2 (dBμV/m) *4
*1 beyond 75 MHz or more above of the band edge. *2 below the band edge increasing linearly to 10 dBm/MHz at 25 MHz above. *3 below the band edge increasing linearly to a level of 15.6 dBm/MHz at 5 MHz above. *4 from 5 MHz above or below the band edge increasing linearly to a level of 27 dBm/MHz at the band edge.			

Note:

The following formula is used to convert the effective isotropic radiated power (eirp) to field strength:

$$E = \frac{1000000\sqrt{30P}}{3} \mu\text{V/m, where P is the eirp (Watts).}$$

Underwriters Laboratories Taiwan Co., Ltd.

Building B and Building E, No. 372-7, Sec. 4, Zhongxing Rd., Zhudong Township, Hsinchu County, Taiwan

Telephone :+886-2-7737-3000

Facsimile (FAX) :+886-3-583-7948



Test Procedures

[For 9 kHz ~ 30 MHz]

- a. The EUT was placed on the top of a rotating table 0.8 meters above the ground at a 3 meter chamber room. The table was rotated 360 degrees to determine the position of the highest radiation.
- b. The EUT was set 3 meters away from the interference-receiving antenna, which was mounted on the top of a variable-height antenna tower.
- c. Parallel, perpendicular, and ground-parallel orientations of the antenna are set to make the measurement.
- d. For each suspected emission, the EUT was arranged to its worst case and the rotatable table was turned from 0 degrees to 360 degrees to find the maximum reading.
- e. For measurement below 30MHz, the initial step in collecting conducted emission data is a spectrum analyzer peak detector mode pre-scanning the measurement frequency range. Significant peaks are then marked and then Quasi Peak detector mode re-measured. If the emission level of the EUT measured by the peak detector is lower than the applicable limit, the peak emission level will be reported. Otherwise, the emission measurement will be repeated using the quasi-peak detector and reported.

NOTE:

1. The resolution bandwidth and video bandwidth of test receiver/spectrum analyzer is 9kHz at frequency below 30MHz.

[For above 30 MHz]

- a. The EUT was placed on the top of a rotating table 0.8 meters (for 30MHz ~ 1GHz) / 1.5 meters (for above 1GHz) above the ground at 3 meter chamber room for test. The table was rotated 360 degrees to determine the position of the highest radiation.
- b. The EUT was set 3 meters away from the interference-receiving antenna, which was mounted on the top of a variable-height antenna tower.
- c. The height of antenna is varied from one meter to four meters above the ground to determine the maximum value of the field strength. Both horizontal and vertical polarizations of the antenna are set to make the measurement.
- d. For each suspected emission, the EUT was arranged to its worst case and then the antenna was tuned to heights from 1 meter to 4 meters and the rotatable table was turned from 0 degrees to 360 degrees to find the maximum reading.
- e. For measurement below 1GHz, the initial step in collecting conducted emission data is a spectrum analyzer peak detector mode pre-scanning the measurement frequency range. Significant peaks are then marked and then Quasi Peak detector mode re-measured. If the emission level of the EUT measured by the peak detector is lower than the applicable limit, the peak emission level will be reported. Otherwise, the emission measurement will be repeated using the quasi-peak detector and reported.
- f. The test-receiver system was set to peak and average detects function and specified bandwidth with maximum hold mode when the test frequency is above 1 GHz. If the peak reading value also meets average limit, measurement with the average detector is unnecessary.

Underwriters Laboratories Taiwan Co., Ltd.

Building B and Building E, No. 372-7, Sec. 4, Zhongxing Rd., Zhudong Township, Hsinchu County, Taiwan

Telephone :+886-2-7737-3000

Facsimile (FAX) :+886-3-583-7948

Doc No: 17-EM-F0878 / 6.0



Note:

- a. The resolution bandwidth and video bandwidth of test receiver/spectrum analyzer is 120kHz for Quasi-peak detection (QP) at frequency below 1GHz.
- b. The resolution bandwidth of test receiver/spectrum analyzer is 1 MHz and the video bandwidth is 3 MHz for Peak detection (PK) at frequency above 1GHz.
- c. The resolution bandwidth of test receiver/spectrum analyzer is 1MHz and the video bandwidth is $\geq 1/T$ (Duty cycle < 98%) or 10Hz (Duty cycle $\geq 98\%$) for Average detection (AV) at frequency above 1GHz.

Configuration	Average	
	RBW	VBW
802.11a	1MHz	1kHz
802.11ac (VHT20)		1kHz
802.11ac (VHT40)		2kHz
802.11ac (VHT80)		5.1kHz

Note: Refer to section 6.6 for duty cycle.

- d. All modes of operation were investigated (includes all external accessories) and the worst-case emissions are reported, the other emission levels were low against the limit.

Underwriters Laboratories Taiwan Co., Ltd.

Building B and Building E, No. 372-7, Sec. 4, Zhongxing Rd., Zhudong Township, Hsinchu County, Taiwan

Telephone :+886-2-7737-3000

Facsimile (FAX) :+886-3-583-7948

Doc No: 17-EM-F0878 / 6.0

Test Setup

<Frequency Range 9 kHz ~ 30 MHz>

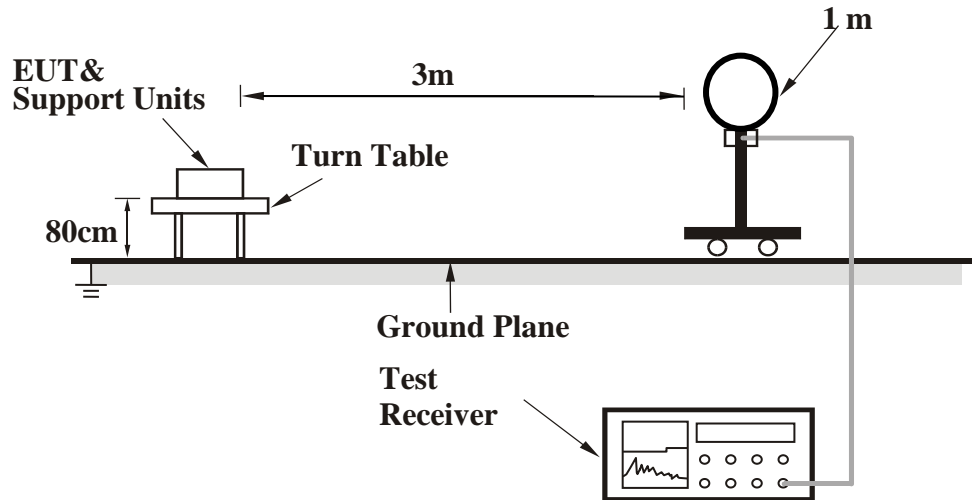

<Frequency Range 30 MHz ~ 1 GHz >

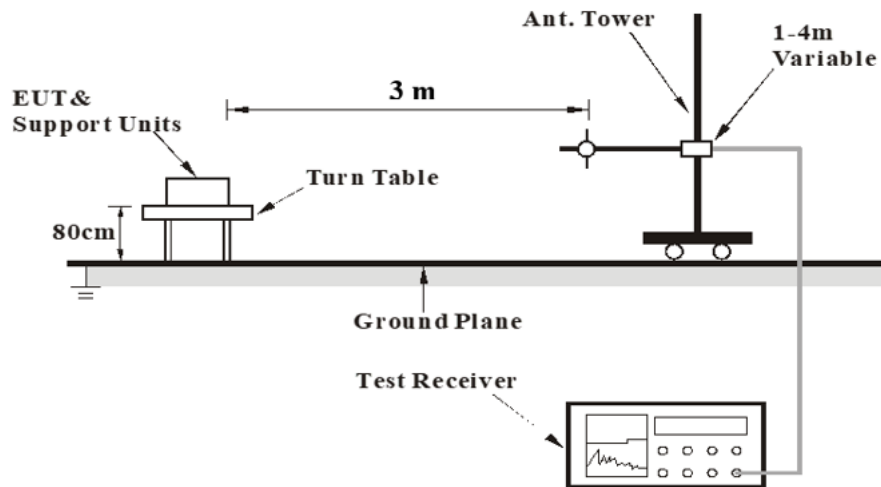

Underwriters Laboratories Taiwan Co., Ltd.

Building B and Building E, No. 372-7, Sec. 4, Zhongxing Rd., Zhudong Township, Hsinchu County, Taiwan

Telephone : +886-2-7737-3000

Facsimile (FAX) : +886-3-583-7948

Doc No: 17-EM-F0878 / 6.0



<Frequency Range above 1 GHz>

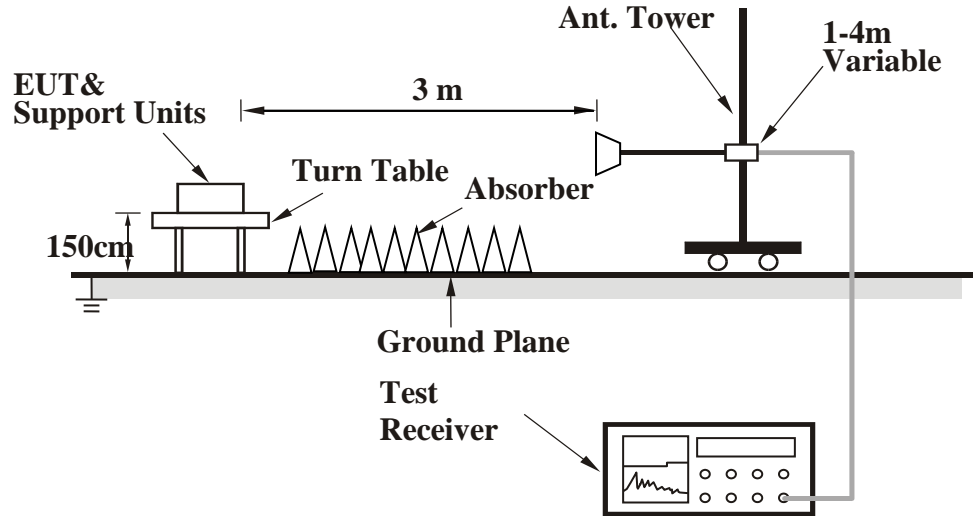

For the actual test configuration, please refer to the Setup Configurations.



Test Data

Above 1GHz Data

802.11a

EUT Test Condition		Measurement Detail	
Channel	Channel 36	Frequency Range	1 GHz ~ 40 GHz

Antenna Polarity & Test Distance: Horizontal at 3 m							
Notation	Frequency	Reading	Correct	Result	Limit	Margin	Remark
	(MHz)	(dBuV)	dB/m	(dBuV/m)	(dBuV/m)	(dB)	
-	10360	31.58	17.39	48.97	68.2	-19.23	Peak
-	5149.8	38.88	13.43	52.31	54	-1.69	Average
@	5180	83.02	13.4	96.42	-	-	Average
-	5147.35	50.78	13.43	64.21	74	-9.79	Peak
@	5180	90.41	13.4	103.81	-	-	Peak
Antenna Polarity & Test Distance: Vertical at 3 m							
Notation	Frequency	Reading	Correct	Result	Limit	Margin	Remark
	(MHz)	(dBuV)	dB/m	(dBuV/m)	(dBuV/m)	(dB)	
-	10360	32.71	17.39	50.1	68.2	-18.1	Peak
-	5149.45	37.99	13.43	51.42	54	-2.58	Average
@	5180	80.59	13.4	93.99	-	-	Average
-	5145.25	48.43	13.43	61.86	74	-12.14	Peak
@	5180	88.01	13.4	101.41	-	-	Peak

Remarks:

1. Result value (dBuV/m) = Reading value (dBuV) + Correction Factor (dB/m).
2. Margin(dB) = Result value (dBuV/m) - Limit value (dBuV/m).
3. Correction Factor (dB/m) = Antenna Factor (dB/m) + Cable Loss (dB) - Preamp Factor (dB).
4. "@": Fundamental Frequency.
5. The other emission levels were very low against the limit.

Underwriters Laboratories Taiwan Co., Ltd.

Building B and Building E, No. 372-7, Sec. 4, Zhongxing Rd., Zhudong Township, Hsinchu County, Taiwan
Telephone :+886-2-7737-3000
Facsimile (FAX) :+886-3-583-7948



EUT Test Condition		Measurement Detail	
Channel	Channel 44	Frequency Range	1 GHz ~ 40 GHz

Antenna Polarity & Test Distance: Horizontal at 3 m							
Notation	Frequency	Reading	Correct	Result	Limit	Margin	Remark
	(MHz)	(dBuV)	dB/m	(dBuV/m)	(dBuV/m)	(dB)	
-	10440	36.62	17.63	54.25	68.2	-13.95	Peak
-	5148.05	31.79	13.42	45.21	54	-8.79	Average
@	5220	85.29	13.33	98.62	-	-	Average
-	5149.1	42.06	13.43	55.49	74	-18.51	Peak
@	5220	92.86	13.33	106.19	-	-	Peak
Antenna Polarity & Test Distance: Vertical at 3 m							
Notation	Frequency	Reading	Correct	Result	Limit	Margin	Remark
	(MHz)	(dBuV)	dB/m	(dBuV/m)	(dBuV/m)	(dB)	
-	10440	36.45	17.63	54.08	68.2	-14.12	Peak
-	5148.75	31.7	13.42	45.12	54	-8.88	Average
@	5220	77.35	13.33	90.68	-	-	Average
-	5147.7	45.38	13.42	58.8	74	-15.2	Peak
@	5220	85.15	13.33	98.48	-	-	Peak

Remarks:

1. Result value (dBuV/m) = Reading value (dBuV) + Correction Factor (dB/m).
2. Margin(dB) = Result value (dBuV/m) - Limit value (dBuV/m).
3. Correction Factor (dB/m) = Antenna Factor (dB/m) + Cable Loss (dB) - Preamp Factor (dB).
4. "@": Fundamental Frequency.
5. The other emission levels were very low against the limit.

Underwriters Laboratories Taiwan Co., Ltd.

Building B and Building E, No. 372-7, Sec. 4, Zhongxing Rd., Zhudong Township, Hsinchu County, Taiwan

Telephone :+886-2-7737-3000

Facsimile (FAX) :+886-3-583-7948

Doc No: 17-EM-F0878 / 6.0



EUT Test Condition		Measurement Detail	
Channel	Channel 48	Frequency Range	1 GHz ~ 40 GHz

Antenna Polarity & Test Distance: Horizontal at 3 m							
Notation	Frequency	Reading	Correct	Result	Limit	Margin	Remark
	(MHz)	(dBuV)	dB/m	(dBuV/m)	(dBuV/m)	(dB)	
-	10480	32.18	17.69	49.87	68.2	-18.33	Peak
-	5087.85	30.65	13.43	44.08	54	-9.92	Average
@	5240	82.05	13.27	95.32	-	-	Average
-	5097.65	42.29	13.46	55.75	74	-18.25	Peak
@	5240	90.11	13.27	103.38	-	-	Peak
Antenna Polarity & Test Distance: Vertical at 3 m							
Notation	Frequency	Reading	Correct	Result	Limit	Margin	Remark
	(MHz)	(dBuV)	dB/m	(dBuV/m)	(dBuV/m)	(dB)	
-	10480	31.65	17.69	49.34	68.2	-18.86	Peak
-	5101.5	30.67	13.46	44.13	54	-9.87	Average
@	5240	75.62	13.27	88.89	-	-	Average
-	5119	41.38	13.45	54.83	74	-19.17	Peak
@	5240	83.74	13.27	97.01	-	-	Peak

Remarks:

1. Result value (dBuV/m) = Reading value (dBuV) + Correction Factor (dB/m).
2. Margin(dB) = Result value (dBuV/m) - Limit value (dBuV/m).
3. Correction Factor (dB/m) = Antenna Factor (dB/m) + Cable Loss (dB) - Preamp Factor (dB).
4. "@": Fundamental Frequency.
5. The other emission levels were very low against the limit.

Underwriters Laboratories Taiwan Co., Ltd.

Building B and Building E, No. 372-7, Sec. 4, Zhongxing Rd., Zhudong Township, Hsinchu County, Taiwan

Telephone :+886-2-7737-3000

Facsimile (FAX) :+886-3-583-7948

Doc No: 17-EM-F0878 / 6.0



EUT Test Condition		Measurement Detail	
Channel	Channel 149	Frequency Range	1 GHz ~ 40 GHz

Antenna Polarity & Test Distance: Horizontal at 3 m							
Notation	Frequency	Reading	Correct	Result	Limit	Margin	Remark
	(MHz)	(dBuV)	dB/m	(dBuV/m)	(dBuV/m)	(dB)	
*	11490	31.47	19.02	50.49	74	-23.51	Peak
-	5600.5	40.72	14.04	54.76	68.2	-13.44	Peak
-	5662.5	40.03	14.01	54.04	77.48	-23.44	Peak
@	5745	90.93	14.28	105.21	-	-	Peak
Antenna Polarity & Test Distance: Vertical at 3 m							
Notation	Frequency	Reading	Correct	Result	Limit	Margin	Remark
	(MHz)	(dBuV)	dB/m	(dBuV/m)	(dBuV/m)	(dB)	
*	11490	33.7	19.02	52.72	74	-21.28	Peak
-	5593.5	40.54	14.03	54.57	68.2	-13.63	Peak
-	5683.5	39.75	14.03	53.78	93.03	-39.25	Peak
@	5745	87.49	14.28	101.77	-	-	Peak

Remarks:

1. Result value (dBuV/m) = Reading value (dBuV) + Correction Factor (dB/m).
2. Margin(dB) = Result value (dBuV/m) - Limit value (dBuV/m).
3. Correction Factor (dB/m) = Antenna Factor (dB/m) + Cable Loss (dB) - Preamp Factor (dB).
4. "@": Fundamental Frequency.
5. "* * ": The peak result under 20 dB above and complies with AVG limit, AVG result is deemed to comply with AVG limit.
6. The other emission levels were very low against the limit.

Underwriters Laboratories Taiwan Co., Ltd.

Building B and Building E, No. 372-7, Sec. 4, Zhongxing Rd., Zhudong Township, Hsinchu County, Taiwan

Telephone :+886-2-7737-3000

Facsimile (FAX) :+886-3-583-7948

Doc No: 17-EM-F0878 / 6.0



EUT Test Condition		Measurement Detail	
Channel	Channel 157	Frequency Range	1 GHz ~ 40 GHz

Antenna Polarity & Test Distance: Horizontal at 3 m							
Notation	Frequency	Reading	Correct	Result	Limit	Margin	Remark
	(MHz)	(dBuV)	dB/m	(dBuV/m)	(dBuV/m)	(dB)	
*	11570	31.91	18.88	50.79	74	-23.21	Peak
-	5601.5	40.02	14.04	54.06	68.2	-14.14	Peak
-	5676.5	41.93	14.03	55.96	87.85	-31.89	Peak
@	5785	90.39	14.48	104.87	-	-	Peak
-	5883	41.58	14.92	56.5	99.26	-42.76	Peak
-	5941	40.93	15.01	55.94	68.2	-12.26	Peak
Antenna Polarity & Test Distance: Vertical at 3 m							
Notation	Frequency	Reading	Correct	Result	Limit	Margin	Remark
	(MHz)	(dBuV)	dB/m	(dBuV/m)	(dBuV/m)	(dB)	
*	11570	33.39	18.88	52.27	74	-21.73	Peak
-	5602.5	39.93	14.03	53.96	68.2	-14.24	Peak
-	5674.5	39.64	14.02	53.66	86.37	-32.71	Peak
@	5785	81.77	14.48	96.25	-	-	Peak
-	5902	40.73	14.97	55.7	85.18	-29.48	Peak
-	5982.5	40.61	15.11	55.72	68.2	-12.48	Peak

Remarks:

1. Result value (dBuV/m) = Reading value (dBuV) + Correction Factor (dB/m).
2. Margin(dB) = Result value (dBuV/m) - Limit value (dBuV/m).
3. Correction Factor (dB/m) = Antenna Factor (dB/m) + Cable Loss (dB) - Preamp Factor (dB).
4. "@": Fundamental Frequency.
5. " * ": The peak result under 20 dB above and complies with AVG limit, AVG result is deemed to comply with AVG limit.
6. The other emission levels were very low against the limit.

Underwriters Laboratories Taiwan Co., Ltd.

Building B and Building E, No. 372-7, Sec. 4, Zhongxing Rd., Zhudong Township, Hsinchu County, Taiwan
Telephone :+886-2-7737-3000
Facsimile (FAX) :+886-3-583-7948



EUT Test Condition		Measurement Detail	
Channel	Channel 165	Frequency Range	1 GHz ~ 40 GHz

Antenna Polarity & Test Distance: Horizontal at 3 m							
Notation	Frequency	Reading	Correct	Result	Limit	Margin	Remark
	(MHz)	(dBuV)	dB/m	(dBuV/m)	(dBuV/m)	(dB)	
*	11650	30.69	18.63	49.32	74	-24.68	Peak
@	5825	88.74	14.69	103.43	-	-	Peak
-	5906	39.78	14.98	54.76	82.22	-27.46	Peak
-	5946.5	40.58	15.02	55.6	68.2	-12.6	Peak
Antenna Polarity & Test Distance: Vertical at 3 m							
Notation	Frequency	Reading	Correct	Result	Limit	Margin	Remark
	(MHz)	(dBuV)	dB/m	(dBuV/m)	(dBuV/m)	(dB)	
*	11650	32.9	18.63	51.53	74	-22.47	Peak
@	5825	84.78	14.69	99.47	-	-	Peak
-	5917.5	40.01	14.98	54.99	73.73	-18.74	Peak
-	5955	40.07	15.04	55.11	68.2	-13.09	Peak

Remarks:

1. Result value (dBuV/m) = Reading value (dBuV) + Correction Factor (dB/m).
2. Margin(dB) = Result value (dBuV/m) - Limit value (dBuV/m).
3. Correction Factor (dB/m) = Antenna Factor (dB/m) + Cable Loss (dB) - Preamp Factor (dB).
4. "@": Fundamental Frequency.
5. "* * ": The peak result under 20 dB above and complies with AVG limit, AVG result is deemed to comply with AVG limit.
6. The other emission levels were very low against the limit.

Underwriters Laboratories Taiwan Co., Ltd.

Building B and Building E, No. 372-7, Sec. 4, Zhongxing Rd., Zhudong Township, Hsinchu County, Taiwan

Telephone :+886-2-7737-3000

Facsimile (FAX) :+886-3-583-7948

Doc No: 17-EM-F0878 / 6.0



802.11ac (VHT20)

EUT Test Condition		Measurement Detail	
Channel	Channel 36	Frequency Range	1 GHz ~ 40 GHz

Antenna Polarity & Test Distance: Horizontal at 3 m							
Notation	Frequency	Reading	Correct	Result	Limit	Margin	Remark
	(MHz)	(dBuV)	dB/m	(dBuV/m)	(dBuV/m)	(dB)	
-	10360	31.03	17.39	48.42	68.2	-19.78	Peak
-	5148.75	38.79	13.42	52.21	54	-1.79	Average
@	5180	82.5	13.4	95.9	-	-	Average
-	5149.8	52.73	13.43	66.16	74	-7.84	Peak
@	5180	88.73	13.4	102.13	-	-	Peak
Antenna Polarity & Test Distance: Vertical at 3 m							
Notation	Frequency	Reading	Correct	Result	Limit	Margin	Remark
	(MHz)	(dBuV)	dB/m	(dBuV/m)	(dBuV/m)	(dB)	
-	10360	33.03	17.39	50.42	68.2	-17.78	Peak
-	5149.8	38.45	13.43	51.88	54	-2.12	Average
@	5180	80.29	13.4	93.69	-	-	Average
-	5144.2	50.43	13.43	63.86	74	-10.14	Peak
@	5180	87.41	13.4	100.81	-	-	Peak

Remarks:

1. Result value (dBuV/m) = Reading value (dBuV) + Correction Factor (dB/m).
2. Margin(dB) = Result value (dBuV/m) - Limit value (dBuV/m).
3. Correction Factor (dB/m) = Antenna Factor (dB/m) + Cable Loss (dB) - Preamp Factor (dB).
4. "@": Fundamental Frequency.
5. The other emission levels were very low against the limit.

Underwriters Laboratories Taiwan Co., Ltd.

Building B and Building E, No. 372-7, Sec. 4, Zhongxing Rd., Zhudong Township, Hsinchu County, Taiwan
Telephone :+886-2-7737-3000
Facsimile (FAX) :+886-3-583-7948



EUT Test Condition		Measurement Detail	
Channel	Channel 44	Frequency Range	1 GHz ~ 40 GHz

Antenna Polarity & Test Distance: Horizontal at 3 m							
Notation	Frequency	Reading	Correct	Result	Limit	Margin	Remark
	(MHz)	(dBuV)	dB/m	(dBuV/m)	(dBuV/m)	(dB)	
-	10440	32.54	17.63	50.17	68.2	-18.03	Peak
-	5149.1	30.83	13.43	44.26	54	-9.74	Average
@	5220	83.5	13.33	96.83	-	-	Average
-	5067.2	42.49	13.35	55.84	74	-18.16	Peak
@	5220	91.17	13.33	104.5	-	-	Peak
Antenna Polarity & Test Distance: Vertical at 3 m							
Notation	Frequency	Reading	Correct	Result	Limit	Margin	Remark
	(MHz)	(dBuV)	dB/m	(dBuV/m)	(dBuV/m)	(dB)	
-	10440	32.83	17.63	50.46	68.2	-17.74	Peak
-	5085.4	30.74	13.42	44.16	54	-9.84	Average
@	5220	76.11	13.33	89.44	-	-	Average
-	5064.75	42.06	13.35	55.41	74	-18.59	Peak
@	5220	81.68	13.33	95.01	-	-	Peak

Remarks:

1. Result value (dBuV/m) = Reading value (dBuV) + Correction Factor (dB/m).
2. Margin(dB) = Result value (dBuV/m) - Limit value (dBuV/m).
3. Correction Factor (dB/m) = Antenna Factor (dB/m) + Cable Loss (dB) - Preamp Factor (dB).
4. "@": Fundamental Frequency.
5. The other emission levels were very low against the limit.

Underwriters Laboratories Taiwan Co., Ltd.

Building B and Building E, No. 372-7, Sec. 4, Zhongxing Rd., Zhudong Township, Hsinchu County, Taiwan

Telephone :+886-2-7737-3000

Facsimile (FAX) :+886-3-583-7948

Doc No: 17-EM-F0878 / 6.0



EUT Test Condition		Measurement Detail	
Channel	Channel 48	Frequency Range	1 GHz ~ 40 GHz

Antenna Polarity & Test Distance: Horizontal at 3 m							
Notation	Frequency	Reading	Correct	Result	Limit	Margin	Remark
	(MHz)	(dBuV)	dB/m	(dBuV/m)	(dBuV/m)	(dB)	
-	10480	31.36	17.69	49.05	68.2	-19.15	Peak
-	5097.65	30.7	13.46	44.16	54	-9.84	Average
@	5240	81.87	13.27	95.14	-	-	Average
-	5094.5	42.16	13.44	55.6	74	-18.4	Peak
@	5240	89.22	13.27	102.49	-	-	Peak
Antenna Polarity & Test Distance: Vertical at 3 m							
Notation	Frequency	Reading	Correct	Result	Limit	Margin	Remark
	(MHz)	(dBuV)	dB/m	(dBuV/m)	(dBuV/m)	(dB)	
-	10480	32.82	17.69	50.51	68.2	-17.69	Peak
-	5097.65	30.74	13.46	44.2	54	-9.8	Average
@	5240	75.85	13.27	89.12	-	-	Average
-	5096.6	41.63	13.45	55.08	74	-18.92	Peak
@	5240	84.23	13.27	97.5	-	-	Peak

Remarks:

1. Result value (dBuV/m) = Reading value (dBuV) + Correction Factor (dB/m).
2. Margin(dB) = Result value (dBuV/m) - Limit value (dBuV/m).
3. Correction Factor (dB/m) = Antenna Factor (dB/m) + Cable Loss (dB) - Preamp Factor (dB).
4. "@": Fundamental Frequency.
5. The other emission levels were very low against the limit.

Underwriters Laboratories Taiwan Co., Ltd.

Building B and Building E, No. 372-7, Sec. 4, Zhongxing Rd., Zhudong Township, Hsinchu County, Taiwan

Telephone :+886-2-7737-3000

Facsimile (FAX) :+886-3-583-7948

Doc No: 17-EM-F0878 / 6.0



EUT Test Condition		Measurement Detail	
Channel	Channel 149	Frequency Range	1 GHz ~ 40 GHz

Antenna Polarity & Test Distance: Horizontal at 3 m							
Notation	Frequency	Reading	Correct	Result	Limit	Margin	Remark
	(MHz)	(dBuV)	dB/m	(dBuV/m)	(dBuV/m)	(dB)	
*	11490	30.25	19.02	49.27	74	-24.73	Peak
-	5569.5	40.59	13.95	54.54	68.2	-13.66	Peak
-	5657	39.77	14	53.77	73.4	-19.63	Peak
@	5745	90.12	14.28	104.4	-	-	Peak
Antenna Polarity & Test Distance: Vertical at 3 m							
Notation	Frequency	Reading	Correct	Result	Limit	Margin	Remark
	(MHz)	(dBuV)	dB/m	(dBuV/m)	(dBuV/m)	(dB)	
*	11490	32.62	19.02	51.64	74	-22.36	Peak
-	5623	40.61	14.02	54.63	68.2	-13.57	Peak
-	5684	40	14.03	54.03	93.4	-39.37	Peak
@	5745	87.68	14.28	101.96	-	-	Peak

Remarks:

1. Result value (dBuV/m) = Reading value (dBuV) + Correction Factor (dB/m).
2. Margin(dB) = Result value (dBuV/m) - Limit value (dBuV/m).
3. Correction Factor (dB/m) = Antenna Factor (dB/m) + Cable Loss (dB) - Preamp Factor (dB).
4. "@": Fundamental Frequency.
5. "* * ": The peak result under 20 dB above and complies with AVG limit, AVG result is deemed to comply with AVG limit.
6. The other emission levels were very low against the limit.

Underwriters Laboratories Taiwan Co., Ltd.

Building B and Building E, No. 372-7, Sec. 4, Zhongxing Rd., Zhudong Township, Hsinchu County, Taiwan

Telephone :+886-2-7737-3000

Facsimile (FAX) :+886-3-583-7948

Doc No: 17-EM-F0878 / 6.0



EUT Test Condition		Measurement Detail	
Channel	Channel 157	Frequency Range	1 GHz ~ 40 GHz

Antenna Polarity & Test Distance: Horizontal at 3 m							
Notation	Frequency	Reading	Correct	Result	Limit	Margin	Remark
	(MHz)	(dBuV)	dB/m	(dBuV/m)	(dBuV/m)	(dB)	
*	11570	30.59	18.88	49.47	74	-24.53	Peak
-	5619	40.79	14.02	54.81	68.2	-13.39	Peak
-	5667	40.34	14.01	54.35	80.82	-26.47	Peak
@	5785	86.29	14.48	100.77	-	-	Peak
-	5907	40.21	14.97	55.18	81.48	-26.3	Peak
-	5974.5	40.11	15.09	55.2	68.2	-13	Peak
Antenna Polarity & Test Distance: Vertical at 3 m							
Notation	Frequency	Reading	Correct	Result	Limit	Margin	Remark
	(MHz)	(dBuV)	dB/m	(dBuV/m)	(dBuV/m)	(dB)	
*	11570	30.96	18.88	49.84	74	-24.16	Peak
-	5582.5	40.41	13.99	54.4	68.2	-13.8	Peak
-	5674	40.33	14.02	54.35	86	-31.65	Peak
@	5785	81.44	14.48	95.92	-	-	Peak
-	5883.5	41.4	14.92	56.32	98.89	-42.57	Peak
-	5998	40.82	15.17	55.99	68.2	-12.21	Peak

Remarks:

1. Result value (dBuV/m) = Reading value (dBuV) + Correction Factor (dB/m).
2. Margin(dB) = Result value (dBuV/m) - Limit value (dBuV/m).
3. Correction Factor (dB/m) = Antenna Factor (dB/m) + Cable Loss (dB) - Preamp Factor (dB).
4. "@": Fundamental Frequency.
5. " * ": The peak result under 20 dB above and complies with AVG limit, AVG result is deemed to comply with AVG limit.
6. The other emission levels were very low against the limit.

Underwriters Laboratories Taiwan Co., Ltd.

Building B and Building E, No. 372-7, Sec. 4, Zhongxing Rd., Zhudong Township, Hsinchu County, Taiwan

Telephone :+886-2-7737-3000

Facsimile (FAX) :+886-3-583-7948

Doc No: 17-EM-F0878 / 6.0



EUT Test Condition		Measurement Detail	
Channel	Channel 165	Frequency Range	1 GHz ~ 40 GHz

Antenna Polarity & Test Distance: Horizontal at 3 m							
Notation	Frequency	Reading	Correct	Result	Limit	Margin	Remark
	(MHz)	(dBuV)	dB/m	(dBuV/m)	(dBuV/m)	(dB)	
*	11650	31.06	18.63	49.69	74	-24.31	Peak
@	5825	86.68	14.69	101.37	-	-	Peak
-	5880	39.8	14.91	54.71	101.49	-46.78	Peak
-	6009	39.89	15.18	55.07	68.2	-13.13	Peak
Antenna Polarity & Test Distance: Vertical at 3 m							
Notation	Frequency	Reading	Correct	Result	Limit	Margin	Remark
	(MHz)	(dBuV)	dB/m	(dBuV/m)	(dBuV/m)	(dB)	
*	11650	31.18	18.63	49.81	74	-24.19	Peak
@	5825	83.45	14.69	98.14	-	-	Peak
-	5901	39.73	14.97	54.7	85.92	-31.22	Peak
-	5985	40.2	15.12	55.32	68.2	-12.88	Peak

Remarks:

1. Result value (dBuV/m) = Reading value (dBuV) + Correction Factor (dB/m).
2. Margin(dB) = Result value (dBuV/m) - Limit value (dBuV/m).
3. Correction Factor (dB/m) = Antenna Factor (dB/m) + Cable Loss (dB) - Preamp Factor (dB).
4. "@": Fundamental Frequency.
5. "* * ": The peak result under 20 dB above and complies with AVG limit, AVG result is deemed to comply with AVG limit.
6. The other emission levels were very low against the limit.

Underwriters Laboratories Taiwan Co., Ltd.

Building B and Building E, No. 372-7, Sec. 4, Zhongxing Rd., Zhudong Township, Hsinchu County, Taiwan

Telephone :+886-2-7737-3000

Facsimile (FAX) :+886-3-583-7948

Doc No: 17-EM-F0878 / 6.0



802.11ac (VHT40)

EUT Test Condition		Measurement Detail	
Channel	Channel 38	Frequency Range	1 GHz ~ 40 GHz

Antenna Polarity & Test Distance: Horizontal at 3 m							
Notation	Frequency	Reading	Correct	Result	Limit	Margin	Remark
	(MHz)	(dBuV)	dB/m	(dBuV/m)	(dBuV/m)	(dB)	
-	10380	30.72	17.49	48.21	68.2	-19.99	Peak
-	5148.4	39.45	13.42	52.87	54	-1.13	Average
@	5190	78.33	13.4	91.73	-	-	Average
-	5136.15	48.75	13.44	62.19	74	-11.81	Peak
@	5190	84.02	13.4	97.42	-	-	Peak
Antenna Polarity & Test Distance: Vertical at 3 m							
Notation	Frequency	Reading	Correct	Result	Limit	Margin	Remark
	(MHz)	(dBuV)	dB/m	(dBuV/m)	(dBuV/m)	(dB)	
-	10380	32.15	17.49	49.64	68.2	-18.56	Peak
-	5149.8	38.92	13.43	52.35	54	-1.65	Average
@	5190	75.13	13.4	88.53	-	-	Average
-	5144.9	53	13.43	66.43	74	-7.57	Peak
@	5190	84.06	13.4	97.46	-	-	Peak

Remarks:

1. Result value (dBuV/m) = Reading value (dBuV) + Correction Factor (dB/m).
2. Margin(dB) = Result value (dBuV/m) - Limit value (dBuV/m).
3. Correction Factor (dB/m) = Antenna Factor (dB/m) + Cable Loss (dB) - Preamp Factor (dB).
4. "@": Fundamental Frequency.
5. The other emission levels were very low against the limit.

Underwriters Laboratories Taiwan Co., Ltd.

Building B and Building E, No. 372-7, Sec. 4, Zhongxing Rd., Zhudong Township, Hsinchu County, Taiwan
Telephone :+886-2-7737-3000
Facsimile (FAX) :+886-3-583-7948



EUT Test Condition		Measurement Detail	
Channel	Channel 46	Frequency Range	1 GHz ~ 40 GHz

Antenna Polarity & Test Distance: Horizontal at 3 m							
Notation	Frequency	Reading	Correct	Result	Limit	Margin	Remark
	(MHz)	(dBuV)	dB/m	(dBuV/m)	(dBuV/m)	(dB)	
-	10460	31.16	17.66	48.82	68.2	-19.38	Peak
-	5149.45	31.87	13.43	45.3	54	-8.7	Average
@	5230	79.22	13.3	92.52	-	-	Average
-	5144.2	42.23	13.43	55.66	74	-18.34	Peak
@	5230	86.36	13.3	99.66	-	-	Peak
Antenna Polarity & Test Distance: Vertical at 3 m							
Notation	Frequency	Reading	Correct	Result	Limit	Margin	Remark
	(MHz)	(dBuV)	dB/m	(dBuV/m)	(dBuV/m)	(dB)	
-	10460	31.33	17.66	48.99	68.2	-19.21	Peak
-	5147.7	31.54	13.42	44.96	54	-9.04	Average
@	5230	72.23	13.3	85.53	-	-	Average
-	5139.65	41.89	13.43	55.32	74	-18.68	Peak
@	5230	81.15	13.3	94.45	-	-	Peak

Remarks:

1. Result value (dBuV/m) = Reading value (dBuV) + Correction Factor (dB/m).
2. Margin(dB) = Result value (dBuV/m) - Limit value (dBuV/m).
3. Correction Factor (dB/m) = Antenna Factor (dB/m) + Cable Loss (dB) - Preamp Factor (dB).
4. "@": Fundamental Frequency.
5. The other emission levels were very low against the limit.

Underwriters Laboratories Taiwan Co., Ltd.

Building B and Building E, No. 372-7, Sec. 4, Zhongxing Rd., Zhudong Township, Hsinchu County, Taiwan

Telephone :+886-2-7737-3000

Facsimile (FAX) :+886-3-583-7948

Doc No: 17-EM-F0878 / 6.0



EUT Test Condition		Measurement Detail	
Channel	Channel 151	Frequency Range	1 GHz ~ 40 GHz

Antenna Polarity & Test Distance: Horizontal at 3 m							
Notation	Frequency	Reading	Correct	Result	Limit	Margin	Remark
	(MHz)	(dBuV)	dB/m	(dBuV/m)	(dBuV/m)	(dB)	
*	11510	31.85	19.03	50.88	74	-23.12	Peak
-	5556.5	40.91	13.9	54.81	68.2	-13.39	Peak
-	5693.5	41.41	14.05	55.46	100.41	-44.95	Peak
@	5755	88.08	14.33	102.41	-	-	Peak
Antenna Polarity & Test Distance: Vertical at 3 m							
Notation	Frequency	Reading	Correct	Result	Limit	Margin	Remark
	(MHz)	(dBuV)	dB/m	(dBuV/m)	(dBuV/m)	(dB)	
*	11510	30.61	19.03	49.64	74	-24.36	Peak
-	5616.5	40.76	14.03	54.79	68.2	-13.41	Peak
-	5671	40.55	14.02	54.57	83.78	-29.21	Peak
@	5755	84.32	14.33	98.65	-	-	Peak

Remarks:

1. Result value (dBuV/m) = Reading value (dBuV) + Correction Factor (dB/m).
2. Margin(dB) = Result value (dBuV/m) - Limit value (dBuV/m).
3. Correction Factor (dB/m) = Antenna Factor (dB/m) + Cable Loss (dB) - Preamp Factor (dB).
4. "@": Fundamental Frequency.
5. "* * ": The peak result under 20 dB above and complies with AVG limit, AVG result is deemed to comply with AVG limit.
6. The other emission levels were very low against the limit.

Underwriters Laboratories Taiwan Co., Ltd.

Building B and Building E, No. 372-7, Sec. 4, Zhongxing Rd., Zhudong Township, Hsinchu County, Taiwan

Telephone :+886-2-7737-3000

Facsimile (FAX) :+886-3-583-7948

Doc No: 17-EM-F0878 / 6.0



EUT Test Condition		Measurement Detail	
Channel	Channel 159	Frequency Range	1 GHz ~ 40 GHz

Antenna Polarity & Test Distance: Horizontal at 3 m							
Notation	Frequency	Reading	Correct	Result	Limit	Margin	Remark
	(MHz)	(dBuV)	dB/m	(dBuV/m)	(dBuV/m)	(dB)	
*	11590	30.14	18.84	48.98	74	-25.02	Peak
@	5795	86.81	14.53	101.34	-	-	Peak
-	5893	39.89	14.95	54.84	91.84	-37	Peak
-	5950.5	41.61	15.02	56.63	68.2	-11.57	Peak
Antenna Polarity & Test Distance: Vertical at 3 m							
Notation	Frequency	Reading	Correct	Result	Limit	Margin	Remark
	(MHz)	(dBuV)	dB/m	(dBuV/m)	(dBuV/m)	(dB)	
*	11590	30.58	18.84	49.42	74	-24.58	Peak
@	5795	78.84	14.53	93.37	-	-	Peak
-	5914	40.84	14.98	55.82	76.31	-20.49	Peak
-	5980	41.44	15.11	56.55	68.2	-11.65	Peak

Remarks:

1. Result value (dBuV/m) = Reading value (dBuV) + Correction Factor (dB/m).
2. Margin(dB) = Result value (dBuV/m) - Limit value (dBuV/m).
3. Correction Factor (dB/m) = Antenna Factor (dB/m) + Cable Loss (dB) - Preamp Factor (dB).
4. "@": Fundamental Frequency.
5. "* * ": The peak result under 20 dB above and complies with AVG limit, AVG result is deemed to comply with AVG limit.
6. The other emission levels were very low against the limit.

Underwriters Laboratories Taiwan Co., Ltd.

Building B and Building E, No. 372-7, Sec. 4, Zhongxing Rd., Zhudong Township, Hsinchu County, Taiwan

Telephone :+886-2-7737-3000

Facsimile (FAX) :+886-3-583-7948

Doc No: 17-EM-F0878 / 6.0



802.11ac (VHT80)

EUT Test Condition		Measurement Detail	
Channel	Channel 42	Frequency Range	1 GHz ~ 40 GHz

Antenna Polarity & Test Distance: Horizontal at 3 m							
Notation	Frequency	Reading	Correct	Result	Limit	Margin	Remark
	(MHz)	(dBuV)	dB/m	(dBuV/m)	(dBuV/m)	(dB)	
-	10420	30.42	17.6	48.02	68.2	-20.18	Peak
-	5147	39.31	13.43	52.74	54	-1.26	Average
@	5210	76.98	13.36	90.34	-	-	Average
-	5130.9	49.03	13.44	62.47	74	-11.53	Peak
@	5210	83.21	13.36	96.57	-	-	Peak
Antenna Polarity & Test Distance: Vertical at 3 m							
Notation	Frequency	Reading	Correct	Result	Limit	Margin	Remark
	(MHz)	(dBuV)	dB/m	(dBuV/m)	(dBuV/m)	(dB)	
-	10420	31.2	17.6	48.8	68.2	-19.4	Peak
-	5149.8	38.11	13.43	51.54	54	-2.46	Average
@	5210	72.68	13.36	86.04	-	-	Average
-	5148.75	51.77	13.42	65.19	74	-8.81	Peak
@	5210	78.97	13.36	92.33	-	-	Peak

Remarks:

1. Result value (dBuV/m) = Reading value (dBuV) + Correction Factor (dB/m).
2. Margin(dB) = Result value (dBuV/m) - Limit value (dBuV/m).
3. Correction Factor (dB/m) = Antenna Factor (dB/m) + Cable Loss (dB) - Preamp Factor (dB).
4. "@": Fundamental Frequency.
5. The other emission levels were very low against the limit.

Underwriters Laboratories Taiwan Co., Ltd.

Building B and Building E, No. 372-7, Sec. 4, Zhongxing Rd., Zhudong Township, Hsinchu County, Taiwan
Telephone :+886-2-7737-3000
Facsimile (FAX) :+886-3-583-7948



EUT Test Condition		Measurement Detail	
Channel	Channel 155	Frequency Range	1 GHz ~ 40 GHz

Antenna Polarity & Test Distance: Horizontal at 3 m							
Notation	Frequency	Reading	Correct	Result	Limit	Margin	Remark
	(MHz)	(dBuV)	dB/m	(dBuV/m)	(dBuV/m)	(dB)	
*	11550	29.64	18.93	48.57	74	-25.43	Peak
-	5590	40.47	14.02	54.49	68.2	-13.71	Peak
-	5699.5	42.92	14.05	56.97	104.83	-47.86	Peak
@	5775	81.59	14.44	96.03	-	-	Peak
-	5924	41.32	14.99	56.31	68.94	-12.63	Peak
-	6001	41.27	15.17	56.44	68.2	-11.76	Peak
Antenna Polarity & Test Distance: Vertical at 3 m							
Notation	Frequency	Reading	Correct	Result	Limit	Margin	Remark
	(MHz)	(dBuV)	dB/m	(dBuV/m)	(dBuV/m)	(dB)	
*	11550	29.79	18.93	48.72	74	-25.28	Peak
-	5619	40.28	14.02	54.3	68.2	-13.9	Peak
-	5658	40.76	14	54.76	74.14	-19.38	Peak
@	5775	79.94	14.44	94.38	-	-	Peak
-	5882	39.63	14.91	54.54	100	-45.46	Peak
-	5988.5	40.09	15.14	55.23	68.2	-12.97	Peak

Remarks:

1. Result value (dBuV/m) = Reading value (dBuV) + Correction Factor (dB/m).
2. Margin(dB) = Result value (dBuV/m) - Limit value (dBuV/m).
3. Correction Factor (dB/m) = Antenna Factor (dB/m) + Cable Loss (dB) - Preamp Factor (dB).
4. "@": Fundamental Frequency.
5. " * ": The peak result under 20 dB above and complies with AVG limit, AVG result is deemed to comply with AVG limit.
6. The other emission levels were very low against the limit.

Underwriters Laboratories Taiwan Co., Ltd.

Building B and Building E, No. 372-7, Sec. 4, Zhongxing Rd., Zhudong Township, Hsinchu County, Taiwan

Telephone :+886-2-7737-3000

Facsimile (FAX) :+886-3-583-7948

Doc No: 17-EM-F0878 / 6.0



9 kHz ~ 30 MHz Data:

For 9 kHz to 30 MHz radiated emission have performed all modes of operation were investigated. The amplitude of spurious emissions attenuated more than 20 dB below the permissible value is not required to be report.

No non-compliance noted:

KDB 414788 D01 OATS and Chamber Correlation Justification

- Base on FCC 15.31 (f) (2): measurements may be performed at a distance closer than that specified in the regulations; however, an attempt should be made to avoid making measurements in the near field.

- OATs and chamber correlation testing had been performed and chamber measured test results is the worst case test result.

Although these tests were performed other than open area test site, adequate comparison measurements were confirmed against 30m open area test site. Therefore sufficient tests were made to demonstrate that the alternative site produces results that correlate with the ones of tests made in an open field based on KDB 414788.

Underwriters Laboratories Taiwan Co., Ltd.

Building B and Building E, No. 372-7, Sec. 4, Zhongxing Rd., Zhudong Township, Hsinchu County, Taiwan

Telephone :+886-2-7737-3000

Facsimile (FAX) :+886-3-583-7948

Doc No: 17-EM-F0878 / 6.0



30 MHz ~ 1 GHz Data

802.11a

EUT Test Condition		Measurement Detail	
Channel	Channel 44	Frequency Range	30 MHz ~ 1 GHz

Horizontal

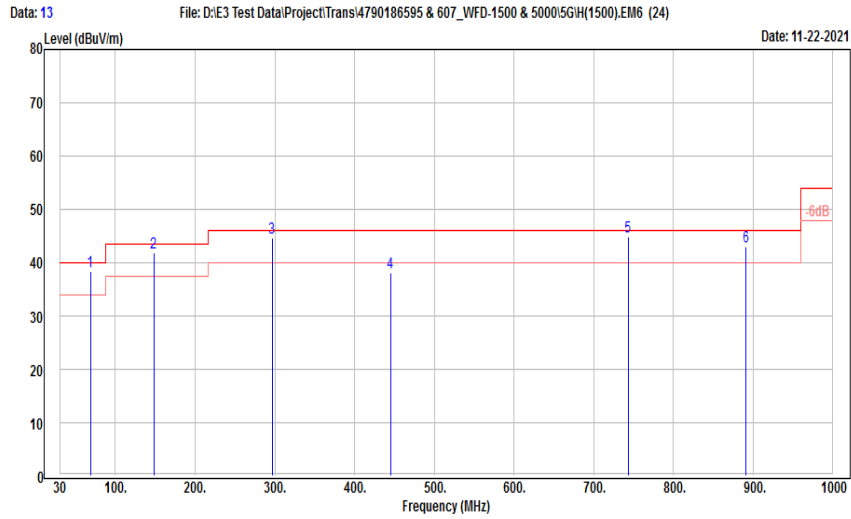

Vertical

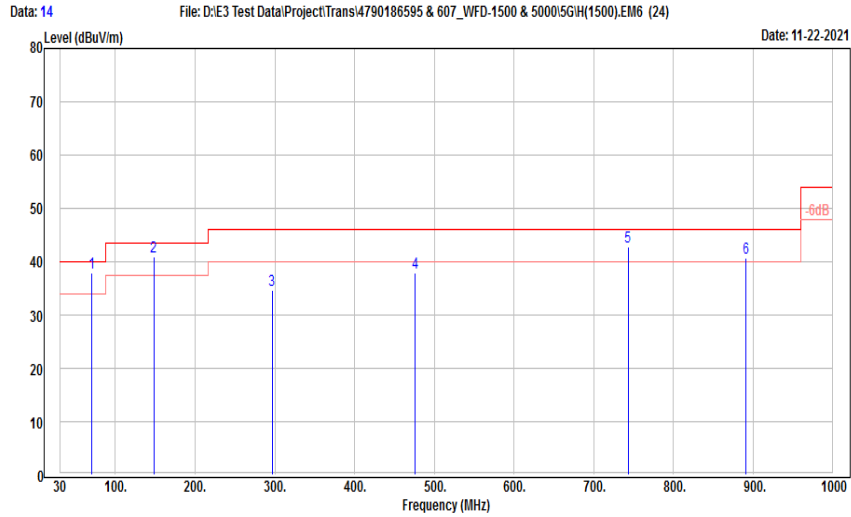

Underwriters Laboratories Taiwan Co., Ltd.

Building B and Building E, No. 372-7, Sec. 4, Zhongxing Rd., Zhudong Township, Hsinchu County, Taiwan

Telephone : +886-2-7737-3000

Facsimile (FAX) : +886-3-583-7948



Antenna Polarity & Test Distance: Horizontal at 3 m							
Notation	Frequency	Reading	Correct	Result	Limit	Margin	Remark
	(MHz)	(dBuV)	dB/m	(dBuV/m)	(dBuV/m)	(dB)	
-	68.8	52.11	-13.76	38.35	40	-1.65	QP
-	148.34	53.4	-11.54	41.86	43.5	-1.64	QP
-	296.75	54.8	-10.08	44.72	46	-1.28	QP
-	445.16	43.97	-5.79	38.18	46	-7.82	Peak
-	742.95	44.46	0.38	44.84	46	-1.16	Peak
-	891.36	40.52	2.58	43.1	46	-2.9	Peak
Antenna Polarity & Test Distance: Vertical at 3 m							
Notation	Frequency	Reading	Correct	Result	Limit	Margin	Remark
	(MHz)	(dBuV)	dB/m	(dBuV/m)	(dBuV/m)	(dB)	
-	70.74	52.2	-14.25	37.95	40	-2.05	QP
-	148.34	52.56	-11.54	41.02	43.5	-2.48	Peak
-	296.75	44.7	-10.08	34.62	46	-11.38	Peak
-	476.2	43.02	-5.14	37.88	46	-8.12	Peak
-	742.95	42.41	0.38	42.79	46	-3.21	Peak
-	891.36	38.21	2.58	40.79	46	-5.21	Peak

Remarks:

1. Result value (dBuV/m) = Reading value (dBuV) + Correction Factor (dB/m).
2. Margin(dB) = Result value (dBuV/m) - Limit value (dBuV/m).
3. Correction Factor (dB/m) = Antenna Factor (dB/m) + Cable Loss (dB) - Preamp Factor (dB).
4. The peak result complies with QP limit, QP result is deemed to comply with QP limit.
5. The other emission levels were very low against the limit.

Underwriters Laboratories Taiwan Co., Ltd.

Building B and Building E, No. 372-7, Sec. 4, Zhongxing Rd., Zhudong Township, Hsinchu County, Taiwan

Telephone :+886-2-7737-3000

Facsimile (FAX) :+886-3-583-7948

Doc No: 17-EM-F0878 / 6.0



9.8. AC Power Line Conducted Emission

Requirements

Frequency (MHz)	Conducted limit (dB μ V)	
	Quasi-peak	Average
0.15 - 0.5	66 - 56	56 - 46
0.50 - 5.0	56	46
5.0 - 30	60	50

Note:

1. The lower limit shall apply at the transition frequencies.
2. The limit decreases in line with the logarithm of the frequency in the range of 0.15 to 0.50MHz.

Test Procedures

- a. The EUT was placed 0.4 meters from the conducting wall of the shielded room with EUT being connected to the power mains through a line impedance stabilization network (LISN). Other support units were connected to the power mains through another LISN. The two LISNs provide 50 ohm/ 50uH of coupling impedance for the measuring instrument.
- b. Both lines of the power mains connected to the EUT were checked for maximum conducted interference.
- c. The frequency range from 150kHz to 30MHz was searched. Emission levels under (Limit - 20dB) was not recorded.

NOTE:

1. The resolution bandwidth and video bandwidth of test receiver is 9kHz for quasi-peak detection (QP) and average detection (AV) at frequency 0.15MHz-30MHz.
2. All modes of operation were investigated (includes all external accessories) and the worst-case emissions are reported, the other emission levels were low against the limit.
3. Test data of Result value (dBuV) = Reading value (dBuV) + Correction Factor (dB).
4. Test data of Margin(dB) = Result value (dBuV) - Limit value (dBuV).
5. Test data of Correction Factor (dB) = Insertion loss(dB) + Cable loss(dB).

Underwriters Laboratories Taiwan Co., Ltd.

Building B and Building E, No. 372-7, Sec. 4, Zhongxing Rd., Zhudong Township, Hsinchu County, Taiwan
Telephone :+886-2-7737-3000
Facsimile (FAX) :+886-3-583-7948



Test Setup

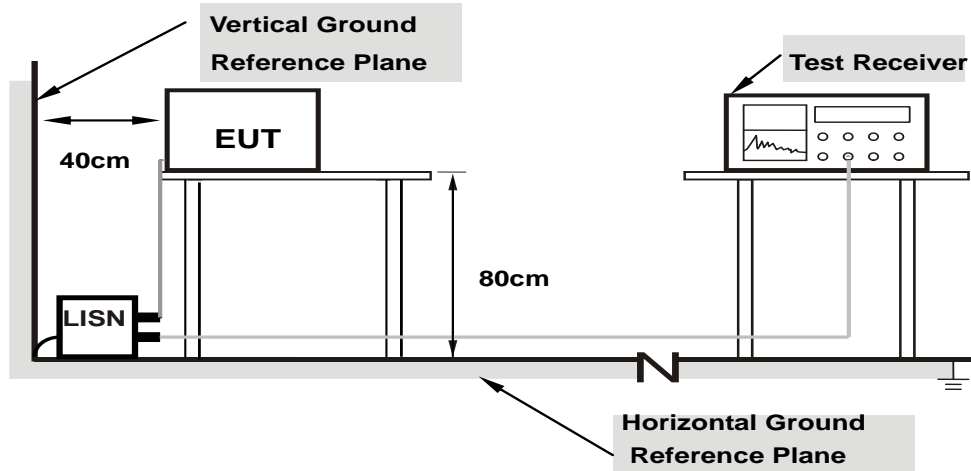

Note: 1.Support units were connected to second LISN.

For the actual test configuration, please refer to the Setup Configurations.

Underwriters Laboratories Taiwan Co., Ltd.

Building B and Building E, No. 372-7, Sec. 4, Zhongxing Rd., Zhudong Township, Hsinchu County, Taiwan

Telephone :+886-2-7737-3000

Facsimile (FAX) :+886-3-583-7948

Doc No: 17-EM-F0878 / 6.0



Test Data

Mode	11a_TX	Channel	44
------	--------	---------	----

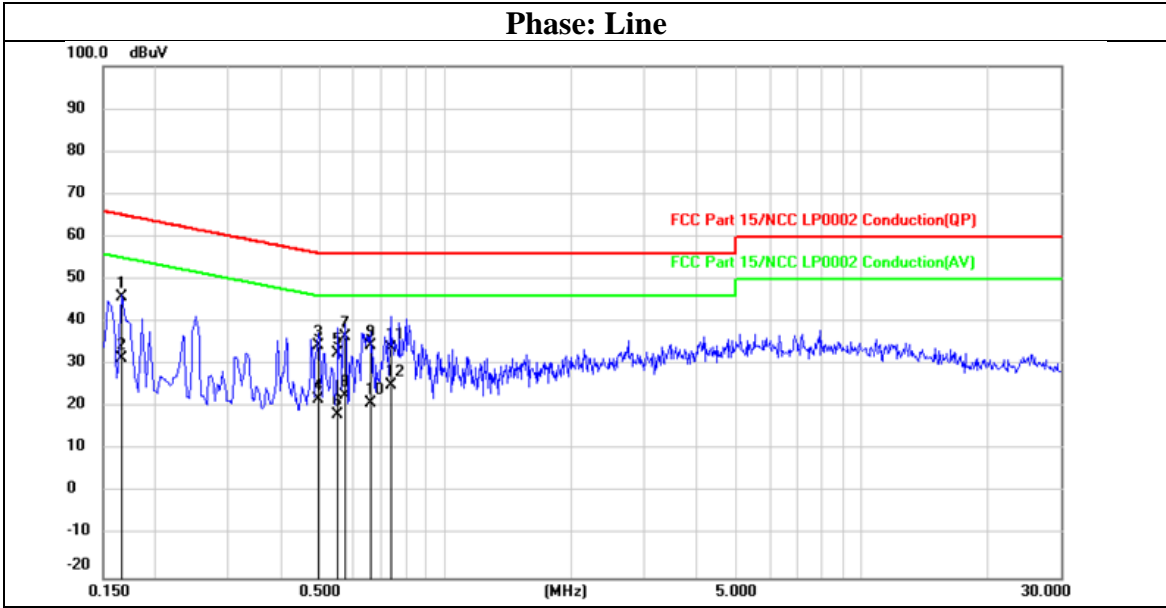

No.	Frequency (MHz)	Reading (dBuV)	Correct (dB)	Result (dBuV)	Limit (dBuV)	Margin (dB)	Remark
1	0.1660	26.30	19.49	45.79	65.16	-19.37	QP
2	0.1660	11.93	19.49	31.42	55.16	-23.74	AVG
3	0.4940	14.86	19.49	34.35	56.10	-21.75	QP
4	0.4940	2.31	19.49	21.80	46.10	-24.30	AVG
5	0.5500	13.17	19.50	32.67	56.00	-23.33	QP
6	0.5500	-1.13	19.50	18.37	46.00	-27.63	AVG
7	0.5740	17.11	19.50	36.61	56.00	-19.39	QP
8	0.5740	3.32	19.50	22.82	46.00	-23.18	AVG
9	0.6580	15.07	19.50	34.57	56.00	-21.43	QP
10	0.6580	1.60	19.50	21.10	46.00	-24.90	AVG
11	0.7380	14.44	19.51	33.95	56.00	-22.05	QP
12	0.7380	5.59	19.51	25.10	46.00	-20.90	AVG

Underwriters Laboratories Taiwan Co., Ltd.

Building B and Building E, No. 372-7, Sec. 4, Zhongxing Rd., Zhudong Township, Hsinchu County, Taiwan

Telephone :+886-2-7737-3000

Facsimile (FAX) :+886-3-583-7948



Mode 11a_TX Channel 44

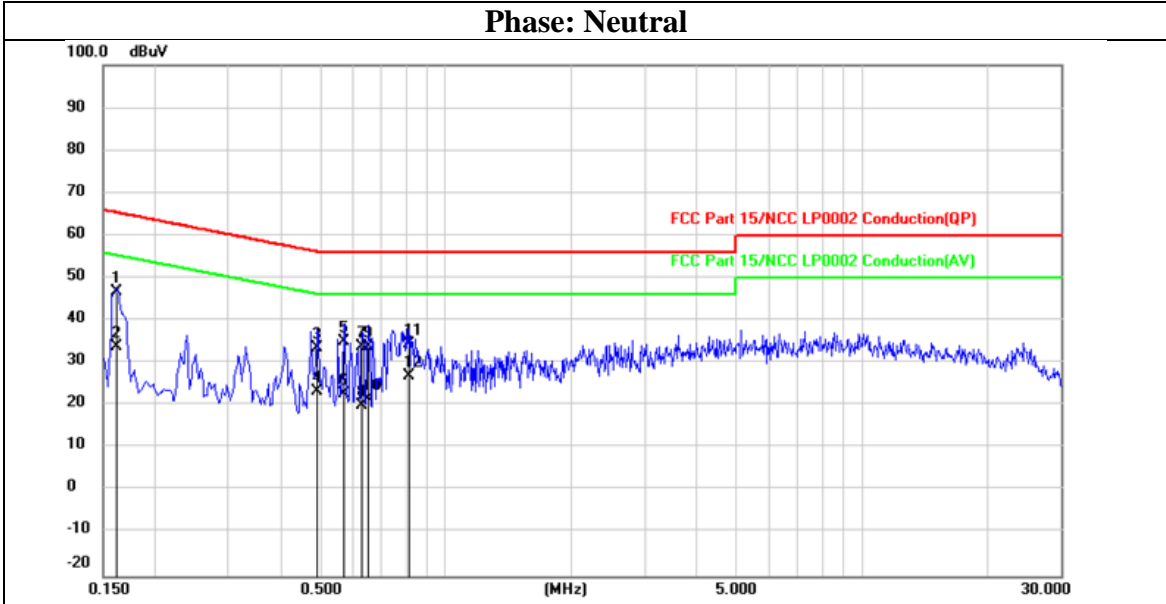

No.	Frequency (MHz)	Reading (dBuV)	Correct (dB)	Result (dBuV)	Limit (dBuV)	Margin (dB)	Remark
1	0.1620	27.18	19.49	46.67	65.36	-18.69	QP
2	0.1620	14.21	19.49	33.70	55.36	-21.66	AVG
3	0.4900	14.13	19.49	33.62	56.17	-22.55	QP
4	0.4900	3.84	19.49	23.33	46.17	-22.84	AVG
5	0.5700	15.65	19.50	35.15	56.00	-20.85	QP
6	0.5700	3.31	19.50	22.81	46.00	-23.19	AVG
7	0.6300	14.37	19.50	33.87	56.00	-22.13	QP
8	0.6300	0.61	19.50	20.11	46.00	-25.89	AVG
9	0.6500	14.22	19.50	33.72	56.00	-22.28	QP
10	0.6500	1.99	19.50	21.49	46.00	-24.51	AVG
11	0.8139	14.82	19.51	34.33	56.00	-21.67	QP
12	0.8139	7.39	19.51	26.90	46.00	-19.10	AVG

Underwriters Laboratories Taiwan Co., Ltd.

Building B and Building E, No. 372-7, Sec. 4, Zhongxing Rd., Zhudong Township, Hsinchu County, Taiwan

Telephone :+886-2-7737-3000

Facsimile (FAX) :+886-3-583-7948

Doc No: 17-EM-F0878 / 6.0



Appendix I Radiated Band Edge and OOB Measurement

802.11a

Peak

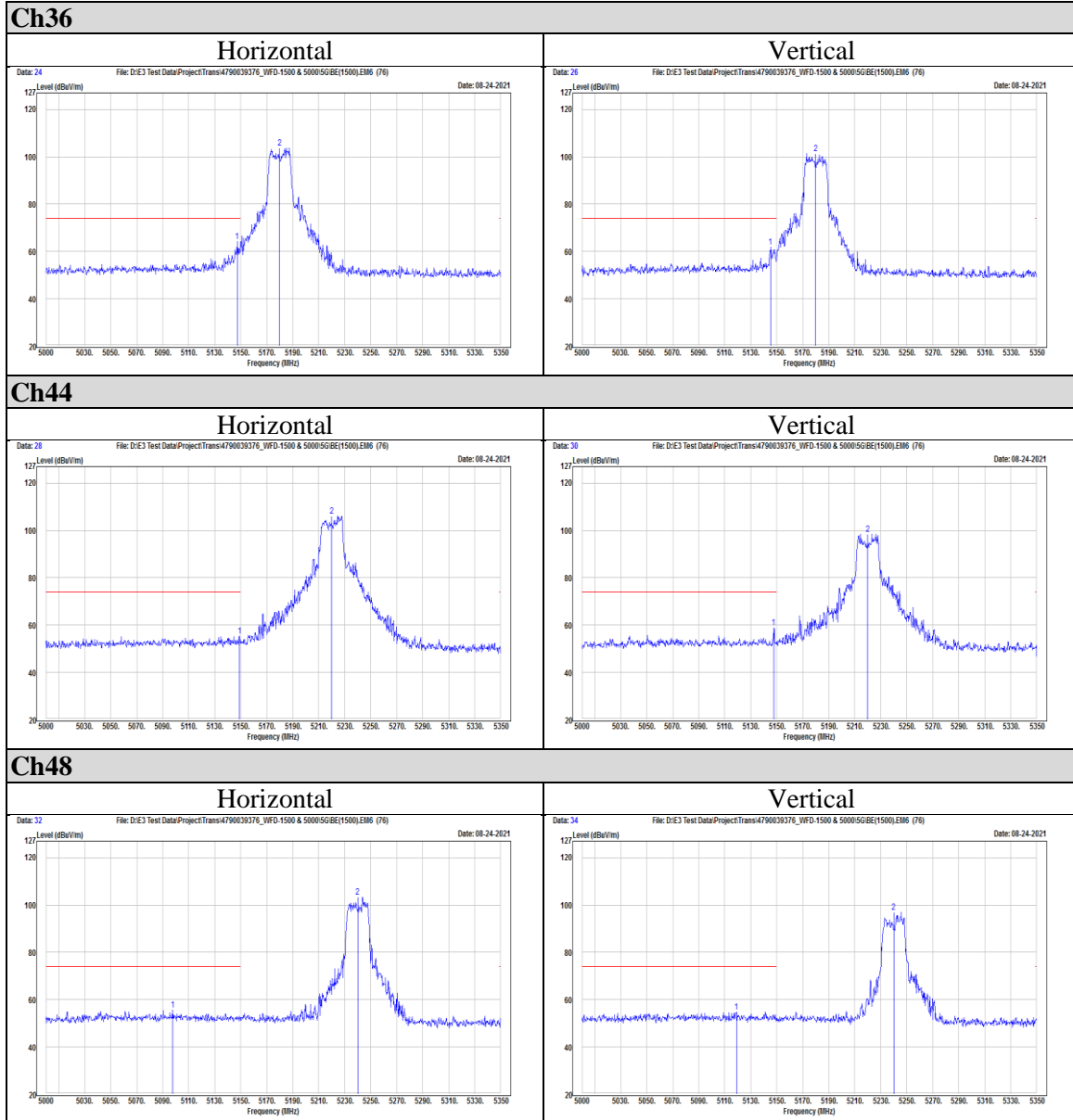

Underwriters Laboratories Taiwan Co., Ltd.

Building B and Building E, No. 372-7, Sec. 4, Zhongxing Rd., Zhudong Township, Hsinchu County, Taiwan

Telephone : +886-2-7737-3000

Facsimile (FAX) : +886-3-583-7948

Doc No: 17-EM-F0878 / 6.0

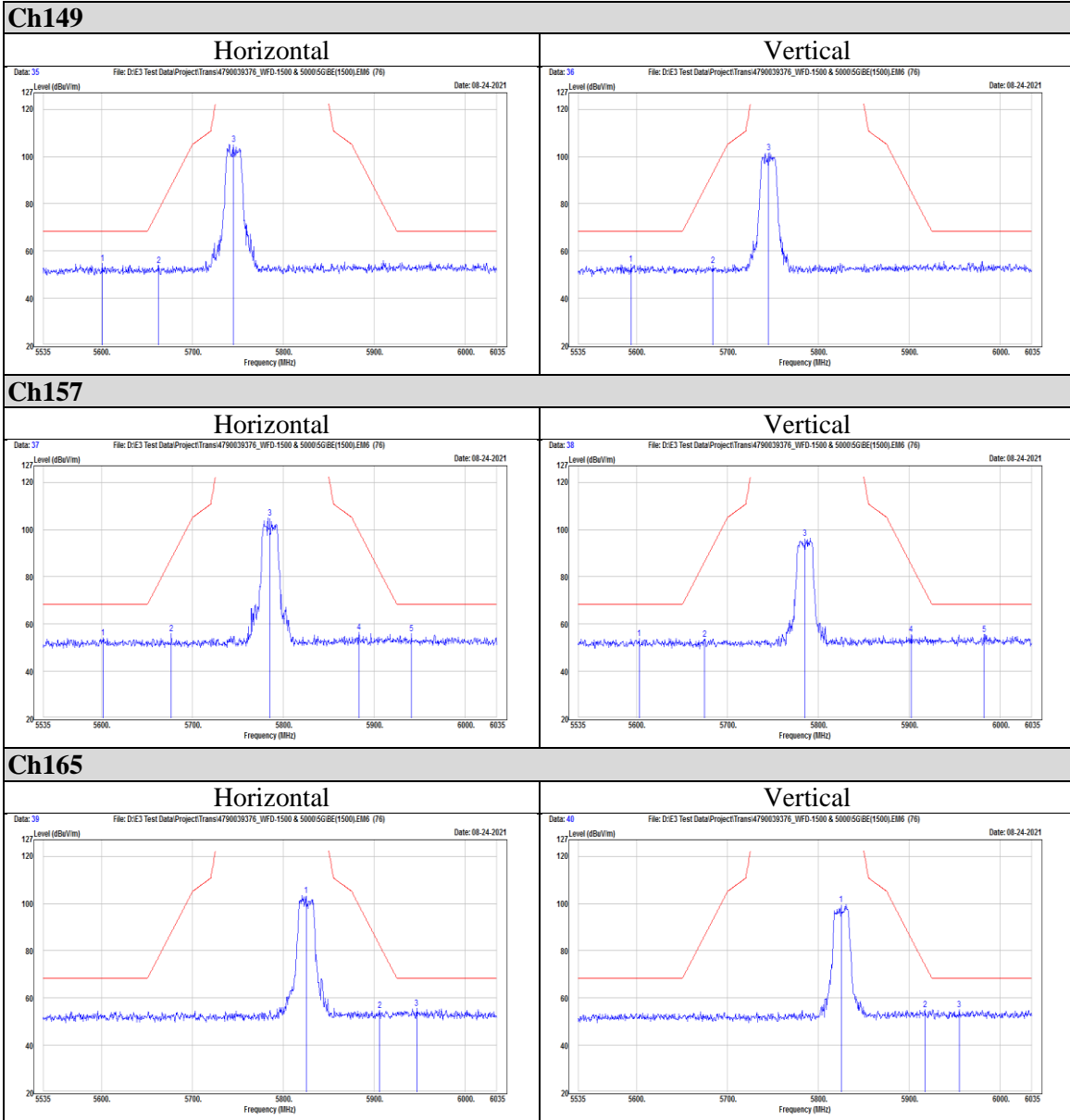



Average

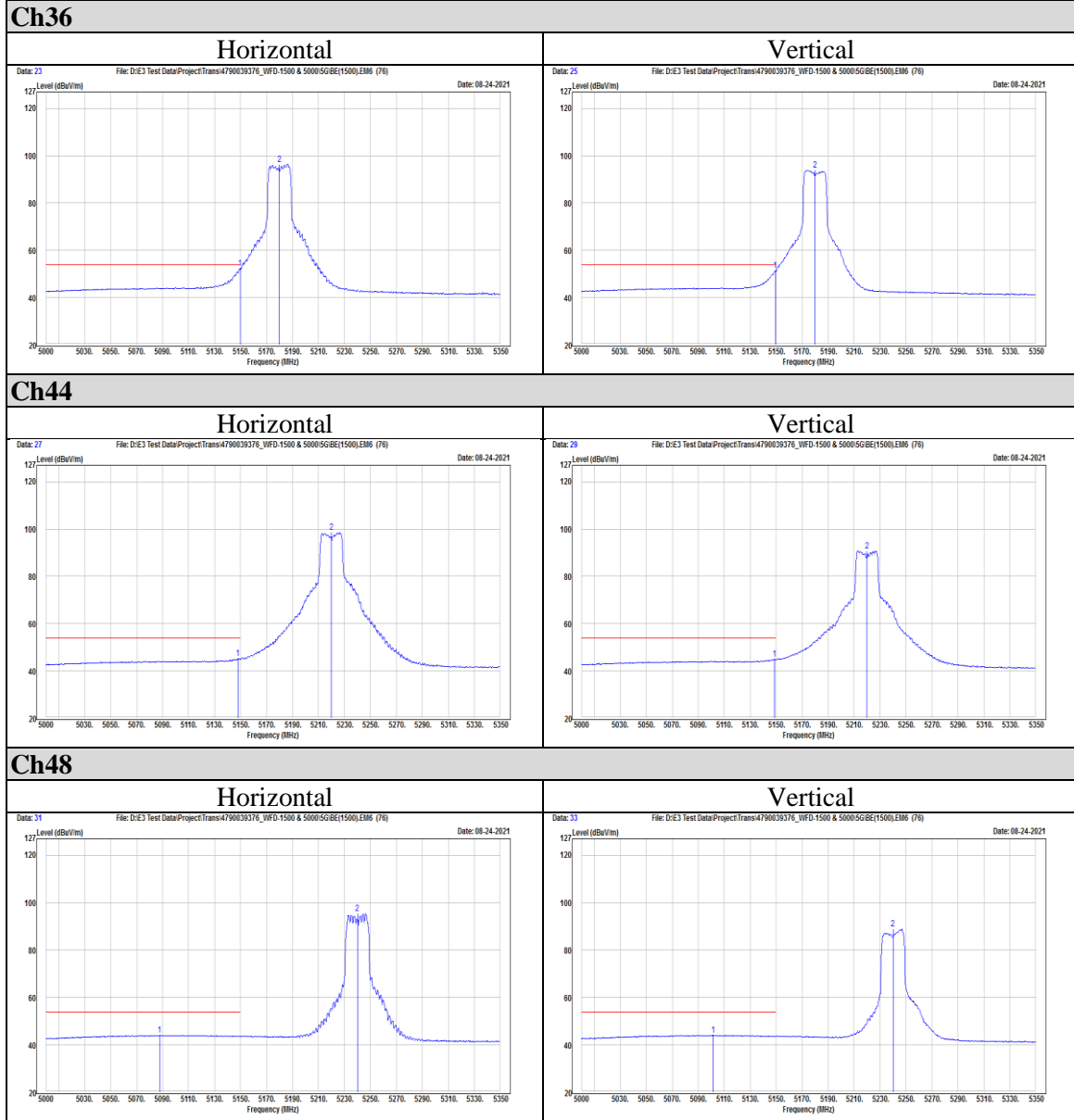

Underwriters Laboratories Taiwan Co., Ltd.

Building B and Building E, No. 372-7, Sec. 4, Zhongxing Rd., Zhudong Township, Hsinchu County, Taiwan

Telephone : +886-2-7737-3000

Facsimile (FAX) : +886-3-583-7948

Doc No: 17-EM-F0878 / 6.0



802.11ac (VHT20)

Peak

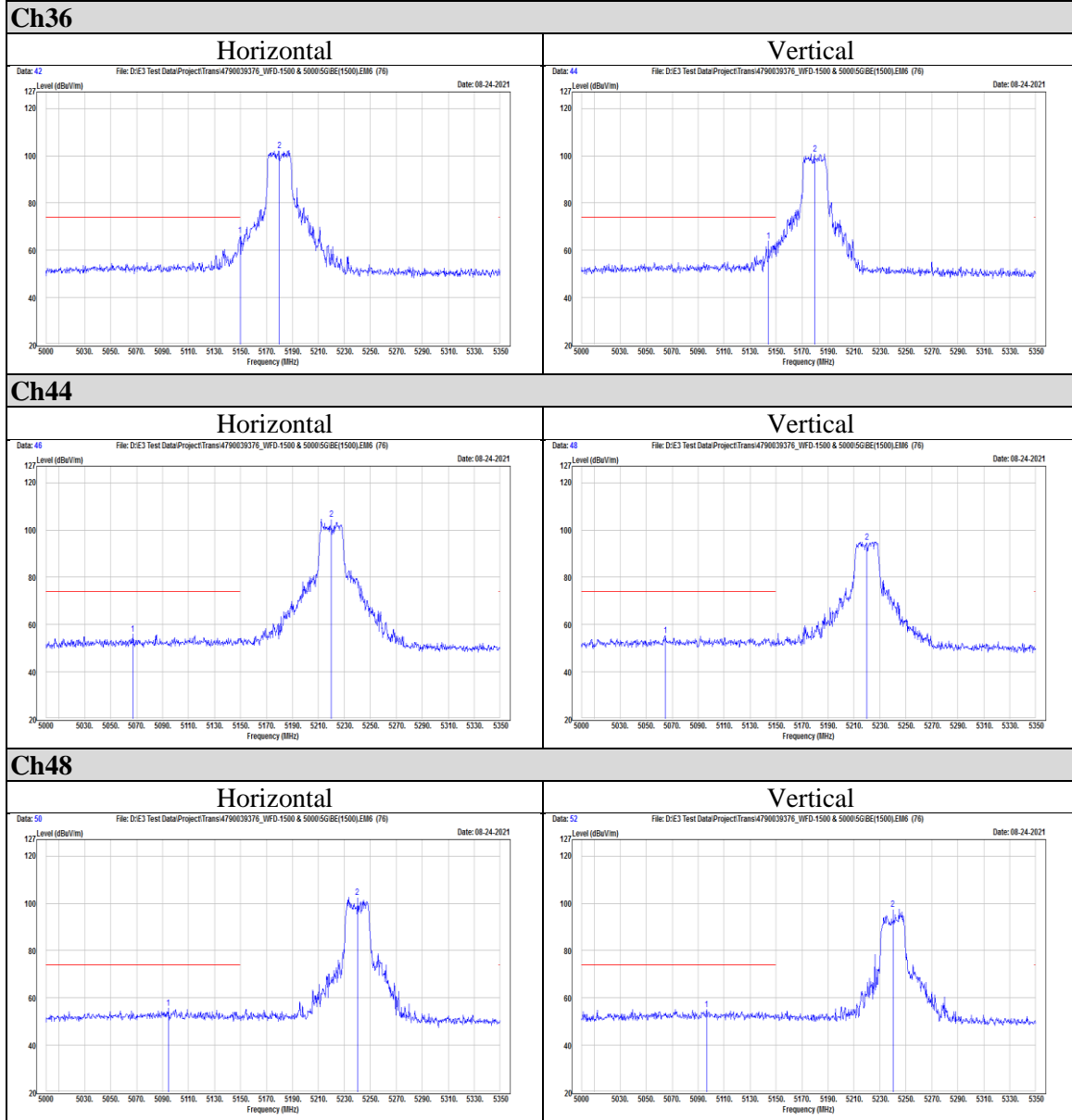

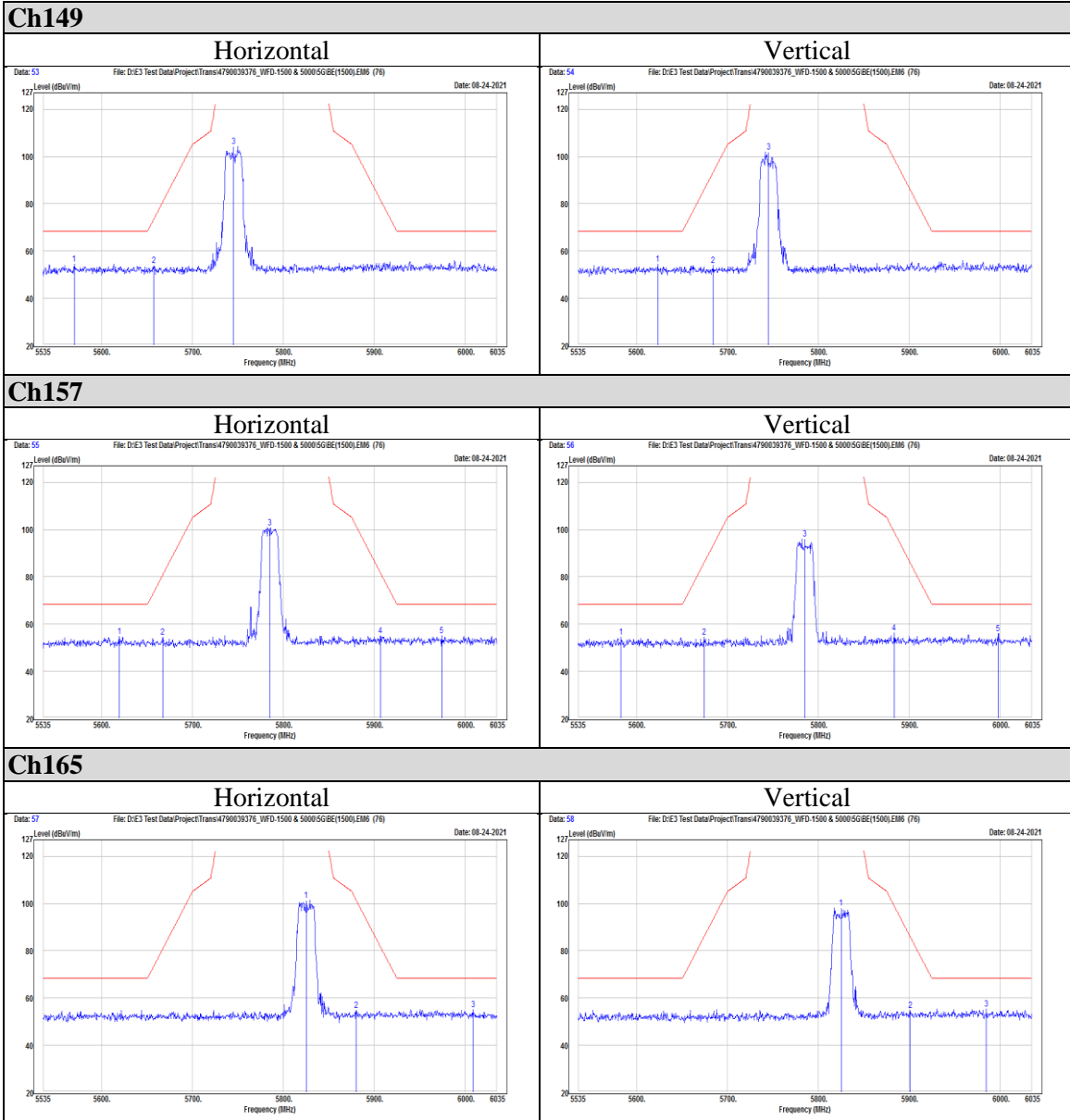



Average

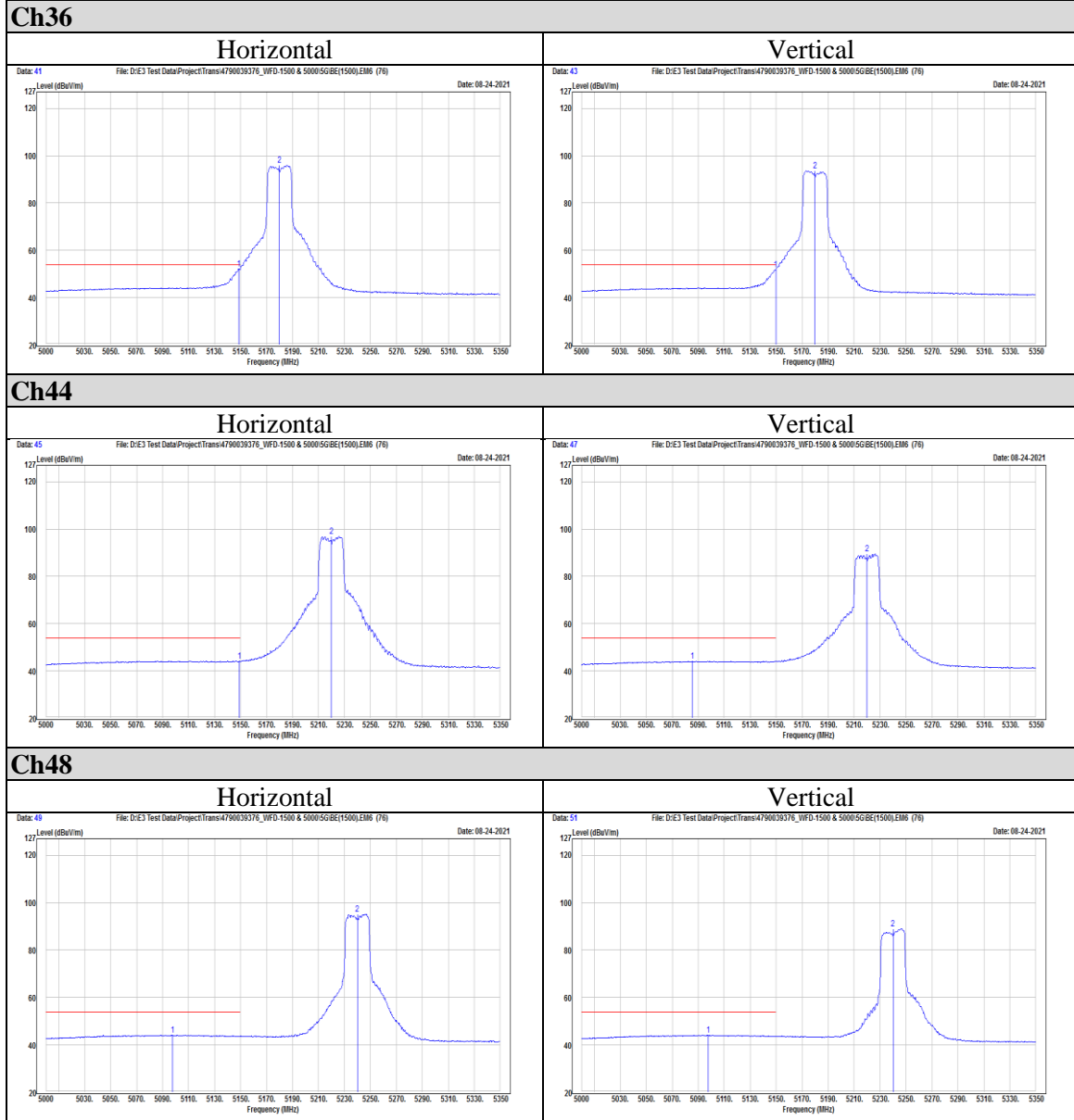

Underwriters Laboratories Taiwan Co., Ltd.

Building B and Building E, No. 372-7, Sec. 4, Zhongxing Rd., Zhudong Township, Hsinchu County, Taiwan

Telephone : +886-2-7737-3000

Facsimile (FAX) : +886-3-583-7948



802.11ac (VHT40)

Peak

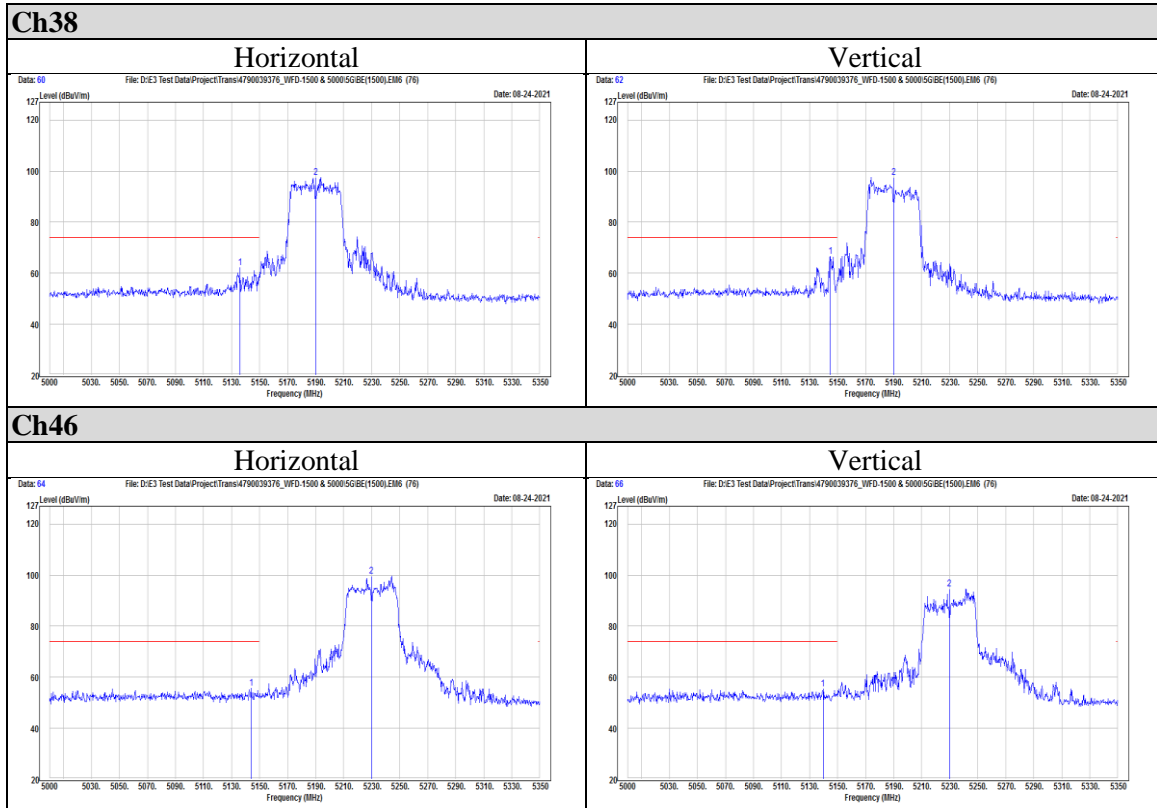

Underwriters Laboratories Taiwan Co., Ltd.

Building B and Building E, No. 372-7, Sec. 4, Zhongxing Rd., Zhudong Township, Hsinchu County, Taiwan

Telephone : +886-2-7737-3000

Facsimile (FAX) : +886-3-583-7948

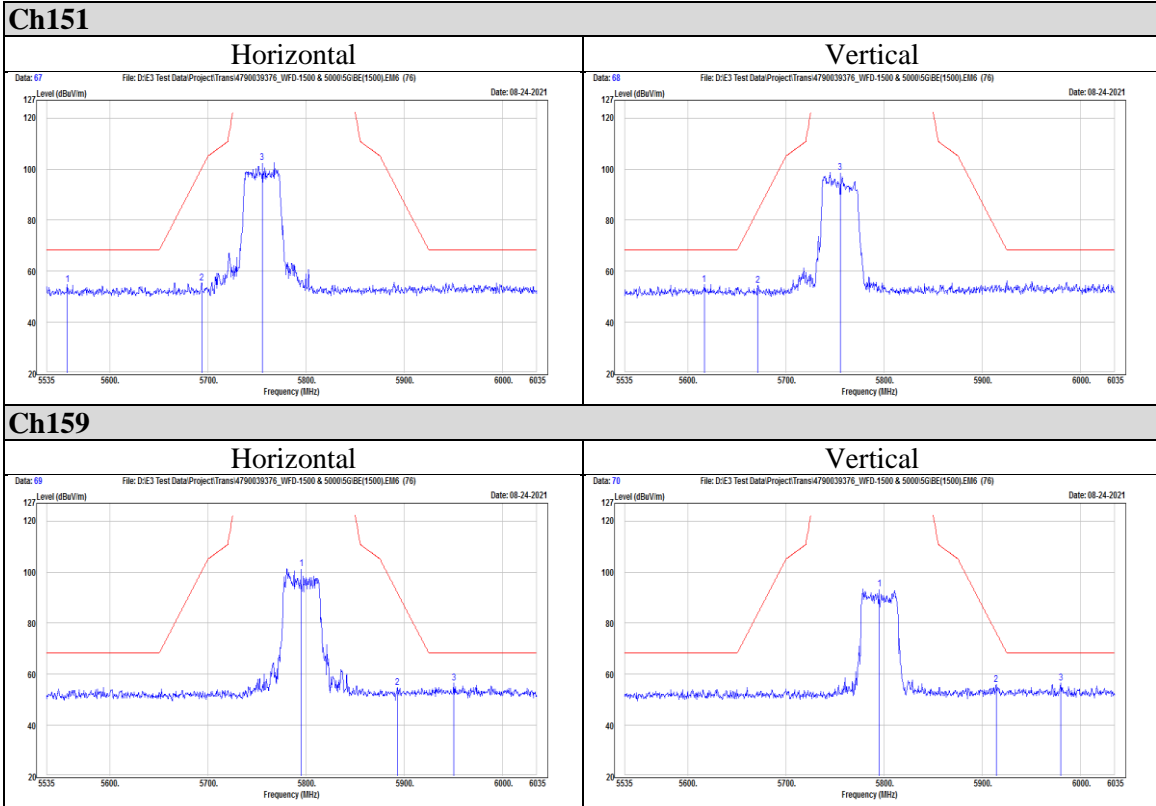

Underwriters Laboratories Taiwan Co., Ltd.

Building B and Building E, No. 372-7, Sec. 4, Zhongxing Rd., Zhudong Township, Hsinchu County, Taiwan

Telephone : +886-2-7737-3000

Facsimile (FAX) : +886-3-583-7948



Average

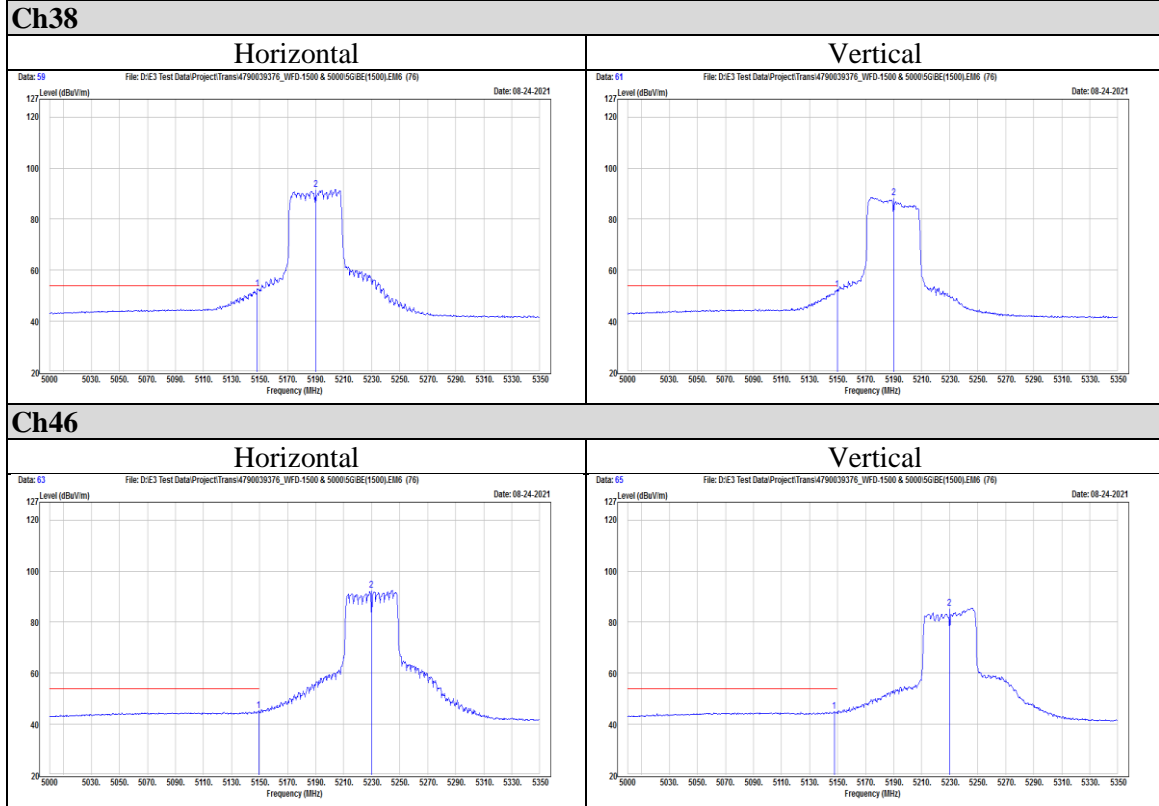

Underwriters Laboratories Taiwan Co., Ltd.

Building B and Building E, No. 372-7, Sec. 4, Zhongxing Rd., Zhudong Township, Hsinchu County, Taiwan

Telephone : +886-2-7737-3000

Facsimile (FAX) : +886-3-583-7948

Doc No: 17-EM-F0878 / 6.0



802.11ac (VHT80)

Peak

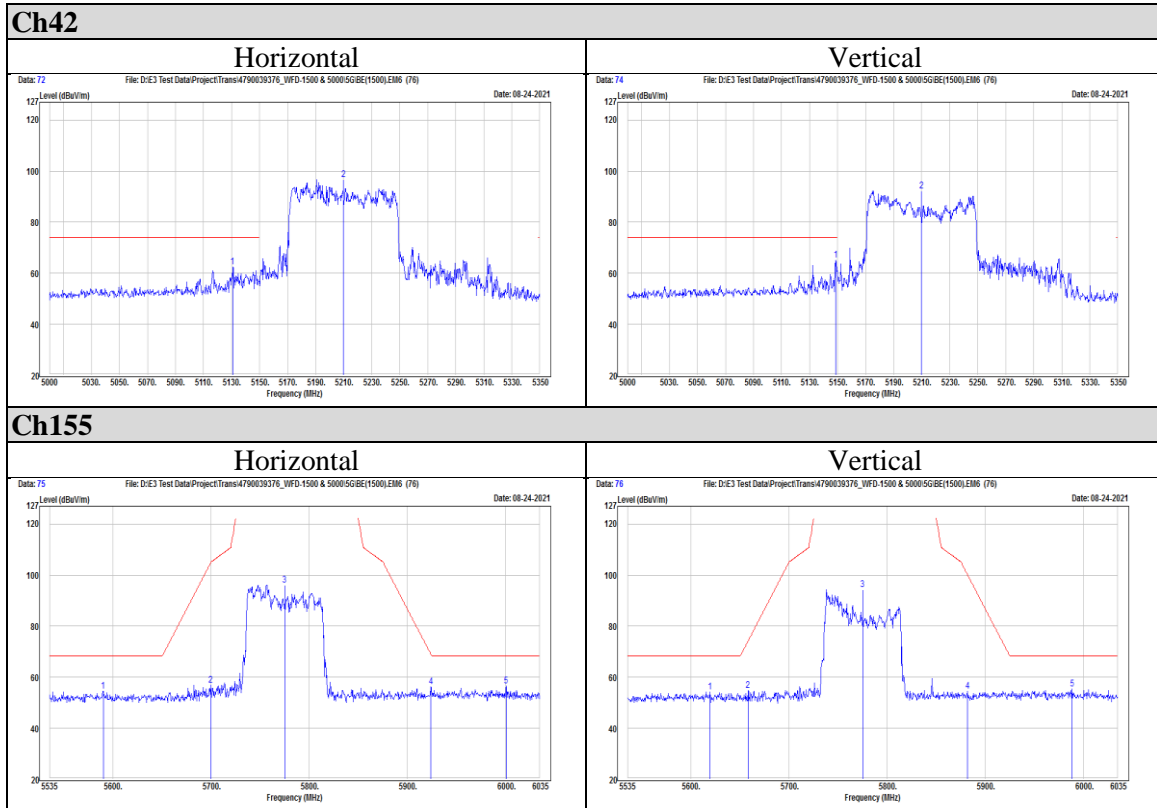

Average

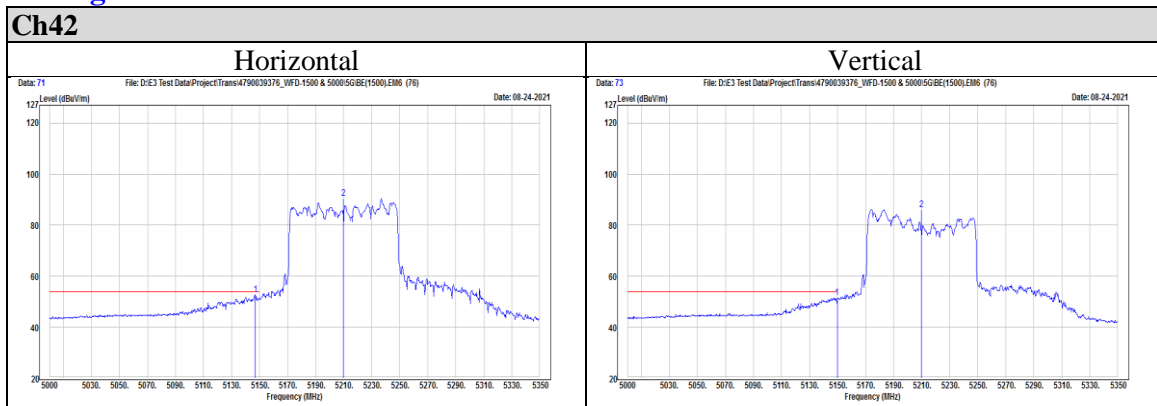

Underwriters Laboratories Taiwan Co., Ltd.

Building B and Building E, No. 372-7, Sec. 4, Zhongxing Rd., Zhudong Township, Hsinchu County, Taiwan

Telephone : +886-2-7737-3000

Facsimile (FAX) : +886-3-583-7948

Doc No: 17-EM-F0878 / 6.0



Appendix II Radiated Spurious Emission Measurement

802.11a

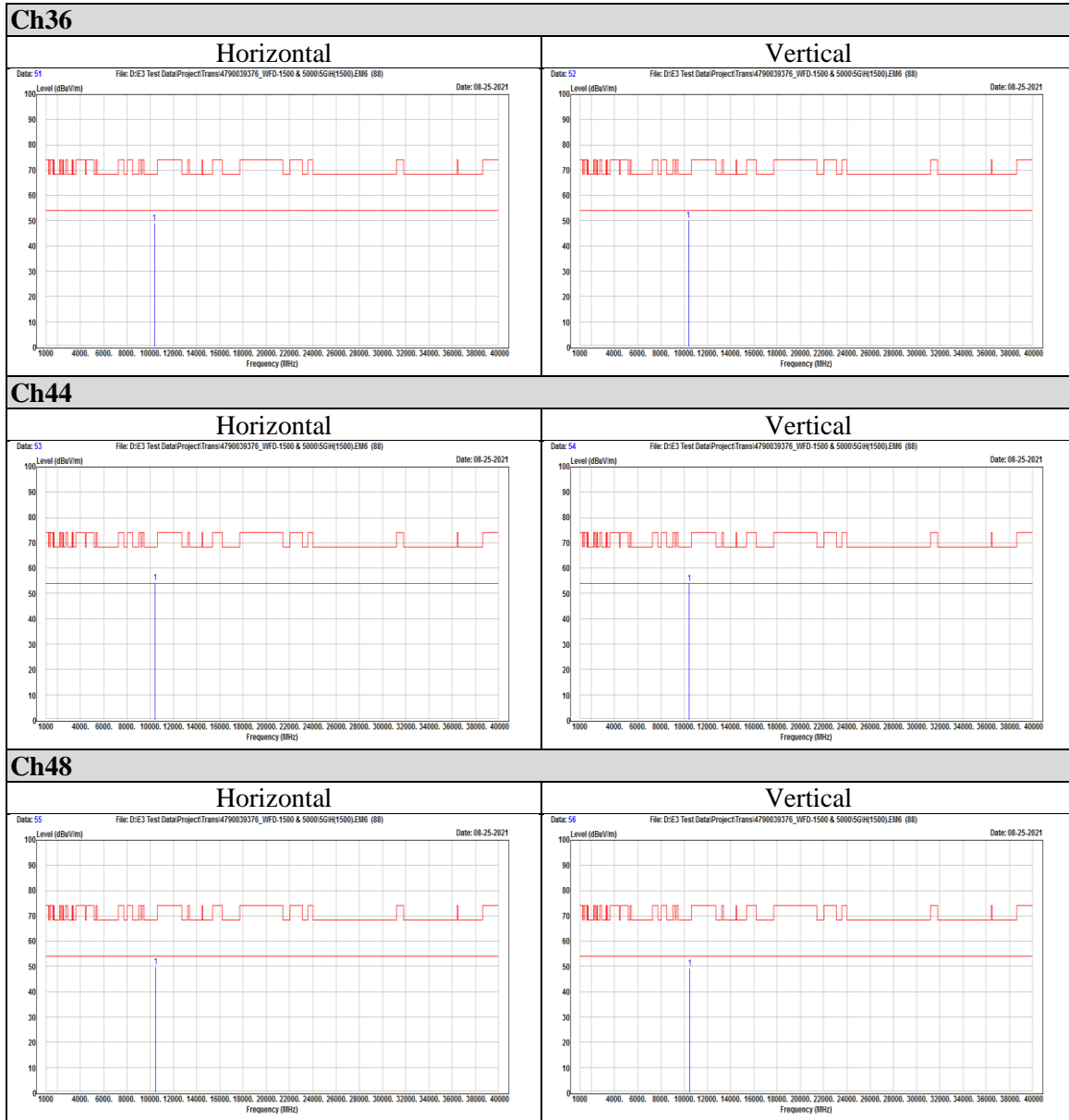

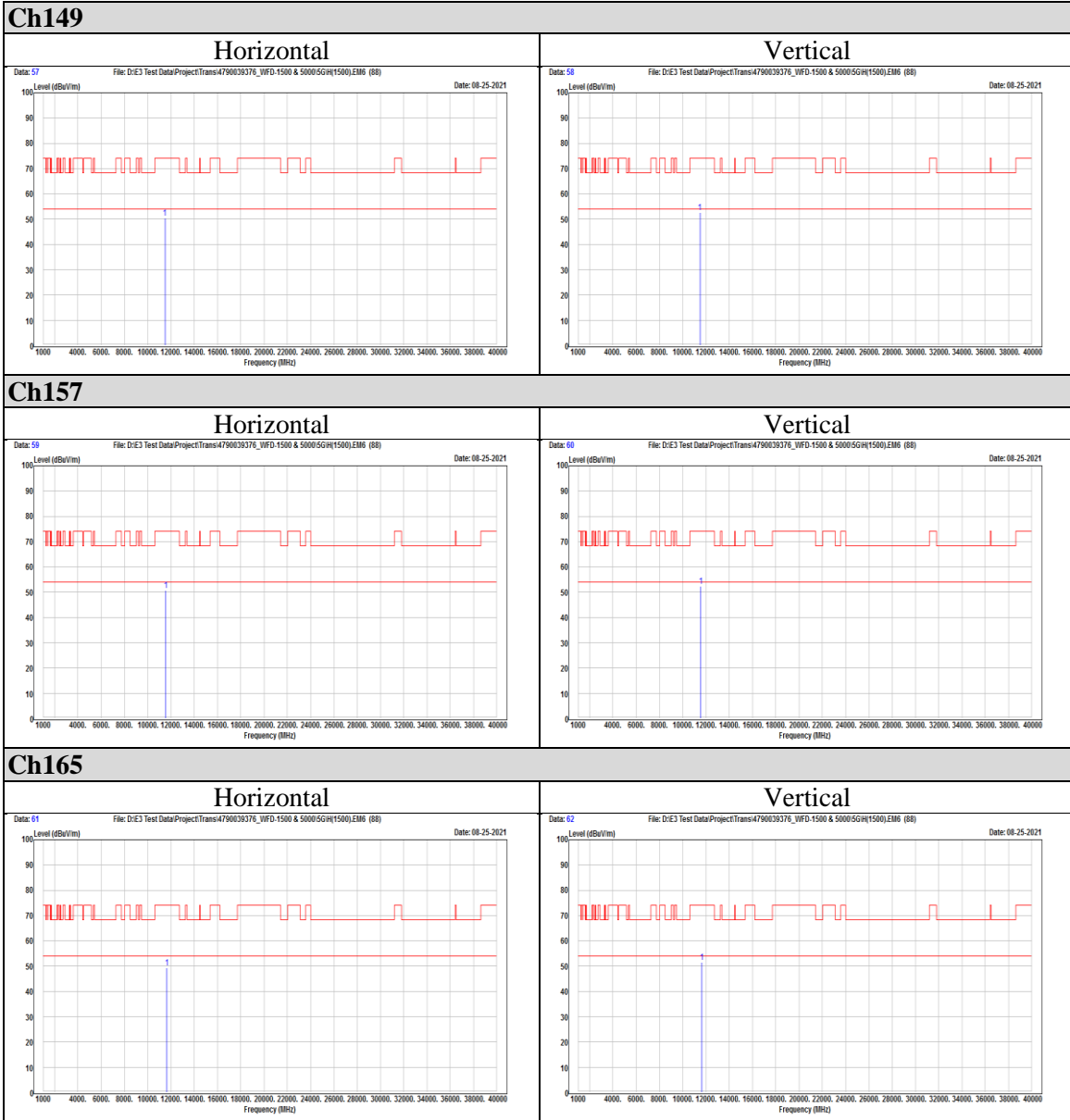



802.11ac (VHT20)

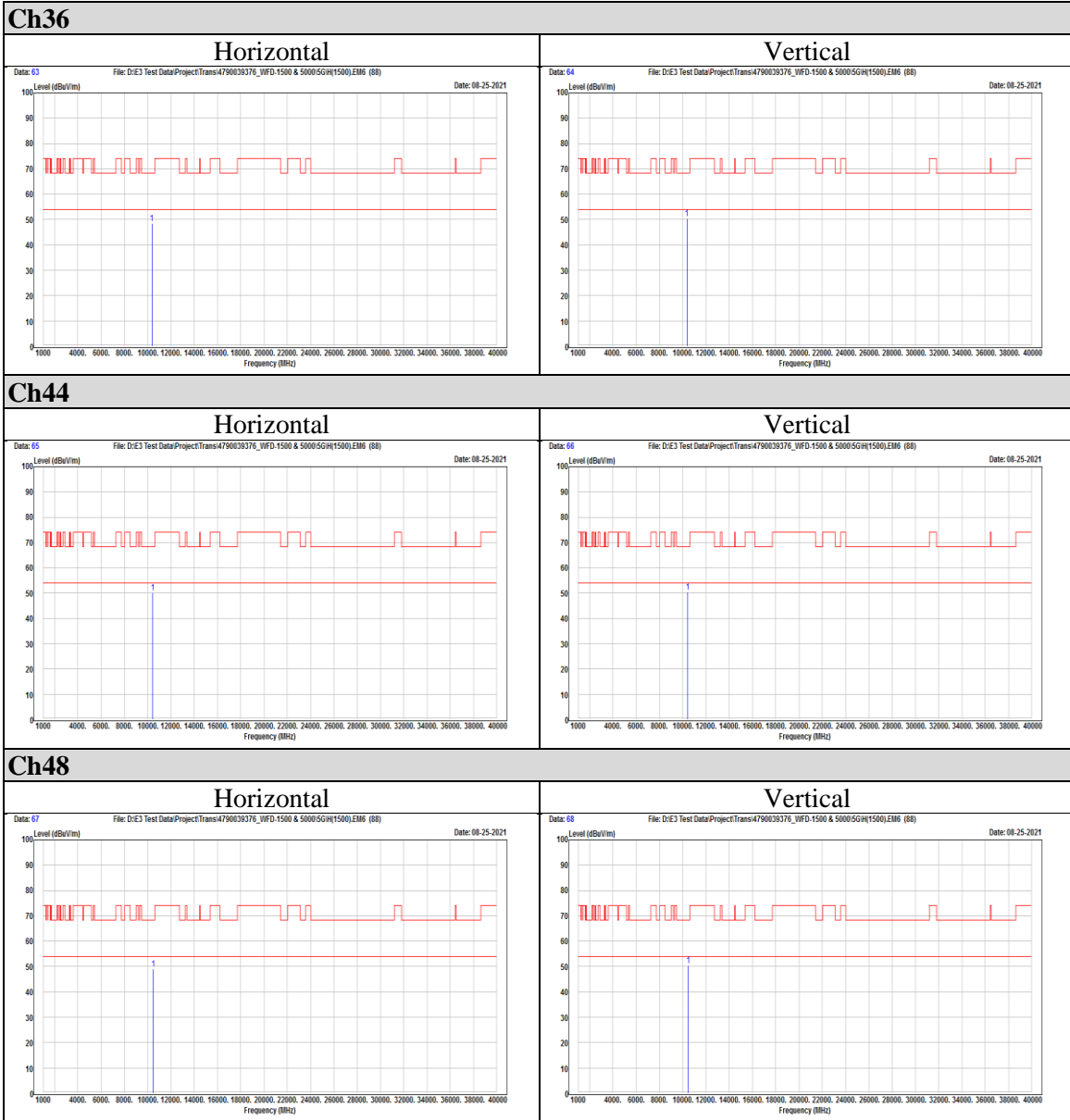

Underwriters Laboratories Taiwan Co., Ltd.

Building B and Building E, No. 372-7, Sec. 4, Zhongxing Rd., Zhudong Township, Hsinchu County, Taiwan

Telephone : +886-2-7737-3000

Facsimile (FAX) : +886-3-583-7948

Doc No: 17-EM-F0878 / 6.0

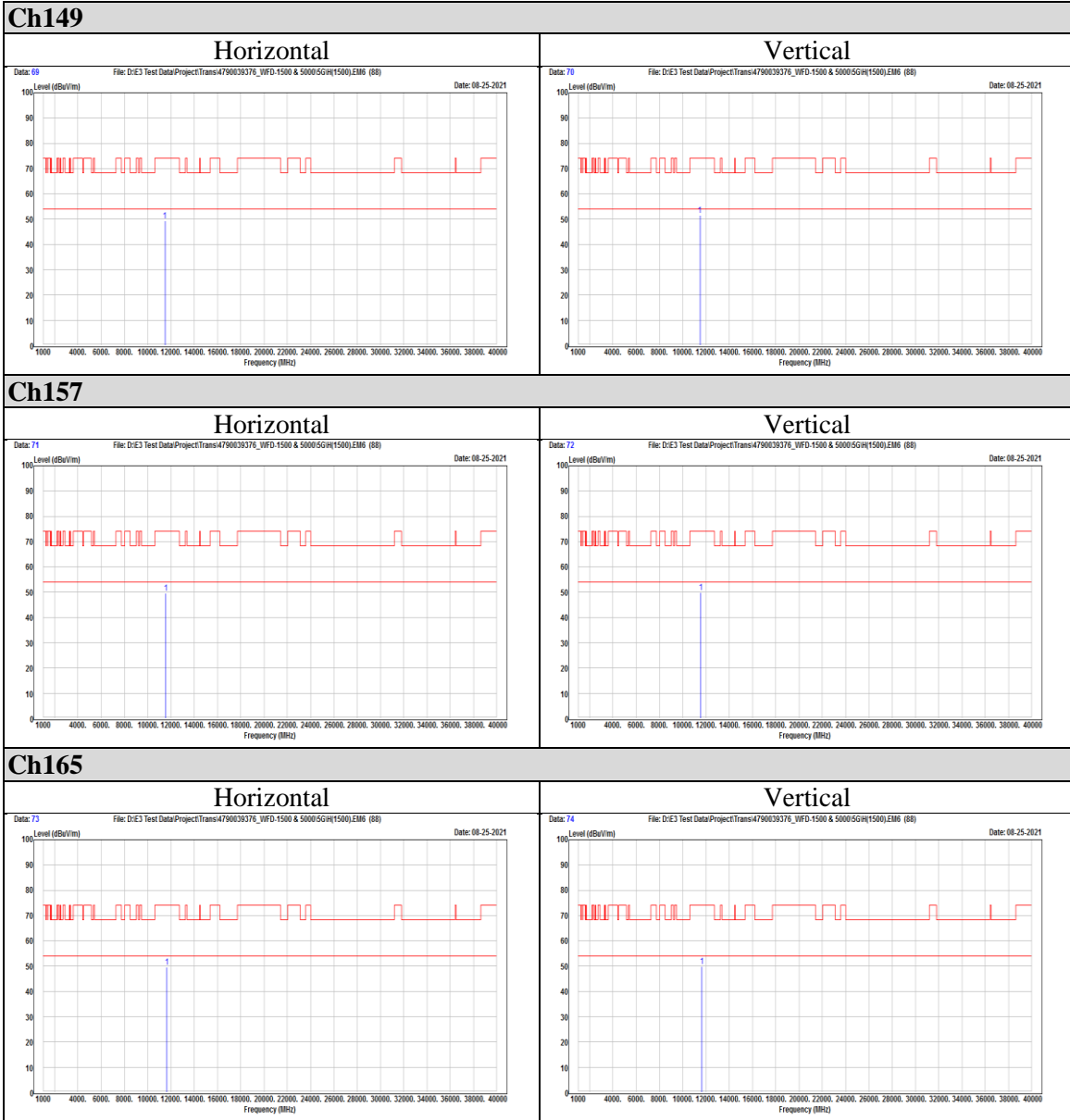



802.11ac (VHT40)

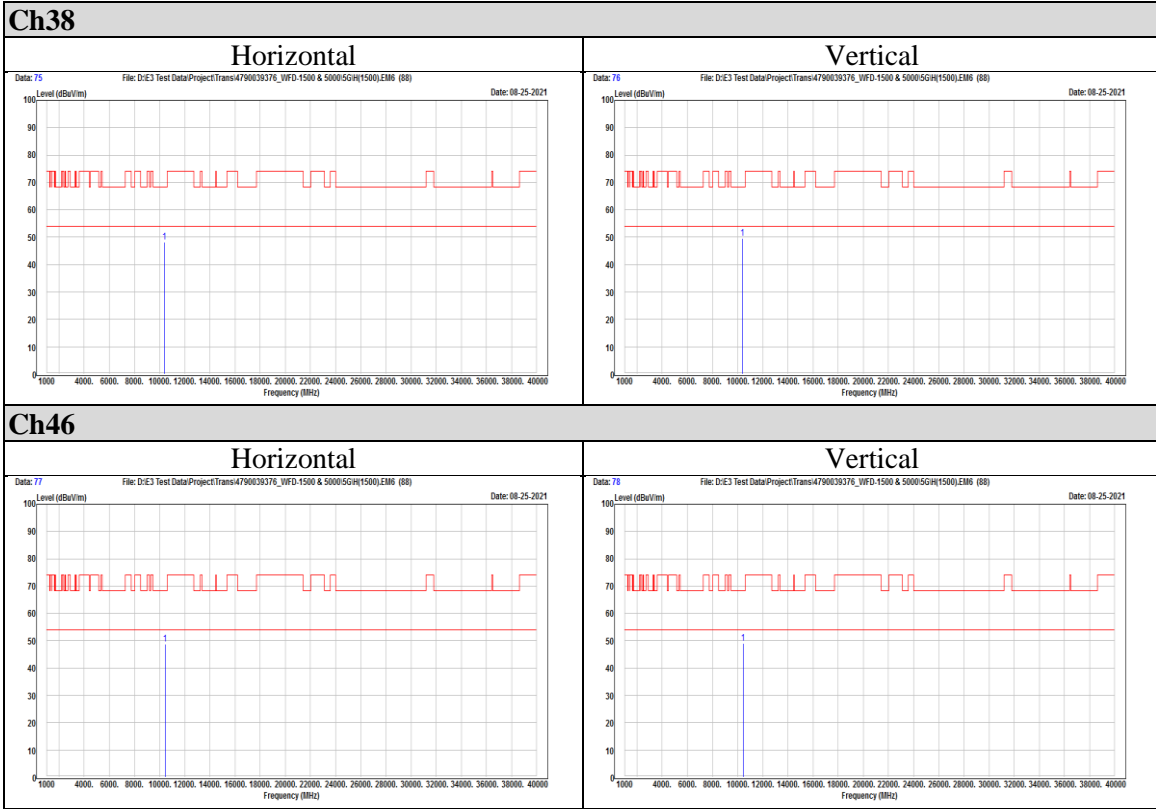

Underwriters Laboratories Taiwan Co., Ltd.

Building B and Building E, No. 372-7, Sec. 4, Zhongxing Rd., Zhudong Township, Hsinchu County, Taiwan

Telephone : +886-2-7737-3000

Facsimile (FAX) : +886-3-583-7948

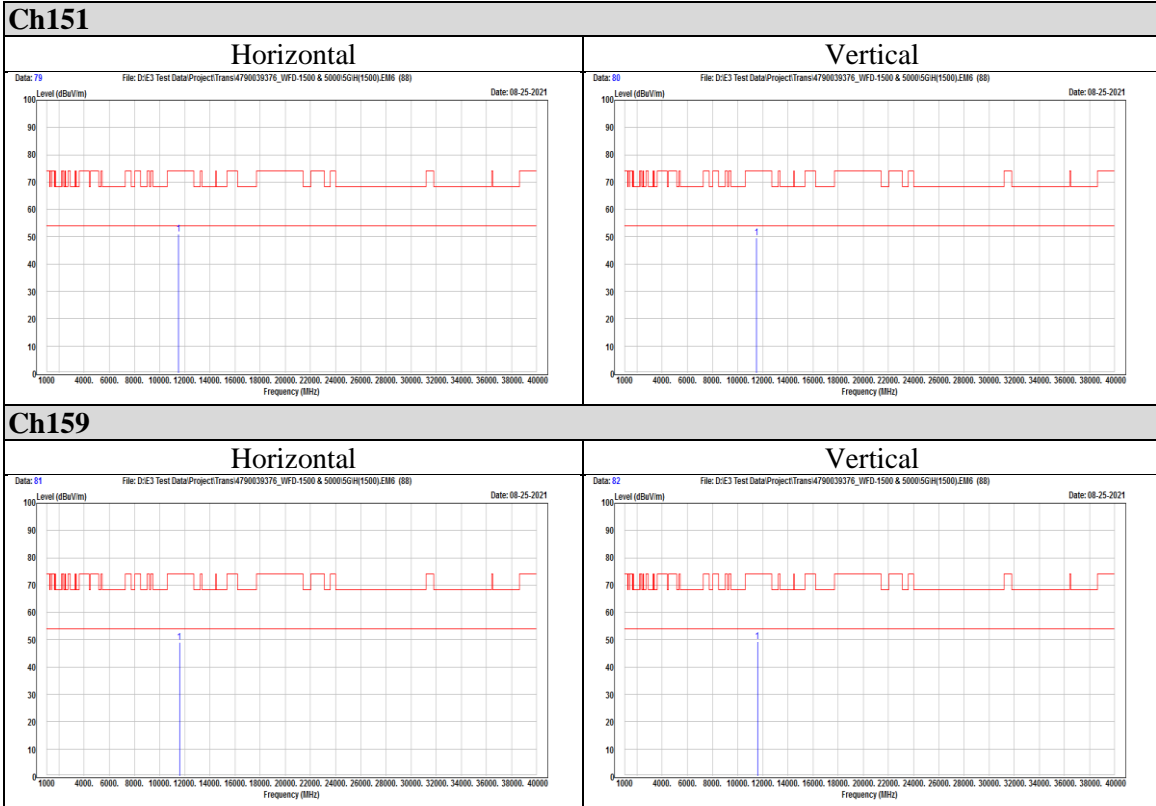



802.11ac (VHT80)

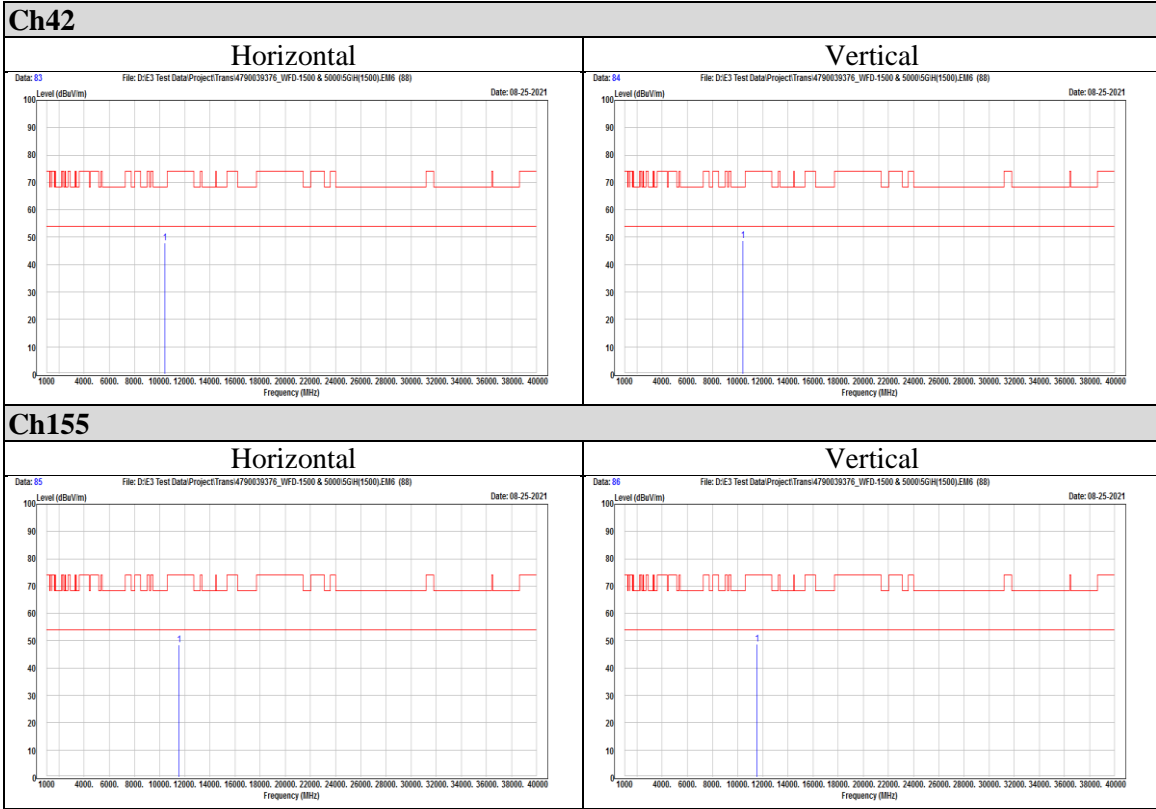

END OF REPORT

Underwriters Laboratories Taiwan Co., Ltd.

Building B and Building E, No. 372-7, Sec. 4, Zhongxing Rd., Zhudong Township, Hsinchu County, Taiwan

Telephone : +886-2-7737-3000

Facsimile (FAX) : +886-3-583-7948

Doc No: 17-EM-F0878 / 6.0