

***FCC Part 15 Subpart C***  
***EMI TEST REPORT***

*of*

E.U.T. : Remote Control Extender(Transmitter)

FCC ID. : BY4IR100A

MODEL : DSC-IR100A

Working Frequency : 418MHz

*for*

APPLICANT : Trans Electric Co., Ltd.

ADDRESS : 765 Chungsan Road, Section 2, Huatang, Changhua,  
TAIWAN

Test Performed by

**ELECTRONICS TESTING CENTER, TAIWAN**

NO. 8 LANE 29, WENMIMG ROAD,  
LOSHAN TSUN, KWEISHAN HSIANG,  
TAOYUAN, TAIWAN, R.O.C.

Tel:(03)3276170-3276174

Fax:(03)3276188

Report Number : ET91S-01-188

## TEST REPORT CERTIFICATION

Applicant : Trans Electric Co., Ltd.  
765 Chungshan Road, Section 2, Huatang, Changhua, TAIWAN

Manufacturer : Trans Electric Co., Ltd.  
765 Chungshan Road, Section 2, Huatang, Changhua, TAIWAN

Description of EUT :

- a) Type of EUT : Remote Control Extender(Transmitter)
- b) Trade Name : RECOTON
- c) Model No. : DSC-IR100A
- d) FCC ID : BY4IR100A
- e) Working Frequency : 418MHz
- f) Power Supply : AC120V/60Hz
- g) Adapter : I/P AC 120V/60Hz  
O/P DC 12V, 100mA

Regulation Applied : FCC Rules and Regulations Part 15 Subpart C (1999)

I HEREBY CERTIFY THAT; The data shown in this report were made in accordance with the procedures given in ANSI C63.4 and the energy emitted by the device was founded to be within the limits applicable. I assume full responsibility for accuracy and completeness of these data.

Note : 1. The results of the testing report relate only to the items tested.  
2. The testing report shall not be reproduced except in full, without the written approval of ETC.

Test Date : Jan. 30, 2002

Test Engineer : Rick Hu

Approve & Authorized  
Signer :

Win-Po Tsai

Win-Po Tsai, Supervisor, NVLAP Signatory  
EMC Dept. I of ELECTRONICS  
TESTING CENTER, TAIWAN

# Table of Contents

Page

<b>1. GENERAL INFORMATION</b> .....	<b>1</b>
1.1 PRODUCT DESCRIPTION.....	1
1.2 CHARACTERISTICS OF DEVICE:.....	1
1.3 TEST METHODOLOGY .....	1
1.4 TEST FACILITY.....	1
<b>2. DEFINITION AND LIMITS</b> .....	<b>2</b>
2.1 DEFINITION .....	2
2.2 RESTRICTED BANDS OF OPERATION .....	2
2.3 LIMITATION .....	2
2.4 LABELING REQUIREMENT .....	4
2.5 USER INFORMATION .....	4
<b>3. RADIATED EMISSION MEASUREMENT</b> .....	<b>5</b>
3.1 APPLICABLE STANDARD.....	5
3.2 MEASUREMENT PROCEDURE .....	5
3.3 TEST DATA.....	7
3.4 FIELD STRENGTH CALCULATION .....	8
3.5 RADIATED TEST EQUIPMENT .....	8
3.6 MEASURING INSTRUMENT SETUP .....	13
3.7 RADIATED MEASUREMENT PHOTOS.....	14
<b>4. BANDWIDTH OF EMISSION</b> .....	<b>15</b>
4.1 APPLICABLE STANDARD PLOT GRAPHIC OF BANDWIDTH.....	15
4.2 BANDWIDTH TEST EQUIPMENT .....	15
4.3 TEST RESULT .....	15
<b>5. CONDUCTED EMISSION MEASUREMENT</b> .....	<b>18</b>
5.1 APPLICABLE STANDARD.....	18
5.2 MEASUREMENT PROCEDURE .....	18
5.3 CONDUCTED EMISSION DATA.....	19
5.4 RESULT DATA CALCULATION.....	22
5.5 CONDUCTED MEASUREMENT EQUIPMENT .....	22
5.6 CONDUCTED MEASUREMENT PHOTOS.....	23
<b>6. LIMIT OF TRANSMISSION TIME</b> .....	<b>24</b>
6.1 APPLICABLE STANDARD.....	24
6.2 ACTIVE TIME.....	24

## 1. GENERAL INFORMATION

### 1.1 Product Description

a) Type of EUT	: Remote Control Extender(Transmitter)
b) Trade Name	: RECOTON
c) Model No.	: DSC-IR100A
d) FCC ID	: BY4IR100A
e) Working Frequency	: 418MHz
f) Power Supply	: AC120V/60Hz
g) Adapter	: I/P AC 120V/60Hz O/P DC 12V, 150mA

### 1.2 Characteristics of Device:

The EUT(Remote Control Extender) enables the users to extend their range of present Infrared IR Remote Control so that the users can operate VCRs, Stereos, Cable Converter, Satellite Receivers, etc. The EUT uses radio frequencies and can operate through walls, doors, around corners, etc.

### 1.3 Test Methodology

Radiated testing were performed according to the procedures in chapter 13 of ANSI C63.4. The equipment under test was operated continuously in its normal operating mode for the purpose of the measurements.

The receiving antenna was varied from 1 to 4 meters and the wooden turntable was rotated through 360 degrees to obtain the highest reading on the field strength meter or on the display of the spectrum analyzer. And also, each emission was to be maximized by changing the orientation of the equipment under test.

### 1.4 Test Facility

The semi-anechoic chamber and conducted measurement facility used to collect the radiated and conducted data are located inside the Building at No.8, Lane 29, Wen-ming Road, Lo-shan Tsun, Kweishan Hsiang, Taoyuan, Taiwan, R.O.C.

This site has been accreditation as a FCC filing site.

## 2. DEFINITION AND LIMITS

### 2.1 Definition

Intentional radiator:

A device that intentionally generates and emits radio frequency energy by radiation or induction.

### 2.2 Restricted Bands of Operation

Only spurious emissions are permitted in any of the frequency bands listed below:

MHz	MHz	MHz	GHz
0.090 - 0.110	16.42-16.423	399.9-410	4.5-5.25
0.495 - 0.505 **	16.69475 - 16.69525	608-614	5.35-5.46
2.1735 - 2.1905	16.80425 - 16.80475	960-1240	7.25-7.75
4.125-4.128	25.5-25.67	1300-1427	8.025-8.5
4.17725-4.17775	37.5-38.25	1435-1626.5	9.0-9.2
4.20725-4.20775	73-74.6	1645.5-1646.5	9.3-9.5
6.215-6.218	74.8-75.2	1660-1710	10.6-12.7
6.26775-6.26825	108-121.94	1718.8-1722.2	13.25-13.4
6.31175-6.31225	123-138	2200-2300	14.47-14.5
8.291-8.294	149.9-150.05	2310-2390	15.35-16.2
8.362-8.366	156.52475 - 156.52525	2483.5-2500	17.7-21.4
8.37625-8.38675	156.7-156.9	2655-2900	22.01-23.12
8.41425-8.41475	162.0125-167.17	3260-3267	23.6-24.0
12.29-12.293	167.72-173.2	3332-3339	31.2-31.8
12.51975-12.52025	240-285	3345.8-3358	36.43-36.5
12.57675-12.57725	322-335.4	3600-4400	Above 38.6
13.36-13.41			

Remark “\*\*” : Until February 1, 1999, this restricted band shall be 0.490-0.510 MHz

### 2.3 Limitation

#### (1) Conducted Emission Limits :

For an intentional radiator which is designed to be connected to the public utility (AC) power line, the conducted limit is the following:

Frequency ( MHz )	Emission ( $\mu$ V )	Emission ( dB $\mu$ V )
0.45 - 30.0	250	48.0

**(2) Radiated Emission Limits :**

According to 15.231 ,Periodic operation in the band 40.66-40.70 MHz and above 70 MHz, the field strength of emissions from intentional radiators operated under this section shall not exceed the following:

Frequency Band (MHz)	Field strength of Fundamental (uV/m)	Field strength of Spurious (uV/m)
40.66-40.70	2250	225
70-130	1250	125
130-174	*1,250 to 3,750	*125 to 375
174-260	3750	375
260-470	*3,750 to 12,500	*375 to 1250
Above 470	12500	1250

\* Linear interpolations.

Field strength limits are at the distance of 3 meters, emissions radiated outside of the specified bands, shall be according to the general radiated limits in 15.209,as following table:

Other Frequencies (MHz)	Field Strength of Fundamental	
	$\mu\text{V}/\text{meter}$	$\text{dB}\mu\text{V}/\text{meter}$
30 - 88	100	40.0
88 - 216	150	43.5
216 - 960	200	46.0
Above 960	500	54.0

As shown in 15.35(b), for frequencies above 1000MHz, the field strength limits are based on average detector, however, the peak field strength of any emission shall not exceed the maximum permitted average limits, specified above by more than 20 dB under any condition of modulation.

**(3) Limit of transmission time**

- a) A manually operated Remote Control Extender (Transmitter) shall employ a switch that will automatically deactivate the Remote Control Extender (Transmitter) within not more than 5 seconds of being released.
- b) A Remote Control Extender (Transmitter) activated automatically shall cease transmission within 5 seconds after activation.

**(4) The bandwidth of the emission**

The bandwidth of the emission shall be no wider than 0.25% of the center frequency for devices operating above 70MHz and below 900MHz.

## **2.4 Labeling Requirement**

The device shall bear the following statement in a conspicuous location on the device :

This device complies with part 15 of the FCC Rules. Operation is subject to the following two conditions: (1) This device may not cause harmful interference, and (2) this device must accept any interference received, including interference that may cause undesired operation.

## **2.5 User Information**

The users manual or instruction manual for an intentional or unintentional radiator shall caution the user that changes or modifications not expressly approved by the party responsible for compliance could void the user's authority to operate the equipment.

### 3. RADIATED EMISSION MEASUREMENT

#### 3.1 Applicable Standard

For periodic operation intentional radiator, the radiated emission shall comply with § 15.231(b).

#### 3.2 Measurement Procedure

1. Setup the configuration per figure 1 and 2 for frequencies measured below and above 1 GHz respectively. Turn on EUT and make sure that it is in normal function.
2. For emission frequencies measured below 1 GHz, a pre-scan is performed in a semi-anechoic chamber to determine the accurate frequencies of higher emissions and then each selected frequency is precisely measured. As the same purpose, for emission measured above 1 GHz, a pre-scan also be performed with a 1 meter measuring distance before final test.
3. For emission measured below and above 1 GHz, set the spectrum analyzer on a 100 kHz and 1 MHz resolution bandwidth respectively for each frequency measured in step 2.
4. The search antenna is to be raised and lowered over a range from 1 to 4 meters in horizontally polarized orientation. Position the highness when the highest value is indicated on spectrum analyzer, then change the orientation of EUT on test table over a range from 0° to 360° with a speed as slow as possible, and keep the azimuth that highest emission is indicated on the spectrum analyzer. Vary the antenna position again and record the highest value as a final reading. A RF test receiver is also used to confirm emissions measured.
5. Repeat step 4 until all frequencies need to be measured were complete.
6. Repeat step 5 with search antenna in vertical polarized orientations.
7. Check the three frequencies of highest emission with varying the placement of cables (if any) associated with EUT to obtain the worse case and record the result.



Figure 1 : Frequencies measured below 1 GHz configuration

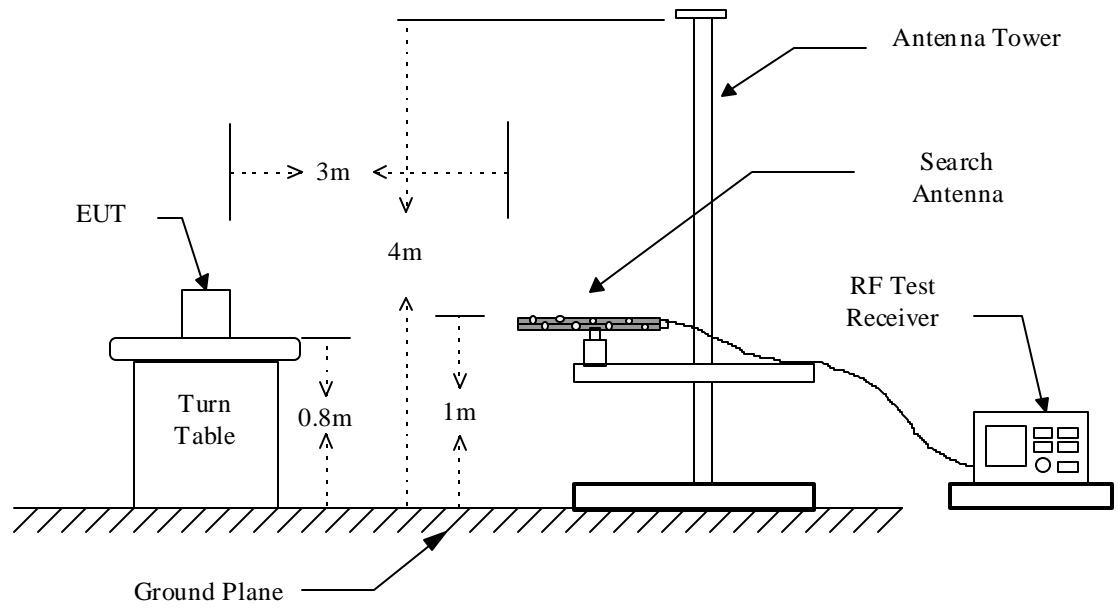
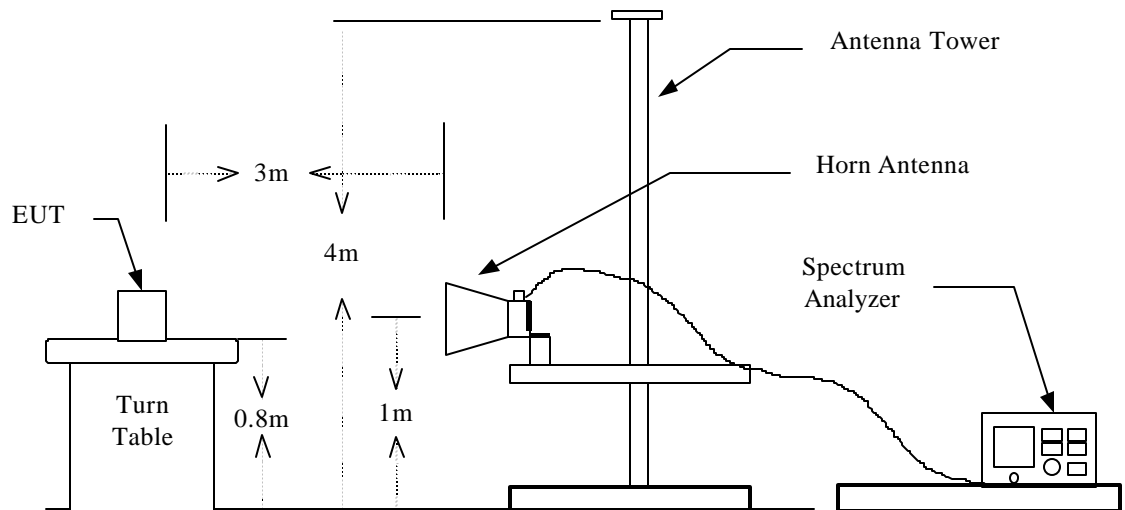

Figure 2 : Frequencies measured above 1 GHz configuration



### 3.3 Test Data

Temperature : 16  
 Humidity : 65 %  
 Operated mode : Transmitting  
 Test Date : Jan. 30, 2002

Frequency (MHz)	Ant Pol H/V	Reading (dBuV) Peak	Correct Factor (dB)	Duty Factor (dB)	Result @3m (dBuV/m)		Limit @3m (dBuV/m)		Margin (dB)	Table Degree (Deg.)	Ant. High (m)
					Peak	AVG	Peak	AVG			
417.838	H	71.8	8.0	-7.2	79.8	72.6	100.3	80.3	-7.7	360	1.0
417.838	V	75.3	8.0	-7.2	83.3	76.1	100.3	80.3	-4.2	140	1.3
835.671	H	24.2	28.6	-7.2	52.8	45.6	80.3	60.3	-14.7	130	1.3
835.671	V	33.1	28.6	-7.2	61.7	54.5	80.3	60.3	-5.8	190	1.2
1253.765	H	16.0	27.5	-7.2	43.5	36.3	80.3	60.3	-24.0	140	1.1
1253.765	V	17.1	27.5	-7.2	44.6	37.4	80.3	60.3	-32.9	120	1.2
1671.352	H/V	----	28.0	-7.2	----	----	74.0	54.0	----	----	----
2089.190	H/V	----	30.6	-7.2	----	----	80.3	60.3	----	----	----
2507.028	H/V	----	31.5	-7.2	----	----	80.3	60.3	----	----	----
2924.866	H/V	----	32.7	-7.2	----	----	80.3	60.3	----	----	----
3342.704	H/V	----	33.5	-7.2	----	----	80.3	60.3	----	----	----
3760.542	H/V	----	35.2	-7.2	----	----	74.0	54.0	----	----	----
4178.380	H/V	----	36.1	-7.2	----	----	74.0	54.0	----	----	----

**Note :**

1. "----" means the noise is too low to be measured.
2. Peak Result = Peak Reading + Correct Factor
3. AVG Result = Peak Result + Duty Factor
4. If the measured frequencies fall in the restricted frequency band, the limit employed is § 15.209 general requirement when frequencies are below or equal to 1 GHz. And the measuring instrument is set to quasi peak detector function, no duty factor applied

### 3.4 Field Strength Calculation

(a) Field Strength :

The field strength is calculated by adding the Antenna Factor and Cable Factor, and subtracting the Amplifier Gain (if any) from the measured reading. The basic equation with a sample calculation is as follows:

$$\mathbf{RESULT = READING + CORR. FACTOR}$$

where CORR. FACTOR = Antenna FACTOR + Cable FACTOR

Assume a receiver reading of 22.5 dB  $\mu$  V is obtained. The Antenna Factor of 14.5 and a Cable Factor of 1.5 is added . The total of field strength is 38.5 dB  $\mu$  V/m.

$$\mathbf{RESULT = 22.5 + 14.5 + 1.5 = 38.5 \text{ dB } \mu \text{ V/m}}$$

$$\mathbf{Level \text{ in } \mu \text{ V/m} = \text{Common Antilogarithm}[(38.5 \text{ dB } \mu \text{ V/m})/20] = 84.14 \mu \text{ V/m}}$$

(b) Duty Factor :

$$20\log\frac{2.45 \times 1 + 1.3 \times 11 + 0.7 \times 4}{45} = -7.2 \text{ dB}$$

The plotted graph of Duty Factor please see page 9~12.

### 3.5 Radiated Test Equipment

The following instrument are used for radiated emissions measurement :

Equipment	Manufacturer	Model No.	Serial No.	Calibrated until
EMI Test Receiver	Hewlett-Packard	8546A	13054404-001	Jun. 20, 2002
BiconiLog Antenna	SCHWARZBECK	9160	13057310-001	Oct. 18, 2002
Horn Antenna	EMCO	3115	43057301-002	Dec. 12, 2002

Note: The standards used to perform this calibration are traceable to NML/ROC, NIST/USA and NPL.

Plotted graph 1 of Duty Factor

13:21:39 JAN 30, 2002

ACTV DET: PEAK  
MEAS DET: PEAK QP AVG  
MKRA 45.000 msec  
.05 dB

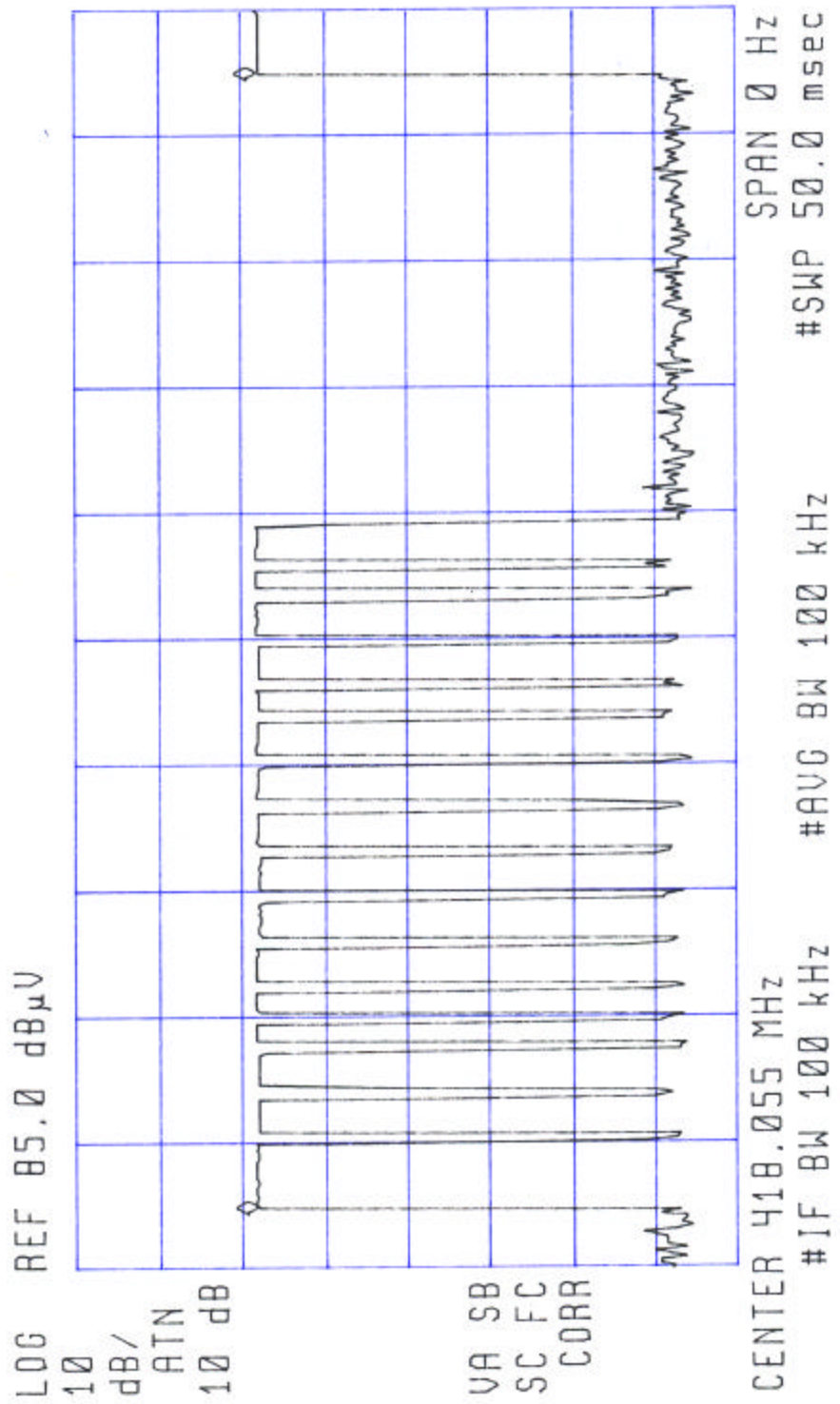

Plotted graph 2 of Duty Factor

13:11:54 JAN 30, 2002

ACTV DET: PEAK  
MEAS DET: PEAK QP AVG  
MKRA 2.4500 msec  
-.19 dB

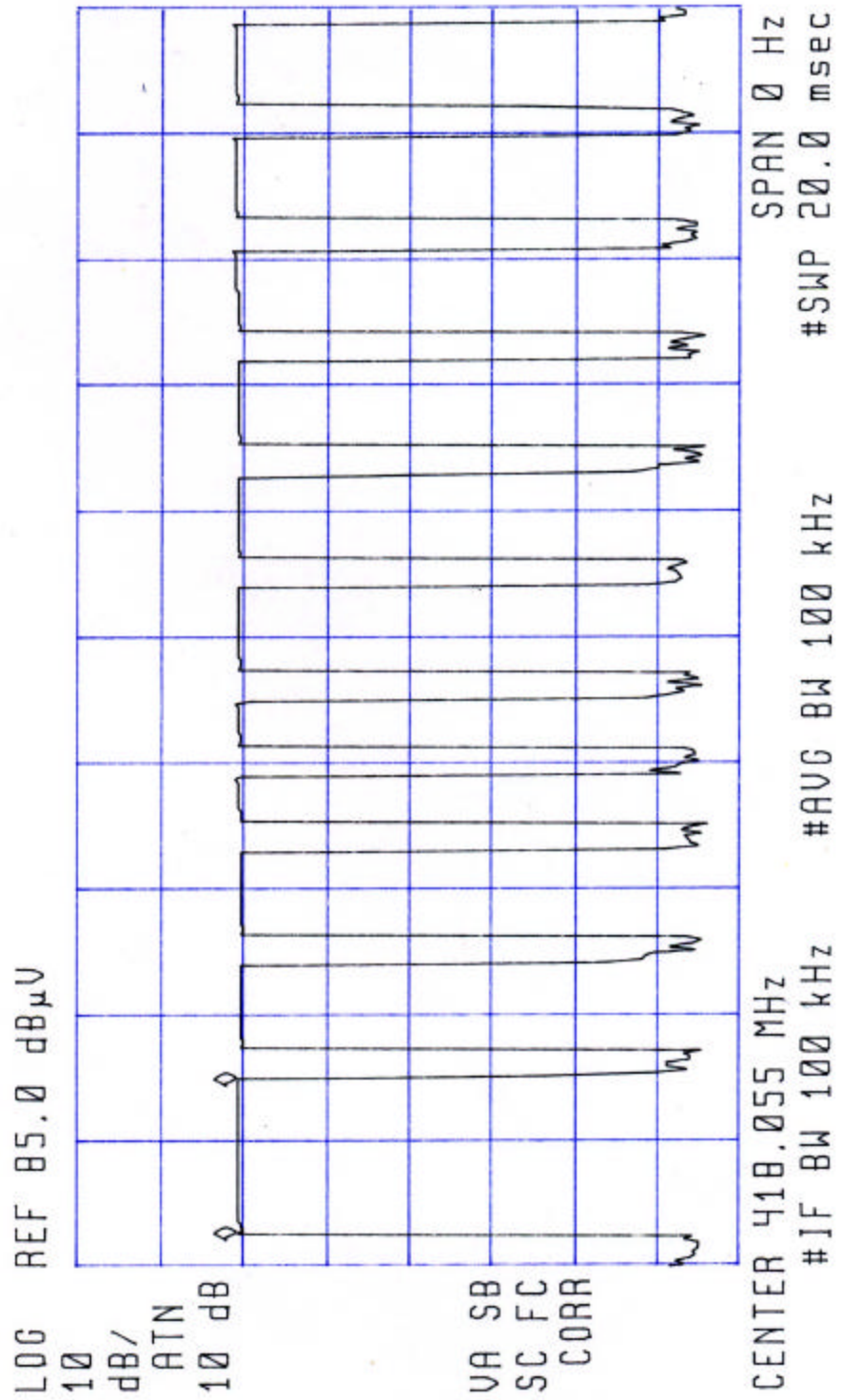

Plotted graph 3 of Duty Factor

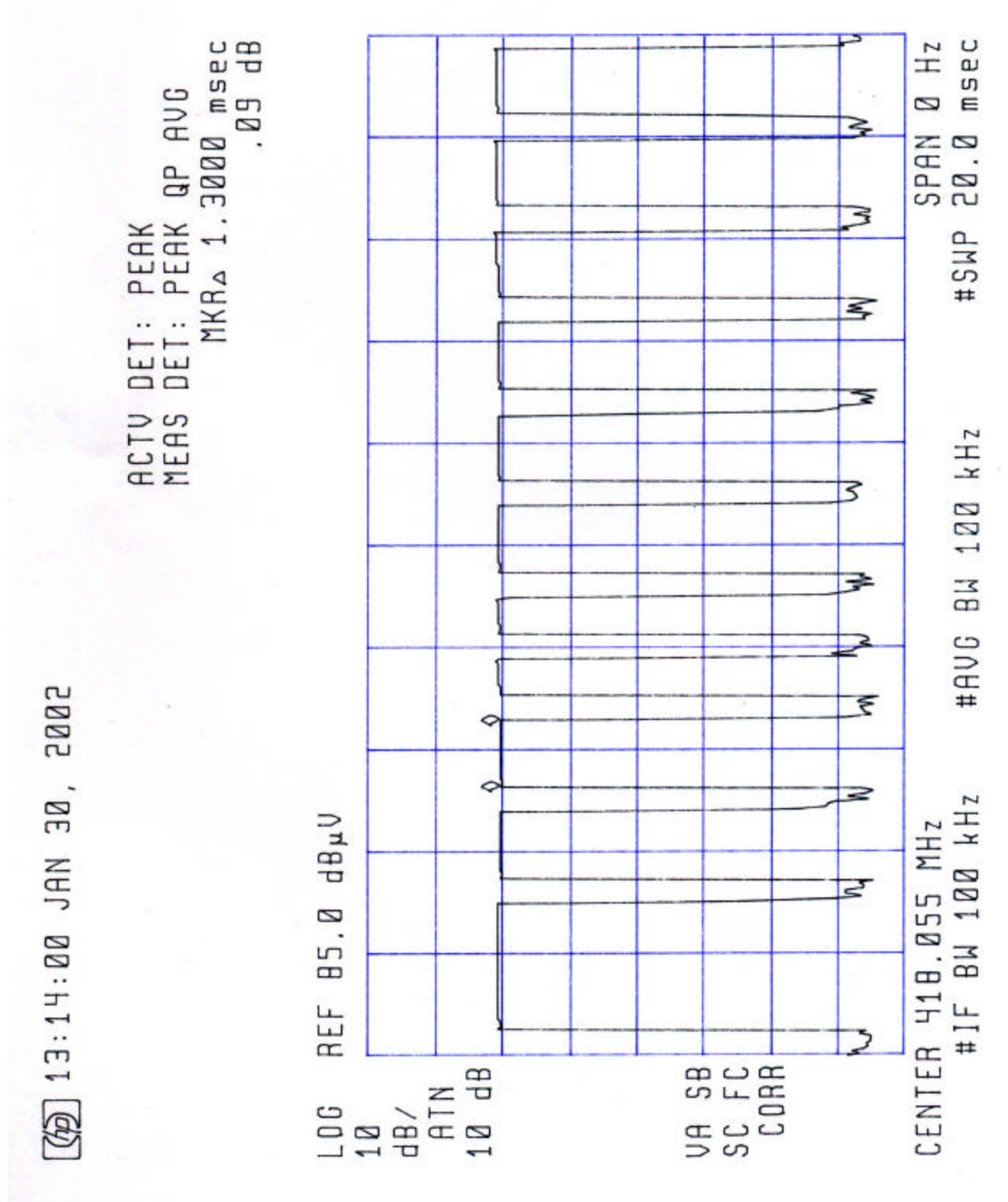

Plotted graph 4 of Duty Factor

13:17:27 JAN 30, 2002

ACTV DET: PEAK  
MEAS DET: PEAK QP AVG  
MKRΔ 700.00 μsec  
.04 dB

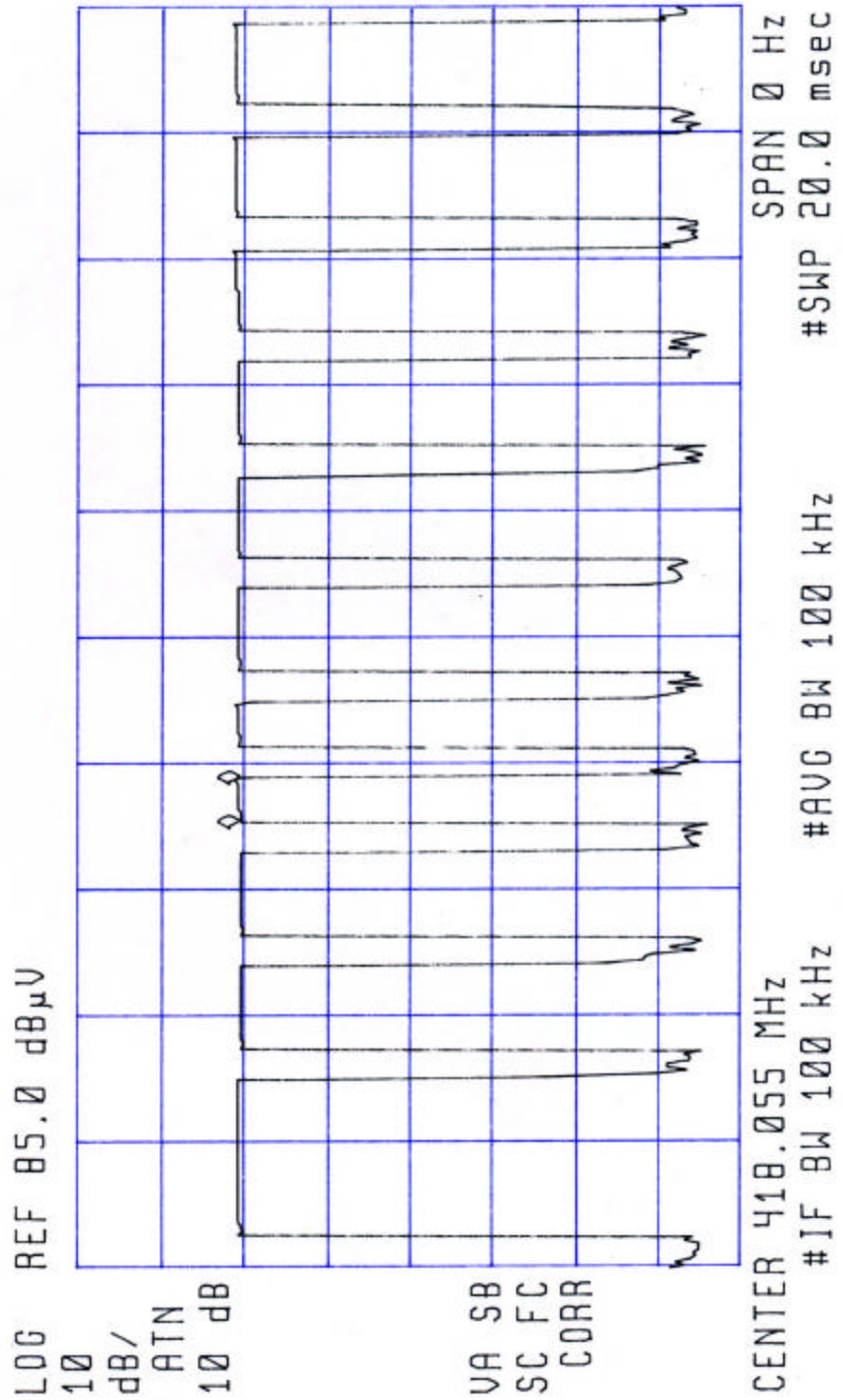

### 3.6 Measuring Instrument Setup

Explanation of measuring instrument setup in frequency band measured is as following :

Frequency Band (MHz)	Instrument	Function	Resolution bandwidth	Video Bandwidth
30 to 1000	EMI Test Receiver	Peak	120 kHz	300 kHz
1000 to 5000	EMI Test Receiver	Peak	1 MHz	1 MHz



### 3.7 Radiated Measurement Photos

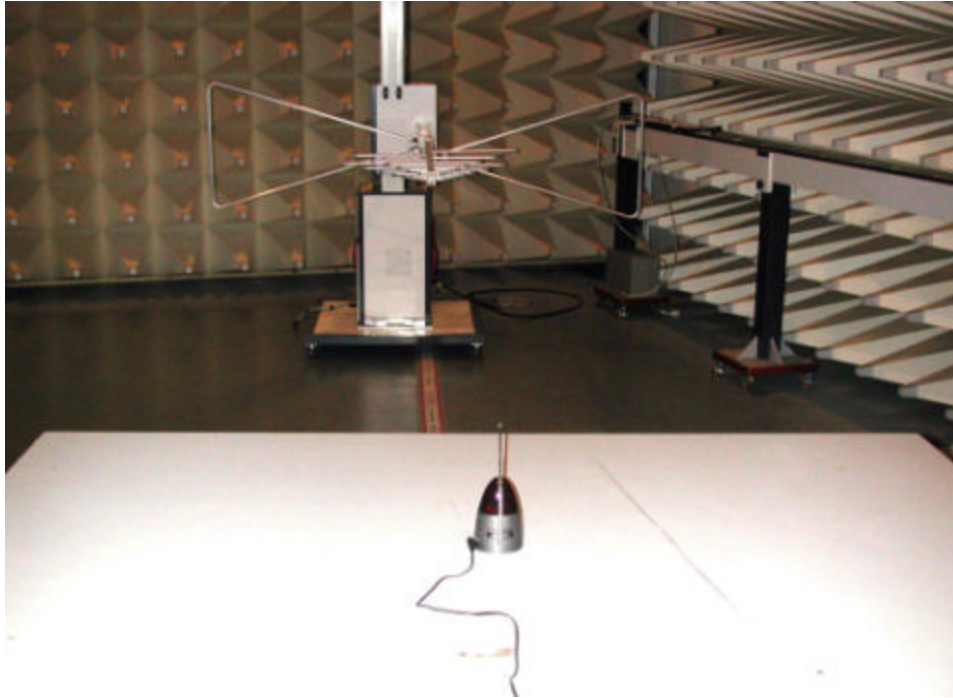

## 4. BANDWIDTH OF EMISSION

### 4.1 Applicable Standard Plot Graphic of Bandwidth

Per FCC rule § 15.231(c), the permitted emission bandwidth is no wider than 0.25% of the center frequency for devices operating above 70 MHz and below 900 MHz.

### 4.2 Bandwidth Test Equipment

Equipment	Manufacturer	Model No.	Next Cal. Date
Test Receiver	Hewlett-Packard	8546A	Jun. 20, 2002
Plotter	Hewlett-Packard	7470A	N/A

### 4.3 Test Result

The emission bandwidth limit for this transmitter is

$$(a) 418.055 \text{ MHz} \times 0.25\% = 1045.1 \text{ kHz}$$

$$(b) \text{ Test Result} = 295+300 = \mathbf{595 \text{ kHz}}$$

The plotted graph of Bandwidth please see page 16,17.

Bandwidth Plotted graph 1

13:01:55 JAN 30, 2002

ACTV DET: PEAK  
MEAS DET: PEAK QP AVG  
MKRA 295 kHz  
-20.55 dB

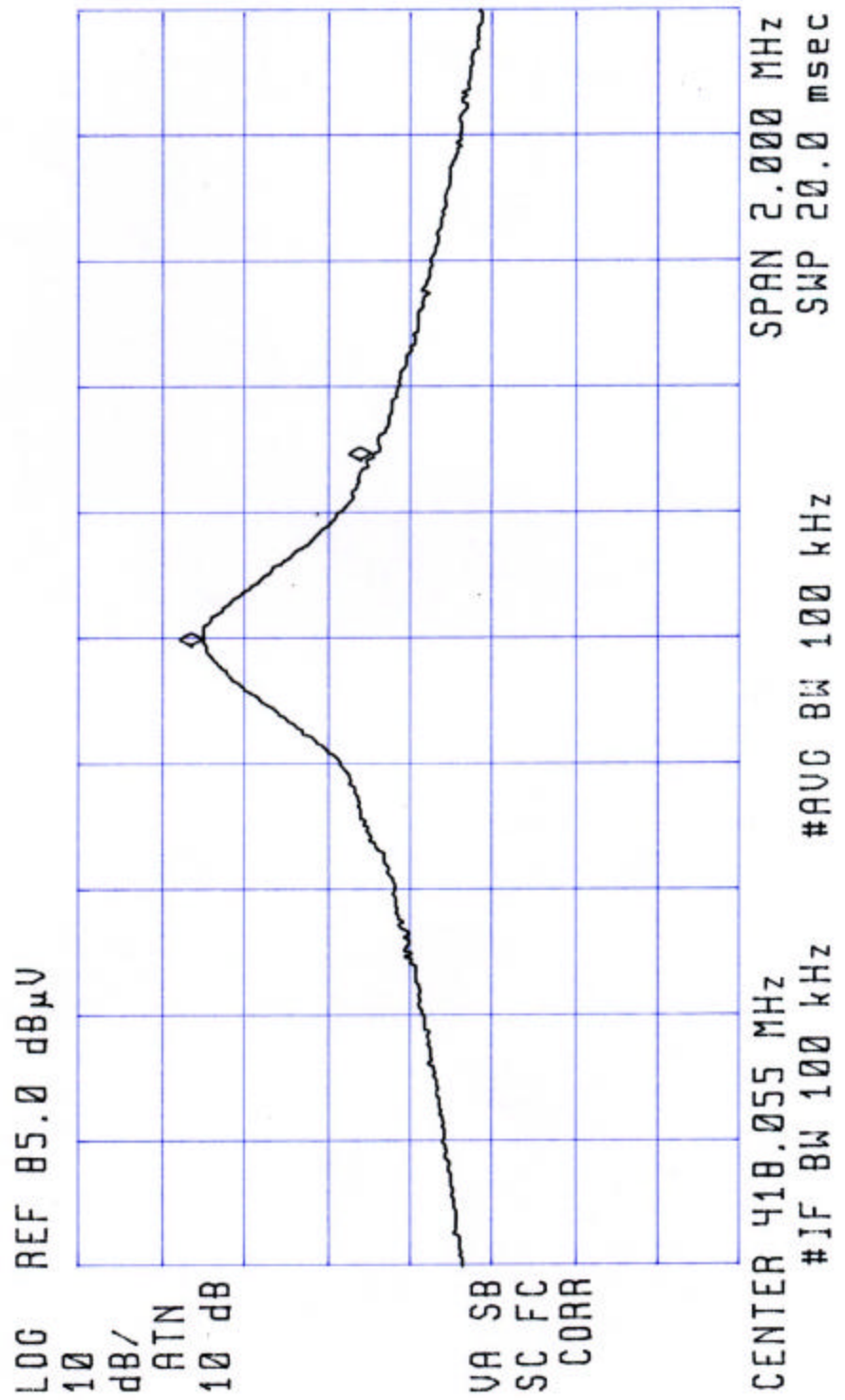

Bandwidth Plotted graph 2

12:59:33 JAN 30, 2002

ACTV DET: PEAK  
MEAS DET: PEAK QP AVG  
MKRΔ -300 kHz  
-20.01 dB

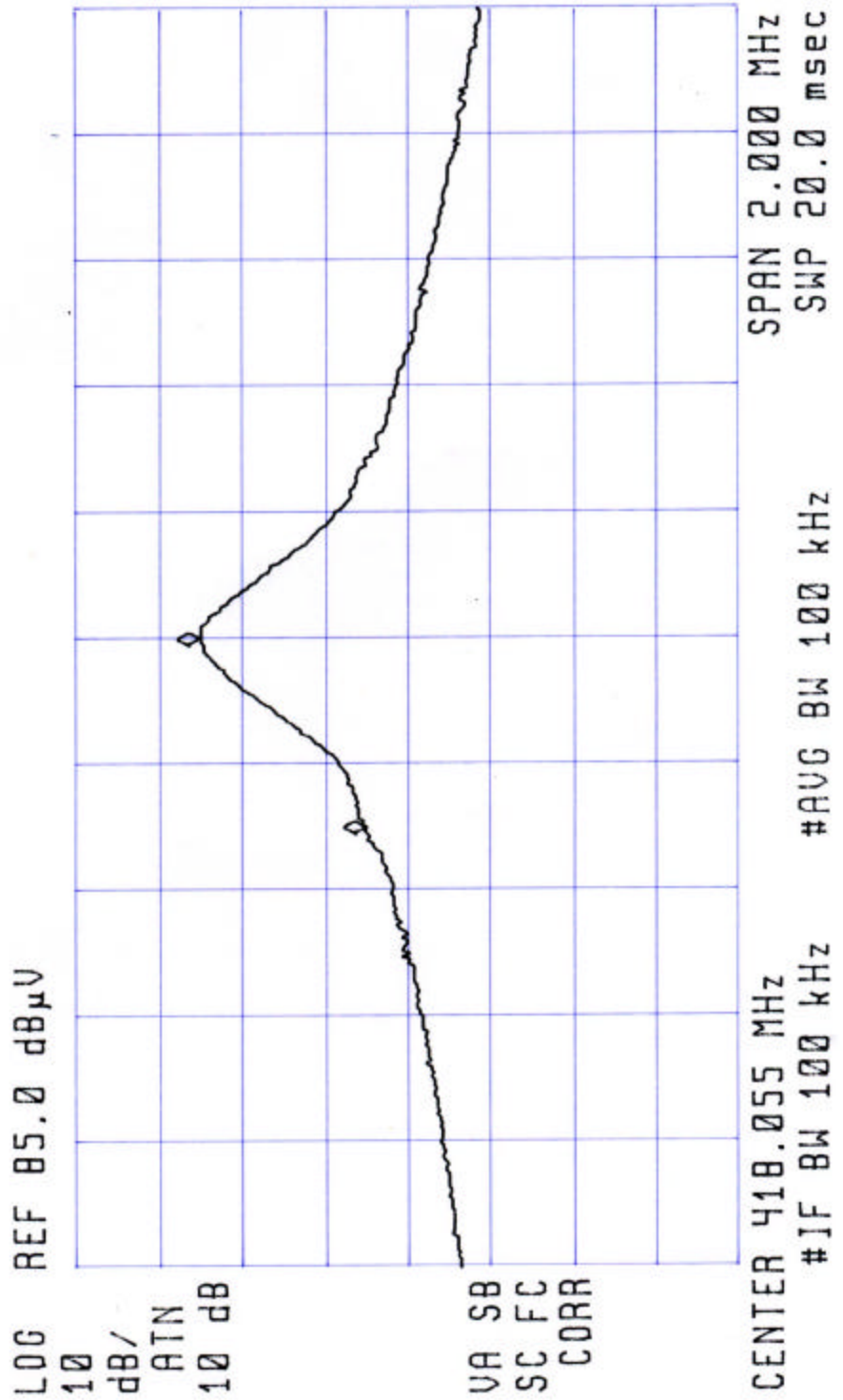

## 5. CONDUCTED EMISSION MEASUREMENT

### 5.1 Applicable Standard

For unintentional digital devices, Line Conducted Emission Limits are in accordance to § 15.107(a).

### 5.2 Measurement Procedure

1. Setup the configuration per figure 2.
2. A preliminary scan with a spectrum monitor is performed to identify the frequency of emission that has the highest amplitude relative to the limit by operating the EUT in selected modes of operation, typical cable positions, and with a typical system configuration.
3. Record the 4 to 8 highest emissions relative to the limit.
4. Measure each frequency obtained from step 3 by a test receiver set on quasi peak detector function, and then record the accuracy frequency and emission level. If all emissions measured in the specified band are attenuated more than 20 dB from the limit, this step would be ignored, and the peak detector function would be used.
5. Confirm the highest emissions with variation of the EUT cable configuration and record the final data.
6. Repeat all above procedures on measuring each operation mode of EUT.

Figure 2 : Conducted emissions measurement configuration

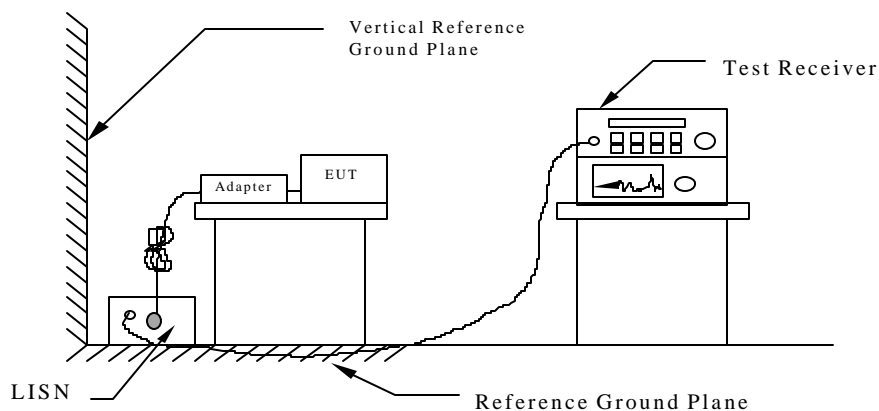

**5.3 Conducted Emission Data**

Temperature : 15  
 Humidity : 70 %  
 Operated mode : Transmitting  
 Test Date : Jan. 30, 2002

Emission Frequency ( MHz )	Meter Reading ( dBuV )		LISN Factor ( dB )	Results ( dBuV )		Limit (dBuV)	Margins ( dB )
	L1	L2		L1	L2		
0.583	17.1#	***	0.1	17.2#	***	48.0	-30.8
0.641	***	19.6#	0.1	***	19.7#	48.0	-28.3
0.684	***	21.0#	0.1	***	21.1#	48.0	-26.9
0.899	18.0#	***	0.1	18.1#	***	48.0	-29.9
0.977	***	19.1#	0.1	***	19.2#	48.0	-28.8
1.164	***	18.4#	0.2	***	18.6#	48.0	-29.4
4.645	***	19.7#	0.2	***	19.9#	48.0	-28.1
5.805	20.6#	***	0.2	20.8#	***	48.0	-27.2
6.012	20.2#	***	0.2	20.4#	***	48.0	-27.6
10.746	21.3#	***	0.4	21.7#	***	48.0	-26.3
11.359	21.8#	***	0.4	22.2#	***	48.0	-25.8
21.176	***	23.1#	0.5	***	23.6#	48.0	-24.4

Note :

1. The full frequency range scanning test data is shown in next two pages.
2. The estimated measurement uncertainty of the result measurement is  $\pm 3$ dB.
3. ① If the data table appeared symbol of "\*\*\*\*" means the value was too low to be measured.  
 ② If the data table appeared symbol of "----" means the Q.P. value is under the limit for AVG.  
 so, the AVG. value doesn't need to be measured.  
 ③ If the data table appeared symbol of "#" means the noise was low, so record the peak value.

### Conducted Emission

#### Peak Value

EUT: Remote Control Extender  
Manuf: TRANS  
Op Cond: Working  
Operator: Rick Hu  
Test Spec: FCC Class B  
Comment: L1  
Model : DSC-IR100A

Final Measurement:      Detector: X QP  
                                 Meas Time: 500msec  
                                 Peaks: 8  
                                 Acc Margin: 10 dB

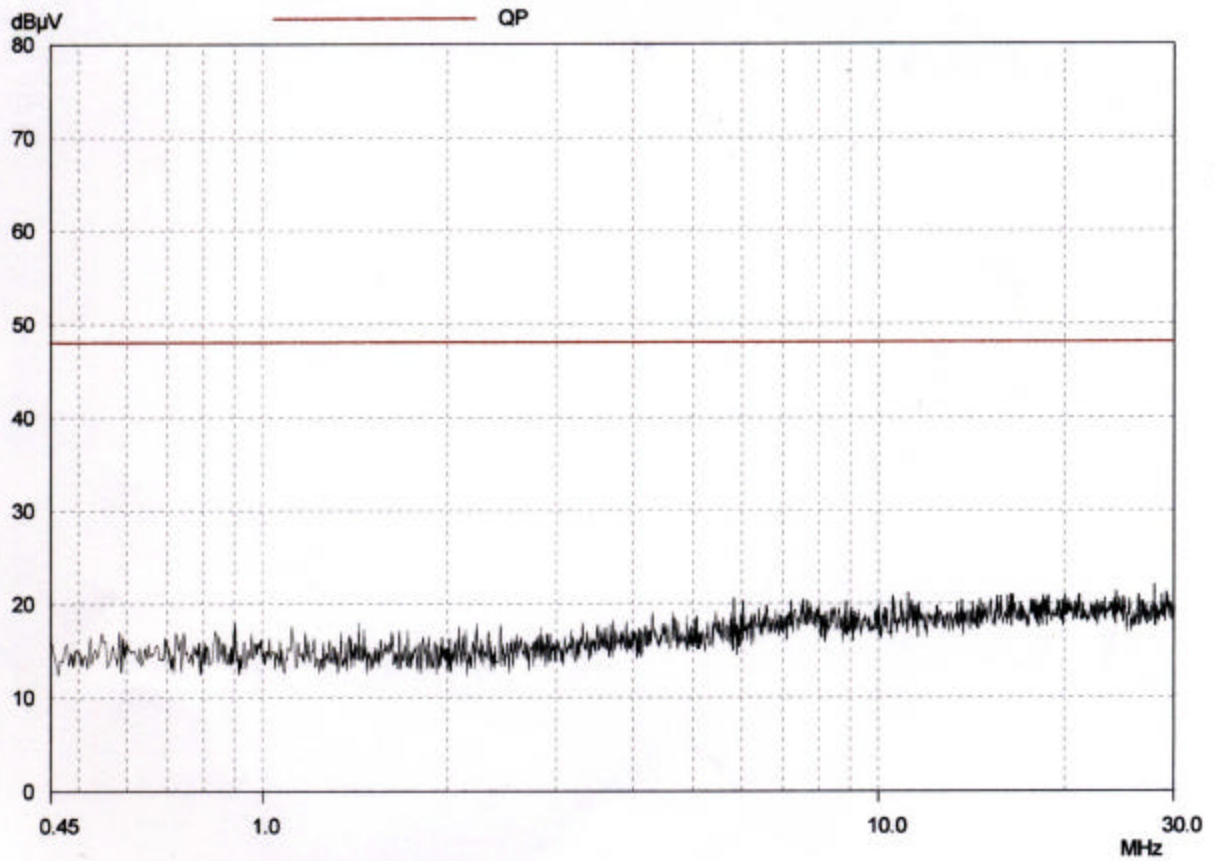

### Conducted Emission

#### Peak Value

EUT: Remote Control Extender  
Manuf: TRANS  
Op Cond: Working  
Operator: Rick Hu  
Test Spec: FCC Class B  
Comment: L2  
Model : DSC-IR100A

Final Measurement:      Detector: X QP  
                                 Meas Time: 500msec  
                                 Peaks: 8  
                                 Acc Margin: 10 dB

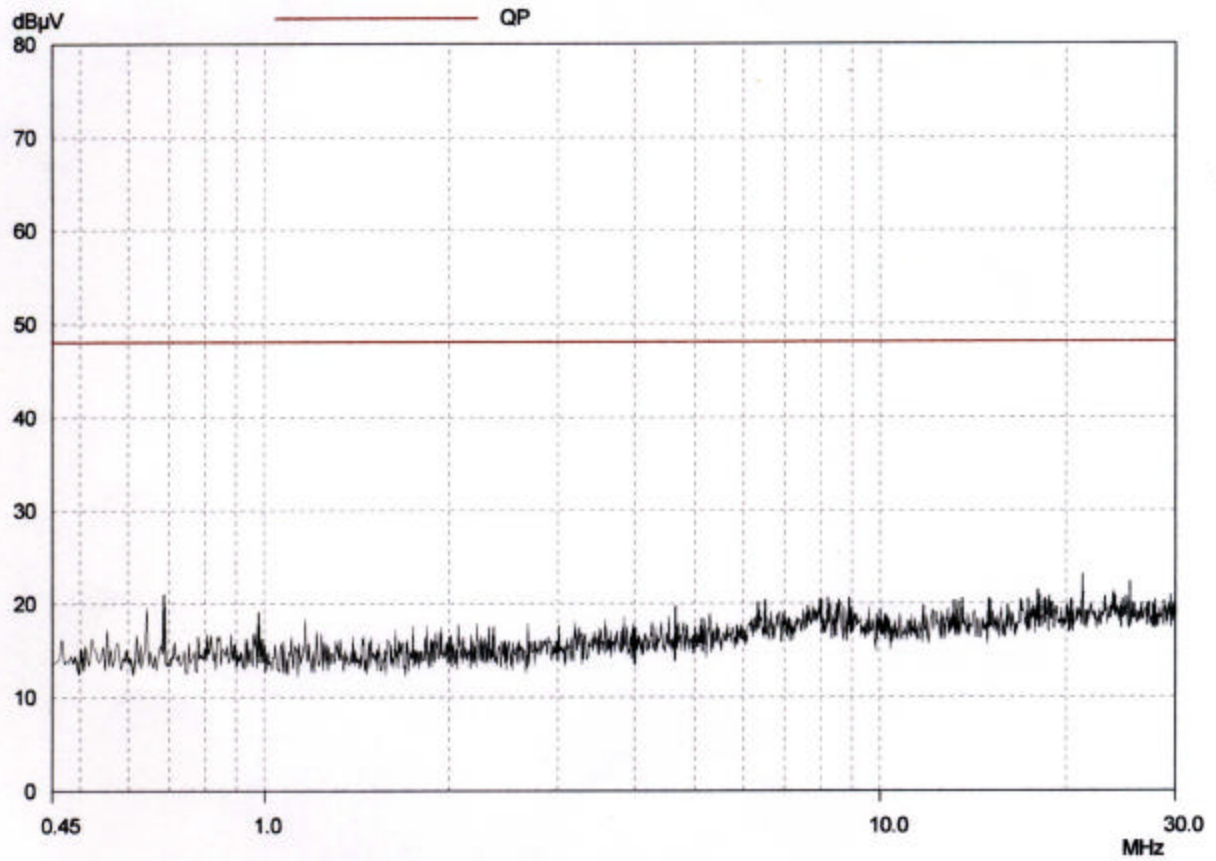



## 5.4 Result Data Calculation

The result data is calculated by adding the LISN Factor to the measured reading. The basic equation with a sample calculation is as follows:

$$\mathbf{RESULT = READING + LISN FACTOR}$$

Assume a receiver reading of 22.5 dB  $\mu$  V is obtained, and LISN Factor is 0.1 dB, then the total of field strength is 22.6 dB  $\mu$  V.

$$\begin{aligned} \text{RESULT} &= 22.5 + 0.1 = 22.6 \text{ dB } \mu \text{ V} \\ \text{Level in } \mu \text{ V} &= \text{Common Antilogarithm}[(22.6 \text{ dB } \mu \text{ V})/20] \\ &= 13.48 \mu \text{ V} \end{aligned}$$

## 5.5 Conducted Measurement Equipment

The following test equipment are used during the conducted test .

Equipment	Manufacturer	Model No.	Serial No.	Calibrated until
EMI Test Receiver	Rohde and Schwarz	ESCS 30	13054409-001	Sep. 18, 2002
Line Impedance Stabilization network	Telemeter	NNB-4/32T	13057706-001	Mar. 28, 2002

Note: The standards used to perform this calibration are traceable to NML/ROC and NIST/USA.

### 5.6 Conducted Measurement Photos

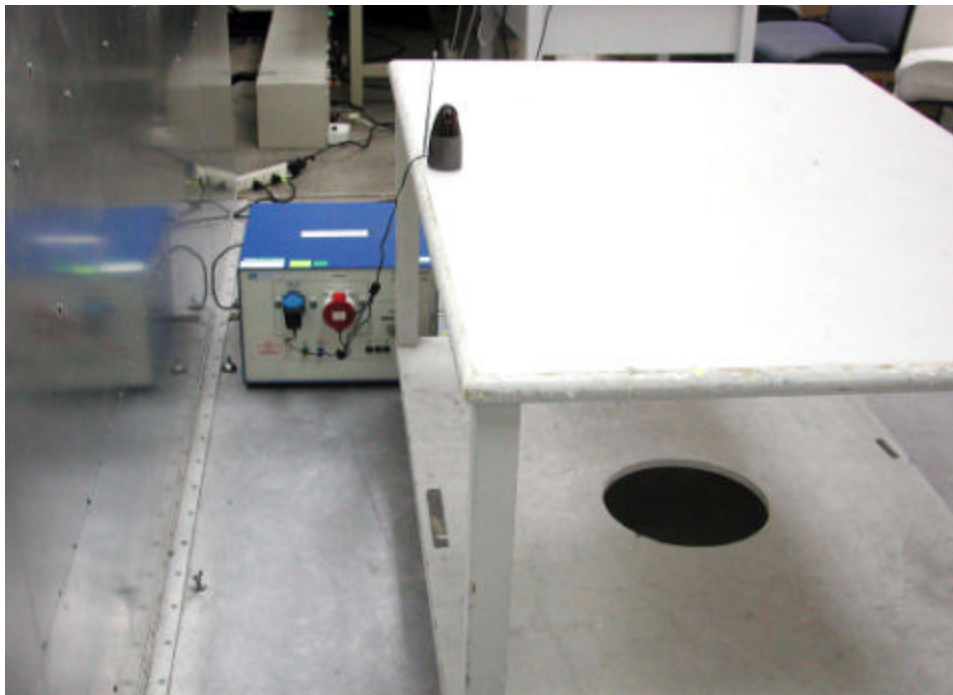

## **6. LIMIT OF TRANSMISSION TIME**

### **6.1 Applicable Standard**

According to 15.231(a)(1), a manually operated transmitter shall employ a switch that will automatically deactivate the transmitter within not more than 5 seconds of being released.

### **6.2 Active Time**

This transmitter is operated by manual and active time is less than 1 second after being released.