



<b>Prüfbericht-Nr.:</b> <i>Test Report No.:</i>	<b>10044699 001</b>	<b>Auftrags-Nr.:</b> <i>Order No.:</i>	<b>114015425</b>	<b>Seite 1 von 47</b> <i>Page 1 of 47</i>
<b>Kunden-Referenz-Nr.:</b> <i>Client Reference No.:</i>	<b>N/A</b>	<b>Auftragsdatum:</b> <i>Order date:</i>	<b>October 25, 2013</b>	
<b>Auftraggeber:</b> <i>Client:</i>	<b>Trans Electric Co., Ltd., 771, Sec. 2, Chungsan Road, Huatang, Changhua, Taiwan</b>			
<b>Prüfgegenstand:</b> <i>Test item:</i>	<b>Bluetooth Music Transmitter and Splitter</b>			
<b>Bezeichnung / Typ-Nr.:</b> <i>Identification / Type No.:</i>	<b>BTX-1000, BTX-1200</b>			
<b>Auftrags-Inhalt:</b> <i>Order content:</i>	<b>FCC Part 15C Test report</b>			
<b>Prüfgrundlage:</b> <i>Test specification:</i>	<b>FCC 47CFR Part 15: Subpart C Section 15.247 RSS-210 (12-2010) A8</b>			
<b>Wareneingangsdatum:</b> <i>Date of receipt:</i>	<b>11/13/2013</b>			
<b>Prüfmuster-Nr.:</b> <i>Test sample No.:</i>	<b>A000028921-002 A000028921-001</b>			
<b>Prüfzeitraum:</b> <i>Testing period:</i>	<b>November 25, 2013 - November 29, 2013</b>			
<b>Ort der Prüfung:</b> <i>Place of testing:</i>	<b>EMC Laboratory Taipei</b>			
<b>Prüflaboratorium:</b> <i>Testing laboratory:</i>	<b>TUV Rheinland Taiwan Ltd.</b>			
<b>Prüfergebnis*:</b> <i>Test result*:</i>	<b>Pass</b>			
<b>geprüft von / tested by:</b>		<b>kontrolliert von / reviewed by:</b>		
<b>2014-01-08</b>  <b>Danny S. C. Sung/Project Manager</b>		<b>2014-01-08</b>  <b>Rene Charton/Senior Project Manager</b>		
<b>Datum</b> <i>Date</i>	<b>Name / Stellung</b> <i>Name / Position</i>	<b>Unterschrift</b> <i>Signature</i>	<b>Datum</b> <i>Date</i>	<b>Name / Stellung</b> <i>Name / Position</i>
<b>Sonstiges / Other:</b>				
<b>Zustand des Prüfgegenstandes bei Anlieferung:</b> <i>Condition of the test item at delivery:</i>		<b>Prüfmuster vollständig und unbeschädigt</b> <i>Test item complete and undamaged</i>		
* Legende: 1 = sehr gut    2 = gut    3 = befriedigend    4 = ausreichend    5 = mangelhaft P(ass) = entspricht o.g. Prüfgrundlage(n)    F(ail) = entspricht nicht o.g. Prüfgrundlage(n)    N/A = nicht anwendbar    N/T = nicht getestet				
Legend: 1 = very good    2 = good    3 = satisfactory    4 = sufficient    5 = poor P(ass) = passed a.m. test specification(s)    F(ail) = failed a.m. test specification(s)    N/A = not applicable    N/T = not tested				
<b>Dieser Prüfbericht bezieht sich nur auf das o.g. Prüfmuster und darf ohne Genehmigung der Prüfstelle nicht auszugsweise vervielfältigt werden. Dieser Bericht berechtigt nicht zur Verwendung eines Prüfzeichens.</b> <i>This test report only relates to the a. m. test sample. Without permission of the test center this test report is not permitted to be duplicated in extracts. This test report does not entitle to carry any test mark.</i>				

V04

## TEST SUMMARY

### 5.1.1 ANTENNA REQUIREMENT

RESULT: *Passed*

### 5.1.2 PEAK OUTPUT POWER

RESULT: *Passed*

### 5.1.3 20DB BANDWIDTH

RESULT: *Passed*

### 5.1.4 99% BANDWIDTH

RESULT: *Passed*

### 5.1.5 CONDUCTED SPURIOUS EMISSIONS AND FREQUENCY BAND EDGE MEASURED IN 100KHz BANDWIDTH

RESULT: *Passed*

### 5.1.6 SPURIOUS EMISSION

RESULT: *Passed*

### 5.1.7 FREQUENCY SEPARATION

RESULT: *Passed*

### 5.1.8 NUMBER OF HOPPING FREQUENCY

RESULT: *Passed*

### 5.1.9 TIME OF OCCUPANCY

RESULT: *Passed*

### 5.2.1 MAINS CONDUCTED EMISSIONS

RESULT: *Passed*

### 6.1.1 ELECTROMAGNETIC FIELDS

RESULT: *Passed*

## Contents

<b>1.</b>	<b>GENERAL REMARKS .....</b>	<b>5</b>
<b>1.1</b>	<b>COMPLEMENTARY MATERIALS.....</b>	<b>5</b>
<b>2.</b>	<b>TEST SITES .....</b>	<b>6</b>
<b>2.1</b>	<b>TEST FACILITIES .....</b>	<b>6</b>
<b>2.2</b>	<b>LIST OF TEST AND MEASUREMENT INSTRUMENTS.....</b>	<b>6</b>
<b>2.3</b>	<b>TRACEABILITY .....</b>	<b>7</b>
<b>2.4</b>	<b>CALIBRATION .....</b>	<b>7</b>
<b>2.5</b>	<b>MEASUREMENT UNCERTAINTY .....</b>	<b>7</b>
<b>3.</b>	<b>GENERAL PRODUCT INFORMATION.....</b>	<b>8</b>
<b>3.1</b>	<b>PRODUCT FUNCTION AND INTENDED USE .....</b>	<b>8</b>
<b>3.2</b>	<b>SYSTEM DETAILS AND RATINGS.....</b>	<b>8</b>
<b>3.3</b>	<b>INDEPENDENT OPERATION MODES.....</b>	<b>9</b>
<b>3.4</b>	<b>NOISE GENERATING AND NOISE SUPPRESSING PARTS .....</b>	<b>10</b>
<b>3.5</b>	<b>SUBMITTED DOCUMENTS.....</b>	<b>10</b>
<b>4.</b>	<b>TEST SET-UP AND OPERATION MODES.....</b>	<b>11</b>
<b>4.1</b>	<b>PRINCIPLE OF CONFIGURATION SELECTION .....</b>	<b>11</b>
<b>4.2</b>	<b>TEST OPERATION AND TEST SOFTWARE.....</b>	<b>11</b>
<b>4.3</b>	<b>SPECIAL ACCESSORIES AND AUXILIARY EQUIPMENT .....</b>	<b>11</b>
<b>4.4</b>	<b>COUNTERMEASURES TO ACHIEVE EMC COMPLIANCE.....</b>	<b>12</b>
<b>4.5</b>	<b>TEST SETUP DIAGRAM .....</b>	<b>12</b>
<b>5.</b>	<b>TEST RESULTS .....</b>	<b>14</b>
<b>5.1</b>	<b>TRANSMITTER REQUIREMENT &amp; TEST SUITES .....</b>	<b>14</b>
<b>5.1.1</b>	<i>Antenna Requirement .....</i>	<i>14</i>
<b>5.1.2</b>	<i>Peak Output Power .....</i>	<i>15</i>
<b>5.1.3</b>	<i>20dB Bandwidth .....</i>	<i>19</i>
<b>5.1.4</b>	<i>99% Bandwidth .....</i>	<i>23</i>
<b>5.1.5</b>	<i>Conducted spurious emissions and Frequency Band Edge measured in 100kHz Bandwidth.....</i>	<i>27</i>
<b>5.1.6</b>	<i>Spurious Emission .....</i>	<i>33</i>
<b>5.1.7</b>	<i>Frequency Separation.....</i>	<i>34</i>
<b>5.1.8</b>	<i>Number of hopping frequency.....</i>	<i>36</i>
<b>5.1.9</b>	<i>Time of Occupancy .....</i>	<i>38</i>
<b>5.2</b>	<b>MAINS EMISSIONS.....</b>	<b>41</b>
<b>5.2.1</b>	<i>Mains Conducted Emissions.....</i>	<i>41</i>
<b>6.</b>	<b>SAFETY HUMAN EXPOSURE .....</b>	<b>42</b>

<b>6.1</b>	<b>RADIO FREQUENCY EXPOSURE COMPLIANCE .....</b>	<b>42</b>
6.1.1	<i>Electromagnetic Fields.....</i>	<i>42</i>
<b>7.</b>	<b>PHOTOGRAPHS OF THE TEST SET-UP.....</b>	<b>43</b>
<b>8.</b>	<b>LIST OF TABLES .....</b>	<b>47</b>
<b>9.</b>	<b>LIST OF PHOTOGRAPHS.....</b>	<b>47</b>

## 1. General Remarks

### 1.1 Complementary Materials

All attachments are integral parts of this test report. This applies especially to the following appendix:

**Appendix PI: Photo Documentation internal view**  
(File Name: 10044699APPENDIX PI)

**Appendix PE: Photo Documentation external view**  
(File Name: 10044699APPENDIX PE)

**Appendix D: Test Result of Radiated Emissions**  
(File Name: 10044699APPENDIX D)

Test Specifications

The following standards were applied (in bold: product standards, otherwise: basic standards).

**Table 1: Applied Standard and Test Levels**

<b>Radio</b>
FCC CFR47 Part 15: Subpart C Section 15.247 ANSI C63.4:2009, Public Notice DA 00-705

## 2. Test Sites

### 2.1 Test Facilities

TUV Rheinland Taiwan Ltd.

11F. No.758, Sec. 4, Bade Rd., Songshan Dist.  
 Taipei City 105  
 Taiwan (R.O.C.)  
 FCC Registration No.: 365730

### 2.2 List of Test and Measurement Instruments

**Table 2: List of Test and Measurement Equipment**

Kind of Equipment	Manufacturer	Type	S/N	Calibrated until
EMI Test Receiver	R&S	ESCI 7	100797	20-Dec-13
Bilog Antenna	TESEQ	CBL6111D	29802	29-Jun-14
Spectrum Analyzer	R&S	FSV 40	100921	13-Dec-13
Horn Antenna	ETS-Lindgren	3117	138160	10-Jan-14
Horn Antenna (18GHz~40GHz)	COM-POWER	AH840	101031	29-Oct-15
Preamplifier (30MHz -1GHz)	HP	8447F	2805A03335	2-Sep-14
Preamplifier (18 GHz -40 GHz)	COM-POWER	PAM-840	461257	2-Sep-14
Pre-Amplifier (1GHz~18GHz)	EM Electronics	EM30180	60558	23-Oct-14
Loop Antenna	Schwarzbeck	FMZB 1513	1513-076	28-Sep-14
EMI Test Receiver	R&S	ESCI	101094	29-Aug-14
LISN (1 phase)	R&S	ENV216	101243	5-Jun-14
LISN	Rolf Heine	NNB-2/16Z	99080	30-Aug-14

## 2.3 Traceability

All measurement equipment calibrations are traceable to NML(Taiwan)/NIST(USA) or where calibration is performed outside Taiwan, to equivalent nationally recognized standards organizations.

## 2.4 Calibration

Equipment requiring calibration is calibrated periodically by the manufacturer or according to manufacturer's specifications. Additionally all equipment is verified for proper performance on a regular basis using in house standards or comparisons.

## 2.5 Measurement Uncertainty

The estimated combined standard uncertainty for radiated emissions and conducted emissions measurements are  $\pm 3$ dB.

**Table 3:** Emission Measurement Uncertainty

Parameter	Uncertainty
Radio Frequency	$\pm 1 \times 10^{-7}$
RF power, conducted	$\pm 1$ dB
Adjacent channel power	$\pm 3$ dB
Radiated emission of transmitter, valid up to 26 GHz	$\pm 6$ dB
Radiated emission of receiver, valid up to 26 GHz	$\pm 6$ dB
Temperature	$\pm 2$ °C
Humidity	$\pm 10$ %

### 3. General Product Information

#### 3.1 Product Function and Intended Use

This is a device which provides an Audio signal which is received via Bluetooth from a Wireless Mobile Device. model numbers "BTX-1000" and "BTX-1200" for new approval. Due to all model electrical constructions are identical, except for product case, one representative model with number "BTX-1000" was tested only.

For details refer to the User Guide, Data Sheet and Circuit Diagram.

#### 3.2 System Details and Ratings

**Table 4: Basic Information of EUT**

Item	EUT information
Kind of Equipment	Bluetooth Music Transmitter and Splitter
Type Designation	BTX-1000, BTX-1200
Brand Name	
FCC ID	BY4BTX1000

**Table 5: Technical Specification of EUT**

Technical Specification	Value
Operating Frequency	2402 MHz ~ 2480 MHz
Channel Spacing	1 MHz
Channel number	79
Operation Voltage	5 V
Modulation	GFSK, $\pi/4$ QPSK, 8 DPSK
Antenna gain	3 dBi



**Table 6: Frequency hopping information**

Technical Specification	Description
Hopping Range	Hereby we declare that the maximum frequency of this device is: 2402-2480MHz. This is according the Bluetooth Core Specification V2.1+EDR for devices which will be operated in the USA. This was checked during the Bluetooth Qualification tests (Test Case: TRM/CA/04).
Hopping Sequence	Example of a 79 hopping sequence in data mode:  33,04,21,44,23,42,53,46,55,48,40,59,72,29,76,31,08,73,07,75,09,45,60,39,58,13,47,11,77,52,35,50,65,54,67,56,69,62,71,64, 7,25,27,66,57,70,74,61,78,63,10,41,05,43,15,44,64,68,02,70,06,01,51,03,55,05,03,66,53,49,36,47,
Receiver input bandwidth	<p>The input bandwidth of the receiver is 1MHz. In every connection one Bluetooth device is the master and the other one is the slave. The master determines the hopping sequence. The slave follows this sequence. Both devices shift between RX and TX time slot according to the clock of the master.</p> <p>Additionally the type of connection is set up at the beginning of the connection. The master adapts its hopping frequency and its TX/RX timing according to the packet type of the connection. Also the slave of the connection will use these settings.</p> <p>Repeating of a packer has no influence on the hopping sequence. The hopping sequence generated by the master of the connection will be followed in any case.</p> <p>That means a repeated packet will not be send on the same frequency, it is send on the next frequency of the hopping sequence.</p>

### 3.3 Independent Operation Modes

The basic operation modes are:

- A. Transmitting
  - 1. Low channel
  - 2. Middle channel
  - 3. High channel
- B. Receiving
- C. Standby
- D. Off

### **3.4 Noise Generating and Noise Suppressing Parts**

Refer to the Circuit Diagram.

### **3.5 Submitted Documents**

- Bill of Material
- PCB Layout
- Photo Document
- Technical Description
- Circuit Diagram
- Instruction Manual
- Rating Label

## 4. Test Set-up and Operation Modes

### 4.1 Principle of Configuration Selection

The equipment under test (EUT) was configured to measure its maximum power level. The test modes were adapted accordingly in reference to the instructions for use.

### 4.2 Test Operation and Test Software

Test operation refers to test setup in chapter 4. All testing were performed according to the procedures in ANSI C63.10: 2009 and DA 00-705 of March 30, 2000.

The samples were used as follows:

Conducted: **A000028921-001**

Radiation: **A000028921-002**

Full test was applied on all test modes, but only worst case was shown.

### 4.3 Special Accessories and Auxiliary Equipment

The product has been tested together with the following additional accessories:

Kind of Equipment	Manufacturer	Model Name	S/N
Laptop	MSI	MSI4532 (CX420MX)	CX420 MX-233TWK 1008000096

## 4.4 Countermeasures to achieve EMC Compliance

The test sample which has been tested contained the noise suppression parts as described in the Constructional Data Form or the Technical Construction File. No additional measures were employed to achieve compliance.

## 4.5 Test Setup Diagram

### Diagram of Measurement Configuration for Radiation Test

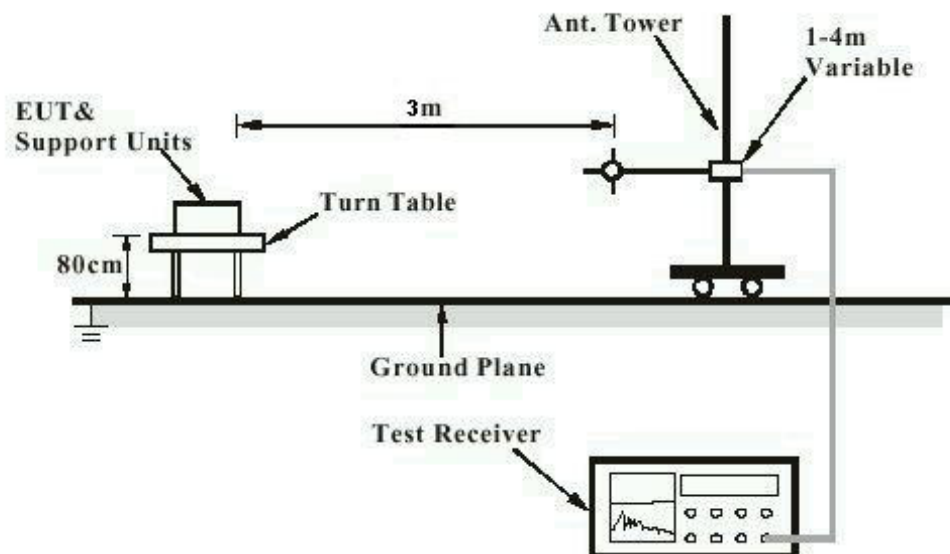

**Diagram of Measurement Equipment Configuration for Mains Conduction Measurement**

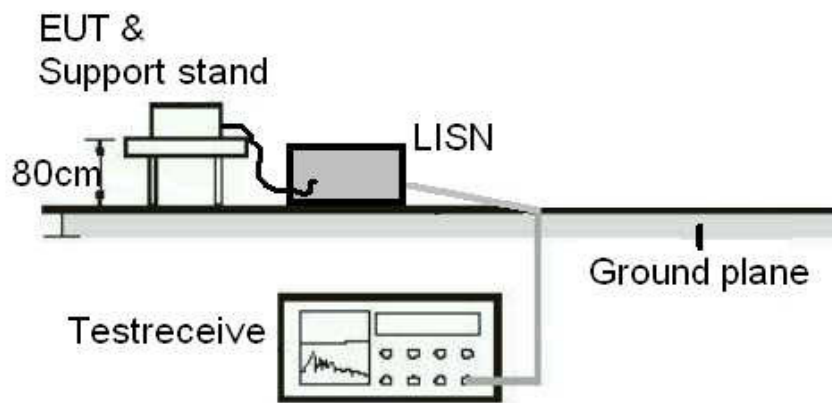

**Diagram of Measurement Equipment Configuration for Conducted Transmitter Measurement**

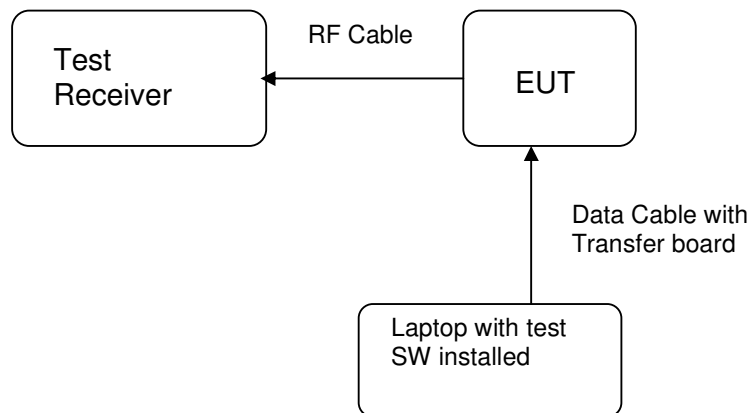

## 5. Test Results

### 5.1 Transmitter Requirement & Test Suites

#### 5.1.1 Antenna Requirement

**RESULT:** **Passed**

Test standard	:	FCC Part 15.247(b)(4), Part 15.203 and RSS-Gen 7.1.4
Limit	:	the use of antennas with directional gains that do not exceed 6 dBi

According to the manufacturer declaration, the EUT has an antenna with a directional gain of 3 dBi. The antenna is a Chip Antenna soldered to the PCB with no possibility of replacement with a non-approved antenna by the end-user. Therefore, the EUT is considered to comply with this provision.

.

Refer to EUT photo for details.

## 5.1.2 Peak Output Power

**RESULT:**
**Passed**

Test standard : FCC Part 15.247(b)(1), RSS-210 A8.4(2)  
 Basic standard : DA 00-705 of March 30, 2000  
 Kind of test site : Shielded room

**Test setup**

Test Channel : Low/ Middle/ High  
 Operation Mode : A

Ambient temperature : 22-26 °C  
 Relative humidity : 50-65 %  
 Atmospheric pressure : 100-103 kPa

**Table 7: Test result of Peak Output Power, GFSK modulation**

Channel	Channel Frequency	Peak Output Power		Limit
	(MHz)	(dBm)	(W)	(W)
Low Channel	2402	-1.3	0.00074	0.125
Middle Channel	2441	-2.27	0.00059	0.125
High Channel	2480	-2.61	0.00055	0.125

**Table 8: Test result of Peak Output Power, 8DPSK modulation**

Channel	Channel Frequency	Peak Output Power		Limit
	(MHz)	(dBm)	(W)	(W)
Low Channel	2402	-1.21	0.00076	0.125
Middle Channel	2441	-2.06	0.00062	0.125
High Channel	2480	-2.4	0.00058	0.125

Pmax: 0.7568 mW

## Test Plot of Peak Output Power, GFSK modulation

### Low Channel

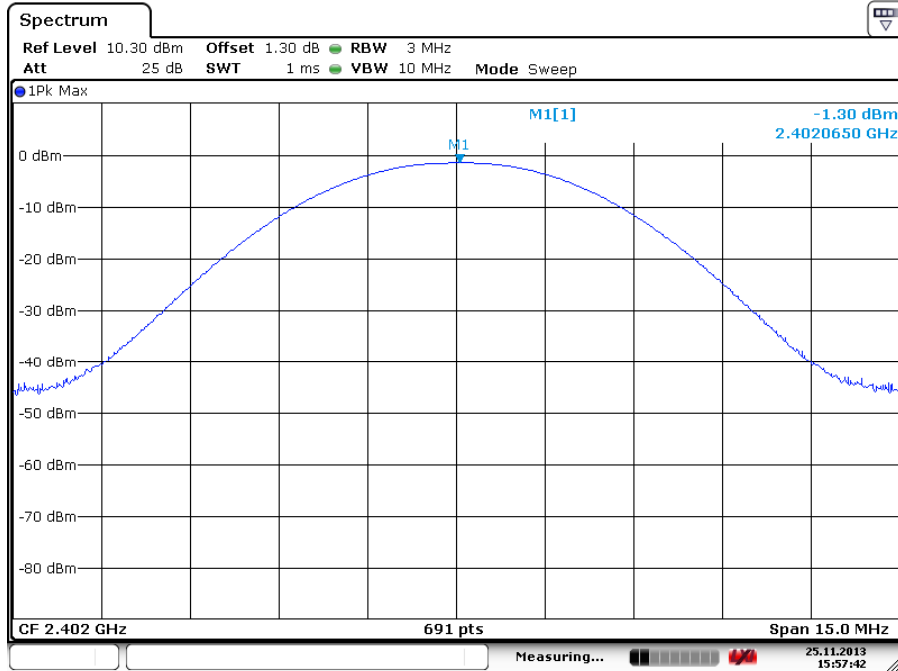

Date: 25.NOV.2013 15:57:42

### Middle Channel

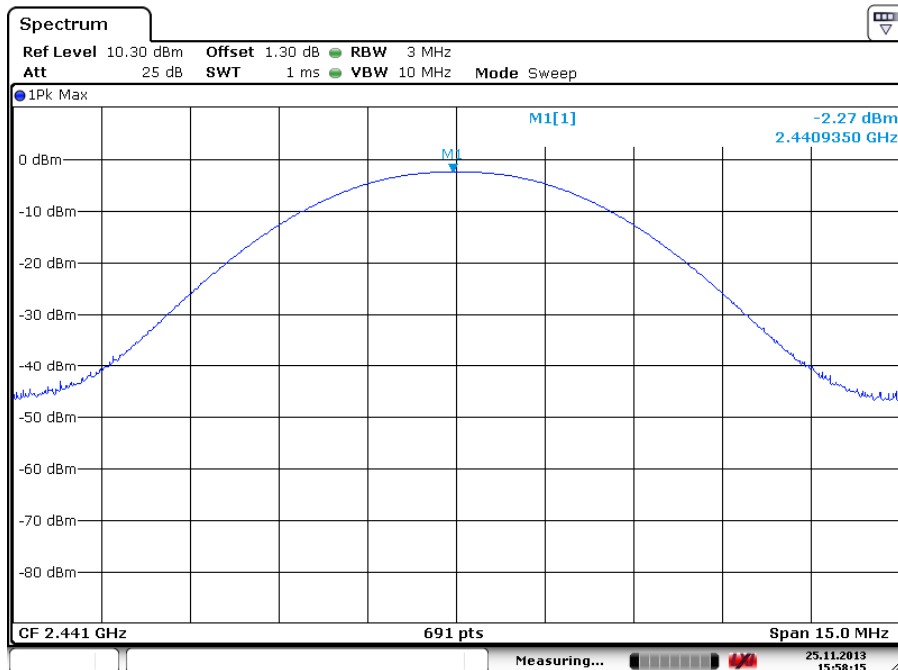

Date: 25.NOV.2013 15:58:16

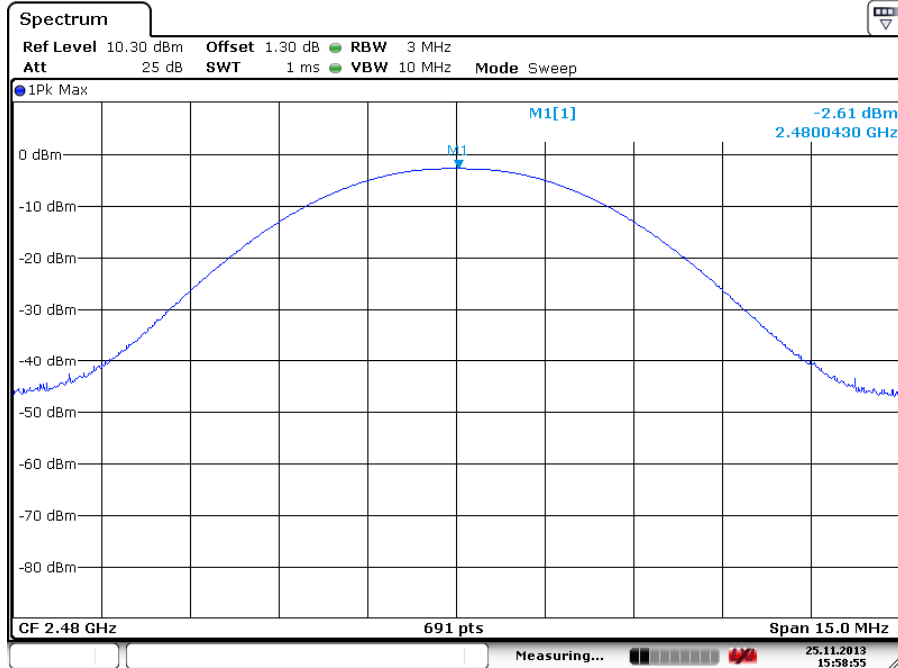

**High Channel**

Date: 25.NOV.2013 15:58:56

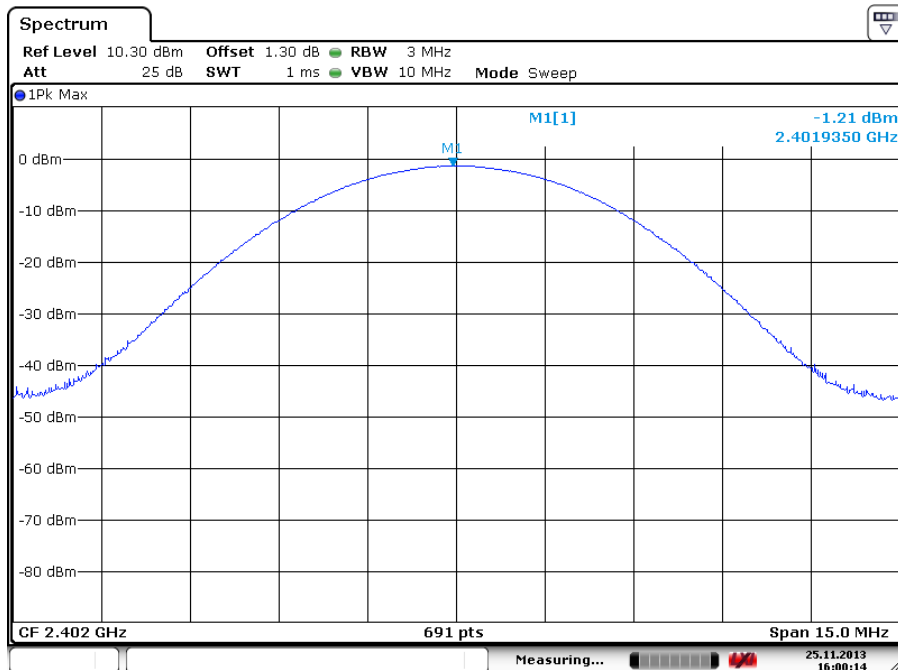
**Test Plot of Peak Output Power, 8DPSK modulation**
**Low Channel**

Date: 25.NOV.2013 16:00:15

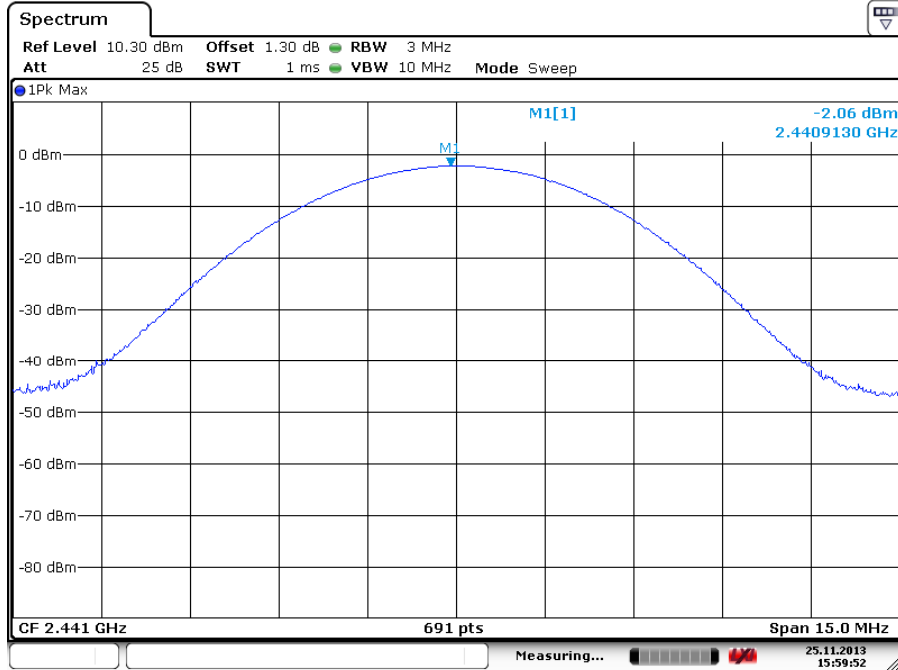
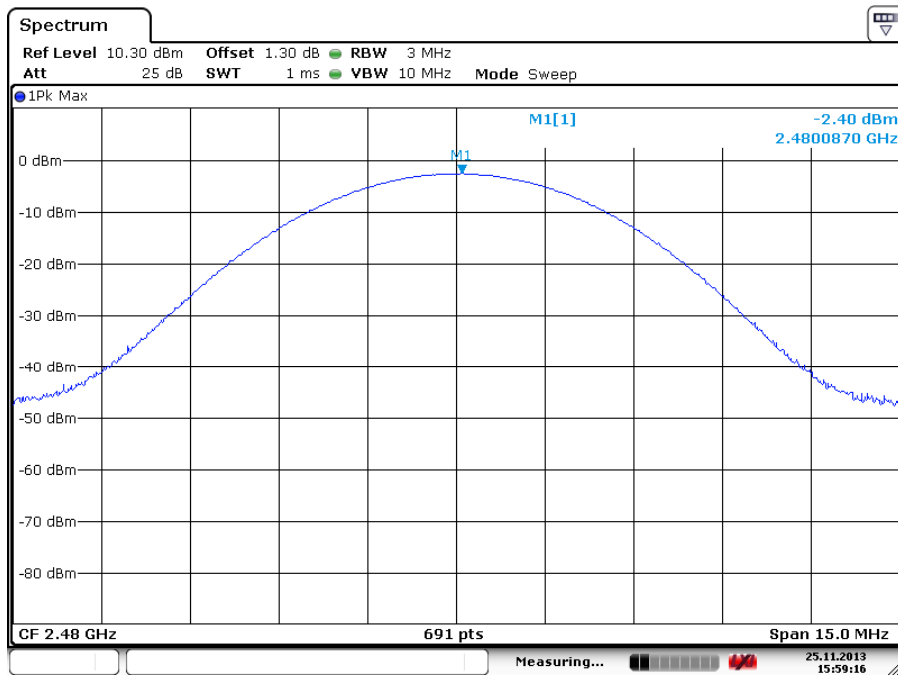
**Middle Channel**

**High Channel**

### 5.1.3 20dB Bandwidth

**RESULT:**
**Passed**

Test standard : FCC Part 15.247(a)(1), RSS-210 A8.1(a)  
 Basic standard : DA 00-705 of March 30, 2000  
 Kind of test site : Shielded room

**Test setup**

Test Channel : Low/ Middle/ High  
 Operation Mode : A

Ambient temperature : 22-26°C  
 Relative humidity : 50-65%  
 Atmospheric pressure : 100-103 kPa

**Table 9: Test result of 20dB Bandwidth, GFSK modulation**

Channel	Channel Frequency (MHz)	20dB Bandwidth (MHz)	Limit (MHz)	Result
Low Channel	2402	0.938	1.5	Pass
Mid Channel	2441	0.944	1.5	Pass
High Channel	2480	0.932	1.5	Pass

Note: Limit is for Channel Separation of 1 MHz and a power limit of 125 mW.

**Table 10: Test result of 20dB Bandwidth, 8DPSK modulation**

Channel	Channel Frequency (MHz)	20dB Bandwidth (MHz)	Limit (MHz)	Result
Low Channel	2402	1.285	1.5	Pass
Mid Channel	2441	1.265	1.5	Pass
High Channel	2480	1.285	1.5	Pass

Note: Limit is for Channel Separation of 1 MHz and a power limit of 125 mW.

## Test Plot of 20dB Bandwidth, GFSK modulation

### Low Channel

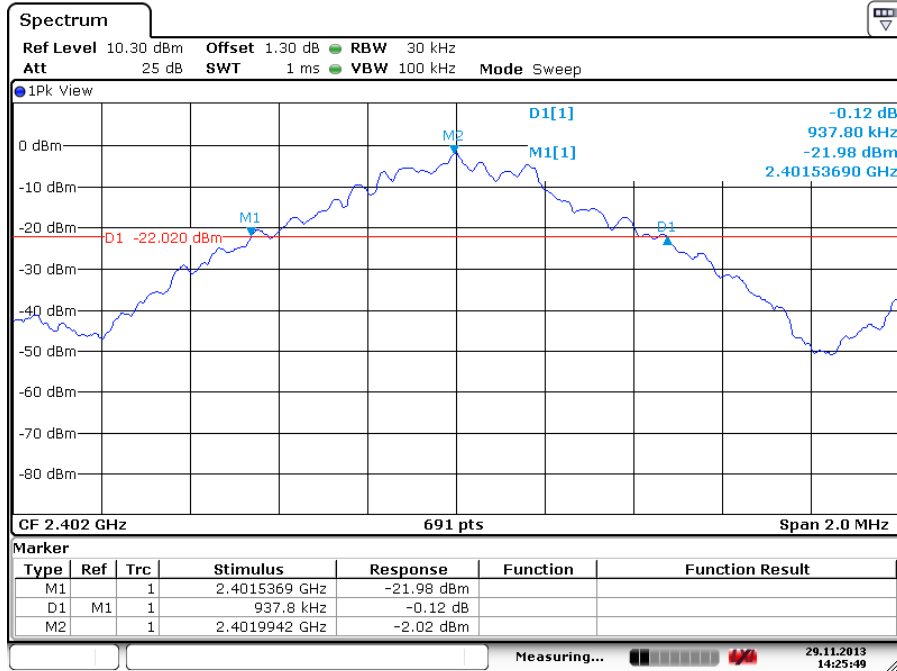

Date: 29.NOV.2013 14:25:49

### Middle Channel

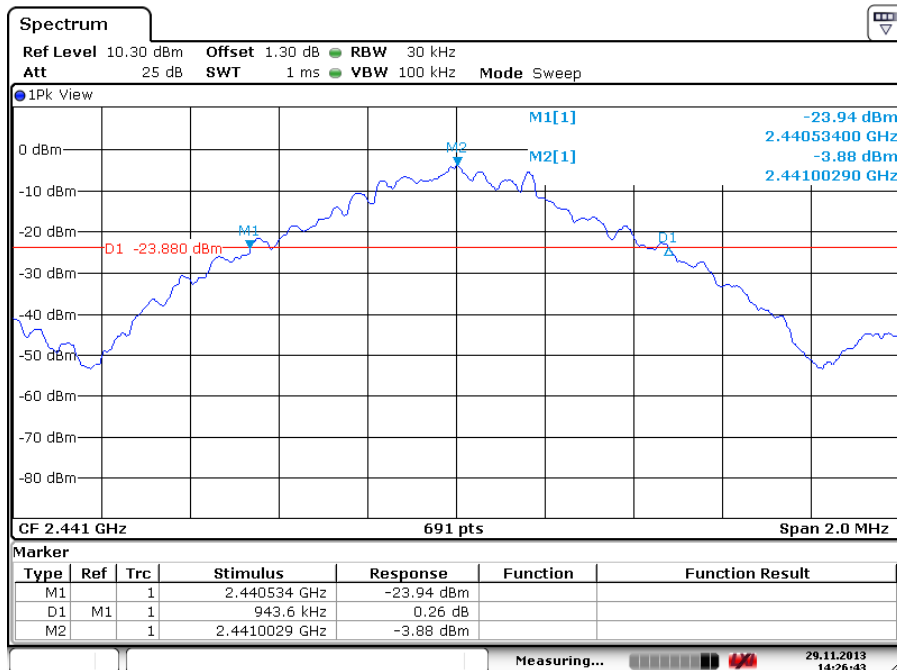

Date: 29.NOV.2013 14:26:43

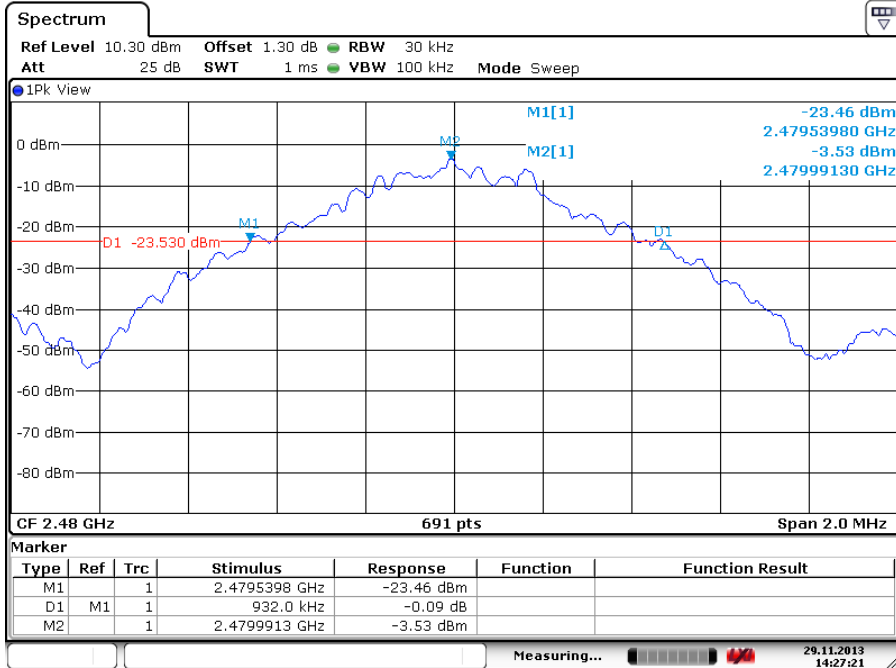
**High Channel**

Date: 29.NOV.2013 14:27:21

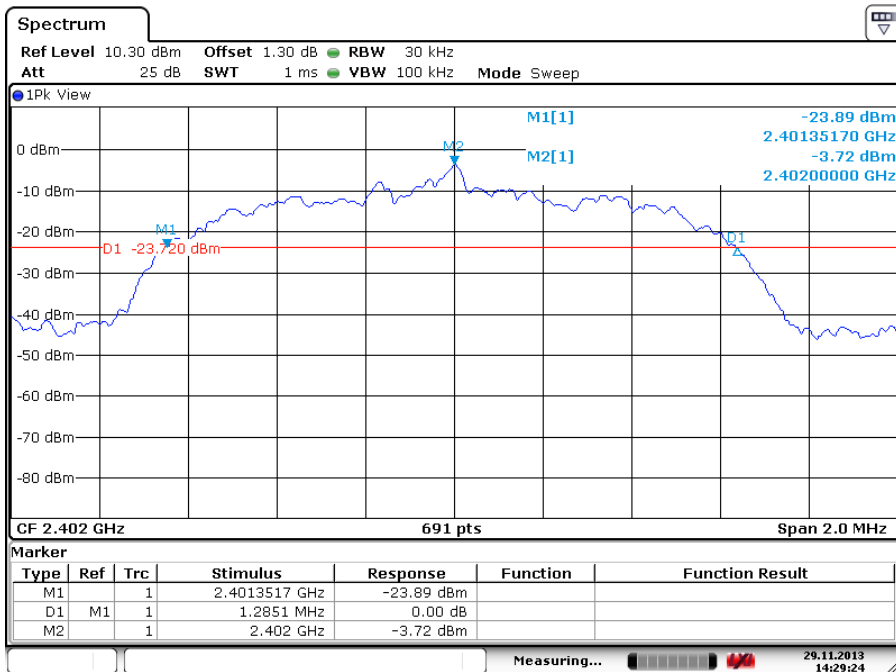
**Test Plot of 20dB Bandwidth, 8DPSK modulation**
**Low Channel**

Date: 29.NOV.2013 14:29:24

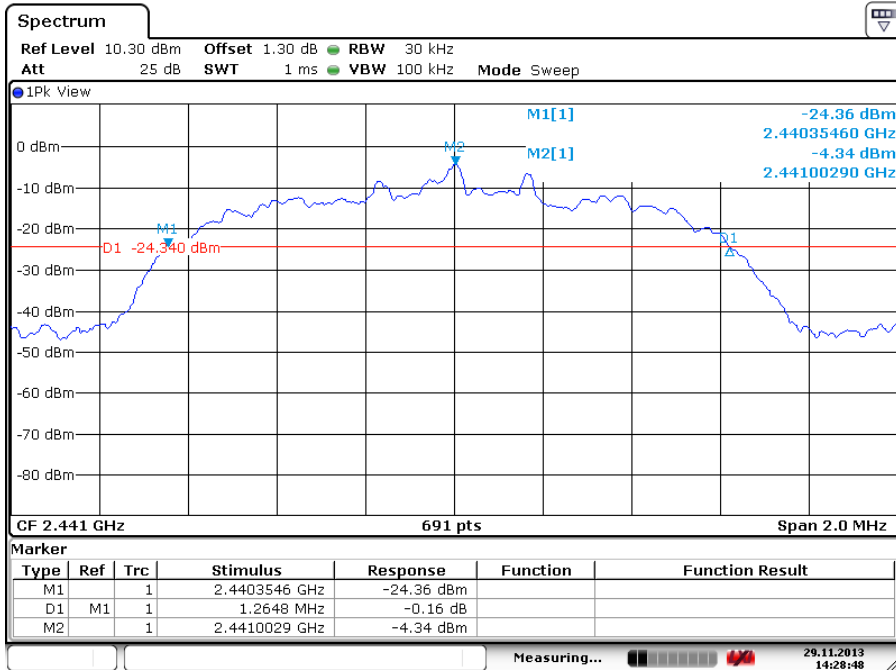
**Middle Channel**

Date: 29.NOV.2013 14:28:48

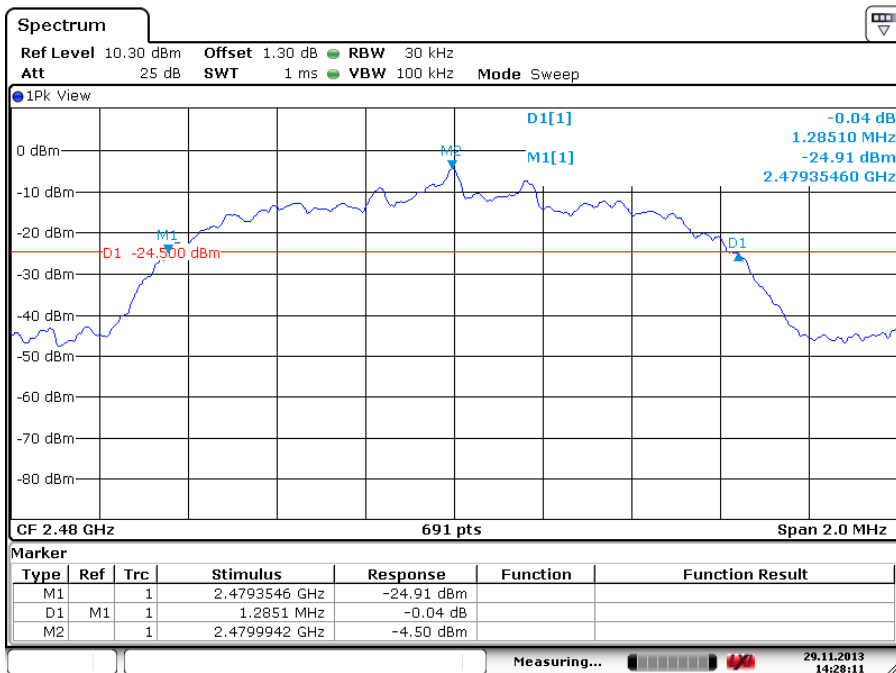
**High Channel**

Date: 29.NOV.2013 14:28:11

### 5.1.4 99% Bandwidth

**RESULT:**
**Passed**

Test standard : RSS-Gen (Issue 3) Dec. 2010  
 Basic standard : RSS-Gen (Issue 3) Dec. 2010  
 Kind of test site : Shielded room

**Test setup**

Test Channel : Low/ Middle/ High  
 Operation Mode : A  
  
 Ambient temperature : 22-26°C  
 Relative humidity : 50-65%  
 Atmospheric pressure : 100-103 kPa

**Table 11: Test result of 99% Bandwidth, GFSK modulation**

Channel	Channel Frequency (MHz)	99% Bandwidth (kHz)	Limit (MHz)	Result
Low Channel	2402	872.6	/	Pass
Mid Channel	2441	876.9	/	Pass
High Channel	2480	868.3	/	Pass

**Table 12: Test result of 99% Bandwidth, PSK modulation**

Channel	Channel Frequency (MHz)	99% Bandwidth (kHz)	Limit (MHz)	Result
Low Channel	2402	1189.5	/	Pass
Mid Channel	2441	1185.2	/	Pass
High Channel	2480	1185.2	/	Pass

## Test Plot of 99% Bandwidth, GFSK modulation

### Low Channel

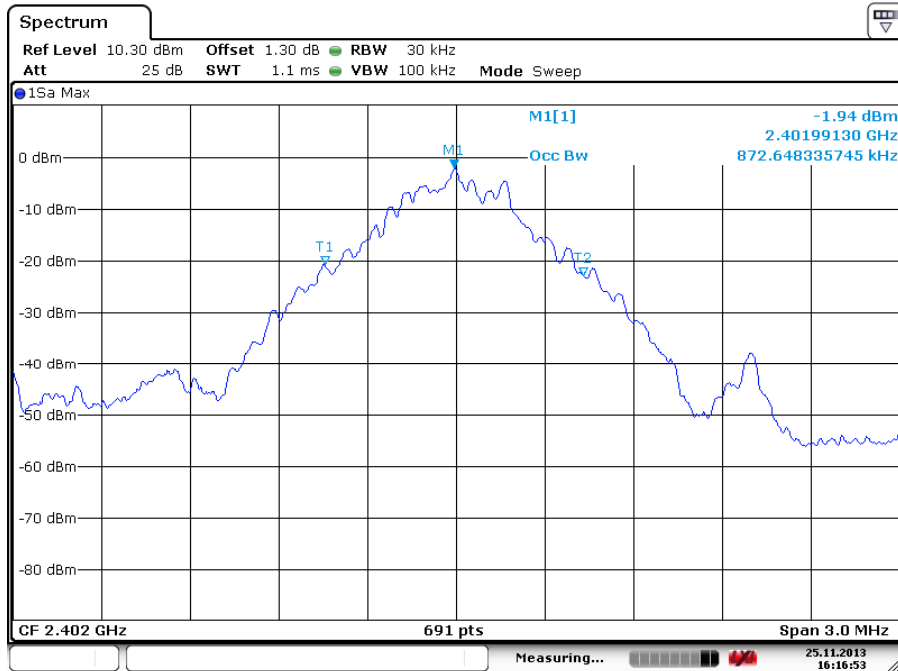

Date: 25.NOV.2013 16:16:54

### Middle Channel

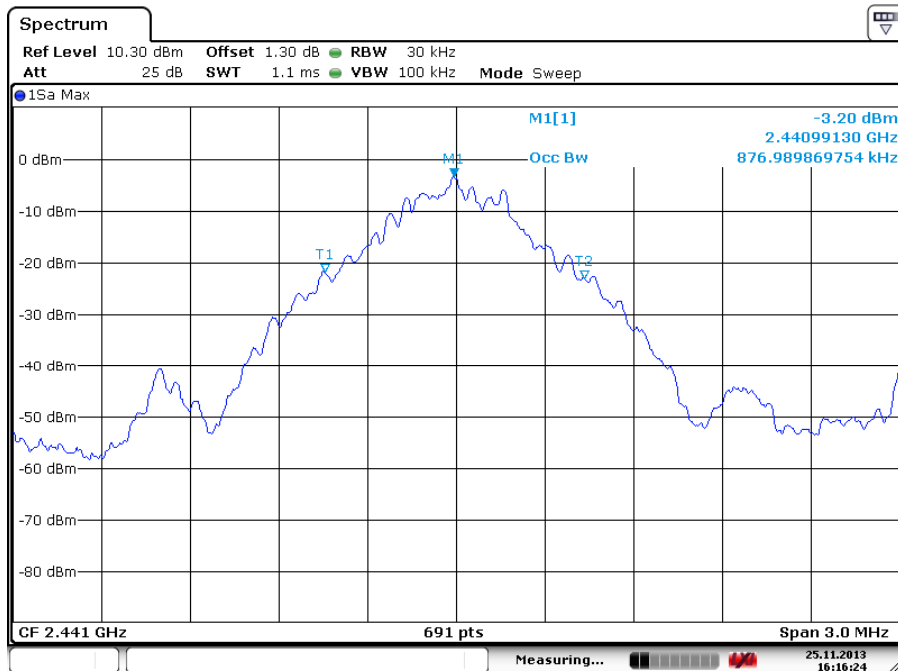

Date: 25.NOV.2013 16:16:25

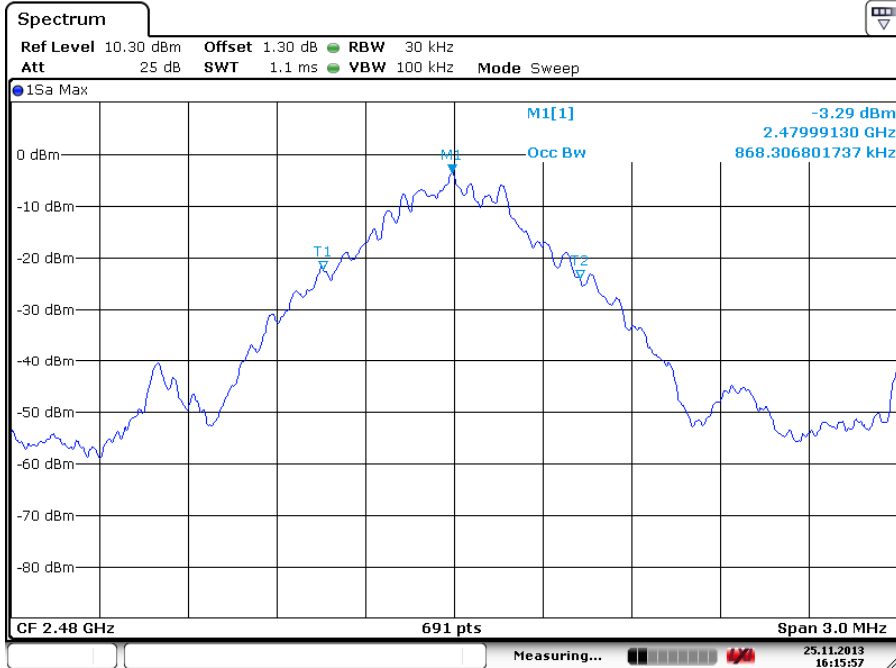

**High Channel**

Date: 25.NOV.2013 16:15:58

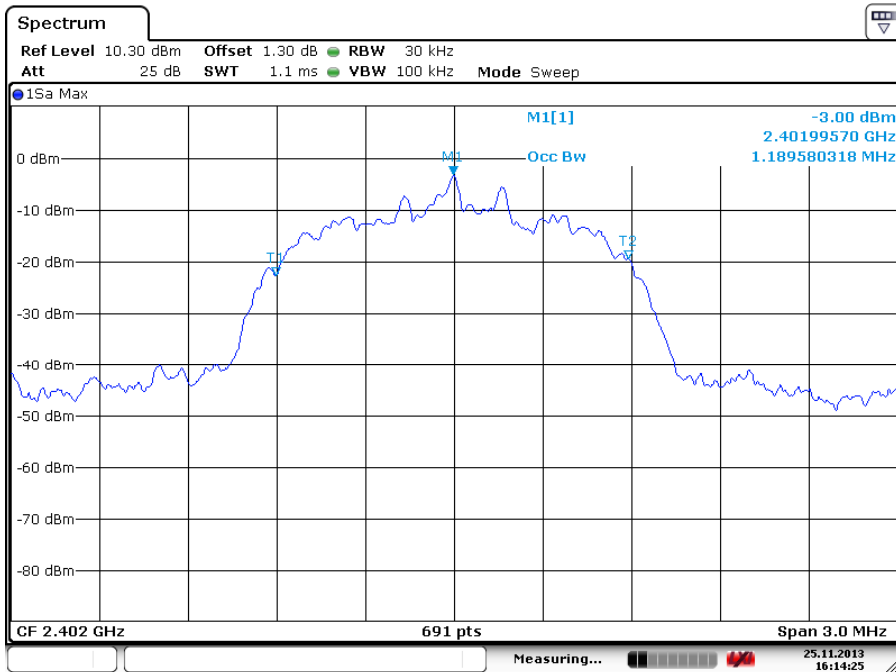
**Test Plot of 99% Bandwidth, 8DPSK modulation**
**Low Channel**

Date: 25.NOV.2013 16:14:25

**Middle Channel**

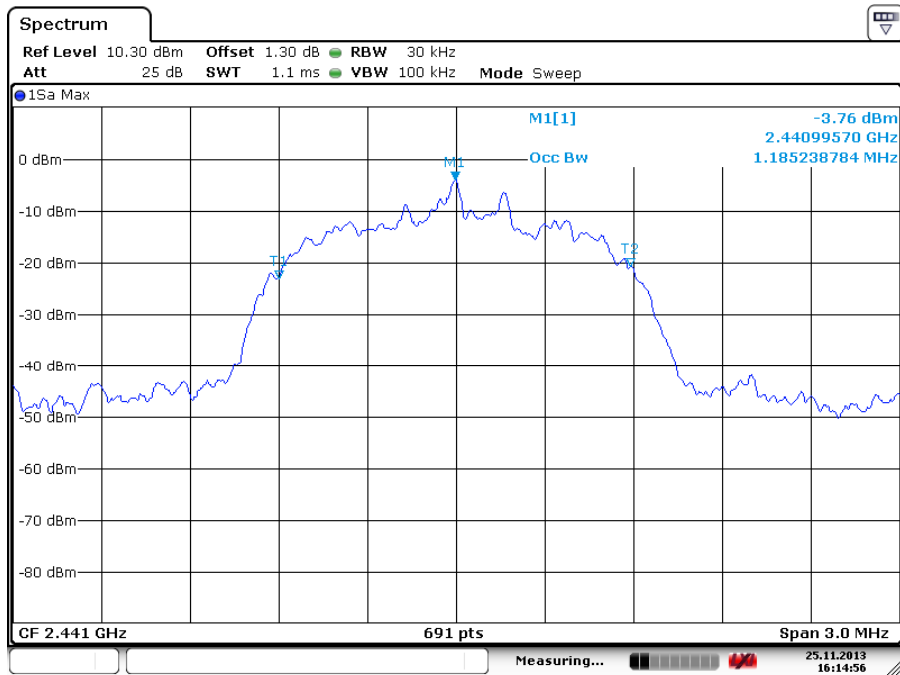

Date: 25.NOV.2013 16:14:57

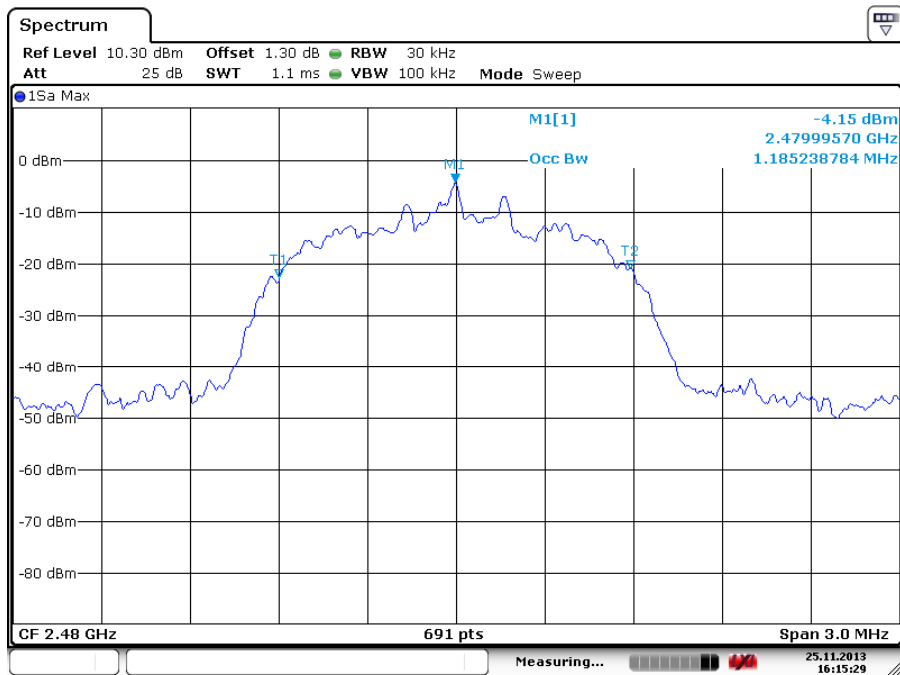
**High Channel**

Date: 25.NOV.2013 16:15:29

### 5.1.5 Conducted spurious emissions and Frequency Band Edge measured in 100kHz Bandwidth

**RESULT:****Passed**

Test standard	:	FCC part 15.247(d), RSS-210 A8.5
Basic standard	:	DA 00-705 of March 30, 2000
Limit	:	20dB (below that in the 100kHz bandwidth within the band that contains the highest level of the desired power)
Kind of test site	:	Shielded room

**Test setup**

Test Channel	:	Low/ Middle/ High
Operation Mode	:	A
Ambient temperature	:	22-26°C
Relative humidity	:	50-65%
Atmospheric pressure	:	100-103 kPa

All emissions are more than 20dB below fundamental, details refer to following test plot, and compliance is achieved as well.

Due to the small size of the product and that there are no inductive components of significant size, 9kHz to 30MHz frequency range is not tested based on technical judgment.

## Test Plot of 100kHz Conducted Emissions, GFSK modulation

### Low Channel

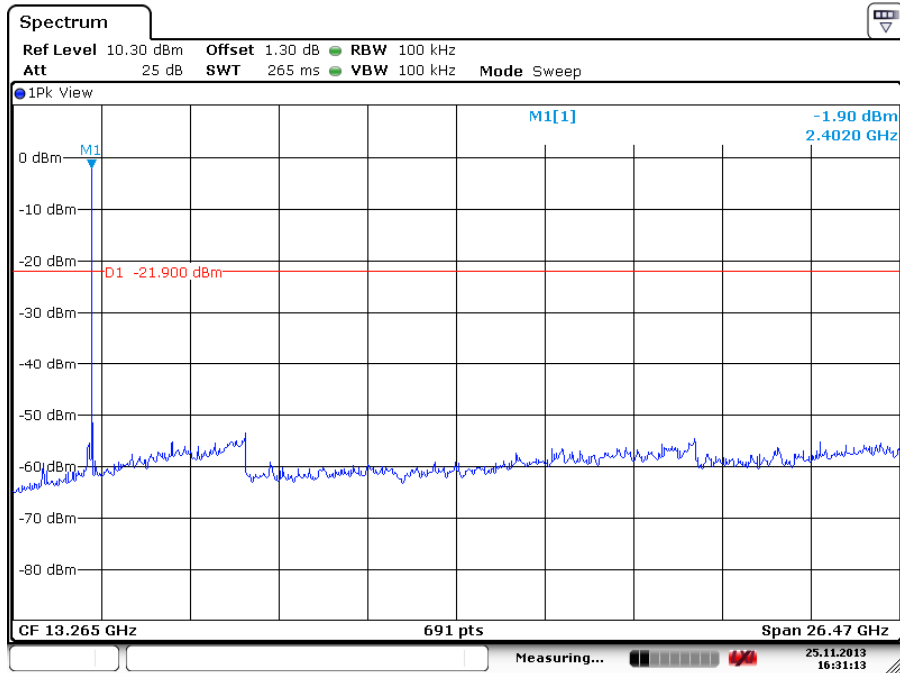

Date: 25.NOV.2013 16:31:14

### Middle Channel

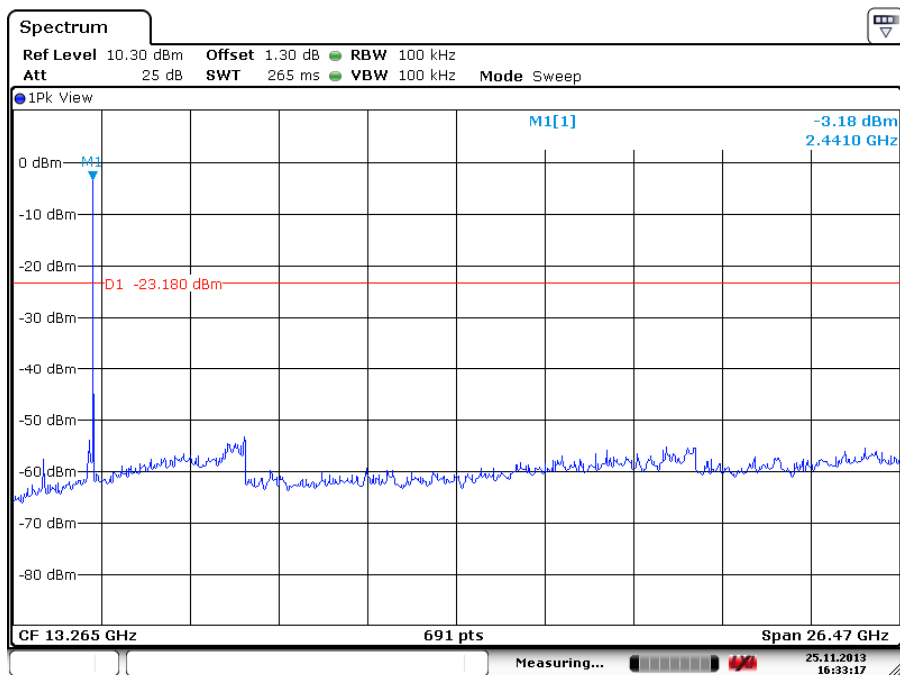

Date: 25.NOV.2013 16:33:18

### High Channel

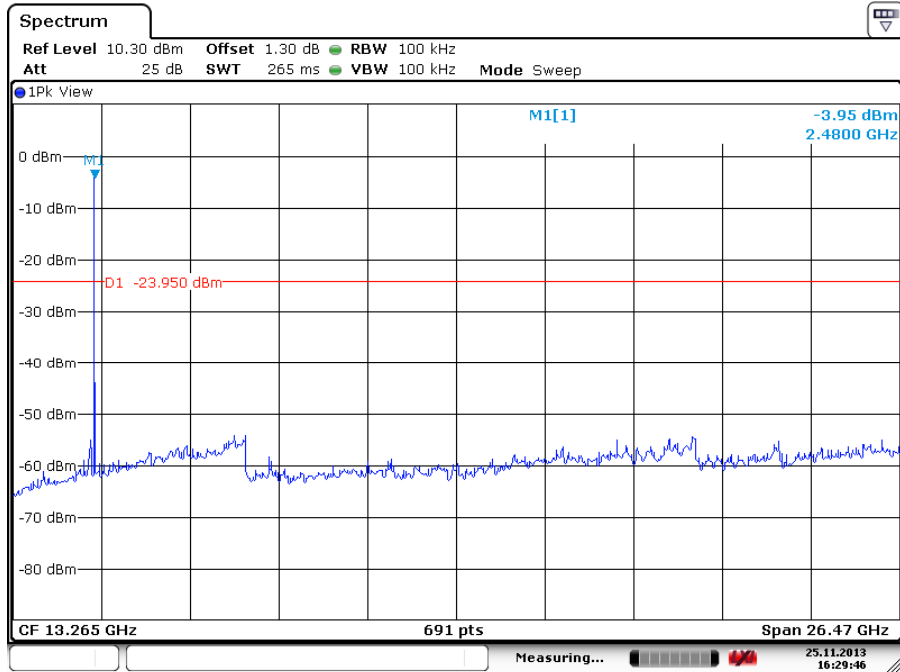

Date: 25.NOV.2013 16:29:47

### Test Plot of 100kHz Conducted Emissions, 8DPSK modulation

#### Low Channel

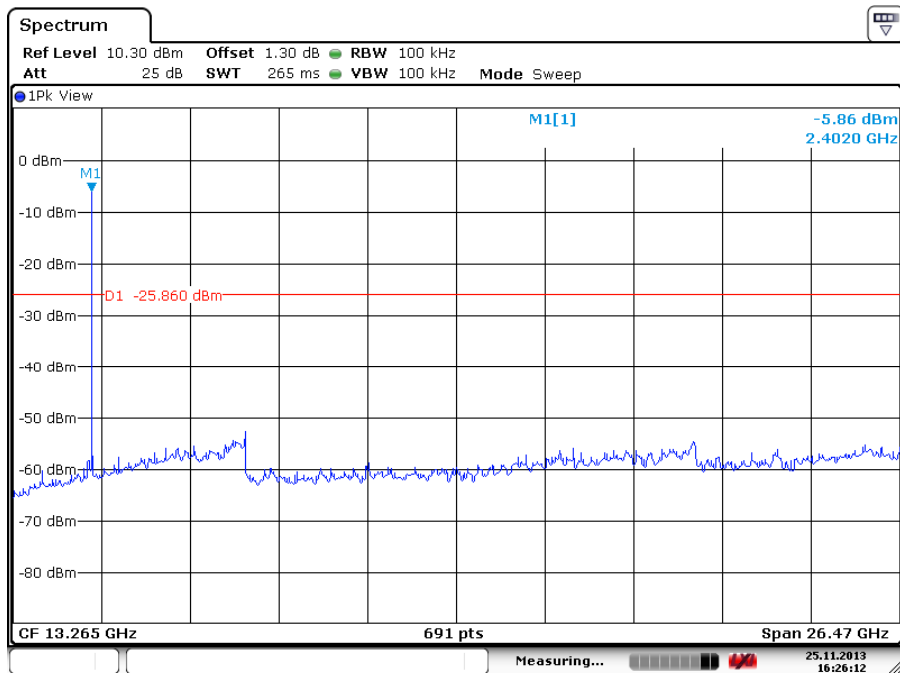

Date: 25.NOV.2013 16:26:12

#### Middle Channel

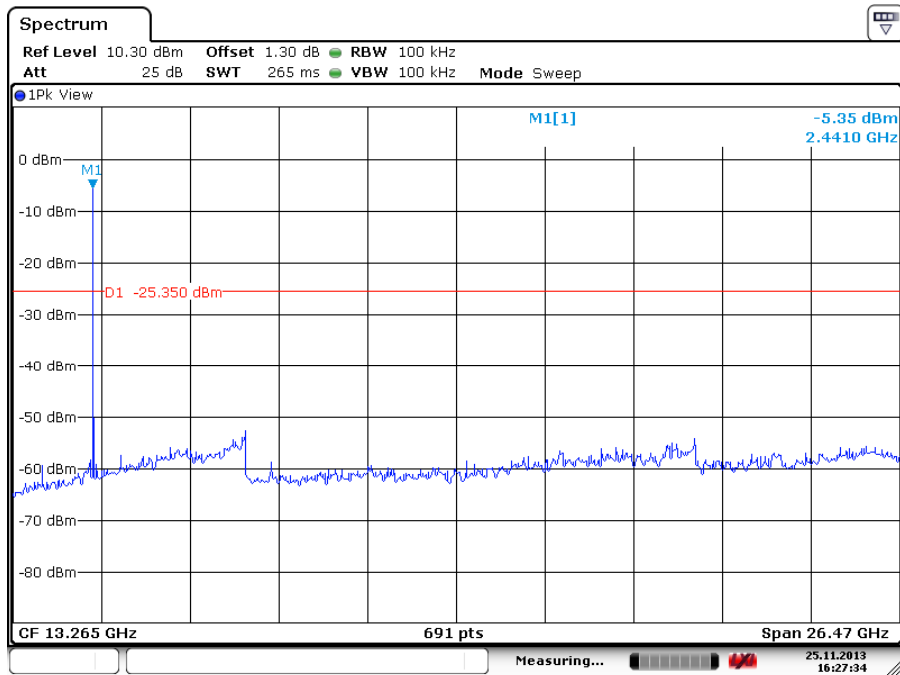

Date: 25.NOV.2013 16:27:34

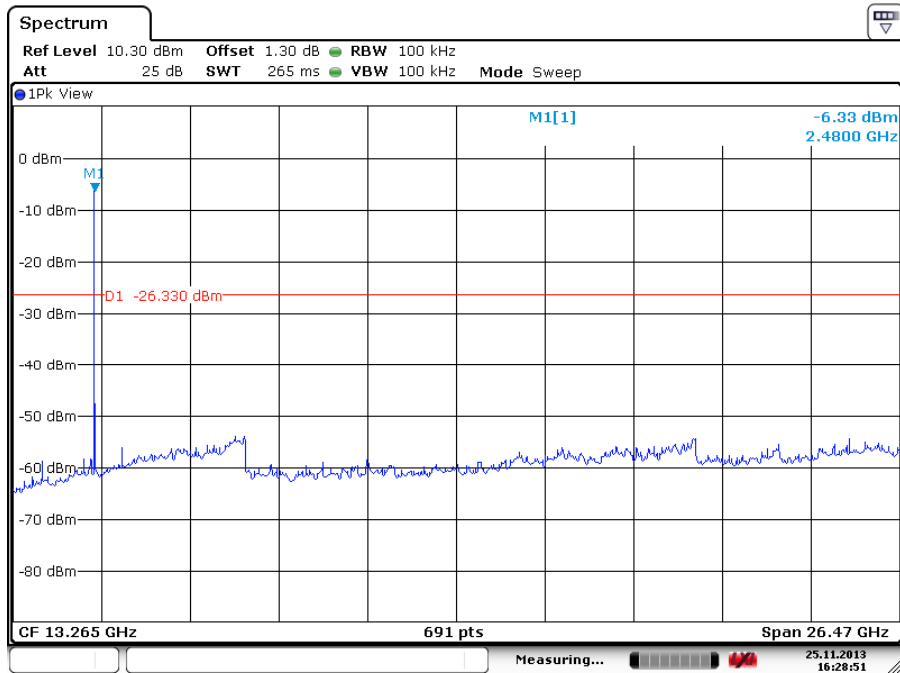
**High Channel**

Date: 25.NOV.2013 16:28:52

## Test Plot of 100kHz Bandwidth of Frequency Band Edge, GFSK modulation

### Low Channel

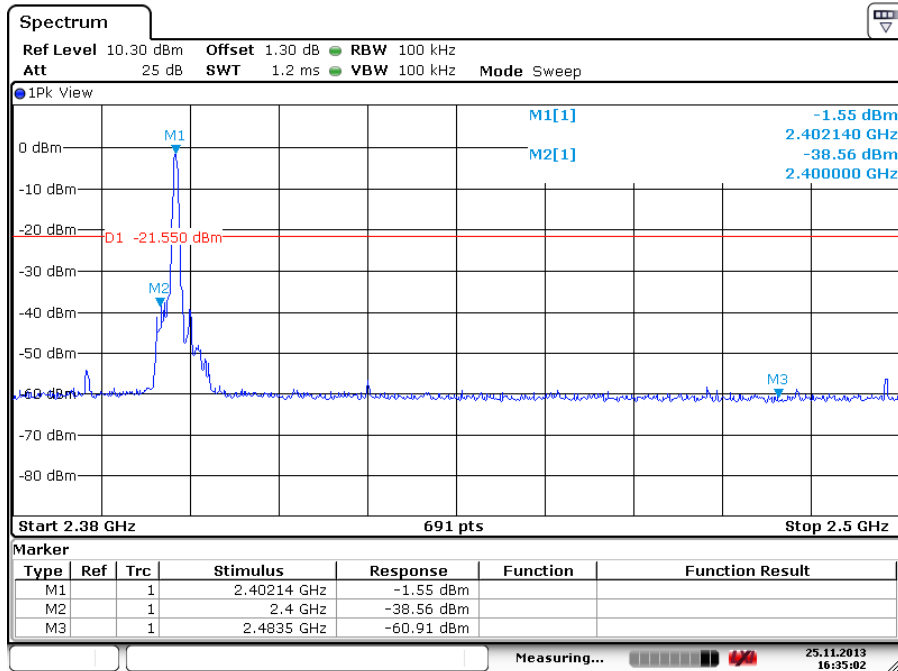

Date: 25.NOV.2013 16:35:03

### High Channel

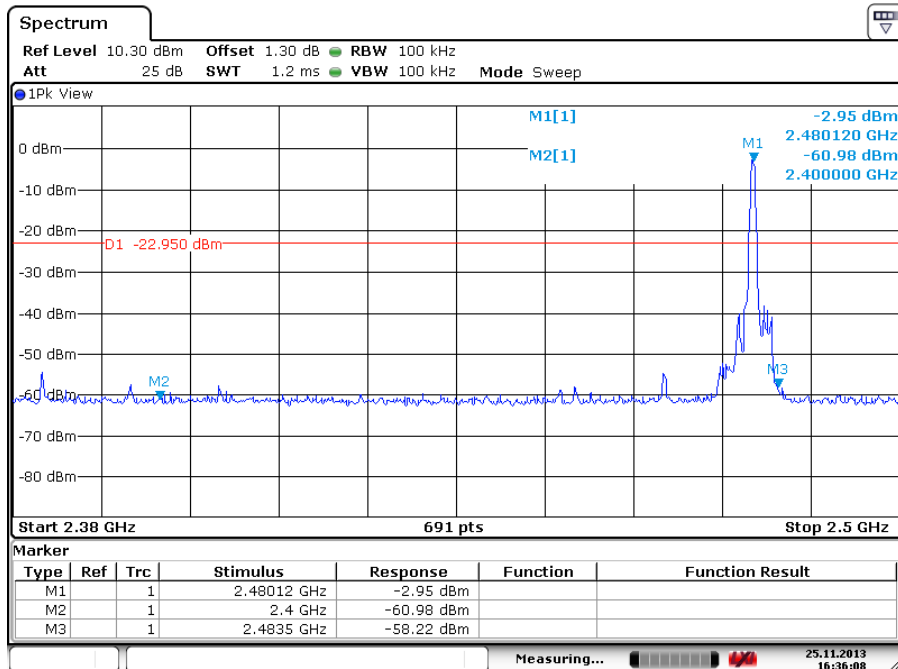

Date: 25.NOV.2013 16:36:09

## Test Plot of 100kHz Bandwidth of Frequency Band Edge, 8DPSK modulation

### Low Channel

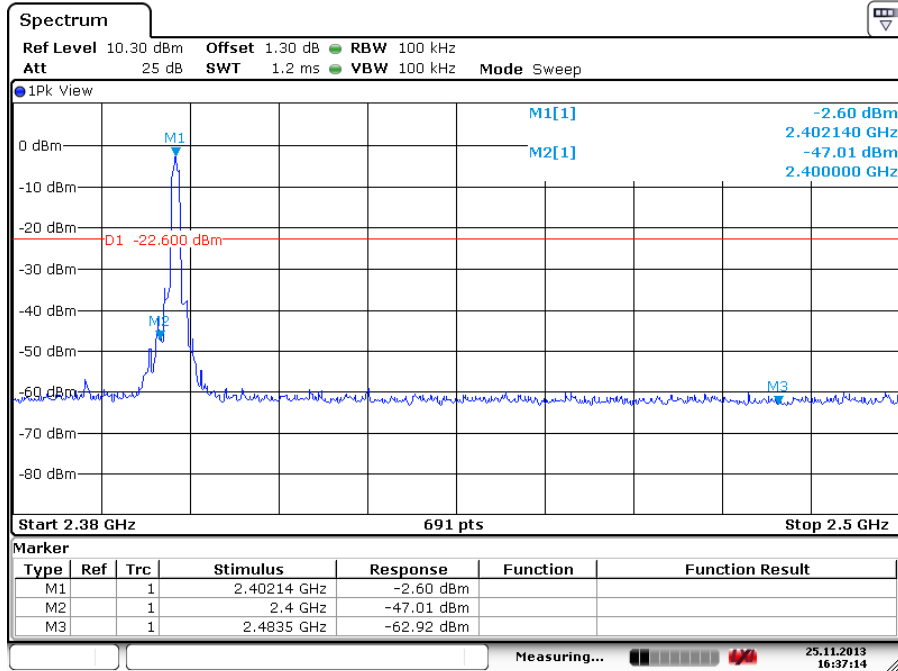

Date: 25.NOV.2013 16:37:15

### High Channel

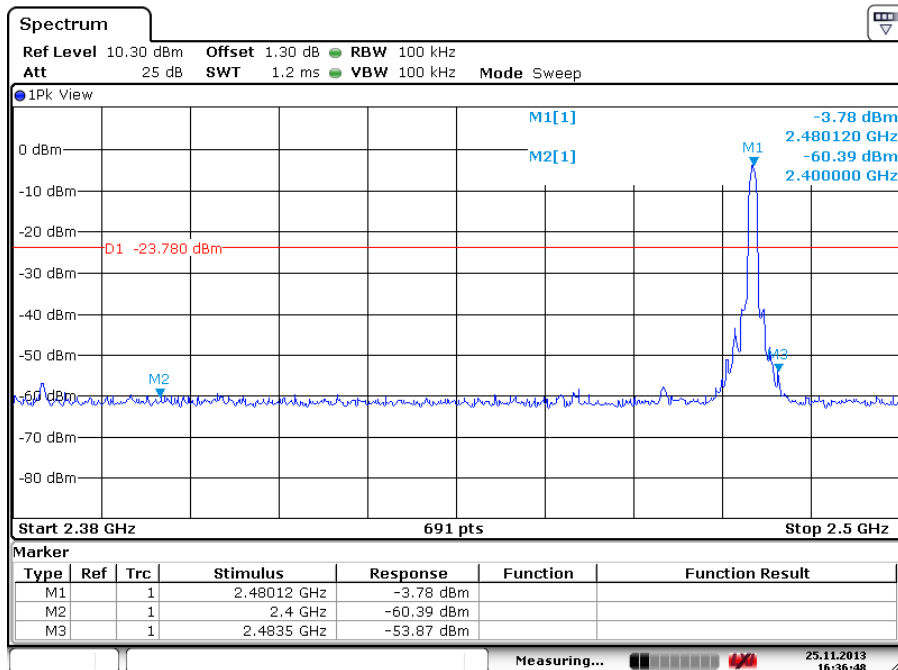

Date: 25.NOV.2013 16:36:49



## 5.1.6 Spurious Emission

**RESULT:****Passed**

Test standard	:	FCC part 15.247(d), FCC 15.205, FCC 15.209, RSS-210 2.2, RSS-210 A8.5 and RSS-Gen 7.2.1
Basic standard	:	ANSI C63.10: 2009
Limits	:	Radiated emissions which fall in the restricted bands, as defined in FCC 15.205(a) and RSS-210 2.7 (Table 1), must comply with the radiated emission limits specified in FCC 15.209(a) and RSS-210 2.7 (Table 2 and 3). Emission radiated outside the specified frequency bands must comply with the radiated emission limits specified in FCC 15.209(a) and FCC 15.249(a), RSS-210 2.7 (Table 2 and 3) and RSS-210 A2.9(a).
Kind of test site	:	3m Semi-Anechoic Chamber

**Test setup**

Test Channel	:	Low/ Middle/ High
Operation Mode	:	A
Ambient temperature	:	22-26°C
Relative humidity	:	50-65%
Atmospheric pressure	:	100-103 kPa

Remark: Testing was carried out within frequency range 30MHz to the tenth harmonic. For details refer to Appendix 2. The Radiated Emissions testing was performed in the X, Y and Z axis orientation. The X Axis orientation is the worst-case and recorded in this test report. Due to the small size of the product and that there are no inductive components of significant size, 9kHz to 30MHz frequency range is not tested based on technical judgment.

### 5.1.7 Frequency Separation

**RESULT:** **Passed**

Test standard : FCC part 15.247(a)(1), RSS-210 A8.1(b)  
 Basic standard : DA 00-705 of March 30, 2000  
 Limit :  $\geq 25\text{kHz}$  or  $2/3$  of 20dB bandwidth, whichever is greater

**Test setup**

Test Channel : Low/ Middle/ High  
 Operation Mode : A  
 Ambient temperature : 24°C  
 Relative humidity : 53%

**Table 13: Test result of Frequency Separation**

Channel	Channel Frequency (MHz)	Measured Channel Separation (MHz)	Limit (kHz)	Result
Record Channel	2441	1	$\geq 25\text{kHz}$ or $2/3$ of 20dB bandwidth	Pass
Record Channel adj 1	2440			
Record Channel adj 2	2442			



### 5.1.8 Number of hopping frequency

**RESULT:**
**Passed**

Test standard : FCC part 15.247(a)(1)(iii), RSS-210 A8.1(d)  
 Basic standard : DA 00-705 of March 30, 2000  
 Limits :  $\geq 15$  non-overlapping channels  
 Kind of test site : Shield room

**Test setup**

Test Channel : Low/ Middle/ High  
 Operation Mode : A  
  
 Ambient temperature : 22-26°C  
 Relative humidity : 50-65%  
 Atmospheric pressure : 100-103 kPa

**Table 14: Test result of Number of hopping frequency**

Frequency Range	Measured Quantity of Hopping Channel	Limit	Result
2400 to 2483.5 MHz	79	$\geq 15$	Pass



### 5.1.9 Time of Occupancy

**RESULT:**
**Passed**

Test standard : FCC part 15.247(a)(1)(iii) , RSS-210 A8.1(d)  
 Basic standard : DA 00-705 of March 30, 2000  
 Limits : 0.4s  
 Kind of test site : Shield room

**Test setup**

Test Channel : Low/ Middle/ High  
 Operation Mode : A  
  
 Ambient temperature : 22-26°C  
 Relative humidity : 50-65%  
 Atmospheric pressure : 100-103 kPa

**Table 15: Test result of Time of Occupancy**

Data Mode	Captured Burst (s)	Dwell time (s)	On+Off time (s)	Limit (s)	Result
DH5	0.0031	0.3295	0.003783	0.4	Pass
3DH5	0.0031	0.3292	0.003768	0.4	Pass

**Note:**

Dwell time = Pulse width x (Hopping rate / Number of channels) x Period

Period = 0.4 (seconds/ channel) x 79 (channel) = 31.6 seconds.

### Test Plot of Time of Occupancy, GFSK modulation

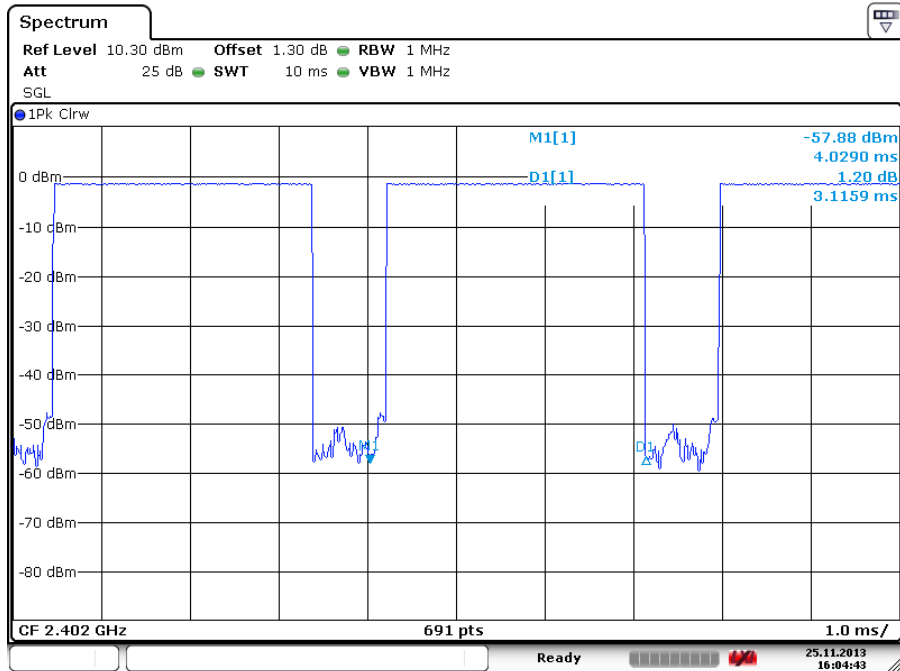

Date: 25.NOV.2013 16:04:43

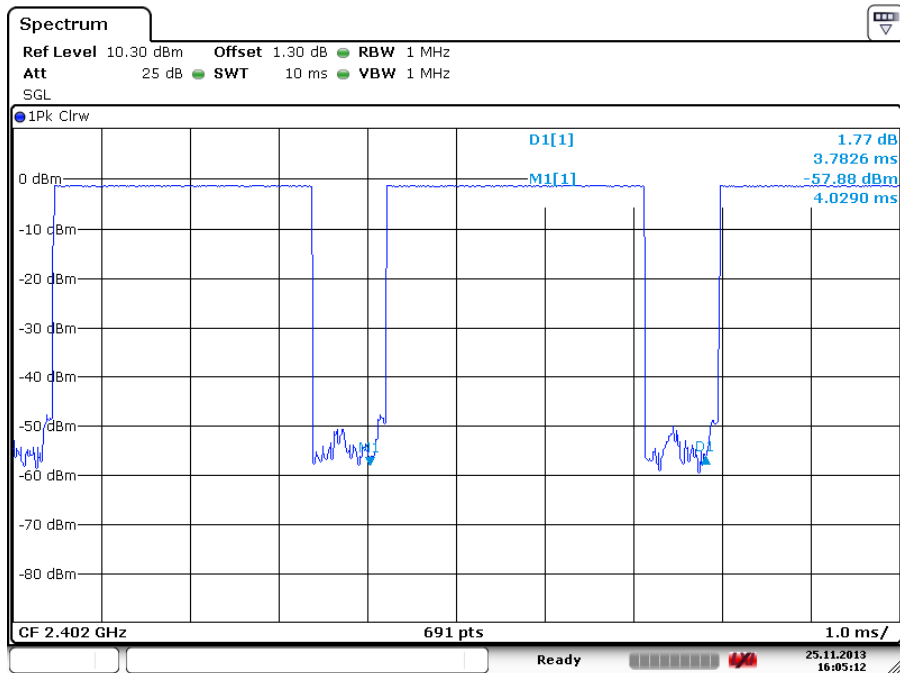

Date: 25.NOV.2013 16:05:13

### Test Plot of Time of Occupancy, 8DPSK modulation

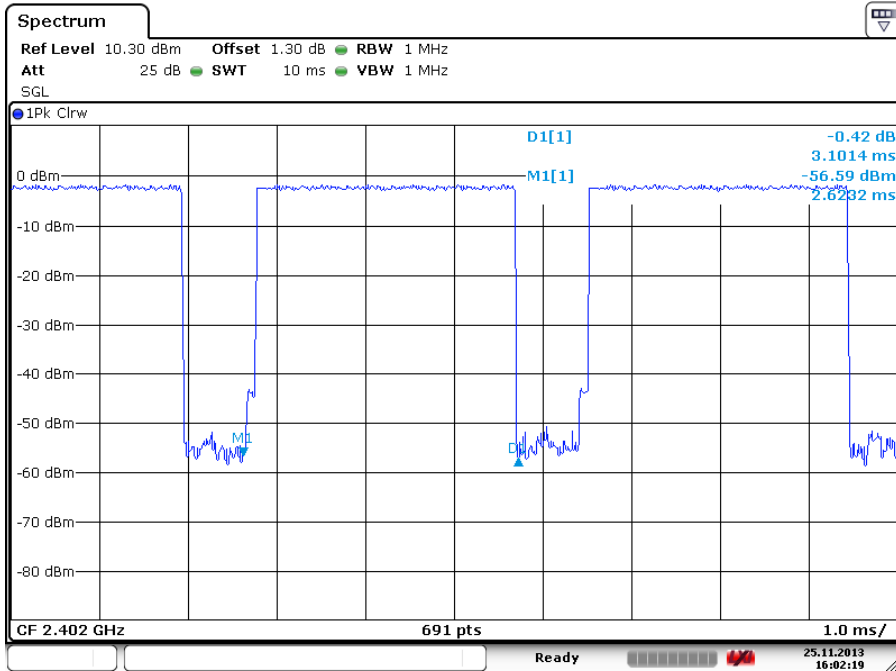

Date: 25.NOV.2013 16:02:20

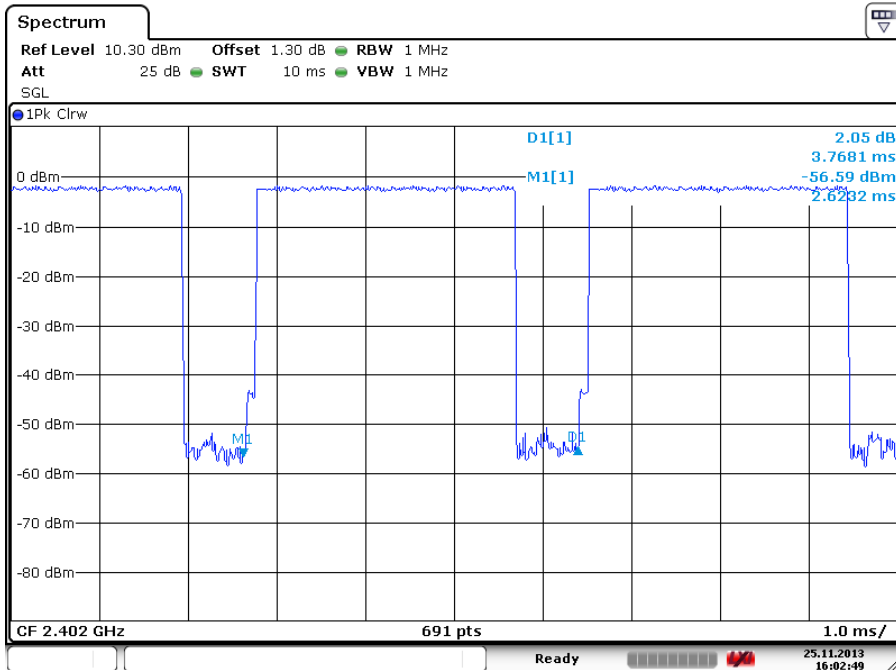

Date: 25.NOV.2013 16:02:49



## 5.2 Mains Emissions

### 5.2.1 Mains Conducted Emissions

**RESULT:****Passed**

Test standard	:	FCC Part 15.207 FCC Part 15.107 RSS-Gen 7.2.4 LP0002: 2.3
Limits	:	Mains Conducted emissions as defined in above test standards must comply with the mains conducted emission limits specified
Kind of test site	:	Shielded Room

**Test setup**

Test Channel	:	Middle
Operation mode	:	A

Remark: For details refer to Appendix D.

## 6. Safety Human exposure

### 6.1 Radio Frequency Exposure Compliance

#### 6.1.1 Electromagnetic Fields

**RESULT:****Passed**

Test standard : FCC KDB Publication 447498

Since maximum peak output power of the transmitter is 0.76mW <1mW, hence the EUT is excluded from SAR evaluation according to FCC KDB publication 447498 D01: Mobile Portable RF Exposure..

## 7. Photographs of the Test Set-Up

Photograph 1: Set-up for Spurious Emissions (Front View)

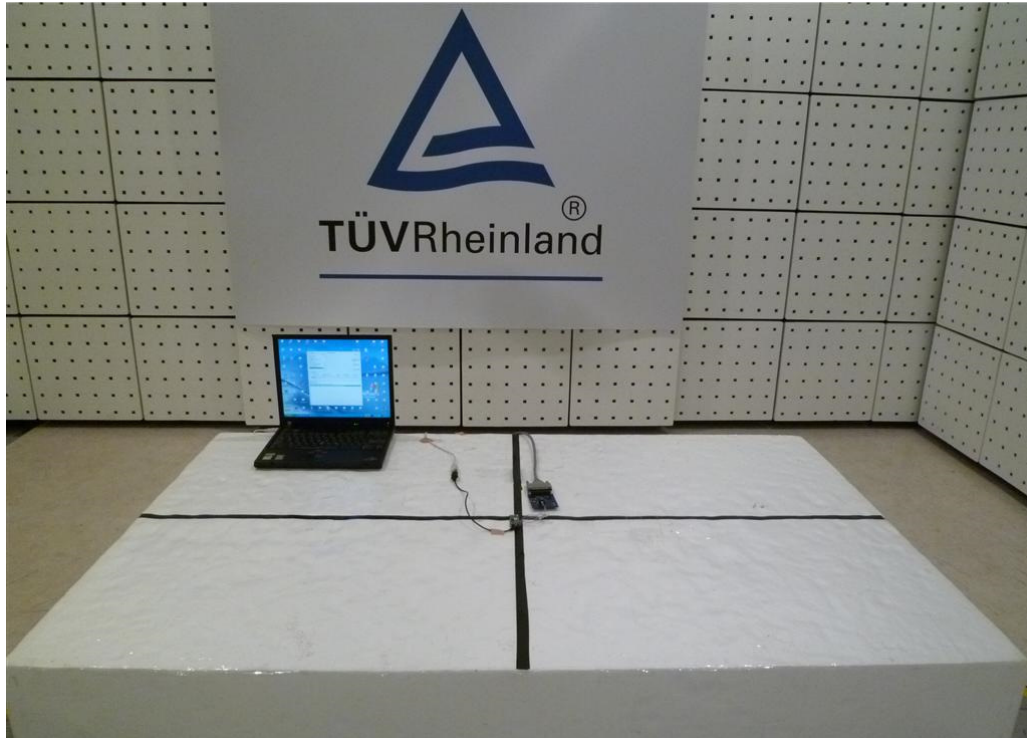

**Photograph 2: Set-up for Spurious Emissions (Back View 1)**



**Photograph 3: Set-up for Spurious Emissions (Back View 2)**

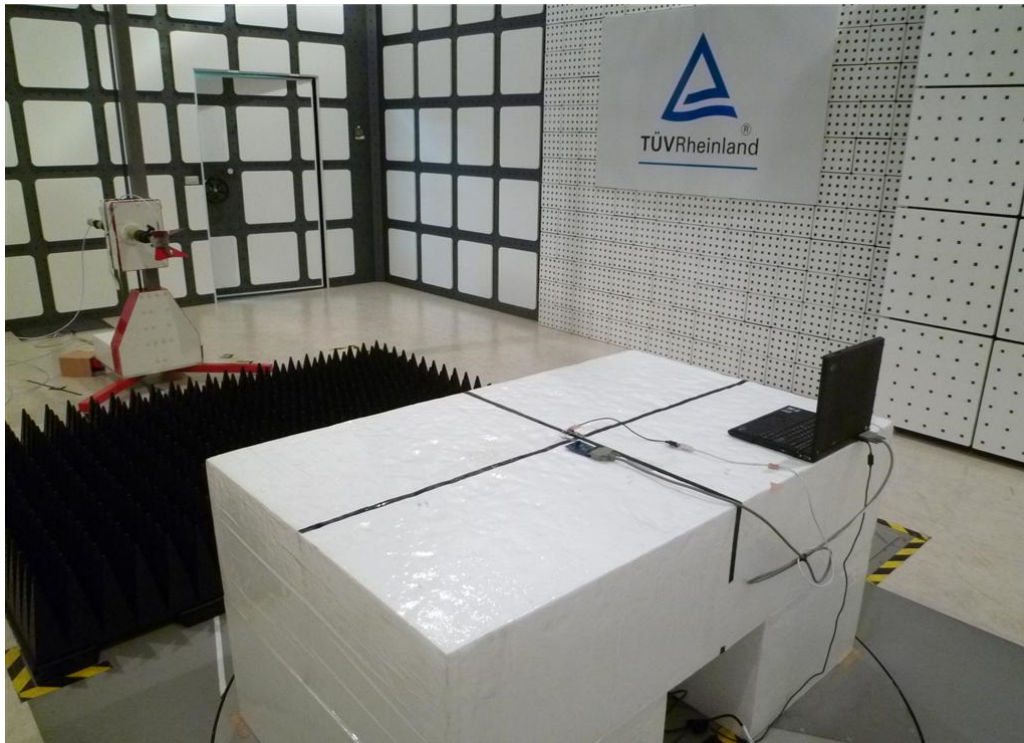

**Photograph 4: Set-up for Conducted testing**





**Photograph 5: Set-up for for Mains Conducted testing Back**



**Photograph 6: Set-up for for Mains Conducted testing Front**



## 8. List of Tables

Table 1: Applied Standard and Test Levels .....	5
Table 2: List of Test and Measurement Equipment .....	6
Table 3: Emission Measurement Uncertainty.....	7
Table 4: Basic Information of EUT .....	8
Table 5: Technical Specification of EUT .....	8
Table 6: Frequency hopping information.....	9
Table 7: Test result of Peak Output Power, GFSK modulation.....	15
Table 8: Test result of Peak Output Power, 8DPSK modulation.....	15
Table 9: Test result of 20dB Bandwidth, GFSK modulation.....	19
Table 10: Test result of 20dB Bandwidth, 8DPSK modulation.....	19
Table 11: Test result of 99% Bandwidth, GFSK modulation.....	23
Table 12: Test result of 99% Bandwidth, PSK modulation.....	23
Table 13: Test result of Frequency Separation .....	34
Table 14: Test result of Number of hopping frequency .....	36
Table 15: Test result of Time of Occupancy.....	38

## 9. List of Photographs

Photograph 1: Set-up for Spurious Emissions (Front View).....	43
Photograph 2: Set-up for Spurious Emissions (Back View 1) .....	44
Photograph 3: Set-up for Spurious Emissions (Back View 2) .....	45
Photograph 4: Set-up for Conducted testing .....	45
Photograph 5: Set-up for for Mains Conducted testing Back.....	46
Photograph 6: Set-up for for Mains Conducted testing Front.....	46