



**FCC 47 CFR PART 15 SUBPART C AND ANSI C63.10:2009
TEST REPORT**

For

HD IP Camera

Model : IP-2100

Data Applies To : Linx Cam

Trade Name : PX ; QQLinx

Issued for

Trans Electric Co., Ltd

771 Sec.2 Chungsan Rd, Huatang, Changhua, Taiwan 503

Issued by

Compliance Certification Services Inc.

Hsinchu Lab.

**NO. 989-1 Wen Shan Rd., Shang Shan Village,
Qionglin Shiang Hsinchu County 30741, Taiwan, R.O.C**

TEL: +886-3-5921698

FAX: +886-3-5921108

<http://www.ccsrf.com>

E-Mail : service@ccsrf.com

Issued Date: July 17, 2014



Note: *This report shall not be reproduced except in full, without the written approval of Compliance Certification Services Inc. This document may be altered or revised by Compliance Certification Services Inc. personnel only, and shall be noted in the revision section of the document. The client should not use it to claim product endorsement by TAF or any government agencies. The test results of this report relate only to the tested sample identified in this report.*



Revision History

Rev.	Issue Date	Revisions	Effect Page	Revised By
00	07/17/2014	Initial Issue	All Page 92	Dola Hsieh



TABLE OF CONTENTS

TITLE	PAGE NO.
1. TEST REPORT CERTIFICATION	4
2. EUT DESCRIPTION	5
3. DESCRIPTION OF TEST MODES	6
4. TEST METHODOLOGY	7
5. FACILITIES AND ACCREDITATION	7
5.1 FACILITIES	7
5.2 ACCREDITATIONS.....	7
5.3 MEASUREMENT UNCERTAINTY	8
6. SETUP OF EQUIPMENT UNDER TEST.....	9
7. FCC PART 15.247 REQUIREMENTS	11
7.1 6dB BANDWIDTH	11
7.2 MAXIMUM PEAK OUTPUT POWER	21
7.3 AVERAGE POWER	24
7.4 POWER SPECTRAL DENSITY	27
7.5 CONDUCTED SPURIOUS EMISSION	38
7.6 RADIATED EMISSION.....	51
7.7 CONDUCTED EMISSION.....	84
APPENDIX I SETUP PHOTOS	89



1. TEST REPORT CERTIFICATION

Applicant : Trans Electric Co., Ltd
Address : 771 Sec.2 Chungsan Rd, Huatang, Changhua, Taiwan 503
Equipment Under Test : HD IP Camera
Model : IP-2100
Data Applies To : Linx Cam
Trade Name : PX ; QQLinx
Tested Date : July 03 ~ 17, 2014

APPLICABLE STANDARD	
Standard	Test Result
FCC Part 15 Subpart C AND ANSI C63.10:2009	PASS

WE HEREBY CERTIFY THAT: The above equipment has been tested by Compliance Certification Services Inc., and found compliance with the requirements set forth in the technical standards mentioned above. The results of testing in this report apply only to the product/system, which was tested. Other similar equipment will not necessarily produce the same results due to production tolerance and measurement uncertainties.

Approved by:

Sb. Lu
Sr. Engineer

Reviewed by:

Gundam Lin
Sr. Engineer

**2. EUT DESCRIPTION**

Product Name	HD IP Camera
Model Number	IP-2100
Data Applies To	Linx Cam
Identify Number	T140703D08
Received Date	July 03, 2014
Frequency Range	IEEE 802.11b/g, 802.11gn HT20 : 2412MHz~2462MHz IEEE 802.11gn HT40 : 2422MHz ~ 2452MHz
Transmit Power	IEEE 802.11b : 18.38 dBm (0.0688W) IEEE 802.11g : 19.23 dBm (0.0837W) IEEE 802.11gn HT20 : 19.14 dBm (0.0821W) IEEE 802.11gn HT40: 19.11 dBm (0.0815W)
Channel Spacing	IEEE 802.11b/g, 802.11gn HT20/HT40 : 5MHz
Channel Number	IEEE 802.11b/g, 802.11gn HT20 : 11 Channels IEEE 802.11gn HT40 : 9 Channels
Transmit Data Rate	IEEE 802.11b : 11, 5.5, 2, 1 Mbps IEEE 802.11g : 54, 48, 36, 24, 18, 12, 9, 6 Mbps IEEE 802.11gn HT20 : 72.2, 65, 58.5, 57.8, 52, 43.3, 39, 28.9, 26, 21.7, 19.5, 14.4, 13, 7.2, 6.5 Mbps IEEE 802.11gn HT40 : 150, 135, 121.5, 120, 108, 90, 81, 60, 54, 45, 40.5, 30, 27, 15, 13.5Mbps
Type of Modulation	IEEE 802.11b : DSSS (CCK, DQPSK, DBPSK) IEEE 802.11g : OFDM (64QAM, 16QAM, QPSK, BPSK) IEEE 802.11gn HT20/HT40 : OFDM (64QAM, 16QAM, QPSK, BPSK)
Frequency Selection	by software / firmware
Antenna Type	Dipole Antenna, Antenna Gain 2 dBi
Power Rating	5Vdc
Test Voltage	120Vac, 60Hz
DC Power Cable Type	Non-shielded cable 1.5 m (Non-detachable)
I/O Port	RJ-45 Port × 1, Audio Port × 1, Micro SD Card Port × 1, USB Port × 1, Power Port × 1
Signal Cable	Non-shielded RJ-45 cable, 1 m × 1 (Detachable)

The difference of the series model

Model Number	Trade Name	Difference
IP-2100	PX	For the marketing purpose
Linx Cam	QQLinx	



Power Adapter :

No.	Manufacturer	Model No.	Power Input	Power Output
1	GSP	GSCU2000S005V015	100-240Vac, 0.5A Max, 50/60Hz	5Vdc, 2.0A

Remark :

1. The sample selected for test was engineering sample that approximated to production product and was provided by manufacturer.
2. For more details, please refer to the User's manual of the EUT.
3. The model IP-2100 was considered the main model for testing.
4. This submittal(s) (test report) is intended for FCC ID: BY4-IP2100LinxCam filing to comply with Section 15.207, 15.209 and 15.247 of the FCC Part 15, Subpart C Rules.

3. DESCRIPTION OF TEST MODES

The EUT is an 802.11gn transceiver in HD IP Camera form factor.

For IEEE 802.11b/g, 802.11gn HT20/HT40 mode (1TX / 1RX)

Conducted Emission / Radiated Emission Test (Below 1 GHz)

1. The following test modes were scanned during the preliminary test:

No.	Pre-Test Mode
1	Normal Operating

2. After the preliminary scan, the following test mode was found to produce the highest emission level.

Final Test Mode		
Emission	Radiated Emission	Normal Operating
	Conducted Emission	

Remark : Then, the above highest emission mode of the configuration of the EUT and cable was chosen for all final test items.

Conducted / Radiated Emission Test (Above 1 GHz)

IEEE 802.11b, 802.11g, 802.11gn HT20 mode

The EUT had been tested under operating condition.

There are three channels have been tested as following :

Channel	Frequency (MHz)
Low	2412
Middle	2437
High	2462

IEEE 802.11b mode : 1Mbps data rate (worst case) were chosen for full testing.

IEEE 802.11g mode : 6Mbps data rate (worst case) were chosen for full testing.

IEEE 802.11gn HT20 mode : 6.5Mbps data rate (worst case) were chosen for full testing.



IEEE 802.11gn HT40 mode

The EUT had been tested under operating condition.

There are three channels have been tested as following :

Channel	Frequency (MHz)
Low	2422
Middle	2437
High	2452

IEEE 802.11gn HT40 mode : 13.5Mbps data rate (worst case) were chosen for full testing.

4. TEST METHODOLOGY

The tests documented in this report were performed in accordance with ANSI C63.10: 2009 and FCC CFR 47, 15.207, 15.209, 15.247.

5. FACILITIES AND ACCREDITATION

5.1 FACILITIES

All measurement facilities used to collect the measurement data are located at

NO. 989-1 Wen Shan Rd., Shang Shan Village,
Qionglin Shiang Hsinchu County 30741, Taiwan, R.O.C

The sites are constructed in conformance with the requirements of ANSI C63.10:2009 and CISPR 22. All receiving equipment conforms to CISPR 16-1-1, CISPR 16-1-2, CISPR 16-1-3, CISPR 16-1-4, CISPR 16-1-5.

5.2 ACCREDITATIONS

Our laboratories are accredited and approved by the following approval agencies according to ISO/IEC 17025.

Taiwan	TAF
---------------	-----

The measuring facility of laboratories has been authorized or registered by the following approval agencies.

Canada	INDUSTRY CANADA
Japan	VCCI
Taiwan	BSMI
USA	FCC MRA

Copies of granted accreditation certificates are available for downloading from our web site, <http://www.ccsrf.com>

Remark: FCC Designation Number TW1027.



5.3 MEASUREMENT UNCERTAINTY

The following table is for the measurement uncertainty, which is calculated as per the document CISPR 16-4-2.

PARAMETER	UNCERTAINTY
Semi Anechoic Chamber (966 Chamber_B) / Radiated Emission, 30 to 1000 MHz	+/- 3.97
Semi Anechoic Chamber (966 Chamber_B) / Radiated Emission, 1 to 18GHz	+/- 3.58
Semi Anechoic Chamber (966 Chamber_B) / Radiated Emission, 18 to 26 GHz	+/- 3.59
Semi Anechoic Chamber (966 Chamber_B) / Radiated Emission, 26 to 40 GHz	+/- 3.81
Conducted Emission (Mains Terminals), 9kHz to 30MHz	+/- 2.48

This uncertainty represents an expanded uncertainty expressed at approximately the 95% confidence level using a coverage factor of k=2.

Consistent with industry standard (e.g. CISPR 22, clause 11, Measurement Uncertainty) determining compliance with the limits shall be base on the results of the compliance measurement. Consequently the measure emissions being less than the maximum allowed emission result in this be a compliant test or passing test.

The acceptable measurement uncertainty value without requiring revision of the compliance statement is base on conducted and radiated emissions being less than U_{CISPR} which is 3.6dB and 5.2dB respectively. CCS values (called U_{Lab} in CISPR 16-4-2) is less than U_{CISPR} as shown in the table above. Therefore, MU need not be considered for compliance.



6. SETUP OF EQUIPMENT UNDER TEST

SUPPORT EQUIPMENT

No.	Product	Manufacturer	Model No.	Serial No.
1	Notebook PC	HP	ProBook 4421s	CNF03242PJ
2	Multi-media Stereo Headset	KINYO	EM-3000	4712260000000
3	Mirco SD	Sandisk	SDSDM-1024	---
4	Cell Phone	ASUS	ASUS_T00G	E6AZCY525527
5	Draft 11n Wireless 4-Port Gigabit Broadband Router	SMC	SMCWGBR14S-N	U193600496

No.	Power & Signal Cable Description
1	Non-shielded RJ-45 cable, 12 m × 1

SETUP DIAGRAM FOR TESTS

EUT & peripherals setup diagram is shown in appendix setup photos.

EUT OPERATING CONDITION

RF Mode :

1. EUT & peripherals setup diagram is shown in appendix setup photos.
2. USB Fixture link to Notebook PC.
3. Run Realtek Test.

TX Mode: Enter the command

- ⇒ **Tx Data Rate:** 1Mbps Bandwidth 20 (IEEE 802.11b mode)
6Mbps Bandwidth 20 (IEEE 802.11g mode)
6.5Mbps Bandwidth 20 (IEEE 802.11gn HT20 mode)
13.5Mbps Bandwidth 40 (IEEE 802.11gn HT40 mode)

⇒ **Power control**

- IEEE 802.11b Channel Low (2412MHz) TX Power 52
- IEEE 802.11b Channel Mid (2437MHz) TX Power 48
- IEEE 802.11b Channel High (2462MHz) TX Power 44



IEEE 802.11g Channel Low (2412MHz) TX Power 60
IEEE 802.11g Channel Mid (2437MHz) TX Power 63
IEEE 802.11g Channel High (2462MHz) TX Power 60
IEEE 802.11gn HT20 Channel Low (2412MHz) TX Power 58
IEEE 802.11gn HT20 Channel Mid (2437MHz) TX Power 63
IEEE 802.11gn HT20 Channel High (2462MHz) TX Power 58
IEEE 802.11gn HT40 Channel Low (2422MHz) TX Power 57
IEEE 802.11gn HT40 Channel Mid (2437MHz) TX Power 63
IEEE 802.11gn HT40 Channel High (2452MHz) TX Power 56

5. All of the functions are under run.
6. Start test.

Normal Mode :

1. EUT & peripherals setup diagram is shown in appendix setup photos.
2. Notebook PC link to EUT by WiFi.
3. Cell phone link WiFi , APP control EUT by cell phone.
4. All of the functions are under run (web display video).
5. Start test.



7. FCC PART 15.247 REQUIREMENTS

7.1 6dB BANDWIDTH

LIMITS

§ 15.247(a) (2) For direct sequence systems, the minimum 6dB bandwidth shall be at least 500kHz.

TEST EQUIPMENT

Name of Equipment	Manufacturer	Model	Serial Number	Calibration Due
Spectrum Analyzer	Agilent	E4446A	MY43360132	06/10/2015

Remark: Each piece of equipment is scheduled for calibration once a year.

TEST SETUP



TEST PROCEDURE

1. The transmitter output was connected to a spectrum analyzer.
2. Set RBW = 100 kHz.
3. Set the video bandwidth (VBW) $\geq 3 \times$ RBW.
4. Detector = Peak.
5. Trace mode = max hold.
6. Sweep = auto couple.
7. Allow the trace to stabilize.
8. Measure the maximum width of the emission that is constrained by the frequencies associated with the two outermost amplitude points (upper and lower frequencies) that are attenuated by 6 dB relative to the maximum level measured in the fundamental emission.



TEST RESULTS

IEEE 802.11b Mode

Channel	Channel Frequency (MHz)	6dB Bandwidth (MHz)	Minimum Limit (kHz)	Pass / Fail
Low	2412	9.605	500	PASS
Middle	2437	9.615	500	PASS
High	2462	10.060	500	PASS

IEEE 802.11g Mode

Channel	Channel Frequency (MHz)	6dB Bandwidth (MHz)	Minimum Limit (kHz)	Pass / Fail
Low	2412	16.530	500	PASS
Middle	2437	16.515	500	PASS
High	2462	16.530	500	PASS

IEEE 802.11gn HT20 Mode

Channel	Channel Frequency (MHz)	6dB Bandwidth (MHz)	Minimum Limit (kHz)	Pass / Fail
Low	2412	17.805	500	PASS
Middle	2437	17.815	500	PASS
High	2462	17.780	500	PASS

IEEE 802.11gn HT40 Mode

Channel	Channel Frequency (MHz)	6dB Bandwidth (MHz)	Minimum Limit (kHz)	Pass / Fail
Low	2422	36.360	500	PASS
Middle	2437	36.340	500	PASS
High	2452	36.350	500	PASS



6dB BANDWIDTH

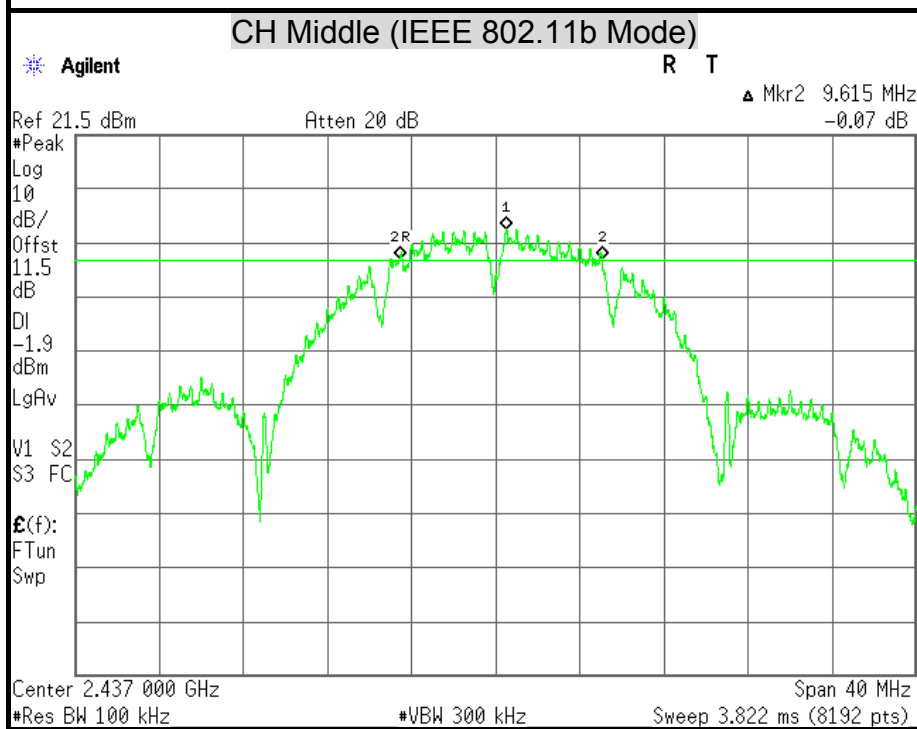
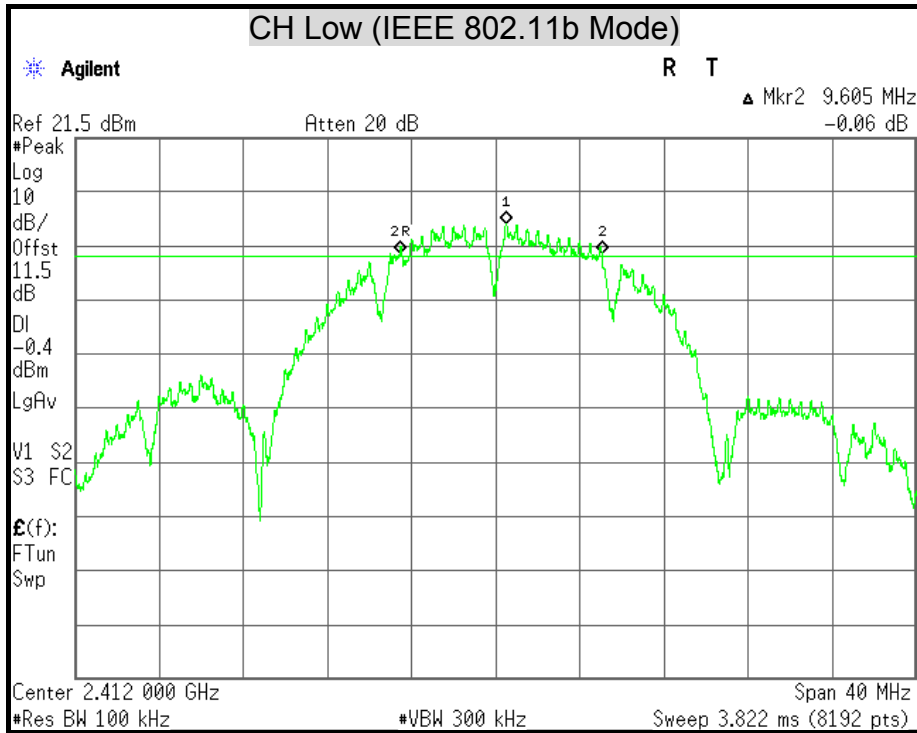

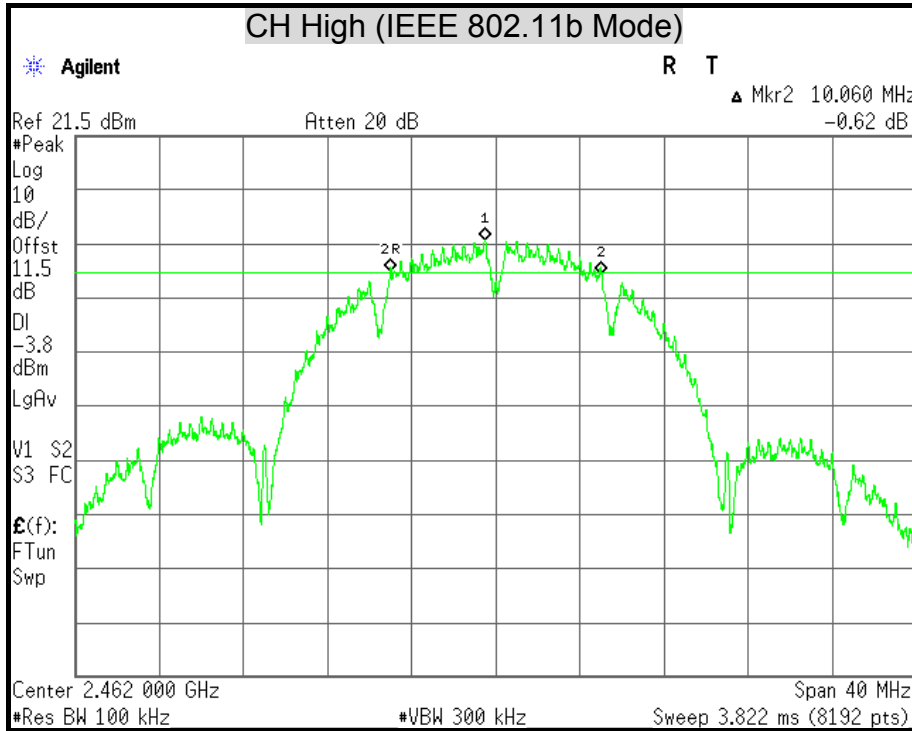

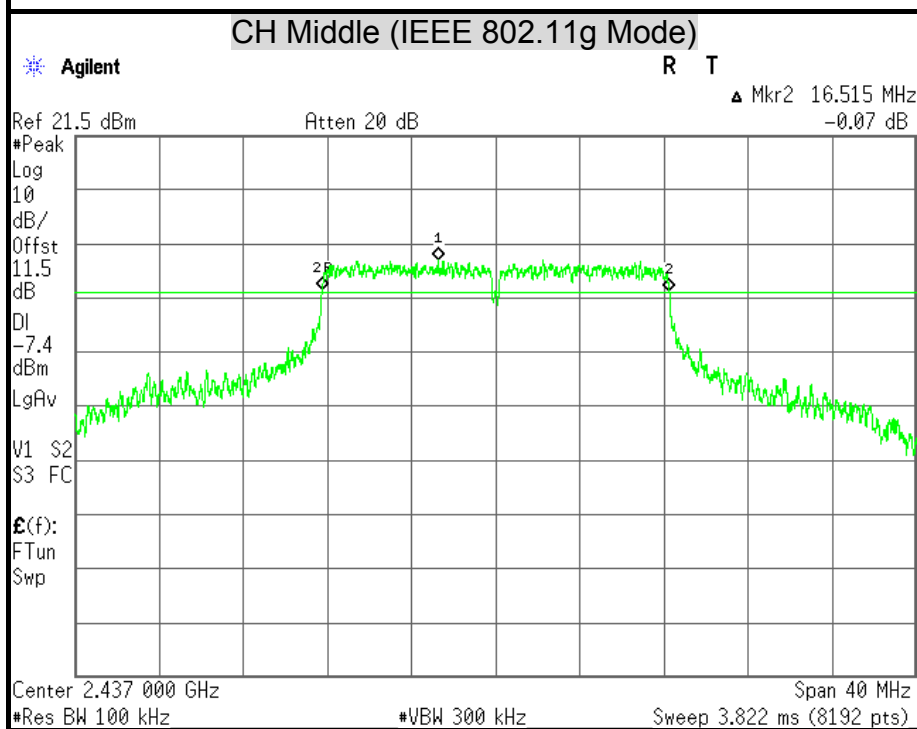
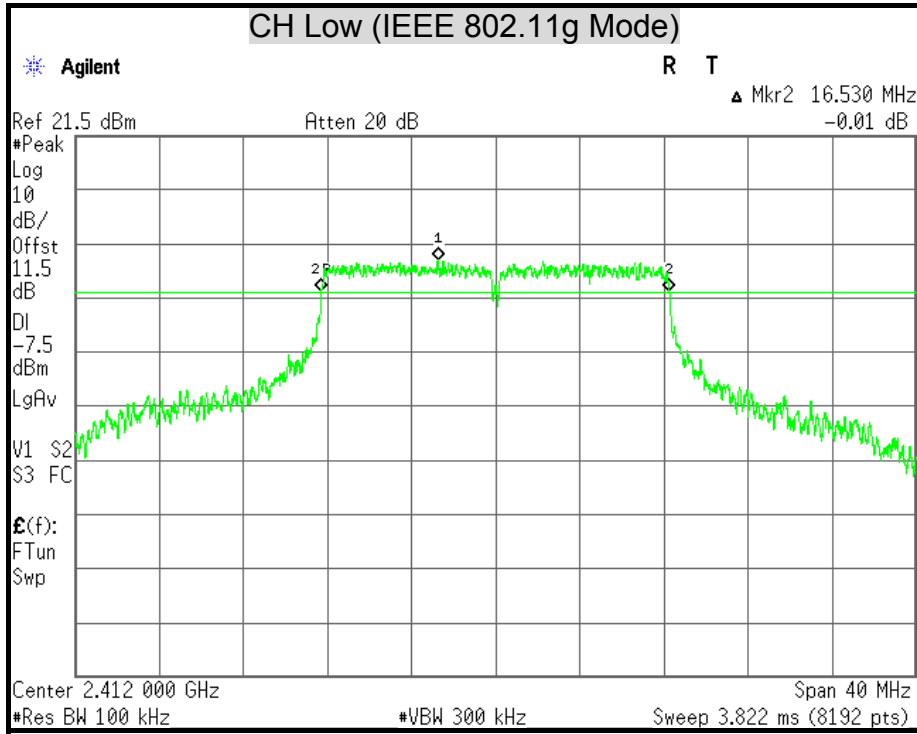

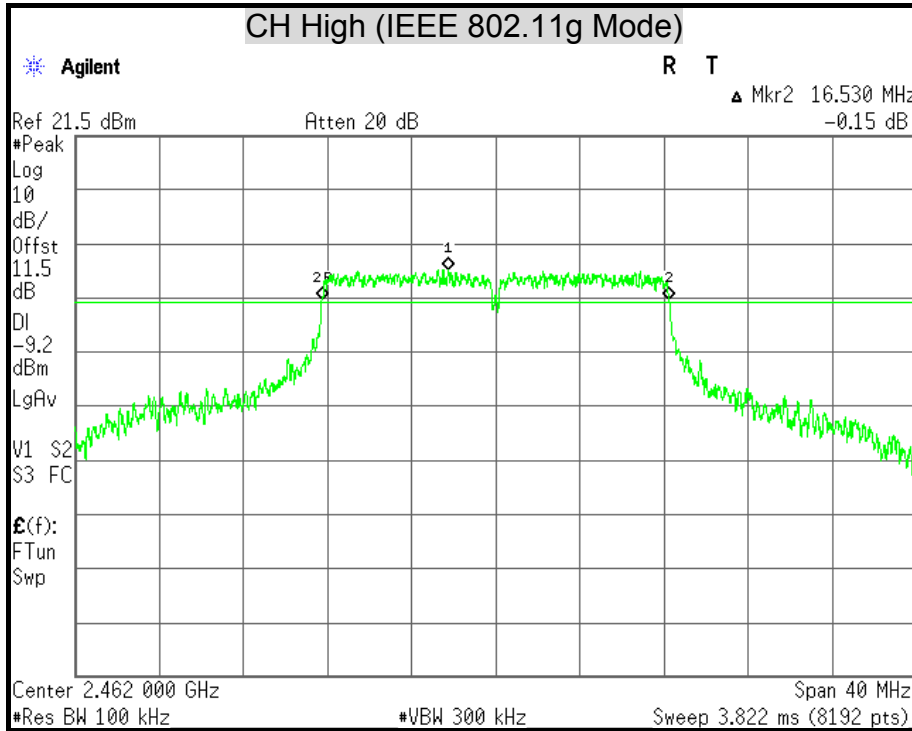

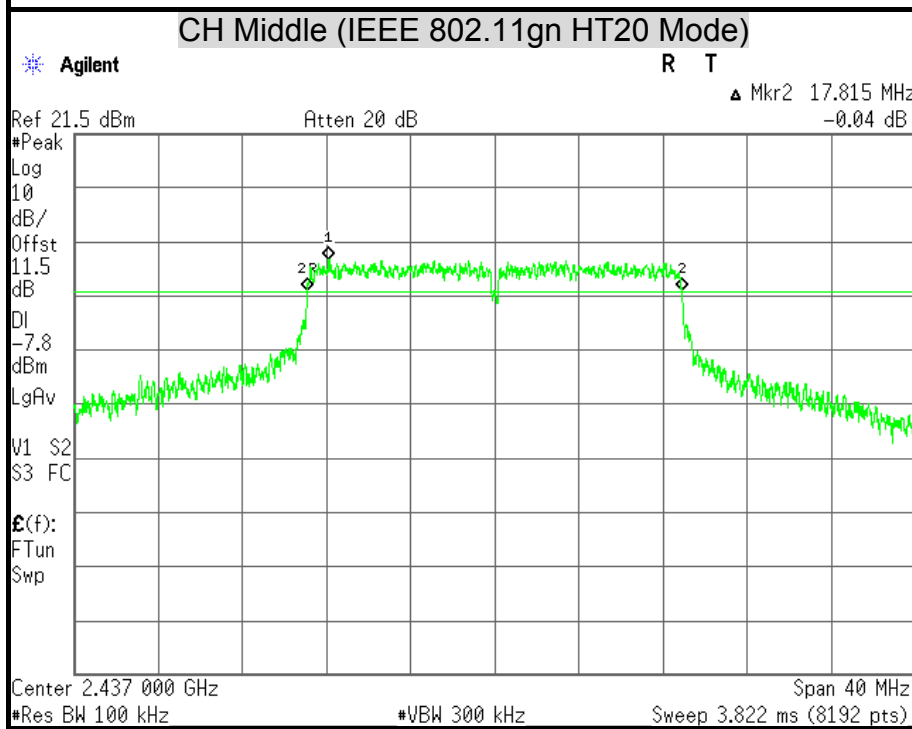
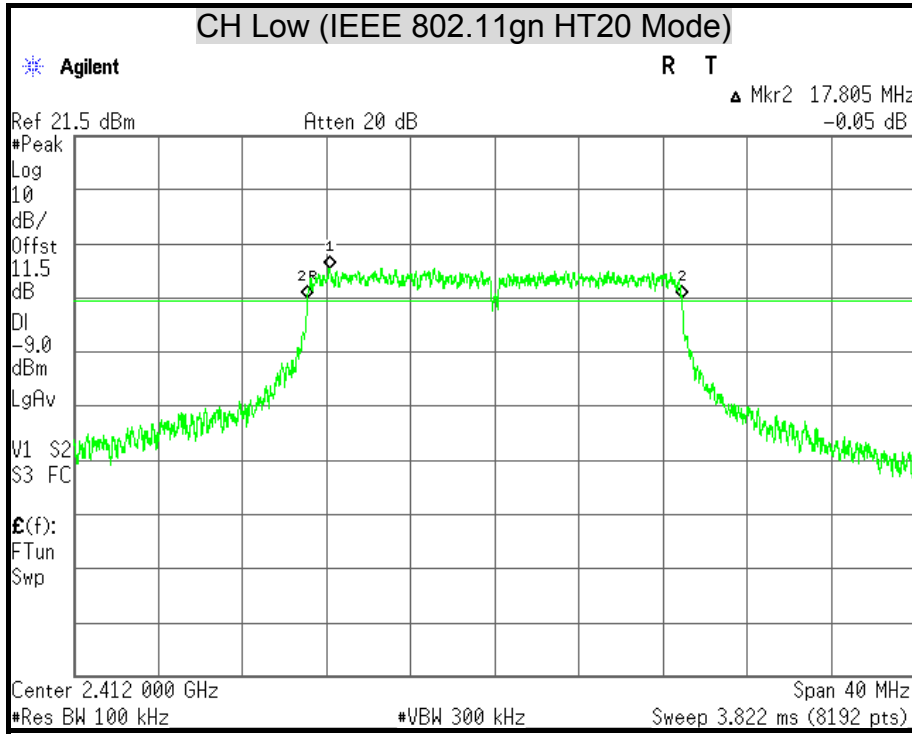

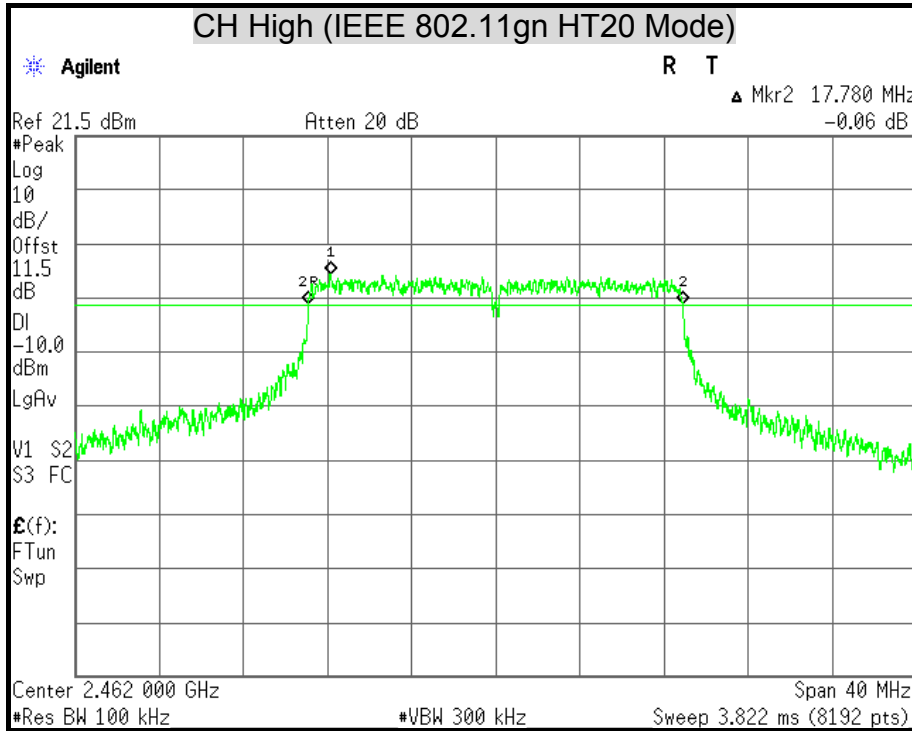

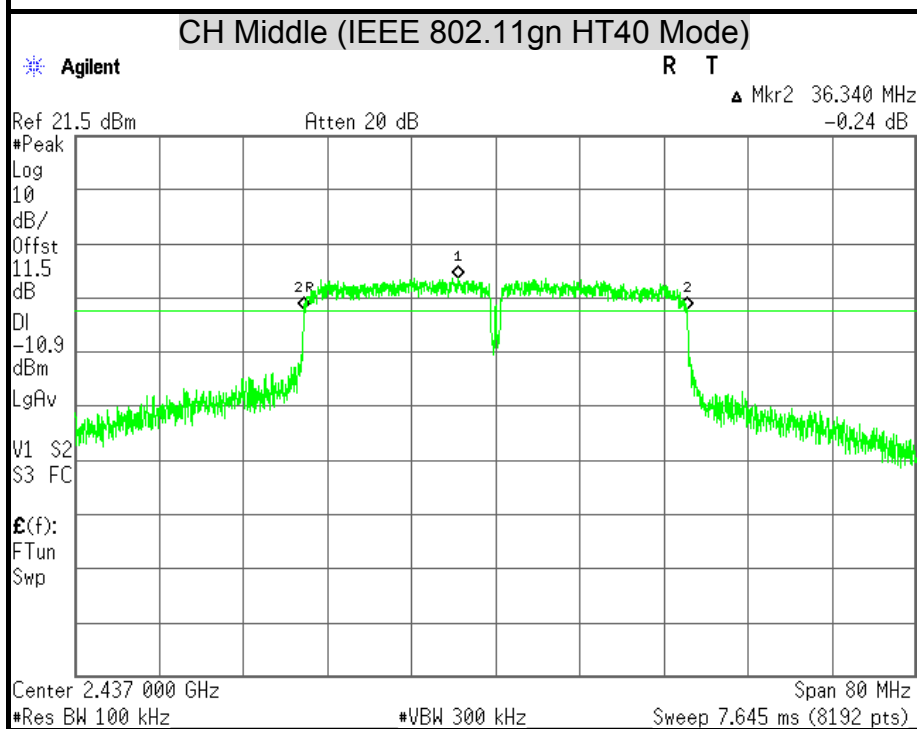
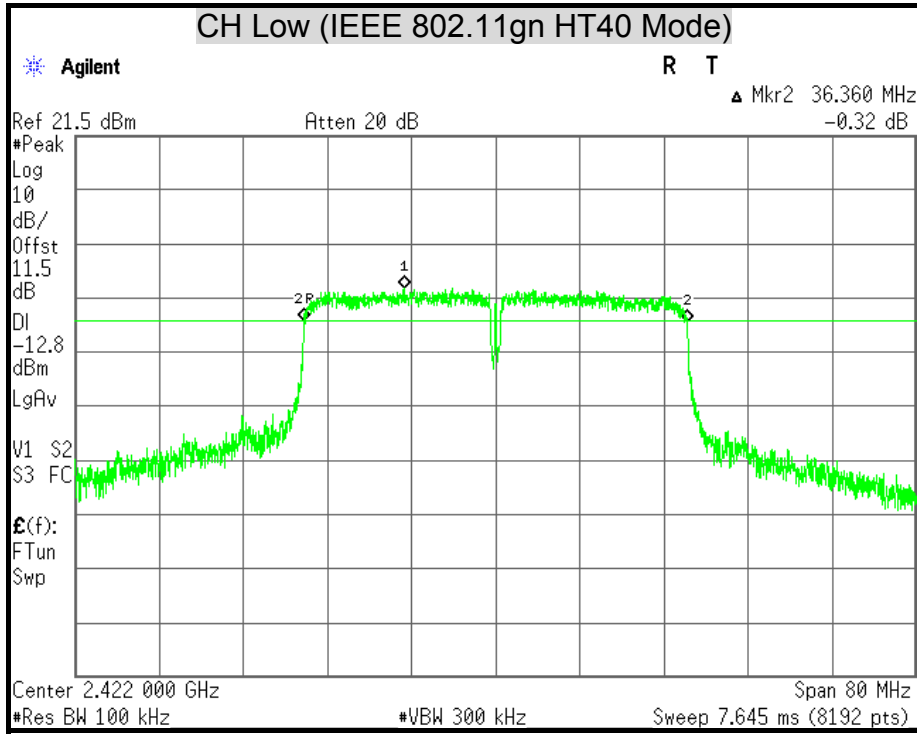

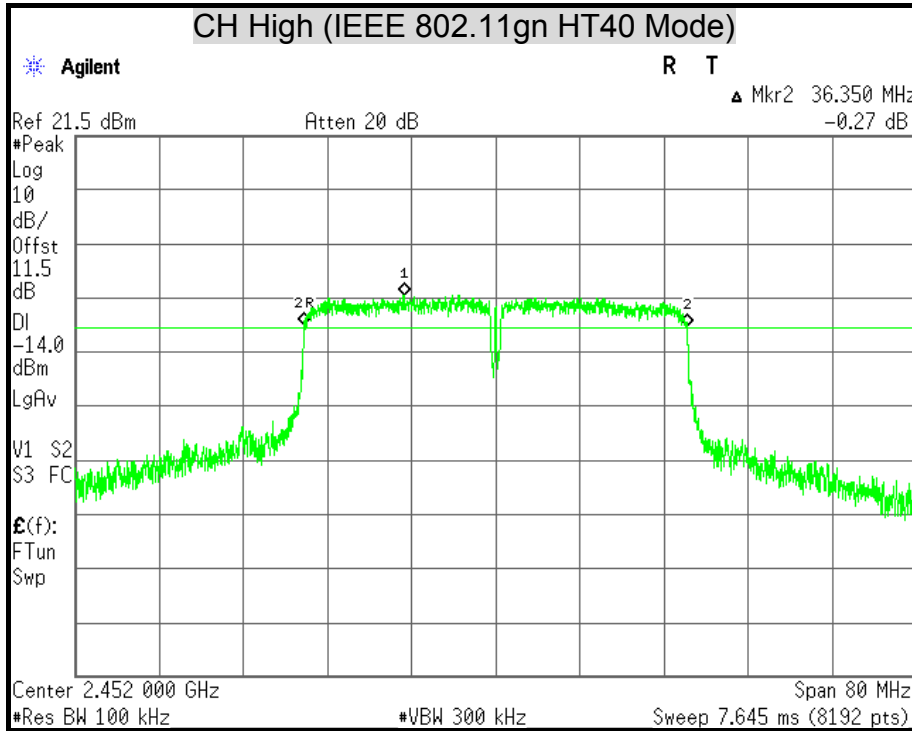



7.2 MAXIMUM PEAK OUTPUT POWER

LIMITS

§ 15.247(b) The maximum peak output power of the intentional radiator shall not exceed the following :

§ 15.247(b) (3) For systems using digital modulation in the 902-928 MHz, 2400-2483.5 MHz, and 5725-5850 MHz bands : 1 watt.

§ 15.247(b) (4) Except as shown in paragraphs (c) of this section, if transmitting antennas of directional gain greater than 6 dBi are used the peak output power from the intentional radiator shall be reduced below the stated values in paragraphs (b)(1) or (b)(2), and (b)(3) of this section, as appropriate, by the amount in dB that the directional gain of the antenna exceeds 6 dBi.

TEST EQUIPMENT

Name of Equipment	Manufacturer	Model	Serial Number	Calibration Due
Power Meter	ANRITSU	ML2495A	1149001	12/06/2014
Power Sensor	ANRITSU	MA2411B	1126148	12/06/2014

Remark: Each piece of equipment is scheduled for calibration once a year.

TEST SETUP



TEST PROCEDURE

The transmitter output is connected to the power meter. The power meter is set to the peak power detection.



TEST RESULTS

IEEE 802.11b Mode

Channel	Channel Frequency (MHz)	Peak Power (dBm)		Peak Power Limit		Pass / Fail
		(dBm)	(W)	(dBm)	(W)	
Low	2412	18.38	0.0688	30	1	PASS
Middle	2437	16.36	0.0432	30	1	PASS
High	2462	14.73	0.0297	30	1	PASS

Remark:

1. At final test to get the worst-case emission at 1Mbps.
2. The cable assembly insertion loss of 10.5dB (including 10 dB pad and 0.5 dB cable) was Entered as an offset in the power meter to allow for direct reading of power.

IEEE 802.11g Mode

Channel	Channel Frequency (MHz)	Peak Power (dBm)		Peak Power Limit		Pass / Fail
		(dBm)	(W)	(dBm)	(W)	
Low	2412	19.23	0.0837	30	1	PASS
Middle	2437	19.00	0.0795	30	1	PASS
High	2462	17.30	0.0537	30	1	PASS

Remark:

1. At final test to get the worst-case emission at 6Mbps.
2. The cable assembly insertion loss of 10.5dB (including 10 dB pad and 0.5 dB cable) was Entered as an offset in the power meter to allow for direct reading of power.



IEEE 802.11gn HT20 mode

Channel	Channel Frequency (MHz)	Peak Power		Peak Power Limit		Pass / Fail
		(dBm)	(W)	(dBm)	(W)	
Low	2412	18.26	0.0670	30	1	PASS
Middle	2437	19.14	0.0821	30	1	PASS
High	2462	16.82	0.0481	30	1	PASS

Remark:

1. At final test to get the worst-case emission at 6.5Mbps.
2. The cable assembly insertion loss of 10.5dB (including 10 dB pad and 0.5 dB cable) was Entered as an offset in the power meter to allow for direct reading of power.

IEEE 802.11gn HT40 mode

Channel	Channel Frequency (MHz)	Peak Power		Peak Power Limit		Pass / Fail
		(dBm)	(W)	(dBm)	(W)	
Low	2422	17.30	0.0537	30	1	PASS
Middle	2437	19.11	0.0815	30	1	PASS
High	2452	16.13	0.0410	30	1	PASS

Remark:

1. At final test to get the worst-case emission at 13.5Mbps.
2. The cable assembly insertion loss of 10.5dB (including 10 dB pad and 0.5 dB cable) was Entered as an offset in the power meter to allow for direct reading of power.



7.3 AVERAGE POWER

LIMITS

None; for reporting purposes only.

TEST EQUIPMENT

Name of Equipment	Manufacturer	Model	Serial Number	Calibration Due
Power Meter	ANRITSU	ML2495A	1149001	12/06/2014
Power Sensor	ANRITSU	MA2411B	1126148	12/06/2014

Remark: Each piece of equipment is scheduled for calibration once a year.

TEST SETUP



TEST PROCEDURE

The transmitter output is connected to the power meter. The power meter is set to the average power detection.



TEST RESULTS

IEEE 802.11b Mode

Channel	Channel Frequency (MHz)	Average Power (dBm)
Low	2412	15.40
Middle	2437	13.35
High	2462	11.64

Remark:

1. At final test to get the worst-case emission at 1Mbps.
2. The cable assembly insertion loss of 10.5 dB (including 10 dB pad and 0.5 dB cable) was Entered as an offset in the power meter to allow for direct reading of power.

IEEE 802.11g Mode

Channel	Channel Frequency (MHz)	Average Power (dBm)
Low	2412	12.15
Middle	2437	12.10
High	2462	10.39

Remark:

1. At final test to get the worst-case emission at 6Mbps.
2. The cable assembly insertion loss of 10.5 dB (including 10 dB pad and 0.5 dB cable) was Entered as an offset in the power meter to allow for direct reading of power.



IEEE 802.11gn HT20 mode

Channel	Channel Frequency (MHz)	Average Power Output (dBm)
Low	2412	11.15
Middle	2437	12.13
High	2462	9.75

Remark:

1. At final test to get the worst-case emission at 6.5Mbps.
2. The cable assembly insertion loss of 10.5 dB (including 10 dB pad and 0.5 dB cable) was Entered as an offset in the power meter to allow for direct reading of power.

IEEE 802.11gn HT40 mode

Channel	Channel Frequency (MHz)	Average Power Output (dBm)
Low	2422	10.28
Middle	2437	12.04
High	2452	9.04

Remark:

1. At final test to get the worst-case emission at 13.5Mbps.
2. The cable assembly insertion loss of 10.5 dB (including 10 dB pad and 0.5 dB cable) was Entered as an offset in the power meter to allow for direct reading of power.



7.4 POWER SPECTRAL DENSITY

LIMITS

§ 15.247(e) For digitally modulated systems, the power spectral density conducted from the intentional radiator to the antenna shall not greater than 8 dBm in any 3 kHz band during any time interval of continuous transmission.

TEST EQUIPMENT

Name of Equipment	Manufacturer	Model	Serial Number	Calibration Due
Spectrum Analyzer	Agilent	E4446A	MY43360132	06/10/2015

Remark: Each piece of equipment is scheduled for calibration once a year.

TEST SETUP



TEST PROCEDURE

1. The transmitter output was connected to the spectrum analyzer.
2. Set analyzer center frequency to DTS channel center frequency.
3. Set the span to 1.5 times the DTS channel bandwidth.
4. Set the RBW to: $3 \text{ kHz} \leq \text{RBW} \leq 100 \text{ kHz}$.
5. Set the VBW $\geq 3 \times \text{RBW}$.
6. Detector = peak.
7. Sweep time = auto couple.
8. Trace mode = max hold.
9. Allow trace to fully stabilize.
10. Use the peak marker function to determine the maximum amplitude level within the RBW.
11. If measured value exceeds limit, reduce RBW (no less than 3 kHz) and repeat.



TEST RESULTS

IEEE 802.11b Mode

Channel	Channel Frequency (MHz)	Final RF Power Level in 3kHz BW (dBm)	Minimum Limit (dBm)	Pass / Fail
Low	2412	-13.98	8	PASS
Middle	2437	-15.20	8	PASS
High	2462	-13.25	8	PASS

Remark:

1. At final test to get the worst-case emission at 1Mbps.
2. The cable assembly insertion loss of 10.5dB (including 10 dB pad and 0.5 dB cable) was Entered as an offset in the spectrum analyzer to allow for direct reading of power.

IEEE 802.11g Mode

Channel	Channel Frequency (MHz)	Final RF Power Level in 3kHz BW (dBm)	Minimum Limit (dBm)	Pass / Fail
Low	2412	-11.16	8	PASS
Middle	2437	-12.53	8	PASS
High	2462	-12.86	8	PASS

Remark:

1. At final test to get the worst-case emission at 6Mbps.
2. The cable assembly insertion loss of 10.5dB (including 10 dB pad and 0.5 dB cable) was Entered as an offset in the spectrum analyzer to allow for direct reading of power.



IEEE 802.11gn HT20 mode

Channel	Channel Frequency (MHz)	Final RF Power Level in 3kHz BW (dBm)	Minimum Limit (dBm)	Pass / Fail
Low	2412	-11.24	8	PASS
Middle	2437	-12.68	8	PASS
High	2462	-12.61	8	PASS

Remark:

1. At final test to get the worst-case emission at 6.5Mbps.
2. The cable assembly insertion loss of 10.5dB (including 10 dB pad and 0.5 dB cable) was Entered as an offset in the spectrum analyzer to allow for direct reading of power.

IEEE 802.11gn HT40 mode

Channel	Channel Frequency (MHz)	Final RF Power Level in 3kHz BW (dBm)	Minimum Limit (dBm)	Pass / Fail
Low	2412	-11.31	8	PASS
Middle	2437	-12.57	8	PASS
High	2452	-12.07	8	PASS

Remark:

1. At final test to get the worst-case emission at 13.5Mbps.
2. The cable assembly insertion loss of 10.5dB (including 10 dB pad and 0.5 dB cable) was Entered as an offset in the spectrum analyzer to allow for direct reading of power.



POWER SPECTRAL DENSITY

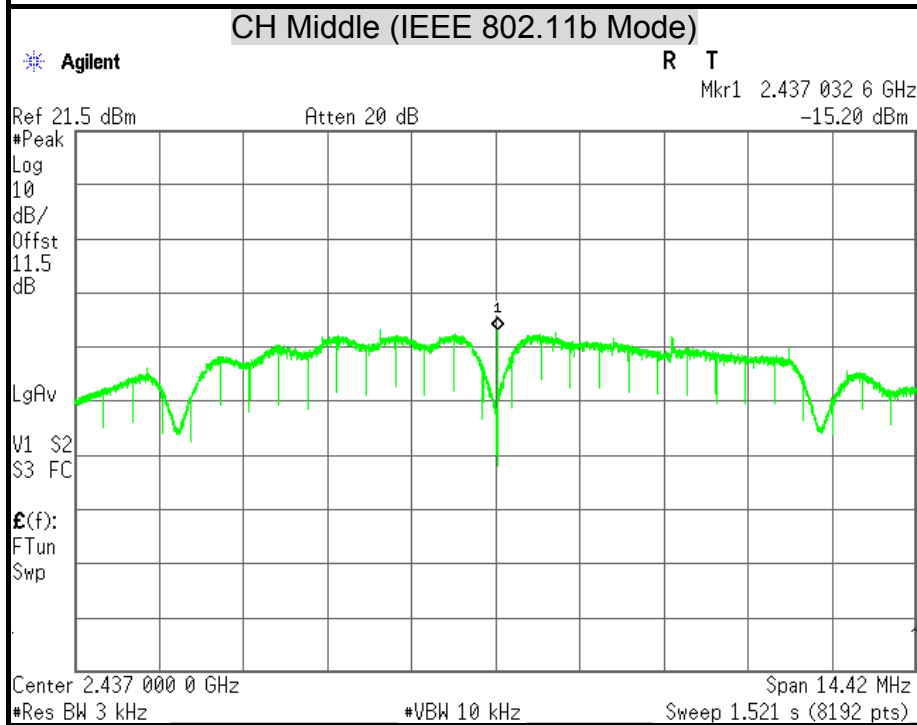
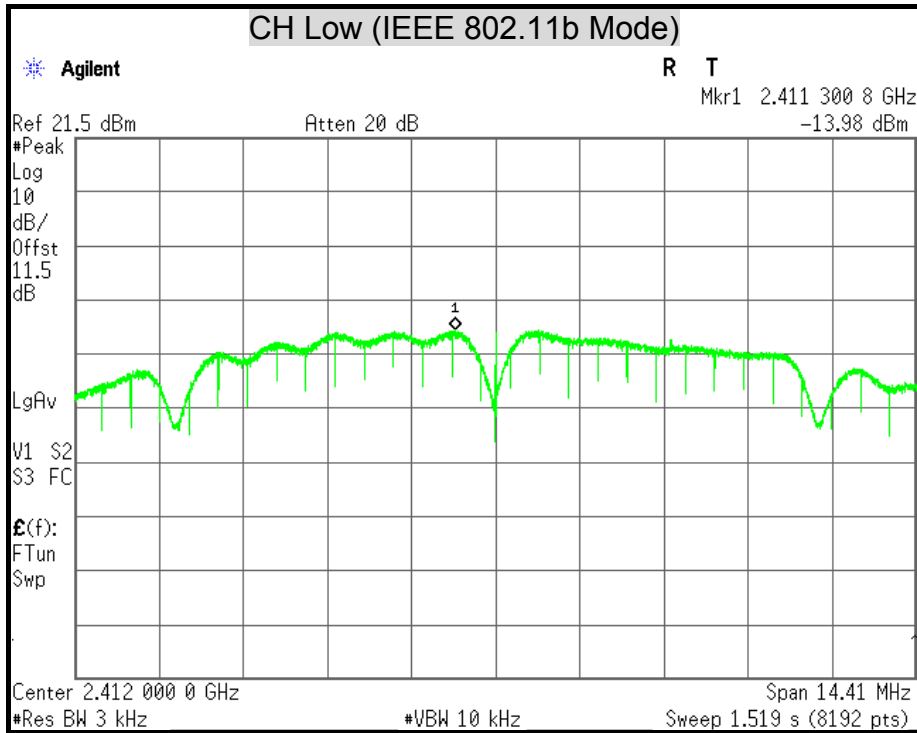

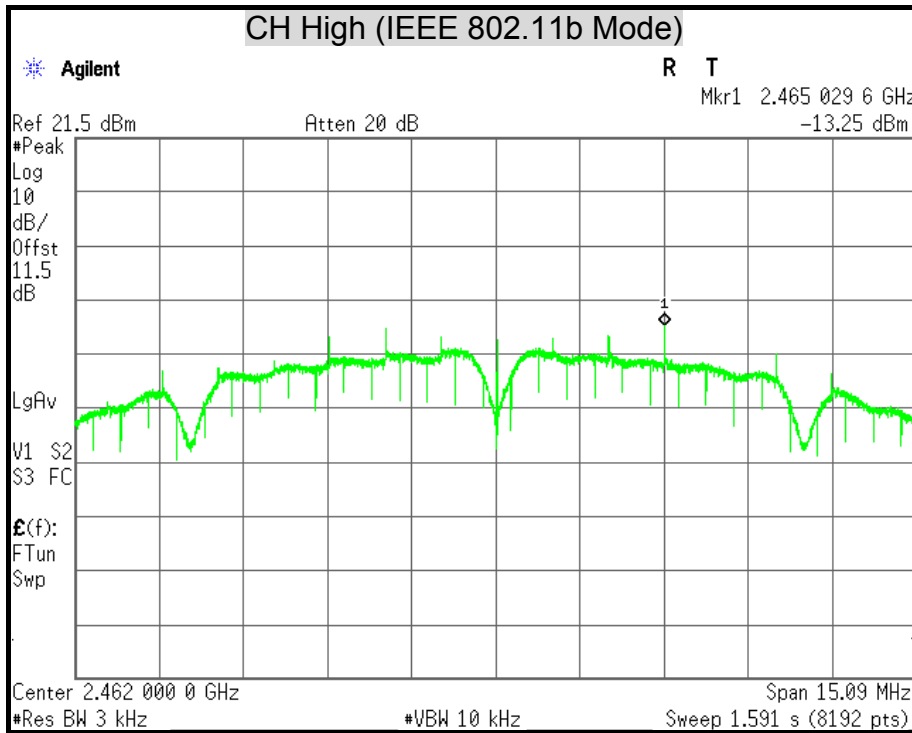

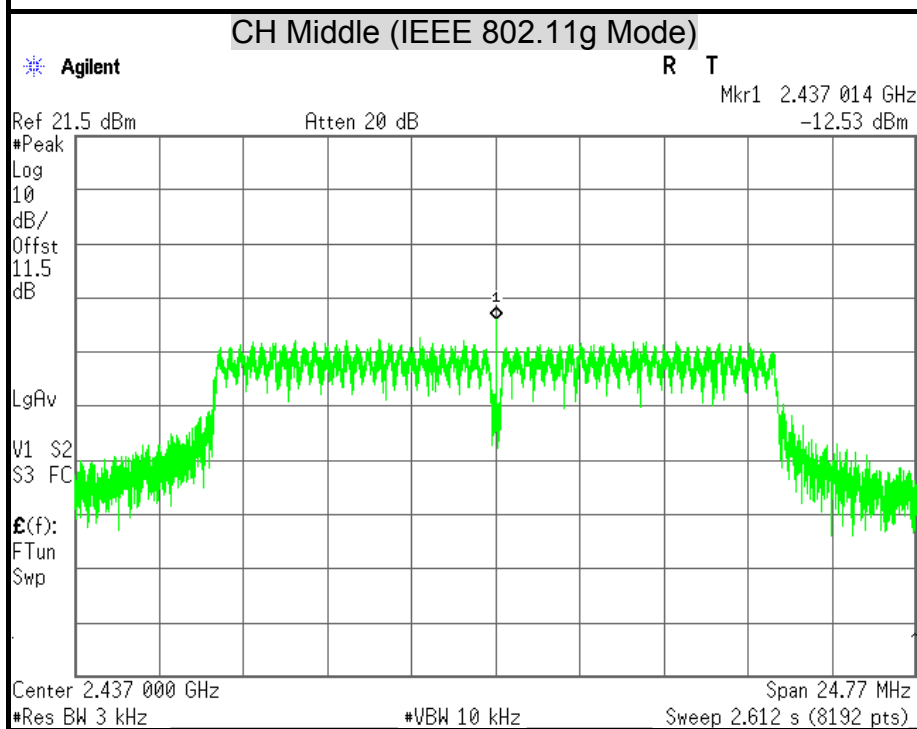
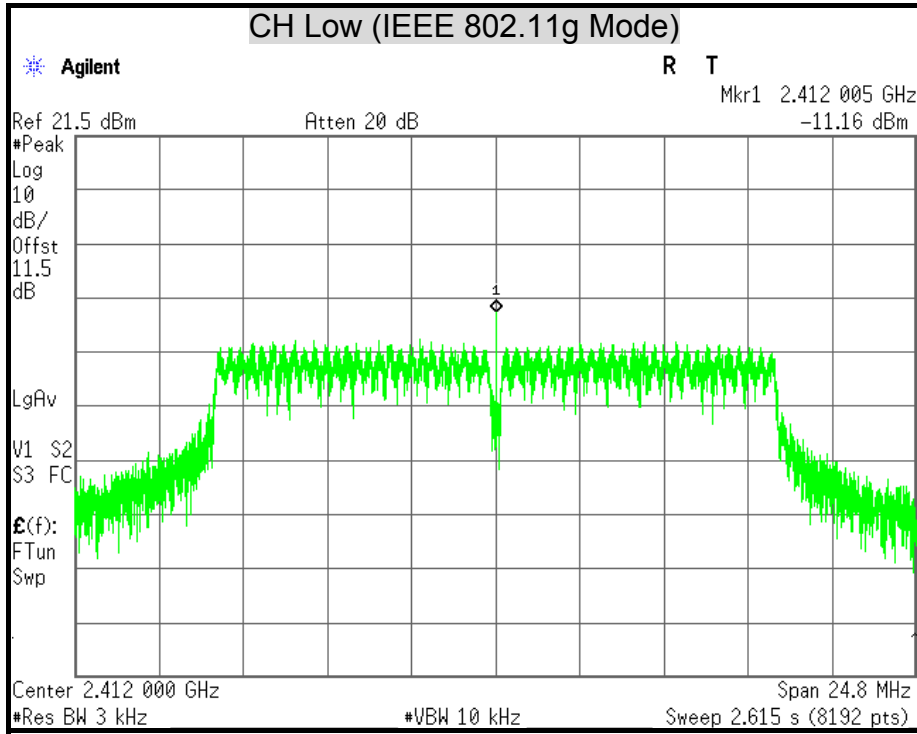

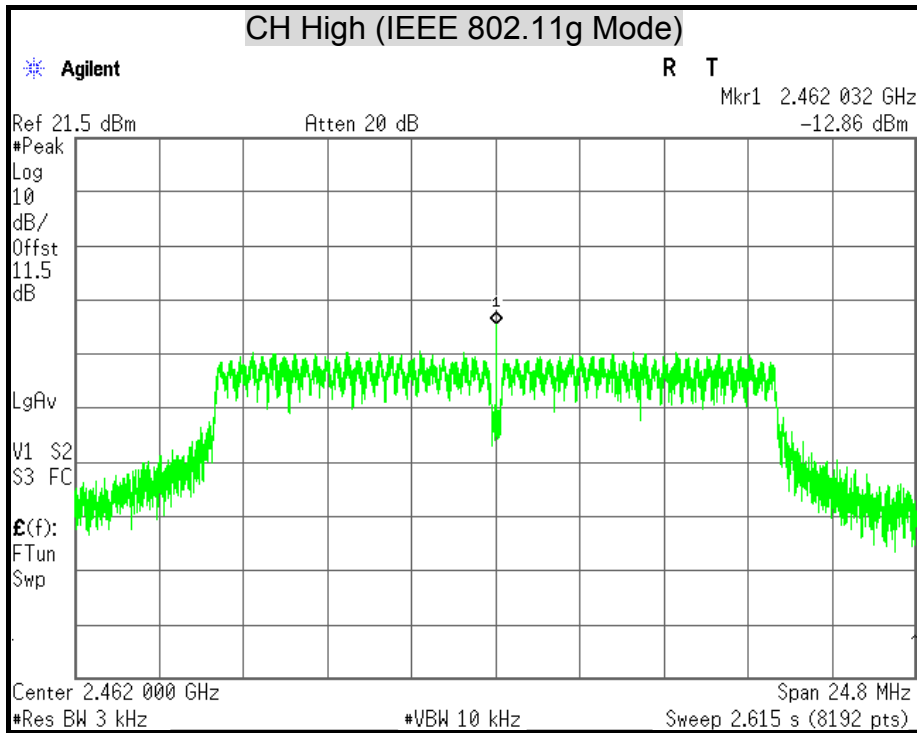

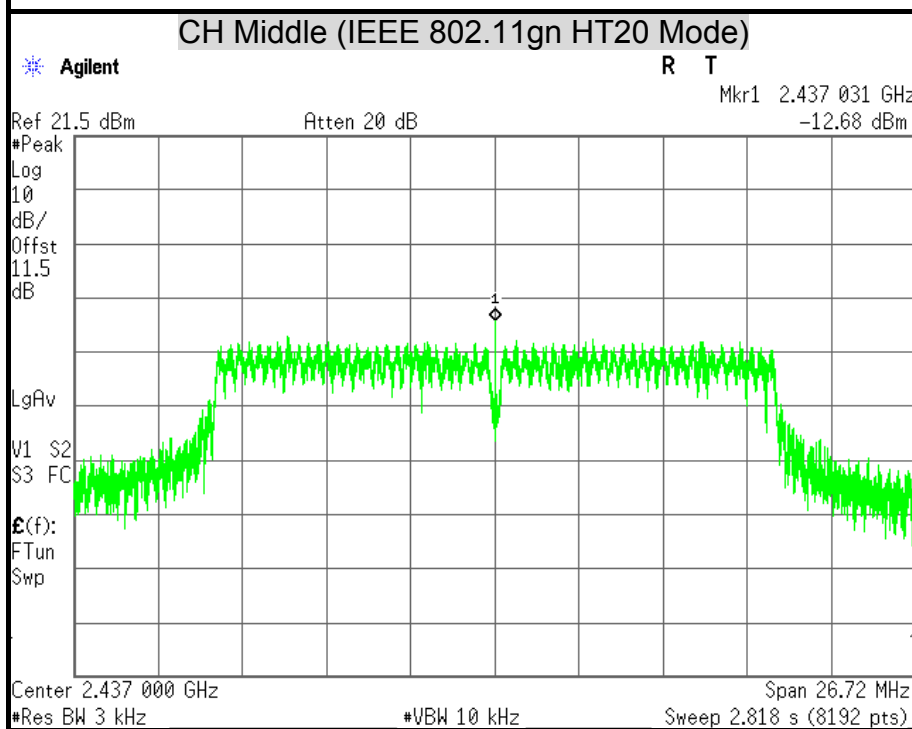
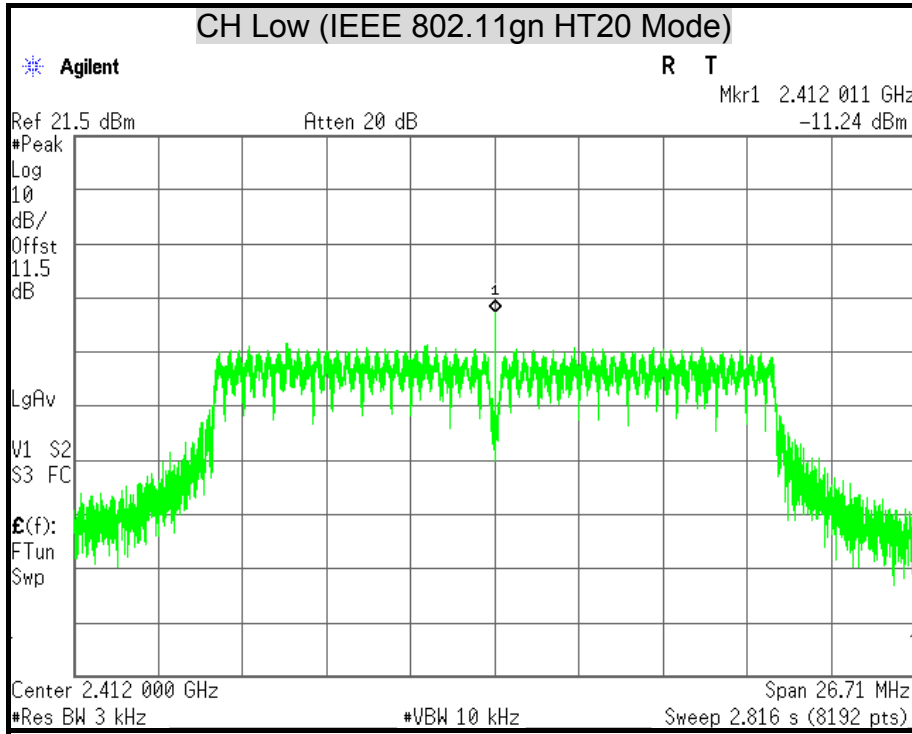

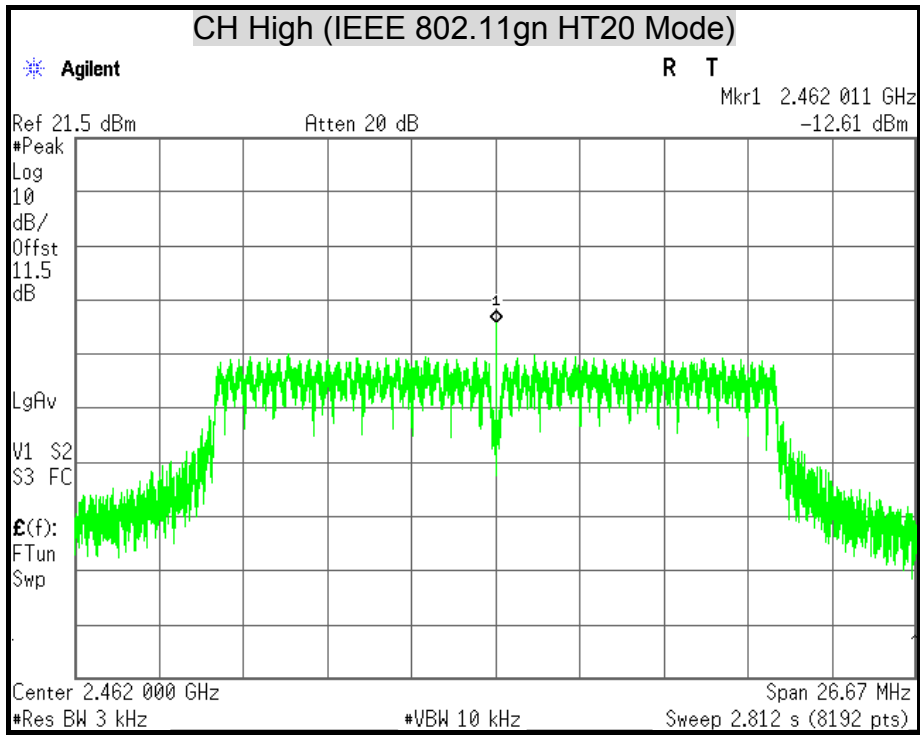

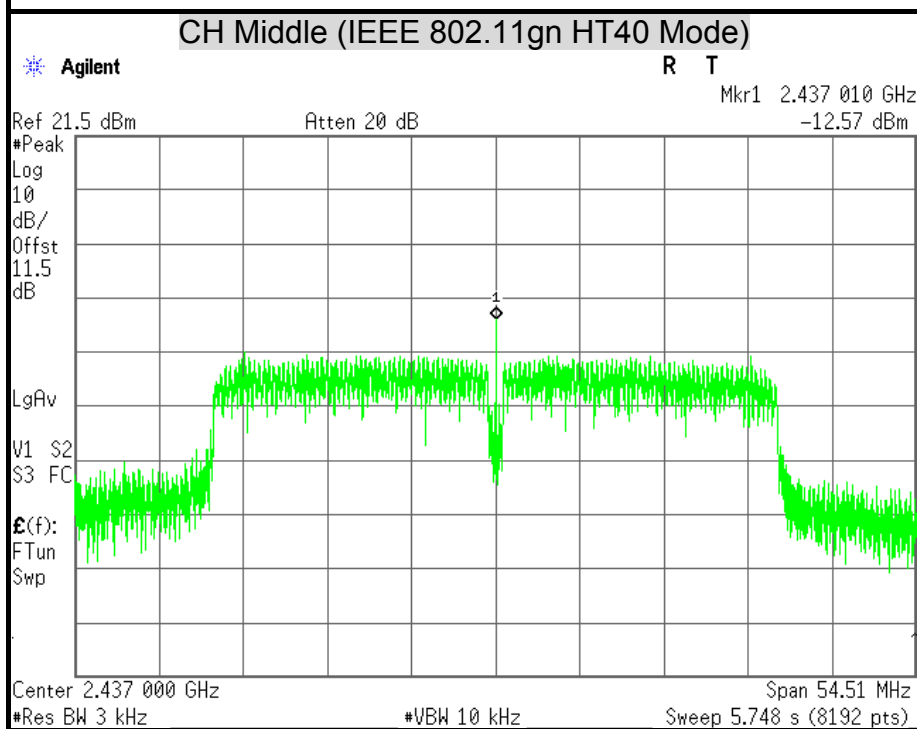
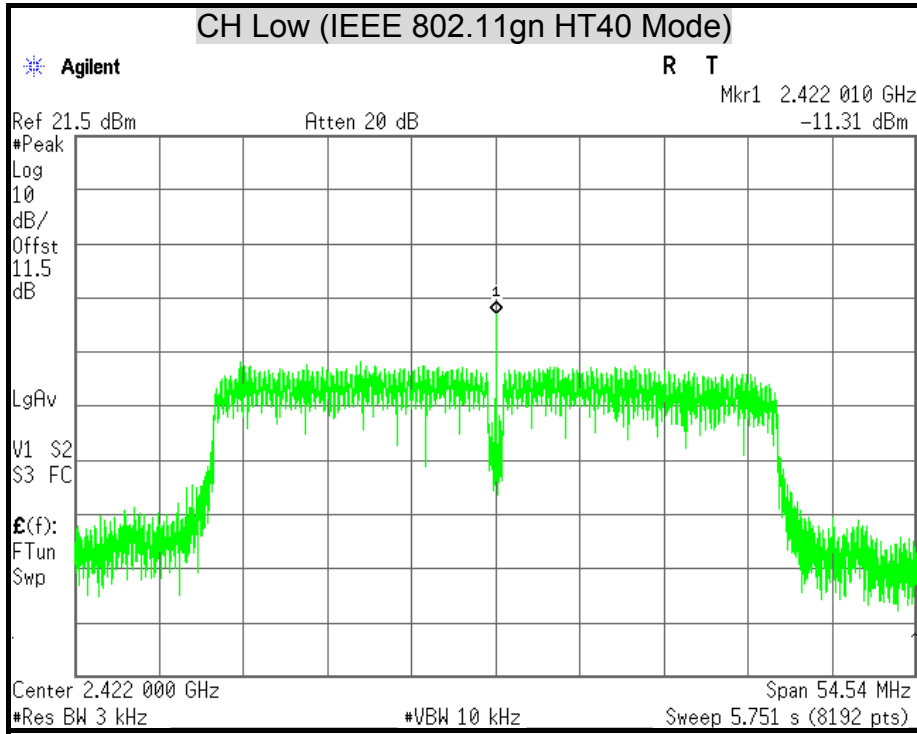

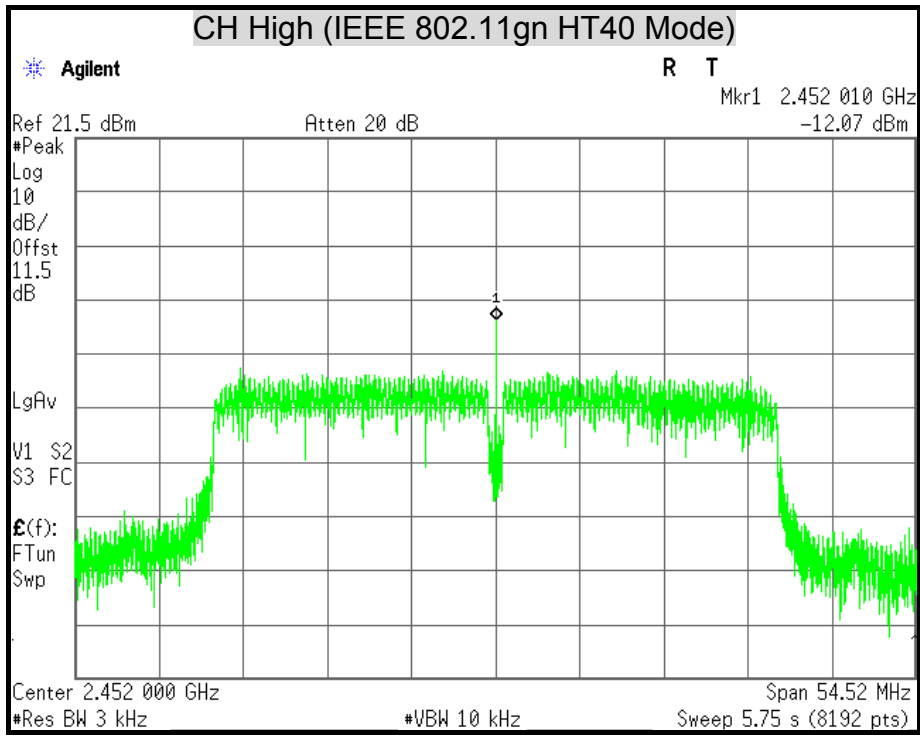



7.5 CONDUCTED SPURIOUS EMISSION

LIMITS

§ 15.247(d) In any 100 kHz bandwidth outside the frequency band in which the spread spectrum intentional radiator is operating, the radio frequency power that is produced by the intentional radiator shall be at least 20 dB below that in the 100 kHz bandwidth within the band that contains the highest level of the desired power, based on either an RF conducted or a radiated measurement. Attenuation below the general limits specified in § 15.209(a) is not required. In addition, radiated emissions which fall in the restricted bands, as defined in § 15.205(a), must also comply with the radiated emission limits specified in § 15.209(a) (see § 15.205(c)).

TEST EQUIPMENT

Name of Equipment	Manufacturer	Model	Serial Number	Calibration Due
Spectrum Analyzer	Agilent	E4446A	MY43360132	06/10/2015

Remark: Each piece of equipment is scheduled for calibration once a year.

TEST SETUP



TEST PROCEDURE

The transmitter output is connected to a spectrum analyzer. The resolution bandwidth is set to 100 kHz. The video bandwidth is set to 300 kHz.

The spectrum from 30 MHz to 26.5 GHz is investigated with the transmitter set to the lowest, middle, and highest channels in the 2.4 GHz band.



TEST RESULTS

OUT-OF-BAND SPURIOUS EMISSIONS-CONDUCTED MEASUREMENT

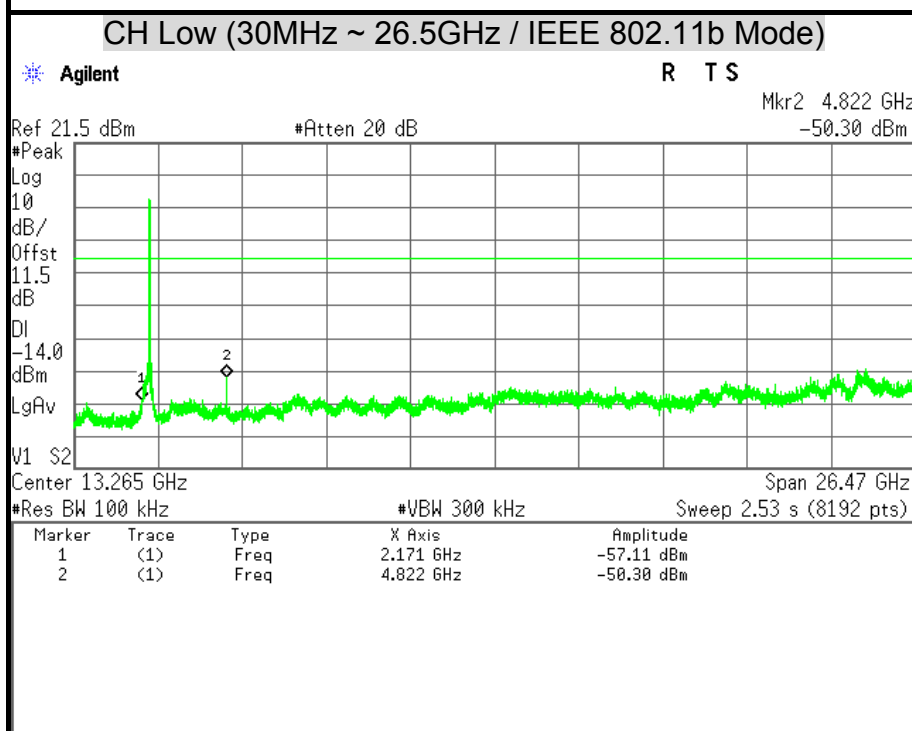
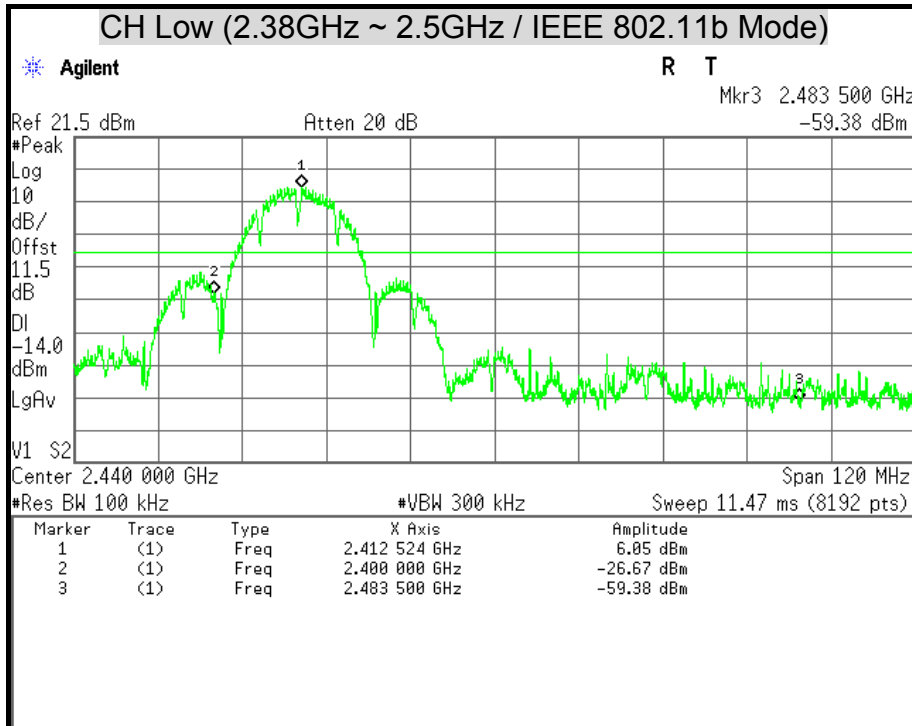

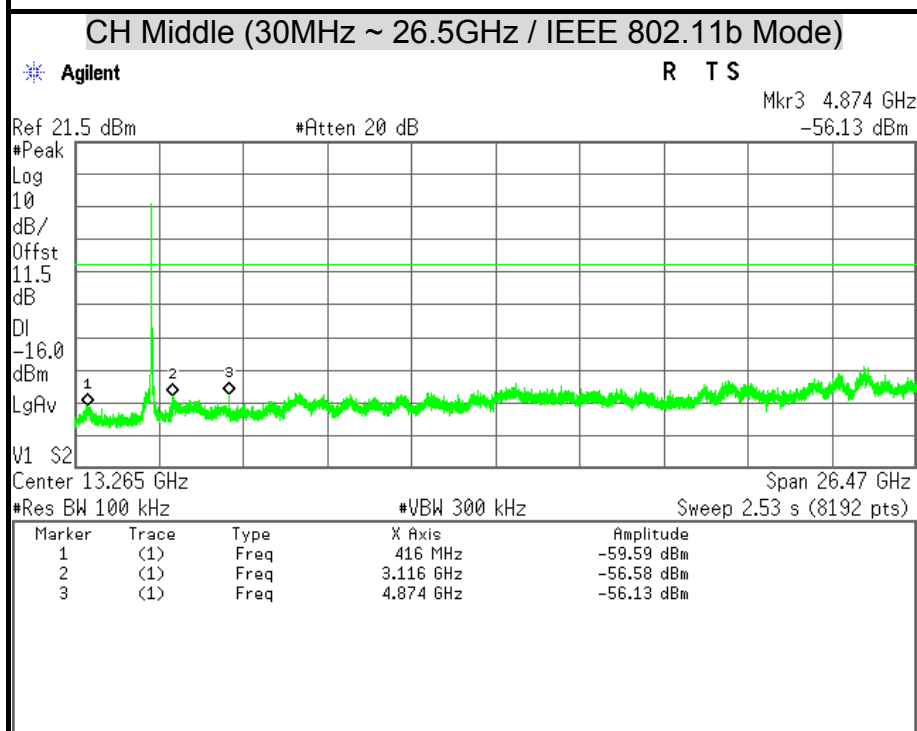
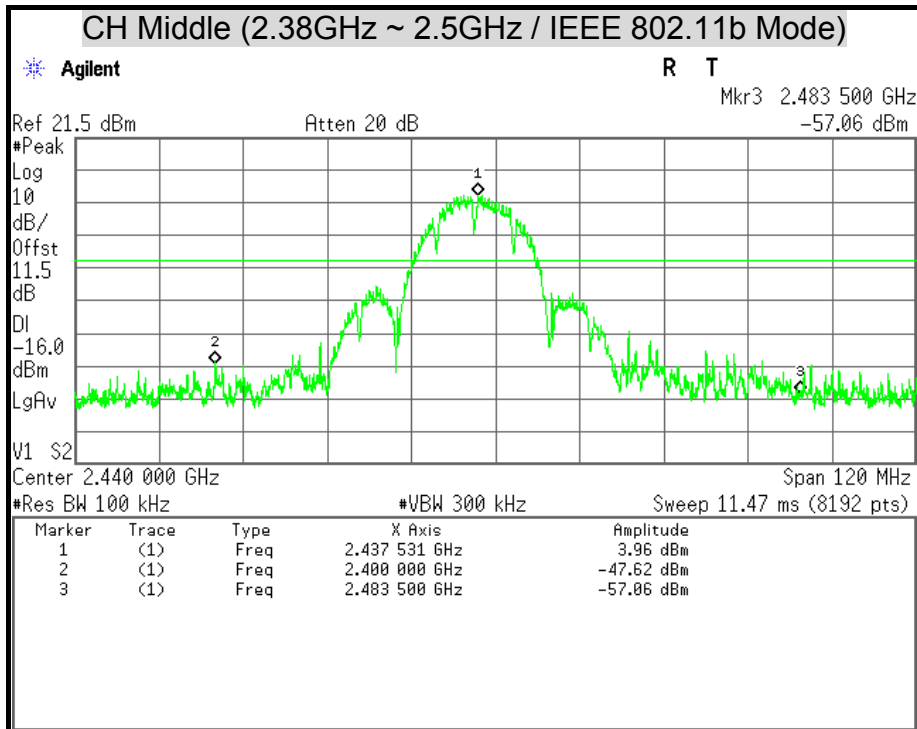

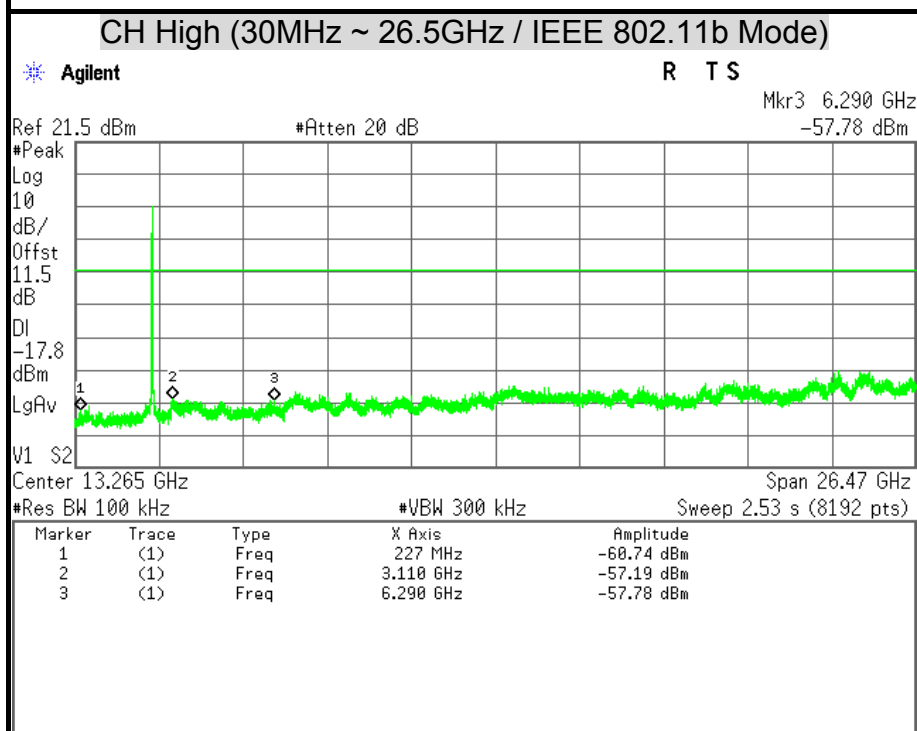
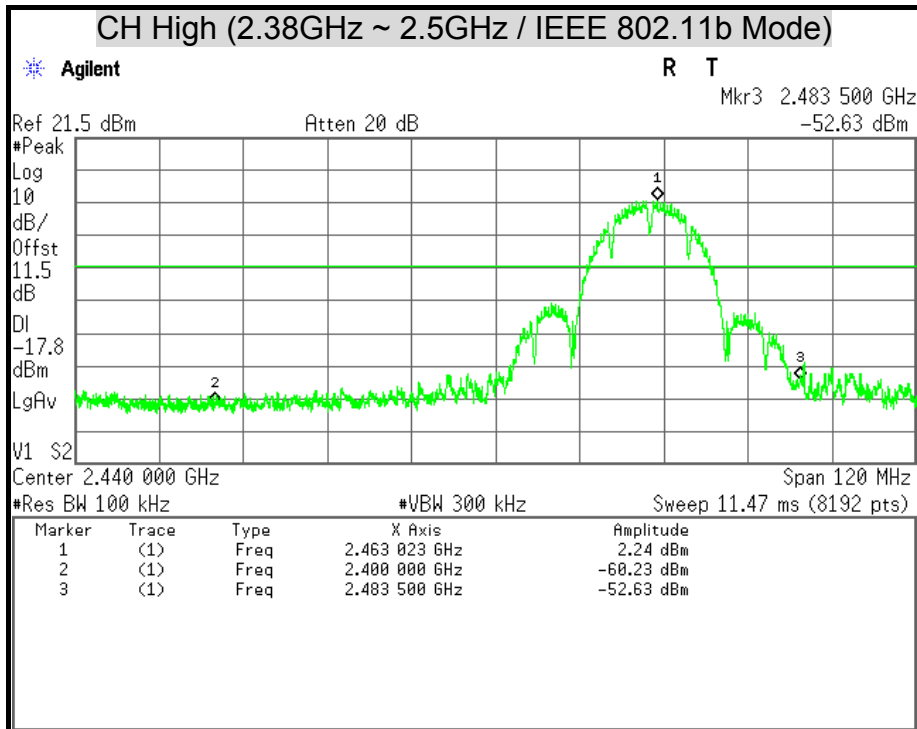

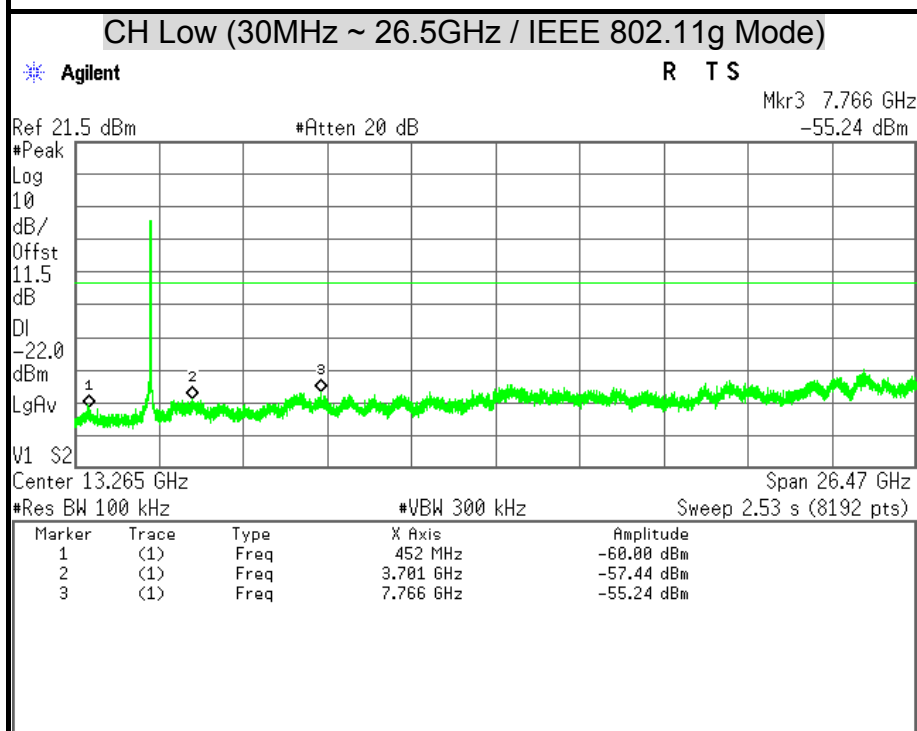
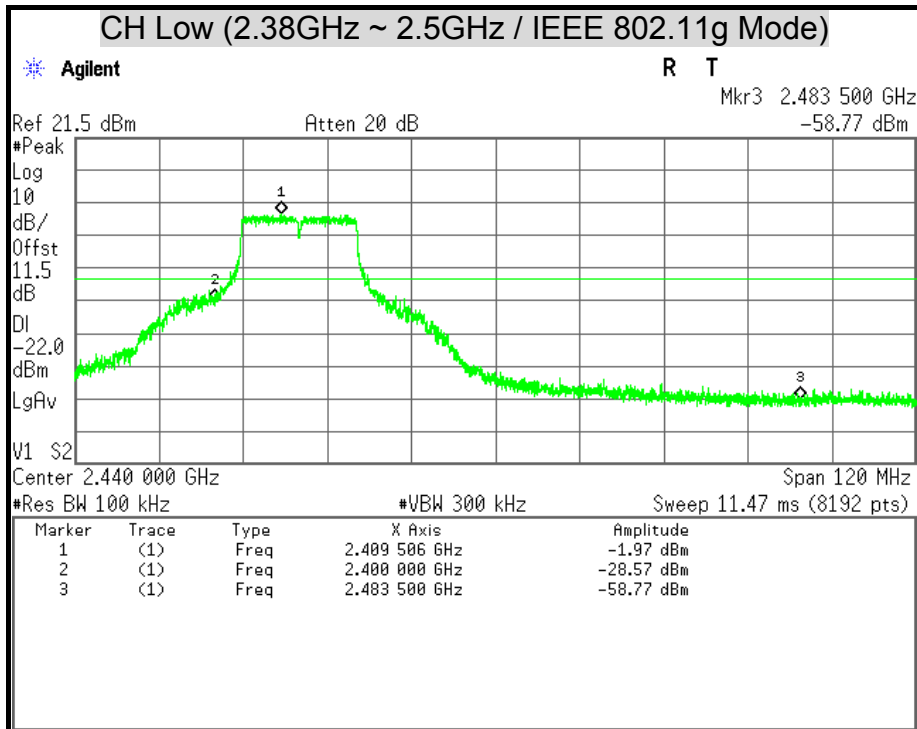

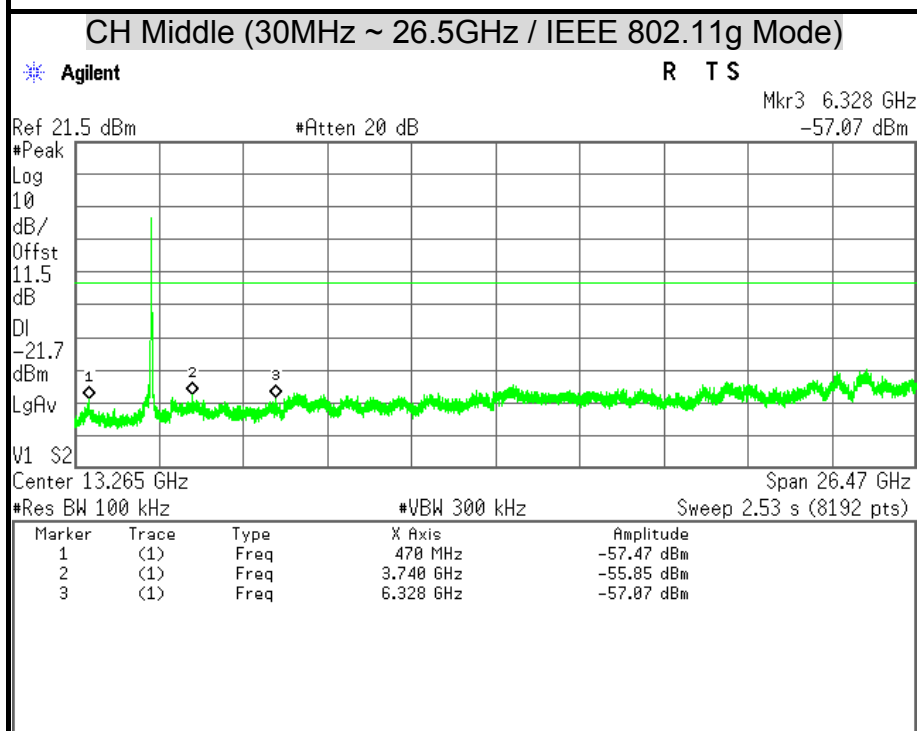
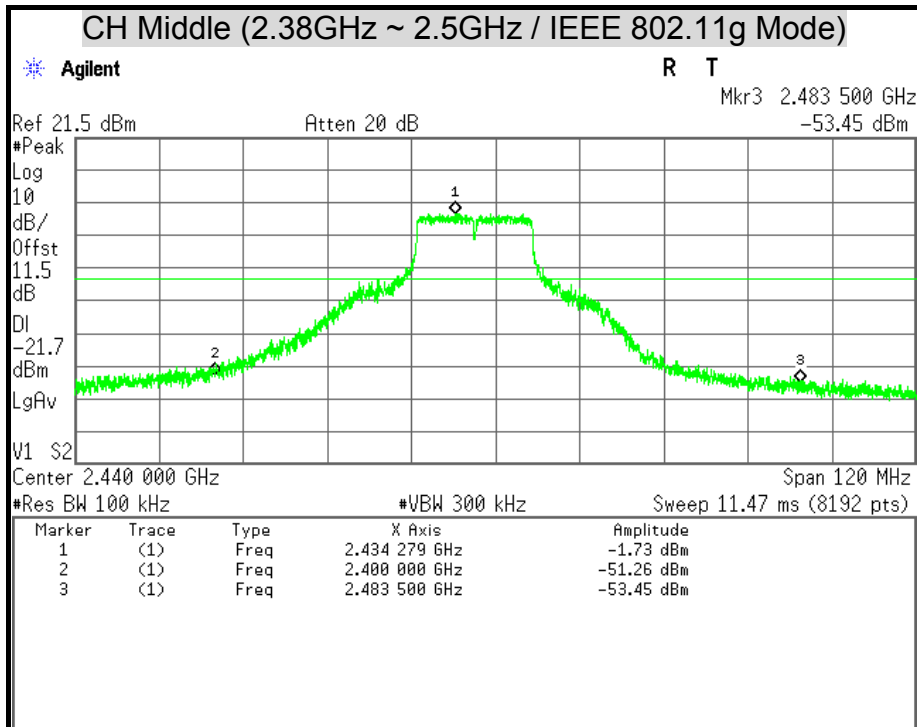

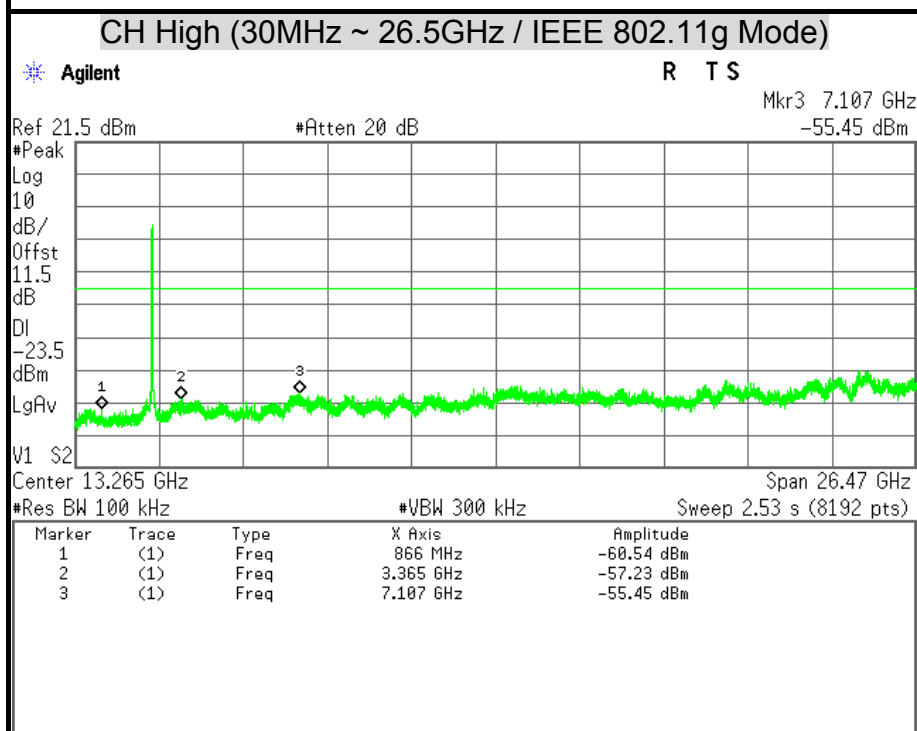
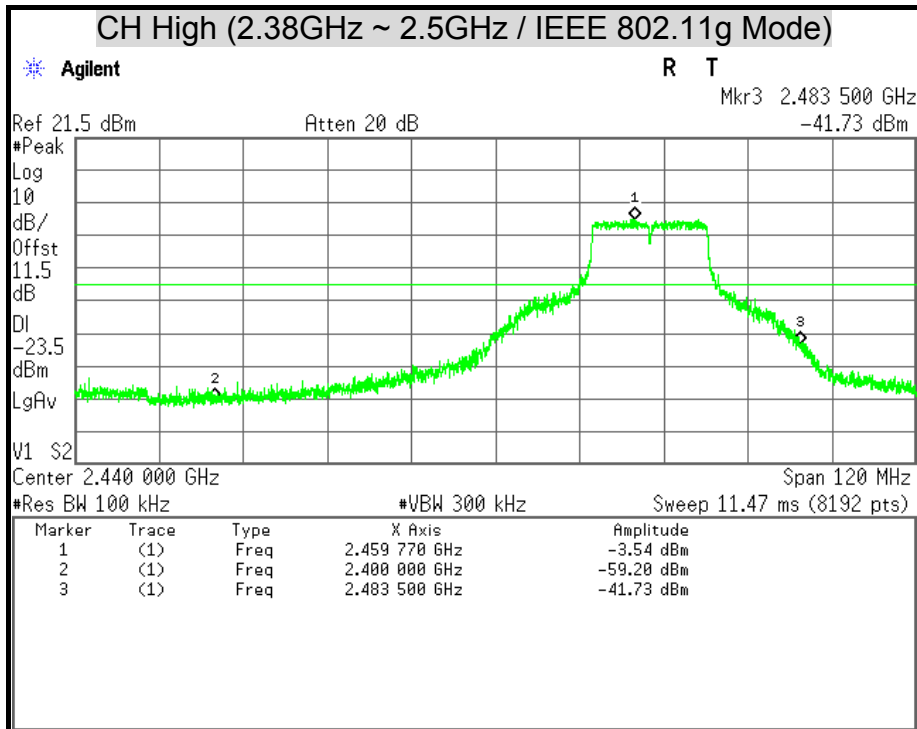

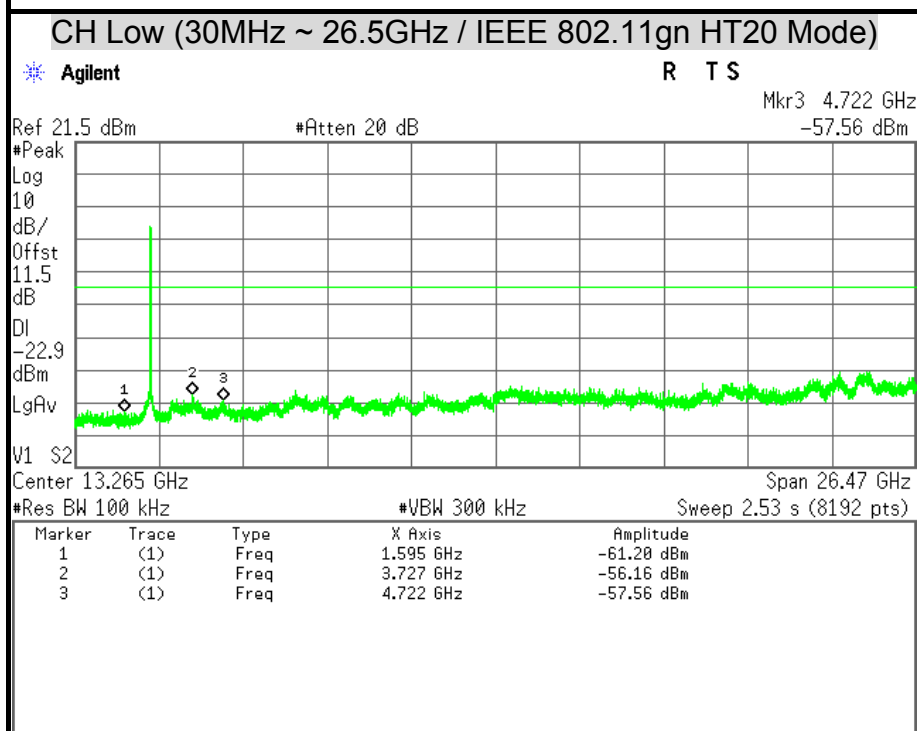
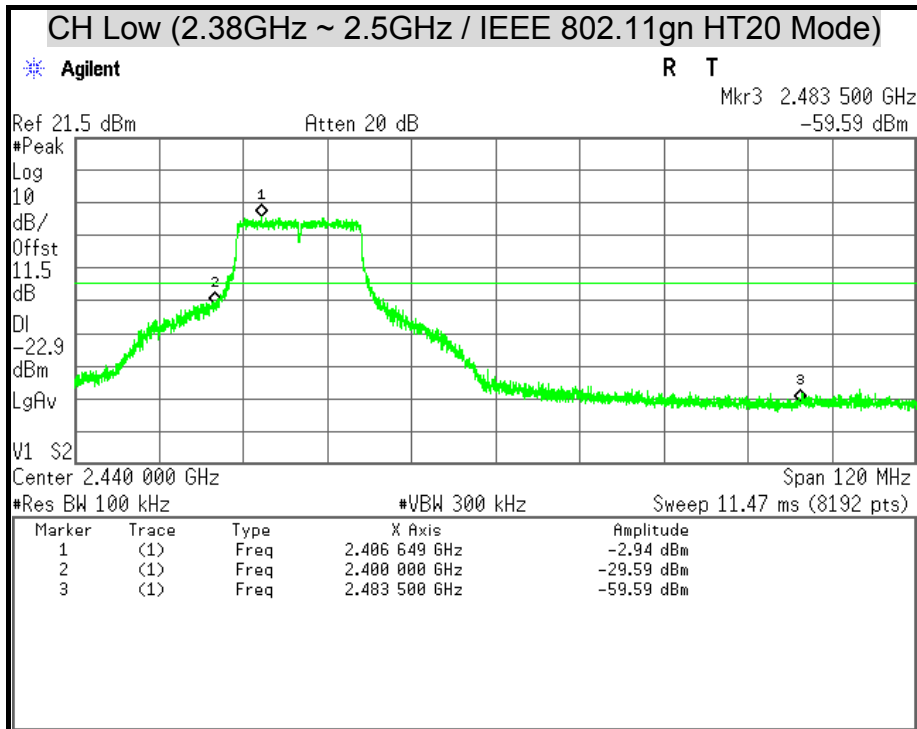

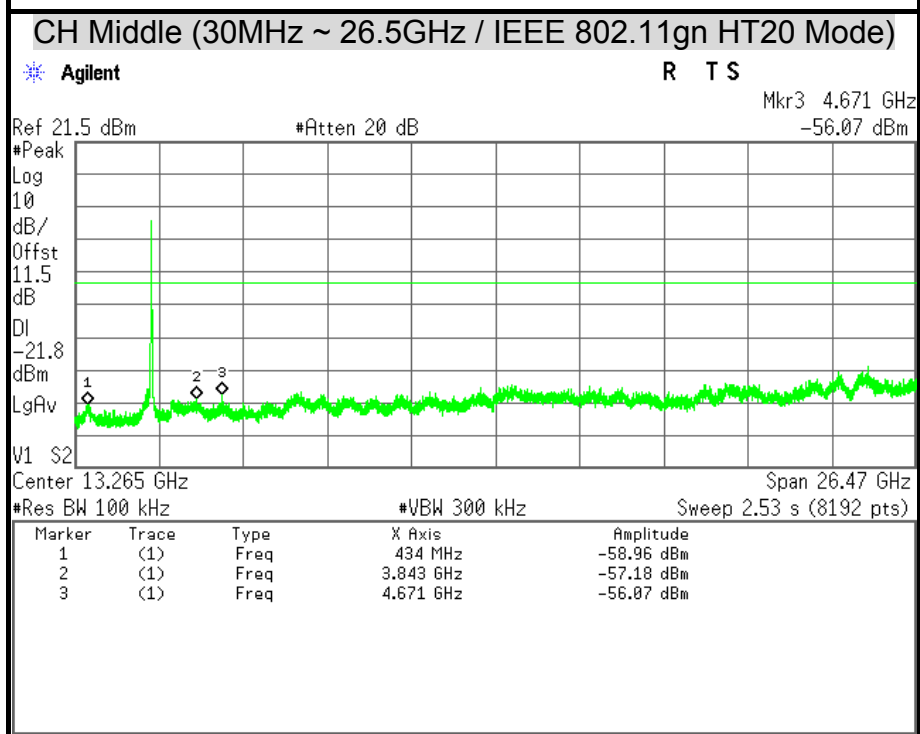
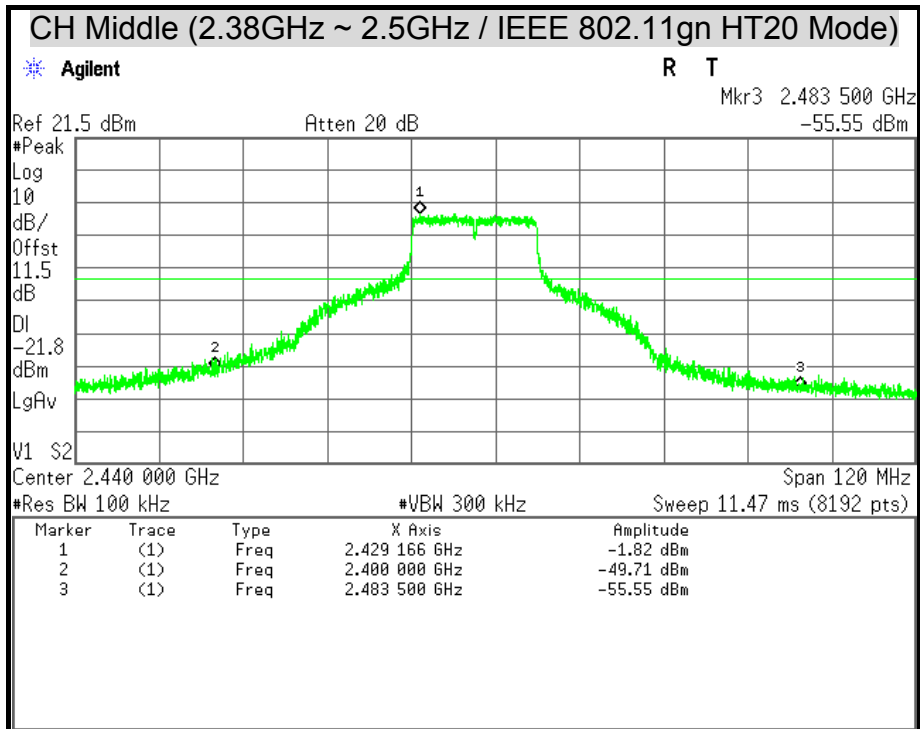

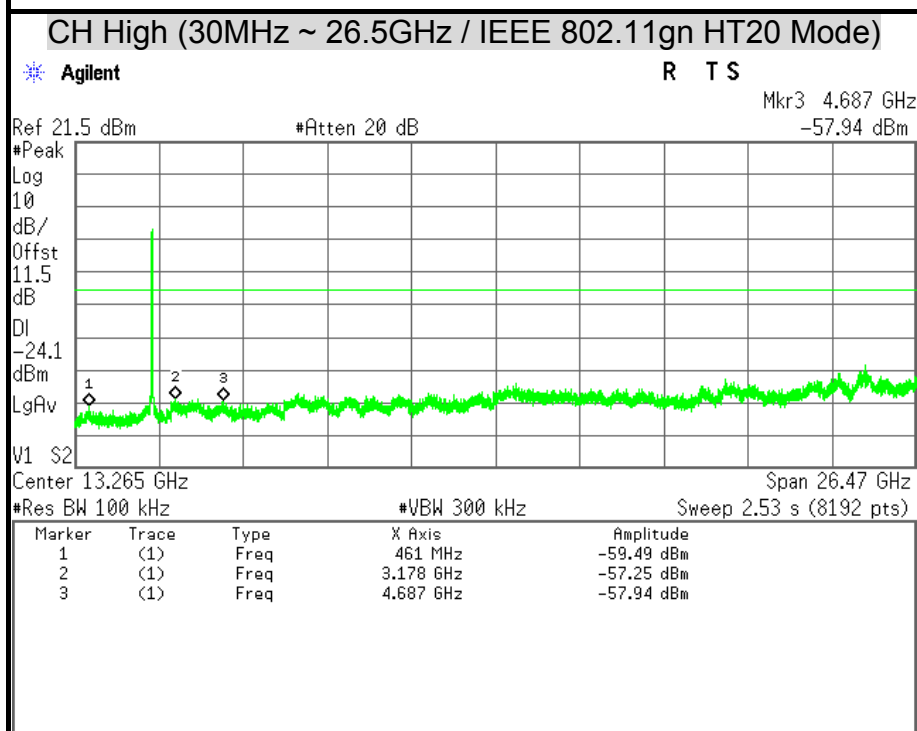
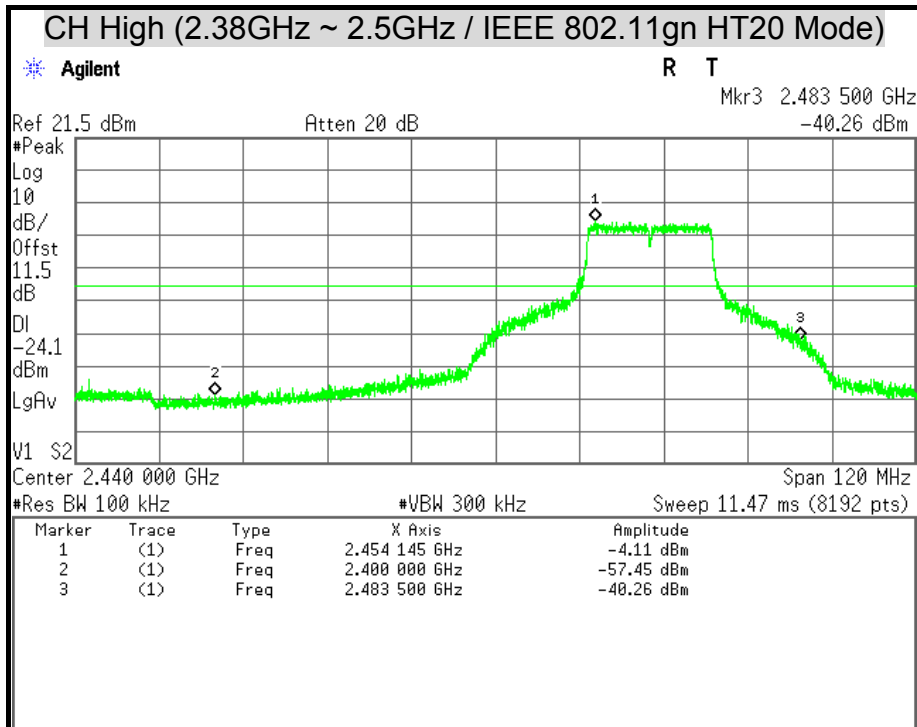

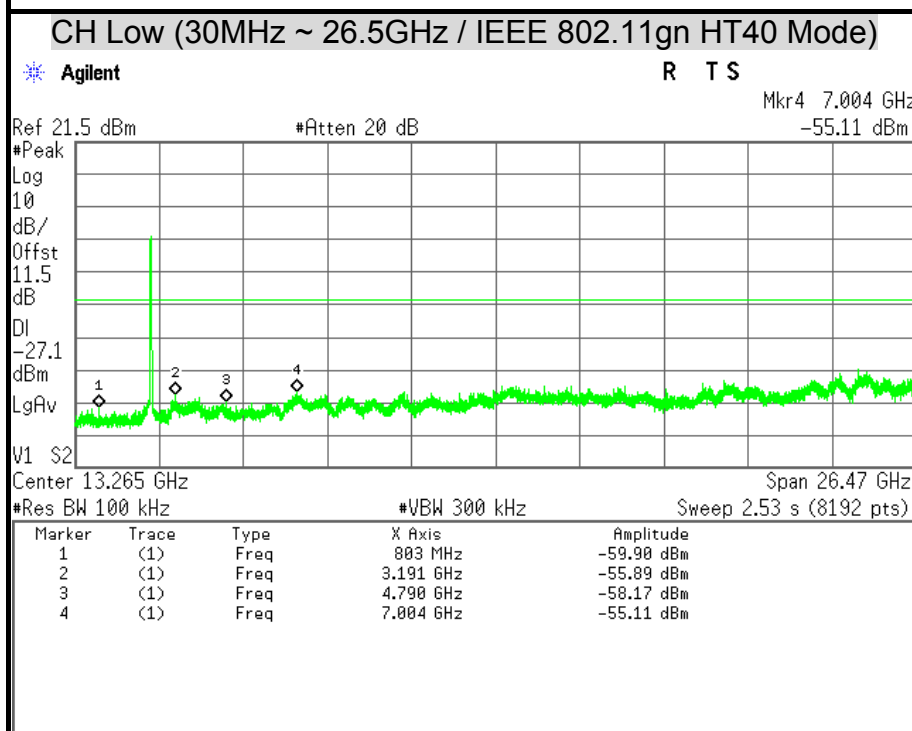
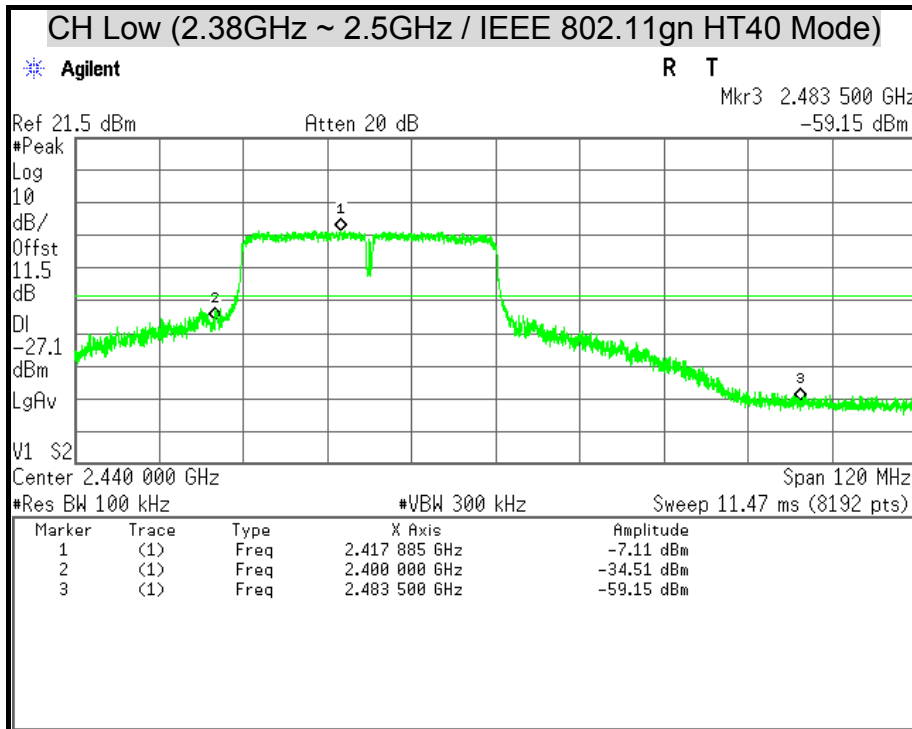

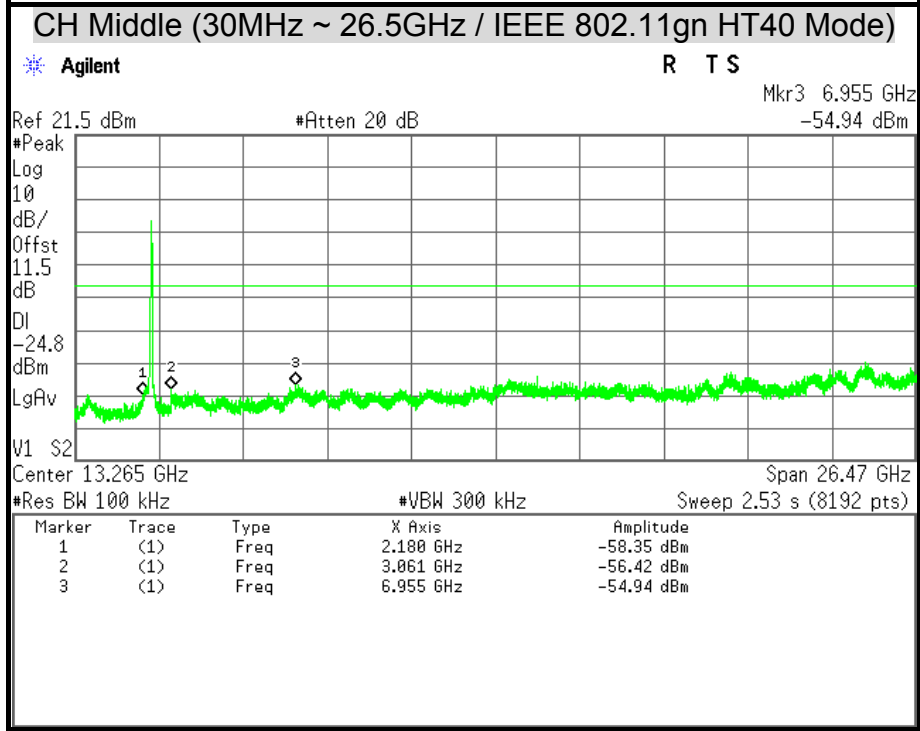
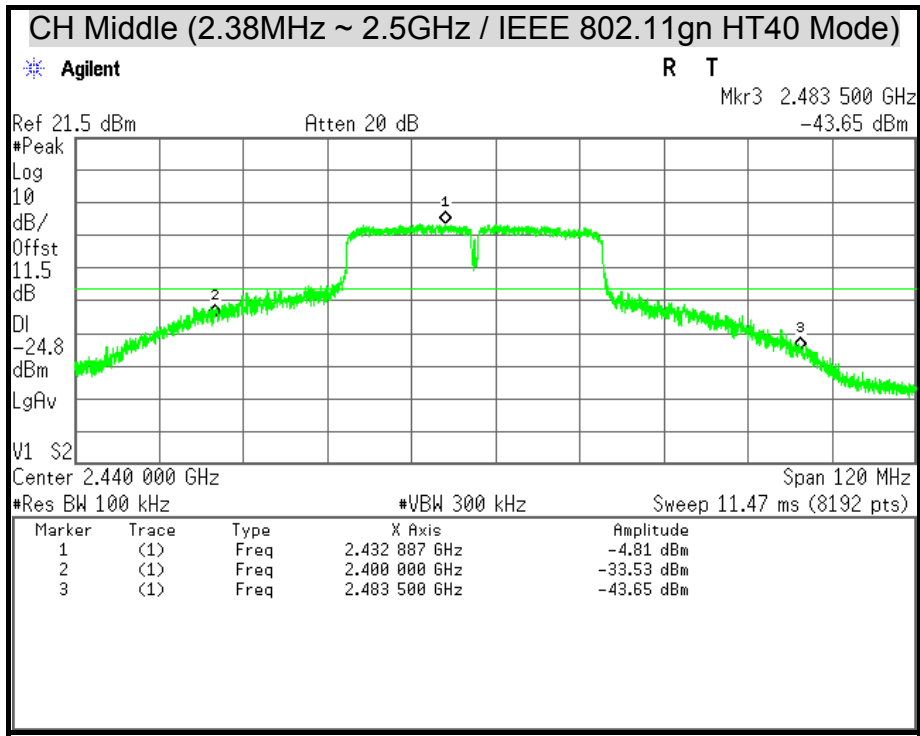

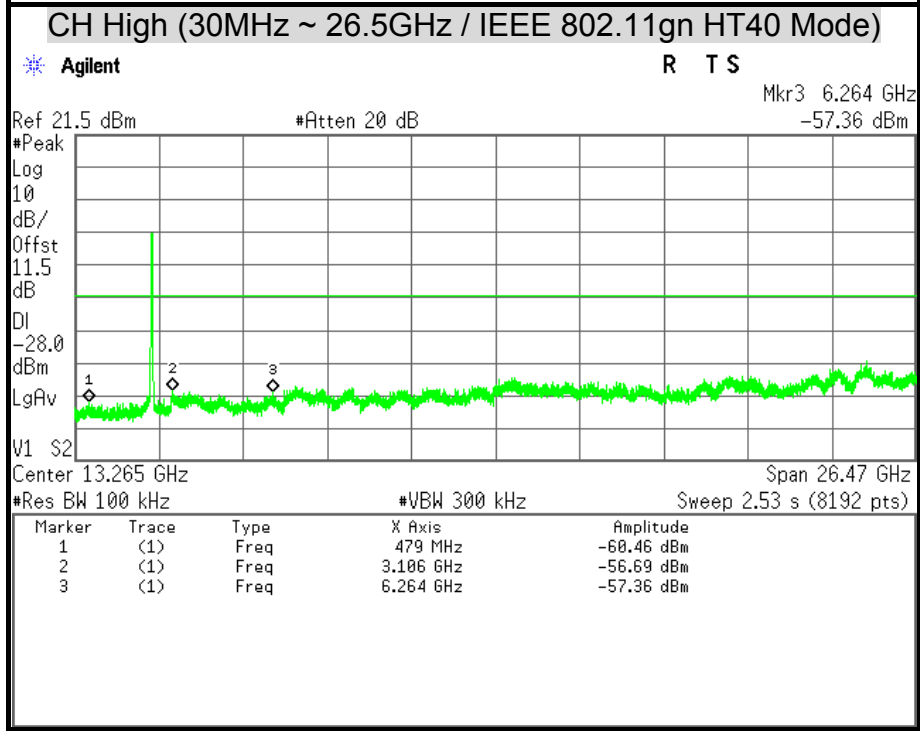
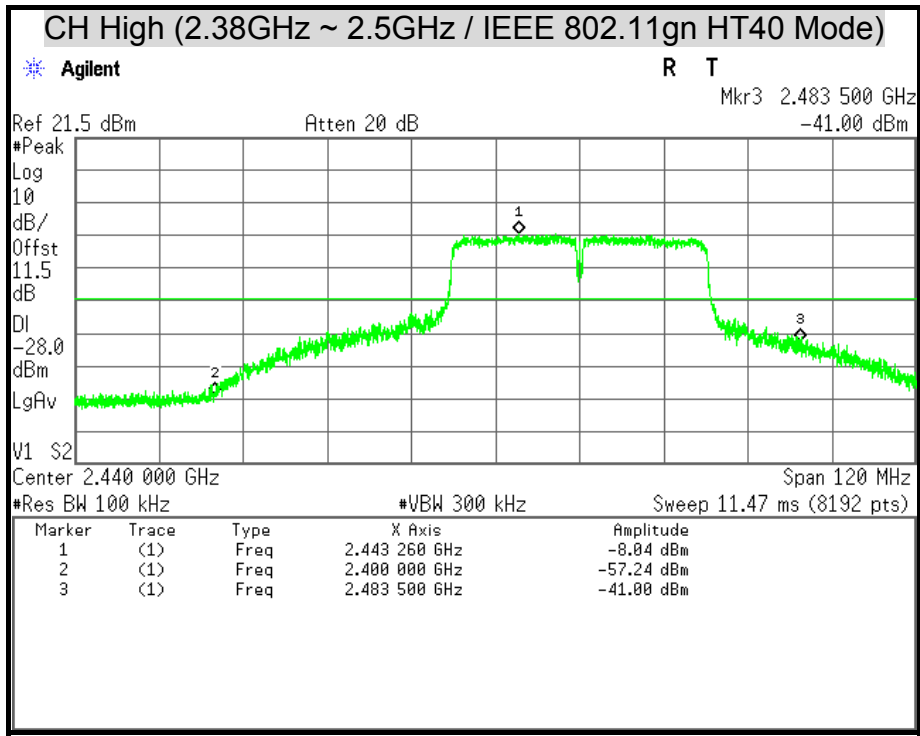



7.6 RADIATED EMISSION

LIMITS

(1) According to § 15.205 (a) Except as shown in paragraph (d) of this section, only spurious emissions are permitted in any of the frequency bands listed below:

MHz	MHz	MHz	GHz
0.090 - 0.110	16.42 - 16.423	399.9 - 410	4.5 - 5.15
¹ 0.495 - 0.505	16.69475 - 16.69525	608 - 614	5.35 - 5.46
2.1735 - 2.1905	16.80425 - 16.80475	960 - 1240	7.25 - 7.75
4.125 - 4.128	25.5 - 25.67	1300 - 1427	8.025 - 8.5
4.17725 - 4.17775	37.5 - 38.25	1435 - 1626.5	9.0 - 9.2
4.20725 - 4.20775	73 - 74.6	1645.5 - 1646.5	9.3 - 9.5
6.215 - 6.218	74.8 - 75.2	1660 -1710	10.6 -12.7
6.26775 - 6.26825	108 -121.94	1718.8 - 1722.2	13.25 -13.4
6.31175 - 6.31225	123 - 138	2200 - 2300	14.47 – 14.5
8.291 - 8.294	149.9 - 150.05	2310 - 2390	15.35 -16.2
8.362 - 8.366	156.52475 - 156.52525	2483.5 - 2500	17.7 - 21.4
8.37625 - 8.38675	156.7 - 156.9	2655 - 2900	22.01 - 23.12
8.41425 - 8.41475	162.0125 - 167.17	3260 - 3267	23.6 - 24.0
12.29 - 12.293	167.72 - 173.2	3332 - 3339	31.2 - 31.8
12.51975 - 12.52025	240 - 285	3345.8 - 3338	36.43 - 36.5
12.57675 - 12.57725	322 -335.4	3600 - 4400	(²)
13.36 - 13.41			

Remark:

- 1. ¹ Until February 1, 1999, this restricted band shall be 0.490-0.510 MHz.
- 2. ² Above 38.6

(2) According to § 15.205 (b) Except as provided in paragraphs (d) and (e), the field strength of emissions appearing within these frequency bands shall not exceed the limits shown in Section 15.209. At frequencies equal to or less than 1000 MHz, compliance with the limits in Section 15.209 shall be demonstrated using measurement instrumentation employing a CISPR quasi-peak detector. Above 1000 MHz, compliance with the emission limits in Section 15.209 shall be demonstrated based on the average value of the measured emissions. The provisions in Section 15.35 apply to these measurements.



(3) According to § 15.209 (a) Except as provided elsewhere in this Subpart, the emissions from an intentional radiator shall not exceed the field strength levels specified in the following table :

Frequency (MHz)	Field Strength (microvolts/meter)	Measurement Distance (meters)
0.009 – 0.490	2400/F(KHz)	300
0.490 – 1.705	24000/F(KHz)	30
1.705 – 30.0	30	30
30 - 88	100 **	3
88 - 216	150 **	3
216 - 960	200 **	3
Above 960	500	3

Remark: **Except as provided in paragraph (g), fundamental emissions from intentional radiators operating under this Section shall not be located in the frequency bands 54-72 MHz, 76-88 MHz, 174-216 MHz or 470-806 MHz. However, operation within these frequency bands is permitted under other sections of this Part, e.g., Sections 15.231 and 15.241.

(4) According to § 15.209 (b) In the emission table above, the tighter limit applies at the band edges.

TEST EQUIPMENT

Radiated Emission / 966Chamber_B

Name of Equipment	Manufacture	Model	Serial Number	Calibration Due
Spectrum Analyzer	Agilent	E4446A	MY46180323	04/15/2015
EMI Test Receiver	ROHDE & SCHWARZ	ESCS 30	835418/008	10/16/2014
Bi-log Antenna	SCHWARZBECK	VULB 9168	9168-250	09/12/2014
Broad-Band Horn Antenna	SCHWARZBECK	BBHA 9120 D	9120D-778	09/12/2014
Double-Ridged Waveguide Horn	ETS-LINDGREN	3117	00078733	12/05/2014
Horn Antenna	COM-POWER	AH-840	03077	12/18/2014
Pre-Amplifier	Agilent	8447D	2944A10052	07/15/2015
Pre-Amplifier	Agilent	8449B	3008A01916	07/15/2015
LOOP Antenna	EMCO	6502	8905-2356	08/20/2014
Notch Filters Band Reject	Micro-Tronics	BRM05702-01	026	N.C.R

Remark: 1. Each piece of equipment is scheduled for calibration once a year.
2. N.C.R = No Calibration Request.



TEST SETUP

The diagram below shows the test setup that is utilized to make the measurements for emission below 1GHz.

9kHz ~ 30MHz

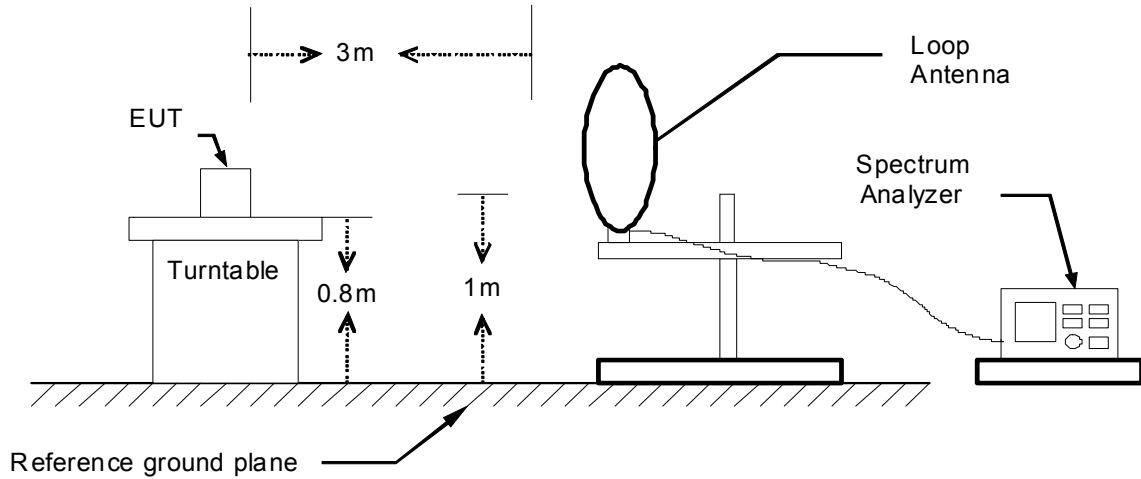

30MHz ~ 1GHz

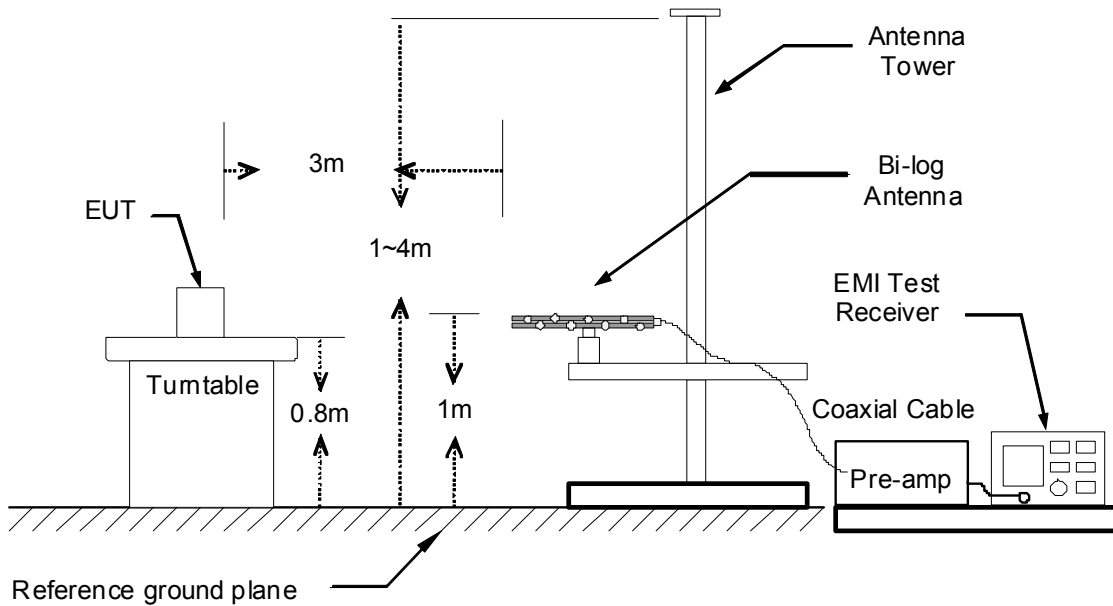



The diagram below shows the test setup that is utilized to make the measurements for emission above 1GHz.

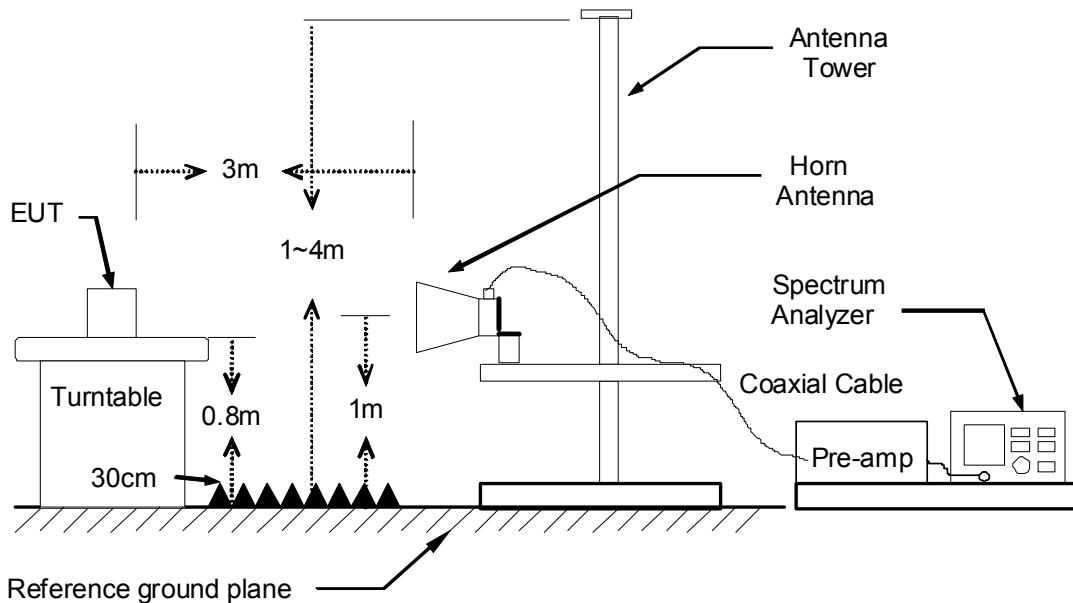

TEST PROCEDURE

1. The EUT was placed on the top of a rotating table 0.8 meters above the ground. The table was rotated 360 degrees to determine the position of the highest radiation.
2. While measuring the radiated emission below 1GHz, the EUT was set 3 meters away from the interference-receiving antenna, which was mounted on the top of a variable-height antenna tower. While measuring the radiated emission above 1GHz, the EUT was set 3 meters away from the interference-receiving antenna.
3. The antenna is a broadband antenna, and its height is varied from one meter to four meters above the ground to determine the maximum value of the field strength. Both horizontal and vertical polarization of the antenna are set to make the measurement.
4. For each suspected emission, the EUT was arranged to its worst case and then the antenna was tuned to heights from 1 meter to 4 meters and the table was turned from 0 degrees to 360 degrees to find the maximum reading.
5. The test-receiver system was set to Peak Detect Function and Specified Bandwidth with Maximum Hold Mode.
6. If the emission level of the EUT in peak mode was 10 dB lower than the limit specified, then testing could be stopped and the peak values of the EUT would be reported. Otherwise the emissions that did not have 10 dB margin would be re-tested one by one using peak, quasi-peak or average method as specified and then reported in a data sheet.

Remark :

1. The resolution bandwidth and video bandwidth of test receiver/spectrum analyzer is 120 KHz for Peak detection (PK) and Quasi-peak detection (QP) at frequency below 1GHz.
2. The resolution bandwidth and video bandwidth of test receiver/spectrum analyzer is 1 MHz for Peak detection and frequency above 1GHz.
3. The resolution bandwidth of test receiver/spectrum analyzer is 1 MHz and the video bandwidth is 10 Hz for Average detection (AV) at frequency above 1GHz.



TEST RESULTS

Below 1 GHz (9kHz ~ 30MHz)

No emission found between lowest internal used/generated frequency to 30MHz.

Below 1 GHz (30MHz ~ 1GHz)

Product Name	HD IP Camera	Test By	Ted Wu
Test Model	IP-2100	Test Date	2014/07/13
Test Mode	Normal Operating	Temp. & Humidity	30°C, 50%

966 Chamber_B at 3Meter / Horizontal						
Frequency (MHz)	Reading (dBµV)	Correction Factor (dB/m)	Result (dBµV/m)	Limit (dBµV/m)	Margin (dB)	Remark
191.02	48.26	-15.44	32.83	43.50	-10.67	Peak
263.77	53.16	-13.16	40.00	46.00	-6.00	Peak
351.07	49.17	-10.87	38.30	46.00	-7.70	Peak
480.08	46.34	-8.46	37.88	46.00	-8.12	Peak
627.52	42.31	-5.80	36.51	46.00	-9.49	Peak
774.96	45.16	-3.33	41.83	46.00	-4.17	Peak
811.82	44.38	-2.86	41.52	46.00	-4.48	Peak

966 Chamber_B at 3Meter / Vertical						
Frequency (MHz)	Reading (dBµV)	Correction Factor (dB/m)	Result (dBµV/m)	Limit (dBµV/m)	Margin (dB)	Remark
40.67	51.92	-14.40	37.53	40.00	-2.47	Peak
54.25	46.20	-13.92	32.28	40.00	-7.72	QP
125.06	51.81	-15.56	36.26	43.50	-7.24	Peak
194.90	54.96	-15.71	39.26	43.50	-4.24	Peak
480.08	47.65	-8.46	39.19	46.00	-6.81	Peak
627.52	45.25	-5.80	39.45	46.00	-6.55	Peak
812.79	45.70	-2.84	42.86	46.00	-3.14	QP

Remark:

1. Quasi-peak test would be performed if the peak result were greater than the quasi-peak limit.
2. Data of measurement within this frequency range shown " --- " in the table above means the reading of emissions are attenuated more than 20dB below the permissible limits or the field strength is too small to be measured.
3. Correction Factor (dB/m) = Antenna Factor (dB/m) + Cable Loss (dB) – PreAmp.Gain (dB)
4. Result (dBµV/m) = Reading (dBµV) + Correction Factor (dB/m)
5. Margin (dB) = Remark result (dBµV/m) - Quasi-peak limit (dBµV/m)



Above 1 GHz

Product Name	HD IP Camera	Test By	Rex Chiu
Test Model	IP-2100	Test Date	2014/07/14
Test Mode	IEEE 802.11b TX / CH Low	Temp. & Humidity	30°C, 52%

966 Chamber_B at 3Meter / Horizontal									
Frequency (MHz)	Reading-PK (dBuV)	Reading-AV (dBuV)	Correction Factor (dB/m)	Result-PK (dBuV/m)	Result-AV (dBuV/m)	Limit-PK (dBuV/m)	Limit-AV (dBuV/m)	Margin (dB)	Remark
1320.00	60.90	47.46	-2.89	58.01	44.57	74.00	54.00	-9.43	AVG
1444.00	52.73	---	-2.90	49.83	---	74.00	54.00	-4.17	Peak
1584.00	52.79	---	-2.11	50.68	---	74.00	54.00	-3.32	Peak
1982.00	48.87	---	1.65	50.52	---	74.00	54.00	-3.48	Peak
4830.00	47.13	43.23	8.09	55.22	51.32	74.00	54.00	-2.68	AVG
6135.00	38.65	---	11.20	49.85	---	74.00	54.00	-4.15	Peak
7230.00	37.85	---	12.84	50.70	---	74.00	54.00	-3.30	Peak

966 Chamber_B at 3Meter / Vertical									
Frequency (MHz)	Reading-PK (dBuV)	Reading-AV (dBuV)	Correction Factor (dB/m)	Result-PK (dBuV/m)	Result-AV (dBuV/m)	Limit-PK (dBuV/m)	Limit-AV (dBuV/m)	Margin (dB)	Remark
1320.00	59.45	46.05	-2.89	56.56	43.16	74.00	54.00	-10.84	AVG
1584.00	49.98	---	-2.11	47.88	---	74.00	54.00	-6.12	Peak
1848.00	48.20	---	0.39	48.58	---	74.00	54.00	-5.42	Peak
4830.00	50.65	44.94	8.09	58.74	53.03	74.00	54.00	-0.97	AVG
6135.00	38.73	---	11.20	49.93	---	74.00	54.00	-4.07	Peak
7230.00	37.70	---	12.84	50.54	---	74.00	54.00	-3.46	Peak

Remark:

1. Measuring frequencies from 1 GHz to the 10th harmonic of highest fundamental frequency.
2. Average test would be performed if the peak result were greater than the average limit.
3. Data of measurement within this frequency range shown " --- " in the table above means the reading of emissions are attenuated more than 20dB below the permissible limits or the field strength is too small to be measured.
4. Measurements above show only up to 6 maximum emissions noted, or would be lesser, with " N/A " remark, if no specific emissions from the EUT are recorded (ie: margin>20dB from the applicable limit) and considered that's already beyond the background noise floor.
5. Result = Reading + Correction Factor
Margin = Result - Limit
Remark Peak = Result(PK) - Limit(AV)
Remark AVG = Result(AV) - Limit(AV)



Product Name	HD IP Camera	Test By	Rex Chiu
Test Model	IP-2100	Test Date	2014/07/14
Test Mode	IEEE 802.11b TX / CH Middle	Temp. & Humidity	30°C, 52%

966 Chamber_B at 3Meter / Horizontal									
Frequency (MHz)	Reading-PK (dBuV)	Reading-AV (dBuV)	Correction Factor (dB/m)	Result-PK (dBuV/m)	Result-AV (dBuV/m)	Limit-PK (dBuV/m)	Limit-AV (dBuV/m)	Margin (dB)	Remark
1320.00	59.12	46.32	-2.89	56.23	43.43	74.00	54.00	-10.57	AVG
1452.00	57.48	50.12	-2.90	54.58	47.22	74.00	54.00	-6.78	AVG
1584.00	56.86	49.23	-2.11	54.75	47.12	74.00	54.00	-6.88	AVG
2046.00	52.68	44.37	1.91	54.59	46.28	74.00	54.00	-7.72	AVG
4875.00	42.72	---	8.18	50.91	---	74.00	54.00	-3.09	Peak
5505.00	39.87	---	9.32	49.19	---	74.00	54.00	-4.81	Peak
6810.00	37.94	---	12.18	50.12	---	74.00	54.00	-3.88	Peak

966 Chamber_B at 3Meter / Vertical									
Frequency (MHz)	Reading-PK (dBuV)	Reading-AV (dBuV)	Correction Factor (dB/m)	Result-PK (dBuV/m)	Result-AV (dBuV/m)	Limit-PK (dBuV/m)	Limit-AV (dBuV/m)	Margin (dB)	Remark
1330.00	57.64	43.32	-2.89	54.75	40.43	74.00	54.00	-13.57	AVG
1584.00	50.20	---	-2.11	48.09	---	74.00	54.00	-5.91	Peak
1784.00	49.13	---	-0.22	48.91	---	74.00	54.00	-5.09	Peak
4875.00	48.31	45.40	8.18	56.49	53.58	74.00	54.00	-0.42	AVG
5685.00	39.50	---	9.86	49.36	---	74.00	54.00	-4.64	Peak
6750.00	38.70	---	12.20	50.90	---	74.00	54.00	-3.10	Peak

Remark:

1. Measuring frequencies from 1 GHz to the 10th harmonic of highest fundamental frequency.
2. Average test would be performed if the peak result were greater than the average limit.
3. Data of measurement within this frequency range shown " --- " in the table above means the reading of emissions are attenuated more than 20dB below the permissible limits or the field strength is too small to be measured.
4. Measurements above show only up to 6 maximum emissions noted, or would be lesser, with " N/A " remark, if no specific emissions from the EUT are recorded (ie: margin>20dB from the applicable limit) and considered that's already beyond the background noise floor.
5. Result = Reading + Correction Factor
Margin = Result - Limit
Remark Peak = Result(PK) - Limit(AV)
Remark AVG = Result(AV) - Limit(AV)



Product Name	HD IP Camera	Test By	Rex Chiu
Test Model	IP-2100	Test Date	2014/07/14
Test Mode	IEEE 802.11b TX / CH High	Temp. & Humidity	30°C, 52%

966 Chamber_B at 3Meter / Horizontal									
Frequency (MHz)	Reading-PK (dBuV)	Reading-AV (dBuV)	Correction Factor (dB/m)	Result-PK (dBuV/m)	Result-AV (dBuV/m)	Limit-PK (dBuV/m)	Limit-AV (dBuV/m)	Margin (dB)	Remark
1316.00	61.51	47.95	-2.89	58.62	45.06	74.00	54.00	-8.94	AVG
1584.00	56.74	49.36	-2.11	54.63	47.25	74.00	54.00	-6.75	AVG
1848.00	50.19	---	0.39	50.57	---	74.00	54.00	-3.43	Peak
4920.00	46.47	42.14	8.28	54.75	50.42	74.00	54.00	-3.58	AVG
5505.00	39.54	---	9.32	48.86	---	74.00	54.00	-5.14	Peak
6330.00	38.41	---	11.77	50.18	---	74.00	54.00	-3.82	Peak

966 Chamber_B at 3Meter / Vertical									
Frequency (MHz)	Reading-PK (dBuV)	Reading-AV (dBuV)	Correction Factor (dB/m)	Result-PK (dBuV/m)	Result-AV (dBuV/m)	Limit-PK (dBuV/m)	Limit-AV (dBuV/m)	Margin (dB)	Remark
1320.00	53.80	41.59	-2.89	50.91	38.70	74.00	54.00	-15.30	AVG
1386.00	52.65	---	-2.90	49.75	---	74.00	54.00	-4.25	Peak
1584.00	50.88	---	-2.11	48.77	---	74.00	54.00	-5.23	Peak
4920.00	48.38	45.14	8.28	56.66	53.42	74.00	54.00	-0.58	AVG
6150.00	39.74	---	11.24	50.98	---	74.00	54.00	-3.02	Peak
7380.00	37.49	---	13.31	50.80	---	74.00	54.00	-3.20	Peak

Remark:

1. Measuring frequencies from 1 GHz to the 10th harmonic of highest fundamental frequency.
2. Average test would be performed if the peak result were greater than the average limit.
3. Data of measurement within this frequency range shown " --- " in the table above means the reading of emissions are attenuated more than 20dB below the permissible limits or the field strength is too small to be measured.
4. Measurements above show only up to 6 maximum emissions noted, or would be lesser, with " N/A " remark, if no specific emissions from the EUT are recorded (ie: margin>20dB from the applicable limit) and considered that's already beyond the background noise floor.
5. Result = Reading + Correction Factor
Margin = Result - Limit
Remark Peak = Result(PK) - Limit(AV)
Remark AVG = Result(AV) - Limit(AV)



Product Name	HD IP Camera	Test By	Rex Chiu
Test Model	IP-2100	Test Date	2014/07/14
Test Mode	IEEE 802.11g TX / CH Low	Temp. & Humidity	30°C, 52%

966 Chamber_B at 3Meter / Horizontal									
Frequency (MHz)	Reading-PK (dBuV)	Reading-AV (dBuV)	Correction Factor (dB/m)	Result-PK (dBuV/m)	Result-AV (dBuV/m)	Limit-PK (dBuV/m)	Limit-AV (dBuV/m)	Margin (dB)	Remark
1320.00	59.56	46.36	-2.89	56.67	43.47	74.00	54.00	-10.53	AVG
1386.00	57.85	50.46	-2.90	54.95	47.56	74.00	54.00	-6.44	AVG
1584.00	57.32	49.86	-2.11	55.21	47.75	74.00	54.00	-6.25	AVG
4830.00	42.79	---	8.09	50.88	---	74.00	54.00	-3.12	Peak
5430.00	40.18	---	9.19	49.37	---	74.00	54.00	-4.63	Peak
6195.00	39.39	---	11.37	50.76	---	74.00	54.00	-3.24	Peak

966 Chamber_B at 3Meter / Vertical									
Frequency (MHz)	Reading-PK (dBuV)	Reading-AV (dBuV)	Correction Factor (dB/m)	Result-PK (dBuV/m)	Result-AV (dBuV/m)	Limit-PK (dBuV/m)	Limit-AV (dBuV/m)	Margin (dB)	Remark
1320.00	57.34	42.76	-2.89	54.45	39.87	74.00	54.00	-14.13	AVG
1584.00	49.03	---	-2.11	46.93	---	74.00	54.00	-7.07	Peak
1858.00	49.31	---	0.48	49.79	---	74.00	54.00	-4.21	Peak
4830.00	44.95	30.92	8.09	53.04	39.01	74.00	54.00	-14.99	AVG
6105.00	38.79	---	11.11	49.90	---	74.00	54.00	-4.10	Peak
7230.00	38.24	---	12.84	51.09	---	74.00	54.00	-2.91	Peak

Remark:

1. Measuring frequencies from 1 GHz to the 10th harmonic of highest fundamental frequency.
2. Average test would be performed if the peak result were greater than the average limit.
3. Data of measurement within this frequency range shown " --- " in the table above means the reading of emissions are attenuated more than 20dB below the permissible limits or the field strength is too small to be measured.
4. Measurements above show only up to 6 maximum emissions noted, or would be lesser, with " N/A " remark, if no specific emissions from the EUT are recorded (ie: margin>20dB from the applicable limit) and considered that's already beyond the background noise floor.
5. Result = Reading + Correction Factor
Margin = Result - Limit
Remark Peak = Result(PK) - Limit(AV)
Remark AVG = Result(AV) - Limit(AV)



Product Name	HD IP Camera	Test By	Rex Chiu
Test Model	IP-2100	Test Date	2014/07/15
Test Mode	IEEE 802.11g TX / CH Middle	Temp. & Humidity	30°C, 52%

966 Chamber_B at 3Meter / Horizontal									
Frequency (MHz)	Reading-PK (dBuV)	Reading-AV (dBuV)	Correction Factor (dB/m)	Result-PK (dBuV/m)	Result-AV (dBuV/m)	Limit-PK (dBuV/m)	Limit-AV (dBuV/m)	Margin (dB)	Remark
1320.00	60.64	45.37	-2.89	57.75	42.48	74.00	54.00	-11.52	AVG
2390.00	46.35	---	2.59	48.94	---	74.00	54.00	-5.06	Peak
2484.00	46.73	---	2.78	49.50	---	74.00	54.00	-4.50	Peak
4875.00	48.06	34.65	8.18	56.24	42.83	74.00	54.00	-11.17	AVG
5805.00	38.50	---	10.22	48.72	---	74.00	54.00	-5.28	Peak
6675.00	38.42	---	12.22	50.65	---	74.00	54.00	-3.35	Peak

966 Chamber_B at 3Meter / Vertical									
Frequency (MHz)	Reading-PK (dBuV)	Reading-AV (dBuV)	Correction Factor (dB/m)	Result-PK (dBuV/m)	Result-AV (dBuV/m)	Limit-PK (dBuV/m)	Limit-AV (dBuV/m)	Margin (dB)	Remark
1320.00	56.88	41.73	-2.89	53.99	38.84	74.00	54.00	-15.16	AVG
1848.00	50.54	---	0.39	50.92	---	74.00	54.00	-3.08	Peak
1980.00	49.05	---	1.63	50.68	---	74.00	54.00	-3.32	Peak
2390.00	52.87	39.83	2.59	55.46	42.42	74.00	54.00	-11.58	AVG
2482.00	53.49	39.01	2.77	56.26	41.78	74.00	54.00	-12.22	AVG
4875.00	49.81	36.21	8.18	57.99	44.39	74.00	54.00	-9.61	AVG
5850.00	38.61	---	10.35	48.96	---	74.00	54.00	-5.04	Peak
6345.00	38.86	---	11.81	50.67	---	74.00	54.00	-3.33	Peak

Remark:

1. Measuring frequencies from 1 GHz to the 10th harmonic of highest fundamental frequency.
2. Average test would be performed if the peak result were greater than the average limit.
3. Data of measurement within this frequency range shown " --- " in the table above means the reading of emissions are attenuated more than 20dB below the permissible limits or the field strength is too small to be measured.
4. Measurements above show only up to 6 maximum emissions noted, or would be lesser, with " N/A " remark, if no specific emissions from the EUT are recorded (ie: margin>20dB from the applicable limit) and considered that's already beyond the background noise floor.
5. Result = Reading + Correction Factor
Margin = Result - Limit
Remark Peak = Result(PK) - Limit(AV)
Remark AVG = Result(AV) - Limit(AV)



Product Name	HD IP Camera	Test By	Rex Chiu
Test Model	IP-2100	Test Date	2014/07/15
Test Mode	IEEE 802.11g TX / CH High	Temp. & Humidity	30°C, 52%

966 Chamber_B at 3Meter / Horizontal									
Frequency (MHz)	Reading-PK (dBuV)	Reading-AV (dBuV)	Correction Factor (dB/m)	Result-PK (dBuV/m)	Result-AV (dBuV/m)	Limit-PK (dBuV/m)	Limit-AV (dBuV/m)	Margin (dB)	Remark
1320.00	60.65	45.85	-2.89	57.76	42.96	74.00	54.00	-11.04	AVG
1452.00	52.82	---	-2.90	49.93	---	74.00	54.00	-4.07	Peak
2048.00	51.45	43.92	1.92	53.37	45.84	74.00	54.00	-8.16	Peak
4920.00	47.88	34.47	8.28	56.16	42.75	74.00	54.00	-11.25	AVG
5565.00	39.29	---	9.50	48.79	---	74.00	54.00	-5.21	Peak
6345.00	38.83	---	11.81	50.64	---	74.00	54.00	-3.36	Peak

966 Chamber_B at 3Meter / Vertical									
Frequency (MHz)	Reading-PK (dBuV)	Reading-AV (dBuV)	Correction Factor (dB/m)	Result-PK (dBuV/m)	Result-AV (dBuV/m)	Limit-PK (dBuV/m)	Limit-AV (dBuV/m)	Margin (dB)	Remark
1320.00	58.49	43.21	-2.89	55.60	40.32	74.00	54.00	-13.68	AVG
1848.00	54.28	47.02	0.39	54.67	47.41	74.00	54.00	-6.59	AVG
1980.00	46.33	---	1.63	47.96	---	74.00	54.00	-6.04	Peak
4920.00	51.67	38.39	8.28	59.95	46.67	74.00	54.00	-7.33	AVG
5745.00	38.82	---	10.04	48.86	---	74.00	54.00	-5.14	Peak
6795.00	38.65	---	12.19	50.84	---	74.00	54.00	-3.16	Peak

Remark:

1. Measuring frequencies from 1 GHz to the 10th harmonic of highest fundamental frequency.
2. Average test would be performed if the peak result were greater than the average limit.
3. Data of measurement within this frequency range shown " --- " in the table above means the reading of emissions are attenuated more than 20dB below the permissible limits or the field strength is too small to be measured.
4. Measurements above show only up to 6 maximum emissions noted, or would be lesser, with " N/A " remark, if no specific emissions from the EUT are recorded (ie: margin>20dB from the applicable limit) and considered that's already beyond the background noise floor.
5. Result = Reading + Correction Factor
Margin = Result - Limit
Remark Peak = Result(PK) - Limit(AV)
Remark AVG = Result(AV) - Limit(AV)



Product Name	HD IP Camera	Test By	Rex Chiu
Test Model	IP-2100	Test Date	2014/07/15
Test Mode	IEEE 802.11gn HT20 TX / CH Low	Temp. & Humidity	30°C, 52%

966 Chamber_B at 3Meter / Horizontal									
Frequency (MHz)	Reading-PK (dBuV)	Reading-AV (dBuV)	Correction Factor (dB/m)	Result-PK (dBuV/m)	Result-AV (dBuV/m)	Limit-PK (dBuV/m)	Limit-AV (dBuV/m)	Margin (dB)	Remark
1320.00	59.40	44.70	-2.89	56.51	41.81	74.00	54.00	-12.19	AVG
1584.00	56.76	47.56	-2.11	54.65	45.45	74.00	54.00	-8.55	AVG
1980.00	53.36	46.27	1.63	54.99	47.90	74.00	54.00	-6.10	AVG
4830.00	42.27	---	8.09	50.36	---	74.00	54.00	-3.64	Peak
6450.00	38.84	---	12.12	50.96	---	74.00	54.00	-3.04	Peak
7230.00	38.11	---	12.84	50.95	---	74.00	54.00	-3.05	Peak

966 Chamber_B at 3Meter / Vertical									
Frequency (MHz)	Reading-PK (dBuV)	Reading-AV (dBuV)	Correction Factor (dB/m)	Result-PK (dBuV/m)	Result-AV (dBuV/m)	Limit-PK (dBuV/m)	Limit-AV (dBuV/m)	Margin (dB)	Remark
1320.00	57.46	44.15	-2.89	54.57	41.26	74.00	54.00	-12.74	AVG
1784.00	49.42	---	-0.22	49.20	---	74.00	54.00	-4.80	Peak
2046.00	47.51	---	1.91	49.42	---	74.00	54.00	-4.58	Peak
2492.00	48.16	35.38	2.79	50.95	38.17	74.00	54.00	-15.83	AVG
4005.00	41.46	---	5.88	47.34	---	74.00	54.00	-6.66	Peak
4830.00	42.08	---	8.09	50.17	---	74.00	54.00	-3.83	Peak
5685.00	39.81	---	9.86	49.67	---	74.00	54.00	-4.33	Peak

Remark:

1. Measuring frequencies from 1 GHz to the 10th harmonic of highest fundamental frequency.
2. Average test would be performed if the peak result were greater than the average limit.
3. Data of measurement within this frequency range shown " --- " in the table above means the reading of emissions are attenuated more than 20dB below the permissible limits or the field strength is too small to be measured.
4. Measurements above show only up to 6 maximum emissions noted, or would be lesser, with " N/A " remark, if no specific emissions from the EUT are recorded (ie: margin>20dB from the applicable limit) and considered that's already beyond the background noise floor.
5. Result = Reading + Correction Factor
Margin = Result - Limit
Remark Peak = Result(PK) - Limit(AV)
Remark AVG = Result(AV) - Limit(AV)



Product Name	HD IP Camera	Test By	Rex Chiu
Test Model	IP-2100	Test Date	2014/07/15
Test Mode	IEEE 802.11gn HT20 TX / CH Middle	Temp. & Humidity	30°C, 52%

966 Chamber_B at 3Meter / Horizontal									
Frequency (MHz)	Reading-PK (dBuV)	Reading-AV (dBuV)	Correction Factor (dB/m)	Result-PK (dBuV/m)	Result-AV (dBuV/m)	Limit-PK (dBuV/m)	Limit-AV (dBuV/m)	Margin (dB)	Remark
1320.00	60.03	46.76	-2.89	57.14	43.87	74.00	54.00	-10.13	AVG
1584.00	56.58	47.34	-2.11	54.47	45.23	74.00	54.00	-8.77	AVG
1980.00	53.72	46.56	1.63	55.35	48.19	74.00	54.00	-5.81	AVG
4875.00	48.65	33.97	8.18	56.83	42.15	74.00	54.00	-11.85	AVG
6030.00	39.24	---	10.89	50.13	---	74.00	54.00	-3.87	Peak
7305.00	37.86	---	13.08	50.94	---	74.00	54.00	-3.06	Peak

966 Chamber_B at 3Meter / Vertical									
Frequency (MHz)	Reading-PK (dBuV)	Reading-AV (dBuV)	Correction Factor (dB/m)	Result-PK (dBuV/m)	Result-AV (dBuV/m)	Limit-PK (dBuV/m)	Limit-AV (dBuV/m)	Margin (dB)	Remark
1330.00	58.59	44.26	-2.89	55.70	41.37	74.00	54.00	-12.63	AVG
2390.00	54.53	38.36	2.59	57.12	40.95	74.00	54.00	-13.05	AVG
2484.00	52.86	38.70	2.78	55.64	41.48	74.00	54.00	-12.52	AVG
4875.00	49.61	35.45	8.18	57.79	43.63	74.00	54.00	-10.37	AVG
5685.00	40.09	---	9.86	49.95	---	74.00	54.00	-4.05	Peak
7320.00	37.49	---	13.12	50.61	---	74.00	54.00	-3.39	Peak

Remark:

1. Measuring frequencies from 1 GHz to the 10th harmonic of highest fundamental frequency.
2. Average test would be performed if the peak result were greater than the average limit.
3. Data of measurement within this frequency range shown " --- " in the table above means the reading of emissions are attenuated more than 20dB below the permissible limits or the field strength is too small to be measured.
4. Measurements above show only up to 6 maximum emissions noted, or would be lesser, with " N/A " remark, if no specific emissions from the EUT are recorded (ie: margin>20dB from the applicable limit) and considered that's already beyond the background noise floor.
5. Result = Reading + Correction Factor
 Margin = Result - Limit
 Remark Peak = Result(PK) - Limit(AV)
 Remark AVG = Result(AV) - Limit(AV)



Product Name	HD IP Camera	Test By	Rex Chiu
Test Model	IP-2100	Test Date	2014/07/15
Test Mode	IEEE 802.11gn HT20 TX / CH High	Temp. & Humidity	30°C, 52%

966 Chamber_B at 3Meter / Horizontal									
Frequency (MHz)	Reading-PK (dBuV)	Reading-AV (dBuV)	Correction Factor (dB/m)	Result-PK (dBuV/m)	Result-AV (dBuV/m)	Limit-PK (dBuV/m)	Limit-AV (dBuV/m)	Margin (dB)	Remark
1320.00	59.84	44.76	-2.89	56.95	41.87	74.00	54.00	-12.13	AVG
1584.00	52.96	---	-2.11	50.85	---	74.00	54.00	-3.15	Peak
1980.00	51.99	44.83	1.63	53.62	46.46	74.00	54.00	-7.54	AVG
4935.00	42.66	---	8.31	50.97	---	74.00	54.00	-3.03	Peak
6135.00	39.40	---	11.20	50.60	---	74.00	54.00	-3.40	Peak
7380.00	37.51	---	13.31	50.82	---	74.00	54.00	-3.18	Peak

966 Chamber_B at 3Meter / Vertical									
Frequency (MHz)	Reading-PK (dBuV)	Reading-AV (dBuV)	Correction Factor (dB/m)	Result-PK (dBuV/m)	Result-AV (dBuV/m)	Limit-PK (dBuV/m)	Limit-AV (dBuV/m)	Margin (dB)	Remark
1320.00	58.33	44.62	-2.89	55.44	41.73	74.00	54.00	-12.27	AVG
1914.00	48.08	---	1.01	49.08	---	74.00	54.00	-4.92	Peak
2046.00	46.23	---	1.91	48.14	---	74.00	54.00	-5.86	Peak
4920.00	49.64	35.43	8.28	57.92	43.71	74.00	54.00	-10.29	AVG
5670.00	39.31	---	9.82	49.13	---	74.00	54.00	-4.87	Peak
6540.00	38.18	---	12.26	50.44	---	74.00	54.00	-3.56	Peak

Remark:

1. Measuring frequencies from 1 GHz to the 10th harmonic of highest fundamental frequency.
2. Average test would be performed if the peak result were greater than the average limit.
3. Data of measurement within this frequency range shown " --- " in the table above means the reading of emissions are attenuated more than 20dB below the permissible limits or the field strength is too small to be measured.
4. Measurements above show only up to 6 maximum emissions noted, or would be lesser, with " N/A " remark, if no specific emissions from the EUT are recorded (ie: margin>20dB from the applicable limit) and considered that's already beyond the background noise floor.
5. Result = Reading + Correction Factor
 Margin = Result - Limit
 Remark Peak = Result(PK) - Limit(AV)
 Remark AVG = Result(AV) - Limit(AV)



Product Name	HD IP Camera	Test By	Rex Chiu
Test Model	IP-2100	Test Date	2014/07/15
Test Mode	IEEE 802.11gn HT40 TX / CH Low	Temp. & Humidity	30°C, 52%

966 Chamber_B at 3Meter / Horizontal									
Frequency (MHz)	Reading-PK (dBuV)	Reading-AV (dBuV)	Correction Factor (dB/m)	Result-PK (dBuV/m)	Result-AV (dBuV/m)	Limit-PK (dBuV/m)	Limit-AV (dBuV/m)	Margin (dB)	Remark
1320.00	60.32	46.30	-2.89	57.43	43.41	74.00	54.00	-10.59	AVG
1980.00	49.45	---	1.63	51.08	---	74.00	54.00	-2.92	Peak
2046.00	48.91	---	1.91	50.82	---	74.00	54.00	-3.18	Peak
4845.00	40.32	---	8.12	48.45	---	74.00	54.00	-5.55	Peak
5490.00	39.13	---	9.29	48.42	---	74.00	54.00	-5.58	Peak
6360.00	38.89	---	11.86	50.75	---	74.00	54.00	-3.25	Peak

966 Chamber_B at 3Meter / Vertical									
Frequency (MHz)	Reading-PK (dBuV)	Reading-AV (dBuV)	Correction Factor (dB/m)	Result-PK (dBuV/m)	Result-AV (dBuV/m)	Limit-PK (dBuV/m)	Limit-AV (dBuV/m)	Margin (dB)	Remark
1320.00	57.30	43.60	-2.89	54.41	40.71	74.00	54.00	-13.29	AVG
1782.00	51.04	---	-0.24	50.80	---	74.00	54.00	-3.20	Peak
1848.00	48.45	---	0.39	48.83	---	74.00	54.00	-5.17	Peak
3705.00	42.17	---	5.05	47.22	---	74.00	54.00	-6.78	Peak
4845.00	39.67	---	8.12	47.79	---	74.00	54.00	-6.21	Peak
5655.00	39.48	---	9.77	49.25	---	74.00	54.00	-4.75	Peak

Remark:

1. Measuring frequencies from 1 GHz to the 10th harmonic of highest fundamental frequency.
2. Average test would be performed if the peak result were greater than the average limit.
3. Data of measurement within this frequency range shown " --- " in the table above means the reading of emissions are attenuated more than 20dB below the permissible limits or the field strength is too small to be measured.
4. Measurements above show only up to 6 maximum emissions noted, or would be lesser, with " N/A " remark, if no specific emissions from the EUT are recorded (ie: margin>20dB from the applicable limit) and considered that's already beyond the background noise floor.
5. Result = Reading + Correction Factor
 Margin = Result - Limit
 Remark Peak = Result(PK) - Limit(AV)
 Remark AVG = Result(AV) - Limit(AV)



Product Name	HD IP Camera	Test By	Rex Chiu
Test Model	IP-2100	Test Date	2014/07/15
Test Mode	IEEE 802.11gn HT40 TX / CH Middle	Temp. & Humidity	30°C, 52%

966 Chamber_B at 3Meter / Horizontal									
Frequency (MHz)	Reading-PK (dBuV)	Reading-AV (dBuV)	Correction Factor (dB/m)	Result-PK (dBuV/m)	Result-AV (dBuV/m)	Limit-PK (dBuV/m)	Limit-AV (dBuV/m)	Margin (dB)	Remark
1320.00	60.49	46.50	-2.89	57.60	43.61	74.00	54.00	-10.39	AVG
2390.00	58.50	43.60	2.59	61.09	46.19	74.00	54.00	-7.81	AVG
2484.00	56.87	42.30	2.78	59.65	45.08	74.00	54.00	-8.92	AVG
4875.00	41.36	---	8.18	49.54	---	74.00	54.00	-4.46	Peak
5595.00	39.17	---	9.59	48.77	---	74.00	54.00	-5.23	Peak
7320.00	37.59	---	13.12	50.71	---	74.00	54.00	-3.29	Peak

966 Chamber_B at 3Meter / Vertical									
Frequency (MHz)	Reading-PK (dBuV)	Reading-AV (dBuV)	Correction Factor (dB/m)	Result-PK (dBuV/m)	Result-AV (dBuV/m)	Limit-PK (dBuV/m)	Limit-AV (dBuV/m)	Margin (dB)	Remark
1320.00	57.59	43.50	-2.89	54.70	40.61	74.00	54.00	-13.39	AVG
2390.00	66.34	49.65	2.59	68.93	52.24	74.00	54.00	-1.76	AVG
2484.00	64.01	48.08	2.78	66.79	50.86	74.00	54.00	-3.14	AVG
4875.00	42.38	---	8.18	50.57	---	74.00	54.00	-3.43	Peak
5610.00	40.18	---	9.64	49.81	---	74.00	54.00	-4.19	Peak
6030.00	38.75	---	10.89	49.64	---	74.00	54.00	-4.36	Peak

Remark:

1. Measuring frequencies from 1 GHz to the 10th harmonic of highest fundamental frequency.
2. Average test would be performed if the peak result were greater than the average limit.
3. Data of measurement within this frequency range shown " --- " in the table above means the reading of emissions are attenuated more than 20dB below the permissible limits or the field strength is too small to be measured.
4. Measurements above show only up to 6 maximum emissions noted, or would be lesser, with " N/A " remark, if no specific emissions from the EUT are recorded (ie: margin>20dB from the applicable limit) and considered that's already beyond the background noise floor.
5. Result = Reading + Correction Factor
 Margin = Result - Limit
 Remark Peak = Result(PK) - Limit(AV)
 Remark AVG = Result(AV) - Limit(AV)



Product Name	HD IP Camera	Test By	Rex Chiu
Test Model	IP-2100	Test Date	2014/07/15
Test Mode	IEEE 802.11gn HT40 TX / CH High	Temp. & Humidity	30°C, 52%

966 Chamber_B at 3Meter / Horizontal									
Frequency (MHz)	Reading-PK (dBuV)	Reading-AV (dBuV)	Correction Factor (dB/m)	Result-PK (dBuV/m)	Result-AV (dBuV/m)	Limit-PK (dBuV/m)	Limit-AV (dBuV/m)	Margin (dB)	Remark
1320.00	61.16	47.30	-2.89	58.27	44.41	74.00	54.00	-9.59	AVG
1584.00	55.20	48.10	-2.11	53.09	45.99	74.00	54.00	-8.01	AVG
2046.00	47.87	---	1.91	49.78	---	74.00	54.00	-4.22	Peak
4905.00	40.69	---	8.24	48.93	---	74.00	54.00	-5.07	Peak
5460.00	39.90	---	9.24	49.14	---	74.00	54.00	-4.86	Peak
6690.00	38.04	---	12.22	50.25	---	74.00	54.00	-3.75	Peak

966 Chamber_B at 3Meter / Vertical									
Frequency (MHz)	Reading-PK (dBuV)	Reading-AV (dBuV)	Correction Factor (dB/m)	Result-PK (dBuV/m)	Result-AV (dBuV/m)	Limit-PK (dBuV/m)	Limit-AV (dBuV/m)	Margin (dB)	Remark
1320.00	57.82	43.60	-2.89	54.93	40.71	74.00	54.00	-13.29	AVG
1856.00	48.78	---	0.46	49.24	---	74.00	54.00	-4.76	Peak
1914.00	47.04	---	1.01	48.05	---	74.00	54.00	-5.95	Peak
4920.00	40.71	---	8.28	48.99	---	74.00	54.00	-5.01	Peak
5970.00	38.81	---	10.71	49.52	---	74.00	54.00	-4.48	Peak
7350.00	37.72	---	13.22	50.94	---	74.00	54.00	-3.06	Peak

Remark:

1. Measuring frequencies from 1 GHz to the 10th harmonic of highest fundamental frequency.
2. Average test would be performed if the peak result were greater than the average limit.
3. Data of measurement within this frequency range shown " --- " in the table above means the reading of emissions are attenuated more than 20dB below the permissible limits or the field strength is too small to be measured.
4. Measurements above show only up to 6 maximum emissions noted, or would be lesser, with " N/A " remark, if no specific emissions from the EUT are recorded (ie: margin>20dB from the applicable limit) and considered that's already beyond the background noise floor.
5. Result = Reading + Correction Factor
 Margin = Result - Limit
 Remark Peak = Result(PK) - Limit(AV)
 Remark AVG = Result(AV) - Limit(AV)



Restricted Band Edges

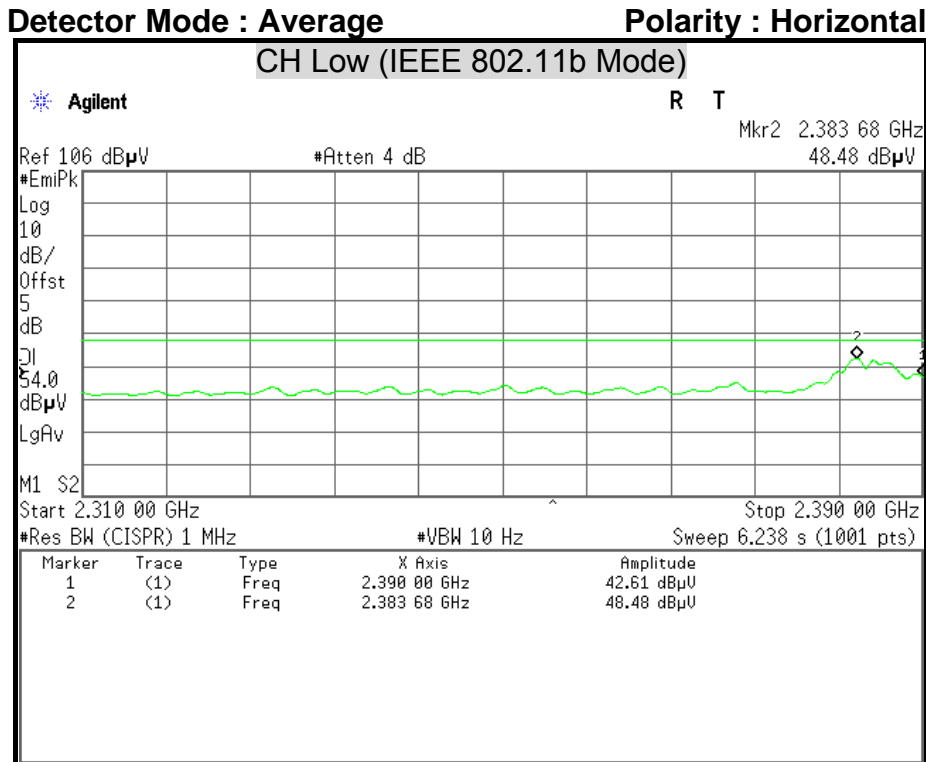
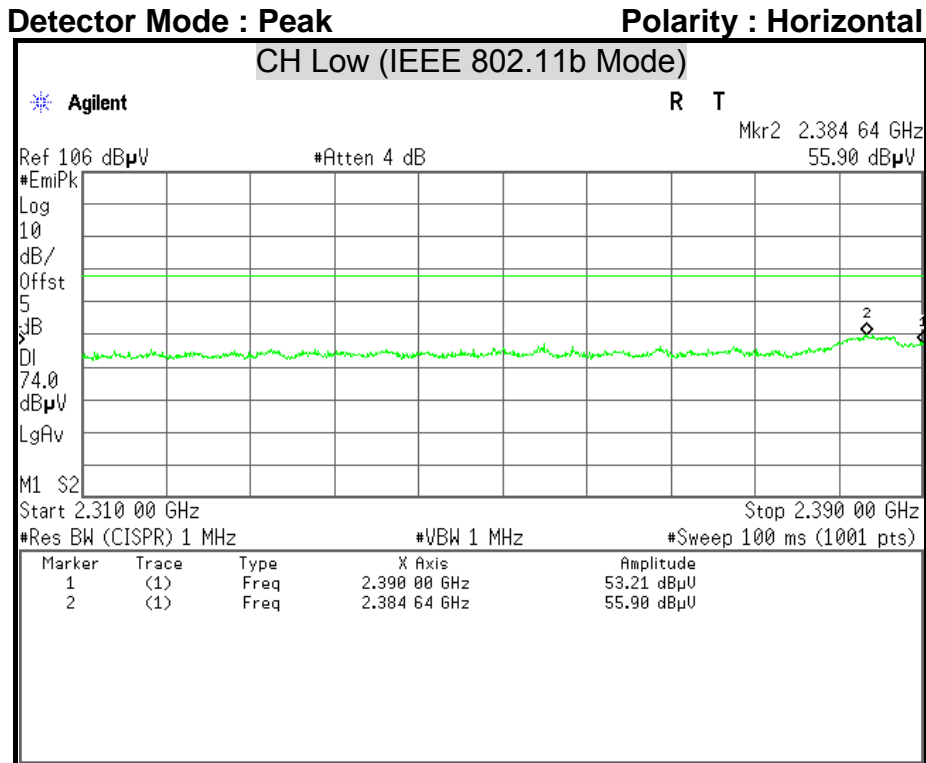



Detector Mode : Peak

Polarity : Vertical

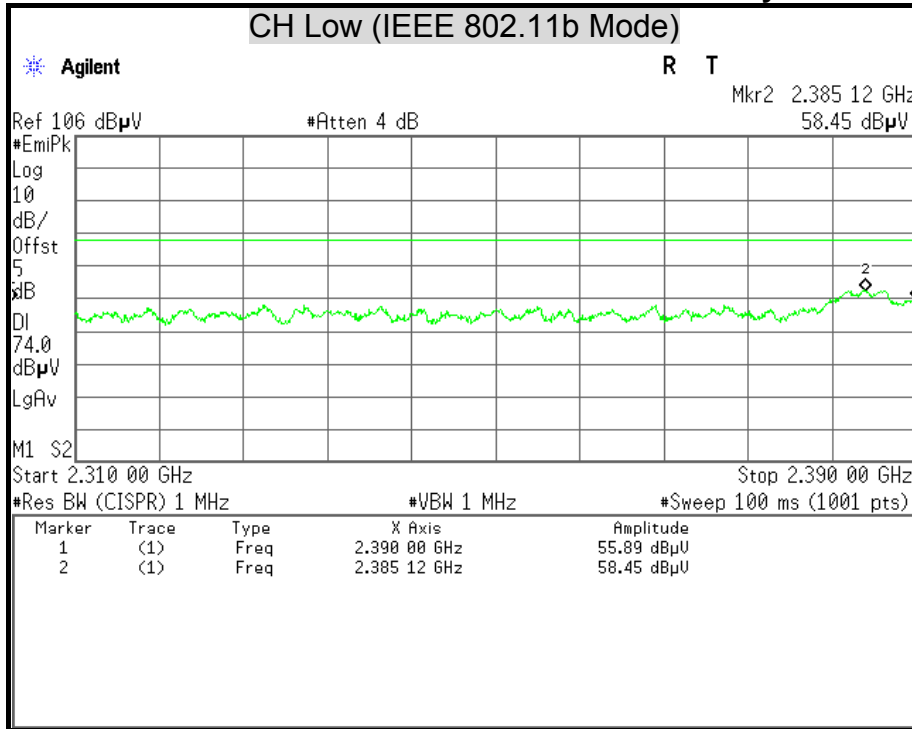

Detector Mode : Average

Polarity : Vertical

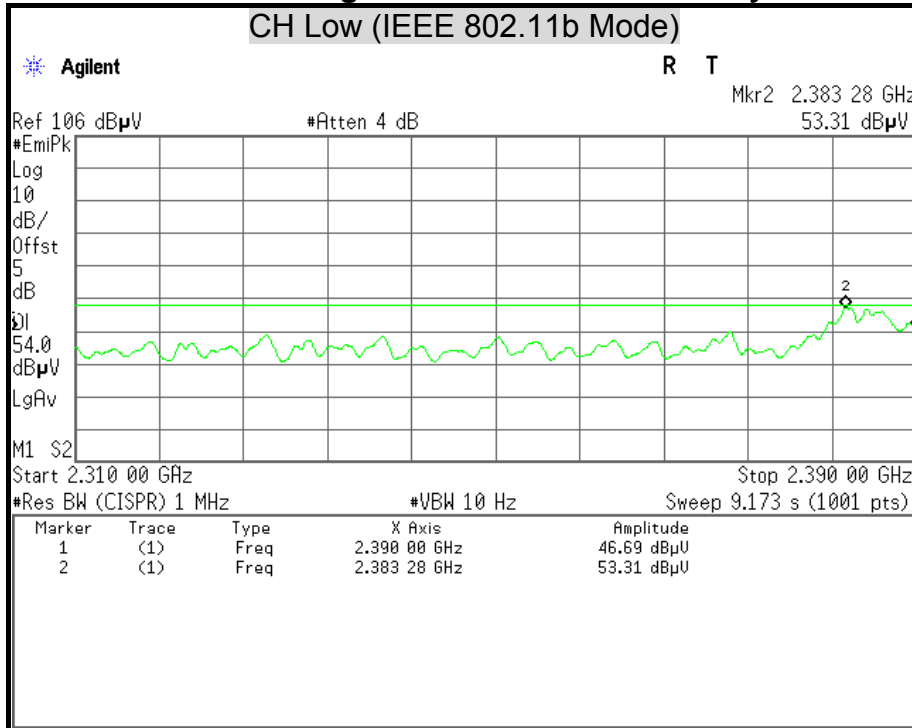



Detector Mode : Peak

Polarity : Horizontal

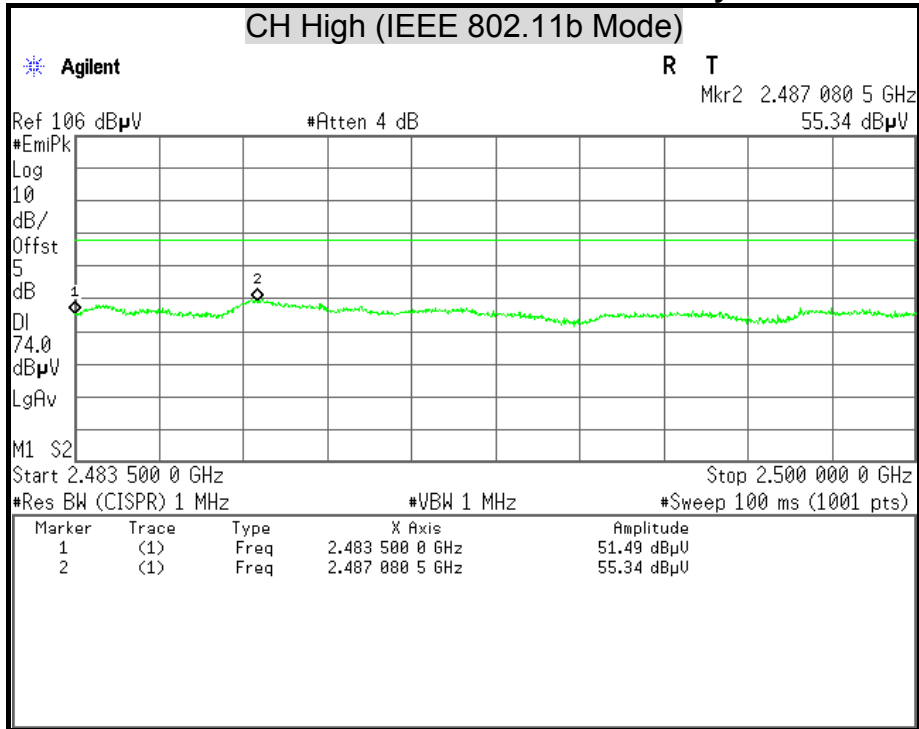

Detector Mode : Average

Polarity : Horizontal

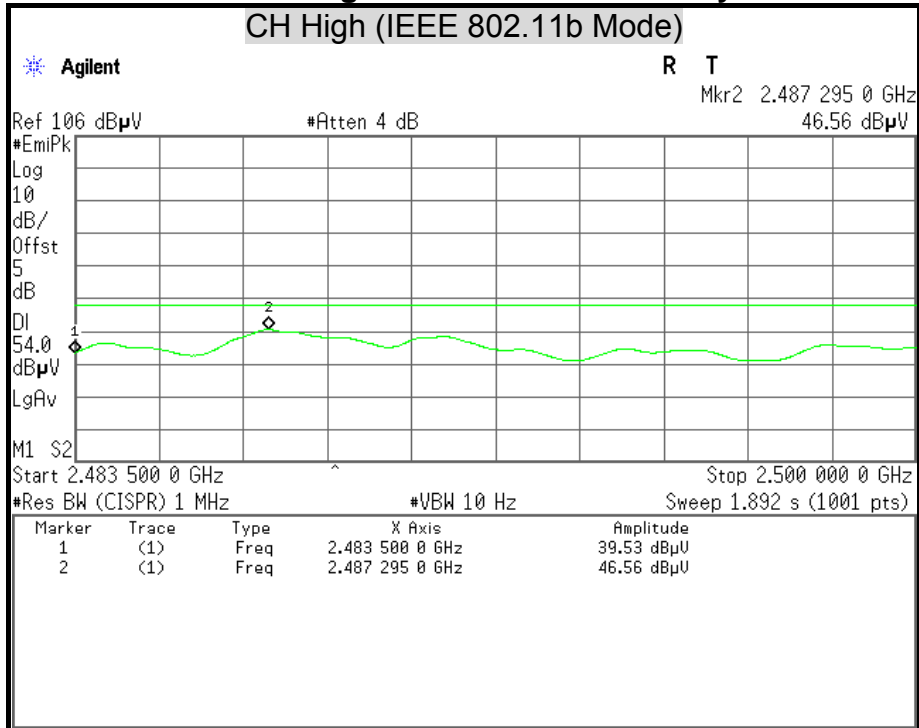



Detector Mode : Peak

Polarity : Vertical

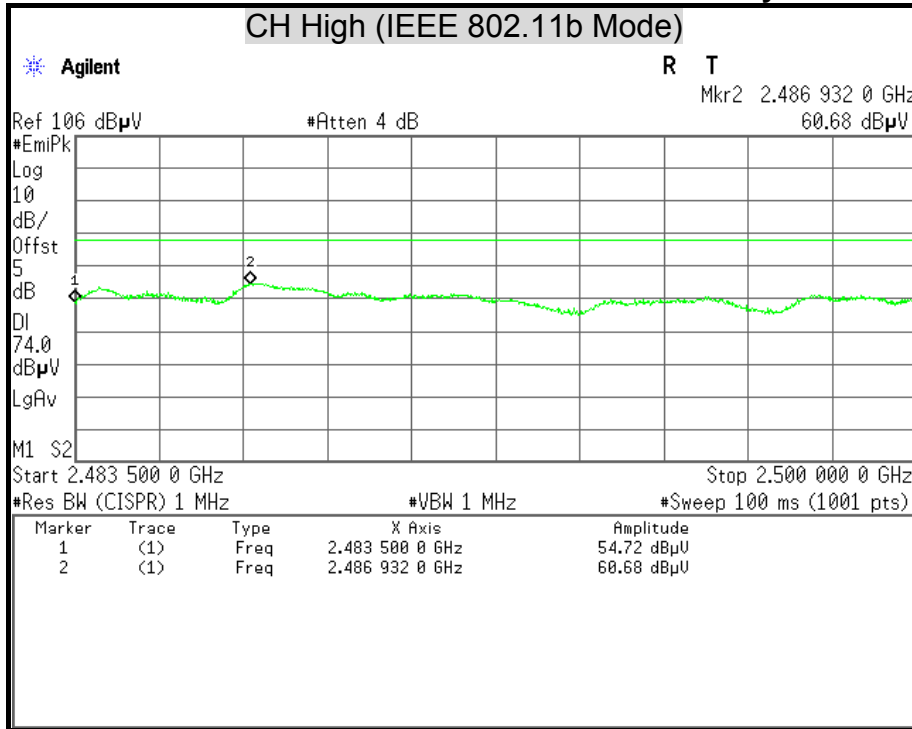

Detector Mode : Average

Polarity : Vertical

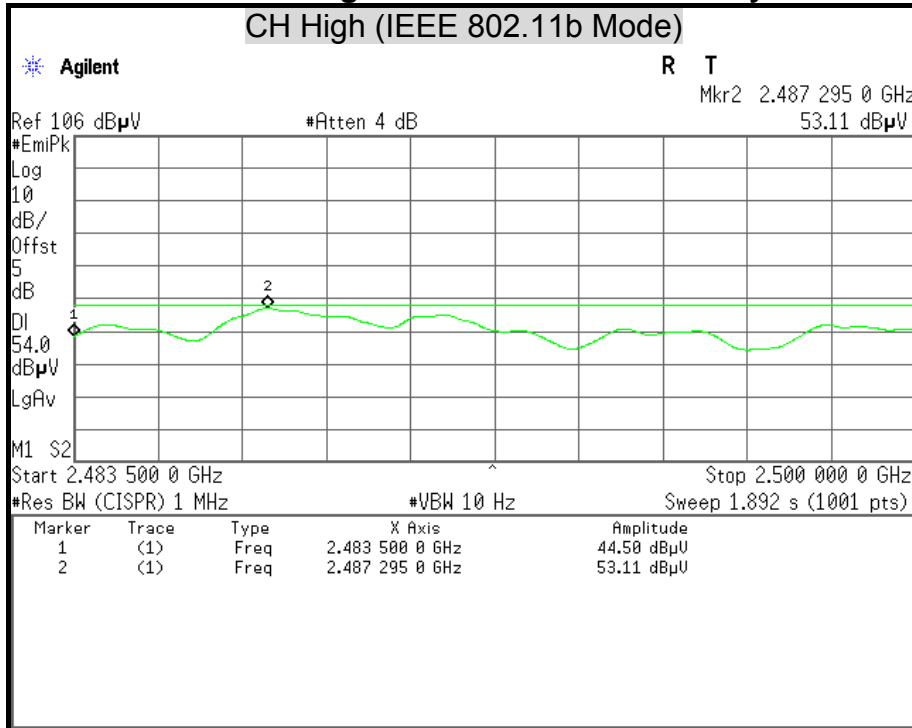



Detector Mode : Peak

Polarity : Horizontal

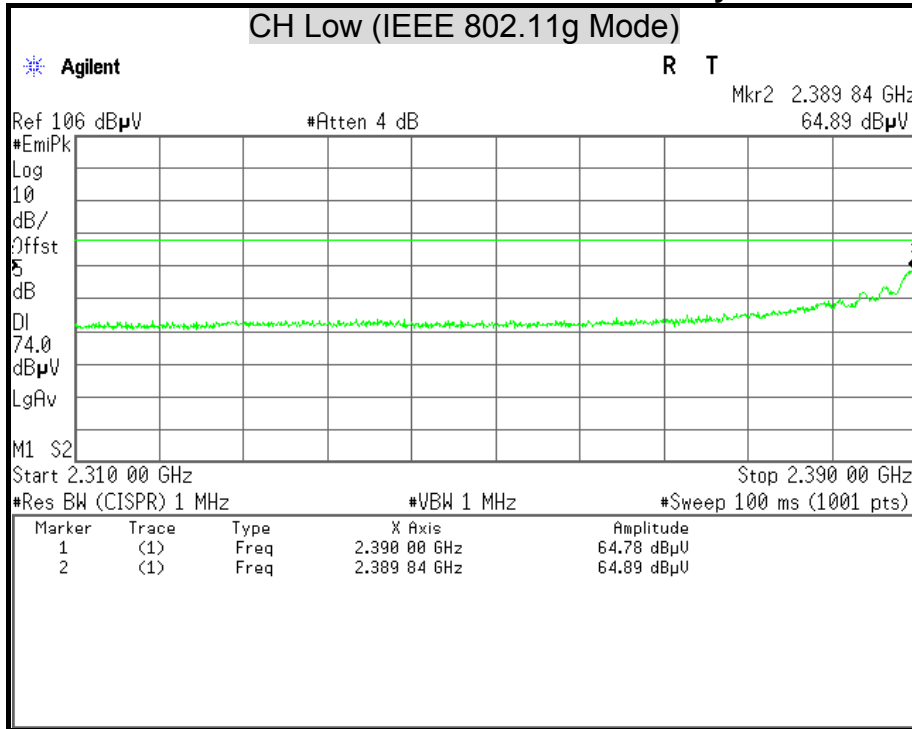

Detector Mode : Average

Polarity : Horizontal

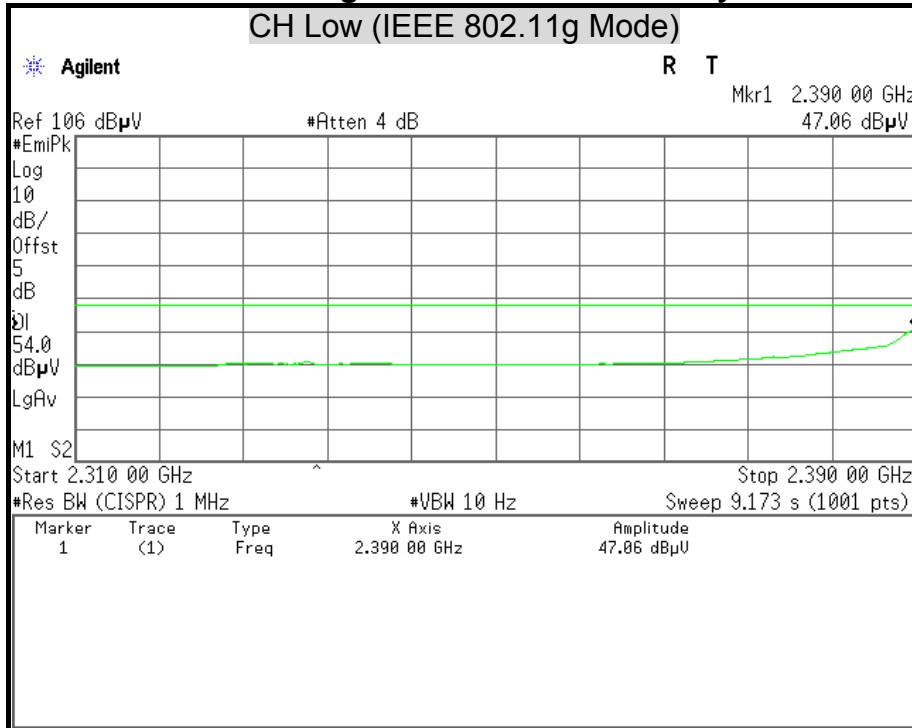



Detector Mode : Peak

Polarity : Vertical

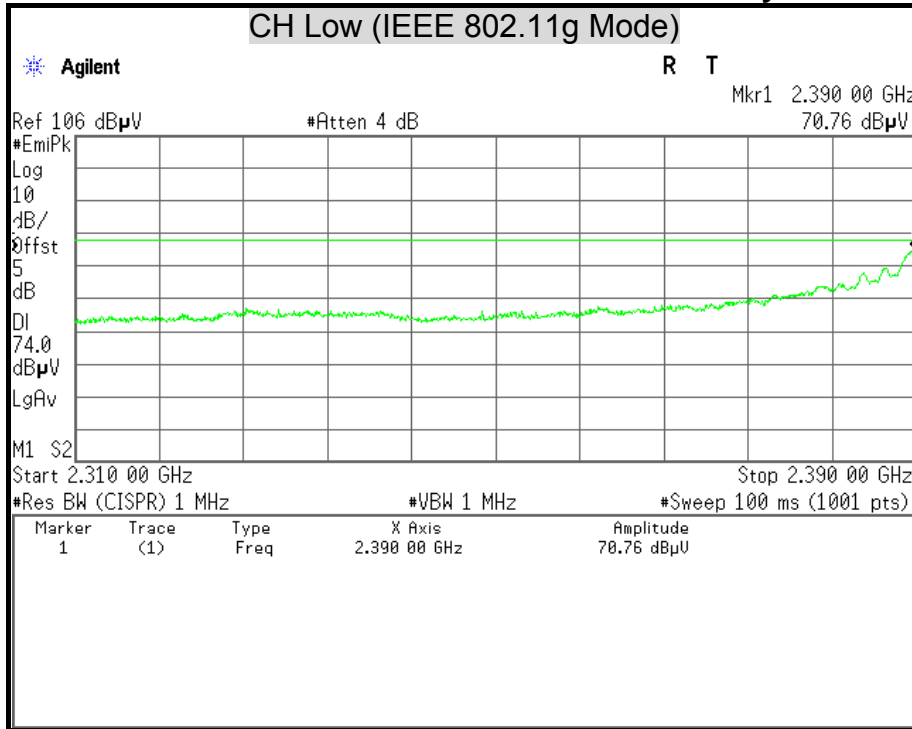

Detector Mode : Average

Polarity : Vertical

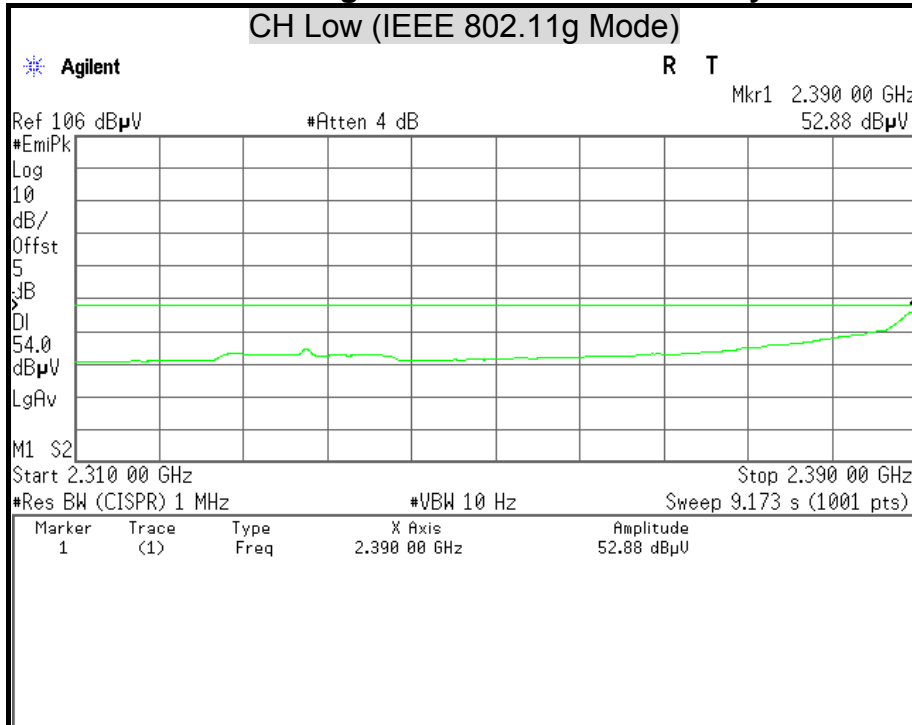



Detector Mode : Peak

Polarity : Horizontal

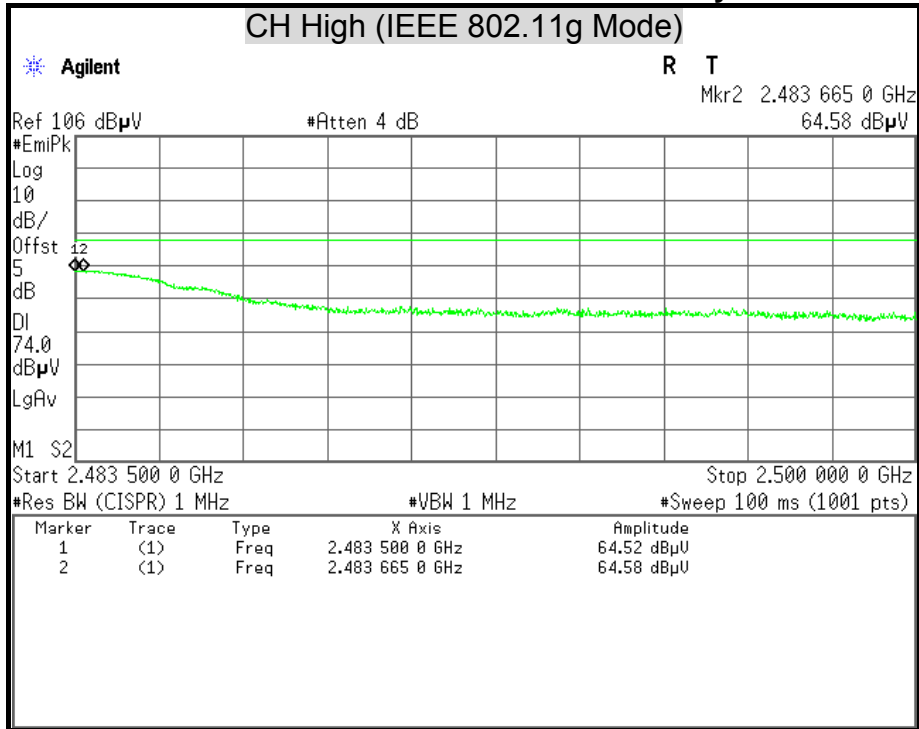

Detector Mode : Average

Polarity : Horizontal

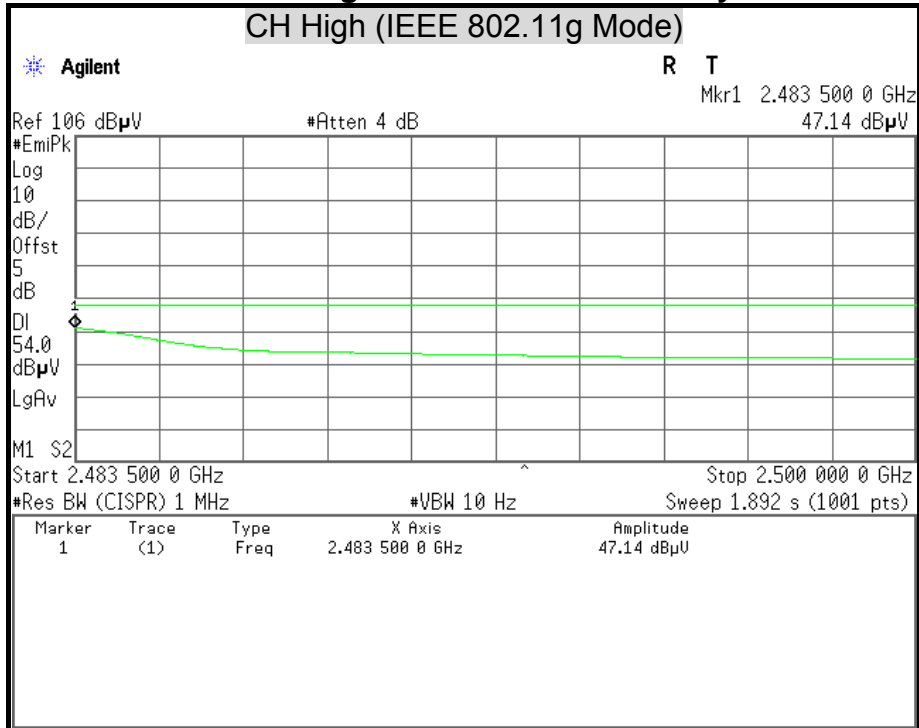



Detector Mode : Peak

Polarity : Vertical

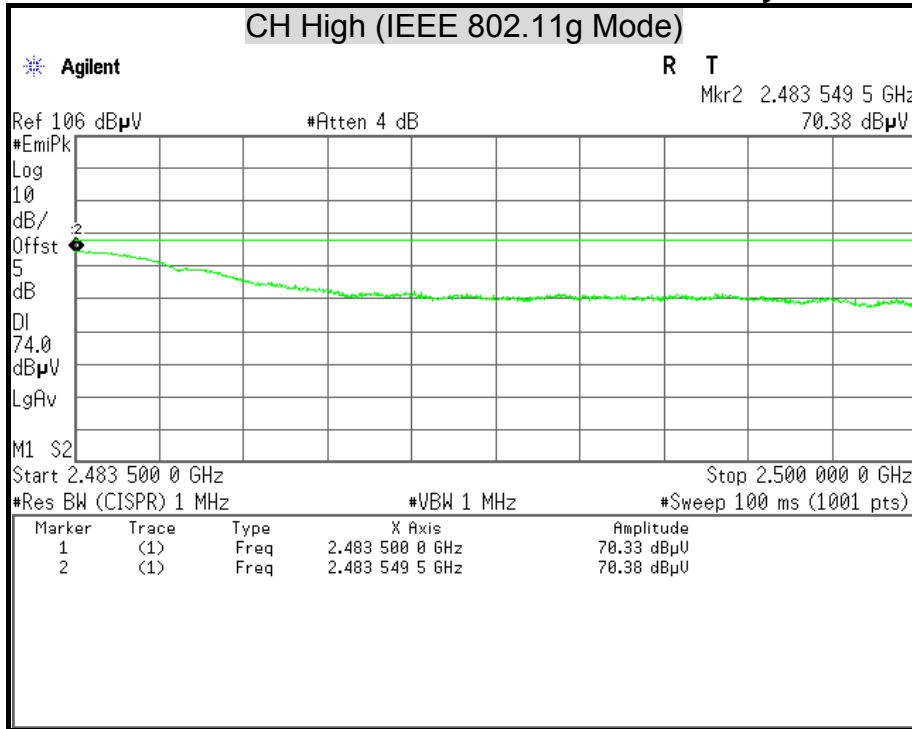

Detector Mode : Average

Polarity : Vertical

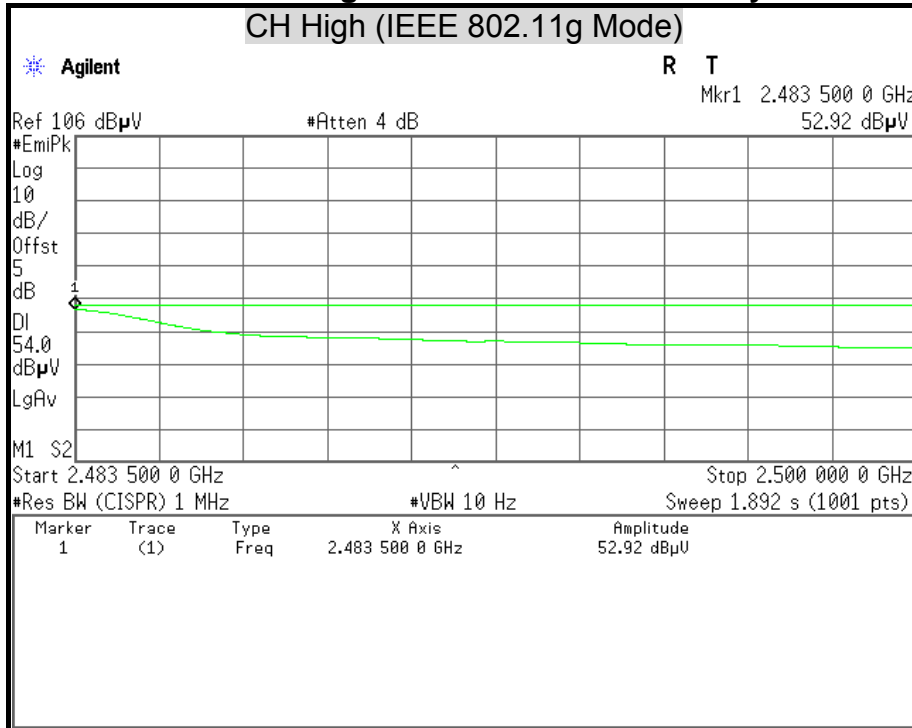



Detector Mode : Peak

Polarity : Horizontal

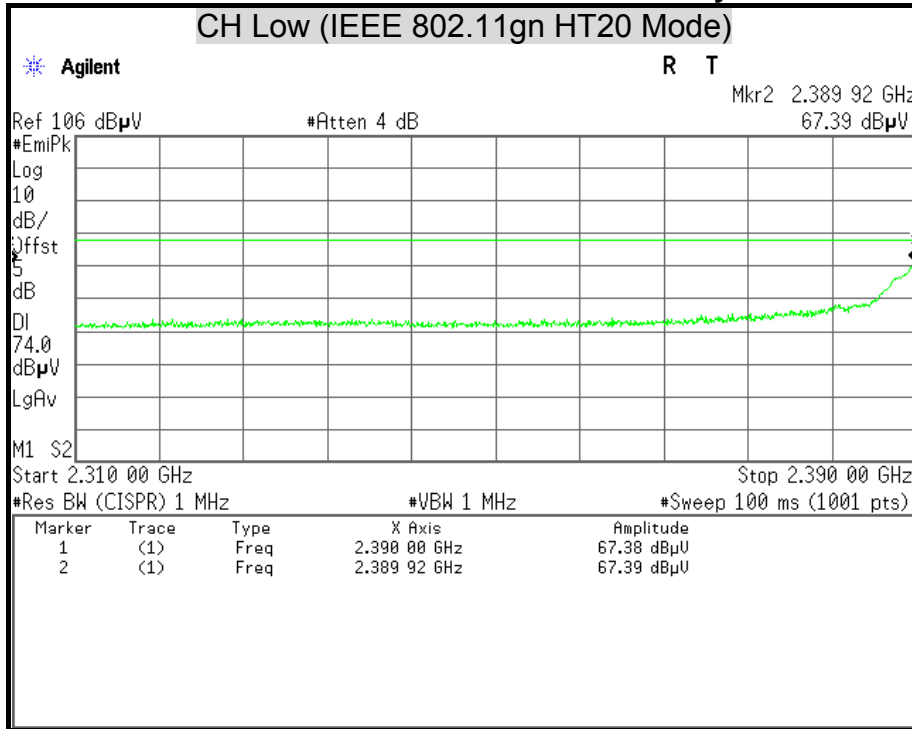

Detector Mode : Average

Polarity : Horizontal

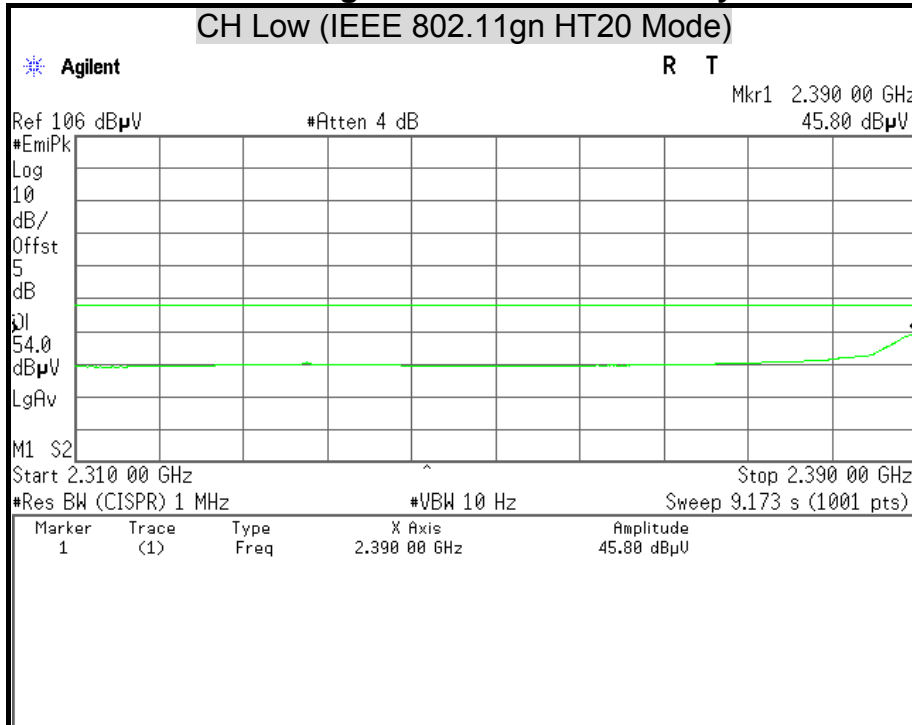



Detector Mode : Peak

Polarity : Vertical

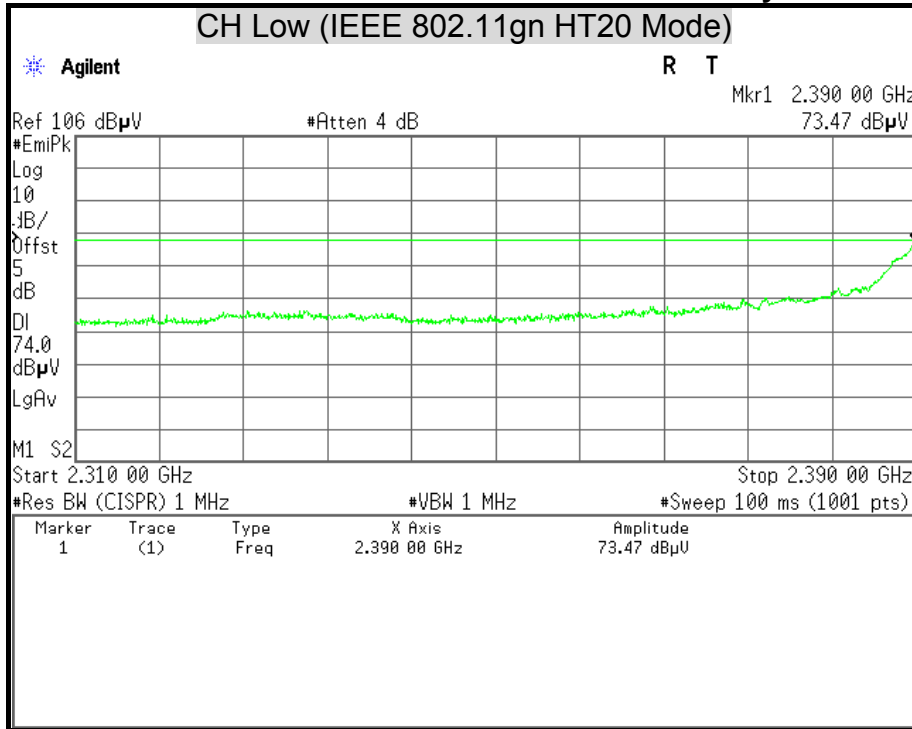

Detector Mode : Average

Polarity : Vertical

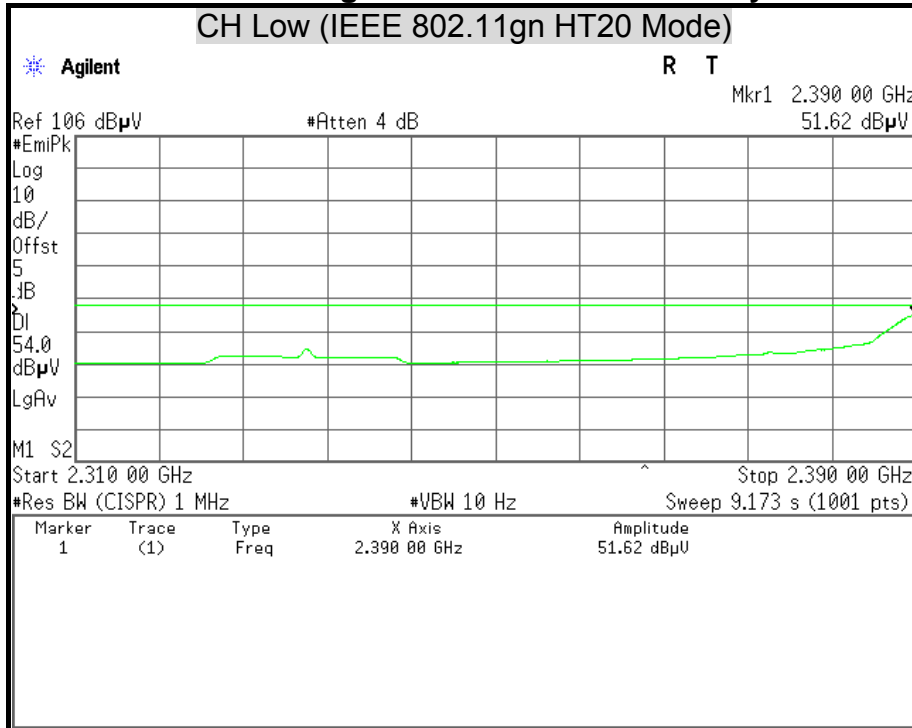



Detector Mode : Peak

Polarity : Horizontal

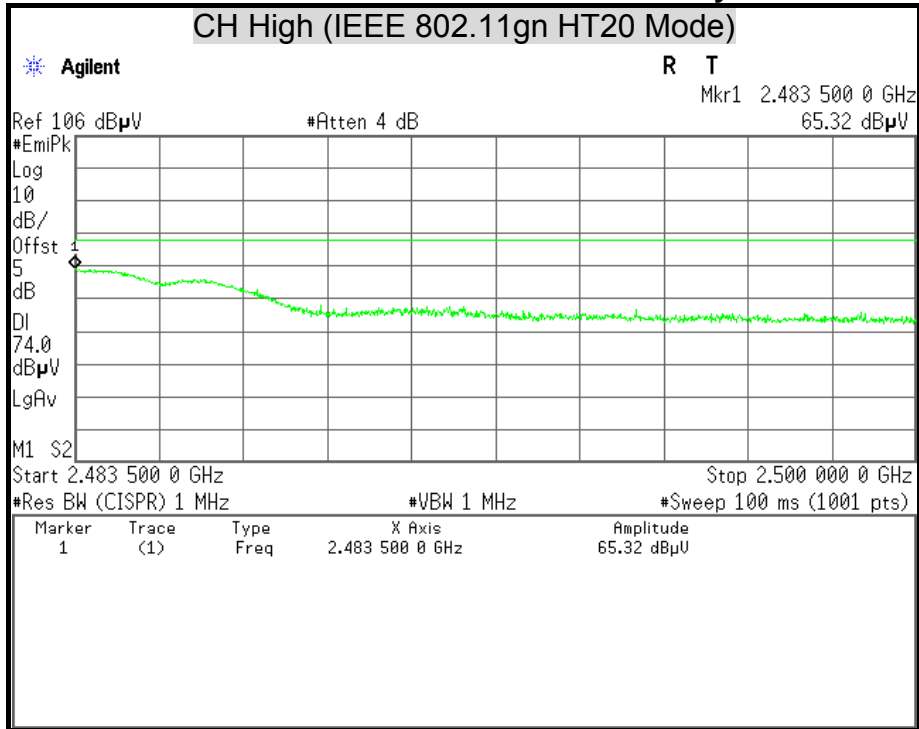

Detector Mode : Average

Polarity : Horizontal

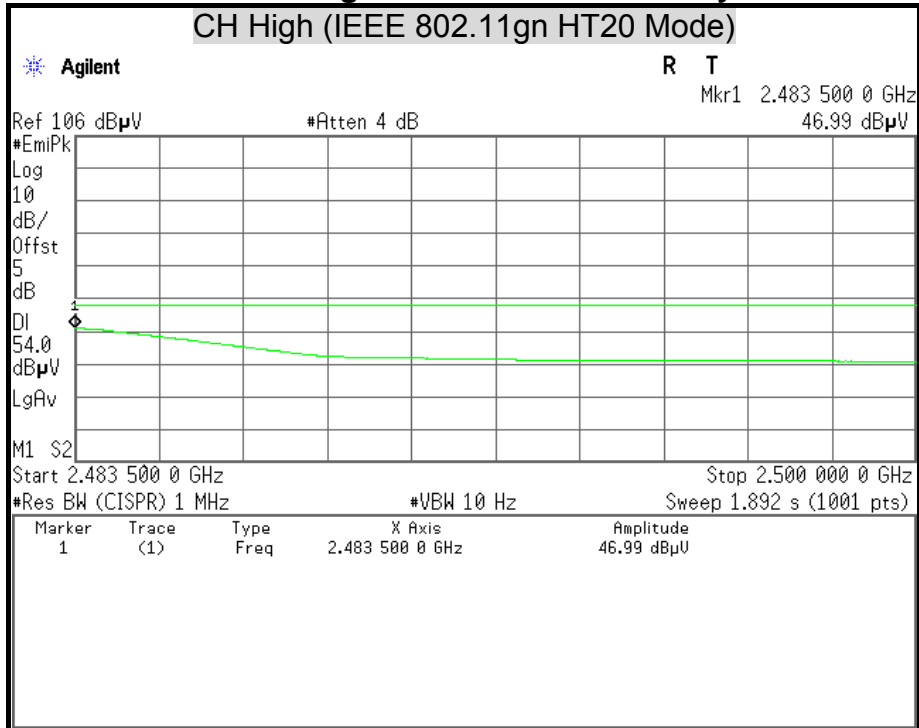



Detector Mode : Peak

Polarity : Vertical

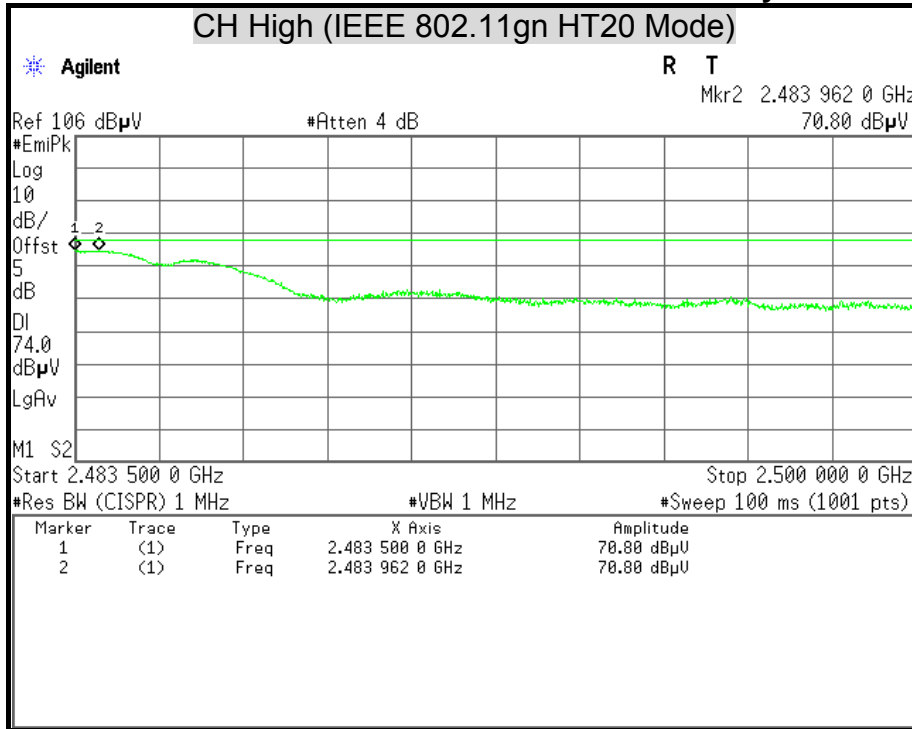

Detector Mode : Average

Polarity : Vertical

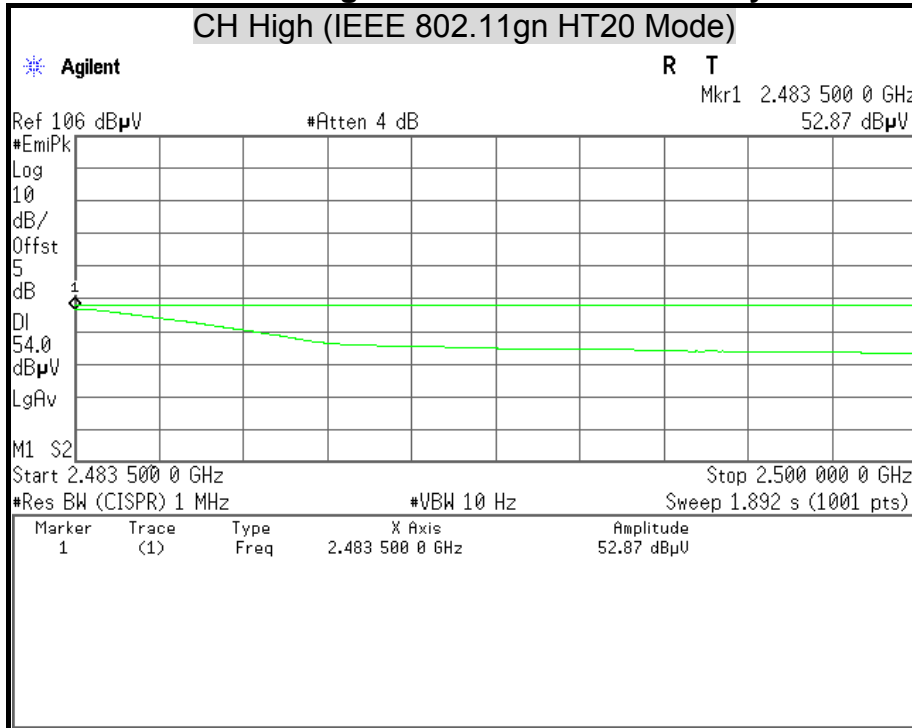



Detector Mode : Peak

Polarity : Horizontal

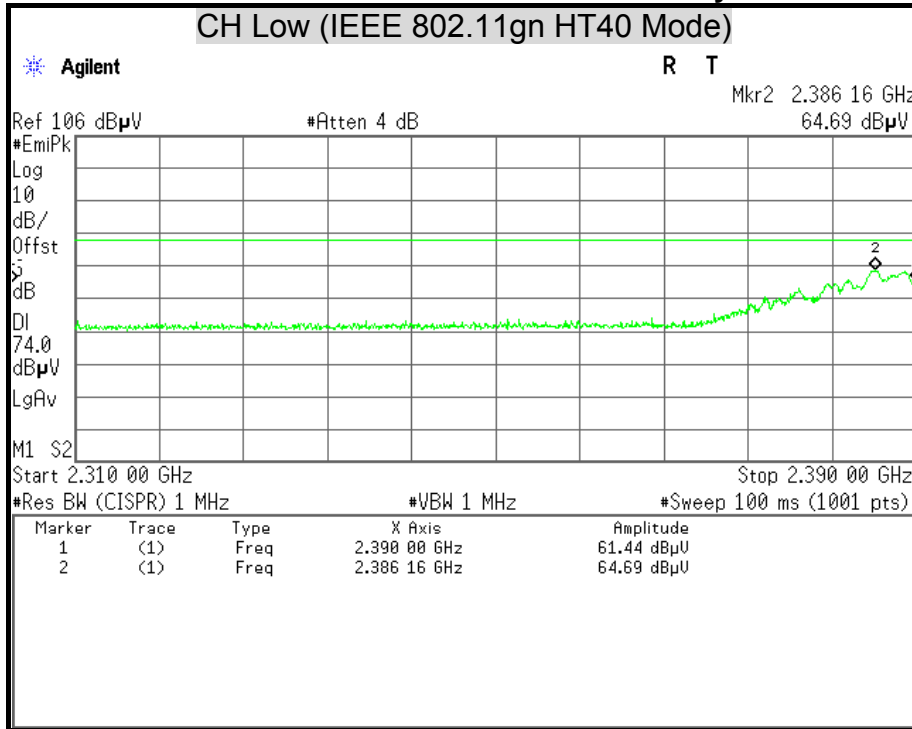

Detector Mode : Average

Polarity : Horizontal

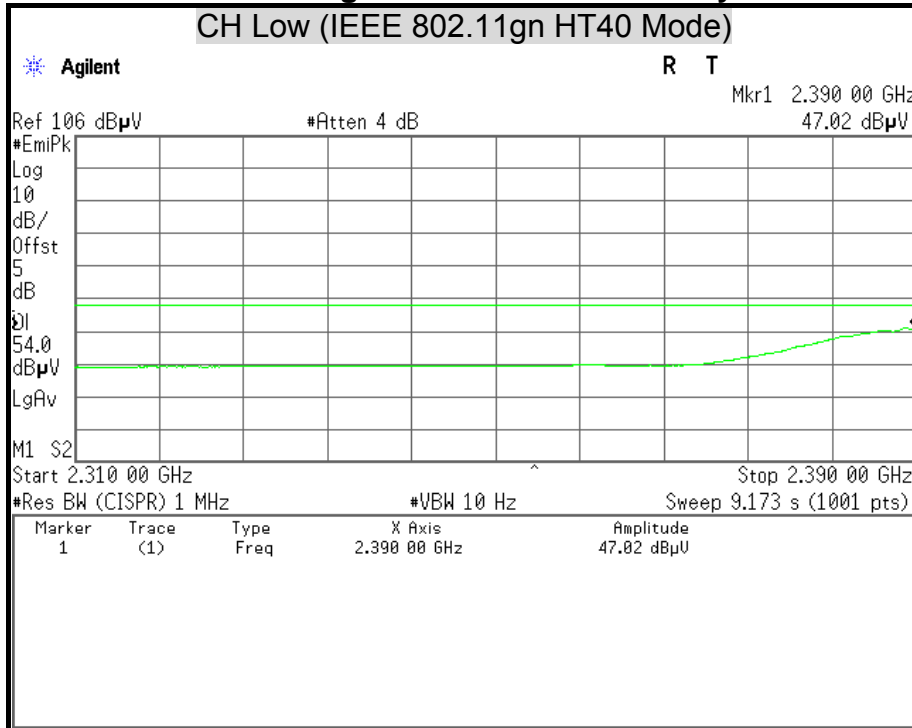



Detector Mode : Peak

Polarity : Vertical

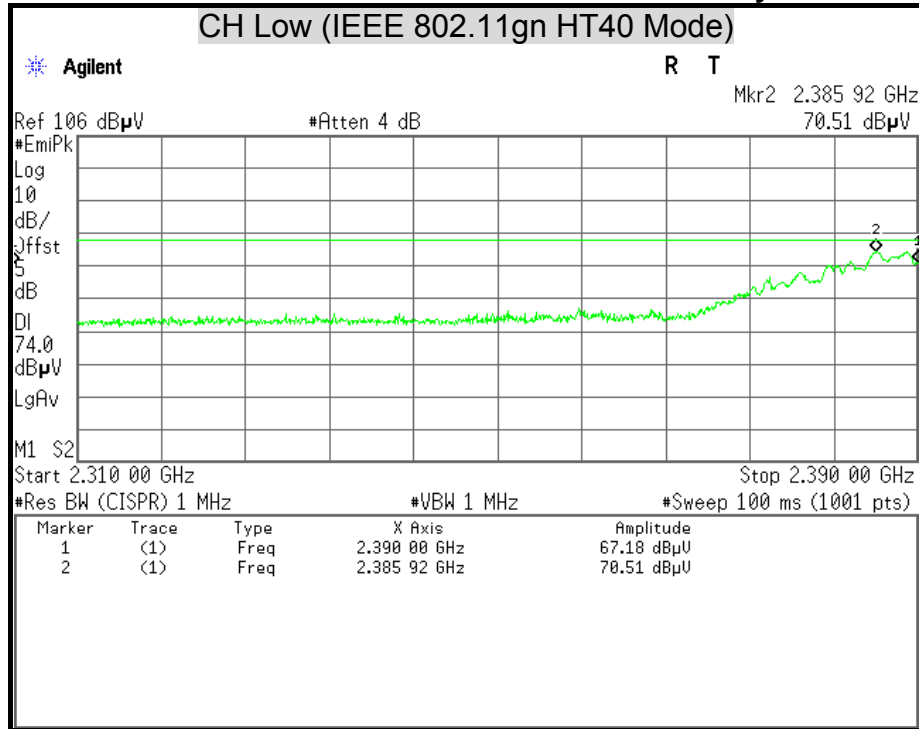

Detector Mode : Average

Polarity : Vertical

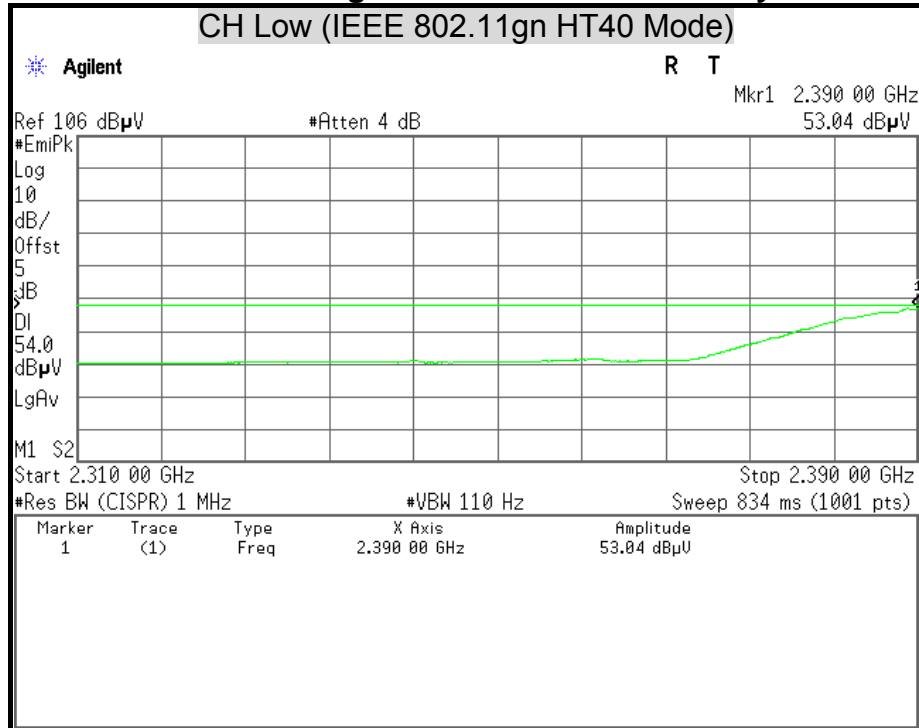



Detector Mode : Peak

Polarity : Horizontal

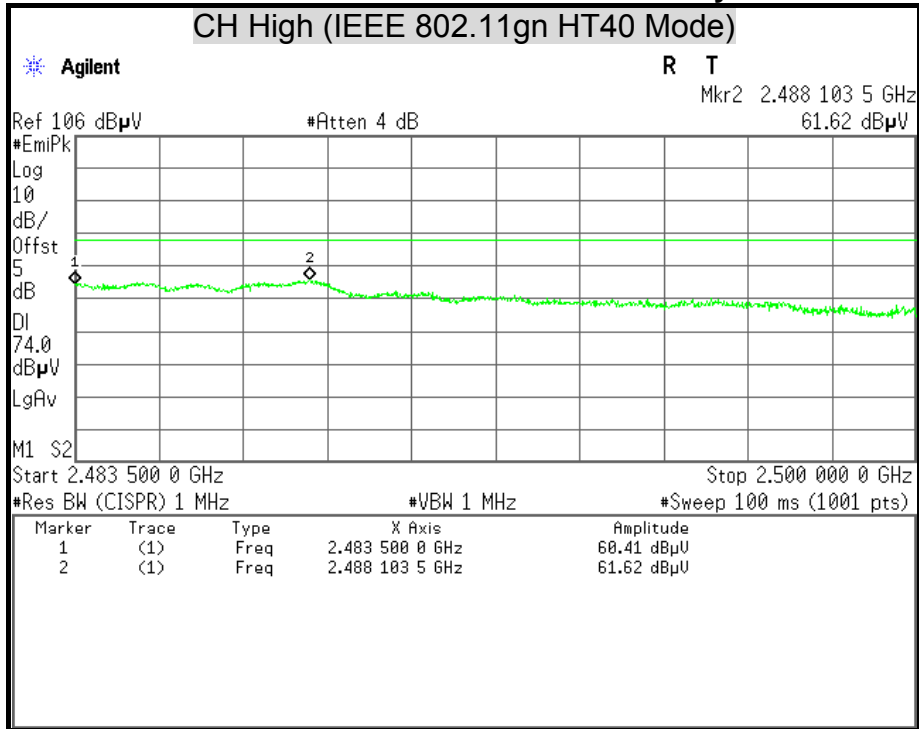

Detector Mode : Average

Polarity : Horizontal

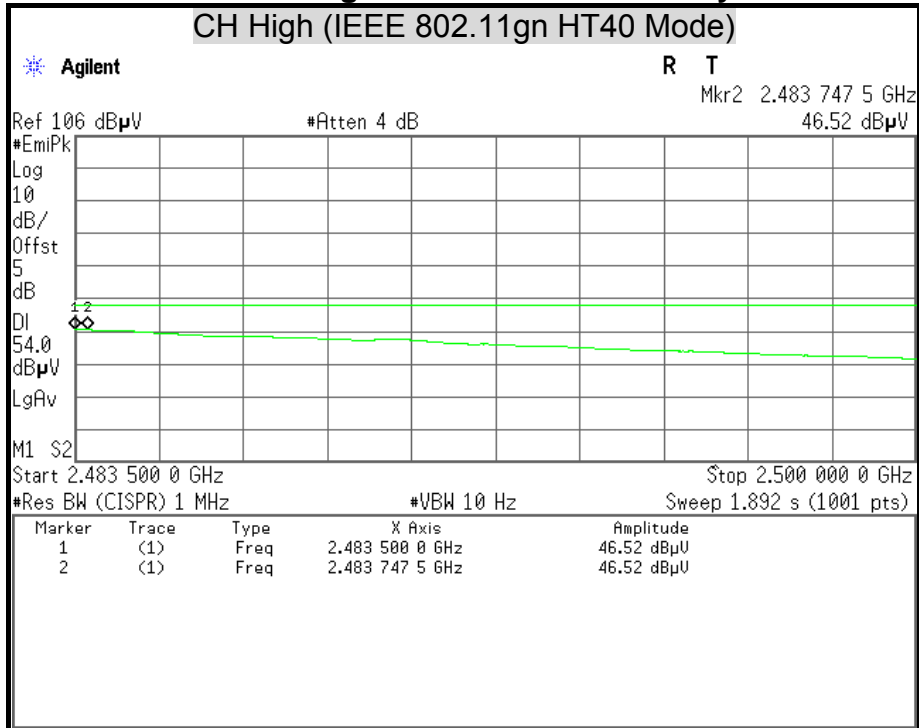



Detector Mode : Peak

Polarity : Vertical

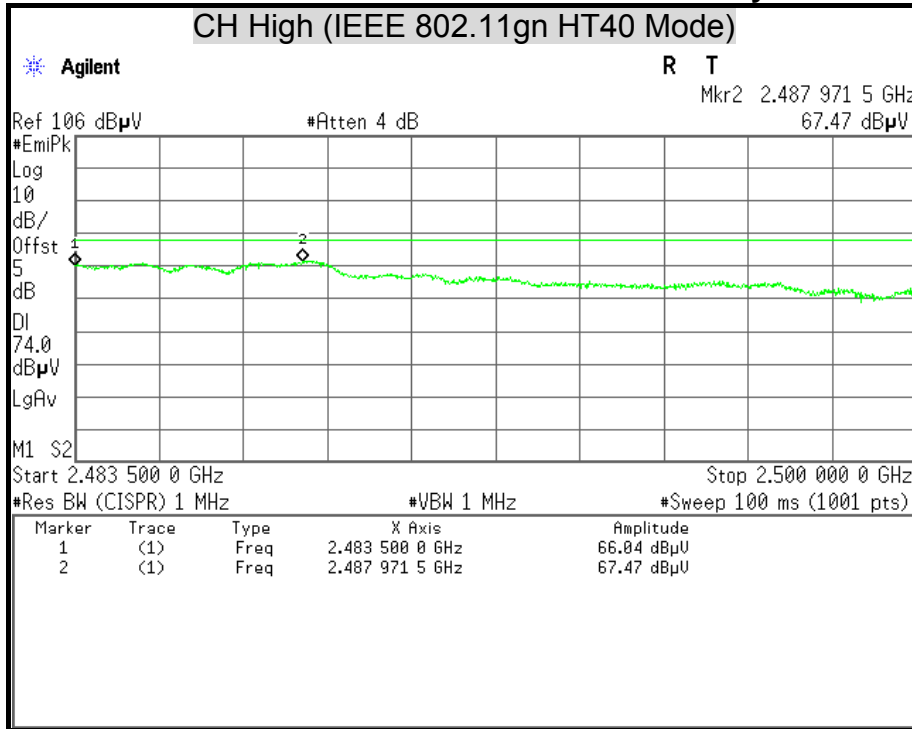

Detector Mode : Average

Polarity : Vertical

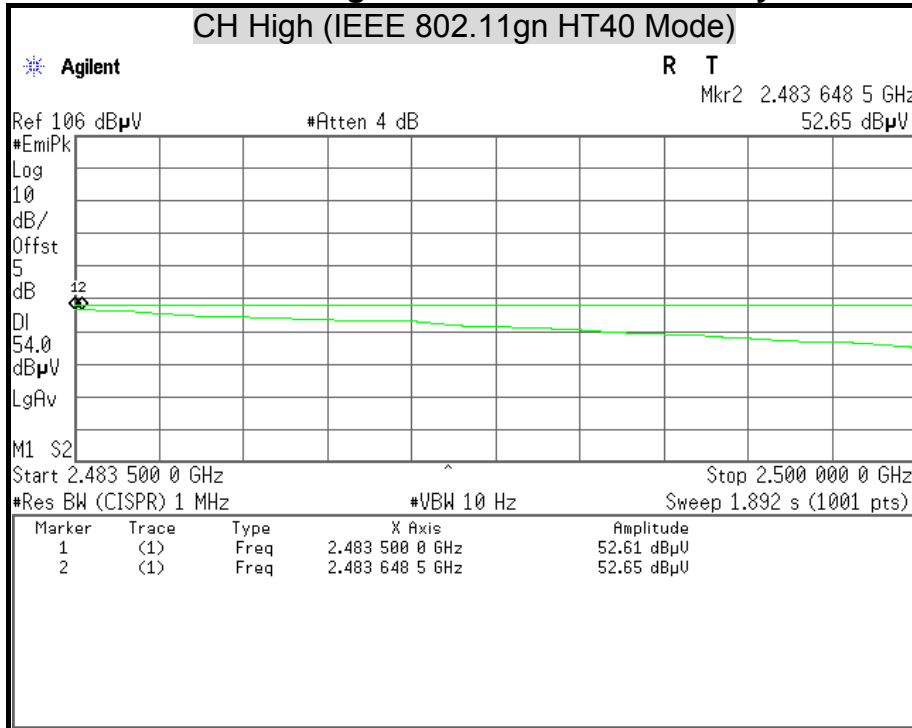



7.7 CONDUCTED EMISSION

LIMITS

§ 15.207 (a) Except as shown in paragraph (b) and (c) this section, for an intentional radiator that is designed to be connected to the public utility (AC) power line, the radio frequency voltage that is conducted back onto the AC power line on any frequency or frequencies within the band 150 kHz to 30 MHz shall not exceed the limits in the following table, as measured using a 50 μ H/50 ohms line impedance stabilization network (LISN). Compliance with the provisions of this paragraph shall be based on the measurement of the radio frequency voltage between each power line and ground at the power terminal. The lower limit applies at the boundary between the frequency ranges.

Frequency Range (MHz)	Conducted Limit (dB μ v)	
	Quasi-peak	Average
0.15 - 0.50	66 - 56*	56 - 46*
0.50 - 5.00	56	46
5.00 - 30.0	60	50

Remark: * Decreasing linearly with the logarithm of the frequency.

TEST EQUIPMENT

Name of Equipment	Manufacturer	Model	Serial Number	Calibration Due
L.I.S.N	SCHWARZBECK	NSLK 8127	8127-465	08/11/2014
L.I.S.N	SCHWARZBECK	NSLK 8127	8127-473	03/10/2015
EMI Test Receiver	ROHDE & SCHWARZ	ESHS 30	838550/003	11/07/2014
Pulse Limiter	ROHDE & SCHWARZ	ESH3-Z2	100111	06/30/2015

Remark: Each piece of equipment is scheduled for calibration once a year.



TEST SETUP

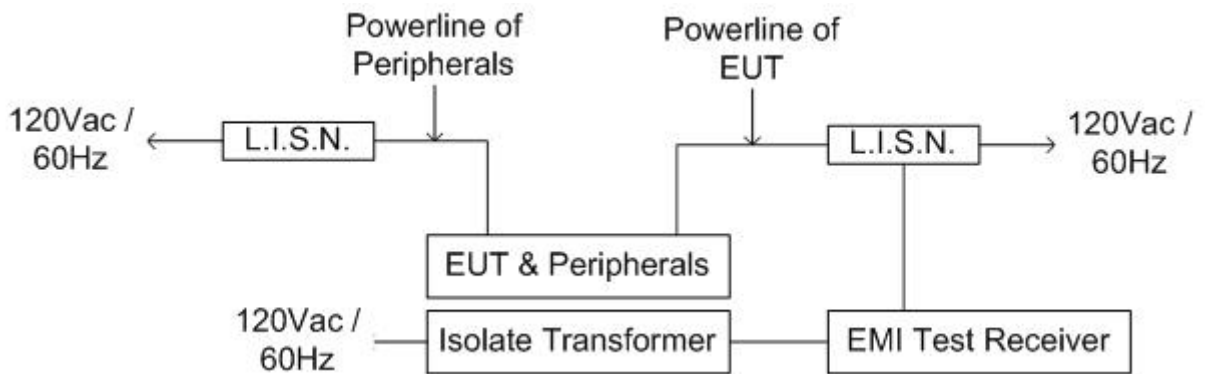
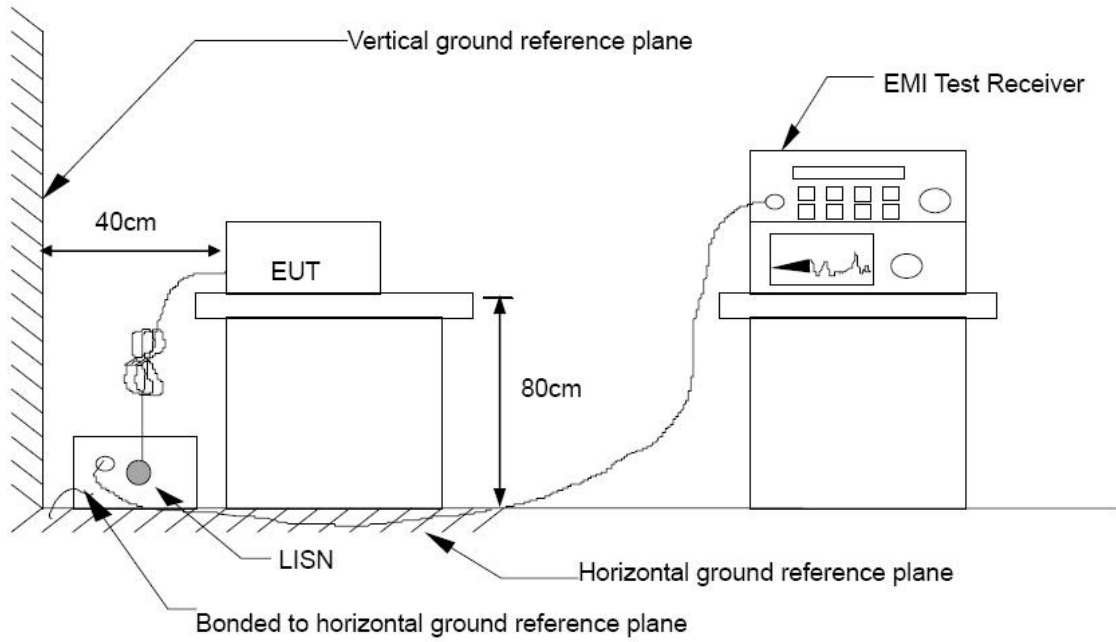



TEST PROCEDURE

The basic test procedure was in accordance with ANSI C63.10:2009.

The test procedure is performed in a 4m × 3m × 2.4m (L×W×H) shielded room.

The EUT along with its peripherals were placed on a 1.0m (W) × 1.5m (L) and 0.8m in height wooden table and the EUT was adjusted to maintain a 0.4 meter space from a vertical reference plane.

The EUT was connected to power mains through a line impedance stabilization network (LISN) which provides 50 ohm coupling impedance for measuring instrument and the chassis ground was bounded to the horizontal ground plane of shielded room. All peripherals were connected to the second LISN and the chassis ground also bounded to the horizontal ground plane of shielded room.

The EUT was located so that the distance between the boundary of the EUT and the closest surface of the LISN is 0.8 m. Where a mains flexible cord was provided by the manufacturer shall be 1 m long, or if in excess of 1 m, the excess cable was folded back and forth as far as possible so as to form a bundle not exceeding 0.4 m in length.



TEST RESULTS

Product Name	HD IP Camera	Test By	Ted Wu
Test Model	IP-2100	Test Date	2014/07/10
Test Mode	Normal Operating	Temp. & Humidity	21°C, 61%

LINE

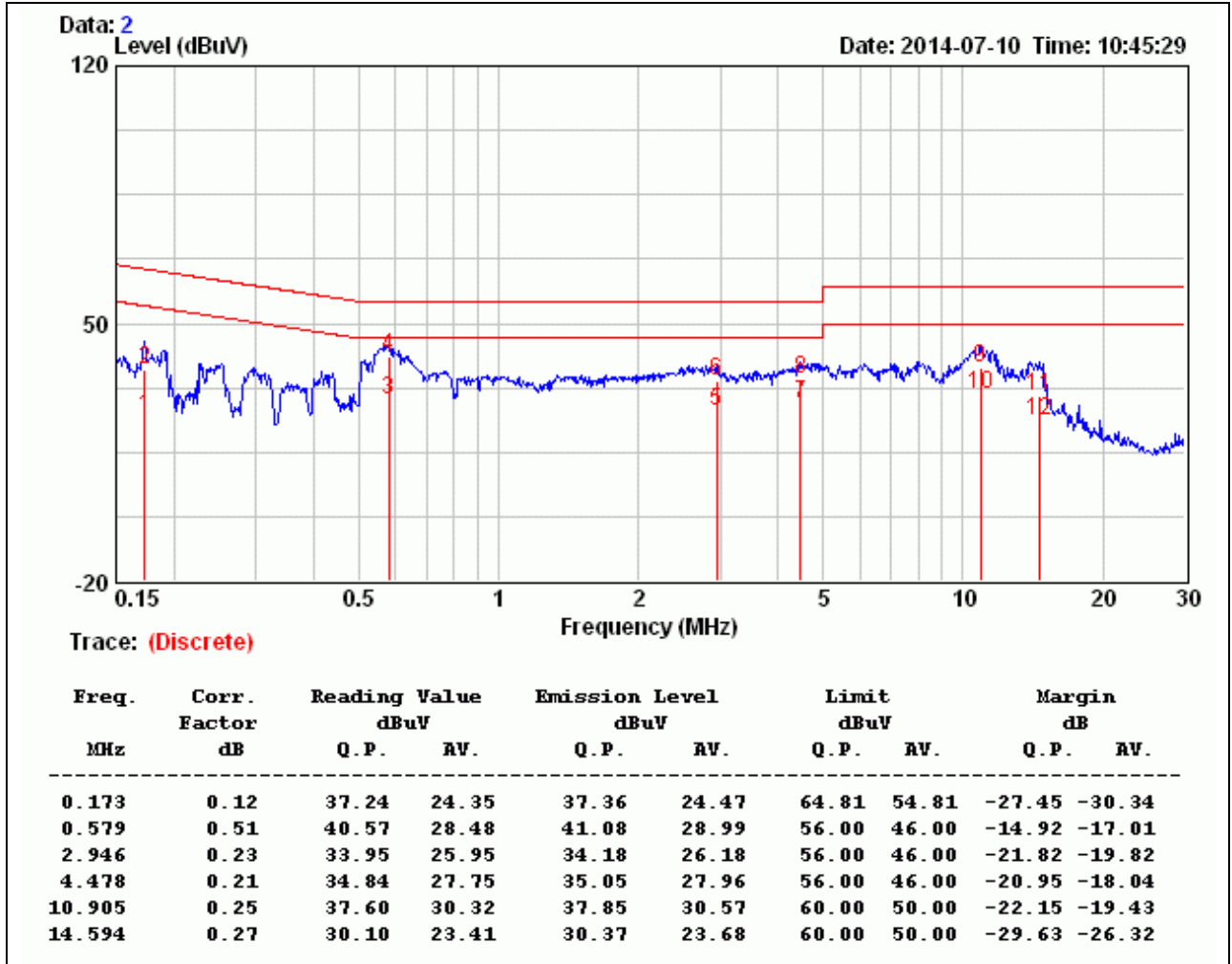

Remark:

1. Correction Factor = Insertion loss + Cable loss
2. Emission level = Reading Value + Correction factor
3. Margin value = Emission level - Limit value



Product Name	HD IP Camera	Test By	Ted Wu
Test Model	IP-2100	Test Date	2014/07/10
Test Mode	Normal Operating	Temp. & Humidity	21°C, 61%

NEUTRAL

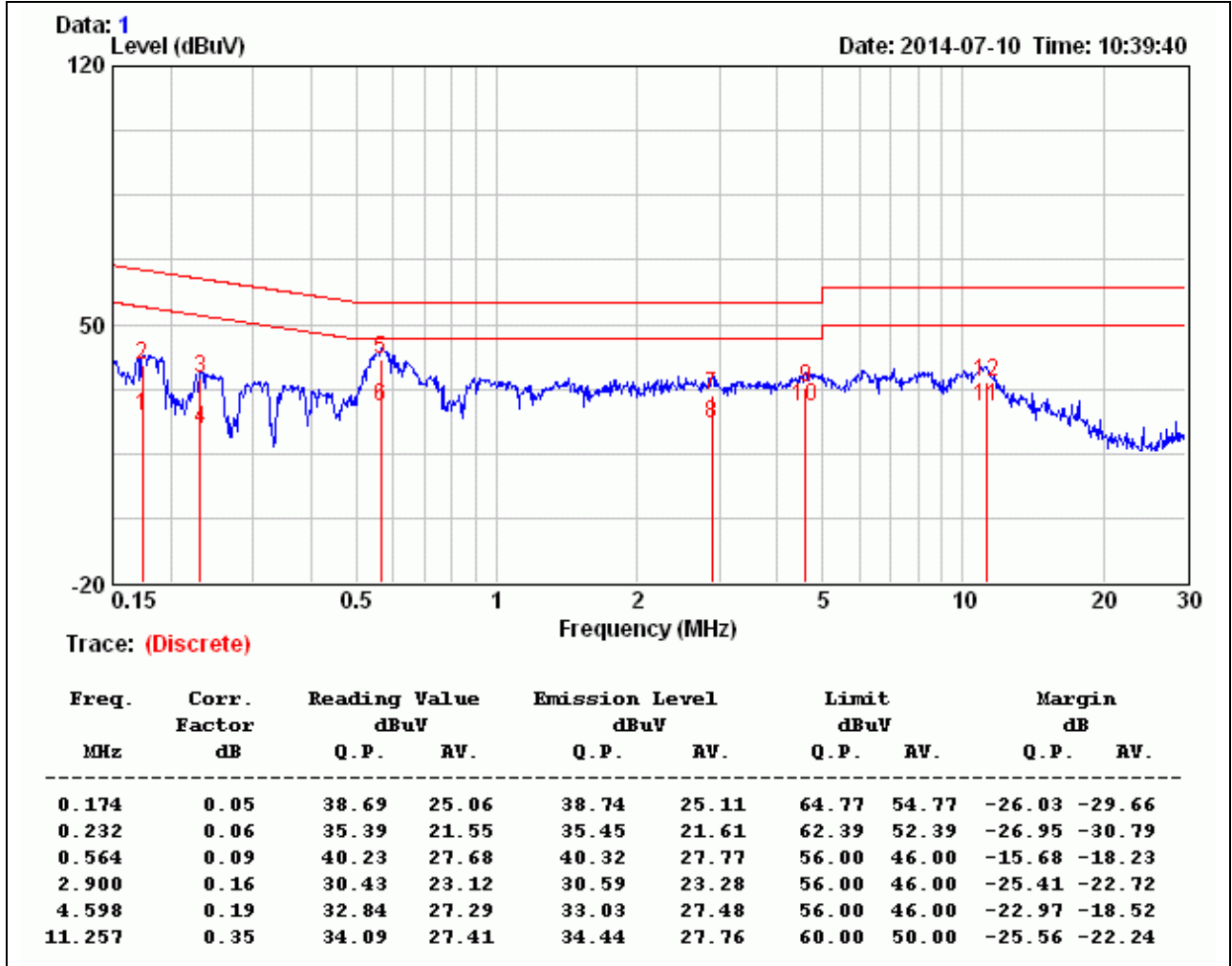

Remark:

1. Correction Factor = Insertion loss + Cable loss
2. Emission level = Reading Value + Correction factor
3. Margin value = Emission level – Limit value