

DAS-2420

2.4 GHz Wireless Digital Audio Sender with Portable Receiver

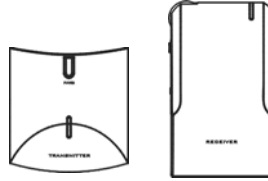

Introduction

In the scenario, when you want to watch your favorite action movie at night, and all your family members were sleep, you do not want to wake them up at this time, The DAS-2420 is the best solution. DAS-2420 deploy the 2.4GHz ISM band with frequency hopping and WiFi auto-detection scheme to provide crystal clear audio.

Feature

- 2.4GHz ISM band
- ID Pairing
- 34 channels Frequency hopping
- 1→1, 1→N Application
- Portable receiver with batteries powering and DC adaptor powering
- Frequency hopping to avoid co-channel interference
- Volume controllable via rotatable switch
- 44.1KHz sampling frequency

Package of content

Before your installation, please check the content of package

- DAS-2420 Tx X1
- DAS-2420 Rx X1
- AC/DC Adaptor X2
- 3.5 mm to RCA R/L audio cable X1
- Stereo 3.5mm Cabel
- Earphone X1

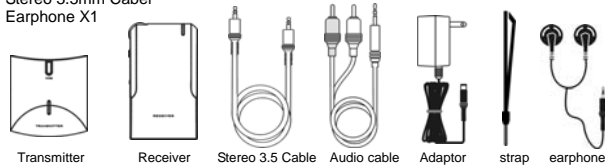

Connectors and control

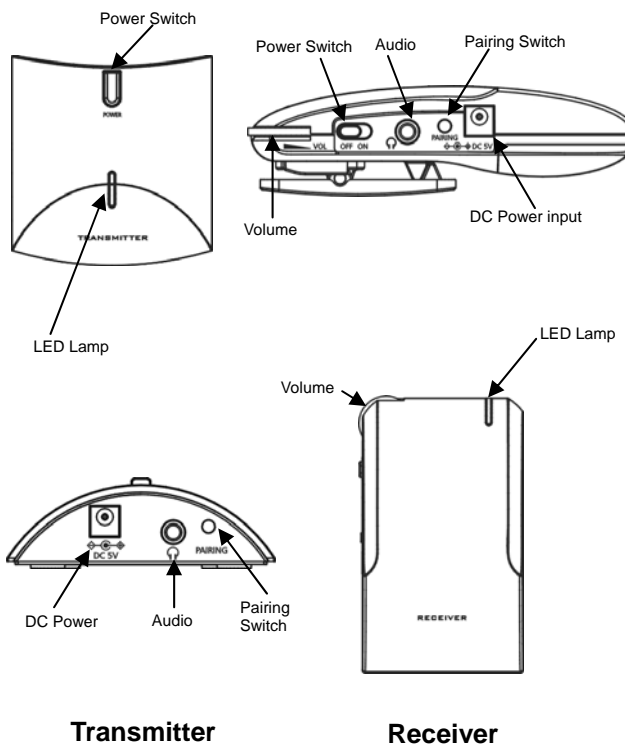

Transmitter

Receiver

CAUTION

Federal Communication Commission Interference Statement

This equipment has been tested and found to comply with the limits for a Class B digital device, pursuant to Part 15 of the FCC Rules. These limits are designed to provide reasonable protection against harmful interference in a residential installation. This equipment generates, uses and can radiate radio frequency energy and, if not installed and used in accordance with the instructions, may cause harmful interference to radio communications. However, there is no guarantee that interference will not occur in a particular installation. If this equipment does cause harmful interference to radio or television reception, which can be determined by turning the equipment off and on, the user is encouraged to try to correct the interference by one of the following measures:

- Reorient or relocate the receiving antenna.
- Increase the separation between the equipment and receiver.
- Connect the equipment into an outlet on a circuit different from that to which the receiver is connected.
- Consult the dealer or an experienced radio/TV technician for help.

FCC Caution: Any changes or modifications not expressly approved by the party responsible for compliance could void the user's authority to operate this equipment.

This device complies with Part 15 of the FCC Rules. Operation is subject to the following two conditions:

- (1) This device may not cause harmful interference, and
- (2) This device must accept any interference received, including interference that may cause undesired operation.

CAUTION

RISK OF EXPLOSION IF BATTERY IS REPLACED BY AN INCORRECT TYPE.
DISPOSE OF USED BATTERIES ACCORDING TO THE INSTRUCTIONS

Installation Illustration

Before your operation, please read this manual carefully and keep this for further reference.

Application 1: Listen to the TV sound without turn the volume of TV loudly.
In this scenario, the Tx unit should be located around the TV set

Tx installation

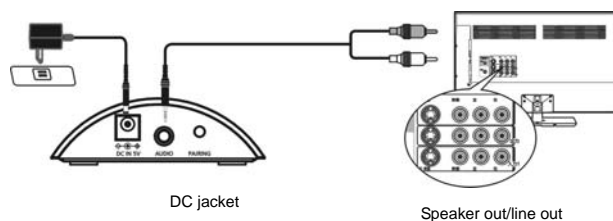

Step1: Take out the main unit
Step2: Take a 3.5mm→Audio RL cable, connect the 3.5mm connector to the 3.5mm socket on the Tx unit, another RL connector to the "Speaker out" or "line out" of your TV set
Step3: Take out the AC/DC adaptor, plug the barrel end to the DC socket of DAS-2420, the AC blade end to your AC outlet, please be noted, DO NOT OVERLOAD YOUR AC OUTLET.

Rx installation

Via AA Batteries powering

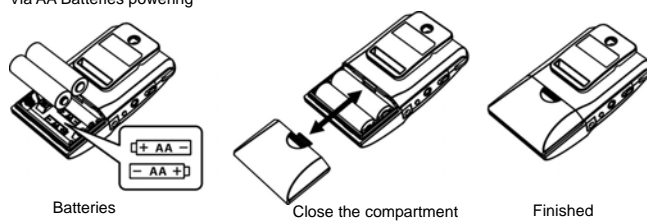

Step1: Take out the Rx unit
Step2: open the batteries compartment
Step3: Install 2 new AA batteries as figure shown (please make sure the polarity)
Step4: Close the Batteries compartment

Via AC/DC Adaptor

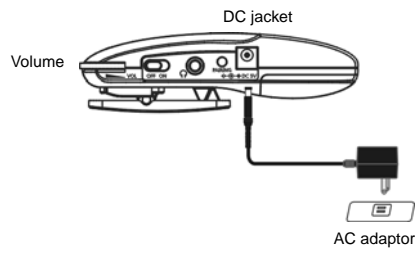

- Step1: Take out the Rx unit
 - Step2: Take out the AC/DC adaptor included
 - Step3: Connect the DC barrel end to the DC socket of RX
 - Step4: Connect the AC blade end to your AC outlet, **please be noticed, DO NOT OVERLOAD YOUR AC Outlet**
- Note: When you using AC/DC Adaptor, the power from batteries is cut.**

Strap for hanging

Please take the strap and fasten it on the receiver unit like followed illustration picture.

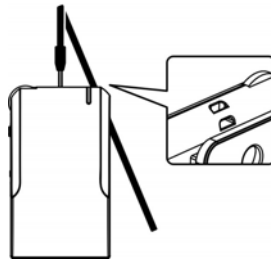

Operation

When All the connection are finished, you can start to use this wireless audio sender system as followed steps

Step1: Power on the Tx (press the power switch on the Tx)

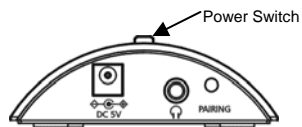

Step2: Power on the Rx unit via sliding the Power key on the RX unit

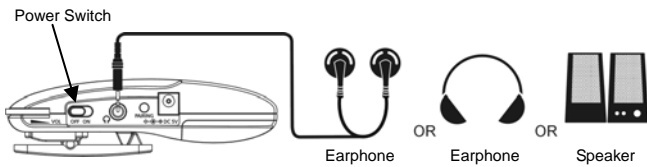

Step4: Turn the Volume of Rx to the lowest value

Step5: Connect the earphone to the Audio socket on the RX unit

Step6: You have finished all the setting , and you can listen to the TV sound now, and you can adjust the suitable volume for yourself.

ADDING A NEW RX

The DAS-2420 is designed to work with various Rx's, it can be configured to work with more than 16 Rx's (within the transmission distance).

How to add a new Rx

Step1: Power the Transmitter unit, press the power switch.
Step2: Power on the Receiver unit, slide the power switch.
Step3: Press Pairing key on the transmitter for 3 Secs. Transmitter will be under pairing mode, the LED on Tx will be blinking.

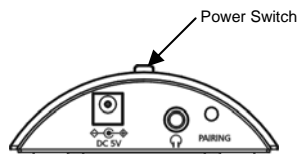

Step4: Press the pairing key on receiver for 3 Secs, Tx and Rx are under pairing mode. The LED on Rx will be blinking.

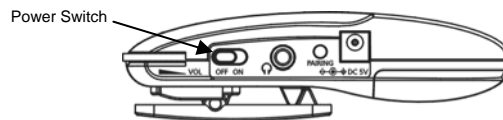

Step5: When the pairing procedure is ok, LED on Tx and Rx will dimmed at the same time, Pairing is OK. It will take 10 sec to do the pairing.

FAQ

No audio output

1. Check the power of Tx and Rx.
2. Check the audio connection on Tx and Rx.
3. Check the LED light on Tx, if there is audio presented, the LED will be lighted, if it is blinking that means that there is no audio presented in Tx.

There is some noise

1. Check the Tx and Rx are in the range of specification
2. Check if there are obstacles in the transmission range, such as microwave oven. Etc
3. press the pairing key once to check if there is interference again.

SAFETY NOTICE

- INDOOR USE ONLY.
- THIS DEVICE WITH WIRELESS RF SIGNAL RECEPTION,CONSULT YOUR DOCTOR IF YOU WEAR PACEMAKER.
- IF YOU GO OUT FOR MORE THAN 2 WEEKS, PLEASE TAKE THE BATTERIES OUT FROM YOUR RX UNIT.
- CLEAN WITH DRY AND SOFT CLOTH.
- DO NOT OPEN THE UNIT.
- NO SERVICEABLE PARTS FOR CUSTOMER.
- DO NOT USE THIS UNIT IN THE HOT AND DAMP PLACE.

Digital Audio Sender Specifications

Model NO.	Transmitter	RECEIVER
Description	Transmitter	Receiver
Operating temperature	0 ~ +60 (degrees Celsius)	0 ~ +60 (degrees Celsius)
Frequency range	2406 ~ 2472 MHz	2406 ~ 2472 MHz
Modulation	GFSK	
Channels	34	
TX Power	15 dBm	
Input impedance	>10K Ohm (3.5mm)	
Input level	2Vp-p (Max)	
RX Sensitivity		-78 dBm (Min.)
Output impedance		16 Ohm (Nominal)
Output level		2Vp-p (Max)
Transmit Distance Between Tx & Rx	100ft(Min, LOS)	
Response (station)	20 ~ 20 KHz, ±0.5dB	
Crosstalk	-70dB (Min)	
S/N ratio (station)	70dB (Min)	
THD + N	5% (Max)	
Power supply	AC 90~240V @50/60Hz/DC 5V, 1000mA PLUG: 5.5mmx2.1mmx11mm Polarity: Outside Jack(-) Inside Jack(+)	

NOTE: The changes or modifications not expressly approved by the party responsible for compliance could void the user's authority to operate the equipment.

To avoid the interference, please far away the sources of interference such as wireless LAN AP, Microwave OVEN etc

Federal Communication Commission Interference Statement

This device complies with Part 15 of the FCC Rules. Operation is subject to the following two conditions: (1) This device may not cause harmful interference, and (2) this device must accept any interference received, including interference that may cause undesired operation.

This equipment has been tested and found to comply with the limits for a Class B digital device, pursuant to Part 15 of the FCC Rules. These limits are designed to provide reasonable protection against harmful interference in a residential installation. This equipment generates, uses and can radiate radio frequency energy and, if not installed and used in accordance with the instructions, may cause harmful interference to radio communications. However, there is no guarantee that interference will not occur in a particular installation. If this equipment does cause harmful interference to radio or television reception, which can be determined by turning the equipment off and on, the user is encouraged to try to correct the interference by one of the following measures:

- Reorient or relocate the receiving antenna.
- Increase the separation between the equipment and receiver.
- Connect the equipment into an outlet on a circuit different from that to which the receiver is connected.
- Consult the dealer or an experienced radio/TV technician for help.

FCC Caution: Any changes or modifications not expressly approved by the party responsible for compliance could void the user's authority to operate this equipment.

This transmitter must not be co-located or operating in conjunction with any other antenna or transmitter.

FOR MOBILE DEVICE USAGE (>20cm/low power)

Radiation Exposure Statement:

This equipment complies with FCC radiation exposure limits set forth for an uncontrolled environment. This equipment should be installed and operated with minimum distance 20cm between the radiator & your body.