

TEST REPORT
No.: 6-0592-14-2-10a-C1

According to:

FCC Part 15.247

for
ASCOM AB

SH1-ACAA
Cellular/Wi-Fi Smartphone
(WLAN 2.4GHz)

FCC ID: BXZSH1C







Laboratory Accreditation and Listings			
 <p>DAkKS Deutsche Akkreditierungsstelle D-PL-12047-01-01</p>	 <p>FEDERAL COMMUNICATIONS COMMISSION FC USA MRA US-EU 0003</p>	 <p>Industry Canada Reg. No.: 3462D-1 Reg. No.: 3462D-2 Reg. No.: 3462D-3</p>	 <p>Voluntary Controls for Electromagnetic Emissions Reg. No.: R-2666 C-2914, T-1967, G-301</p>
 <p>WiFi ALLIANCE AUTHORIZED RF LABORATORY</p>	 <p>CTIA Authorized Test Lab LAB CODE 20011130-00</p>		
accredited according to DIN EN ISO/IEC 17025			
<p>CETECOM GmbH Laboratory Radio Communications & Electromagnetic Compatibility Im Teelbruch 116 • 45219 Essen • Germany Registered in Essen, Germany, Reg. No.: HRB Essen 8984 Tel.: + 49 (0) 20 54 / 95 19-954 • Fax: + 49 (0) 20 54 / 95 19-964 E-mail: info@cetecom.com • Internet: www.cetecom.com</p>			

Table of contents

1. SUMMARY OF TEST RESULTS.....	3
1.1. Tests measurement overview according of US FCC CFR47, Part 15C Standards	3
2. ADMINISTRATIVE DATA	5
2.1. Identification of the testing laboratory.....	5
2.2. Test location	5
2.3. Organizational items.....	5
2.4. Applicant’s details	5
2.5. Manufacturer’s details	5
3. EQUIPMENT UNDER TEST (EUT).....	6
3.1. TECHNICAL DATA OF MAIN EUT DECLARED BY APPLICANT.....	6
3.2. IEEE 802.11 OVERVIEW: MODULATION AND DATA RATES	7
3.3. EUT: Type, S/N etc. and short descriptions used in this test report	8
3.4. Auxiliary Equipment (AE): Type, S/N etc. and short descriptions.....	8
3.5. EUT set-ups	8
3.6. EUT operating modes	9
3.7. Configuration of cables used for testing	9
3.8. Test system set-up for conducted RF-measurement at antenna port.....	10
3.9. Test system set-up for radiated magnetic field measurements below 30 MHz.....	11
3.10. Test system set-up for radiated electric field measurement 30 MHz to 1 GHz	12
3.11. Test system set-up for radiated electric field measurement above 1 GHz	13
4. MEASUREMENTS	14
4.1. RF-Parameter conducted - 6 dB Bandwidth and 99% occupied Bandwidth	14
4.2. RF-Parameter conducted: Maximum peak output power	16
4.3. RF-Parameter conducted - Power Spectral Density.....	19
4.4. RF-Parameter conducted - 20 dBc power specification.....	21
4.5. General Limit - Conducted emissions on AC-Power lines	23
4.6. General Limit - Radiated field strength emissions below 30 MHz.....	24
4.7. General Limit - Radiated field strength emissions, 30 MHz - 1 GHz.....	26
4.8. General Limit - Radiated emissions, above 1 GHz.....	28
4.9. RF-Parameter - Radiated Band Edge compliance measurements	29
4.10. Measurement uncertainties	31
5. ACCREDITATION DETAILS OF CETECOM’S LABORATORIES AND TEST SITES	31
6. INSTRUMENTS AND ANCILLARY.....	32
6.1. Used equipment “CTC”	32
7. VERSIONS OF TEST REPORTS (CHANGE HISTORY)	35

Table of annex

	Total pages
Annex 1: External photographs of EUT - separate document TR6-0592-14-2-10a-A1	4
Annex 2: Internal photographs of EUT - separate document TR6-0592-14-2-10a-A2	4
Annex 3: Test set-up photographs - separate document TR6-0592-14-2-10a-A3	5
Annex 4: Measurement diagrams - separate document TR6-0592-14-2-10a -A4	125

1. Summary of test results

The test results apply exclusively to the test samples as presented in this Report. The CETECOM GmbH does not assume responsibility for any conclusions and generalizations taken in conjunction with other specimens or samples of the type of the item presented to tests.

The presented Equipment Under Test (in this report, hereinafter referred as EUT) is a radio transmitting device on WiFi 2.4/5GHz band which incorporates also cellular technology.

The Cellular and 5GHz WiFi wireless technology were not tested within this test report, this is covered separately by other test reports.

All test results are valid only with the specific power settings for each operating mode or channel as described on each tests. **The manufacturer is informed that usage of other power settings then determined within this test session, may result in a non-compliance verdict. It is applicant's responsibility to ensure that only during the test session determined settings are used in final firmware software version delivered to market.**

1.1. Tests measurement overview according of US FCC CFR47, Part 15C Standards

Test cases	Port	References & Limits		EUT set-up	EUT operating mode	Result
		FCC Standard	Test Limit			
TX-Mode						
Timing of transmitter (pulsed operation)	Antenna Terminal or enclosure	§15.35	--	--	--	Not applicable
6 dB bandwidth	Antenna terminal (conducted)	§15.247(a)(2)	≥ 500 kHz for DTS systems	1	1	passed
99% occupied bandwidth	Antenna terminal (conducted)	--	99% Power bandwidth	1	1	passed
Transmitter Peak output power	Antenna terminal (conducted)	§15.247(b)(3)	1 Watt Peak	1	1	passed
Transmitter Peak output power radiated	Enclosure (radiated)	§15.247(b)(4)	< 1 Watt (EIRP) for antenna with directional gain less 6dBi	2	1	passed
Out-Of-Band RF- emissions Band-Edge emissions	Antenna terminal (conducted)	§15.247 (d)	20 dBc	1	1	passed
Power spectral density	Antenna terminal (conducted)	§15.247(e)	8dBm in any 3 kHz band	1	1	passed

General field strength emissions + restricted bands	Enclosure + Inter-connecting cables (radiated)	§ 15.247 (d) § 15.205 § 15.209	Emissions in restricted bands must meet the general field-strength radiated limits	2+3+4	1	passed
AC-Power Lines Conducted Emissions	AC-Power lines	§ 15.207	FCC § 15.107 class B limits § 15.207 limits	4	2	passed

Remark:
N/A: not applicable
NT: not tested

The current version of the Test Report TR6-0592-14-2-10a-C1 replaces the Test Report TR6-0592-14-2-10 dated 2015-04-28. The replaced Test report is herewith invalid.

.....
Dipl.-Ing. Ch. Lorenz
Responsible for test section

.....
Dipl.-Ing N. Perez
Responsible for test report

2. Administrative Data

2.1. Identification of the testing laboratory

Company name:	CETECOM GmbH
Address:	Im Teelbruch 116 45219 Essen - Kettwig Germany
Responsible for testing laboratory:	Dipl.-Ing. Rachid Acharkaoui
Deputy:	Dipl.-Ing. Niels Jeß

2.2. Test location

2.2.1. Test laboratory "CTC"

Company name:	see chapter 2.1. Identification of the testing laboratory
---------------	---

2.3. Organizational items

Project leader:	Dipl.-Ing C. Obert
Responsible for test report:	Dipl.-Ing N. Perez
Receipt of EUT:	2014-12-12
Date(s) of test:	2015-01-27 to 2015-03-05
Date of report:	2015-06-01

Version of template:	13.02

2.4. Applicant's details

Applicant's name:	ASCOM AB
Address:	Grimbodalen 2 SE-402 76 Göteborg Sweden
Contact person:	Lena Kindmark

2.5. Manufacturer's details

Manufacturer's name:	please see Applicant's details
Address:	please see Applicant's details

3. Equipment under test (EUT)

3.1. TECHNICAL DATA OF MAIN EUT DECLARED BY APPLICANT

3.1.1. 2.4GHZ MODE

Main function	Smartphone		
Type	SH1-ACAA		
Frequency range (US/Canada -bands)	2412 MHz (channel 1) to 2462 MHz (channel 11)		
Type of modulation	See chapter 3.2		
Number of channels (USA/Canada -bands)	1 to 11 (20MHz signal bandwidth)		
Antenna Type	<input checked="" type="checkbox"/> Integrated <input type="checkbox"/> External, no RF- connector <input type="checkbox"/> External, separate RF-connector		
Antenna Gain	Max. 0 dBi gain according applicants information in 2.4 GHz band		
Power supply	<input checked="" type="checkbox"/> DC, battery powered, Vnom=3.7V DC		
Special EMI components	--		
EUT sample type	<input type="checkbox"/> Production	<input checked="" type="checkbox"/> Pre-Production	<input type="checkbox"/> Engineering
FCC label attached	<input type="checkbox"/> yes	<input checked="" type="checkbox"/> no	

3.2. IEEE 802.11 OVERVIEW: MODULATION AND DATA RATES

The modulations and data rates defined for 802.11 b/g/n transmitters are identified in the table below. Also it shows which operational mode is possible for the device under test (EUT) according applicant's information.

802.11b-Mode (DSSS System)		
Data rate [Mbps]	Modulation type	Supported by EUT
1	DBPSK (Differential binary phase shift keying)	YES
2	DQPSK (Differential quadrature phase shift keying)	YES
5.5 / 11	CCK/PBCC (8-chip complementary code keying)	YES
22	ERP-PBCC (Packet binary convolutional coding)	YES

802.11g-Mode (OFDM system)		
Brutto data rate [Mbps]	Modulation type of subcarriers	Supported by EUT
6 / 9	BPSK	YES
12 / 18	QPSK	YES
24 / 36	16-QAM	YES
48 / 54	64-QAM	YES

Remark: 52 sub-carriers which can be modulated at different data-rates.

802.11n-Mode (OFDM)		
Brutto data rate [Mbps]	Modulation type	Supported by EUT
7.2/14.4/21.7/28.9/43.3/57.8/65/72.2 Mbps	HT20 (MCS0..MCS7)	YES

3.3. EUT: Type, S/N etc. and short descriptions used in this test report

Short description*)	EUT	Type	S/N serial number	HW hardware status	SW software status
EUT A	Cellular/Wi-Fi Smartphone	SH1-ACAA	T26105EB7Z	PF	myco-eng 4.4.2 daily_2014-12-11_eng daily_379_214-12-11 dev-keys
EUT B	Cellular/Wi-Fi Smartphone	SH1-ACAA	T26105EB77	PF	myco-eng 4.4.2 daily_2014-12-11_eng daily_379_214-12-11 dev-keys
EUT C	Cellular/Wi-Fi Smartphone	SH1-ACAA	T26105GL8N	PF	myco-eng 4.4.2 daily_2015-02-20_eng daily_448_2015-02-20 dev-keys
EUT D	Cellular/Wi-Fi Smartphone	SH1-ACAA	T26105EA0D	PF	myco-eng 4.4.2 daily_2014-12-11_eng daily_379_214-12-11 dev-keys

*) EUT short description is used to simplify the identification of the EUT in this test report.

3.4. Auxiliary Equipment (AE): Type, S/N etc. and short descriptions

AE short description *)	Auxiliary Equipment	Type	S/N serial number	HW hardware status	SW software status
AE 1	UNIFIVE AC/DC charger	UBX305-0510	E11-0087739	--	--
AE 2	USB cable	Highspeed USB 2.0 Type LL87003	--	--	--

*) AE short description is used to simplify the identification of the auxiliary equipment in this test report.

3.5. EUT set-ups

EUT set-up no. *)	Combination of EUT and AE	Remarks
set. 1	EUT A	Set-up for conducted tests
set. 2	EUT B + AE 1 + AE 2	Set-up for radiated tests
set. 3	EUT C + AE 1 + AE 2	Set-up for radiated tests
set. 4	EUT D + AE 1 + AE 2	Set-up for conducted emission tests

*) EUT set-up no. is used to simplify the identification of the EUT set-up in this test report.

3.6. EUT operating modes

EUT operating mode no. *)	Description of operating modes	Additional information
op. 1	Continuous TX, 2.4GHz Mode	Continuous traffic; WLAN 2.4GHz, BW 20MHz with special software version
op. 2	Normal TX, 2.4GHz Mode	unit associated to a router and continuously pinged by a client

*) EUT operating mode no. is used to simplify the test report.

The following power settings have been applied during tests:

Channel	gc value	Additional information
1	50	Additional setting necessary: PA off
6,7,8,9,10	58	Additional setting necessary: PA off
11	50	Additional setting necessary: PA off

3.7. Configuration of cables used for testing

Cable number	Item	Type	S/N serial number	HW hardware status	Cable length
Cable 1	USB-Cable	Highspeed USB 2.0 Type LL87003	--	--	1m

3.8. Test system set-up for conducted RF-measurement at antenna port

Specification: ANSI C63.10-2009

General Description: In order to avoid overload, the EUT's RF-signal is first attenuated before it is connected to the power meter. The specific attenuation is determined prior to the measurement within a set-up calibration. The power measurement is done either with a suitable power meter or a spectrum analyzer. The value is taken into account by correcting the measurement readings on the spectrum-analyzer either by a transducer factor (TDF) or an relative offset to reference level.

Schematic:

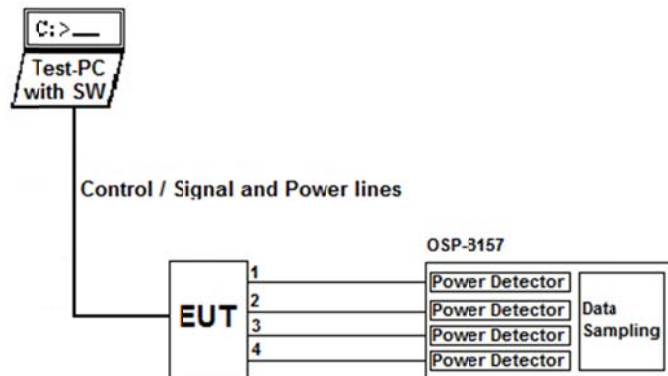

Testing method for MIMO devices:

. The measurements are performed by using R&S TS8997 (Ref.No. 693) test system which is able to perform measurements simultaneously and time-synchronized on maximum 4 antenna conducted RF-ports. A common trigger ensures the sampling time is minimized so the total power represents a sampling value calculated for all 4-ports simultaneously for each time bin/frame. A high data sampling rate together with a wide band power measurement capability ensures that latest modulation schemes are correctly measured.

Testing method for DTS-devices:

ANSI C63.10: 2013 Chapter 11.9.2.3.1+ FCC KDB DTS558074 latest version from June 2014

MIMO-Procedures:

If applicable KDB662911 v02r01, KDB662911 D02 v01

3.9. Test system set-up for radiated magnetic field measurements below 30 MHz

Specification: ANSI C63.4-2009 chapter 8.2.1, ANSI C63.10-2009 chapter 6.4

General Description: Evaluating the radiated field emissions are done first by an exploratory emission measurement and a final measurement for most critical frequencies determined.

The loop antenna was placed at 1 m height above ground plane and 3 m measurement distance from set-up for investigations. Because of reduced measurement distance, correction data were applied, as stated in chapter “General Limit - Radiated field strength emissions below 30 MHz“. The tests are performed in the semi anechoic room recognized by the regulatory commission.

Schematic:

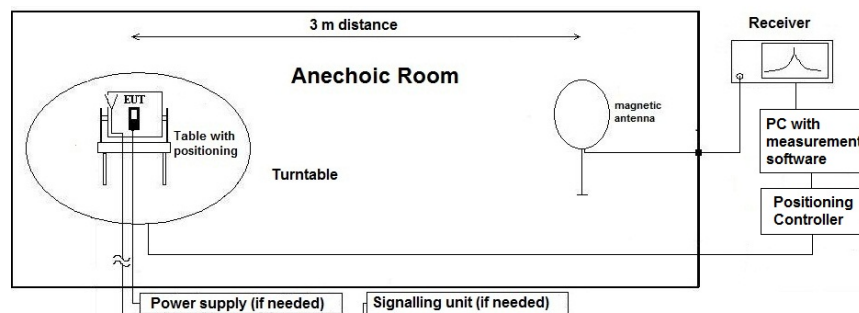

Testing method:

Exploratory, preliminary measurement

The EUT and its associated accessories are placed on a non-conductive position manipulator (tipping device) of 0.8 m height which is placed on the turntable. By rotating the turntable (step 90°, range 0° to 360°) and the EUT itself either on 3-orthogonal axis (portable equipment) or 2-orthogonal axis (defined operational position of EUT), the emission spectrum was recorded. The loop antenna was moved at least to 2-perpendicular axes (antenna vector in direction of EUT and parallel to EUT) in order to maximize the emissions. The results are documented in a diagram. Critical frequencies (low margin to limit) are saved within a data reduction table for further investigations. If various operating modes are supported, further investigations are made to find the worst-case. Also the interconnection cables and equipment position were varied in order to maximize the emissions.

Final measurement on critical frequencies

Based on the exploratory measurements, the most critical frequencies are re-measured by maintaining the EUT’s worst-case operation mode, cable position, etc.

First a frequency zoom around the critical frequency is done to locate the frequency more precisely. After this step, for all identified critical frequencies, the maximum peak was determined.

Following parameters were varied: the turntable angle continuously in the range 0 to 360 degree, the EUT itself either over 3-orthogonal axis (not defined usage position) or 2-orthogonal axis (defined usage position).

On the determined worst-case position, a final measurement with necessary bandwidth and detector according standard has been carried out.

Formula:

$$E_C = E_R + AF + C_L + D_F - G_A$$

$$M = L_T - E_C$$

- AF = Antenna factor
- C_L = Cable loss
- D_F = Distance correction factor
- E_C = Electrical field – corrected value
- E_R = Receiver reading
- G_A = Gain of pre-amplifier (if used)
- L_T = Limit
- M = Margin

All units are dB-units, positive margin means value is below limit.

Distance correction:

Reference for applied correction (extrapolating) factors:
 IEEC Transaction EMC, Vol. 47, No. 3, Aug. 2005, Journal Paper
 “Extrapolating Near-field emissions of low frequency loop transmitters”.

3.10. Test system set-up for radiated electric field measurement 30 MHz to 1 GHz

Specification: ANSI C63.4-2009 chapter 8, ANSI C63.10-2009 chapter 6.5

General Description: Evaluating the field emissions have to be done first by an exploratory emissions measurement and a final measurement for most critical frequencies. The tests are performed in a NSA-compliant semi anechoic room (SAR) recognized by the regulatory commissions.

Schematic:

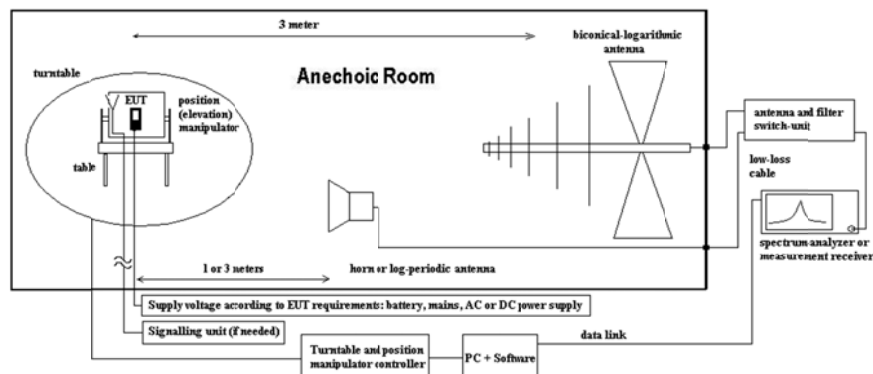

Testing method:

Exploratory, preliminary measurements

The EUT and its associated accessories are placed on a non-conductive position manipulator (tipping device) of 0.8 m height which is placed on the turntable. By rotating the turntable (range 0° to 360°, step 90°) and the EUT itself either on 3-orthogonal axis (portable equipment) or 2-orthogonal axis (defined operational position of EUT) the emission spectrum and its characteristics was recorded with an EMI-receiver, broadband antenna and software.

Measurement antenna: horizontal and vertical, heights: 1,0 m and 1,82 m as worst-case determined by an exploratory emission measurements. The results are documented in a diagram. Critical frequencies (low margin to limit) are saved within a table for further investigations. If various operating modes are supported, further investigations are made to find the worst-case of them. Also the interconnection cables and equipment position were varied in order to maximize the emissions.

Final measurement on critical frequencies

Based on the exploratory measurements, the most critical frequencies are re-measured by maintaining the EUT's worst-case operation mode, cable position, etc.

First a frequency zoom around the critical frequency is done to locate the frequency more precisely. After this step, for all identified critical frequencies, the maximum peak was determined.

Following parameters were varied: the turntable angle continuously in the range 0 to 360 degree, the EUT itself either over 3-orthogonal axis (not defined usage position) or 2-orthogonal axis (defined usage position). The measurement antenna height between 1 m and 4 m.

On the determined worst-case position, a final measurement with necessary bandwidth and detector according standard has been carried out.

Formula:

$$E_C = E_R + AF + C_L + D_F - G_A \quad (1)$$

$$M = L_T - E_C \quad (2)$$

- AF = Antenna factor
- C_L = Cable loss
- D_F = Distance correction factor (if used)
- E_C = Electrical field – corrected value
- E_R = Receiver reading
- G_A = Gain of pre-amplifier (if used)
- L_T = Limit
- M = Margin

All units are dB-units, positive margin means value is below limit.

3.11. Test system set-up for radiated electric field measurement above 1 GHz

Specification: ANSI C63.4-2009 chapter 8, ANSI C63.10-2009 chapter 6.6

General Description: Evaluating the field emissions have to be done first by an exploratory emissions measurement and a final measurement for most critical frequencies. The tests are performed in a CISPR 16-4 compliant fully anechoic room (FAR) recognized by the regulatory commissions. The measurement distance was set to 3 meter for frequencies up to 18 GHz and 2 meter above 18 GHz. A bicon-log or horn antenna is used for frequency range 1 GHz to 40 GHz. Due to use of a fully anechoic room the measurement antennas are set to fixed antenna height of 1.55 m and the site validation criteria accord. CISPR 16-1-4:2010, Chapter 8.3 is fulfilled. The EUT is aligned within 3 dB beamwidth of the measurement antenna, on big EUTs several surface measurements are performed.

Schematic:

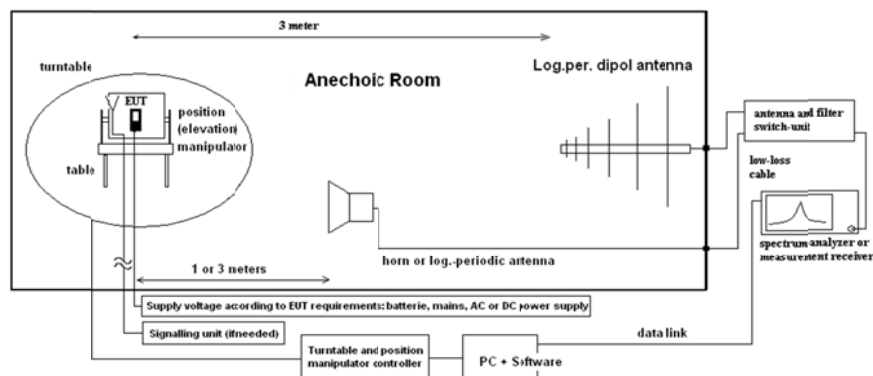

Testing method:

Exploratory, preliminary measurements

The EUT and its associated accessories are placed on a non-conductive position manipulator (tipping device) of 1.55 m height which is placed on the turntable. By rotating the turntable (range 0° to 360°, step 15°) and the EUT itself either on 3-orthogonal axis (portable equipment) or 2-orthogonal axis (defined operational position of EUT) the emission spectrum and its characteristics was recorded with an EMI-receiver, broadband antenna and software.

The measurements are performed in horizontal and vertical polarization of the measurement antennas. The results are documented in a diagram. Critical frequencies (low margin to limit) are saved within a table for further investigations. If various operating modes are supported, further investigations are made to find the worst-case of them. Also the interconnection cables and equipment position were varied in order to maximize the emissions.

Final measurement on critical frequencies

Based on the exploratory measurements, the most critical frequencies are re-measured by maintaining the EUT's worst-case operation mode, cable position, etc.

First a frequency zoom around the critical frequency is done to locate the frequency more precisely. After this step, for all identified critical frequencies, the maximum peak was determined.

Following parameters were varied: the turntable angle continuously in the range 0 to 360 degree, the EUT itself either over 3-orthogonal axis (not defined usage position) or 2-orthogonal axis (defined usage position). The measurement antenna height is fixed to 1.55 m.

On the determined worst-case position, a final measurement with necessary bandwidth and detector according standard has been carried out.

Formula:

$$E_C = E_R + AF + C_L + D_F - G_A \quad (1)$$

$$M = L_T - E_C \quad (2)$$

E_C = Electrical field – corrected value

E_R = Receiver reading

M = Margin

L_T = Limit

AF = Antenna factor

C_L = Cable loss

D_F = Distance correction factor (if used)

G_A = Gain of pre-amplifier (if used)

All units are dB-units, positive margin means value is below limit.

4. Measurements

4.1. RF-Parameter conducted - 6 dB Bandwidth and 99% Occupied Bandwidth

4.1.1. Test location and equipment (for reference numbers please see chapter 'List of test equipment')

test site	<input type="checkbox"/> 441 EMI SAR	<input type="checkbox"/> 348 EMI cond.	<input type="checkbox"/> 443 EMI FAR	<input checked="" type="checkbox"/> 347 Radio.lab.	<input type="checkbox"/> 337 OATS	<input type="checkbox"/>
spectr. analys.	<input type="checkbox"/> 584 FSU	<input checked="" type="checkbox"/> 120 FSEM	<input type="checkbox"/> 264 FSEK	<input checked="" type="checkbox"/> 489 ESU	<input type="checkbox"/>	<input type="checkbox"/>
attenuator	<input type="checkbox"/> 530 10 dB	<input type="checkbox"/>	<input type="checkbox"/>	<input type="checkbox"/>	<input type="checkbox"/>	<input type="checkbox"/>
signaling	<input type="checkbox"/> 392 MT8820A	<input type="checkbox"/> 436 CMU	<input type="checkbox"/> 547 CMU			
DCpower	<input checked="" type="checkbox"/> 463 Power source	<input type="checkbox"/> 087 EA3013	<input type="checkbox"/> 354 NGPE 40	<input type="checkbox"/> 086 LNG50-10	<input type="checkbox"/>	<input type="checkbox"/>
Power supply voltage	<input type="checkbox"/> 230 V 50 Hz via public mains		<input type="checkbox"/> 060 110 V 60 Hz via PAS 5000			
Others	<input checked="" type="checkbox"/> 530 10dB Attenuator		<input checked="" type="checkbox"/> cable K5			

4.1.2. Test condition and measurement test set-up

link to test system (if used):	<input type="checkbox"/> air link	<input checked="" type="checkbox"/> cable connection	<input type="checkbox"/>
Climatic conditions	Temperature: (22±3°C)		Rel. humidity: (40±20)%

4.1.3. References of occupied and emission bandwidth

FCC	<input checked="" type="checkbox"/> §15.247(a)(2)
ANSI	<input checked="" type="checkbox"/> ANSI 63.10:2009

(1) *Frequency hopping systems shall have hopping channel carrier frequencies separated by a minimum of 25 kHz or the 20 dB bandwidth of the hopping channel, whichever is greater. Alternatively, frequency hopping systems operating in the 2400-2483.5 MHz band may have hopping channel carrier frequencies that are separated by 25 kHz or two-thirds of the 20 dB bandwidth of the hopping channel, whichever is greater, provided the systems operate with an output power no greater than 125 mW.*

(2) *DSSS Systems using digital modulation techniques may operate in the 902-928 MHz, 2400-2483.5 MHz, and 5725-5850 MHz bands. The minimum 6 dB bandwidth shall be at least 500 kHz.*

4.1.4. EUT Settings:

The EUT was instructed to send with maximum power (if adjustable) according applicants instructions. Different modulation characteristics have been checked, e.g. data rates which EUT can operate.

4.1.5. Measurement method:

Three carrier frequencies (low/middle/high) were used for showing the compliance with this requirement. A DELTA Marker method was set to measure the bandwidth compared to the highest In-Band power. The operating modes have been varied (e.g. data rate, modulation scheme, etc.). If applicable the hopping-mode is switched off.

Also the **99% emission bandwidth** was measured. Two markers are placed on frequency points such that left to lower f-marker and right to higher f-marker only 1% of the TX-power is contained. Between the markers, 99% of the power is laying. The RBW value is readjusted and the measurement repeated until the RBW/EBW ratio is around 1%.

4.1.6. Spectrum-Analyzer settings:

Span	Set as to fully display the emissions + 30%
Scale y display	approximate 30dB below the maximum PEAK level
Resolution Bandwidth (RBW)	<input type="checkbox"/> ANSI 63.10:2009 Set to initial value approx 1% to 5% of the emission bandwidth, re-adjust and proof that RBW/EBW is between 1% and 5% <input checked="" type="checkbox"/> KDB558074V03
Video Bandwidth (VBW)	Minimum 3 times the resolution bandwidth
Sweep time	Auto -coupled
Detector	Peak detector
Sweep mode	Repetitive Mode, MAX-HOLD, trace stabilization

4.1.7. Results:

For graphical results pls. see annex 4 to this test report.

6dB BANDWIDTH:

Set-up no.: 1 Op. Mode: 1	6dB BANDWIDTH [MHz]		
T _{NOM} =21°C, V _{NOM} = 3V	Low channel = 1 (2412 MHz)	Middle channel = 6 (2437 MHz)	High channel = 11 (2462 MHz)
Measured Level b-Mode @1Mbps	10.12	10.11	10.08
Measured Level g-Mode @6Mbps	16.57	16.63	16.61
Measured Level n-Mode @MCS0	17.66	17.76	17.81
Maximum value	17.66	17.76	17.81

Remark: 1.) see extract of diagrams and results for different modulation types(Data rates) in separate document A4

Additional also the 99% occupied bandwidth were measured for worst-case 6dB bandwidth.

99% OCCUPIED BANDWIDTH:

Set-up no.: 1 Op. Mode: 1	99% Bandwidth [MHz]		
T _{NOM} =21°C, V _{NOM} = 3V	Low channel = 1 (2412 MHz)	Middle channel = 6 (2437 MHz)	High channel = 11 (2462 MHz)
Measured Level b-Mode @1Mbps	12.24	12.22	12.18
Measured Level g-Mode @6Mbps	16.40	16.40	16.39
Measured Level n-Mode @MCS0	17.58	17.58	17.58
Maximum value	17.58	17.58	17.58

Remark:

VERDICT: DTS system requirements according §15.247 (BW > 500kHz) fulfilled

4.2. RF-Parameter conducted: Maximum peak output power

4.2.1. Test location and equipment (for reference numbers please see chapter 'List of test equipment')

test location	<input checked="" type="checkbox"/> CETECOM Essen (Chapter. 2.2.1)	<input type="checkbox"/> 443 System CTC-FAR-EMI-	<input type="checkbox"/> Please see Chapter. 2.2.3			
test site	<input type="checkbox"/> 441 EMI SAR	<input type="checkbox"/> 487 SAR NSA	<input checked="" type="checkbox"/> 347 Radio.lab.			
receiver	<input type="checkbox"/> 377 ESCS30	<input type="checkbox"/> 001 ESS	<input type="checkbox"/> 489 ESU 40	<input checked="" type="checkbox"/> 693 TS8997		
spectr. analys.	<input type="checkbox"/> 584 FSU	<input type="checkbox"/> 120 FSEM	<input type="checkbox"/> 264 FSEK	<input checked="" type="checkbox"/> 489 ESU 40		
antenna	<input type="checkbox"/> 574 BTA-L	<input type="checkbox"/> 133 EMCO3115	<input type="checkbox"/> 302 BBHA9170	<input type="checkbox"/> 289 CBL 6141	<input type="checkbox"/> 030 HFH-Z2	<input type="checkbox"/> 477 GPS
signaling	<input type="checkbox"/> 392 MT8820A	<input type="checkbox"/> 436 CMU	<input type="checkbox"/> 547 CMU			
otherwise	<input type="checkbox"/> 400 FTC40x15E	<input type="checkbox"/> 401 FTC40x15E	<input type="checkbox"/> 110 USB LWL	<input type="checkbox"/> 482 Filter Matrix	<input type="checkbox"/> 378 RadiSense	
DC power	<input type="checkbox"/> 456 EA 3013A	<input checked="" type="checkbox"/> 463 HP3245A	<input type="checkbox"/> 459 EA 2032-50	<input type="checkbox"/> 268 EA- 3050	<input type="checkbox"/> 494 AG6632A	<input type="checkbox"/> 498 NGPE 40
otherwise	<input type="checkbox"/> 331 HC 4055	<input checked="" type="checkbox"/> 248 6 dB Attenuator	<input type="checkbox"/> 529 Power divider	<input type="checkbox"/> - cable OTA20		
	<input type="checkbox"/> 613 20dB Attenuator		<input checked="" type="checkbox"/> K 4 Cable kit			
line voltage	<input type="checkbox"/> 230 V 50 Hz via public mains	<input type="checkbox"/> 060 110 V 60 Hz via PAS 5000				

4.2.2. References:

FCC	<input checked="" type="checkbox"/> §15.247(b)(3)
ANSI	<input checked="" type="checkbox"/> ANSI 63.10:2009

The maximum peak conducted output power of the intentional radiator shall not exceed the following:

(1) For frequency hopping systems (FHSS) operating in the 2400-2483.5 MHz band employing at least 75 non-overlapping hopping channels, and all frequency hopping systems in the 5725-5850 MHz band: 1 watt. For all other frequency hopping systems in the 2400-2483.5 MHz band: 0.125 watts.

(2) For frequency hopping systems operating in the 902-928 MHz band: 1 watt for systems employing at least 50 hopping channels; and, 0.25 watts for systems employing less than 50 hopping channels, but at least 25 hopping channels, as permitted under paragraph (a)(1)(i) of this section.

(3) For systems using digital modulation (DSSS) in the 902-928 MHz, 2400-2483.5 MHz, and 5725-5850 MHz bands: 1 Watt. As an alternative to a peak power measurement, compliance with the one Watt limit can be based on a measurement of the maximum conducted output power. Maximum Conducted Output Power is defined as the total transmit power delivered to all antennas and antenna elements averaged across all symbols in the signalling alphabet when the transmitter is operating at its maximum power control level. Power must be summed across all antennas and antenna elements. The average must not include any time intervals during which the transmitter is off or is transmitting at a reduced power level. If multiple modes of operation are possible (e.g., alternative modulation methods), the maximum conducted output power is the highest total transmit power occurring in any mode.

(4) The conducted output power limit specified in paragraph (b) of this section is based on the use of antennas with directional gains that do not exceed 6 dBi. Except as shown in paragraph (c) of this section, if transmitting antennas of directional gain greater than 6 dBi are used, the conducted output power from the intentional radiator shall be reduced below the stated values in paragraphs (b)(1), (b)(2), and (b)(3) of this section, as appropriate, by the amount in dB that the directional gain of the antenna exceeds 6 dBi.

4.2.3. EUT settings:

The EUT was instructed to send with maximum power (if adjustable) according applicants instructions. Different modulation characteristics have been checked, e.g. data rates which EUT can operate.

4.2.4. Measurement method and analyzer settings:

The measurement was performed in non-hopping transmission mode with the carrier set to lowest/middle and highest channel. The power was also checked for different data rates, modulation scheme or packet types if applicable.

MEASUREMENT METHOD/ SPECTRUM-ANALYZER SETTINGS:

Measurement Method ¹⁾	§15.247(b) (3) Maximum Peak	1.) <input type="checkbox"/> PK1-Method (§5.2.1.1): RBW > 6dB-bandwidth of the signal, ANSI 63.10: 2009, chapter 6.10.2.1a 2.) <input type="checkbox"/> PK2-Method (§5.2.1.2): Channel integration method (ANSI 63.10:2009) 3.) <input checked="" type="checkbox"/> PK power meter method
	§15.247(b) (3) Maximum Average	4.) <input type="checkbox"/> AVG1 - power averaging over EBW + integrated band power measurement 5.) <input type="checkbox"/> AVG2 - trace averaging over EBW + integrated band power measurement 6.) <input type="checkbox"/> RMS power meter method
Center Frequency	Nominal channel frequency	
Span	30% higher then the EBW measured before	
Resolution Bandwidth (RBW)	1MHz	
Video Bandwidth (VBW)	3MHz	
Sweep time	coupled	
Detector	Peak, Max hold mode for method PK1/PK2 or RMS and trace average for method AVG1/AVG2	
Sweep Mode	Repetitive mode, allow trace to stabilize	
Analyzer-Mode	<input type="checkbox"/> normal <input type="checkbox"/> activated channel integration method with limits set to the EBW of the signal	

Remark 1: guidance 558074 D01 measurement DTS guidance V03

APPLICANT’S DECLARED ANTENNA CHARACTERISTICS:

- Directional Gain < 6 dBi (measured: difference between measured conducted and radiated eirp. power)
- Directional Gain > 6 dBi (measured / applicant’s declaration) -> conducted power reduction necessary

- Maximum declared antenna gain [isotropic]: 0dBi for Channel 6 (2437MHz)

4.2.5. Antenna gain verification

Gain (conducted power – radiated EIRP) [dBi]	
Set-up no: 2 Op-Mode: 1	Channel 6, 2437MHz
Conducted average power [dBm]	15.85
Average EIRP [dBm]	13.98
Gain [dBi]	-1.87

Remark: Gain verification only worst case channel and worst case modulation was performed

4.2.6. RESULTS

Different modulation types and data rates were tested in order to find the maximum peak conducted output power. **Enclosed are only the maximum values for each modulation format**, pls. compare separate document A4 for all results.

MAX POWER (conducted) [dBm]			
Set-up no: 1 Op-Mode: 1	Low channel = 1 (2412 MHz)	Middle channel = 6 (2437 MHz)	High channel = 11 (2462 MHz)
Measured Level b-Mode	17.78	17.41	17.04
Measured Level g-Mode	14.18	17.08	12.90
Measured Level n-Mode	14.22	17.29	13.16
Maximum Level	17.78	17.41	17.04
Limit	1 Watt (30dBm) Peak		

Remark:

- 1.) External Path Loss -> set as either as correction factor in spectrum-analyzer or activated as transducer table
- 2.) at this place only each maximum power reported, pls. compare separate annex 4 for more details
- 3.) maximum value among all data rates and modulations, pls. compare separate annex 4 for more details

VERDICT: Maximum value of 17.78dBm Peak (60mW) -> passed

4.3. RF-Parameter conducted - Power Spectral Density

4.3.1. Test location and equipment (for reference numbers please see chapter 'List of test equipment')

test location	<input checked="" type="checkbox"/> CETECOM Essen (Chapter. 2.2.1)	<input type="checkbox"/> Please see Chapter. 2.2.2	<input type="checkbox"/> Please see Chapter. 2.2.3
test site	<input type="checkbox"/> 441 EMI SAR	<input type="checkbox"/> 487 SAR NSA	<input type="checkbox"/> 337 OATS
receiver	<input type="checkbox"/> 377 ESCS30	<input type="checkbox"/> 001 ESS	<input checked="" type="checkbox"/> 489 ESU
spectr. analys.	<input type="checkbox"/> 489 ESU	<input type="checkbox"/> 120 FSEM	<input type="checkbox"/> 264 FSEK
power supply	<input type="checkbox"/> 456 EA 3013A	<input type="checkbox"/> 457 EA 3013A	<input type="checkbox"/> 463
otherwise	<input checked="" type="checkbox"/> 630 10dB Attenuator		<input checked="" type="checkbox"/> cable K4

4.3.2. REFERENCES:

FCC	<input checked="" type="checkbox"/> §15.247(e)
ANSI	<input checked="" type="checkbox"/> ANSI 63.10:2009

(e) For digitally modulated systems, the power spectral density conducted from the intentional radiator to the antenna shall not be greater than 8 dBm in any 3 kHz band during any time interval of continuous transmission. This power spectral density shall be determined in accordance with the provisions of paragraph (b) of this section. The same method of determining the conducted output power shall be used to determine the power spectral density.

4.3.3. EUT SETTINGS:

The EUT was instructed to send with maximum power (if adjustable) according applicants instructions. Different modulation characteristics have been checked, e.g. data rates which EUT can operate.

4.3.4. Measurement Method/ Spectrum-Analyzer Settings:

The method is according in ANSI63.10:2009, chapter 6.11.2.3/6.11.2.4 or chapter 5.3 of document guidance 558074 D01 measurement DTS guidance V01

Measurement Method	<input type="checkbox"/> ANSI 63.10:2009	<input type="checkbox"/> PKPSD-Method <input type="checkbox"/> AVGPSD Method
	<input checked="" type="checkbox"/> guidance 558074 D01 measurement DTS guidance V03	
Center Frequency	Nominal channel frequency	
Span	5..30% higher then the EBW measured before	
Resolution Bandwidth (RBW)	100 kHz	
Video Bandwidth (VBW)	>300 kHz	
Sweep time	coupled	
Detector	Peak, Max hold mode for method PKPSD or RMS method AVGPSD	
Sweep Mode	Repetitive mode, allow trace to stabilize (PKPSD) or single (AVGPSD)	
Bandwidth correction factor	10*Log(3kHz/100kHz)= -15.2	
Addiction correction factors	external measuring set-up path-loss	

Remark 1: guidance 558074 D01 measurement DTS guidance V03

4.3.5. RESULTS

Set-up no.: 1 Op. Mode: 1	POWER SPECTRAL DENSITY [dBm/3 kHz]		
	Low channel = 1 (2412 MHz)	Middle channel = 6 (2437 MHz)	High channel = 11 (2462 MHz)
Measured Level b-Mode	-5.17	-5.89	-6.42
Measured Level g-Mode	-3.66	-10.70	-5.29
Measured Level n-Mode	-4.54	-11.19	-4.39
Maximum Level	-3.66	-5.89	-4.39
Limit	< 8dBm/3 kHz		

Remark: see diagrams for details on frequency in separate annex A4

4.3.6. VERDICT: pass

4.4. RF-Parameter conducted - 20 dBc power specification

4.4.1. Test location and equipment (for reference numbers please see chapter 'List of test equipment')

test location	<input checked="" type="checkbox"/> CETECOM Essen (Chapter. 2.2.1)	<input checked="" type="checkbox"/> 443 System CTC-FAR-EMI-	<input type="checkbox"/> Please see Chapter. 2.2.3
test site	<input type="checkbox"/> 441 EMI SAR	<input type="checkbox"/> 487 SAR NSA	<input type="checkbox"/> 337 OATS
receiver	<input type="checkbox"/> 377 ESCS30	<input type="checkbox"/> 001 ESS	<input checked="" type="checkbox"/> 489 ESU
spectr. analys.	<input type="checkbox"/> 489 ESU	<input type="checkbox"/> 120 FSEM	<input type="checkbox"/> 264 FSEK
power supply	<input type="checkbox"/> 456 EA 3013A	<input type="checkbox"/> 457 EA 3013A	<input type="checkbox"/> 459 EA 2032-50
otherwise	<input checked="" type="checkbox"/> 630 10 dB Attenuator	<input checked="" type="checkbox"/> cable K4	<input type="checkbox"/> 268 EA- 3050
		<input type="checkbox"/> 494 AG6632A	<input type="checkbox"/> 498 NGPE 40

4.4.2. Reference: §15.247, §15.205, RSS-210: A8.5

FCC	<input checked="" type="checkbox"/> §15.247	<i>(d) In any 100 kHz bandwidth outside the frequency band in which the spread spectrum or digitally modulated intentional radiator is operating, the radio frequency power that is produced by the intentional radiator shall be at least 20 dB below that in the 100 kHz bandwidth within the band that contains the highest level of the desired power,</i>
ANSI	<input checked="" type="checkbox"/> ANSI 63.10:2009	

4.4.3. EUT settings:

For FHHS-systems hopping mode was switched-off so fixed three different channels could be measured. The EUT was instructed to send with maximum power (if adjustable) according to applicants instructions.

4.4.4. Measurement method:

The frequency spectrum was investigated for **conducted** spurious emissions values lower than 20dB related to the RF-carrier power value. Three carrier frequencies (low/middle/high channel) were used for showing the compliance with this requirement. First a In-Band Reference level measurement of the carrier was performed. The video bandwidth (VBW) was chosen 10 times the resolution bandwidth (RBW). The frequency scan was up to 10 times the highest channel frequency within the operational mode. The spectrum-analyzer was set to MAX-PEAK Detector, MAX-Hold Mode, trace stabilisation or long sweep time depending of the TX off-time of the EUT.

4.4.5. Table of Measurement results:

4.4.5.1. b-mode

Set-up no.: 1	RF-Conducted test: 20 dBc spurious emissions					
Op-Mode: 1	Low channel =1 (2402 MHz) Level Reference (In-Band)= 114.96dBµV /m Limit=94.96dBµV /m		Middle channel = 6 (2441 MHz) Level Reference (In-Band) = 114.81dBµV /m Limit= 94.81dBµV /m		High channel = 11 (2480 MHz) Level Reference (In-Band)= 114.24 dBµV /m Limit=94.24dBµV /m	
Frequency Range	Frequency [MHz]	Value [dBc]	Frequency [MHz]	Value [dBc]	Frequency [MHz]	Value [dBc]
30 to 1000 MHz	noise floor, no relevant peaks found	-	noise floor, no relevant peaks found		noise floor, no relevant peaks found	
1.0 to 2.8 GHz						
2.8 to 18 GHz	noise floor, no relevant peaks found	-	noise floor, no relevant peaks found		noise floor, no relevant peaks found	
18 to 25 GHz						
Band-Edge	2400	-30.30	--		2486	-39.53

Remark: see diagrams in separate document A4

The limit on the diagrams is 30dB under the reference level (on average output power) measured In-Band for each channel

4.4.5.2. g-mode

Set-up no.: 1 Op-Mode: 1	RF-Conducted test: 20 dBc spurious emissions					
Frequency Range	Low channel =1 (2402 MHz) Level Reference (In-Band)= 106.35dB μ V /m Limit=86.35dB μ V /m		Middle channel = 6 (2441 MHz) Level Reference (In-Band) = 110.35dB μ V /m Limit= 90.35dB μ V /m		High channel = 11 (2480 MHz) Level Reference (In-Band)= 106.42dB μ V /m Limit=86.42dB μ V /m	
	Frequency [MHz]	Value [dBc]	Frequency [MHz]	Value [dBc]	Frequency [MHz]	Value [dBc]
30 to 1000 MHz	noise floor, no relevant peaks found	-	noise floor, no relevant peaks found		noise floor, no relevant peaks found	
1.0 to 2.8 GHz						
2.8 to 18 GHz	noise floor, no relevant peaks found	-	noise floor, no relevant peaks found		noise floor, no relevant peaks found	
18 to 25 GHz						
Band-Edge	2399	-31.52	--		2484	-41.11

Remark: see diagrams in separate document A4

The limit on the diagrams is 20dB under the reference level measured In-Band for each channel

4.4.5.3. n-mode

Set-up no.: 1 Op-Mode: 1	RF-Conducted test: 20 dBc spurious emissions					
Frequency Range	Low channel =1 (2402 MHz) Level Reference (In-Band)= 105.4dB μ V /m Limit=85.4dB μ V /m		Middle channel = 6 (2441 MHz) Level Reference (In-Band) = 110.55 dB μ V /m Limit= 90.55dB μ V /m		High channel = 11 (2480 MHz) Level Reference (In-Band)= 106.36dB μ V /m Limit=86.36dB μ V /m	
	Frequency [MHz]	Value [dBc]	Frequency [MHz]	Value [dBc]	Frequency [MHz]	Value [dBc]
30 to 1000 MHz	noise floor, no relevant peaks found	-	noise floor, no relevant peaks found		noise floor, no relevant peaks found	
1.0 to 2.8 GHz						
2.8 to 18 GHz	noise floor, no relevant peaks found	-	noise floor, no relevant peaks found		noise floor, no relevant peaks found	
18 to 25 GHz						
Band-Edge	2400	-29.69			2486	-39.20

Remark: see diagrams in separate document A1

The limit on the diagrams is 20dB under the reference level measured In-Band for each channel

4.4.6. Test result: passed

4.5. General Limit - Conducted emissions on AC-Power lines

4.5.1. Test location and equipment

test location	<input checked="" type="checkbox"/> CETECOM Essen (Chapter 2.2.1)	<input type="checkbox"/> Please see Chapter 2.2.2	<input type="checkbox"/> Please see Chapter 2.2.3
test site	<input type="checkbox"/> 333 EMI field	<input checked="" type="checkbox"/> 348 EMI cond.	
receiver	<input type="checkbox"/> 001 ESS	<input checked="" type="checkbox"/> 377 ESCS 30	<input type="checkbox"/> 489 ESU 40 <input type="checkbox"/> 620 ESU 26
LISN	<input checked="" type="checkbox"/> 005 ESH2-Z5	<input type="checkbox"/> 007 ESH3-Z6	<input type="checkbox"/> 300 ESH3-Z5 & 50Ω used for AE <input type="checkbox"/> no LISN for AE
signaling	<input type="checkbox"/> 392 MT8820A	<input type="checkbox"/> 436 CMU	<input type="checkbox"/> 547 CMU <input type="checkbox"/> 594 CMW
line voltage	<input type="checkbox"/> 230 V 50 Hz via public mains <input checked="" type="checkbox"/> 060 120 V 60 Hz via PAS 5000		

4.5.2. Requirements

FCC		Part 15, Subpart B, §15.207	
ANSI		C63.10-2009, Chapter 6.2	
Limit	Frequency [MHz]	QUASI-Peak [dBµV]	AVERAGE [dBµV]
	0.15 – 0.5	66 to 56*	56 to 46*
	0.5 – 5	56	46
	5 – 30	60	50

Remark: * decreases with the logarithm of the frequency

4.5.3. Test condition and test set-up

Signal link to test system (if used):		<input checked="" type="checkbox"/> air link	<input type="checkbox"/> cable connection	<input type="checkbox"/>
EUT-grounding		<input checked="" type="checkbox"/> none	<input type="checkbox"/> with power supply	<input type="checkbox"/> additional connection
Equipment set up		<input checked="" type="checkbox"/> table top (40 cm distance to reference ground plane (wall))		<input type="checkbox"/> floor standing EUT stands isolated on reference ground plane (floor)
Climatic conditions		Temperature: (22±3°C)		Rel. humidity: (40±20)%
EMI-Receiver or Analyzer settings	Scan data	<input type="checkbox"/> 9 – 150 kHz, RBW = 200 Hz, Step = 61 Hz <input checked="" type="checkbox"/> 150 kHz – 30 MHz RBW = 9 kHz, Step = 4 kHz <input type="checkbox"/> other:		
	Scan-Mode	6 dB EMI-Receiver Mode		
	Pre-measurement Final measurement	Peak detector, Repetitive-Scan, max-hold, sweep-time 50 µs per frequency point Average & Quasi-peak detector at critical frequencies		
General measurement procedures		Please see chapter “Test system set-up for AC power line conducted emissions measurements”		

4.5.4. Measurement results

The results are presented below in summary form only. For more information please see the diagrams

EUT set-up no.:4			Op.-mode 2		
Diagram No.	EUT operating mode no. or comment	Used Detector	Power line	Additional (scan-) information or remarks	Result
1.04	2	<input checked="" type="checkbox"/> Peak (pre-scan) <input checked="" type="checkbox"/> CAV (final) <input checked="" type="checkbox"/> QP (final)	L1/ N	Ping method	passed

4.6. General Limit - Radiated field strength emissions below 30 MHz

4.6.1. Test location and equipment

test location	<input checked="" type="checkbox"/> CETECOM Essen (Chapter. 2.2.1)	<input type="checkbox"/> Please see Chapter. 2.2.2	<input type="checkbox"/> Please see Chapter. 2.2.3
test site	<input checked="" type="checkbox"/> 441 EMI SAR	<input type="checkbox"/> 487 SAR NSA	<input type="checkbox"/> 347 Radio.lab.
receiver	<input type="checkbox"/> 377 ESCS30	<input checked="" type="checkbox"/> 001 ESS	<input type="checkbox"/>
spectr. analys.	<input type="checkbox"/> 584 FSU	<input type="checkbox"/> 120 FSEM	<input type="checkbox"/> 264 FSEK
antenna	<input type="checkbox"/> 574 BTA-L	<input type="checkbox"/> 133 EMCO3115	<input type="checkbox"/> 302 BBHA9170
signaling	<input type="checkbox"/> 392 MT8820A	<input type="checkbox"/> 371 CBT32	<input type="checkbox"/> 547 CMU
otherwise	<input type="checkbox"/> 357 NRV-Z1	<input type="checkbox"/> 600 NRVD	<input type="checkbox"/> 110 USB LWL
DC power	<input type="checkbox"/> 456 EA 3013A	<input type="checkbox"/> 457 EA 3013A	<input type="checkbox"/> 459 EA 2032-50
line voltage	<input type="checkbox"/> 230 V 50 Hz via public mains	<input checked="" type="checkbox"/> 060 120 V 60 Hz via PAS 5000	<input type="checkbox"/> 289 CBL 6141
			<input checked="" type="checkbox"/> 030 HFH-Z2
			<input type="checkbox"/> 477 GPS
			<input type="checkbox"/> 594 CMW
			<input type="checkbox"/> 482 Filter Matrix
			<input type="checkbox"/> 378 RadiSense
			<input type="checkbox"/> 494 AG6632A
			<input type="checkbox"/> 498 NGPE 40

4.6.2. Requirements

FCC	Part 15, Subpart C, §15.205 & §15.209			
ANSI	C63.10-2009			
Frequency [MHz]	Field strength limit		Distance [m]	Remarks
	[µV/m]	[dBµV/m]		
0.009 – 0.490	2400/f (kHz)	67.6 – 20Log(f) (kHz)	300	Correction factor used due to measurement distance of 3 m
0.490 – 1.705	24000/f (kHz)	87.6 – 20Log(f) (kHz)	30	Correction factor used due to measurement distance of 3 m
1.705 – 30	30	29.5	30	Correction factor used due to measurement distance of 3 m

4.6.3. Test condition and test set-up

Signal link to test system (if used):	<input type="checkbox"/> air link	<input type="checkbox"/> cable connection	<input checked="" type="checkbox"/> none
EUT-grounding	<input checked="" type="checkbox"/> none	<input type="checkbox"/> with power supply	<input type="checkbox"/> additional connection
Equipment set up	<input checked="" type="checkbox"/> table top		<input type="checkbox"/> floor standing
Climatic conditions	Temperature: (22±3°C)		Rel. humidity: (40±20)%
EMI-Receiver or Analyzer Settings	Scan data	<input checked="" type="checkbox"/> 9 – 150 kHz RBW/VBW = 200 Hz Scan step = 80 Hz <input checked="" type="checkbox"/> 150 kHz – 30 MHz RBW/VBW = 9 kHz Scan step = 4 kHz <input type="checkbox"/> other:	
	Detector Mode: Sweep-Time	<input checked="" type="checkbox"/> 6 dB EMI-Receiver Mode <input type="checkbox"/> 3dB Spectrum analyser Mode Peak (pre-measurement) and Quasi-PK/Average (final if applicable) Repetitive-Scan, max-hold Coupled – calibrated display if continuous signal otherwise adapted to EUT’s individual transmission duty-cycle	
General measurement procedures	Please see chapter “Test system set-up radiated magnetic field measurements below 30 MHz”		

4.6.4. Measurement Results

Table of measurement results:

Diagram No.	Carrier Channel		Frequency range	Set-up no.	OP-mode no.	Remark	Used detector			Result
	Range	No.					PK	AV	QP	
2.01	Low	1	9 kHz-30 MHz	1	1	No critical frequencies found	<input checked="" type="checkbox"/>	<input type="checkbox"/>	<input type="checkbox"/>	passed
2.01	Middle	2	9 kHz-30 MHz	1	1	No critical frequencies found	<input checked="" type="checkbox"/>	<input type="checkbox"/>	<input type="checkbox"/>	passed
2.03	High	3	9 kHz-30 MHz	1	1	No critical frequencies found	<input checked="" type="checkbox"/>	<input type="checkbox"/>	<input checked="" type="checkbox"/>	passed

4.6.5. Correction factors due to reduced meas. distance (f < 30 MHz)

The used correction factors when the measurement distance is reduced, are taken from IIEC Transaction EMC, Vol 47, No.3, Aug. 2005, Journal Paper “*EXTRAPOLATING NEAR-FIELD EMISSIONS OF LOW-FREQUENCY LOOP TRANSMITTERS*”.

Used Transducer factors (f < 30 MHz)					
1	2	3	4	5	6
Frequency	Antenna factor	Corection factor		Cable loss	Transducer factor
kHz	dB μ V/m	300m to 3m	30m to 3m	dB	dB μ V/m
9,0	20,0	-116,7		0,0	-96,7
10,6	20,0	-116,7		0,0	-96,7
12,6	20,0	-116,7		0,0	-96,7
14,8	20,0	-116,7		0,0	-96,7
17,5	20,0	-116,6		0,0	-96,6
20,7	20,0	-116,6		0,0	-96,6
24,4	20,0	-116,6		0,0	-96,6
28,9	20,0	-116,6		0,0	-96,6
34,1	20,0	-116,5		0,0	-96,5
40,3	20,0	-116,4		0,0	-96,4
47,6	20,0	-116,3		0,0	-96,3
56,2	20,0	-116,2		0,0	-96,2
66,4	20,0	-116,0		0,0	-96,0
78,4	20,0	-115,8		0,0	-95,8
92,7	20,0	-115,4		0,0	-95,4
109,4	20,0	-115,0		0,0	-95,0
129,3	20,0	-114,5		0,0	-94,5
152,7	20,0	-113,9		0,0	-93,9
180,4	20,0	-113,1		0,0	-93,1
213,1	20,0	-112,2		0,0	-92,2
251,7	20,0	-111,3		0,0	-91,3
297,3	20,0	-108,3		0,0	-88,3
351,2	20,0	-105,2		0,0	-85,2
414,8	20,0	-102,1		0,0	-82,1
490,0	20,0	-99,1		0,0	-79,1
490,0	20,0		-56,4	0,1	-36,3
582,0	20,0		-56,2	0,1	-36,1
690,0	20,0		-56,0	0,2	-35,8
820,0	20,0		-55,7	0,2	-35,5
973,0	20,0		-55,4	0,2	-35,2
1.155,0	20,0		-54,9	0,3	-34,6
1.371,0	20,0		-54,4	0,3	-34,1
1.627,0	20,0		-53,7	0,3	-33,4
1.931,0	20,0		-52,9	0,4	-32,5
2.292,0	20,0		-52,0	0,4	-31,6
2.721,0	20,0		-49,8	0,5	-29,3
3.230,0	20,0		-46,6	0,5	-26,1
3.834,0	20,0		-43,3	0,6	-22,7
4.551,0	20,0		-40,1	0,6	-19,5
5.402,0	20,0		-36,8	0,7	-16,1
6.412,0	20,0		-33,5	0,7	-12,8
7.612,0	20,0		-30,3	0,8	-9,5
9.035,0	20,0		-27,0	0,8	-6,2
10.725,0	20,0		-23,9	0,9	-3,0
12.730,0	20,0		-21,2	0,9	-0,3
15.111,0	20,0		-19,3	1,0	1,7
17.937,0	20,0		-18,4	1,0	2,6
21.292,0	20,0		-18,2	1,1	2,9
25.274,0	20,0		-18,3	1,1	2,8
30.000,0	20,0		-18,4	1,2	2,8

4.7. General Limit - Radiated field strength emissions, 30 MHz - 1 GHz

4.7.1. Test location and equipment

test location	<input checked="" type="checkbox"/> CETECOM Essen (Chapter. 2.2.1)	<input type="checkbox"/> Please see Chapter. 2.2.2	<input type="checkbox"/> Please see Chapter. 2.2.3
test site	<input checked="" type="checkbox"/> 441 EMI SAR <input checked="" type="checkbox"/> 487 SAR NSA		
receiver	<input type="checkbox"/> 377 ESCS30 <input checked="" type="checkbox"/> 001 ESS	<input type="checkbox"/> 489 ESU 40 <input type="checkbox"/> 620 ESU 26	
spectr. analys.	<input type="checkbox"/> 584 FSU <input type="checkbox"/> 120 FSEM	<input type="checkbox"/> 264 FSEK	
antenna	<input checked="" type="checkbox"/> 574 BTA-L <input type="checkbox"/> 133 EMCO3115	<input type="checkbox"/> 302 BBHA9170 <input type="checkbox"/> 289 CBL 6141	<input type="checkbox"/> 030 HFH-Z2 <input type="checkbox"/> 477 GPS
signaling	<input type="checkbox"/> 392 MT8820A <input type="checkbox"/> 371 CBT32	<input type="checkbox"/> 547 CMU <input type="checkbox"/> 594 CMW	
otherwise	<input type="checkbox"/> 400 FTC40x15E <input type="checkbox"/> 401 FTC40x15E	<input type="checkbox"/> 110 USB LWL <input checked="" type="checkbox"/> 482 Filter Matrix	
DC power	<input type="checkbox"/> 456 EA 3013A <input type="checkbox"/> 457 EA 3013A	<input type="checkbox"/> 459 EA 2032-50 <input type="checkbox"/> 268 EA- 3050	<input type="checkbox"/> 494 AG6632A <input type="checkbox"/> 498 NGPE
line voltage	<input type="checkbox"/> 230 V 50 Hz via public mains	<input checked="" type="checkbox"/> 060 120 V 60 Hz via PAS 5000	

4.7.2. Requirements/Limits

FCC		<input type="checkbox"/> Part 15 Subpart B, §15.109, class B <input checked="" type="checkbox"/> Part 15 Subpart C, §15.209 @ frequencies defined in §15.205	
ANSI		<input type="checkbox"/> C63.4-2009 <input checked="" type="checkbox"/> C63.10-2009	
Limit	Frequency [MHz]	Radiated emissions limits, 3 meters	
		QUASI Peak [μ V/m]	QUASI-Peak [dB μ V/m]
	30 - 88	100	40.0
	88 - 216	150	43.5
	216 - 960	200	46.0
	above 960	500	49.0

4.7.3. Restricted bands of operation, §15.205

MHz	MHz	MHz	GHz
0.090-0.110	16.42-16.423	399.9-410	4.5-5.15
0.495-0.505	16.69475-16.69525	608-614	5.35-5.46
2.1735-2.1905	16.80425-16.80475	960-1240	7.25-7.75
4.125-4.128	25.5-25.67	1300-1427	8.025-8.5
4.20725-4.20775	37.5-38.25	1645.5-1646.5	9.3-9.5
6.215-6.218	73-74.6	1660-1710	10.6-12.7
6.26775-6.26825	74.8-75.2	1718.8-1722.2	13.25-13.4
6.31175-6.31225	108-121.94	2200-2300	14.47-14.5
8.291-8.294	123-138	2310-2390	15.35-16.2
8.362-8.366	149.9-150.05	2483.5-2500	17.7-21.4
8.37625-8.38675	156.52475-156.52525	2690-2900	22.01-23.12
8.41425-8.41475	156.7-156.9	3260-3267	23.6-24.0
12.29-12.293	162.0125-167.17	3332-3339	31.2-31.8
12.51975-12.52025	167.72-173.2	3345.8-3358	36.43-36.5
12.57675-12.57725	240-285	3600-4400	Above 38.6
13.36-13.41	322-335.4	--	--

Remark: only spurious emissions are allowed within these frequency bands not exceeding the limits per §15.209

4.7.4. Test condition and measurement test set-up

Signal link to test system (if used):		<input type="checkbox"/> air link	<input type="checkbox"/> cable connection	<input checked="" type="checkbox"/> none
EUT-grounding		<input checked="" type="checkbox"/> none	<input type="checkbox"/> with power supply	<input type="checkbox"/> additional connection
Equipment set up		<input checked="" type="checkbox"/> table top 0.8m height		<input type="checkbox"/> floor standing
Climatic conditions		Temperature: (22±3°C)		Rel. humidity: (40±20)%
EMI-Receiver (Analyzer) Settings	Scan frequency range:	<input checked="" type="checkbox"/> 30 – 1000 MHz <input type="checkbox"/> other:		
	Scan-Mode	<input checked="" type="checkbox"/> 6 dB EMI-Receiver Mode <input type="checkbox"/> 3 dB spectrum analyser mode		
	Detector	Peak / Quasi-peak		
	RBW/VBW	100 kHz/300 kHz		
	Mode:	Repetitive-Scan, max-hold		
Scan step	80 kHz			
Sweep-Time	Coupled – calibrated display if continuous tx-signal otherwise adapted to EUT’s individual duty-cycle			
General measurement procedures		Please see chapter “Test system set-up for electric field measurement in the range 30 MHz to 1 GHz”		

4.7.5. MEASUREMENT RESULTS

The results are presented below in summary form only. For more information please see diagrams enclosed in annex4.

Table of measurement results:

Dia-gram no.	Carrier Channel		Frequency range	Set-up no.	OP-mode no.	Remark	Used detector			Result
	Range	No.					PK	AV	QP	
3.01	Middle	1	30MHz to 1GHz	4	1		<input checked="" type="checkbox"/>	<input type="checkbox"/>	<input type="checkbox"/>	passed
3.02	Middle	6		4	1		<input checked="" type="checkbox"/>	<input type="checkbox"/>	<input checked="" type="checkbox"/>	passed
3.03	Middle	11		4	1		<input checked="" type="checkbox"/>	<input type="checkbox"/>	<input checked="" type="checkbox"/>	passed

Remark:

4.8. General Limit - Radiated emissions, above 1 GHz

4.8.1. Test location and equipment FAR

test site	<input type="checkbox"/> 441 EMI SAR	<input type="checkbox"/> 348 EMI cond.	<input checked="" type="checkbox"/> 443 EMI FAR	<input type="checkbox"/> 347 Radio.lab.	<input type="checkbox"/> 337 OATS	<input type="checkbox"/>
spectr. analys.	<input type="checkbox"/> 584 FSU	<input type="checkbox"/> 120 FSEM	<input type="checkbox"/> 264 FSEK	<input checked="" type="checkbox"/> 489 ESU 40	<input type="checkbox"/>	<input type="checkbox"/>
antenna meas	<input type="checkbox"/> 574 BTA-L	<input type="checkbox"/> 289 CBL 6141	<input type="checkbox"/> 608 HL 562	<input checked="" type="checkbox"/> 549 HL025	<input checked="" type="checkbox"/> 302 BBHA9170	<input type="checkbox"/> 477 GPS
antenna meas	<input type="checkbox"/> 123 HUF-Z2	<input type="checkbox"/> 132 HUF-Z3	<input type="checkbox"/> 030 HFH-Z2	<input type="checkbox"/>	<input type="checkbox"/>	<input type="checkbox"/>
antenna subst	<input type="checkbox"/> 071 HUF-Z2	<input type="checkbox"/> 020 EMCO3115	<input type="checkbox"/> 063 LP 3146	<input type="checkbox"/> 303 BBHA9170	<input type="checkbox"/>	<input type="checkbox"/>
multimeter	<input type="checkbox"/> 341 Fluke 112	<input type="checkbox"/>	<input type="checkbox"/>	<input type="checkbox"/>	<input type="checkbox"/>	<input type="checkbox"/>
signaling	<input type="checkbox"/> 392 MT8820A	<input type="checkbox"/> 371 CBT32	<input type="checkbox"/> 547 CMU	<input type="checkbox"/> 594 CMW	<input type="checkbox"/>	<input type="checkbox"/>
DCpower	<input type="checkbox"/> 086 LNG50-10	<input type="checkbox"/> 087 EA3013	<input type="checkbox"/> 354 NGPE 40	<input type="checkbox"/> 349 car battery	<input type="checkbox"/> 350 Car battery	<input type="checkbox"/>
line voltage	<input type="checkbox"/> 230 V 50 Hz via public mains		<input checked="" type="checkbox"/> 060 120 V 60 Hz via PAS 5000			

4.8.2. Requirements/Limits

FCC	<input type="checkbox"/> Part 15 Subpart B, §15.109 class B <input checked="" type="checkbox"/> Part 15 subpart C, §15.209 @ frequencies defined in §15.205			
ANSI	<input type="checkbox"/> C63.4-2009 <input checked="" type="checkbox"/> C63.10-2009			
Frequency [MHz]	Limits, 3 meters			
	AV [µV/m]	AV [dBµV/m]	Peak [µV/m]	Peak [dBµV/m]
above 1 GHz	500	54.0	5000	74.0

4.8.3. Test condition and measurement test set-up

Signal link to test system (if used):	<input type="checkbox"/> air link	<input type="checkbox"/> cable connection	
EUT-grounding	<input checked="" type="checkbox"/> none	<input type="checkbox"/> with power supply	<input type="checkbox"/> additional connection
Equipment set up	<input checked="" type="checkbox"/> table top 1.5m height		<input type="checkbox"/> floor standing
Climatic conditions	Temperature: (22±3°C)		Rel. humidity: (40±20)%
Spectrum-Analyzer settings	Scan frequency range: <input checked="" type="checkbox"/> 1 – 18 GHz <input checked="" type="checkbox"/> 18 – 25 GHz <input type="checkbox"/> 18 – 40 GHz <input type="checkbox"/> other: <input checked="" type="checkbox"/> 6 dB EMI-Receiver Mode <input type="checkbox"/> 3 dB Spectrum analyser Mode Peak and Average 1 MHz / 3 MHz Repetitive-Scan, max-hold 400 kHz Coupled – calibrated display if CW signal otherwise adapted to EUT’s individual duty-cycle		
General measurement procedures	Please see chapter “Test system set-up for radiated electric field measurements above 1 GHz”		

4.8.4. Measurement Results

The results are presented below in summary form only. For more information please see diagrams.

Dia-gram no.	Carrier Channel		Frequency range	Set-up no.	OP-mode no.	Remark	Used detector			Result
	Range	No.					PK	AV	QP	
8.01	Low	6	1 to 18GHz	2	1	--	<input checked="" type="checkbox"/>	<input checked="" type="checkbox"/>	<input type="checkbox"/>	passed
8.01b	Low	6	18 to 25 GHz	3	1	--	<input checked="" type="checkbox"/>	<input checked="" type="checkbox"/>	<input type="checkbox"/>	passed
8.02	Middle	6	1 to 18GHz	2	1	--	<input checked="" type="checkbox"/>	<input checked="" type="checkbox"/>	<input type="checkbox"/>	passed
8.02b	Middle	6	18 to 25 GHz	3	1	--	<input checked="" type="checkbox"/>	<input checked="" type="checkbox"/>	<input type="checkbox"/>	passed
8.03	High	6	1 to 18GHz	2	1	--	<input checked="" type="checkbox"/>	<input checked="" type="checkbox"/>	<input type="checkbox"/>	passed
8.03b	High	6	18 to 25 GHz	3	1	--	<input checked="" type="checkbox"/>	<input checked="" type="checkbox"/>	<input type="checkbox"/>	passed

4.9. RF-Parameter - Radiated Band Edge compliance measurements

4.9.1. Test location and equipment FAR

test site	<input type="checkbox"/> 441 EMI SAR	<input type="checkbox"/> 348 EMI cond.	<input checked="" type="checkbox"/> 443 EMI FAR	<input type="checkbox"/> 347 Radio.lab.	<input type="checkbox"/> 337 OATS	<input type="checkbox"/>
spectr. analys.	<input type="checkbox"/> 584 FSU	<input type="checkbox"/> 120 FSEM	<input type="checkbox"/> 264 FSEK	<input checked="" type="checkbox"/> 489 ESU 40	<input type="checkbox"/>	<input type="checkbox"/>
antenna meas	<input type="checkbox"/> 574 BTA-L	<input type="checkbox"/> 289 CBL 6141	<input type="checkbox"/> 608 HL 562	<input checked="" type="checkbox"/> 549 HL025	<input type="checkbox"/> 302 BBHA9170	<input type="checkbox"/> 477 GPS
antenna meas	<input type="checkbox"/> 123 HUF-Z2	<input type="checkbox"/> 132 HUF-Z3	<input type="checkbox"/> 030 HFH-Z2	<input type="checkbox"/>	<input type="checkbox"/>	<input type="checkbox"/>
antenna subst	<input type="checkbox"/> 071 HUF-Z2	<input type="checkbox"/> 020 EMCO3115	<input type="checkbox"/> 063 LP 3146	<input type="checkbox"/> 303 BBHA9170	<input type="checkbox"/>	<input type="checkbox"/>
multimeter	<input type="checkbox"/> 341 Fluke 112	<input type="checkbox"/>	<input type="checkbox"/>	<input type="checkbox"/>	<input type="checkbox"/>	<input type="checkbox"/>
signaling	<input type="checkbox"/> 392 MT8820A	<input type="checkbox"/> 371 CBT32	<input type="checkbox"/> 547 CMU	<input type="checkbox"/> 594 CMW	<input type="checkbox"/>	<input type="checkbox"/>
DC power	<input type="checkbox"/> 086 LNG50-10	<input type="checkbox"/> 087 EA3013	<input type="checkbox"/> 354 NGPE 40	<input type="checkbox"/> 349 car battery	<input type="checkbox"/> 350 Car battery	<input type="checkbox"/>
line voltage	<input type="checkbox"/> 230 V 50 Hz via public mains		<input type="checkbox"/> 060 120 V 60 Hz via PAS 5000			

4.9.2. Requirements/Limits

FCC	<input type="checkbox"/> Part 15 Subpart B, §15.109 class B <input checked="" type="checkbox"/> Part 15 subpart C, §15.209 @ frequencies defined in §15.205
ANSI	<input type="checkbox"/> C63.4-2009 <input checked="" type="checkbox"/> C63.10-2009

4.9.3. Measurement Method

For uncritical results where a measurement bandwidth of 1MHz can clearly show the compliance without influencing the results, a field strength measurement was performed only to show compliance.

For critical results a Marker-Delta marker method was used for showing compliance to restricted bands according §15.205. The method is according ANSI 63.10:2009 “Marker-Delta method”. The method consists of three independent steps:

- 1. Step:** Prior to the measurement the fundamental radiated In-Band field strength was performed. The determined value is used as reference value.
- 2. Step:** Second step consist of finding the relative attenuation between the fundamental emission and the maximum local out-of-band emission (within 2 MHz range around the band edge either on the band-edge directly or some modulation product if the level is greater than that on the band-edge) when measured with lower resolution bandwidth.
- 3. Step:** The delta value recorded in step 2 will be subtracted from value recorded in step 1, thus giving the required field strength at the band-edge. This value must fulfil the requirements for radiated spurious emissions in restricted bands in §15.205 (RSS-Gen) with the general limits of §15.209 or RSS-Gen..

4.9.4. EUT settings

A fully loaded battery was used and changed if required in order to keep the voltage constant over the test time. The EUT was instructed to send with maximum power (if adjustable) according to applicants instructions.

4.9.5. Measurements results: for non-restricted bands near-by (§15.247)

Channel no.	Restricted band ?	Fundamental Value [dBuV/m]		Peak-Value at Band-Edge [dBuV/m]	Difference [dB]	Limit [dBc]	Margin [dB]	Verdict	Remark:
		Peak-Value	Average-Value						
1	no	83,92	75	53,54	30,38	20	10,38	PASS	b-mode, gc value= 58
1	no	75,51	69	52,92	22,59	20	2,59	PASS	g-mode, gc value= 50
1	no	76,25	70	53,10	23,15	20	3,15	PASS	n-mode, gc value= 50

Remark:

4.9.6. Measurements results: for restricted bands near-by (§15.205)

Channel no.	Restricted band ?	Fundamental Value [dBuV/m]		Value at Band-Edge [dBuV/m]		Limits [dBuV/m]		Margin [dB]		Verdict	Remark:
		Peak-Value	Average-Value	Peak -Value	Average -Value	Peak -Value	Average -Value	Peak	Average		
11	yes	103,09	101	59,15	47,5	74	54	14,85	6,5	PASS	b-mode, gc-value=58
11	yes	84,39	77	58,61	47	74	54	15,39	7	PASS	g-mode, gc-value=50
11	yes	83,66	75	60,07	47,5	74	54	13,93	6,5	PASS	n-mode, gc-value=50

Remark:

4.9.7. Verdict: passed

4.10. Measurement uncertainties

The reported uncertainties are calculated based on the standard uncertainty multiplied with the appropriate coverage factor **k**, such that a confidence level of approximately 95% is achieved. For uncertainty determination, each component used in the concrete measurement set-up was taken in account and its contribution to the overall uncertainty according to its statistical distribution calculated.

RF-Measurement	Reference	Frequency range	Calculated uncertainty based on a confidence level of 95%	Remarks
Conducted emissions (U _{CISPR})	CISPR 16-2-1	9 kHz - 150 kHz 150 kHz - 30 MHz	4.0 dB 3.6 dB	-
Radiated emissions Enclosure	CISPR 16-2-3	30 MHz - 1 GHz 1 GHz - 18 GHz	4.2 dB 5.1 dB	E-Field
Disturbance power	CISPR 16-2-2	30 MHz - 300 MHz	-	-
Power Output radiated	-	30 MHz - 4 GHz	3.17 dB	Substitution
Power Output conducted	-	9 kHz - 20 GHz	1.0 dB	-
Conducted emissions on antenna ports	-	9 kHz - 20 GHz 20 GHz - 40 GHz	1.0 dB	-
Occupied bandwidth	-	9 kHz - 4 GHz	0.1272 ppm (Delta Marker)	Frequency error
			1.0 dB	Power
Emission bandwidth	-	9 kHz - 4 GHz	0.1272 ppm (Delta Marker)	Frequency error
			1.0 dB	Power
Frequency stability	-	9 kHz - 20 GHz	0.0636 ppm	-
Radiated emissions Enclosure	-	150 kHz - 30 MHz	5.0 dB	Magnetic field E-field Substitution (Power)
		30 MHz - 1 GHz	4.2 dB	
		1 GHz - 20 GHz	3.17 dB	

Table: measurement uncertainties, valid for conducted/radiated measurements

5. Accreditation details of CETECOM's laboratories and test sites

Ref.-No.	Accreditation Certificate	Valid for laboratory area or test site	Accreditation Body
-	D-PL-12047-01-01	All laboratories and test sites of CETECOM GmbH, Essen	DAkKS, Deutsche Akkreditierungsstelle GmbH
337 487 558 348 348	MRA US-EU 0003	Radiated Measurements 30 MHz to 1 GHz, 3 m / 10 m (OATS) Radiated Measurements 30 MHz to 1 GHz, 3 m (SAR) Radiated Measurements above 1 GHz, 3 m (FAR) Mains Ports Conducted Interference Measurements Telecommunication Ports Conducted Interference Measur.	FCC, Federal Communications Commission Laboratory Division, USA
337 487 550 558	3462D-1 3462D-2 3462D-2 3462D-3	Radiated Measurements 30 MHz to 1 GHz, 3 m / 10 m (OATS) Radiated Measurements 30 MHz to 1 GHz, 3 m (SAR) Radiated Measurements 1 GHz to 6 GHz, 3 m (SAR) Radiated Measurements above 1 GHz, 3 m (FAR)	IC, Industry Canada Certification and Engineering Bureau
487 550 348 348	R-2666 G-301 C-2914 T-1967	Radiated Measurements 30 MHz to 1 GHz, 3 m (SAR) Radiated Measurements 1 GHz to 6 GHz, 3 m (SAR) Mains Ports Conducted Interference Measurements Telecommunication Ports Conducted Interference Measur.	VCCI, Voluntary Control Council for Interference by Information Technology Equipment, Japan

OATS = Open Area Test Site, SAR = Semi Anechoic Room, FAR = Fully Anechoic Room

6. Instruments and Ancillary

6.1. Used equipment "CTC"

The "Ref.-No" in the left column of the following tables allows the clear identification of the laboratory equipment.

6.1.1. Test software and firmware of equipment

Ref.-No.	Equipment	Type	Serial-No.	Version of Firmware or Software during the test
001	EMI Test Receiver	ESS	825132/017	Firm.= 1.21 , OTP=2.0, GRA=2.0
012	Signal Generator (EMS-cond.)	SMY 01	839069/027	Firm.= V 2.02
013	Power Meter (EMS cond.)	NRVD	839111/003	Firm.= V 1.51
017	Digital Radiocommunication Tester	CMD 60 M	844365/014	Firmware = V 3.52 .22.01.99, DECT = D2.87 13.01.99
053	Audio Analyzer	UPA3	860612/022	Firm. V 4.3
119	RT Harmonics Analyzer dig. Flickermeter	B10	G60547	Firm.= V 3.1DHG
140	Signal Generator	SMHU	831314/006	Firm.= 3.21
261	Thermal Power Sensor	NRV-Z55	825083/0008	EPROM-Datum 02.12.04, SE EE 1 B
262	Power Meter	NRV-S	825770/0010	Firm.= 2.6
263	Signal Generator	SMP 04	826190/0007	Firm.=3.21
264	Spectrum Analyzer	FSEK 30	826939/005	Bios=2.1, Analyzer= 3.20
295	Racal Digital Radio Test Set	6103	1572	UNIT Firmware= 4.04, SW-Main=4.04, SW-BBP=1.04, SW-DSP=1.02, Hardboot=1.02, Softboot=2.02
298	Univ. Radio Communication Tester	CMU 200	832221/091	R&S Test Firmware =3.53 /3.54 (current Testsoftw. f. all band used
323	Digital Radiocommunication Tester	CMD 55	825878/0034	Firm.= 3.52 .22.01.99
331	Climatic Test Chamber -40/+80 Grad	HC 4055	43146	TSI 1.53
335	CTC-EMS-Conducted	System EMS Conducted	-	EMC 32 V 8.52
340	Digital Radiocommunication Tester	CMD 55	849709/037	Firm.= 3.52 .22.01.99
355	Power Meter	URV 5	891310/027	Firm.= 1.31
365	10V Insertion Unit 50 Ohm	URV5-Z2	100880	Eprom Data = 31.03.08
366	Ultra Compact Simulator	UCS 500 M4	V0531100594	Firm. UCS 500=001925/3.06a02, rc=ISMIEC 4.10
371	Bluetooth Tester	CBT32	100153	CBT V5.30+ SW-Option K55, K57
377	EMI Test Receiver	ESCS 30	100160	Firm.= 2.30, OTP= 02.01, GRA= 02.36
378	Broadband RF Field Monitor	RadiSense III	03D00013SNO-08	Firm.= V.03D13
389	Digital Multimeter	Keithley 2000	0583926	Firm. = A13 (Mainboard) A02 (Display)
392	Radio Communication Tester	MT8820A	6K00000788	Firm.= 4.50 #005, IPL=4.01#001, OS=4.02#001, GSM=4.41#013, W-CDMA= 4.54#004, scenario= 4.52#002
436	Univ. Radio Communication Tester	CMU 200	103083	R&S Test Firmware Base=5.14, Mess-Software= GSM:5.14 WCDMA:5.14 (current Testsoftw. F. all band
441	CTC-SAR-EMI Cable Loss	System EMI field (SAR)	-	EMC 32 Version 8.52
442	CTC-SAR-EMS	System EMS field (SAR)	-	EMC 32 Version 8.40
443	CTC-FAR-EMI-RSE	System CTC-FAR-EMI-RSE	-	Spuri 7.2.5 or EMC 32 Ver. 9.15.00
444	CTC-FAR-EMS field	System-EMS-Field (FAR)	-	EMC 32 Version 9.15.00
460	Univ. Radio Communication Tester	CMU 200	108901	R&S Test Firmware Base=5.14, GSM=5.14 WCDMA=5.14 (current Testsoftw.,f. all band to be used,
489	EMI Test Receiver	ESU40	1000-30	Firmware=4.43 SP3, Bios=V5.1-16-3, Spec. =01.00
491	ESD Simulator dito	ESD dito	dito307022	V 2.30
524	Voltage Drop Simulator	VDS 200	0196-16	Software Nr: 000037 Version V4.20a01
526	Burst Generator	EFT 200 A	0496-06	Software Nr. 000034 Version V2.32
527	Micro Pulse Generator	MPG 200 B	0496-05	Software-Nr. 000030 Version V2.43
528	Load Dump Simulator	LD 200B	0496-06	Software-Nr. 000031 Version V2.35a01
546	Univ. Radio Communication Tester	CMU 200	106436	R&S Test Firmware Base=5.14, GSM=5.14 WCDMA=5.14 (current Testsoftw.,f. all band to be used
547	Univ. Radio Communication Tester	CMU 200	835390/014	R&S Test Firmware Base=V5.1403 (current Testsoftw., f. all band used, GSM = 5.14 WCDMA: = 5.14
584	Spectrum Analyzer	FSU 8	100248	2.82 SP3
597	Univ. Radio Communication Tester	CMU 200	100347	R&S Test Firmware Base=5.01, GSM=5.02 WCDMA= not installed, Mainboard= μ P1=V.850
598	Spectrum Analyzer	FSEM 30 (Reserve)	831259/013	Firmware Bios 3.40 , Analyzer 3.40 Sp 2
620	EMI Test Receiver	ESU 26	100362	4.43 SP3
642	Wideband Radio Communication Tester	CMW 500	126089	Setup V03.26, Test programm component V03.02.20
692	Bluetooth Tester	CBT 32	100236	CBT V 5.40, FW: V.2.41 (FPGA Digital, V. 3.09 FPGA RF)

6.1.2. Single instruments and test systems

Ref.-No.	Equipment	Type	Serial-No.	Manufacturer	Interval of calibration	Remark	Cal due
001	EMI Test Receiver	ESS	825132/017	Rohde & Schwarz	12 M	-	31.05.2015
005	AC - LISN (50 Ohm/50µH, test site 1)	ESH2-Z5	861741/005	Rohde & Schwarz	12 M	-	31.05.2015
007	Single-Line V-Network (50 Ohm/5µH)	ESH3-Z6	892563/002	Rohde & Schwarz	12 M	-	31.05.2015
009	Power Meter (EMS-radiated)	NRV	863056/017	Rohde & Schwarz	24 M	-	31.05.2015
016	Line Impedance Simulating Network	Op. 24-D	B6366	Spitzenberger+Spies	36 M	-	31.03.2016
020	Horn Antenna 18 GHz (Subst 1)	3115	9107-3699	EMCO	36/12 M	-	31.03.2017
021	Loop Antenna (H-Field)	6502	9206-2770	EMCO	36 M	-	31.05.2015
030	Loop Antenna (H-field)	HFH-Z2	879604/026	Rohde & Schwarz	36 M	-	31.05.2015
033	RF-current probe (100kHz-30MHz)	ESH2-Z1	879581/18	Rohde & Schwarz	24 M	-	31.05.2015
057	relay-switch-unit (EMS system)	RSU	494440/002	Rohde & Schwarz	pre-m	1a	
060	power amplifier (DC-2kHz)	PAS 5000	B6363	Spitzenberger+Spies	-	3	
066	notch filter (WCDMA; FDD1)	WRCT 1900/2200-5/40-10EEK	5	Wainwright GmbH	12 M	1g	31.07.2015
086	DC - power supply, 0 -10 A	LNG 50-10	-	Heinzinger Electronic	pre-m	2	
087	DC - power supply, 0 -5 A	EA-3013 S	-	Elektro Automatik	pre-m	2	
090	Helmholtz coil: 2x10 coils in series	Helmholtz coil: 2x10 coils in	-	RWTÜV	12 M	4	31.05.2015
091	USB-LWL-Converter	OLS-1	007/2006	Ing. Büro Scheiba	-	4	
099	passive voltage probe	ESH2-Z3	299.7810.52	Rohde & Schwarz	36 M	-	31.05.2015
100	passive voltage probe	Probe TK 9416	without	Schwarzbeck	36 M	-	31.05.2015
110	USB-LWL-Converter	OLS-1	-	Ing. Büro Scheiba	-	4	
119	RT Harmonics Analyzer dig. Flickermeter	B10	B60547	BOCONSULT	36 M	-	31.03.2016
136	adjustable dipole antenna (Dipole 1)	3121C-DB4	9105-0697	EMCO	36 M	-	31.05.2015
140	Signal Generator	SMHU	831314/006	Rohde & Schwarz	24 M	-	31.03.2016
248	attenuator	SMA 6dB 2W	-	Radiall	pre-m	2	
249	attenuator	SMA 10dB 10W	-	Radiall	pre-m	2	
252	attenuator	N 6dB 12W	-	Radiall	pre-m	2	
256	attenuator	SMA 3dB 2W	-	Radiall	pre-m	2	
257	hybrid	4031C	04491	Narda	pre-m	2	
260	hybrid coupler	4032C	11342	Narda	pre-m	2	
261	Thermal Power Sensor	NRV-Z55	825083/0008	Rohde & Schwarz	24 M	-	31.03.2016
262	Power Meter	NRV-S	825770/0010	Rohde & Schwarz	24 M	-	31.03.2016
263	Signal Generator	SMP 04	826190/0007	Rohde & Schwarz	36 M	-	31.03.2016
264	Spectrum Analyzer	FSEK 30	826939/005	Rohde & Schwarz	12 M	-	31.05.2015
265	peak power sensor	NRV-Z33, Model 04	840414/009	Rohde & Schwarz	24 M	-	31.03.2016
266	Peak Power Sensor	NRV-Z31, Model 04	843383/016	Rohde & Schwarz	24 M	-	31.03.2016
267	notch filter GSM 850	WRCA 800/960-6EEK	9	Wainwright GmbH	pre-m	2	
270	termination	1418 N	BB6935	Weinschel	pre-m	2	
271	termination	1418 N	BE6384	Weinschel	pre-m	2	
272	attenuator (20 dB) 50 W	Model 47	BF6239	Weinschel	pre-m	2	
273	attenuator (10 dB) 100 W	Model 48	BF9229	Weinschel	pre-m	2	
274	attenuator (10 dB) 50 W	Model 47 (10 dB) 50 W	BG0321	Weinschel	pre-m	2	
275	DC-Block	Model 7003 (N)	C5129	Weinschel	pre-m	2	
276	DC-Block	Model 7006 (SMA)	C7061	Weinschel	pre-m	2	
279	power divider	1515 (SMA)	LH855	Weinschel	pre-m	2	
287	pre-amplifier 25MHz - 4GHz	AMF-2D-100M4G-35-10P	379418	Miteq	12 M	1c	31.07.2015
291	high pass filter GSM 850/900	WHJ 2200-4EE	14	Wainwright GmbH	12 M	1c	31.07.2015
298	Univ. Radio Communication Tester	CMU 200	832221/091	Rohde & Schwarz	pre-m	3	
300	AC LISN (50 Ohm/50µH, 1-phase)	ESH3-Z5	892 239/020	Rohde & Schwarz	12 M	-	31.05.2015
301	attenuator (20 dB) 50W, 18GHz	47-20-33	AW0272	Lucas Weinschel	pre-m	2	
302	horn antenna 40 GHz (Meas 1)	BBHA9170	155	Schwarzbeck	36 M	-	31.03.2017
303	horn antenna 40 GHz (Subst 1)	BBHA9170	156	Schwarzbeck	36 M	-	31.03.2017
331	Climatic Test Chamber -40/+80 Grad	HC 4055	43146	Heraeus Vötsch	24 M	-	30.11.2014
341	Digital Multimeter	Fluke 112	81650455	Fluke	24 M	-	31.03.2016
342	Digital Multimeter	Voltcraft M-4660A	IB 255466	Voltcraft	24 M	-	31.05.2015
347	laboratory site	radio lab.	-	-	-	5	
348	laboratory site	EMI conducted	-	-	-	5	
354	DC - Power Supply 40A	NGPE 40/40	448	Rohde & Schwarz	pre-m	2	
355	Power Meter	URV 5	891310/027	Rohde & Schwarz	24 M	-	31.03.2016
356	power sensor	NRV-Z1	882322/014	Rohde & Schwarz	24 M	-	31.05.2015
357	power sensor	NRV-Z1	861761/002	Rohde & Schwarz	24 M	-	31.05.2015
371	Bluetooth Tester	CBT32	100153	R&S	24 M	-	31.03.2016
373	Single-Line V-Network (50 Ohm/5µH)	ESH3-Z6	100535	Rohde & Schwarz	24 M	-	31.03.2016
377	EMI Test Receiver	ESCS 30	100160	Rohde & Schwarz	12 M	-	31.05.2015
389	Digital Multimeter	Keithley 2000	0583926	Keithley	24 M	-	31.05.2015
392	Radio Communication Tester	MT8820A	6K00000788	Anritsu	12 M	-	31.05.2015
431	Model 7405	Near-Field Probe Set	9305-2457	EMCO	-	4	
436	Univ. Radio Communication Tester	CMU 200	103083	Rohde & Schwarz	12 M	-	31.05.2015
439	UltraLog-Antenna	HL 562	100248	Rohde & Schwarz	36 M	-	31.03.2017
441	CTC-SAR-EMI Cable Loss	System EMI field (SAR) Cable	-	CETECOM	12 M	5	30.01.2016
443	CTC-FAR-EMI-RSE	System CTC-FAR-EMI-RSE	-	ETS-Lindgren / CETECOM	12 M	5	31.07.2015
448	notch filter WCDMA_FDD II	WRCT 1850.0/2170.0-5/40-	5	Wainwright Instruments GmbH	12 M	1c	31.07.2015

Ref.-No.	Equipment	Type	Serial-No.	Manufacturer	Interval of calibration	Remark	Cal due
449	notch filter WCDMA FDD V	WRCT 824.0/894.0-5/40-8SSK	1	Wainwright	12 M	1c	31.07.2015
454	Oscilloscope	HM 205-3	9210 P 29661	Hameg	-	4	
456	DC-Power supply 0-5 A	EA 3013 S	207810	Elektro Automatik	pre-m	2	
459	DC -Power supply 0-5 A , 0-32 V	EA-PS 2032-50	910722	Elektro Automatik	pre-m	2	
460	Univ. Radio Communication Tester	CMU 200	108901	Rohde & Schwarz	12 M	-	31.05.2015
463	Universal source	HP3245A	2831A03472	Agilent	-	4	
466	Digital Multimeter	Fluke 112	89210157	Fluke USA	24 M	-	31.03.2016
467	Digital Multimeter	Fluke 112	89680306	Fluke USA	36 M	-	31.05.2015
468	Digital Multimeter	Fluke 112	90090455	Fluke USA	36 M	-	31.05.2015
477	ReRadiating GPS-System	AS-47	-	Automotive Cons. Fink	-	3	
480	power meter (Fula)	NRVS	838392/031	Rohde & Schwarz	24 M	-	31.05.2015
482	filter matrix	Filter matrix SAR 1	-	CETECOM (Brl)	-	1d	
484	pre-amplifier 2,5 - 18 GHz	AMF-5D-02501800-25-10P	1244554	Miteq	12 M	-	31.07.2015
487	System CTC NSA-Verification SAR-EMI	System EMI field (SAR) NSA	-	ETS Lindgren / CETECOM	24 M	-	30.06.2015
489	EMI Test Receiver	ESU40	1000-30	Rohde & Schwarz	12 M	-	31.05.2015
502	band reject filter	WRCG 1709/1786-1699/1796-	SN 9	Wainwright	pre-m	2	
503	band reject filter	WRCG 824/849-814/859-	SN 5	Wainwright	pre-m	2	
512	notch filter GSM 850	WRCA 800/960-02/40-6EEK	SN 24	Wainwright	12 M	1c	31.07.2015
517	relais switch matrix	HF Relais Box Keithley	SE 04	Keithley	pre-m	2	
523	Digital Multimeter	L4411A	MY46000154	Agilent	24 M	-	31.05.2015
529	6 dB Broadband resistive power divider	Model 1515	LH 855	Weinschel	pre-m	2	
530	10 dB Broadband resistive power divider	R 416110000	LOT 9828	-	pre-m	2	
546	Univ. Radio Communication Tester	CMU 200	106436	R&S	12 M	-	12.02.2015
547	Univ. Radio Communication Tester	CMU 200	835390/014	Rohde & Schwarz	12 M	-	31.05.2015
548	Digital-Barometer	GBP 2300	without	Greisinger GmbH	36 M	-	30.06.2015
549	Log-Per-Antenna	HL025	1000060	Rohde & Schwarz	36/12 M	-	31.05.2015
552	high pass filter 2,8-18GHz	WHKX 2.8/18G-10SS	4	Wainwright	12 M	1c	31.07.2015
557	System CTC-OTA-2	R&S TS8991	-	Rohde & Schwarz	12 M	5	30.09.2015
558	System CTC FAR S-VSWR	System CTC FAR S-VSWR	-	CTC	24 M	-	31.07.2015
574	Biconilog Hybrid Antenna	BTA-L	980026L	Frankonia	36/12 M	-	31.03.2016
584	Spectrum Analyzer	FSU 8	100248	Rohde & Schwarz	pre-m	-	
594	Wideband Radio Communication Tester	CMW 500	101757	Rohde & Schwarz	12 M	-	31.05.2015
597	Univ. Radio Communication Tester	CMU 200	100347	Rohde & Schwarz	36 M	-	31.03.2016
598	Spectrum Analyzer	FSEM 30 (Reserve)	831259/013	Rohde & Schwarz	24 M	-	13.01.2015
600	power meter	NRVD (Reserve)	834501/018	Rohde & Schwarz	24 M	-	31.05.2015
601	medium-sensitivity diode sensor	NRV-Z5 (Reserve)	8435323/003	Rohde & Schwarz	24 M	-	31.05.2015
602	peak power sensor	NRV-Z32 (Reserve)	835080	Rohde & Schwarz	24 M	-	31.05.2015
611	DC power supply	E3632A	KR 75305854	Agilent	pre-m	2	
612	DC power supply	E3632A	MY 40001321	Agilent	pre-m	2	
613	Attenuator	R416120000 20dB 10W	Lot. 9828	Radiall	pre-m	2	
616	Digitalmultimeter	Fluke 177	88900339	Fluke	24 M	-	31.03.2016
617	Power Splitter/Combiner	ZFSC-2-2-S+	S F987001108	Mini Circuits	-	2	
618	Power Splitter/Combiner	50PD-634	600994	JFW Industries USA	-	2	
619	Power Splitter/Combiner	50PD-634	600995	JFW Industries, USA	-	3	
620	EMI Test Receiver	ESU 26	100362	Rohde-Schwarz	12 M	-	01.12.2015
621	Step Attenuator 0-139 dB	RSP	100017	Rohde & Schwarz	pre-m	2	
625	Generic Test Load USB	Generic Test Load USB	-	CETECOM	-	2	
627	data logger	OPUS 1	201.0999.9302.6.4.1.4 3	G. Luft GmbH	36 M	-	30.05.2015
634	Spectrum Analyzer	FSM (HF-Unit)	826188/010	Rohde & Schwarz	pre-m	2	
636	Thermal Imaging camera	Ti32	Ti32-12060213	Fluke Corporation	36 M	-	31.07.2015
637	High Speed HDMI with Ethernet 1m	HDMI cable with Ethernet 1m	-	KogiLink	-	2	
638	HDMI Kabel with Ethernet 1,5 m flach	HDMI cable with Ethernet	-	Reichelt	-	2	
640	HDMI cable 2m rund	HDMI cable 2m rund	-	Reichelt	-	2	
641	HDMI cable with Ethernet	Certified HDMI cable with	-	PureLink	-	2	
642	Wideband Radio Communication Tester	CMW 500	126089	Rohde&Schwarz	12 M	-	31.05.2015
644	Amplifierer	ZX60-2534M+	SN865701299	Mini-Circuits	-	-	
670	Univ. Radio Communication Tester	CMU 200	106833	Rohde & Schwarz	12 M	-	31.05.2015
671	DC-power supply 0-5 A	EA-3013S	-	Elektro Automatik	pre-m	2	
678	Power Meter	NRP	101638	Rohde&Schwarz	pre-m	-	
683	Spectrum Analyzer	FSU 26	200571	Rohde & Schwarz	12 M	-	01.04.2015
686	Field Analyzer	EHP-200A	160WX30702	Narda Safety Test Solutions	24 M	-	18.07.2015
687	Signal Generator	SMF 100A	102073	Rohde&Schwarz	12 M	-	01.04.2015
688	Pre Amp	JS-18004000-40-8P	1750117	Miteq	pre-m	-	
692	Bluetooth Tester	CBT 32	100236	Rohde & Schwarz	12 M	-	31.05.2015
693	TS8997	CTC-Radio Lab 1 TS8997	-	Rohde&Schwarz	12 M	5	31.05.2015
697	Power Splitter	ZN4PD-642W-S+	165001445	Mini-Circuits	-	2	

Ref.-No.	Equipment	Type	Serial-No.	Manufacturer	Interval of calibration	Remark	Cal due

6.1.3. Legend

Note / remarks	Calibrated during system calibration:
1a	System CTC-SAR-EMS (Ref.-No. 442)
1b	System-CTC-EMS-Conducted (Ref.-No. 335)
1c	System CTC-FAR-EMI-RSE (Ref.-No . 443)
1d	System CTC-SAR-EMI (Ref.-No . 441)
1e	System CTC-OATS (EMI radiated) (Ref.-No. 337)
1 f	System CTC-CTIA-OTA (Ref.-No . 420)
1 g	System CTC-FAR-EMS (Ref.-No . 444)
2	Calibration or equipment check immediately before measurement
3	Regulatory maintained equipment for functional check or support purpose
4	Ancillary equipment without calibration e.g. mechanical equipment or monitoring equipment
5	Test System

Interval of calibration	12 M	12 month
	24 M	24 month
	36 M	36 month
	24/12 M	Calibration every 24 months, between this every 12 months internal validation
	36/12 M	Calibration every 36 months, between this every 12 months internal validation
	Pre-m	Check before starting the measurement
	-	Without calibration

7. Versions of test reports (change history)

Version	Applied changes	Date of release
	Initial release	2015-04-28
C1	Passage gain verification added, several typos corrected	2015-05-01