

# **User Manual**

## **Cordless Telephone DT690**

## Contents

<b>1 Introduction</b>	<b>4</b>
1.1 Abbreviations and Glossary	5
1.2 Functions and Accessories	5
<b>2 Safety Instructions</b>	<b>6</b>
2.1 Precautions	6
2.1.1 Frequency Range	7
2.1.2 Warranty Notification	7
2.2 Regulatory Compliance Statements (EU/EFTA only)	7
2.3 Regulatory Compliance Statements (USA and Canada only)	7
2.4 Bluetooth Qualified Design ID	8
2.5 Environmental Requirements	8
<b>3 Descriptions</b>	<b>10</b>
3.1 The Cordless Telephone DT690	11
3.2 Chargers	12
3.2.1 Desktop Charger	12
3.2.2 Rack Charger	12
3.2.3 Battery pack Charger	12
3.3 Icons and Text in the Display	12
3.4 Keys and Buttons	16
3.4.1 Off-hook Key	16
3.4.2 On-hook, and On/Off Key	16
3.4.3 Navigation/Confirmation Key	16
3.4.4 Sound off Key	16
3.4.5 Key Lock, and Upper/Lower Case Key	16
3.4.6 Soft Keys	16
3.4.7 Hot Keys	17
3.4.8 Multifunction Button	17
3.4.9 Volume Button	17
3.5 Alphanumeric Keys	18
3.6 Accessories	18
3.6.1 Belt Clips	18
3.6.2 Security String	19
3.6.3 Leather Casing	19
3.6.4 Headset	19
<b>4 Menu Tree</b>	<b>20</b>
4.1 Calls	20
4.2 Contacts	21
4.3 Profile	21

4.4 Messaging .....	22
4.5 My favourites .....	22
4.6 Short cuts .....	23
4.7 Connections .....	23
4.8 Settings .....	24
4.9 In Call .....	25
<b>5 Basic Operation .....</b>	<b>26</b>
5.1 Switch the Telephone On/Off .....	26
5.1.1 Turn the Audible Signal On/Off .....	26
5.2 Lock/Unlock the Keypad .....	26
5.3 Lock/Unlock the Telephone .....	26
<b>6 Calling .....</b>	<b>27</b>
6.1 Open the Call List .....	27
6.2 Incoming Call .....	27
6.2.1 Answer a Call .....	27
6.2.2 End a Call .....	27
6.3 Outgoing Call .....	27
6.3.1 Pre-Dial .....	27
6.3.2 Dial Using a Pre-programmed Hot key, Soft key or Multifunction button ..	27
6.3.3 Dial a Number from the Call list .....	28
6.3.4 Dial the sender of a Message .....	28
6.3.5 Dial a Number from the Local Phonebook .....	28
6.3.6 Dial a Name from the Central Phonebook .....	28
6.4 During a Call .....	29
6.4.1 Adjust the Volume during a Call .....	29
6.4.2 Open Contacts during the Call .....	29
6.4.3 Turn the Microphone on/off during a Call .....	29
6.4.4 Audio Transfer .....	29
6.4.5 Start a New Call during Conversation .....	29
6.4.6 Switch between Calls .....	29
6.4.7 End a Call .....	29
6.4.8 Transfer a Call .....	30
6.4.9 Transfer to new Call .....	30
6.4.10 Conference Call .....	30
6.4.11 Call Back .....	30
6.4.12 Call Waiting .....	30
6.4.13 DTMF .....	30
6.5 Loudspeaking Function .....	30
6.6 Call Diversion .....	31
<b>7 Messaging.....</b>	<b>32</b>

7.1 Message List .....	32
7.2 Receive a Message .....	32
7.2.1 Read a Stored Message .....	32
7.2.2 Reply to a Message .....	32
7.2.3 Delete Message(s) .....	32
7.2.4 Forward a Message .....	32
7.2.5 Call the Sender of the Message .....	32
7.2.6 Call a telephone number included in a Message .....	32
7.2.7 Save Number .....	33
7.2.8 Write and Send a Message .....	33
7.2.9 Open a Sent Message .....	33
7.2.10 Send to Another Destination .....	33
7.3 Voice Mail .....	33
7.3.1 Receive a Voice Mail .....	33
7.3.2 Check the Voice Mail inbox .....	33
7.3.3 One Key Voice Mail Access .....	34
7.4 Contacts .....	34
7.4.1 Add Contact .....	34
7.4.2 Edit Contact .....	34
7.4.3 Delete Contact .....	34
<b>8 Menu Operation.....</b>	<b>35</b>
8.1 Connections .....	35
8.1.1 Bluetooth .....	35
8.1.2 Headset .....	36
8.1.3 System .....	36
8.1.4 In Charger .....	37
8.2 Calls .....	37
8.2.1 Call List .....	38
8.2.2 Missed Calls .....	38
8.2.3 Call Time .....	38
8.2.4 Call Services .....	39
8.3 Short Cuts .....	40
8.3.1 Define Soft Keys .....	40
8.3.2 Define Hot Keys .....	40
8.3.3 Define Navigation Key .....	40
8.3.4 Define Multi-function Button .....	41
8.4 My Favourites .....	41
8.4.1 Add Favourite .....	41
8.4.2 Delete Favourite .....	41
8.5 Messaging .....	41

8.5.1 Inbox .....	41
8.5.2 Write New Messages .....	43
8.5.3 Unsent Messages .....	43
8.5.4 Sent Messages .....	43
8.6 Profiles .....	44
8.7 Contacts .....	44
8.7.1 Call Contact .....	44
8.7.2 Add Contact .....	45
8.7.3 Edit Contact .....	45
8.7.4 Delete Contact .....	45
8.7.5 Central Phonebook .....	45
8.8 Settings .....	46
8.8.1 Sound and Alert Settings .....	46
8.8.2 Phone Lock settings .....	47
8.8.3 Display Settings .....	48
8.8.4 Time & Date Settings .....	48
8.8.5 Answering .....	49
8.8.6 Change Text size for Messages .....	49
8.8.7 Change the Menu Language .....	49
8.8.8 Change Owner ID .....	49
<b>9 Advanced Functions.....</b>	<b>50</b>
9.1 Admin Menu .....	50
<b>10 System Handling.....</b>	<b>51</b>
10.1 Software Upgrade .....	51
<b>11 Troubleshooting .....</b>	<b>52</b>
<b>12 Operation Notice.....</b>	<b>53</b>
12.1 Accessibility and Voice Quality .....	53
<b>13 Maintenance.....</b>	<b>54</b>
13.1 Charge the Battery .....	54
13.2 Charge Spare Batteries .....	54
13.3 Replace the Battery .....	54
13.4 Attach the Hinge-type Clip .....	55
13.5 Attach the Swivel-type Clip .....	55
13.6 Attach Cover for No Clip .....	56
<b>Appendix A: Bluetooth Headset .....</b>	<b>57</b>

## 1 Introduction

This document describes features and settings available for the Cordless Telephone DT690. The cordless telephone is a feature-rich telephone with colour display, telephony, messaging, and bluetooth as optional. It is designed to be used in medium demanding environment such as hospital environment, but also office environment.

It is suitable for users dependent of being reachable and/or having a need for mobile voice and messaging features, which makes it ideal for applications where the user needs either one way messaging or to be able to interact with other users. The colour display enhances and simplifies the use of the cordless telephone.

Read the [2 Safety Instructions](#) on page 6 before using the DT690 telephone.

For software download and parameter set up, read the *Installation and Operational Manual, Portable Device Manager (PDM), Windows version, TD 92325GB, and the Configuration Manual, Cordless telephone DT690, TD 92503GB, and .*

## 1.1 Abbreviations and Glossary

- PDM: Portable Device Manager:  
 A management tool for devices where to download software, set up parameters, templates etc. It is a Windows version that runs on a pc.
- CPDM: Centralized Portable Device Manager:  
 A system version with more features than the PDM. It runs on a ELISE2 hardware and is manageable from a pc with network communication.

## 1.2 Functions and Accessories

Functions	DT690
Local phonebook (250 contacts)	Yes
Central phonebook	Yes*
Vibrator	Yes
Headset connector	Yes
Microphone on/off during call	Yes
Loudspeaking function	Yes
SMS (Short Message Service)	Yes*
Voice mail access	Yes*
Centralized Management	Yes*
Easy replaceable battery	Yes
Bluetooth (optional)	Yes
Accessories	
Desktop charger Basic	Yes
Desktop charger Advanced	Yes
Charging rack	Yes
Battery pack charger	Yes
Leather case	Yes
Belt Clip	
hinge-type	Yes
swivel-type	Yes
Security chain	Yes
Headset with microphone on boom	Yes
Headset with microphone on cable	Yes
Bluetooth Headset	Yes
CPDM	Yes
PDM Windows Version	Yes

\* System dependent

100

Figure 1. DT690 Features and Accessories

## 2 Safety Instructions

Read this chapter before using the DT690 telephone.

For safe and efficient operation of the telephone, observe the guidelines given in this manual and all necessary safety precautions when using the telephone. Follow the operating instructions and adhere to all warnings and safety precautions located on the product, the Quick Reference Guide and this User Manual.

This product shall only be used with the following batteries:

- Art.No.: 660190 Battery

Single chargers shall only be connected with power adapters supplied by the manufacturer.

Available power adapters (Suppliers Designation) are:

- Art.No.DC3: 130160 Power supply unit AC/5V DC/0.65A - Europe
- Art.No.DC3: 130166 Power supply unit AC/5V DC/1A - USA, Canada, AUS, and UK
- Art.No.DC4: 130161 Power supply unit AC/5V DC/2A

### 2.1 Precautions

- **Save this manual.** It includes important safety information and operating instructions. Save all instructions for future reference.
- Connect AC (power supply) to the desktop battery charger only to designated power sources as marked on the product.  
**Danger:** Never alter the AC cord or plug. If the plug will not fit into the outlet, have a proper outlet installed by a qualified electrician. Improper connection increases the risk of electric shock.
- Position the electrical cord to the AC power supply where it is least likely to be subjected to damage or stress.
- Remove the electrical cord from an outlet by pulling gently on the AC adapter, not by pulling the cord.
- Remove the battery before cleaning the telephone to reduce risk of electric shock.
- Unplug the battery charger from a power source before cleaning the telephone to reduce risk of electric shock.
- Do not use auxiliary equipment with the telephone which is not exclusively recommended by the manufacturer, see [3.6 Accessories](#) on page 18. The use of any auxiliary equipment not recommended by the manufacturer may result in fire, electric shock, or injury, and will void the warranty.
- Do not expose the telephone to open flame.
- Do not expose the telephone and the charger to direct sunlight for long periods. Keep the telephone and charger away from excessive heat and moisture.
- Do not allow heavy objects to fall on the telephone.
- Do not allow children to play with the product packaging material. Product packaging material is often small and may present a choking hazard.
- Do not allow children to play with the telephone. It is not a toy. Children could hurt themselves or others. Children could also damage the telephone.
- Do not expose to prolong light



### 2.1.1 Frequency Range

The telephone is a radio transmitter and receiver. When it is on, it receives and sends out radio frequency (RF) energy. The telephone operates on different frequency ranges depending on market and employs commonly used modulation techniques:

EU	1880-1900 MHz
USA	1920-1930 MHz
LA	1910-1930 MHz

### 2.1.2 Warranty Notification

Do not disassemble the telephone. Disassembling the telephone voids the warranty. The telephone consists of no consumer serviceable components. Service should be performed by Authorized Service centre only.

## 2.2 Regulatory Compliance Statements (EU/EFTA only)

This equipment is intended to be used in the whole EU & EFTA.

This equipment is in compliance with the essential requirements and other relevant provisions of R&TTE Directive 1999/51/EC. The Declaration of Conformity may be consulted at:

<https://www.ascom-ws.com/doc/>

The telephone is marked with the label 

## 2.3 Regulatory Compliance Statements (USA and Canada only)

Portables without Bluetooth	Portables with Bluetooth
FCC ID:BXZDH4	FCC ID:BXZDH4BL
IC: 3724B-DH4	IC: 3724B-DH4BL
US: 9FVW4NANDH4	US: 9FVW4NANDH4

### FCC compliance statements

This equipment has been tested and found to comply with the limits for a Class B digital device, pursuant to part 15 of the FCC Rules. These limits are designed to provide reasonable protection against harmful interference in a residential installation. This equipment generates, uses and can radiate radio frequency energy and, if not installed and used in accordance with the instructions, may cause harmful interference to radio communications. However, there is no guarantee that interference will not occur in a particular installation. If this equipment does cause harmful interference to radio or television reception, which can be determined by turning the equipment off and on, the user is encouraged to try to correct the interference by one or more of the following measures:

- Reorient or relocate the receiving antenna.
- Increase the separation between the equipment and receiver.

- Connect the equipment into an outlet on a circuit different from that to which the receiver is connected.
- Consult the dealer or an experienced radio/TV technician for help.

Privacy of communications may not be ensured when using this telephone.

### Exposure to Radio Frequency Signals

This equipment complies with FCC radiation exposure limits set forth for an uncontrolled environment. This device complies with FCC SAR limit of 1.6 W/kg. The maximum SAR value measured when used at the ear, and when worn on the body using belt clip:

SAR values	With Bluetooth	Without Bluetooth
Head	0.104 W/Kg	0.072 W/Kg
Body worn	0.029 W/Kg	0.036 W/Kg

This device must not be co-located or operating in conjunction with any other antenna or transmitter.

Use of non-Ascom approved accessories may violate the FCC RF exposure guidelines and should be avoided.

### Information to User

This device complies with Part 15 of the FCC Rules. Operation is subject to the following two conditions:

- (1) this device may not cause harmful interference, and
- (2) this device must accept any interference received, including interference that may cause undesired operation.

### Modifications

Changes or modifications to the equipment not expressly approved by the party responsible for compliance could void the user's authority to operate the equipment.

### IC Requirements for Canada

This Class B digital apparatus complies with Canadian ICES-003.  
Cet appareil numérique de la Classe B conforme à la norme NMB-003 du Canada.

## 2.4 Bluetooth Qualified Design ID

Bluetooth QD ID: B014317

## 2.5 Environmental Requirements

### Cordless Telephone

- Only use the telephone in temperatures between 0° C to +40° C (32° F to 104° F).
- Avoid exposing the telephone for direct sunlight or close to other heat sources.
- Do not expose the telephone to open flame.
- Keep the telephone away from excessive heat and moisture.

- Avoid sudden temperature changes to prevent condensation in the telephone. It is recommended to put the telephone into an air tight plastic bag until the temperature is adjusted, for example, when entering or leaving a cold/heated building on a warm/cold day.
- Protect your telephone from aggressive liquids and vapours.
- If the telephone has been exposed for water or condense, remove the battery immediately and let it dry completely before re-inserting the battery.
- Keep the telephone away from strong electromagnetic fields.
- Do not place a cold telephone in a charger.

### **Battery**

- Do not immerse the battery into water. This could short-circuit and damage the battery.
- Do not expose a battery to an open flame. This could cause the battery to explode.
- Do not allow the metal contacts on the battery to touch another metal object. This could short-circuit and damage the battery.
- Do not leave a battery where it could be subjected to extremely high temperatures, such as inside a car on a hot day.
- Use the Desktop Charger or the wall mounted Charging Rack for charging. Charge the battery for at least one hour the first time you use the battery. Note that the wall mounted charger with a battery pack adapter has to be used if the battery alone is to be charged.
- Do not charge a battery when the ambient room temperature is above 40° C or below +5° C (above 104° F or below 41 °F).
- Do not attempt to take a battery apart.
- Do not disconnect the battery unless it needs to be replaced.
- Do power the telephone off before removing the battery.

### **Battery Disposal**

Defective batteries must be returned to a collection point for chemical waste disposal.

### **Chemical Resistance**

The alpha and numeric characters printed on the exterior of the telephone have been tested and found resistant to chipping, fading or wearing off when the telephone is treated with common cleaners and disinfectants or perspiration. The following chemicals have shown no harmful effect:

- 3% Hydrochloric Acid
- M-alcohol (70% Methylated Ethanol)
- 60% Chlorhexidin 0.5mg/ml

Acetone can be damaging to the plastic casing of the telephone and should not be used.

### 3 Descriptions

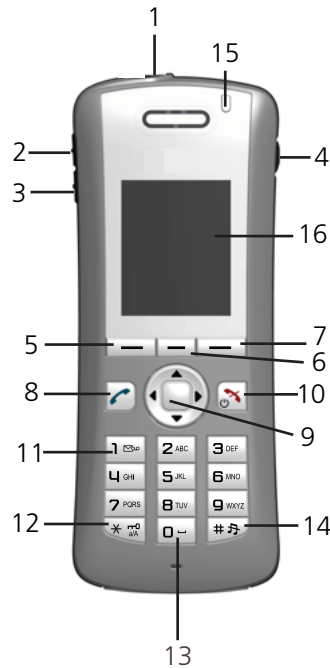

Figure 2. Description of the cordless telephone.

- 1 Multifunction button**  
This button can be used as a short cut to functions; long or double press modes.
- 2 Volume up**  
To increase the speaker volume
- 3 Volume down**  
To decrease the speaker volume
- 4 Headset connector**  
The headset connector is for connecting a headset. The connector is protected against dust by using the headset connector cover.
- 5 Left Soft key**  
Can be pre-programmed or used with GUI
- 6 Middle Soft key**  
Can be pre-programmed or used with GUI
- 7 Right Soft key**  
Can be pre-programmed or used with GUI
- 8 Off-hook key**  
To answer a call, to pre-dial a number, and as a short cut to the Call list.
- 9 Five-way navigation key**  
Navigation key with Left, Right, Up, Down, and Confirmation (in the middle). It is also possible to program these keys for short cuts, except the middle key.
- 10 On-hook; On/Off key**  
Combined button; to end a call, to return to standby mode, and to switch the telephone on/off by long press.
- 11 Voice mail access**  
To listen to a voice mail

- 12 Key lock and Upper/Lower case**  
Combined key lock and Upper/Lower Case
- 13 Space**  
To add space between text
- 14 Sound off**  
Turn off/on audible signals in idle mode, silencing the ring signal at incoming call, and also to turn the microphone on/off during a call.
- 15 LED**  
Indicates incoming call, messaging, low battery, and charging.
- 16 Colour display**  
The full graphic type display is 128 pixels wide and 160 pixels high. The display has multiple colours and backlighting.

### 3.1 The Cordless Telephone DT690

**IMPORTANT:** The telephone may retain small magnetic objects around the mouthcap or earcap region.

#### Case

The plastic cover parts are made of durable PC/ABS material.

#### Antenna

The antenna is integrated inside the cordless telephone.

#### Loudspeaker

The cordless telephone has a separate loudspeaker for the loudspeaking function. It is placed on the back side of the cordless telephone.

#### Microphone

The microphone is placed on the front bottom side of the cordless telephone.

#### Clip

There are three different belt clip options to the cordless telephone; a hinge-type clip (standard), a swivel-type clip, or no clip which makes it possible to use the cordless telephone without any clip on. See [13.4 Attach the Hinge-type Clip](#) on page 55, or [13.5 Attach the Swivel-type Clip](#) on page 55. Use the clip to attach the telephone to a belt or similar.

#### Battery

The battery is a rechargeable Li-Pol battery, placed under a battery cover. See [13.3 Replace the Battery](#) on page 54.

The battery is fully charged within four hours. See [13.1 Charge the Battery](#) on page 54.

The battery can be charged separately with a special battery charger. See [13.2 Charge Spare Batteries](#) on page 54

## 3.2 Chargers

### 3.2.1 Desktop Charger

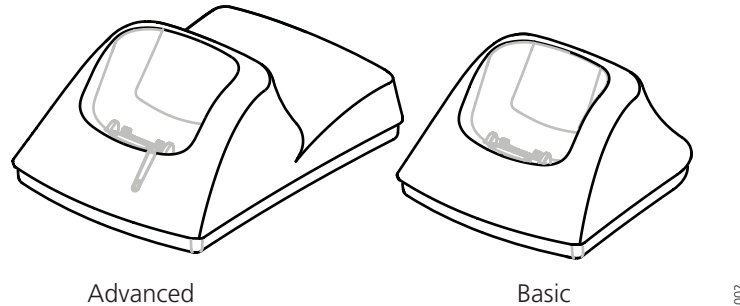

Figure 3. Desktop chargers.

There are two desktop chargers available, one basic that will only charge the cordless telephone, and one with advanced functionality to download new software and to synchronize parameters.

The charger is delivered with a plug-in power supply and is connected into an ordinary wall socket. For more information, see *Installation and Operation Manual, DC4 Desktop Charger, TD92481GB*.

**Note:** Only use the charger within the temperature range of +5° C – +40° C.

**IMPORTANT:** Only use the provided power supply, see *Installation and Operation Manual, DC4 Desktop Charger, TD92481GB*.

### 3.2.2 Rack Charger

The Charging Rack is used for charging several telephones, to synchronize parameters, and for software download.

The built in power supply can charge up to six cordless telephones.

See *Installation and Operation Manual, CR3 Charging Rack, TD92480GB*.

### 3.2.3 Battery pack Charger

The Battery pack charger is used for charging up to six spare batteries.

## 3.3 Icons and Text in the Display

All functions and settings available to the user are shown as icons and text in the display. The icons and text in the display indicate functions and settings to which you have access.

The display normally displays date and time, the Owner ID and telephone number. The Owner ID can manually be set by the user.

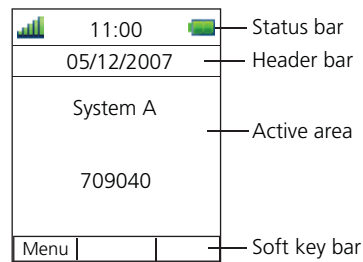

84

Figure 4. Example of a display configuration in standby mode.

















The top row (Status bar) is used for icons which give the user information for signal strength, missed call, new message, phone lock, key lock, sound off, time and battery status. This row is always visible in all screens.

The next row (Header bar) displays the current date, headset connection, Bluetooth connection, and system connection.

The next rows (Active area) are used for information such as the name of the system to which the cordless telephone is connected to. A user identity provided from the system and/or an Owner ID can also be displayed if configured in the Settings menu. This is also the area for pop up text for example, missed calls or to confirm an action.

The bottom row (Soft key bar) is used for Soft keys which can be used as short cuts for functions in the telephone. See [3.4.6 Soft Keys](#) on page 16.

## Icons

-  "Signal strength" icon is visible in the upper left corner. The staples shown in display depends on the signal strength.
-  "Full battery" icon is displayed in upper right corner.
-  "Low battery" icon is shown when the battery only has 5% of its capacity left. The icon is flashing when the battery capacity is equal to, or lower, than 5%.
-  "Sound off" icon is displayed when the Sound off key is pressed.
-  "Microphone off" icon indicates a silenced microphone. It is displayed after a long press on the Sound off key during a call.
-  "Loudspeaking" icon is displayed in the soft key bar during a call. Pressing this icon will activate the loudspeaking mode.
-  "Loudspeaking off" icon is displayed after the soft key for Loudspeaking icon has been pressed. Pressing this icon will deactivate the loudspeaking mode.
-  "New message" icon indicates that a new text message (or messages) has arrived. The icon remains in the status bar until all new messages in the inbox are read.
-  "Voice mail message" icon is displayed in the inbox when there are voice mails. The icon remains until voice mail has been listened.
-  "Read message" icon in front of a message shows that this message once has been read.
-  "Key lock" icon indicates a locked keypad.
-  "Phone lock" icon indicates a locked telephone.
-  "Bluetooth" icon indicates that Bluetooth is enabled.
-  "Bluetooth headset" icon indicates that a Bluetooth headset is connected to the telephone.
-  "Headset" icon indicates that a corded headset is connected to the telephone.
-  "Outgoing call" icon is added to all outgoing calls in the call list.
-  "Incoming call" icon is added to all answered calls in the call list.





"Missed call" icon is added to all missed calls in the call list, and in the status bar.



"System connection" icon is visible when connecting to a system.

### Menu icons



The "Contacts" menu contains all names/numbers in the personal phonebook. It is also possible to access a central phonebook from this menu.



The "My favourites" menu contains menu short cuts used to customize an own menu.



The "Messaging" menu contains all message handling such as reading and writing messages.



The "Calls" menu contains call lists, call time, and call services\*. Call services is configured in the PDM.



The "Connections" menu contains Bluetooth connection, headset selection, System selection, and In charger selection.



The "Settings" menu contains personal telephone settings such as changing the ringer volume, selecting language, etc.



The "Short cuts" menu contains short cuts for the Soft keys, Hot keys, Navigation keys, and the Multifunction button.



The "Profiles" menu contains possibility to add four different profiles. By default there is no profile.

\* System dependent.

### 3.4 Keys and Buttons

#### 3.4.1 Off-hook Key



This key is used for connecting calls. One short press in standby mode opens the call list.

#### 3.4.2 On-hook, and On/Off Key



This key is used for disconnecting calls and returning to main screen. A long press in standby mode will switch the telephone on/off.

#### 3.4.3 Navigation/Confirmation Key



Use this key to step in the menu and when working in text mode.

◀, ▶, ▲, and ▼ are used for stepping left/right and up/down in the menu. The navigation key can be programmed, the ▲ is by default a short cut to the Inbox, and ▼ is a short cut to Call contact. During a call it is possible to increase/decrease the volume by pressing ▲ and ▼.

The middle key is for confirmation and in standby mode it is by default a short cut to the main menu.

#### 3.4.4 Sound off Key



A long press on the key in standby mode will silence the telephone.

#### 3.4.5 Key Lock, and Upper/Lower Case Key



This key is to lock the keypad in combination with the Soft key "Lock". It is also for switching between upper/lower case and digits.

#### 3.4.6 Soft Keys

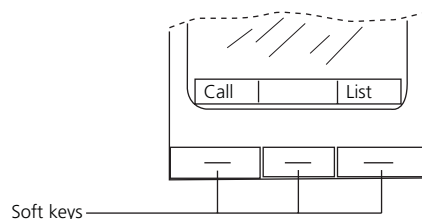

003

Figure 5. Soft keys.

The three Soft keys are located just beneath the display and the functions of each Soft key is indicated by text in the display just above the keys.

In stand-by mode the Soft keys can be used for specific functions defined by the user of the telephone.

#### **3.4.7 Hot Keys**

A Hot Key can be programmed to give access to frequently used functions such as dialling a specific telephone number, a short cut on the menu, or sending an SMS. Any key "0", "2" - "9" can be set to a Hot Key. A long press on any of these digits in stand by mode are by default a short cut to the Call contact list.

#### **3.4.8 Multifunction Button**

This button can be used as a short cut to functions; long or double press modes. It is by default not used, but can be defined by the user of the telephone.

#### **3.4.9 Volume Button**

The two buttons placed on the upper left side of the cordless telephone are used for increasing/decreasing the earpiece, headset, and the loudspeaker volume.

### 3.5 Alphanumeric Keys

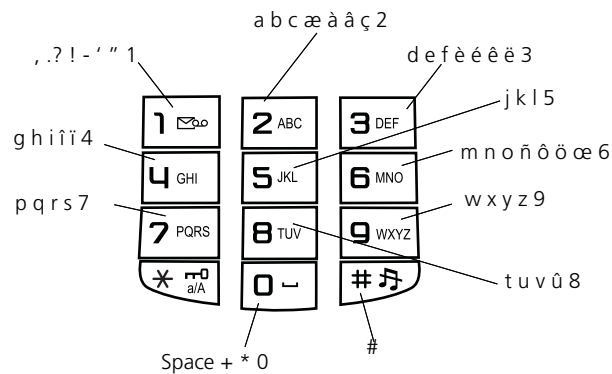

006

Figure 6. Available characters.

**Note:** Depending on the selected menu language, other characters can be available. This means that the character order can differ from the table above.

#### In standby mode, and number input mode

- A short press on a key enter the digits "0" - "9" and the characters \* and #.
- Enter a pause in number input mode by a long press on the # -key. A pause is indicated by a "P" in the display.
- A long press on the \* - key changes the tone sender on. Tone sender on is indicated by a "T" in the display.

#### In text input mode

- A short press on a key 0-9, displays the first available character on that specific key. The marked character is selected after a timeout, or when another key is pressed.
- To change to upper/lower case, press the \* -key before entering the character. The \*-key can also be used to display only the digits.
- To add space in the text, make a short press on key 0.
- The first character entered in a message, or when adding/editing a name in the Contacts menu, will be an upper level character followed by lower level characters, unless the \* -key is pressed before entering the character. To switch between Abc, ABC, abc, and 123 the \*-key is pressed.
- A long press on the #-key displays special characters.

### 3.6 Accessories

#### 3.6.1 Belt Clips

Three belt clip options are available:

- Hinge-type clip  
To prevent the telephone from slipping out of for example pocket or belt

- Swivel-type clip  
To be able to rotate without slipping out from the case
- No clip  
To be able to use the telephone without a clip

### **3.6.2 Security String**

The security string is 800 mm long. The security string is attached directly to the telephone.

### **3.6.3 Leather Casing**

The leather casing is especially designed for the telephone. The casing comes with a swivel type belt clip and the telephone is fully operational while placed in the casing.

### **3.6.4 Headset**

A headset is recommended if you frequently use the telephone and/or want to have both hands free. The headset comes in two versions; microphone integrated in the cable, and microphone on a boom.

## 4 Menu Tree

### 4.1 Calls

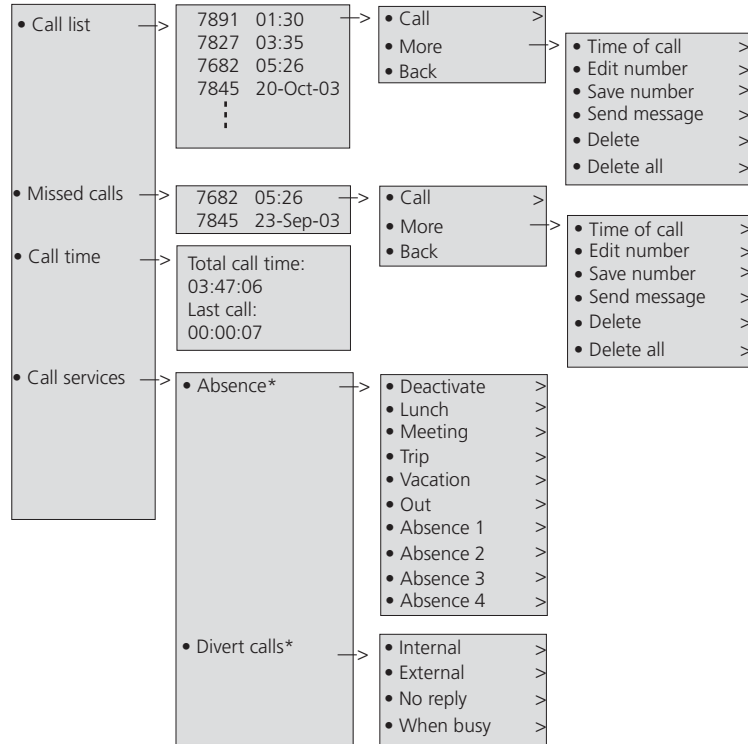

\* Visible if defined in the PDM

## 4.2 Contacts

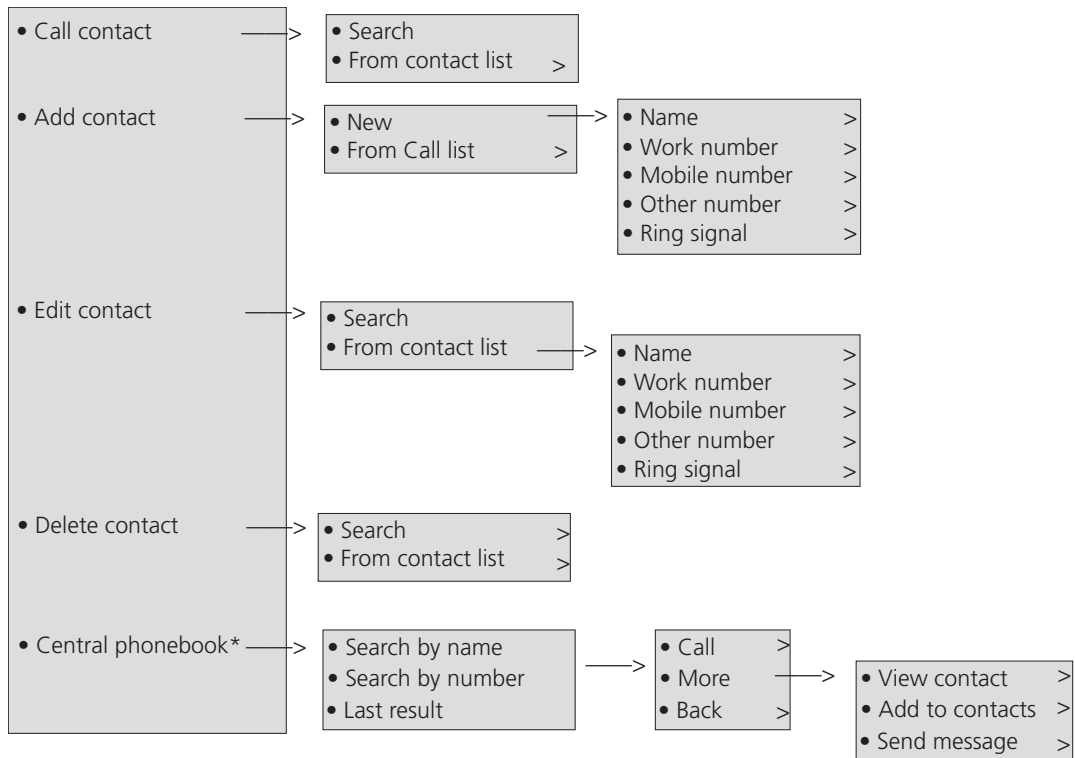

## 4.3 Profile

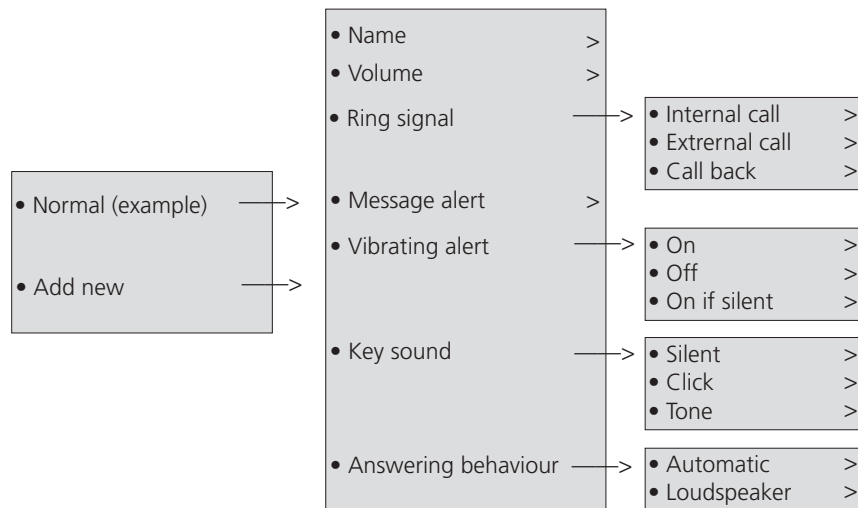

## 4.4 Messaging

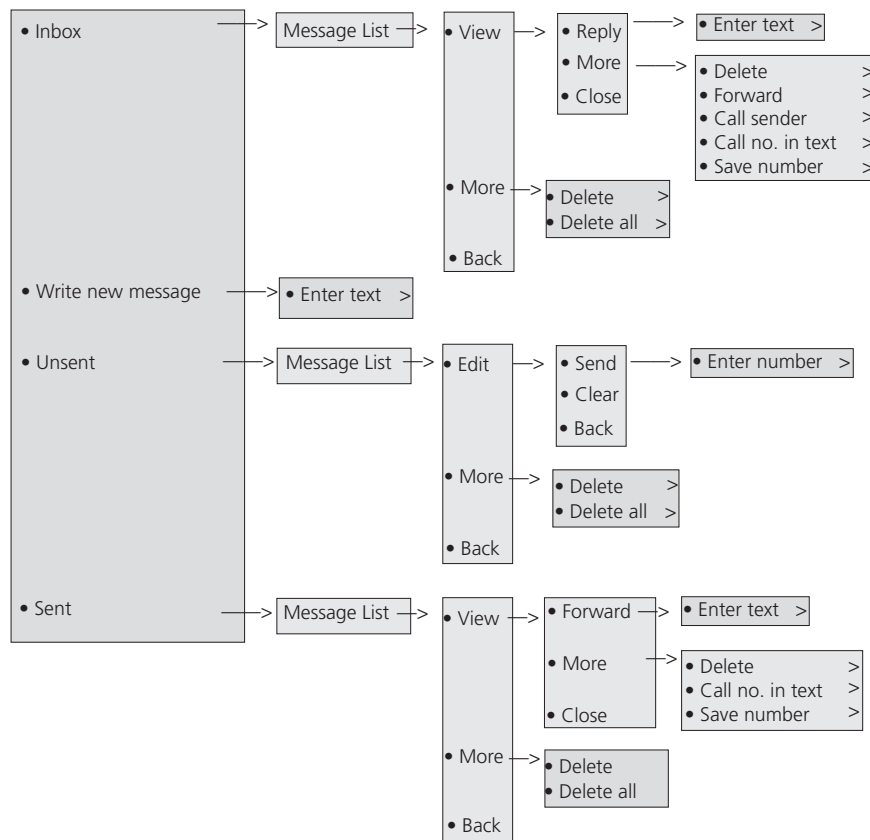

## 4.5 My favourites

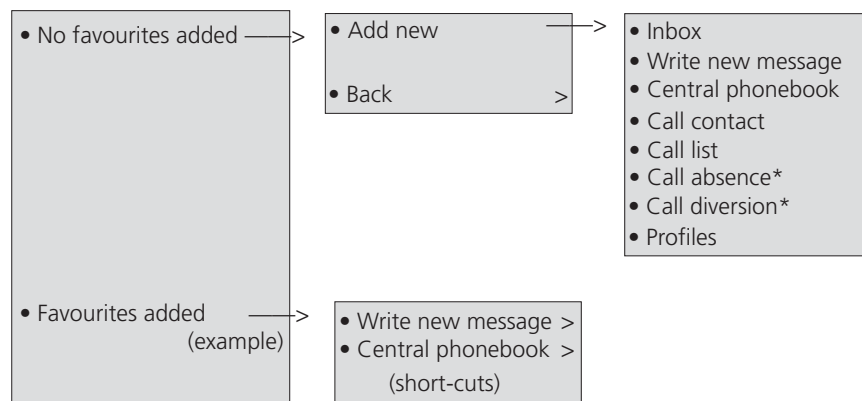

\* Defined in the PDM



## 4.6 Short cuts

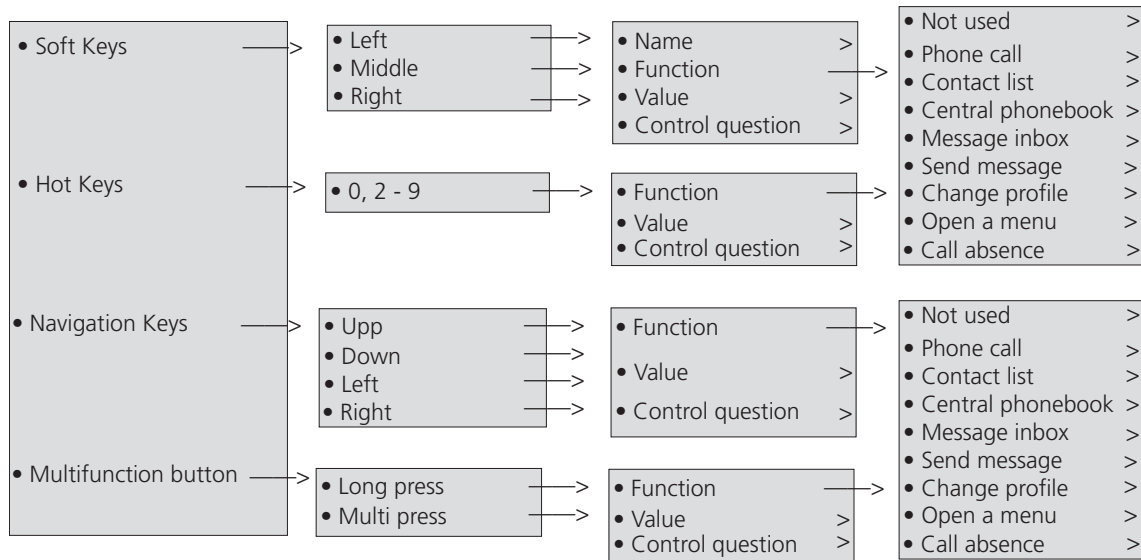

## 4.7 Connections

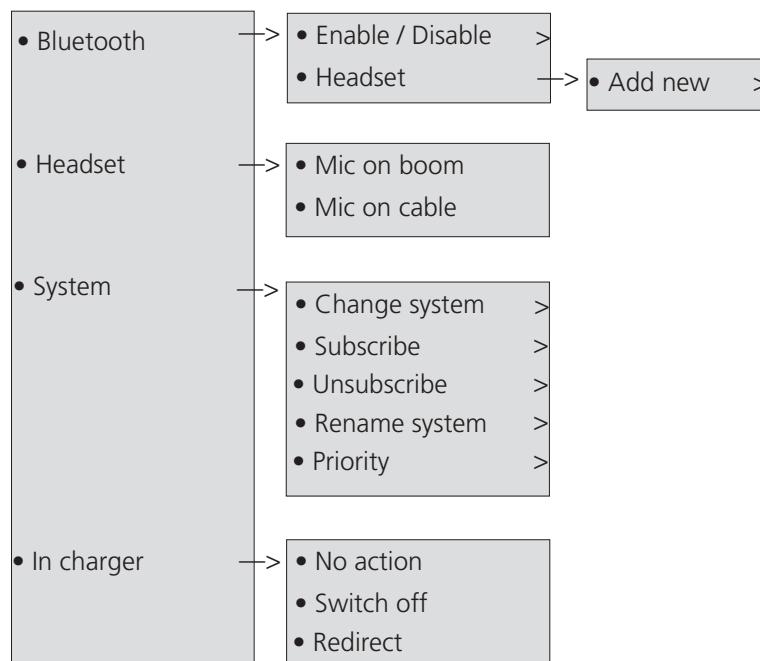

## 4.8 Settings

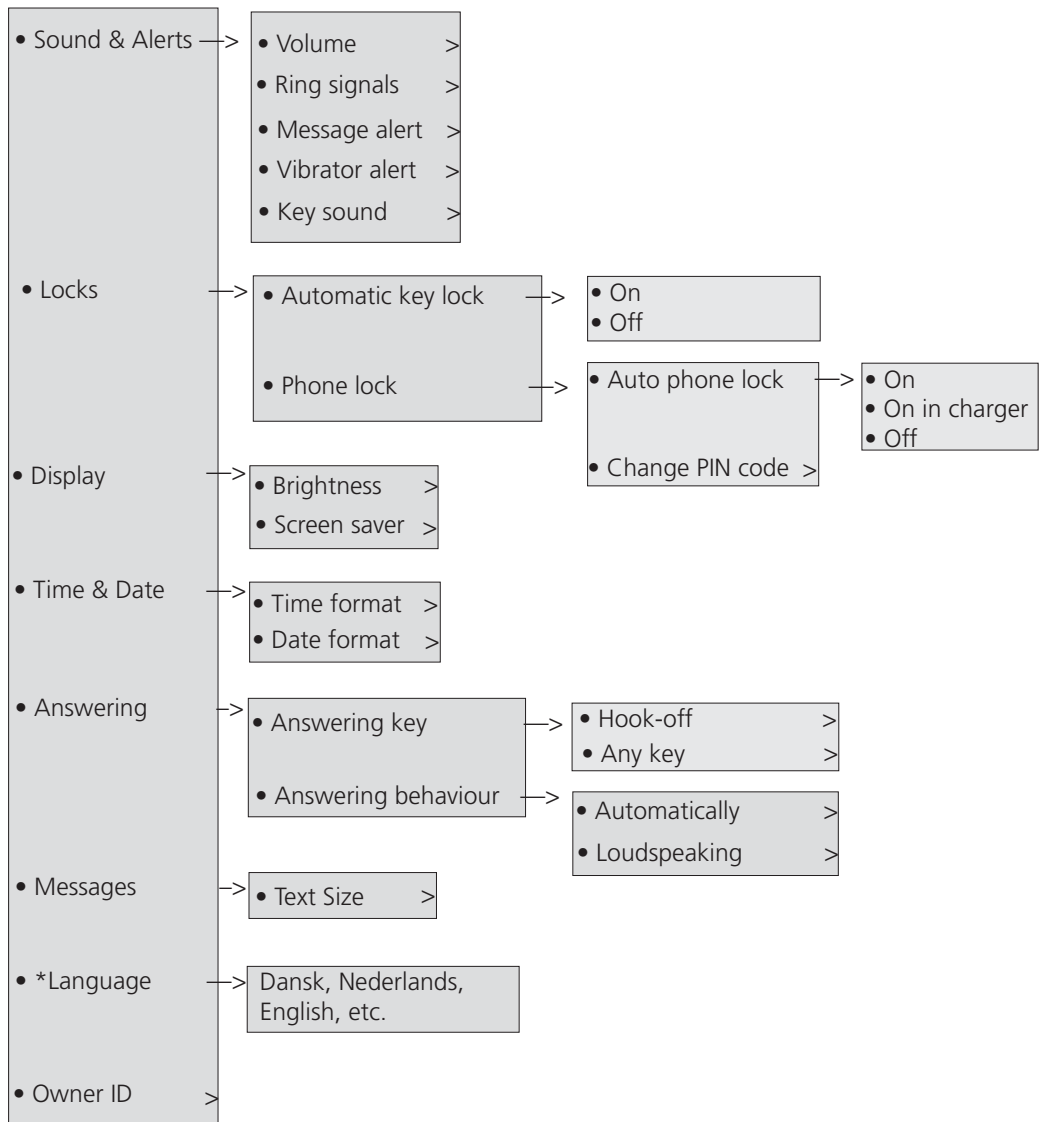

## 4.9 In Call

The In Call menu can be reached during an ongoing call by pressing the middle Soft Key marked "More".

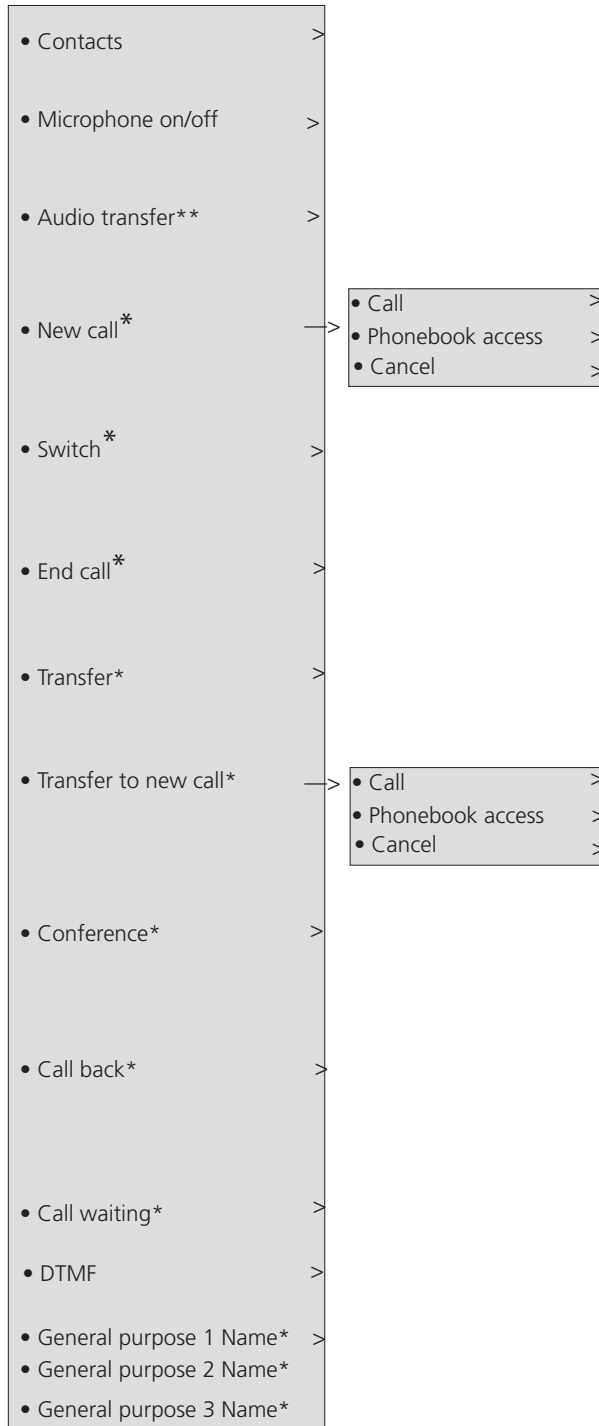

\*\*Only available when Bluetooth connection is active.

\* Visible if defined in the PDM

## 5 Basic Operation

### 5.1 Switch the Telephone On/Off

Press , the telephone will vibrate when it is on and the display lights up. A long press in standby mode will turn the telephone off, a control question will first be displayed to confirm switch On/Off.  
It also returns to standby mode when pressing the key while in a menu.

#### 5.1.1 Turn the Audible Signal On/Off

A long press on the Sound off key  in stand-by mode, changes between ring signal on/off.

The  icon indicates a silenced telephone.

### 5.2 Lock/Unlock the Keypad

To prevent accidentally pressing keys and making a call, the keys can be locked.

#### Lock keypad

Press  and then Softkey "Lock".

#### Unlock keypad

Press  and then Softkey "Yes".

**Note:** It is possible to call an emergency call and to answer/close an incoming call while the keypad is locked.

### 5.3 Lock/Unlock the Telephone

Enter the "Settings" menu, see [4.8 Settings](#) on page 24, and select "Locks". Select "Phone lock".

## 6 Calling

### 6.1 Open the Call List

The 25 last received, dialled or missed calls are stored in a call list.

Press  to open the call list. Step with ▼ and select one of the numbers.

If a number occurs more than once the last time stamp, together with the total number of occurrences, is shown. Press the soft key "Call" to dial.

The call list can also be accessed via the *Calls* info menu, see [8.2 Calls](#) on page 37.



### 6.2 Incoming Call

The flashing LED, accompanied by a ring signal and/or a vibrating telephone, give you notice of a call. Ring signal and vibrator can be disabled. The calling party's telephone number or name is shown. The name will be shown if the calling party's telephone number is stored in the local phonebook. Press the Off-hook key to answer the call. When a headset is connected to the telephone, the answering button on the headset can be used to answer the call.

Other answering methods can also be set in the Settings menu, see [4.8 Settings](#) on page 24. The answering methods are; Automatically and Loudspeaking.

When "Automatically" is enabled, all incoming calls will be connected automatically.

#### 6.2.1 Answer a Call

When the signal sounds press  to answer the call, or press the Soft key  to answer the call in loudspeaking mode. The name/number of the calling party is displayed if calling line information is available.

#### 6.2.2 End a Call

Press  end the call. The duration of the call is shown in the display. The total time of the call can also be retrieved from the Calls menu > Call time.

### 6.3 Outgoing Call

#### 6.3.1 Pre-Dial

Enter the number and press  to get the line. The number is shown on the display while dialling. If needed, you can press the Soft key "Clear" to erase the number. By using the navigation key it is possible to step and add/delete a digit in the middle of a number.

It is possible to turn on the tone sender in a pre-dialled number by making a long press on the \*-key.

#### 6.3.2 Dial Using a Pre-programmed Hot key, Soft key or Multifunction button

A Hot key, Soft key or Multifunction button can be programmed with a telephone number. Press the pre-programmed Hot key, Soft key or multifunction button to dial the number. The call will automatically be connected.

### 6.3.3 Dial a Number from the Call list

Press , select a number and press the same key or Soft key "Call" to dial. The number can be edited before the call is started. Press "More" and select "Edit number".

### 6.3.4 Dial the sender of a Message

You can call the sender of a message stored in the message list, from the Messaging menu.

- 1 Open the menu by pressing the confirmation button, or the Soft key "Menu".
- 2 Select "Messaging".
- 3 Select "Inbox".
- 4 Select number from the list.
- 5 Select "View".
- 6 Select "More".
- 7 Select "Call sender".

### 6.3.5 Dial a Number from the Local Phonebook

- 1 Open the menu by pressing the confirmation button, or the Soft key "Menu".
- 2 Select "Contacts".
- 3 Select "Call contact".
- 4 Select contact from list, or search name/number by entering characters and select search.
- 5 Press the Soft key "Call" or the Off-hook key to make the call.

### 6.3.6 Dial a Name from the Central Phonebook

- 1 Open the menu by pressing the confirmation button, or the Soft key "Menu".
- 2 Select "Contacts".
- 3 Select "Central phonebook".
- 4 Select "Search by name".
- 5 Enter the first name and/or last name, the whole name does not have to be entered.
- 6 Press "Search".
- 7 Press the soft key "Call" or Off-hook key to make the call.

## 6.4 During a Call

**Note:** Some of these functions are system dependent. The parameters are set up in the Portable Device Manager (PDM), see *Configuration Manual, Cordless telephone DT690, TD 92503GB*, and *Installation and Operational Manual, Portable Device Manager (PDM), Windows version, TD 92325GB*.

### 6.4.1 Adjust the Volume during a Call

Press the "Volume up" button to increase the volume, and the "Volume down" button to decrease the volume. The telephone will now store and keep the new volume level. It is also possible to use the navigation key, ▲ and ▼ to adjust the volume.

### 6.4.2 Open Contacts during the Call

Press the soft key "More" during the call, and select "Contacts". Press "Select". See [8.7 Contacts](#) on page 44.

### 6.4.3 Turn the Microphone on/off during a Call

Press the soft key "More" during the call, and select "Microphone off". Press "Select".

The  indicate a silenced microphone. This means that the other part in an ongoing call cannot hear you. To turn the microphone back on, press the soft key "More" during the call, and select "Microphone on". Press "Select".

It also possible to turn the microphone off/on by a long press on .

### 6.4.4 Audio Transfer

To transfer audio between the Bluetooth headset and the telephone's earpiece.

Press the soft key "More" during the call, and select "Audio transfer"<sup>1</sup>. Press "Select".

### 6.4.5 Start a New Call during Conversation

Press the soft key "More" during the call, and select "New Call"<sup>2</sup>. Press "Select".

Dial the number and press .

### 6.4.6 Switch between Calls

A new call is started during conversation, the first call is on hold.

Press the soft key "More", and select "Switch"<sup>2</sup>. Press "Select". This will switch between the calls.

### 6.4.7 End a Call

A new call is started during conversation, the first call is on hold.

Press the soft key "More" during the call, and select "End Call"<sup>2</sup>. Press "Select". This will end the current call and the previous call is resumed.

---

1. Visible if Bluetooth connection is active.

2. Visible if defined in the PDM.

#### 6.4.8 Transfer a Call

A new call is started during conversation, the first call is on hold.

Press the soft key "More", and select "Transfer"<sup>2</sup>. Press "Select". This will connect the first caller with the person you want to transfer the call to.

#### 6.4.9 Transfer to new Call

Press the soft key "More" during the call, and select "Transfer to new call"<sup>2</sup>. Press "Select".

Dial the number to the person you want to transfer the call to. Press  to transfer the call.

#### 6.4.10 Conference Call



A new call is started during conversation, the first call is on hold.

To connect a conference call, press the soft key "More" and select "Conference call"<sup>2</sup>. Press "Select".

The person initiating the conference call is the conference leader, and the other are participant members of the conference call.

#### 6.4.11 Call Back

To enable call back when a call is made to a busy telephone, and to be alerted when the telephone is free; Press the soft key "More" during the call, and select "Call back"<sup>2</sup>. Press "Select".

Press  and wait until the telephone alerts. When the telephone alerts, press  and the call will automatically be started.

#### 6.4.12 Call Waiting

During a call and the line is busy, press the soft key "More", and select "Call waiting"<sup>2</sup>. Press "Select". The other part will get a "Call waiting" signal.

When the line is free it will automatically call the number again. This is system dependent.

#### 6.4.13 DTMF

Press the soft key "More" during the call, and select "DTMF". Press "Select". This will enable the use of Dual Tone Multi Frequency (DTMF) signals.

### 6.5 Loudspeaking Function

An incoming call can be connected with loudspeaking function active by pressing left Soft key. During a call, a press on the left Soft key activates the loudspeaking function. Press the left Soft key again to turn it off.

You can also activate this function by selecting another answering method, see [8.8.5 Answering](#) on page 49.



## 6.6 Call Diversion

All calls; internal calls, external calls, calls when busy, or calls at no answer can be diverted to another telephone number. The diversion is made via the Calls menu > Call services > Divert calls. See [8.2.4 Call Services](#) on page 39.

It is also possible to programme a Soft key, Hot key, or Multifunction button with a short cut to the "Call diversion" function. Refer to [8.3 Short Cuts](#) on page 40, and [Divert Internal/External Calls](#) on page 39.

## 7 Messaging

### 7.1 Message List

The thirty last received messages are stored in a list. The message list is located in the Messaging menu "Inbox". Time and date information is included in the message.

### 7.2 Receive a Message

When a text message is received, the LED starts flashing and the message alert signal sounds. The "New message" icon, and a text with information of received message are displayed. The icon will remain in the display until all new messages are opened. If the message is received during a call a beep notifies the user.

The message can be read by selecting "Yes". It is possible to reply, forward the message, call the sender, and call number in text. It is also possible to read the message later by selecting "No". The message will in both cases be stored in the Inbox.

#### 7.2.1 Read a Stored Message

Enter "Messaging" in the menu, see [4.4 Messaging](#) on page 22, and select "Inbox". Select stored message, and press "View" to read the message.

#### 7.2.2 Reply to a Message

To reply when receiving a message, press "Yes", see [4.4 Messaging](#) on page 22. Press "Reply", enter message, press "Send", enter number, and press "Send" again. See [7.2.8 Write and Send a Message](#).

#### 7.2.3 Delete Message(s)

Enter "Messaging" in the menu, see [4.4 Messaging](#) on page 22, and select "Inbox", select message to delete and press "More". Select "Delete" and press "Yes" for confirmation. The Message is deleted. To delete all messages in the list, select "Delete all" and press "Yes" for confirmation.

#### 7.2.4 Forward a Message

Enter "Messaging" in the menu, see [4.4 Messaging](#) on page 22, and select "Inbox" > message > "View". Press "More" and select "Forward", write additional text, see [7.2.8 Write and Send a Message](#). Press "Send", enter number, and press "Send" to forward the message.

#### 7.2.5 Call the Sender of the Message

Enter "Messaging" in the menu, see [4.4 Messaging](#) on page 22, and select "Inbox", select message and press "More". Select "Call sender".

#### 7.2.6 Call a telephone number included in a Message

If the sender has written a telephone number in the message it is possible to call the number without dialling it. Select "View" > "More" > select "Call (No. in text)", and select "Call".

### 7.2.7 Save Number

Enter "Messaging" in the menu, see [4.4 Messaging](#) on page 22, and select "Inbox" > message > "View". Press "More" and select "Save number". Select "Work number"/ "Mobile number"/ "Other number". Add name and press "OK". Add number and press "OK" and then press "Save". The number will be saved in the contact list. See [8.7.2 Add Contact](#) on page 45.

### 7.2.8 Write and Send a Message

Enter "Messaging" menu, see [4.4 Messaging](#) on page 22, and select "Write new message". Write the message. Keys 0-9, \* or # can be used. Key 0 and 1 contains special characters, see [3.5 Alphanumeric Keys](#) on page 18 to see all characters.

The maximum message length is 160 characters.

**Note:** Some characters require 2 bytes in the final message, therefore the user will sometimes not be able to enter 160 characters.

The first character entered will be an upper level character followed by lower level characters unless the \* -key is pressed before entering the character.

When pressing a key, the first available character on that specific key is displayed, see [3.5 Alphanumeric Keys](#) on page 18. To get any of the other characters on that key, press the key until that character appears in the display.

Example: to get the character E, press key 3 twice. "E" appears in the display and is selected after a timeout or when another key is pressed.

To delete a character, press "Clear".

Press "Send", enter the call number and press "Send" to send the message.

### 7.2.9 Open a Sent Message

Enter "Messaging" menu, see [4.4 Messaging](#) on page 22. Select "Sent" and select message. Press "View" to read the message.

### 7.2.10 Send to Another Destination

Enter "Messaging" menu, see [4.4 Messaging](#) on page 22. Select "Inbox" or "Sent" and select message. Press "More", and select "Forward", then press "Send". Enter the number and press "Send".

## 7.3 Voice Mail

### 7.3.1 Receive a Voice Mail

A new voice mail is indicated by  new message icon in the status bar. Information is stored in the "Messaging" inbox, see [4.4 Messaging](#) on page 22. The Voice Mail is dialled by a long press on digit key "1" in Idle mode, or from the Inbox menu.

### 7.3.2 Check the Voice Mail inbox

Enter "Messaging" menu, see [4.4 Messaging](#) on page 22, and select "Inbox". The voice mail will be displayed first in the inbox list, select  icon "Voice Mail", press "View", and then "Call".

Only one voice mail at the time will be displayed, even if there are more voice mail messages in the message list.

### 7.3.3 One Key Voice Mail Access

If the mailbox extension number is downloaded to the telephone, see *Configuration Manual, Cordless Telephone DT690, TD92503GB*.

A long press on digit key "1" in Idle mode will call your voice mail. If the extension number is not available a pop-up "Voice mail number not defined" is displayed.

## 7.4 Contacts

The telephone has a personal phonebook with 250 entries, where names and numbers freely can be added, deleted, and edited by the user. The phonebook lists all names in alphabetical order, where three numbers can be added for each contact; work number, mobile number, and other number.

It is also possible to access a central phonebook, see [4.2 Contacts](#) on page 21. The user then sends a request to a messaging server with the first characters entered, and the messaging server will return a list of names and numbers that matches the search.

### 7.4.1 Add Contact

Enter "Contacts" in the menu, and select "Add contact". Select "From call list" or "New". Select contact from the list and press "Add". Select "Work number", "Mobile number" or "Other number", and press "Add". Enter name and press "OK", then press "Save".

If "New" is chosen, press "Add", and enter the name, see [3.5 Alphanumeric Keys](#) on page 18. Press "OK" and then select "Work number", "Mobile number" or "Other number", and press "Add". Enter number and press "OK", then press "Save".

### 7.4.2 Edit Contact

Enter "Contacts" menu, see [4.3 Profile](#) on page 21, and select "Edit contact". The names in the Contacts are shown in alphabetical order. To search in the list, enter the first character(s) in the name, or select from list. Press "Edit", and select name/number. Press "Edit", enter new name/number and press "OK". Press "Save".

### 7.4.3 Delete Contact

Enter "Contacts" menu, see [4.3 Profile](#) on page 21, and select "Delete contact". The names in the list are shown in alphabetical order, step with and select Name/Number. To search in the list, enter the first character(s) in the name. The name/number is displayed, press "Delete", and press "Yes" to delete the contact.

## 8 Menu Operation

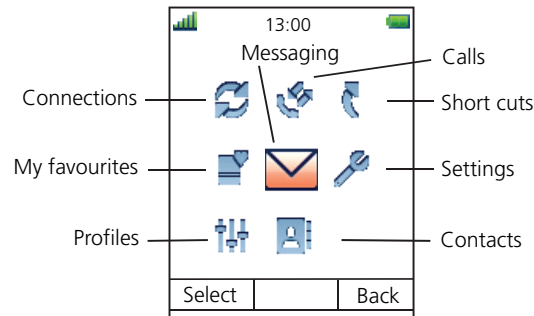



Figure 7. The main menu.

### 8.1 Connections

- 1 Enter the menu by pressing the "Menu" Soft key, or the confirmation button on the Navigation key.
- 2 Select  in the menu, and press the confirmation button or the Soft key "Select".

#### 8.1.1 Bluetooth

Bluetooth is optional, this function is only visible in the menu if Bluetooth is ordered with the telephone. See also [Appendix A](#).

##### Enable Bluetooth Connection

- 1 Select "Bluetooth".
- 2 Select "Enable". A Bluetooth connection icon  will be displayed in the header bar.

##### Disable Bluetooth Connection

- 1 Select "Bluetooth".
- 2 Select "Disable".

##### Connect Bluetooth Headset

This can only be done if Bluetooth connection is enabled and if the Bluetooth headset is in pairing mode. See [Enable Bluetooth Connection](#) and User manual for the Bluetooth headset.

- 1 Select "Bluetooth".
- 2 Select Headset.
- 3 Select "Add new". An information text "Put headset in Pairing mode" is displayed.
- 4 Press "OK". It will now search for a Bluetooth headset for connection.
- 5 When headset is found, press "Pair".
- 6 Enter PIN code, see User manual for the Bluetooth headset.
- 7 Press "OK". "Successful pairing" will be displayed if the pairing mode was successful.

### 8.1.2 Headset

- Mic on boom
- Mic on Cable
- Customized headset profile<sup>1</sup>

- 1 Select "Headset".
- 2 Select headset from list.
- 3 Press "Select".

### 8.1.3 System

#### Change System

Select "Automatic" or a specific system. If the telephone is set to "Automatic" it selects a system according to the priority list, see [Priority](#) on page 37.

#### Subscribe System

The cordless telephone can subscribe up to eight different systems. To subscribe a new system the "Park:" (Portable Access Right Key) and "Ac:" (Authentication code) related to the system you are going to log on to are needed. Contact your system administrator for more information.

The IPEI code is a unique code which has been assigned to the cordless telephone, see also [9.1 Admin Menu](#) on page 50.

- 1 Enter System name. Press "next".
- 2 Enter PARK code.
- 3 Enter AC code. Press "Next".  
An information text "Protection on?" is displayed.
- 4 Select "Yes"/"No", if the new system is to be protected. It is not possible to delete a protected subscription.
- 5 Press "OK". A searching mode starts.

#### Unsubscribe System

- 1 Select "Unsubscribe" to delete a System subscription.
- 2 Select "Delete".

---

<sup>1</sup>.Only visible if the headset profile has been configured in the PDM.

### **Rename System**

It is possible to change the name of the system in the telephone.

- 1 Select "Rename System".
- 2 Select system to rename.
- 3 Enter new name.
- 4 Select "Save".

### **Priority**

The default order of priority is the order of entered subscriptions. This means that the first subscribed system has the highest priority. This list can be edited by the user. It is possible to set the systems in priority by moving them up or down in the list.

**Note:** This is used in combination with system set to be "Automatic", see [Change System](#) on page 36.

- 1 Select "Priority".
- 2 Change the priority if needed by selecting "Up" or "Down". The priority will be saved when "Back" is selected.

## **8.1.4 In Charger**

### **Redirect Calls and Messages when Placed in Charger**

Calls can be redirected to another extension when the cordless telephone is placed in a charger. The function is automatically cancelled when the telephone is removed from the charger.

- 1 Select "In charger".
- 2 Select "Redirect".

### **Switch off While Charging**

When the cordless telephone is placed in the charger it can be switched off while it is charging. When it is removed from the charger it will switch on again.

- 1 Select "In charger".
- 2 Select "Switch off".

### **Deactivate the Charging Mode**

- 1 Select "In charger".
- 2 Select "No action".
- 3 Press "Select" to save the setting.

## **8.2 Calls**

- 1 Enter the menu by pressing the "Menu" Soft key, or the confirmation button on the Navigation key.
- 2 Select  in the menu, and press the confirmation button or the Soft key "Select".

### 8.2.1 Call List

- 1 Select Call list, and step with the ▲ and ▼ to scroll in the list.

#### View the Time of a Call

- 1 Press the Soft key "More".
- 2 Select "Time of call". The time and date is displayed.

#### Edit Number from Call list

- 1 Press the Soft key "More".
- 2 Select "Edit number".

#### Save Number

- 1 Press the Soft key "More".
- 2 Select "Save number".

#### Send Message

- 1 Press the Soft key "More".
- 2 Select "Send message".

#### Delete Entry from the Call list

- 1 Press the Soft key "More".
- 2 Select entry to delete.
- 3 Select "Delete".
- 4 Select "Yes" to delete the entry from the list.

#### Delete all Entries from the Call list

- 1 Press the Soft key "More".
- 2 Select "Delete all".
- 3 Select "Yes" to delete all the entries from the list.

### 8.2.2 Missed Calls

- 1 Select Missed calls, and step with the ▲ and ▼ to scroll in the list.
- 2 Press the Soft key "Call" to call back.

As in Call List there is a Soft key "More" which can be used to view the time/date of the call, edit the received number, add to contacts, delete received numbers. See [8.2.1 Call List](#) on page 38 for information about the functionality in Soft key "More".

### 8.2.3 Call Time

The total time of the previous call and last call is displayed.

- 1 Select "Call time".



## 8.2.4 Call Services

**Note:** These functions are system dependent. The parameters are set up in the Portable Device Manager (PDM), see *Configuration Manual, Cordless telephone DT690, TD 92503GB, and Installation and Operational Manual, Portable Device Manager (PDM), Windows version, TD 92325GB.*

### Absence Handling

The reason for being absent and the return time can be specified here.

- 1 Select "Call services".
- 2 Select "Absence".

If the cordless telephone is preprogrammed a number of absence reasons can be displayed, for example "Lunch", "Meeting", "Trip" etc. Press "Select", enter time or date.

### Deactivate the Absence Setting

- 1 Enter "Call service" in the menu and select "Deactivate". Press Select".

### Divert Calls

The user can divert calls to another extension.

- 1 Select "Divert calls".

### Divert Internal/External Calls

- 1 Select "Internal/External".
- 2 Select "Activate".
- 3 Enter number to divert to.
- 4 Press "OK"

To stop diversion select "Deactivate" and press the confirmation button or the Soft key "OK".

### Divert Calls if No Reply

- 1 Select "No reply".
- 2 Select "Activate" and press "OK".
- 3 Enter number to divert to.
- 4 Press "OK"

To stop diversion select "Deactivate" and press the confirmation button or the Soft key "OK".

### Divert Calls When Busy

- 1 Select "When busy".
- 2 Select "Activate" and press "OK".
- 3 Enter number to divert to.
- 4 Press "OK"

To stop diversion select "Deactivate" and press the confirmation button or the Soft key "OK".

## 8.3 Short Cuts

Predefined functions can be set as short cuts for the Soft keys, Hot keys, Navigation keys, and the Multi-function button. It is for example possible to define the soft key to make a call or as a short cut to send a message.

- 1 Enter the menu by pressing the "Menu" Soft key, or the confirmation button on the Navigation key.
- 2 Select  in the menu, and press the confirmation button or the Soft key "Select".

### 8.3.1 Define Soft Keys

- 1 Select "Soft keys".
- 2 Select "Left", "Middle", or "Right".
- 3 Press "Select" to enter a name for the Soft key.
- 4 Press "OK".
- 5 Select "Function", and press "Select" to select function for the Soft key.
- 6 Select function from list, and press "Back".
- 7 Select "Value" (only for some of the functions), and press "Select". Enter a value for example a telephone number. Press "Back".
- 8 Select "Control question", and press "Select". It is off by default. Press "Back".
- 9 Press "Save".

### 8.3.2 Define Hot Keys

- 1 Select "Hot keys".
- 2 Select "0", "2" to "9".
- 3 Select "Function", and press "Select" to select function for the Soft key.
- 4 Select function from list, and press "Back".
- 5 Select "Value" (only for some of the functions), and press "Select". Enter a value for example a telephone number. Press "Back".
- 6 Select "Control question", and press "Select". It is off by default.
- 7 Press "Save".

### 8.3.3 Define Navigation Key

- 1 Select "Navigation keys".
- 2 Select "Up", "Down", "Left", or "Right".
- 3 Select "Function", and press "Select" to select function for the Soft key.
- 4 Select function from list, and press "Back".
- 5 Select "Value" (only for some of the functions), and press "Select". Enter a value for example a telephone number. Press "Back".
- 6 Select "Control question", and press "Select". It is off by default.
- 7 Press "Save".

### 8.3.4 Define Multi-function Button

The Multi-function button can be defined with two different functions, a long press activates one function, and a double press activates another function.

- 1 Select "Multi-function button".
- 2 Select "Long press", or "Multi press".
- 3 Select "Function", and press "Select" to select function.
- 4 Select function from list, and press "Select" and then press "Back".
- 5 Select "Value" (only for some of the functions), and press "Select". Enter a value for example a telephone number. Press "Back".
- 6 Select "Control question", and press "Select". It is off by default.
- 7 Press "Save".

## 8.4 My Favourites

With this menu it is possible to customize your own menu with functions that are used often. A list of predefined functions are available for example, Write new message, Central phonebook, Call contact, etc.

- 1 Enter the menu by pressing the "Menu" Soft key, or the confirmation button on the Navigation key.
- 2 Select  in the menu, and press the confirmation button or the Soft key "Select".

### 8.4.1 Add Favourite

- 1 Select "Edit favourites".
- 2 Mark a menu box by using the ▲ and ▼ on the navigation key.
- 3 Press "Change", or the confirmation button to check the box.
- 4 Press "Back".

### 8.4.2 Delete Favourite

- 1 Select "Edit favourites".
- 2 Mark a menu box by using the ▲ and ▼ on the navigation key.
- 3 Press "Change", or the confirmation button to un-check the box.
- 4 Press "Back".

## 8.5 Messaging

- 1 Enter the menu by pressing the "Menu" Soft key, or the confirmation button on the Navigation key.
- 2 Select  in the menu, and press the confirmation button or the Soft key "Select".

### 8.5.1 Inbox

- 1 Select "Inbox" to view the message list.
- 2 Select a message by using the ▲ and ▼ on the navigation key.

### **Reply to Sender**

- 1 Select "View".
- 2 Select "Reply".
- 3 Enter text.
- 4 Select "Send".

### **Delete Message**

- 1 Select "More".
- 2 Select "Delete".
- 3 Select "Yes" to delete the message.

### **Forward Message**

- 1 Select "More".
- 2 Select "Forward".
- 3 Enter additional text if needed.
- 4 Select "Send".
- 5 Enter number.
- 6 Select "Send" to forward the message.

### **Call Sender**

- 1 Select "View".
- 2 Select "More".
- 3 Select "Call Sender".

### **Call number in text**

- 1 Select "View".
- 2 Select "More".
- 3 Select "Call (No. in text)".
- 4 Select number from the list.
- 5 Select "Call".

### **Save Number**

- 1 Select "View".
- 2 Select "More".
- 3 Select "Save number".
- 4 Select "Work Number"/"Mobile number"/"Other number".
- 5 Press "Add".
- 6 Enter name for the contact.
- 7 Press "OK".
- 8 Press "Save". The number will be saved in the contact list.

### 8.5.2 Write New Messages

- 1 Select "Write new message".
- 2 Enter text, and press "Send". See also [7 Messaging](#) on page 32.  
It is possible to save the message and send it later by pressing the soft key "Back" and select "Yes". The message will be stored under Unsent messages. See [8.5.3 Unsent Messages](#).
- 3 Enter number, or press middle soft key to get number from contact list.
- 4 Press "Send".

### 8.5.3 Unsent Messages

- 1 Select "Unsent" to view the list.
- 2 Select message to edit/send.
- 3 Select "Edit", edit text and/or just select "Send".

#### Delete/Delete All

- 1 Select "More".
- 2 Select "Delete" or "Delete all".
- 3 Select "Yes" if the unsent message shall be deleted.

### 8.5.4 Sent Messages

- 1 Select "Sent" to view the list.
- 2 Select "View".

#### Forward message

- 1 Enter additional text if needed.
- 2 Enter number.
- 3 Select "Send".

#### Delete Message

- 1 Select "Delete".
- 2 Select "Yes" to delete the message.

#### Delete/Delete All

- 1 Select "More".
- 2 Select "Delete" or "Delete all".
- 3 Select "Yes" if the unsent message shall be deleted.

## 8.6 Profiles

It is possible to set up an own profile for incoming calls, message alerts, vibrating alerts, key sound etc. This can be useful when there are many users on the same telephone, and they want different sound profiles. It can also be used for temporarily settings, for example while in a meeting incoming calls should be silent. It is easy to switch between the different profiles.

- 1 Enter the menu by pressing the "Menu" Soft key, or the confirmation button on the Navigation key.
- 2 Select  in the menu.

### Add new Profile

- 1 Press Soft key "Add new".
- 2 Enter name of the profile and select "Save".
- 3 Select profile from list and change profile as wanted.

### Delete Profile

- 1 Select profile from list.
- 2 Press Soft key "More".
- 3 Select "Delete" from menu.
- 4 Press Soft key "Delete".
- 5 Press Soft key "Yes" to confirm.

### Edit Profile

- 1 Select profile from list.
- 2 Press Soft key "More".
- 3 Select "Edit" from menu.
- 4 Select what to edit and press Soft key "Edit".
- 5 Make changes and press Soft key "Save" to confirm.

## 8.7 Contacts

- 1 Enter the menu by pressing the "Menu" Soft key, or the confirmation button on the Navigation key.
- 2 Select  in the menu, see [4.2 Contacts](#) on page 21.

### 8.7.1 Call Contact

- 1 Select "Call contact".
- 2 Select contact from the list, or enter name or number in the search field.
- 3 Press the Soft key "Call".

It is also possible to edit the contact and to send a message by selecting "View" > "More".

### 8.7.2 Add Contact

- 1 Select "Add contact".

#### Add New Contact

- 1 Select "New".
- 2 Select "Add", and enter the name of the contact.
- 3 Press "OK".
- 4 Select "Work Number"/"Mobile number"/"Other number".
- 5 Press "Add".
- 6 Enter telephone numbers.
- 7 Press "OK".
- 8 Press "Save" and then "Back".

Different ring signals can be set to distinguish this contact from another contact.

#### Add from Call List

- 1 Select "From call list".
- 2 Select number.
- 3 Press "Add".
- 4 Select number type.
- 5 Press "Select".
- 6 Press "Add", and enter name for the contact.
- 7 Press "OK".
- 8 Press "Save".

### 8.7.3 Edit Contact

- 1 Select "Edit contact".
- 2 Select contact, and press "Edit" twice.
- 3 Enter new name/number, and press "OK".
- 4 Press "Save".

### 8.7.4 Delete Contact

- 1 Select "Delete contact".
- 2 Select contact, and press "Delete".
- 3 Press "Yes" to confirm.

### 8.7.5 Central Phonebook

In the Central Phone book it is possible to search by name or number. The last search result can be displayed.

When the search result is ready it is possible to view contact information, add the number to new contact, and to send a message by selecting the Soft key "More". You can also call the number by selecting the Soft key "Call".

- 1 Select "Central phonebook".

### Search by Name

- 1 Select Search by name.
- 2 Enter First name and/or Last name.
- 3 Select "Search". The search result will be displayed.

### Search by Number

- 1 Select "Search by number".
- 2 Enter telephone number, select "Search". The search result is displayed.

### View Last Search Result

- 1 Select "Last result". Only the last result will be displayed.

## 8.8 Settings

- 1 Enter the menu by pressing the "Menu" Soft key, or the confirmation button on the Navigation key.
- 2 Select  in the menu, see [4.8 Settings](#) on page 24.

### 8.8.1 Sound and Alert Settings

#### Adjust the Ringer Volume

- 1 Select "Sound & Alerts".
- 2 Select "Volume".
- 3 Step with ► to increase the volume and with ◀ to decrease it. Press Back to save the setting.

#### Set different Ring Signals for Internal Call, External Call and Call Back

- 1 Select "Sound & Alerts".
- 2 Select "Ring signals".

Different signals for internal calls, external calls and call back can be set.

- 3 Select "Internal call", "External call", or "Callback". The cordless telephone has 14 different ring signals.
- 4 Select sound. By pressing "Play" it is possible to listen to the different sounds.
- 5 Press "Back".

#### Set different Message Alerts for Mail

- 1 Select "Message alert". Different message alerts can be selected. The cordless telephone has 8 different message alerts (default), see [4.8 Settings](#) on page 24.
- 2 Select message alert from list. By pressing "Play" it is possible to listen to the different sounds.
- 3 Press "Back".



### **Turn the Vibrator on/off**

- 1 Select "Vibrator alert". Choose between "On", "On if silent" (i.e. the vibrator is on when the telephone is muted), or "Off".
- 2 Select vibrating alert.
- 3 Press "Back".

### **Set the Key Sound**

This means that every time a key is used, the telephone gives a small sound.

- 1 Select "Key sound". Choose between "Silent", "Click", or "Tone".
- 2 Select key sound.
- 3 Press "Back".

It is possible to listen to the key sound by pressing the Soft key "Play".

## **8.8.2 Phone Lock settings**

### **Activate the Automatic Key lock**

- 1 Select "Locks".
- 2 Select "Automatic key lock".
- 3 Select "On" for activation of automatic key lock.

### **Activate the Phone Lock**

The telephone can be protected for unauthorized use. If this function is activated a PIN code has to be entered at power on, or when the telephone is placed in a charger - this behaviour will first be activated when the telephone is placed in the charger. The default phone lock code (0000) can be changed to any 4 -8 digit personalized code.

- 1 Select "Locks".
- 2 Select "Auto phone lock".
- 3 Select "On", or "On in charger".
- 4 Enter PIN code
- 5 Press "OK".

If the PIN code is forgotten it can be removed by your distributor.

### **Deactivate the Phone Lock**

- 1 Select "Locks".
- 2 Select "Auto phone lock".
- 3 Select "Off".
- 4 Enter PIN code
- 5 Press "OK".

### **Change PIN Code**

- 1 Select "Change PIN code".
- 2 Enter the old PIN code.

- 3 Press "OK".
- 4 Enter the new PIN code.
- 5 Press "OK" and enter the new PIN code again.
- 6 Press "Save".

### 8.8.3 Display Settings

#### Brightness

- 1 Select "Display".
- 2 Select "Brightness".
- 3 Select "Normal" or "Power save".
- 4 Press "Back".

#### Screen Saver

- 1 Select "Display".
- 2 Select "Screen saver".
- 3 Select "Information", or "Black". Time and status information will be displayed when "Information" is selected, and the display will turn off when the telephone is not used.
- 4 Press "Back".

### 8.8.4 Time & Date Settings

#### Set Time Format

- 1 Select "Time & Date" and press "Select".
- 2 Select Time format. The actual time format will be displayed. Selectable time format:
  - 12:00 (AM/PM)
  - 24:00
- 3 Press "Select" to save the setting.

#### Set Date Format

- 1 Select "Time & Date" and press "Select".
- 2 Select "Date format", press "Select". Selectable date format:
  - DD/MM/YYYY, i.e. 17/09/2008 (also called Europe)
  - MM/DD/YYYY, i.e. 9/17/2008 (also called US)
  - YYYY-MM-DD, i.e. 2008-09-17 (ISO 8601)
  - MMM DD YYYY, i.e. Sept 17 2008
  - DD MMM YY, i.e. 17 Sept 08
  - DD.MM.YYYY, i.e. 17.09.2008
  - DD-MM-YYYY, i.e. 17-09-2008

- 3 Press "Select" to save the setting.

### 8.8.5 Answering

The default setting for the telephone is to use the Off-hook key when answering a call. The answering behaviour can be configured to answer the call automatically, i.e. without pressing a key, or/and in loudspeaking mode. It is also possible to set the answering behaviour to any key or hook-off.

- 1 Enter  in the menu, see [4.8 Settings](#) on page 24.
- 2 Select "Answer behaviour".

#### Answering Key

The answering behaviour is by default set to *Hook-off*. It can also be set to *Any key* by first selecting "Answering key Hook-off", and then "Any key". Press "Back" to save the setting.

#### Answering Behaviour

- 1 Select "Automatically"/ "Loudspeaking".
- 2 Press "Change" to change the setting. The check box will be marked.
- 3 Press "Back" to save the setting. To remove the setting, press "Change". The check box will be unmarked.

### 8.8.6 Change Text size for Messages

- 1 Select "Messages".
- 2 Select "Text size Normal". The default text size is "Normal".
- 3 Select Normal or Large size.

### 8.8.7 Change the Menu Language

- 1 Select "\* Language". Choose between; Brazilian Português (Brazilian Portuguese), (Czech), Dansk (Danish), Deutsch (German), English, Español (Spanish), Français (French), (Greek), (Hungarian), Italiano (Italian), Nederlands (Dutch), Norska (Norwegian), (Polish), (Russian), (Slovakian), Soumi (Finish), Svenska (Swedish), and (Turkish).
- 2 Press "Back".

### 8.8.8 Change Owner ID

The Owner ID is set to identify the telephone.

- 1 Select "Owner ID".
- 2 Enter identity.
- 3 Press "Save".

## 9 Advanced Functions

### 9.1 Admin Menu

The telephone has a hidden menu for system administrators. See also *Configuration Manual, Cordless Telephone DT690, TD 92503GB*.

The Admin menu contains:

- Software and hardware information and IPEI
- DECT link information
- Fault logging
- Enhanced system menu with ability to alter protection
- Factory reset option

To activate the Admin Menu enter the Call time screen and press > \* < < \* <.

For quick access to device information short codes are available in the idle menu.

<b>Information</b>	<b>Code</b>
Software version	*#34#
Hardware version	*#34#
IPEI	*#06#

## 10 System Handling

### 10.1 Software Upgrade

Software and parameters in the Cordless telephone DT690 can be upgraded by using the Portable Device Manager (PDM). The PDM exists in two versions, a Windows version and a System version. See *Installation and Operation Manual, Portable Device Manager (PDM) Windows Version, TD92325GB*, or *Installation and Operation Manual CPDM, TD92378GB*

Refer to the *Configuration Manual, Cordless telephone DT690 TD 92503GB* for more information.

To view the telephone's software version, enter *\*#34#* in standby mode.

## 11 Troubleshooting

This section contains information on how to solve common operational problems, and warnings you may receive.

Go through the following lists if you encounter any problems. If this checklist does not solve the problem, contact your system administrator.

If others have similar problems, there may be a system error.

### Operational Problems

<b>Fault</b>	<b>Probable cause</b>	<b>Action or comment</b>
No display	The battery level is low or the telephone is defective.	Charge the battery or contact system administrator.
No ringing	The sound off icon is on, or ringer volume set to silent, or the telephone is defective.	Long press the Sound off key, or increase volume, or contact system administrator.

### Error or Warning Messages

<b>Display shows</b>	<b>Probable cause</b>	<b>Action or comment</b>
No access	The network is in range, but no access rights.	Switch telephone off and then switch it on again or contact system administrator.
No System. The telephone beeps once a minute (during max 30 minutes) with a low tone followed by a high tone (if enabled, the vibrator also follows the beeps).	The telephone is out of coverage or telephone is defective.	Stop the beep with the Sound off key and go into range. Note: When re-entering the coverage area it can take a couple of minutes before the telephone automatically has registered into the system. or contact system administrator.
SERVICE NEEDED Parameters corrupt	The telephone is defective.	Select reset option on the middle soft key if available or if no reset option is available or fault does not resolve the telephone needs repair. Note: Display message only shown in English.
Enter PIN code	The telephone's lock is activated.	Enter the required PIN code. If PIN code lost enter new via PDM or do a factory reset via PDM.
Battery low, charge now	The battery level is low.	Charge or replace the battery.
Phonebook is not available at the moment.	The phonebook does not respond, not available at the moment.	Try again later or if fault persists do a factory reset via admin menu or PDM.
Voice mail number not defined	There is no Voice mail number defined in the telephone.	Define a Voice mail number via PDM.

## 12 Operation Notice

### 12.1 Accessibility and Voice Quality

The base network is not always available. If you do not get in contact with your system, contact your system administrator. For best voice quality, avoid positioning near computer, radio or similar equipment.

#### Operating Area

You can only use your cordless telephone in the area that is covered by your system. Outside this area you will lose contact with the system. The signal strength icon will be low and "Searching" will be displayed.

#### Out of Range

When you leave the system's coverage area a short beep will sound and the text "Searching" will appear in the display.

The out of range beep will be repeated every minute for 30 minutes. It is possible to turn the sound off by pressing the Sound off key .

When re-entering the coverage area it can take a couple of minutes before the telephone automatically has registered into the system.

## 13 Maintenance

### 13.1 Charge the Battery

Place the telephone in the desktop charger or in the rack charger. The battery is being charged when the LED on the telephone is steady orange. When the battery is fully charged the LED will be green.

- An animated battery icon is also shown in the display indicating charging by starting with its current charge and ending with the full charge. A filled Battery icon indicates a fully charged battery.

**Note:** Only use the prescribed chargers for charging.

### 13.2 Charge Spare Batteries

Spare batteries can be charged with a separate battery pack charger. It can charge six batteries at the same time.

### 13.3 Replace the Battery

If the standby time for the cordless telephone becomes too low, the battery should be replaced by a new one. Please contact your system administrator or your supplier, for information about new batteries. Attach the battery as described in the illustration below. The battery is easy to replace. It is attached inside the battery lid and is connected to the cordless telephone in such a way that no miss-contact is possible.

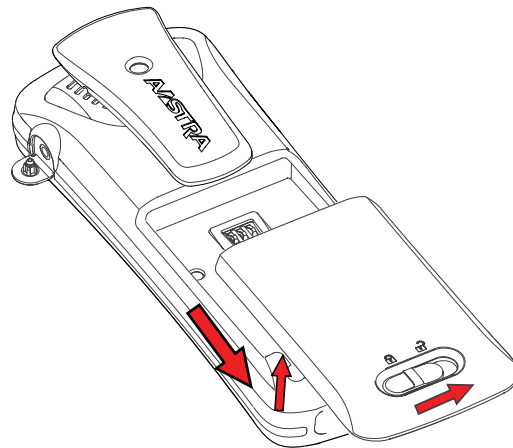

Figure 8. Easy replaceable battery, unlock the lid and remove the battery.



### 13.4 Attach the Hinge-type Clip

Attach the hinge-type belt clip as described in the illustration below.

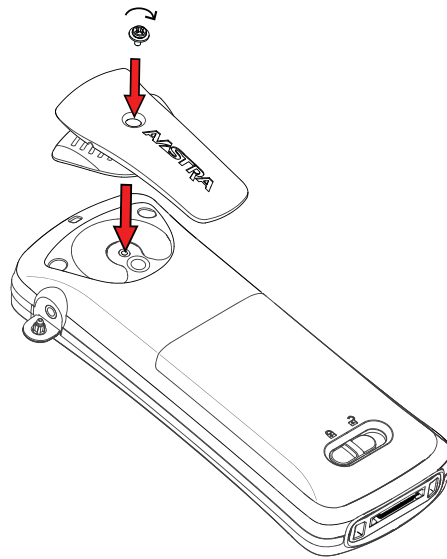

Figure 9. Screw the hinge-type clip into position.

### 13.5 Attach the Swivel-type Clip

Attach the swivel-type belt clip as described in the illustration below.

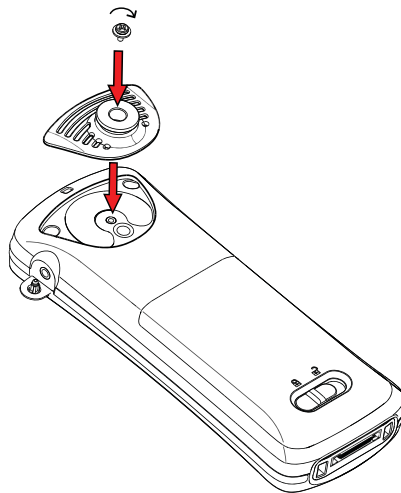

Figure 10. Screw the swivel-type clip into position.

### 13.6 Attach Cover for No Clip

Attach the enclosed cover as described in the illustration below when no clip is to be used.

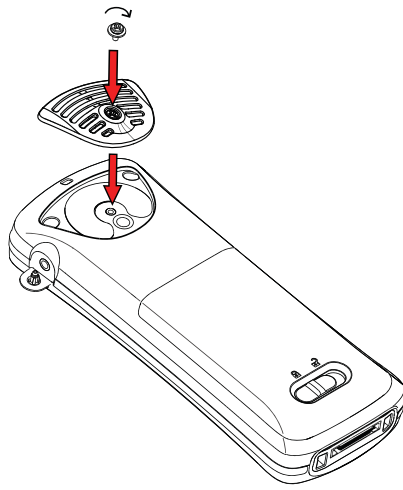

Figure 11. Screw the cover into position.

## Appendix A: Bluetooth Headset

### A.1 Introduction

Bluetooth technology replaces the cord between the cordless telephone and the headset. This allows the user to move more freely and eliminates the risk of a headset cord getting stuck.

Bluetooth is optional to the cordless telephone to be able to use a Bluetooth headset. The Bluetooth is factory mounted on the cordless telephone's circuit board.

Bluetooth supported functions:

- Pair the cordless telephone with its headset
- Chose which device to use when making a call
- Play ring signal in the Bluetooth Headset
- Answer and connect sound to the Bluetooth Headset when answering with the headset's button.
- End call with the Bluetooth headset's button
- Transfer audio to/from Bluetooth headset during call, using the menu in the cordless telephone.
- Increase/decrease the volume in the Bluetooth headset with the volume buttons on the cordless telephone.

### A.2 Description

#### A.2.1 Antenna

The Bluetooth has a integrated antenna.

### A.3 Icon

See [3.3 Icons and Text in the Display](#) on page 12.

## A.4 Wear

For optimal performance wear the Bluetooth headset and the telephone on the same side of your body. The best audio quality in the headset is achieved when no obstructions, including your body, are between the headset and the cordless telephone.

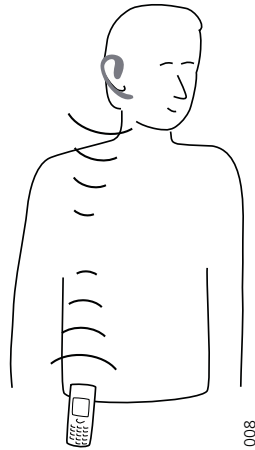

Figure 12. Wear the headset and the telephone on the same side of your body.

## A.5 Headsets

A number of Bluetooth headsets for different work situations have been tested together with the telephone. Refer to the Ascom Wireless Extranet Website for a list of verified Bluetooth headsets.

Since the Bluetooth supports the Bluetooth 2.0 standard, other headsets may also work although not verified by Ascom.

**Note:** Your Bluetooth headset may have more or less functions than described here, refer to the Manual for the Bluetooth headset.

## A.6 Operation



Step between the menus with the navigation key. Confirm each menu selection by pressing the Soft key "Select".

### A.6.1 Enable Bluetooth

To enable the Bluetooth function enter  in the telephone menu, select Bluetooth and select "Enable".

### A.6.2 Pair and Connect a Bluetooth Headset

Before a headset can be used a connection (pairing) between the headset and the telephone must be established.

- 1 Place the Bluetooth headset and the telephone next to each other.
- 2 On the telephone enter  in the menu, select "Bluetooth" > "Headset", > "Add new".

- 3 Put the headset in pairing mode<sup>1</sup> and press the Softkey "OK". The telephone starts to search for the headset.
- 4 The headset is displayed in the telephone menu "Headset found". Press the Softkey "Select" on the telephone to select the headset. The pairing starts.
- 5 A PIN-code is requested for the Bluetooth headset. Enter the PIN-code<sup>1</sup> and press "Select" on the telephone. "Pairing successful" is displayed.
- 6 The paired headset is displayed in the telephone menu "Headset". When pairing a new headset it is automatically connected and will be used for calls.

### A.6.3 Add another Bluetooth Headset

Up to four headsets can be paired to the telephone, but only one at a time can be selected. To pair another headset repeat section "Pair and Connect a headset" steps 1-6.

The paired headsets are displayed by a default name in the telephone menu "Headset". See [A.6.6 Change the name of Bluetooth headset](#)

### A.6.4 Select a Bluetooth Headset

To activate a Bluetooth headset, enter  in the telephone menu, select "Bluetooth" > "Headset". Step with the navigation key, ▲ or ▼ to the headset to be selected and press the Softkey "Select", "Connection successful" is displayed. The headset is now selected.

When a new headset has been selected any previous headset will automatically become disconnected.

### A.6.5 Remove a Headset

To remove a Bluetooth Headset enter  in the telephone menu, select "Bluetooth" > "Headset". Step with the navigation key, ▲ or ▼ to the headset to be removed and press the Softkey "More". Select "Delete". Confirm with the Softkey "Select".

### A.6.6 Change the name of Bluetooth headset

The name, in the headset list, of the headset is the default name for the headset. To change the name enter  in the menu, select "Bluetooth" > "Headset". Step with the navigation key, ▲ or ▼, select the headset. Select "More" > "Edit name". See [3.5 Alphanumeric Keys](#) on page 18.

## A.7 Calling

### A.7.1 Make a Call

Dial the number on the telephone and press the Softkey "Call", or the Off-hook key. When "Transfer call to phone?" is displayed press "No" or ignore the message to use the Bluetooth Headset. Press "Yes" to use the telephone.

### A.7.2 Answer a Call

A ring signal sounds in both the selected Bluetooth headset and the telephone to signal an incoming call.

To answer the call in the Bluetooth headset, press the button\* on the headset.

---

1.For instruction, see headset manual.

To answer the call in the telephone press the Off-hook key on the telephone.

### **A.7.3 End a Call**

To end the call press the button\* on the headset or the On-hook key on the telephone.

## **A.8 Volume/Mute Control**

### **A.8.1 Adjust the Volume During a Call**

Depending on the Bluetooth headset it might be possible to adjust the volume on the headset\*. On the telephone press the upper Volume button on the upper left side to increase the volume and the lower Volume button to decrease the volume in the headset.

### **A.8.2 Turn the Microphone On/Off During a Call**

Mute the headset and the telephone with the Sound off key on the telephone. See [6.4.3 Turn the Microphone on/off during a Call](#) on page 29.

## **A.9 Messaging**

When a text message is received a beep sounds in the Bluetooth headset.

## **A.10 Transfer a call**

### **A.10.1 Transfer a Call to the Telephone**

To transfer a call to the telephone from the Bluetooth headset, press the Softkey "More" on the telephone during the call, and select "Audio transfer".

### **A.10.2 Transfer a Call to the Bluetooth Headset**

To transfer the call to the Bluetooth headset, press the Softkey "More" on the telephone during the call, and select "Audio transfer".

It is also possible to transfer a call to the Bluetooth headset by pressing the button\* on the Bluetooth headset.

## **A.11 Switch to a Headset with Cord**

If a headset with a cord is connected during a call, the call is transferred to this headset automatically.

## **A.12 Menu Tree**

See [4.8 Settings](#) on page 24.

## **A.13 Operation Notice**

### **A.13.1 Accessibility and Voice quality**

Bluetooth uses the frequency of 2.45 GHz. WLAN, microwave oven, and other devices that use the same frequency can disturb the use of a Bluetooth headset.

### **A.13.2 Operation Area**

Maximum distance between the headset and the telephone is 10 metres. The communication distance between the telephone and headset may vary considerably due to the environment and disturbances from other 2.45 GHz equipment. Different headsets can also give different communication distances.

### **A.13.3 Out of Range**

If a connection cannot be made with the selected Bluetooth headset the call is transferred automatically to the telephone.

If the Bluetooth headset and the telephone get out of range from each other the connection is temporarily lost. Since the last connected headset is always considered "selected", the connection is automatically established again when a call is made or received.

## **A.14 Environmental Requirements**

### **A.14.1 Bluetooth Headset Battery**

See the manual for the Bluetooth headset.

### A.15 Trouble Shooting

<b>Problem</b>	<b>Reason</b>	<b>Solution</b>
No headset found	Headset is turned off	Turn on headset
	Headset is out of battery	Charge headset
	Headset is out of range	Move headset closer to telephone < 10 metre.
	Headset is not in pairing mode	Turn headset into pairing mode (see headset manual for details)
Pairing fails	Headset is not in pairing mode	Turn headset into pairing/ discoverable mode (see headset manual for details)
	Incorrect PIN entered	Try again and enter correct PIN (see headset manual for details)
Connecting fails/Failed to connect headset	Headset is not turned on	Turn on headset
	Headset is out of range	Move headset closer to telephone
	Link key in headset has been deleted	Repeat pairing procedure
	Headset is already connected to another telephone	Disconnect headset from the other telephone
	Too close to disturbing devices.	Disturbing devices can be WLAN equipment, microwave etc.
Headset can not connect to telephone (see headset manual for details on how to connect)	Telephone is not turned on	Turn on telephone
	Telephone is out of range	Move telephone closer to headset
	Bluetooth module is disabled	Enable Bluetooth in Bluetooth menu
	Another headset is already connected to the telephone	Disconnect the connected headset
	Link key is missing in either headset or telephone.	Repeat pairing procedure
	Too close to disturbing devices.	Disturbing devices can be WLAN equipment, microwave etc.

\* Refer to the Manual for the Bluetooth headset.





## Index

### Numerics

3rd party ..... 15

### A

Antenna..... 11

### B

Battery ..... 11, 54

    low battery ..... 14, 54

Bluetooth Headset Module..... 57

### C

C (Clear) button ..... 16

Call diversion..... 39

Call info ..... 15, 20

Call service ..... 15, 39

### Calling

    answered call ..... 14

    call a number from the call list ..... 27

    dial a number..... 27

    missed call ..... 15

    outgoing call..... 14

    quick call by a name in the phonebook .... 28

Case ..... 11

Centralized phonebook ..... 34

Chemical resistance..... 9

Clip..... 11

### D

Datacable..... 15

Delete a Text Message..... 32

### E

Earpiece ..... 11

Enable Bluetooth..... 58

### F

Forward a Text Message..... 32

### H

Handsfree key ..... 10

Headset connector ..... 10

### I

Icons ..... 14

### L

Loudspeaker..... 11

Loudspeaking..... 14, 27

### M

Menu tabs..... 15

### Message

    new message ..... 14, 32

    old message..... 14

    voice message..... 14

Microphone ..... 11

Mute button ..... 16

### N

Navigation Key..... 16

Number input mode..... 18

### O

On/Off button ..... 16

Ongoing call..... 15

Operating Area..... 53

Out of Coverage..... 53

### P

Personal phonebook ..... 34

PIN code ..... 47

### R

Reply to a Text Message ..... 32

Ring signal muted..... 14

### S

Signal strength ..... 14

Special characters ..... 33

### Standby mode

    date ..... 13

    time ..... 13

    user identity ..... 13

### T

Text input mode ..... 18

### V

verified Bluetooth headsets..... 58

### W

### Writing Text/Numbers

    add space in text ..... 18

    pause ..... 18

    upper/lower case ..... 18