

Test report no. : 104353-13

Item tested : DH4

Type of equipment : UPCS Handset

FCC ID : BXZDH4

Client : Ascom Sweden AB

FCC Part 15, subpart D

Isochronous UPCS Device
1920 - 1930 MHz

Industry Canada RSS-213, Issue 2

2 GHz Licence-exempt Personal
Communications Service Devices
(LE-PCS)

10 September 2008

Authorized by : 

Egil Hauger
Technical Verificator

CONTENTS

1	GENERAL INFORMATION	3
1.1	Testhouse Info	3
1.2	Client Information	3
1.3	Manufacturer (if other than client).....	3
2	TEST INFORMATION	4
2.1	Tested Item.....	4
2.2	Test Environment	5
2.3	Test Period	5
2.4	Test Engineer(s)	5
2.5	Test Equipment	5
2.6	Other Comments	5
3	TEST REPORT SUMMARY	6
3.1	General.....	6
3.2	Test Summary	7
4	TEST RESULTS.....	8
4.1	Power Line Conducted Emissions	8
4.2	Coordination with fixed microwave	10
4.3	Digital Modulation Techniques	10
4.4	Labeling Requirements	10
4.5	Antenna Requirement.....	11
4.6	Channel Frequencies	11
4.7	Automatic Discontinuation of Transmission	12
4.8	Peak Power Output	13
4.9	Emission Bandwidth B_e	18
4.10	Power Spectral Density	21
4.11	In-Band Unwanted Emissions, Conducted	24
4.12	Out-of-band Emissions, Conducted.....	26
4.13	Carrier Frequency Stability	31
4.14	Frame Repetition Stability	32
4.15	Frame Period and Jitter	32
4.16	Monitoring Threshold, Least Interfered Channel	34
4.17	Threshold Monitoring Bandwidth	36
4.18	Reaction Time and Monitoring Interval	37
4.19	Time and Spectrum Window Access Procedure	39
4.20	Acknowledgements and Transmission Duration	40
4.21	Dual Access Criteria Check.....	42
4.22	Alternative Monitoring Interval	46
4.23	Receiver Spurious Emissions.....	47
5	TEST SETUPS	50
5.1	Frequency Measurements	50
5.2	Timing Measurements	50
5.3	Conducted Emission Test.....	50
5.4	Radiated Emissions Test.....	51
5.5	Power Line Conducted Emissions Test.....	51
5.6	Monitoring Tests	52
6	TEST EQUIPMENT USED	53

1 GENERAL INFORMATION

1.1 Testhouse Info

Name : Nemko AS
Address : Nemko Comlab
Gåsevikveien 8, Box 96
N-2027 Kjeller, NORWAY
Telephone : +47 64 84 57 00
Fax : +47 64 84 57 05
E-mail: comlab@nemko.com
FCC test firm
registration # : 994405
IC OATS
registration # : 2040D-1
Total Number
of Pages: 53

1.2 Client Information

Name : Ascom Sweden AB
Address : P.O. Box 8783, SE-402 76 Gothenburg, Sweden
Telephone : +46 31 559 432

Contact:

Name : Tania Ottebrink
Telephone : +46 31 559 432
E-mail : Tania.ottebrink@ascom.se

1.3 Manufacturer (if other than client)

Name : /
Address : /
Telephone : /
E-mail : /

2 Test Information

2.1 Tested Item

Name :	ASCOM
FCC ID :	BXZDH4
Industry Canada ID :	3724B-DH4
Model/version :	DH4
Serial number :	Conducted Tests: T26103J9XG (DUT #3) Line Conducted Emissions: T26103LVGF (DUT #12)
Hardware identity and/or version:	PC1, PB
Software identity and/or version :	2.4.2
Frequency Range :	1921.536 – 1928.448 MHz
Number of Channels :	5 RF Channels, 5x12 = 60 TDMA Duplex Channels
Type of Modulation :	Digital (GFSK)
User Frequency Adjustment :	None
Rated Output Power :	85 mW Peak Power, 4 mW Time Averaged Power
Type of Power Supply :	Secondary Battery (3.7 V Li-Ion battery)
Antenna Connector :	None
Antenna Diversity Supported :	Yes
Number of Antennas :	2
Desktop Charger :	DC3

Description of Tested Device(s)

The tested equipment is a DECT handset which complies with ETSI EN 300 175. The frequencies have been reprogrammed, the output power reduced and the software updated to comply with the FCC requirements to an Isochronous UPCS device after FCC Part 15D.

The EUT is an initiating device as described in ANSI C63.17 and is designed to operate together with a DECT fixed part (i.e. a base station), which is then the responding device.

The version of DH4 covered by this test report does not have the integrated Bluetooth module.

Exposure Evaluation

The EUT is a portable device and is designed to be held to ear or worn in a belt clip when used. A test reports with the measured SAR values for both configurations are submitted with the application. The SAR values are also included in the user manual.

The EUT is exempted from RF Exposure Evaluation to Industry Canada SAR requirements since the output power is below the limit in RSS-102 Issue 2, clause 2.5.1 for General Public Use.

2.2 Test Environment

Temperature:	22 – 24 °C
Relative humidity:	30 – 40 %
Normal test voltage:	3.7 V DC

The values are the limit registered during the test period.

2.3 Test Period

Item received date:	2008-04-28
Test period :	from 2008-04-28 to 2008-06-17

2.4 Test Engineer(s)

Frode Sveinsen

2.5 Test Equipment

See list of test equipment in clause 6.

2.6 Other Comments

The Monitoring and Time and Spectrum Window Access tests were performed with Test Set-Up 6 (Ref. clause 5). A clock signal from the companion device was used to synchronize the Pulse Pattern Generator and the Spectrum Analyzer to the start of the DECT time window. The EUT was limited by administrative commands to operate on only two frequency carriers. For the tests where the EUT was required to operate on only one frequency carrier, one carrier was blocked by applying a CW interfering signal from RF Generator 3. The Pulse Pattern Generator was used to apply time synchronized interference to time windows where this was required.

Since the EUT was programmed to operate on only two RF carriers, it was only necessary with two RF generators for the monitoring tests, however a third generator was applied for the tests that required specific time slots to be blocked.

All tests except Radiated Power and Power-Line Conducted Emissions were performed in conducted mode with a temporary antenna connector.

3 TEST REPORT SUMMARY

3.1 General

Manufacturer: Ascom Sweden AB
Model No.: DH4
Serial No.: /

All measurements are traceable to national standards.

The tests were conducted on a sample of the equipment for the purpose of demonstrating compliance with FCC CFR47 Part 15D for Isochronous UPCS Devices and Industry Canada RSS-213 Issue 2.

The conducted test methods have been in accordance with ANSI C63.17-2006 where applicable.

Radiated tests were conducted in accordance with ANSI C63.4-2003. Radiated emissions are made in a 10m semi-anechoic chamber. A description of the test facility is on file with the FCC and Industry Canada.

- | | |
|---|---|
| <input checked="" type="checkbox"/> New Submission | <input checked="" type="checkbox"/> Production Unit |
| <input type="checkbox"/> Class II Permissive Change | <input type="checkbox"/> Pre-production Unit |
| PUE Equipment Code | <input type="checkbox"/> Family Listing |

THIS TEST REPORT APPLIES ONLY TO THE ITEM(S) AND CONFIGURATIONS TESTED.

Deviations from, additions to, or exclusions from the test specifications are described in "Summary of Test Data".



TEST REPORT NO: 104353-13

TESTED BY : Frode Sveinsen
Frode Sveinsen, Chief Engineer

DATE: 10 September 2008

Nemko Group authorizes the above named company to reproduce this report provided it is reproduced in its entirety and for use by the company's employees only. Any reproduction of parts of this report requires approval in writing from Nemko Group.

Any use which a third party makes of this report, or any reliance on or decisions to be made based on it, are the responsibility of such third parties. Nemko Group accepts no responsibility for damages suffered by any third party as a result of decisions made or actions based on this report.

3.2 Test Summary

Name of test	FCC CFR 47 Paragraph #	IC RSS-213 Paragraph #	Verdict
Coordination with fixed microwave	15.307(b)	N/A	Complies
Digital Modulation Techniques	15.319(b)	6.1	Complies
Labeling requirements	15.19(a)(3)	RSS-GEN 5.2	Complies
Antenna Requirement	15.317, 15.203	4.1(e)	Complies
Power Line Conducted Emission	15.107(a) 15.207(a)	6.3 RSS-GEN 7.2.2	Complies
Emission Bandwidth	15.323(a)	6.4	Complies
In-band emissions	15.323(d)	6.7.2	Complies
Out-of-band emissions	15.323(d)	6.7.1	Complies
Peak transmit Power	15.319(c)(e), 15.31(e)	6.5	Complies
Power Spectral Density	15.319(d)	4.3.2.1	Complies
Automatic discontinuation of transmission	15.319(f)	4.3.4(a)	Complies
Carrier frequency stability	15.323(f)	6.2	Complies
Frame repetition stability	15.323(e)	4.3.4(c)	Complies
Frame period and jitter	15.323(e)	4.3.4(c)	Complies
Monitoring threshold, Least interfered channel	15.323(c)(2);(5); (9)	4.3.4(b)	Complies
Monitoring of intended transmit window and maximum reaction time	15.323(c)(1)	4.3.4	Complies
Threshold monitoring bandwidth	15.323(c)(7)	4.3.4	Complies
Reaction time and monitoring interval	15.323(c)(1);(5); (7)	4.3.4	Complies
Access criteria test interval	15.323(c)(4);(6)	4.3.4	N/A ¹
Access Criteria functional test	15.323(c)(4);(6)	4.3.4	N/A ¹
Acknowledgements	15.323(c)(4)	4.3.4	Complies
Transmission duration	15.323(c)(3)	4.3.4	Complies
Dual access criteria	15.323(c)(10)	4.3.4	Complies
Alterative monitoring interval	15.323(c)(10);(11)	4.3.4	N/A ²
Spurious Emissions (Antenna Conducted)	15.323(d)	6.7.1	Complies ³
Spurious Emissions (Radiated)	15.319(g) 15.109(a) 15.209(a)	4.3.3 RSS-GEN 7.2.3	N/A ⁴
Receiver Spurious Emissions	N/A	6.8	Complies

¹ Only applies for equipment that transmits unacknowledged control and signaling information

² The client declares that the tested equipment does not implement this provision

³ The tested equipment has integrated antennas only

⁴ Not required if the Conducted Out-of-Band Emissions test is Passed

4 TEST RESULTS

4.1 Power Line Conducted Emissions

Para. No.: 15.207 (a)

Test Performed By: Tore Moe	Date of Test: 10 Sept 2008
-----------------------------	----------------------------

Measurement procedure: ANSI C63.4-2003 using 50 μ H/50 ohms LISN.

Test Results: Complies

Measurement Data: See attached graph, (Peak detector).

Highest measured values:

Frequency	Detector	Measured value	Limit	Margin
KHz	Peak/QP/AV	dB μ V	dB μ V	dB
280	QP	44.3	60.8	16.5
	AV	40.0	50.8	10.8
510	QP	41.0	55.8	14.8
	AV	23.0	45.8	22.8

The test was performed with the handset in the DC3 Desktop Charger and powered by a 5 V DC power supply.

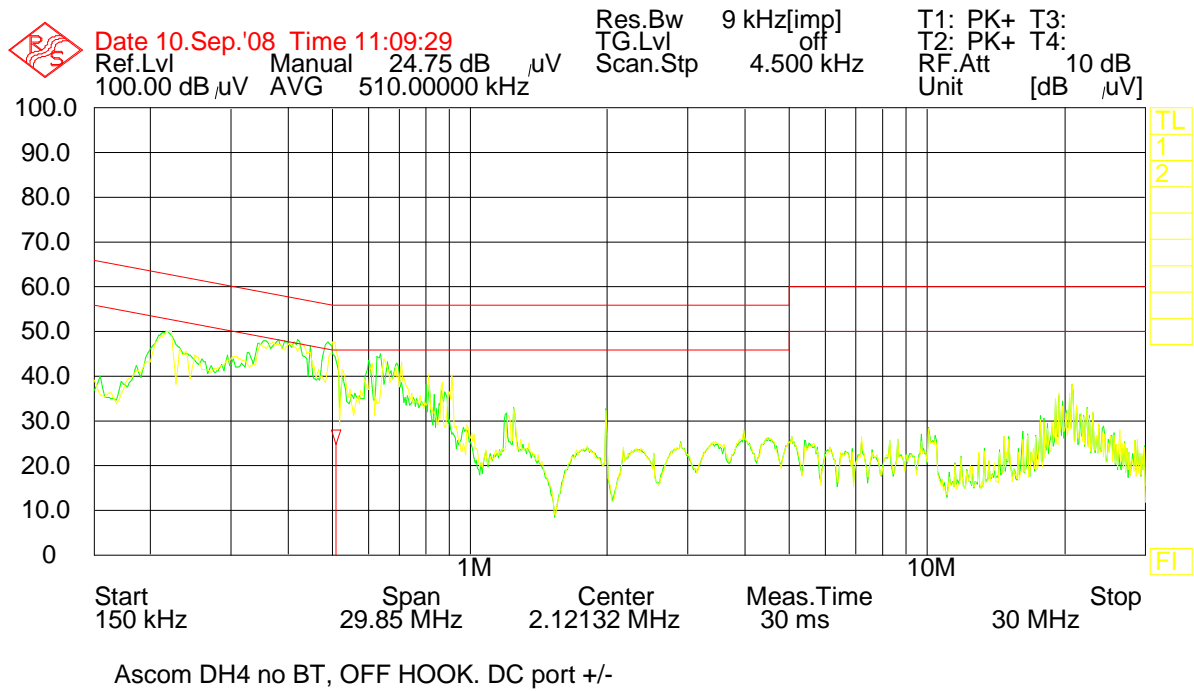

Off-Hook, Charging

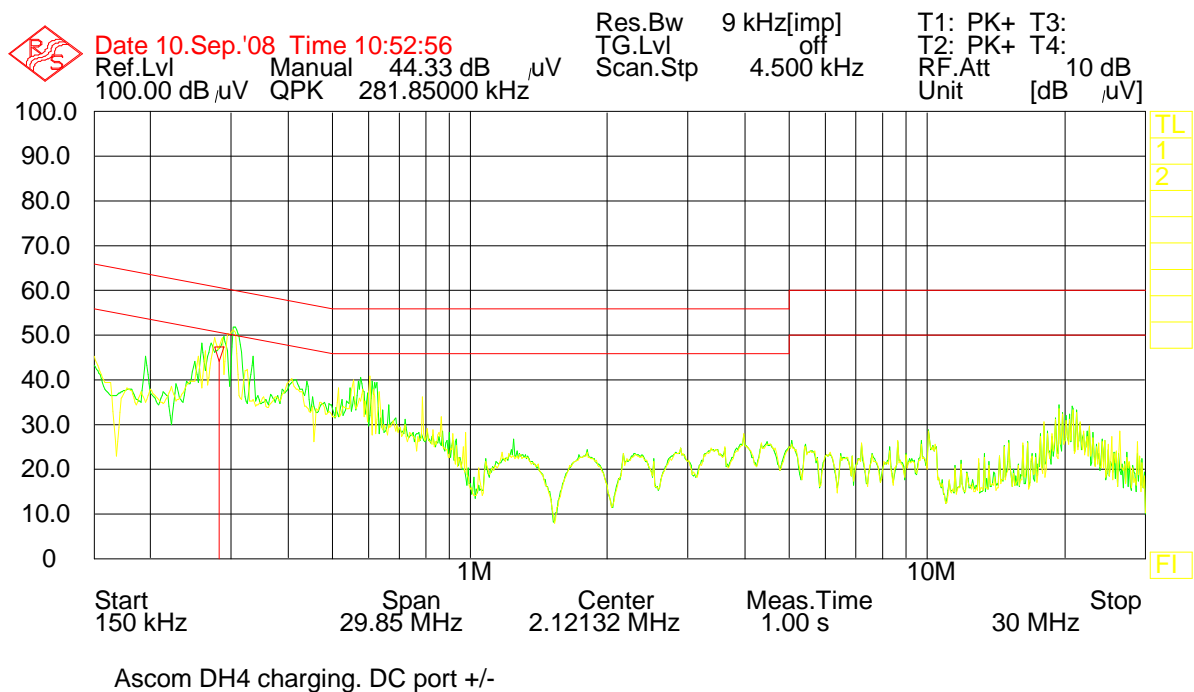

Standby, Charging

4.2 Coordination with fixed microwave

The affidavit from UTAM, Inc. is included in the documentation supplied by the applicant:

Yes

No

Requirement, FCC 15.307 (b):

Each application for certification of equipment operating under the provisions of this Subpart must be accompanied by an affidavit from UTAM, Inc. certifying that the applicant is a participating member of UTAM, Inc. In the event a grantee fails to fulfill the obligations attendant to participation in UTAM, Inc., the Commission may invoke administrative sanctions as necessary to preclude continued marketing and installation of devices covered by the grant of certification, including but not limited to revoking certification.

4.3 Digital Modulation Techniques

The tested equipment is based on DECT technology described in the ETSI standard EN 300175, the only difference is that the channel allocation is modified to operate in the 1920-1930 MHz band.

The EUT used Multi Carrier / Time Division Multiple Access / Time Division Duplex and Digital GFSK modulation.

For further details see the operational description provided by the applicant.

Requirement, FCC 15.319(b):

All transmissions must use only digital modulation techniques.

4.4 Labeling Requirements

See separate documents showing the label design and the placement of the label on the EUT.

Requirements FCC 15.19

The FCC Identifier shall be displayed on the label, and the device(s) shall bear the following statement in a conspicuous location on the device or in the user manual if the device is too small:

This device complies with Part 15 of the FCC Rules. Operation is subject to the following two conditions: (1) this device may not cause harmful interference, and (2) this device must accept any interference received, including interference that may cause undesired operation.

The label itself shall be of a permanent type, not a paper label, and shall last the lifetime of the equipment.

4.5 Antenna Requirement

Does the EUT have detachable antenna(s)?

Yes No

If detachable, is the antenna connector(s) non-standard?

Yes No

The tested equipment has only integral antennas. The conducted tests were performed on a sample with a temporary antenna connector.

Requirement: FCC 15.203, 15.204, 15.317.

4.6 Channel Frequencies

UPCS CHANNEL	FREQUENCY (MHz)
Upper Band Edge	1930.000
0 (Highest)	1928.448
1	1926.720
2	1924.992
3	1923.264
4 (Lowest)	1921.536
Lower Band Edge	1920.000

Requirement: FCC 15.303 (d), (g)

Within 1920 -1930 MHz band for isochronous devices.

4.7 Automatic Discontinuation of Transmission

Does the EUT transmit Control and Signaling Information?	<input type="checkbox"/> YES	<input checked="" type="checkbox"/> NO
TYPE OF EUT :	<input checked="" type="checkbox"/> INITIATING DEVICE	<input type="checkbox"/> RESPONDING DEVICE

The following tests simulate the reaction of the EUT in case of either absence of information to transmit or operational failure after a connection with the companion device is established.

Number	Test	EUT Reaction	Verdict
1	Power removed from the EUT	C	Pass
2	EUT Switch Off	C	Pass
3	Hook-On by companion device	NA	Pass
4	Hook-On by EUT	C	Pass
5	Power Removed from Companion Device	A	Pass
6	Companion Device Switch Off	NA	Pass

- A - Connection breakdown, Cease of all transmissions
- B - Connection breakdown, EUT transmits control and signaling information
- C - Connection breakdown, Companion Device transmits control and signaling information
- NA - Not Applicable (the companion device does not have an on/off switch and can not perform Hook-On)

Requirements, FCC 15.319(f)

The device shall automatically discontinue transmission in case of either absence of information to transmit or operational failure. These provisions are not intended to preclude transmission of control and signaling information or use of repetitive codes used by certain digital technologies to complete frame or burst intervals.

4.8 Peak Power Output

Test Method:

ANSI C63.17, clause 6.1.2.

Test Results: Complies

Measurement Data:

Maximum Conducted Output Power

Channel No.	Frequency (MHz)	Maximum Conducted Output Power (dBm)	Maximum Radiated Output Power (dBm)	Maximum Antenna Gain (dBi)
4	1921.536	19.1	21.6	+2.5
2	1924.992	19.2	21.3	+2.1
0	1928.448	19.3	21.3	+2.0

The EIRP is measured with correction factors programmed in the Spectrum analyzer.

Limit:

Conducted: $100 \mu\text{W} \times \text{SQRT}(B)$ where B is the measured Emission Bandwidth in Hz

FCC 15.319(c)(e): 20.9 dBm (122 mW)

RSS-213, Issue 2: 20.5 dBm (113 mW)

The antenna gain is below 3 dBi, no reduction in transmit power is necessary.

Requirements, FCC 15.319(c)(e), RSS-213, Issue 2

Peak transmit power shall not exceed 100 microwatts multiplied by the square root of the emission bandwidth in Hertz.

The peak transmit power shall be reduced by the amount in decibels that the maximum directional gain of the antenna exceeds 3 dBi.

Conducted Peak Output Power

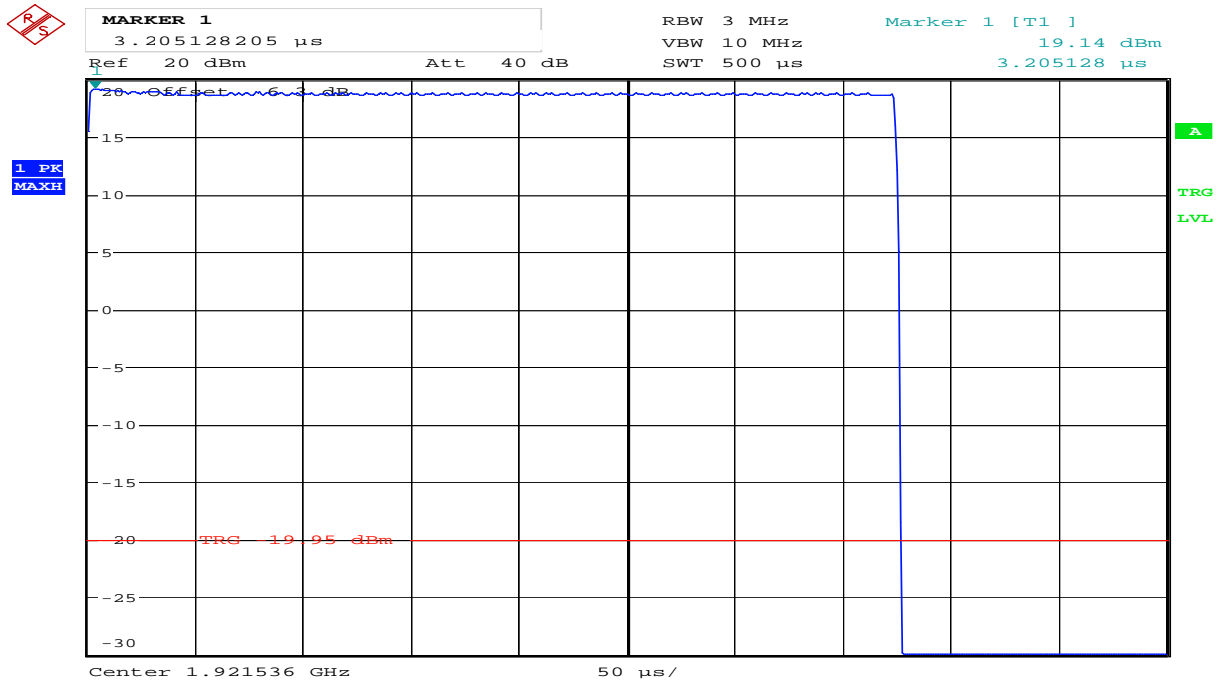

Date: 28.APR.2008 12:52:57

Lower Channel

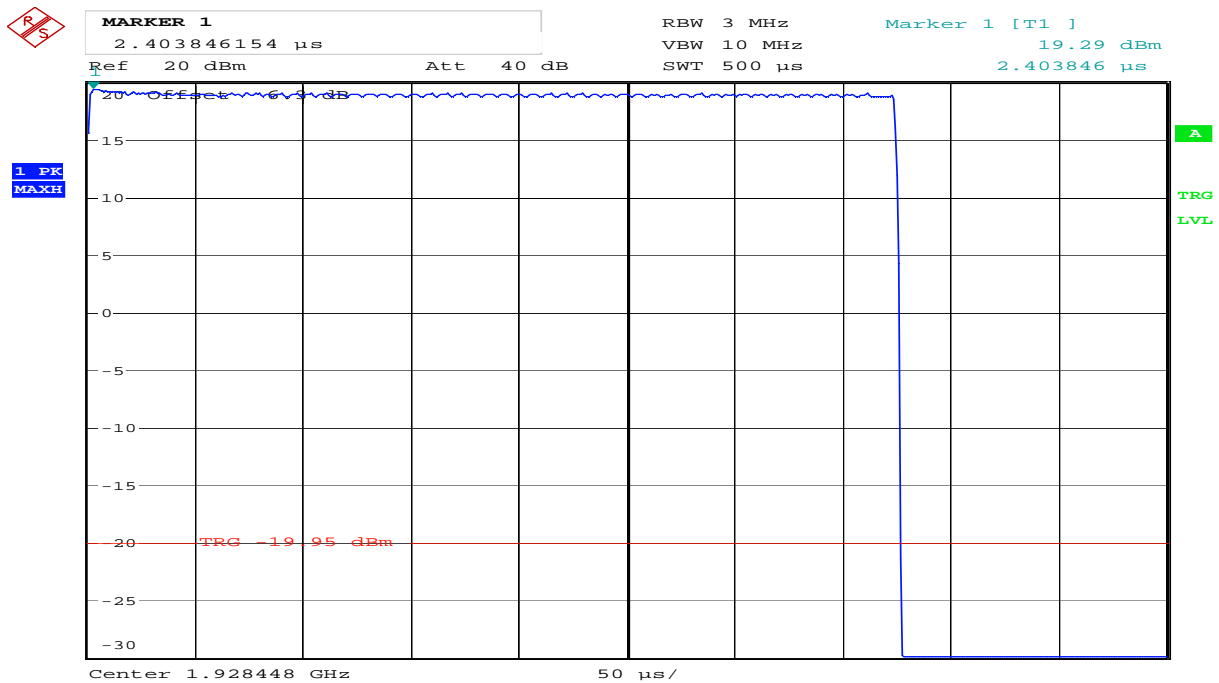

Date: 28.APR.2008 12:51:56

Upper Channel



MARKER 1
 3.205128205 μ s
 Ref 20 dBm Att 40 dB

RBW 3 MHz Marker 1 [T1]
 VBW 10 MHz 19.21 dBm
 SWT 500 μ s 3.205128 μ s

1 PK
 MAXH

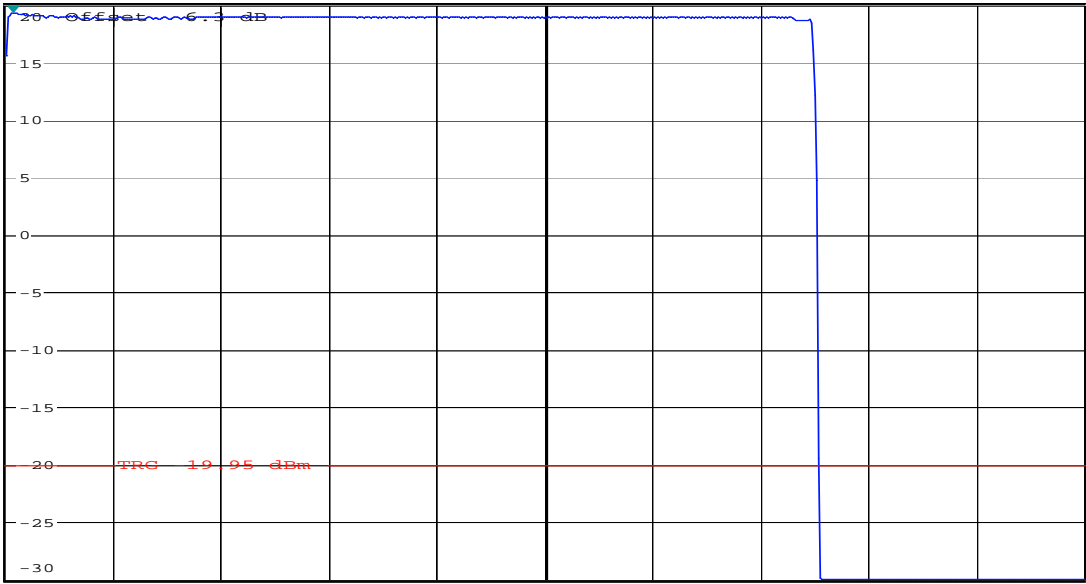

Center 1.924992 GHz 50 μ s/

Date: 28.APR.2008 12:48:55

Middle Channel

Radiated Peak Output Power

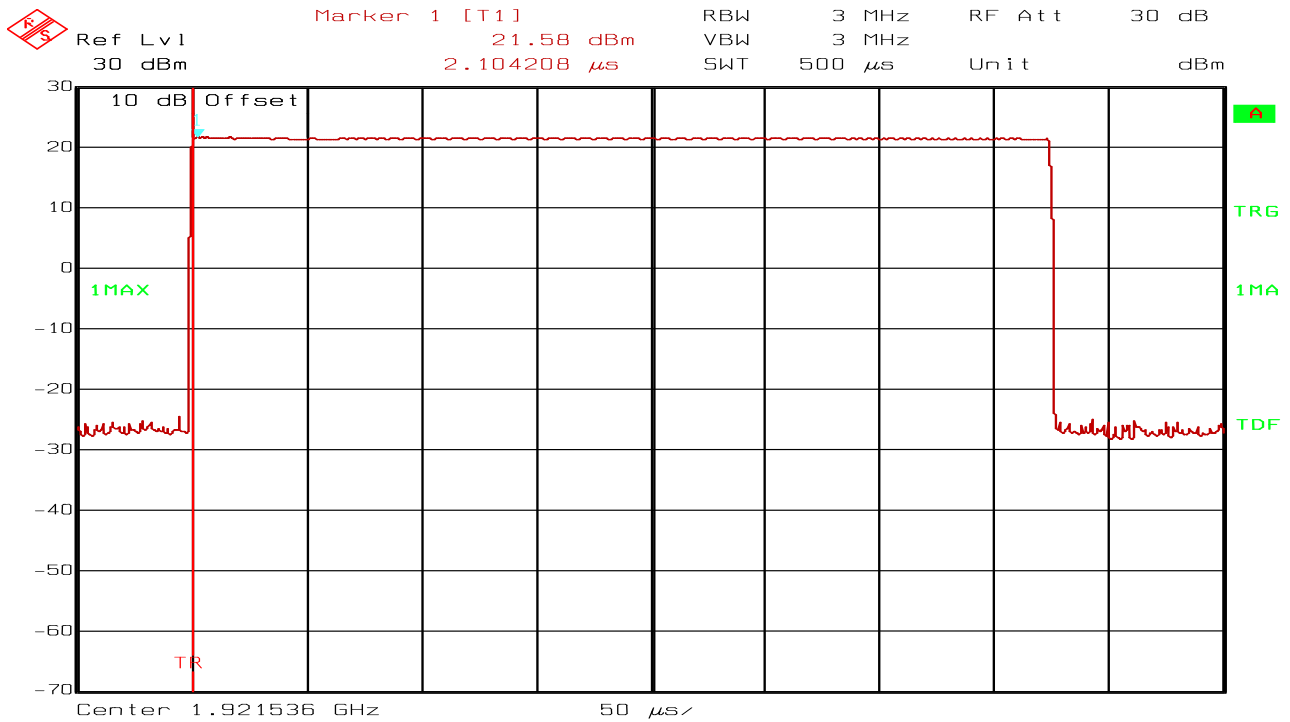

Date: 29.APR.2008 15:21:34

Lower Channel (Max: Ant 0, EUT H, HP)

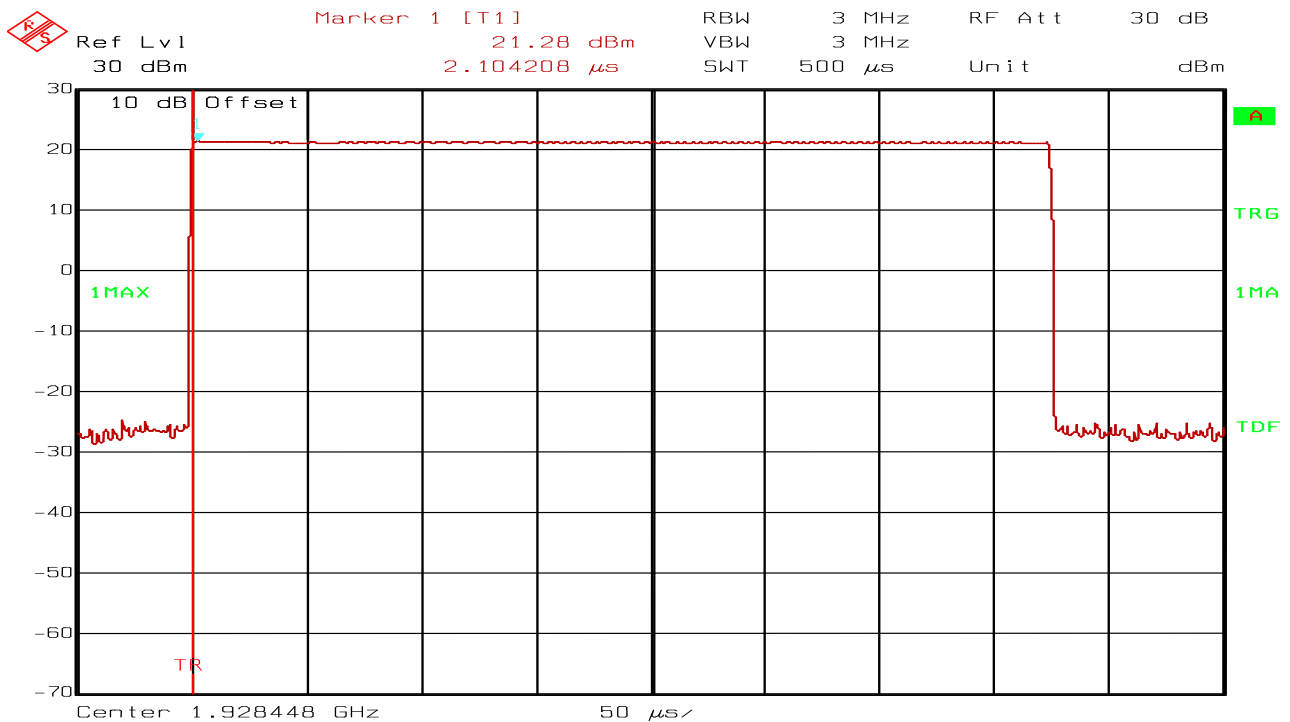

Date: 29.APR.2008 15:20:32

Upper Channel (Max: Ant 0, EUT H, HP)

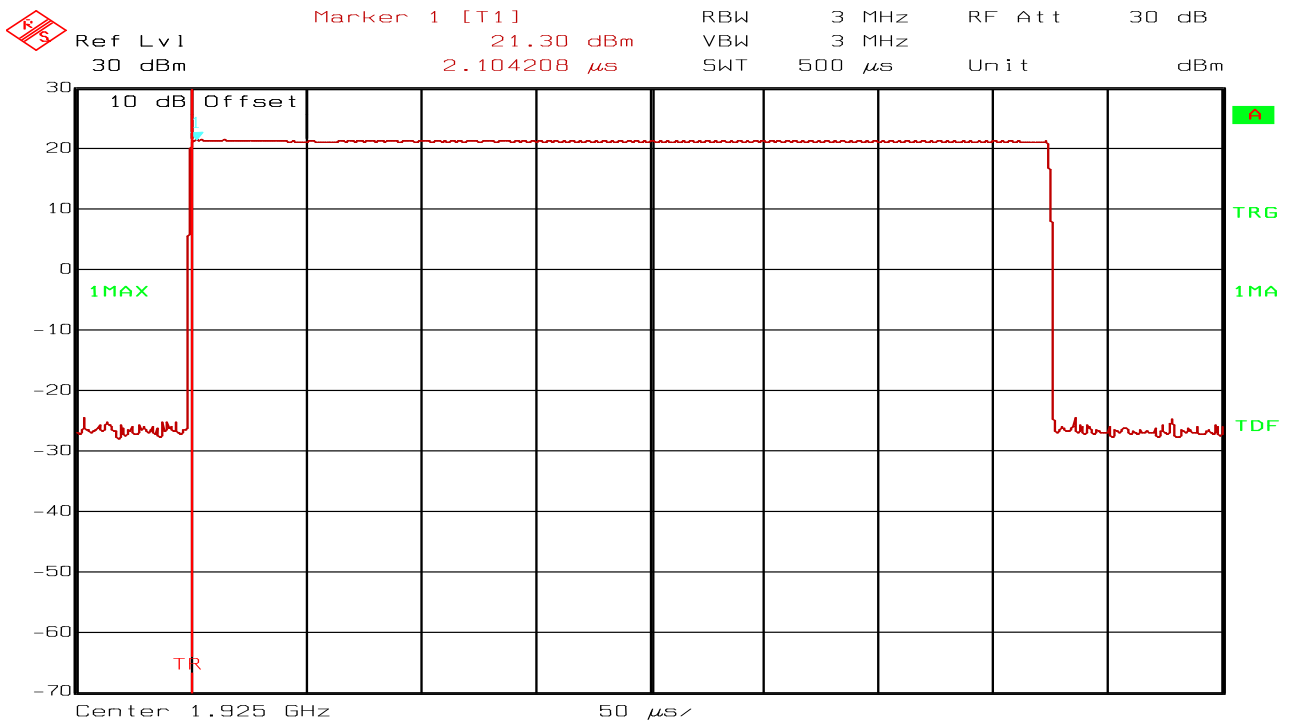

Date: 29.APR.2008 15:18:00

Middle Channel (Max: Ant 0, EUT H, HP)

4.9 Emission Bandwidth *B*

Test Method:

ANSI C63.17, clause 6.1.3.

Test Results: Complies

Measurement Data:

Channel No.	Frequency (MHz)	26 dB Bandwidth <i>B</i> (kHz)
4	1921.536	1490.4
0	1928.448	1498.4

Channel No.	Frequency (MHz)	20 dB Bandwidth (kHz)
2	1924.992	1266.0

Channel No.	Frequency (MHz)	6 dB Bandwidth (kHz)
4	1921.536	NA
0	1928.448	NA

Channel No.	Frequency (MHz)	12 dB Bandwidth (kHz)
4	1921.536	NA
0	1928.448	NA

Requirements, FCC 15.323(a)

The 26 dB Bandwidth *B* shall be larger than 50 kHz and less than 2.5 MHz.

Requirements, RSS-213 Issue 2, clause 6.4

The 20 dB Bandwidth shall be larger than 50 kHz and less than 2.5 MHz.

No requirements for 6 and 12 dB Bandwidth, these values are only used for testing Monitoring Bandwidth if the Simple Compliance test fails (ANSI C63.17, clause 7.4).

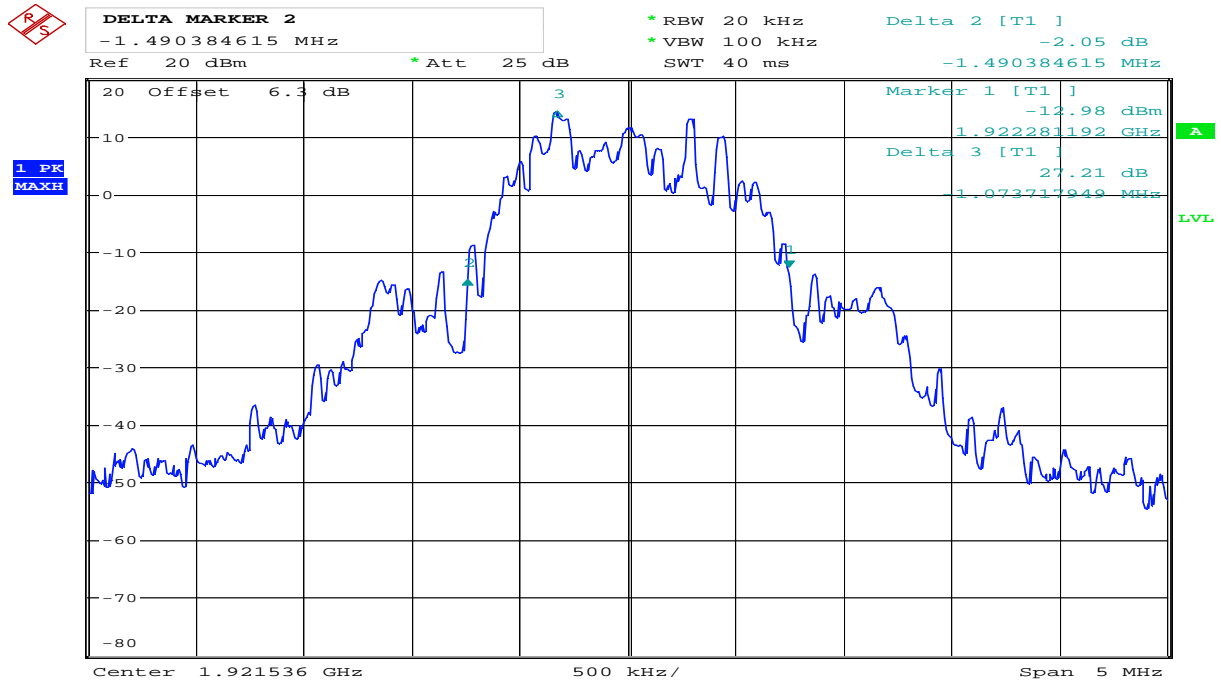

Date: 28.APR.2008 12:59:41

Emission Bandwidth B, Lower Channel



Date: 28.APR.2008 13:04:19

Emission Bandwidth B, Upper Channel



POWER BW (%)
 99 %

Ref 20 dBm Att 20 dB

*RBW 20 kHz *VBW 100 kHz SWT 40 ms

Marker 1 [T1] 14.05 dBm
 1.924671487 GHz

1 PK
 MAXH

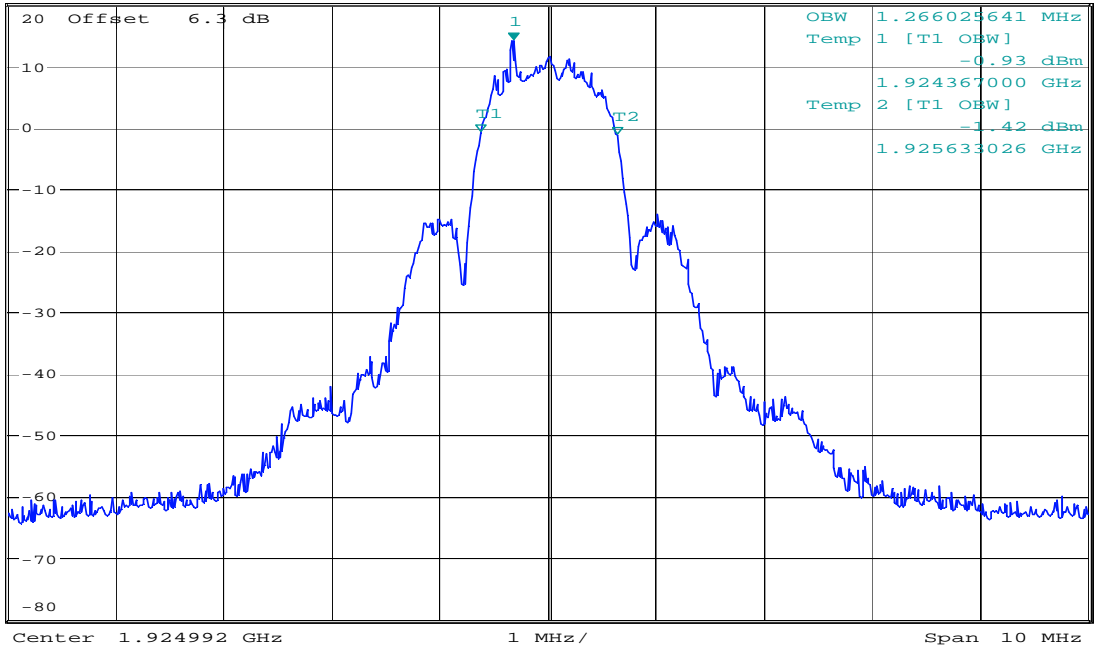

Date: 17.JUN.2008 10:14:51

99% Bandwidth, Middle Channel

4.10 Power Spectral Density

Test Method:

ANSI C63.17, clause 6.1.5.

Test Results: Complies

Measurement Data:

Channel No.	Frequency (MHz)	Power Spectral Density (dBm)
4	1921.536	-0.2
0	1928.448	1.4

Averaged over 1000 sweeps.

Requirements, FCC 15.319(d)

The Power Spectral Density shall be less than 3 mW (4.77 dBm) when averaged over at least 100 sweeps.

Power Spectral Density

Lower Channel:

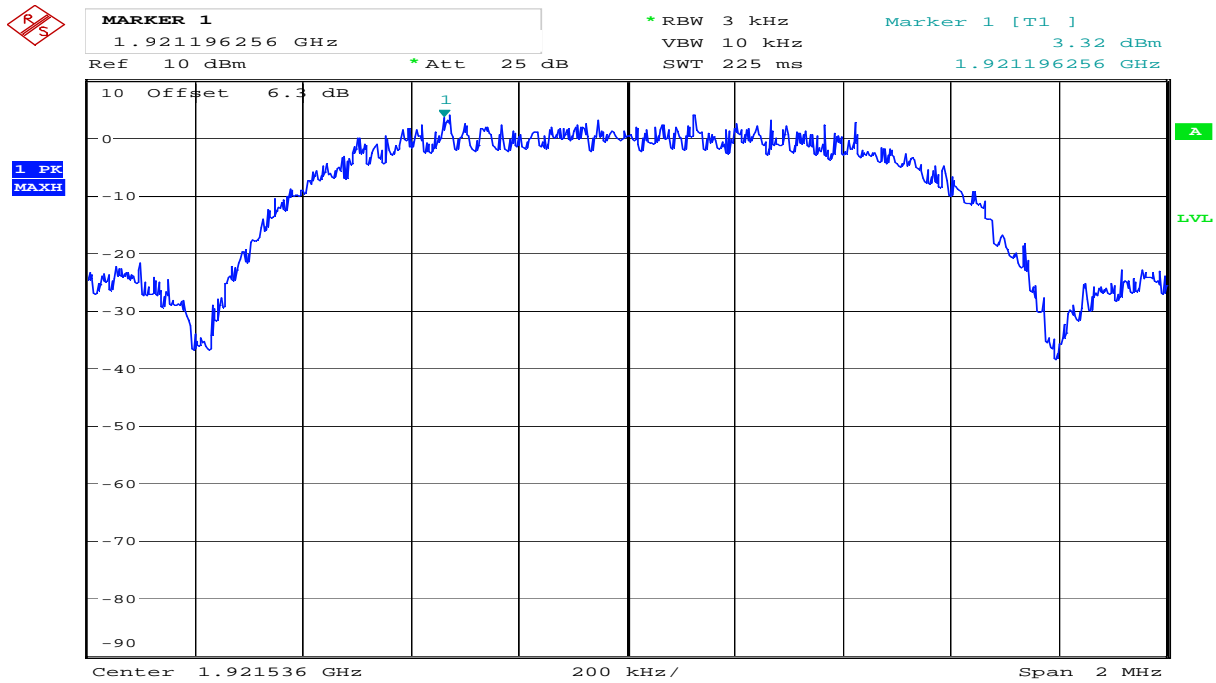

Date: 28.APR.2008 13:28:52

Overview

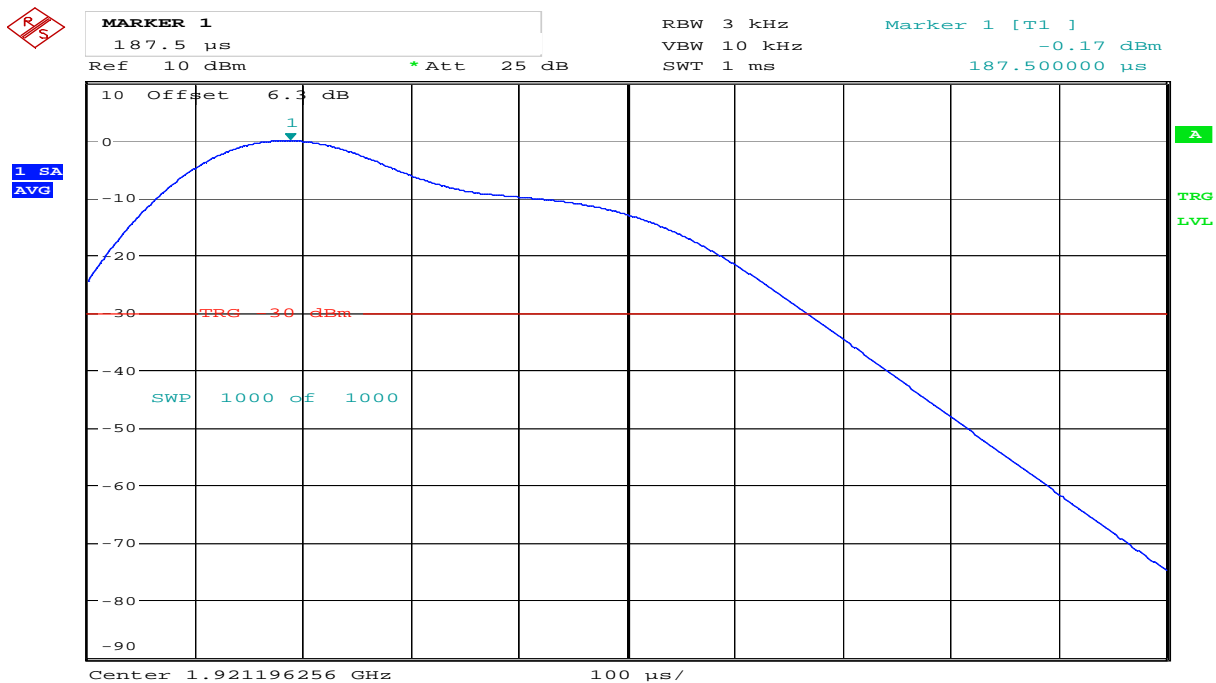

Date: 28.APR.2008 13:31:09

Averaged, 1000 Sweeps

Upper Channel:

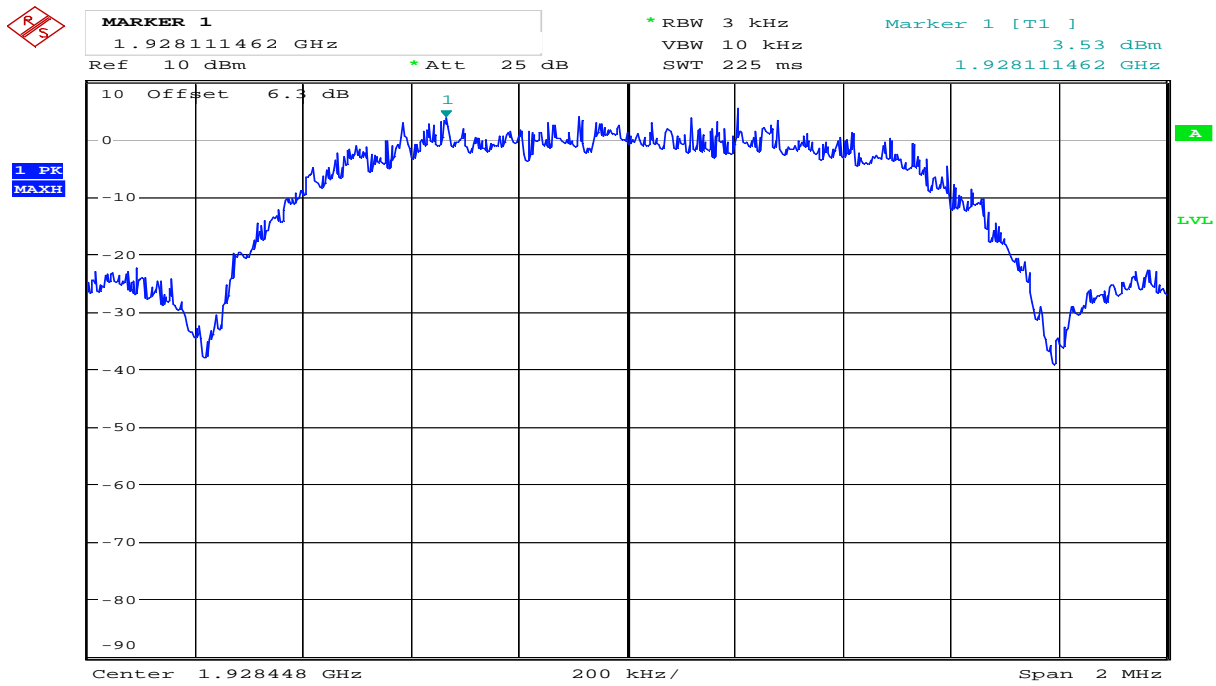

Date: 28.APR.2008 13:23:03

Overview

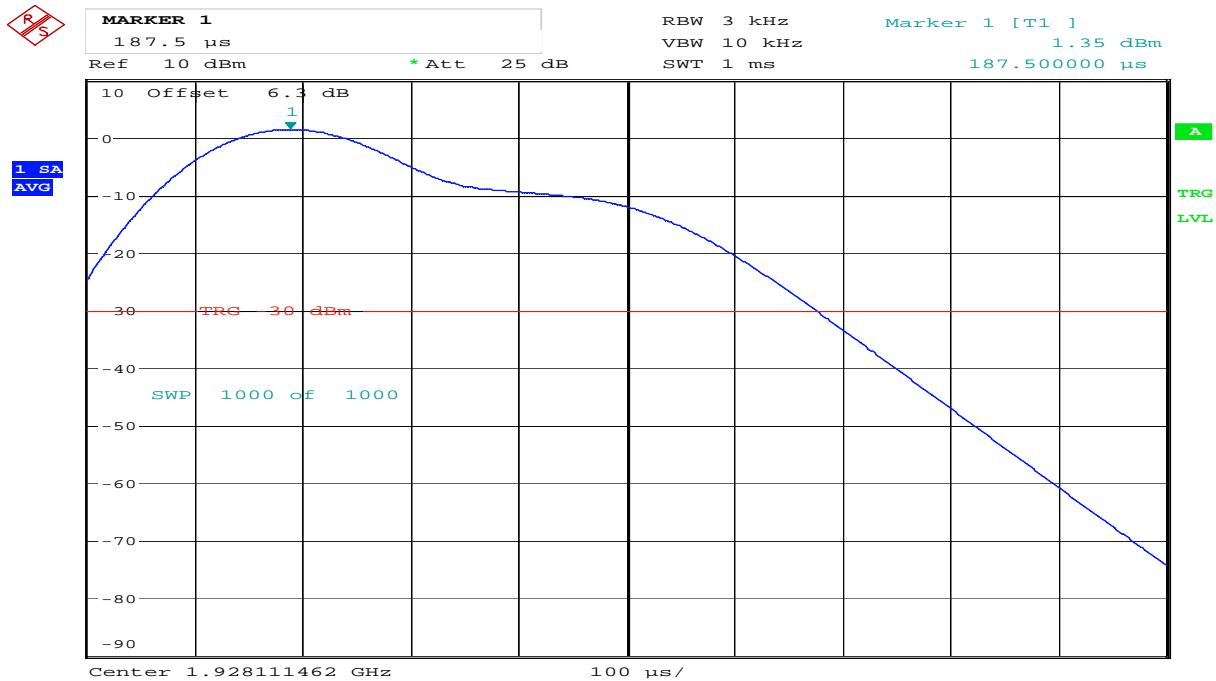

Date: 28.APR.2008 13:25:01

Averaged, 1000 Sweeps

4.11 In-Band Unwanted Emissions, Conducted

Test Method:

ANSI C63.17, clause 6.1.6.1.

Test Results: Complies

Measurement Data:

See plots.

Requirements, FCC 15.323(d):

$B < f \leq 2B$: less than or equal to 30 dB below max. permitted peak power level

$2B < f \leq 3B$: less than or equal to 50 dB below max. permitted peak power level

$3B < f \leq$ UPCS Band Edge : less than or equal to 60 dB below max. permitted peak power level

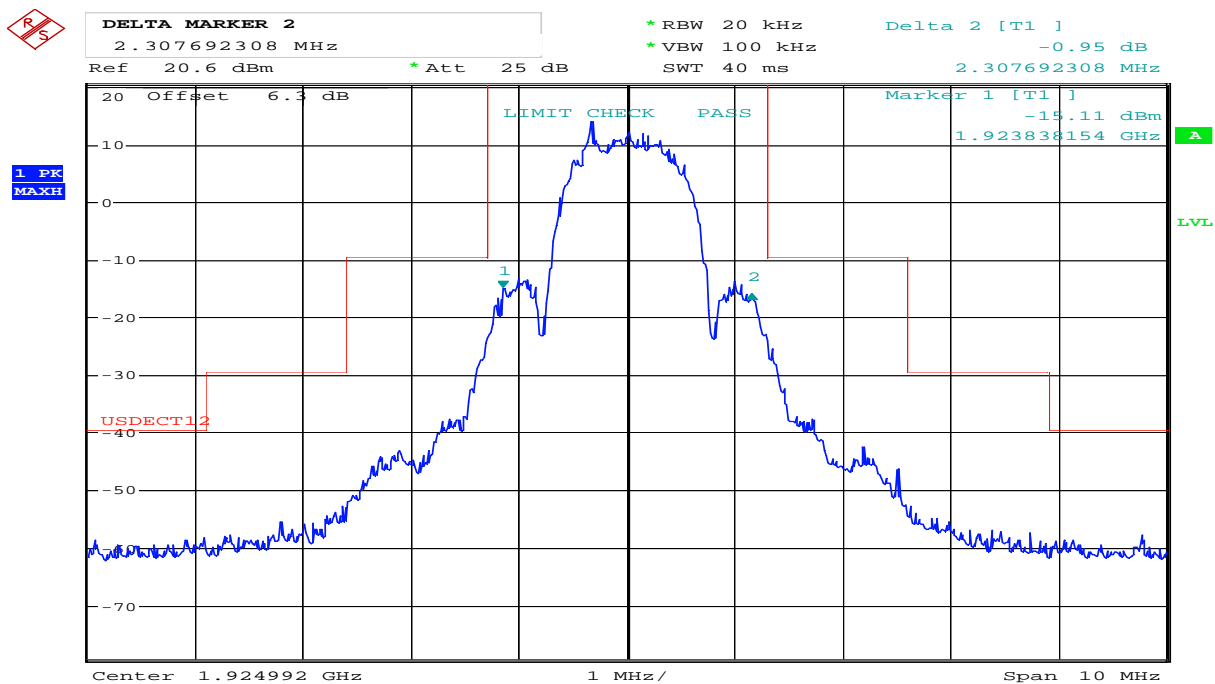

Date: 28.APR.2008 13:41:09

Middle Channel

In-Band Unwanted Emissions, Conducted

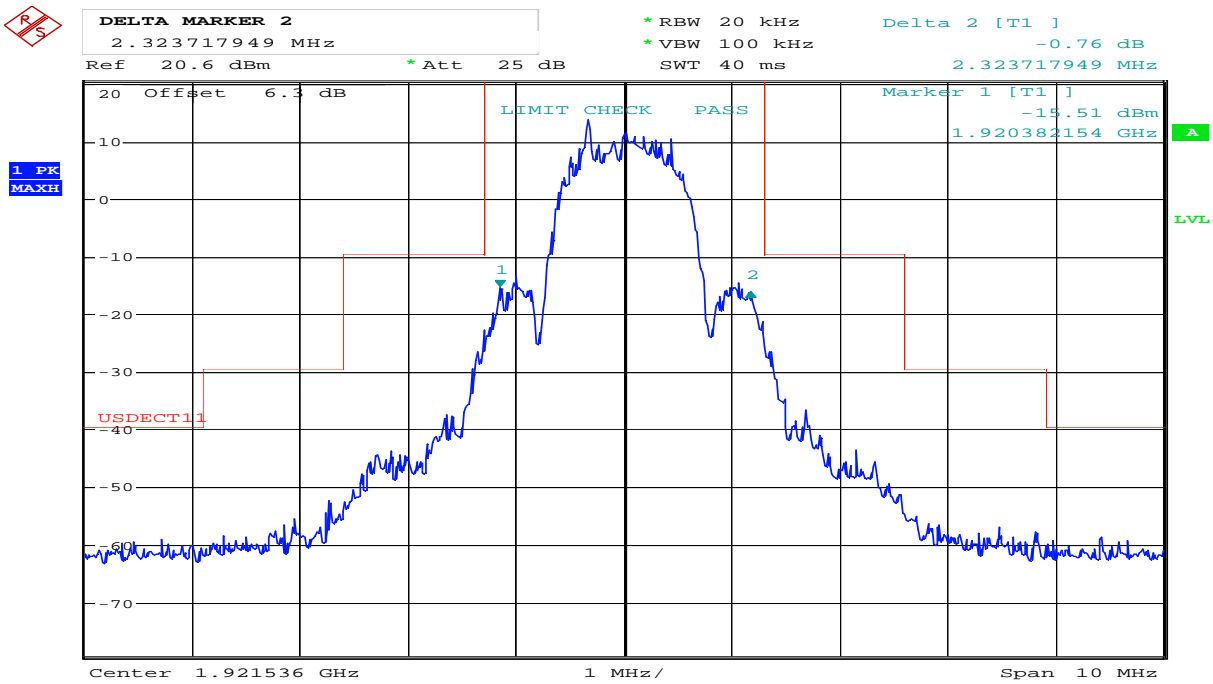

Date: 28.APR.2008 13:36:43

Lower Channel



Date: 28.APR.2008 13:44:32

Upper Channel

4.12 Out-of-band Emissions, Conducted

Test Method:

ANSI C63.17, clause 6.1.6.2.

Test Results: Complies

Measurement Data:

See plots.

Requirements, FCC 15.323(d):

$f \leq 1.25\text{MHz}$ outside UPCS band :	$\leq -9.5\text{dBm}$
$1.25\text{MHz} \leq f \leq 2.5\text{MHz}$ outside UPCS band :	$\leq -29.5\text{ dBm}$
$f \geq 2.5\text{MHz}$ outside UPCS band :	$\leq -39.5\text{ dBm}$

Out-of-Band Emissions, Conducted

Lower Channel:

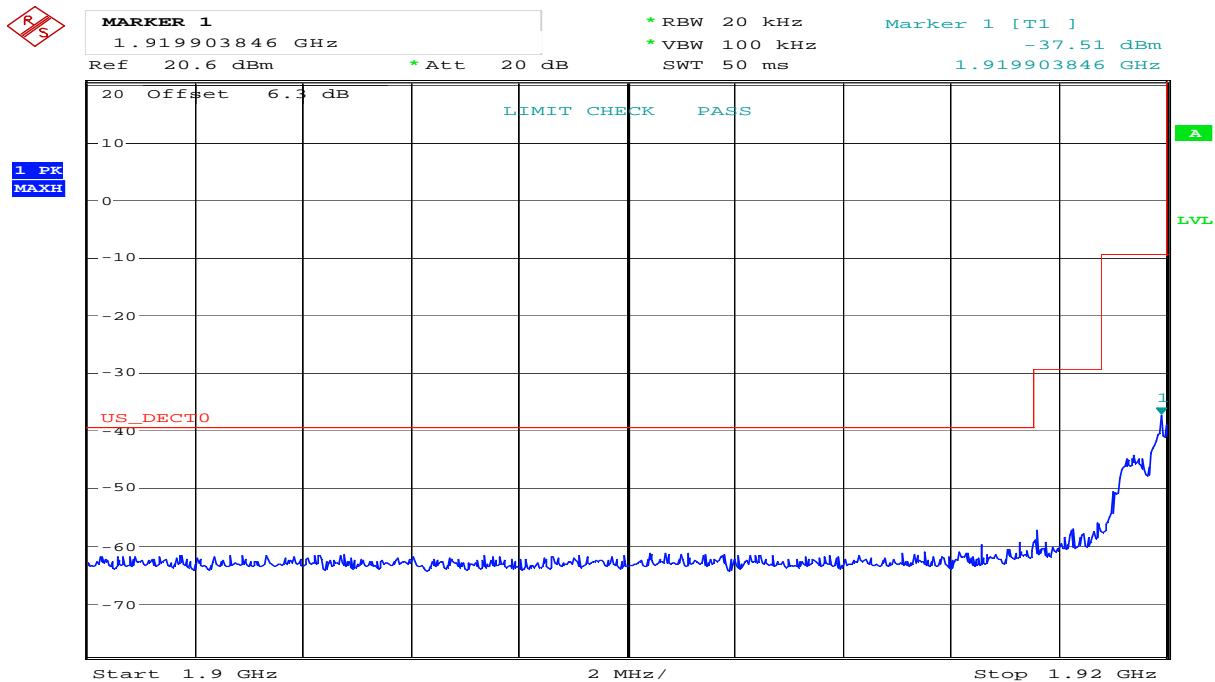

Date: 28.APR.2008 13:54:42

Out-of-Band Emissions, Conducted

Lower Channel:

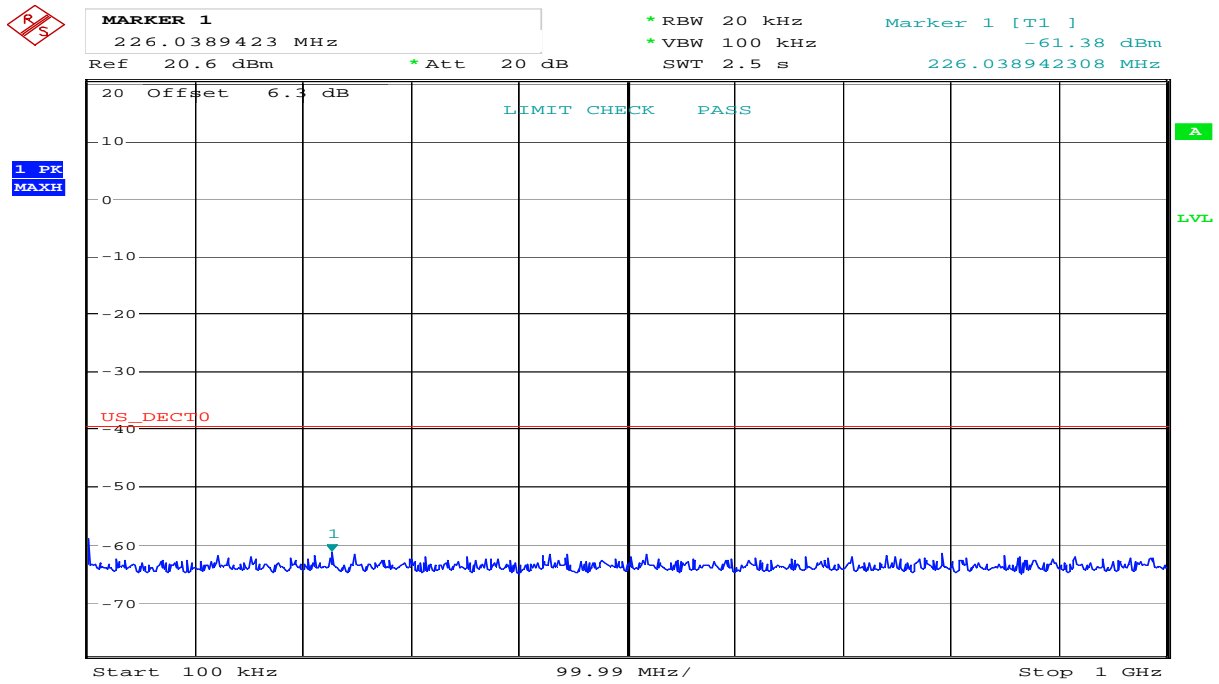

Date: 28.APR.2008 13:57:18

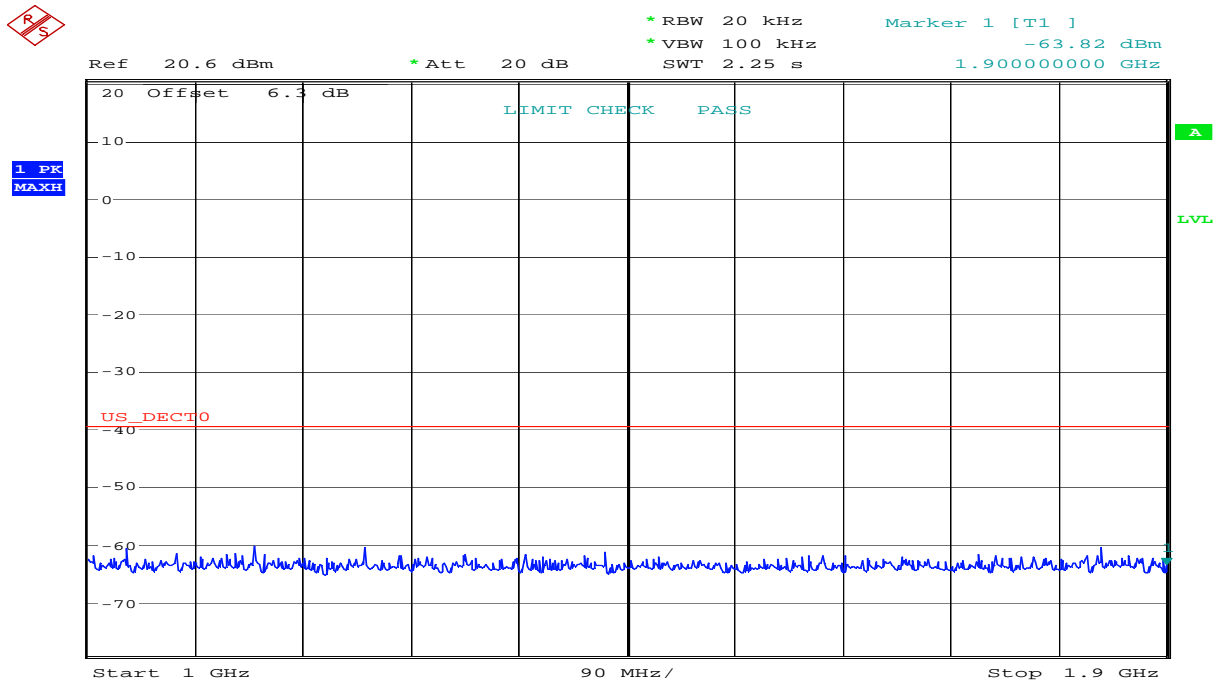

Date: 28.APR.2008 13:55:40

Out-of-Band Emissions, Conducted

Upper Channel:

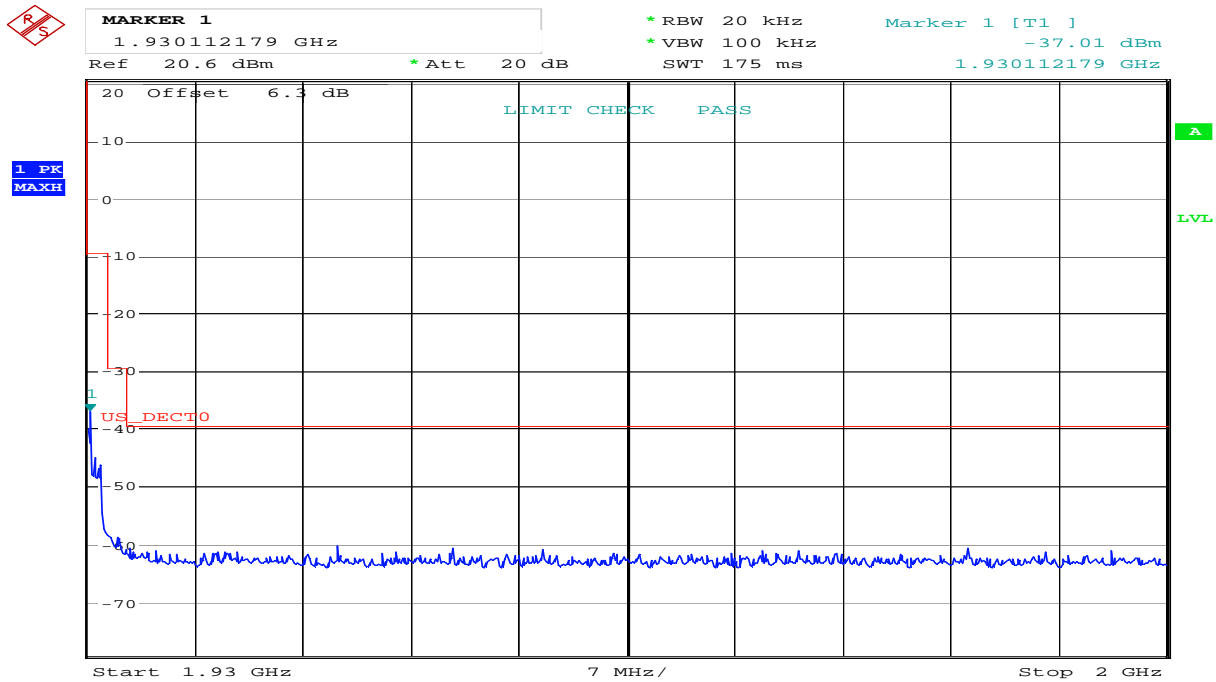

Date: 28.APR.2008 13:52:22

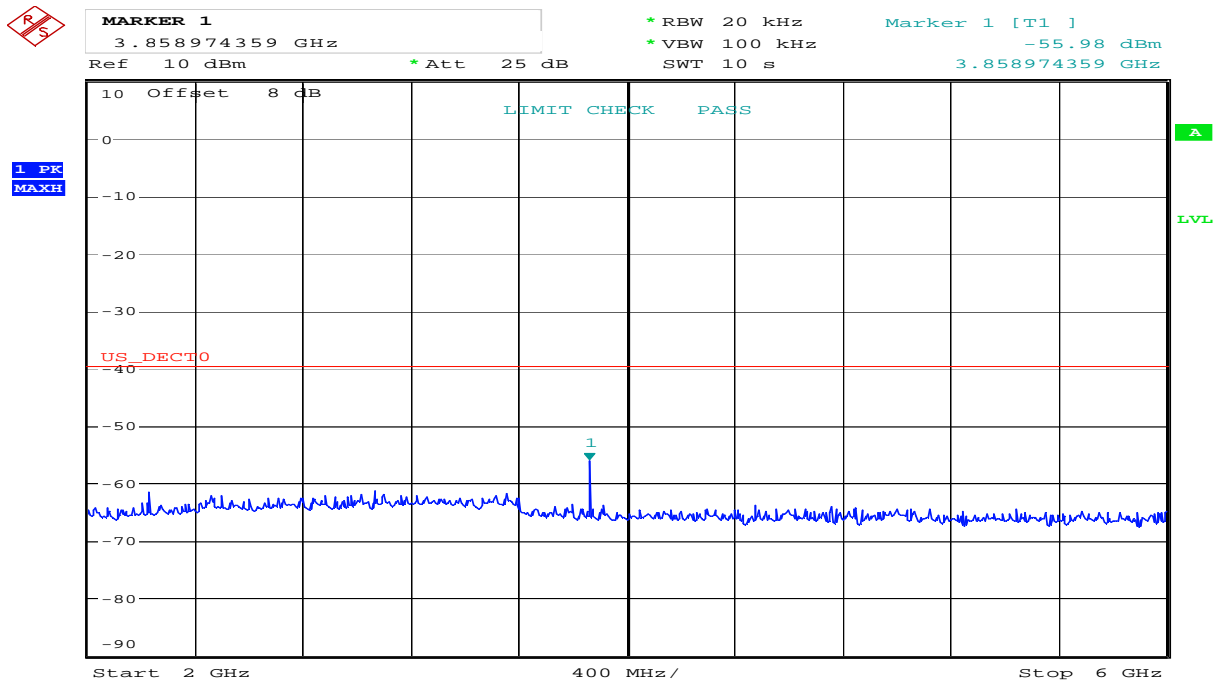

Date: 28.APR.2008 14:05:43

Out-of-Band Emissions, Conducted

Upper Channel:

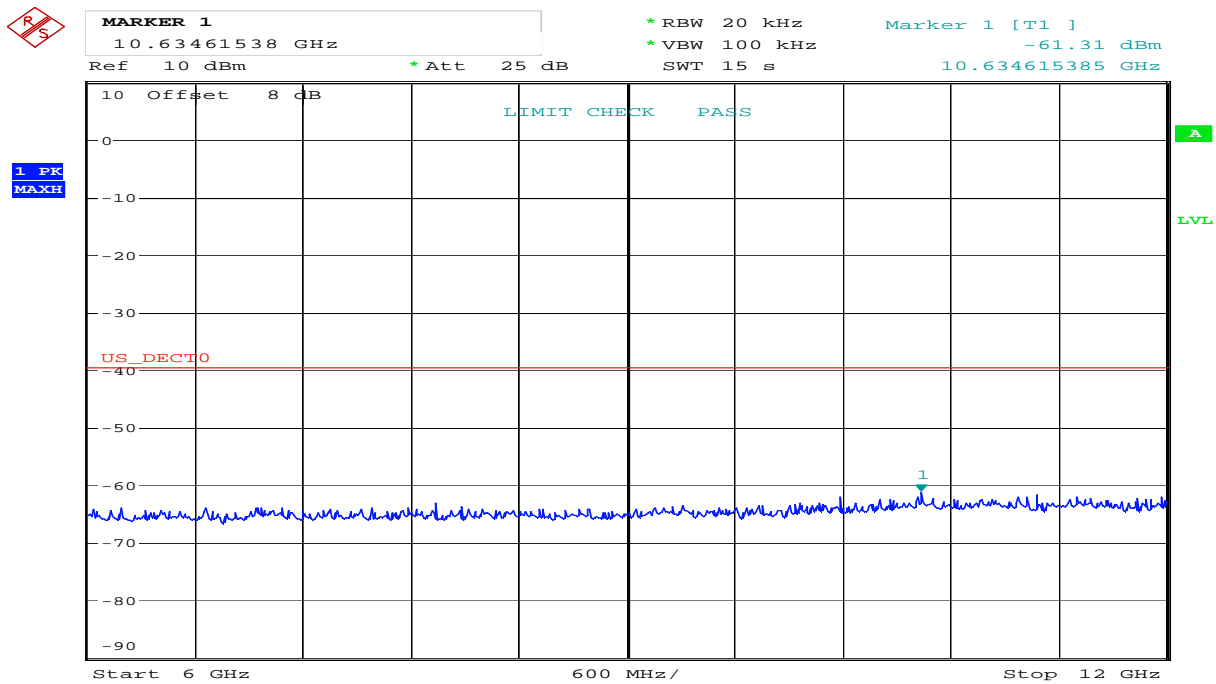

Date: 28.APR.2008 14:08:36

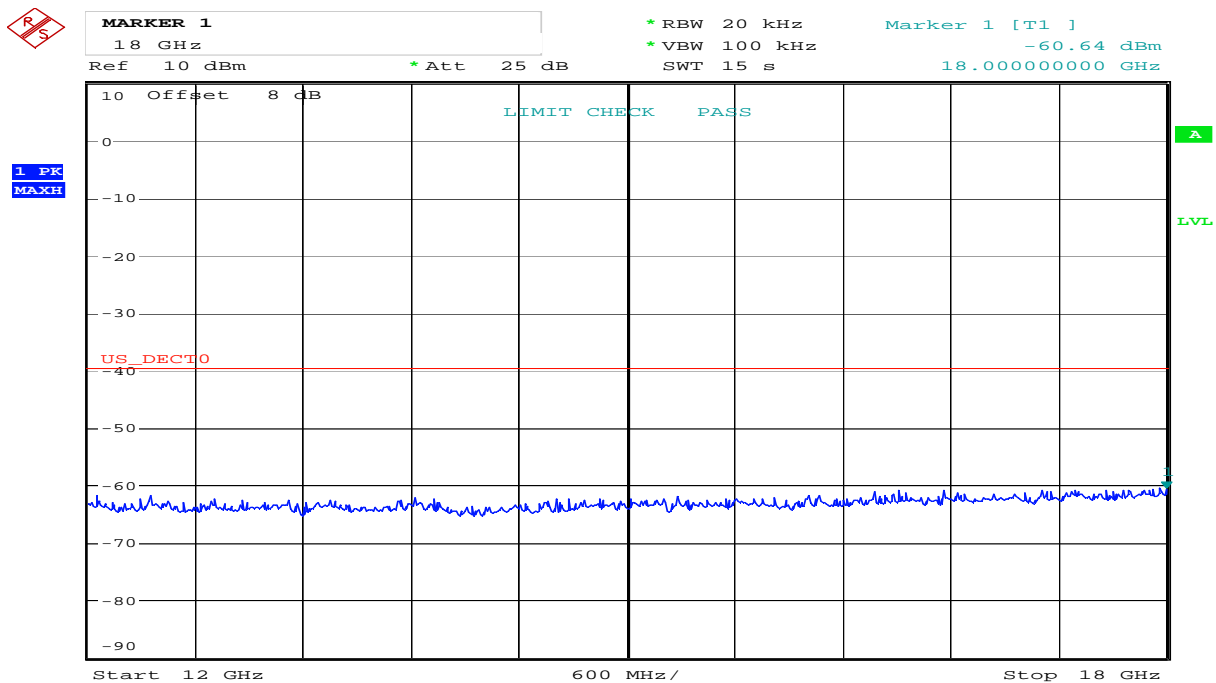

Date: 28.APR.2008 14:11:21

Out-of-Band Emissions, Conducted

Upper Channel:

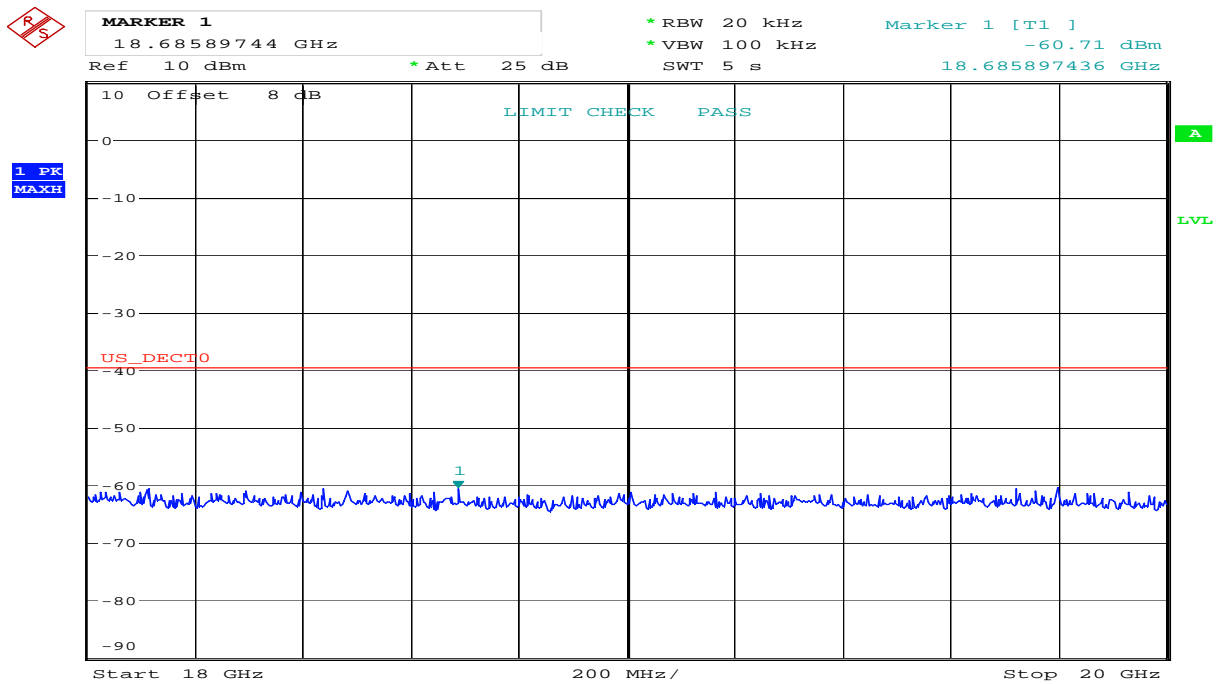

Date: 28.APR.2008 14:13:25

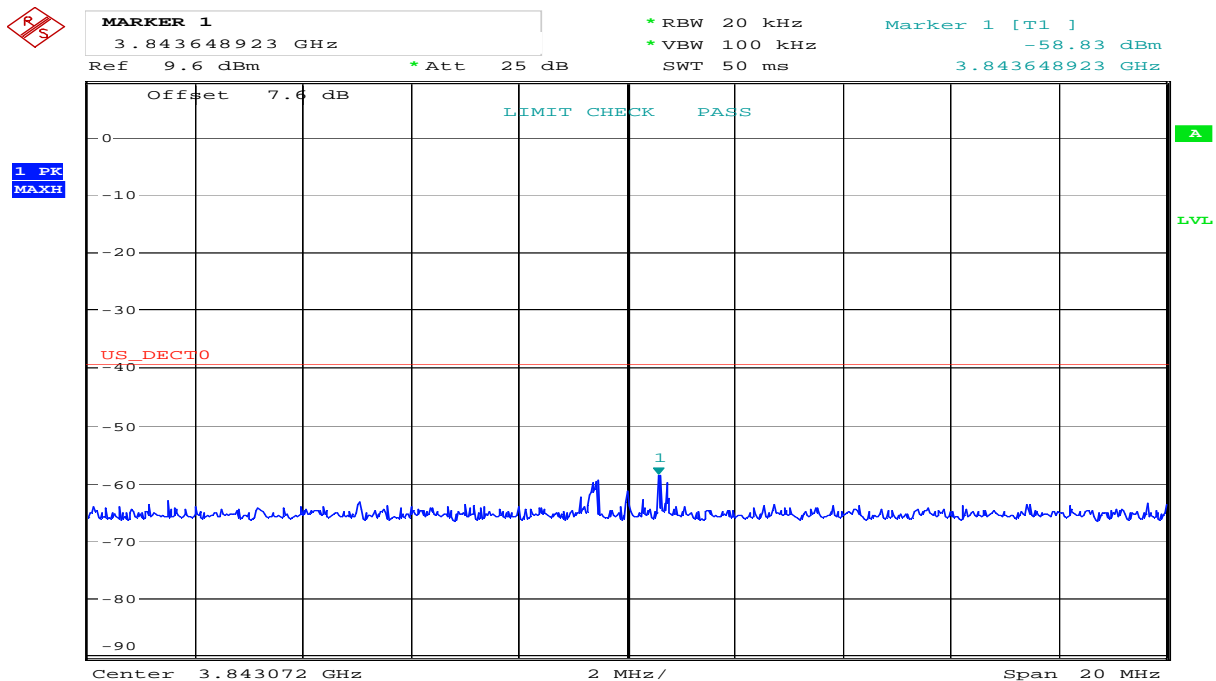

Date: 28.APR.2008 14:21:34

2nd Harmonic of Carrier

4.13 Carrier Frequency Stability

Test Method:

ANSI C63.17, clause 6.2.1.

Test Results: Complies

Measurement Data:

The Frequency Stability is measured with the CMD60. The CMD60 was logged by a computer programmed to get new readings as fast as possible (about 3 readings per second) over the noted time period or number of readings. The peak-to-peak difference was recorded and the mean value and deviation in ppm was calculated.

The Carrier Frequency Stability over Power Supply Voltage and over Temperature is measured with a Frequency Domain Analyzer in histogram mode.

Carrier Frequency Stability over Time at Nominal Temperature

Average Mean Carrier Frequency (MHz)	Max. Diff. (kHz)	Min. Diff. (kHz)	Max. Dev. (ppm)	Limit
1924.990037	+8.982	-12.690	-5.6	±10 ppm

Deviation ppm = ((Diff. - Mean Diff) / Mean Carrier Freq.) x 10⁶

Deviation (ppm) is calculated from 3000 readings.

Frequency Stability over Power Supply Voltage at Nominal Temperature

Voltage	Measured Carrier Frequency (MHz)	Difference (kHz)	Deviation (ppm)	Limit
V _{nom}	/	0	0	±10 ppm
85% of V _{nom}	/	/	/	
115% of V _{nom}	/	/	/	

Deviation ppm = ((Mean – Measured Frequency) / Mean) x 10⁶

This test does not apply for EUT that is powered from batteries.

Frequency Stability over Temperature

Temperature	Measured Carrier Frequency (MHz)	Difference (kHz)	Deviation (ppm)	Limit
T = +20 °C	1924.960828	0	0	±10 ppm
T = -20 °C	1924.951342	-9.5	-4.9	
T = +50 °C	1924.969323	8.5	4.4	

Deviation ppm = ((Mean – Measured Frequency) / Mean) x 10⁶

4.14 Frame Repetition Stability

Test Method:

ANSI C63.17, clause 6.2.2.

Test Results: Complies

Measurement Data:

The envelope of the RF signal from the EUT is detected with a Crystal Detector and the mean and standard deviation of the frame repetition frequency is then gated over 100 frames and measured with a Frequency Domain Analyzer. The frame repetition stability is 3 times the standard deviation.

Carrier Frequency (MHz)	Mean Frame Period (Hz)	Standard Deviation (Hz)	Frame Repetition Stability (ppm)
1924.992	100.0000201	0.00000705	0.212

Limit:

Frame Repetition Stability	±10 ppm (TDMA)
-----------------------------------	----------------

Ref. FCC 15.323(e), ANSI C63.17, clause 6.2.2

4.15 Frame Period and Jitter

Test Method:

ANSI C63.17, clause 6.2.3.

Test Results: Complies

Measurement Data:

Carrier Frequency (MHz)	Frame Period (ms)	Max Jitter (µs)	3xStandard Deviation of Jitter (µs)
1924.992	100.000022	-0.032	-0.019

Max Jitter = (1/ (Frame period + Pk-Pk/2)) - (1/Frame Period), when Pk-Pk and Frame Period are in Hz

$$3xSt.Dev.Jitter = 3x (1/(Frame Period + St.Dev) - 1/St.Dev) \times 10^6$$

Limit:

Frame Period	20 or 10 ms
Max Jitter	25 µs
3 times St.Dev of Jitter	12.5 µs

Ref. FCC 15.323(e), ANSI C63.17, clause 6.2.3

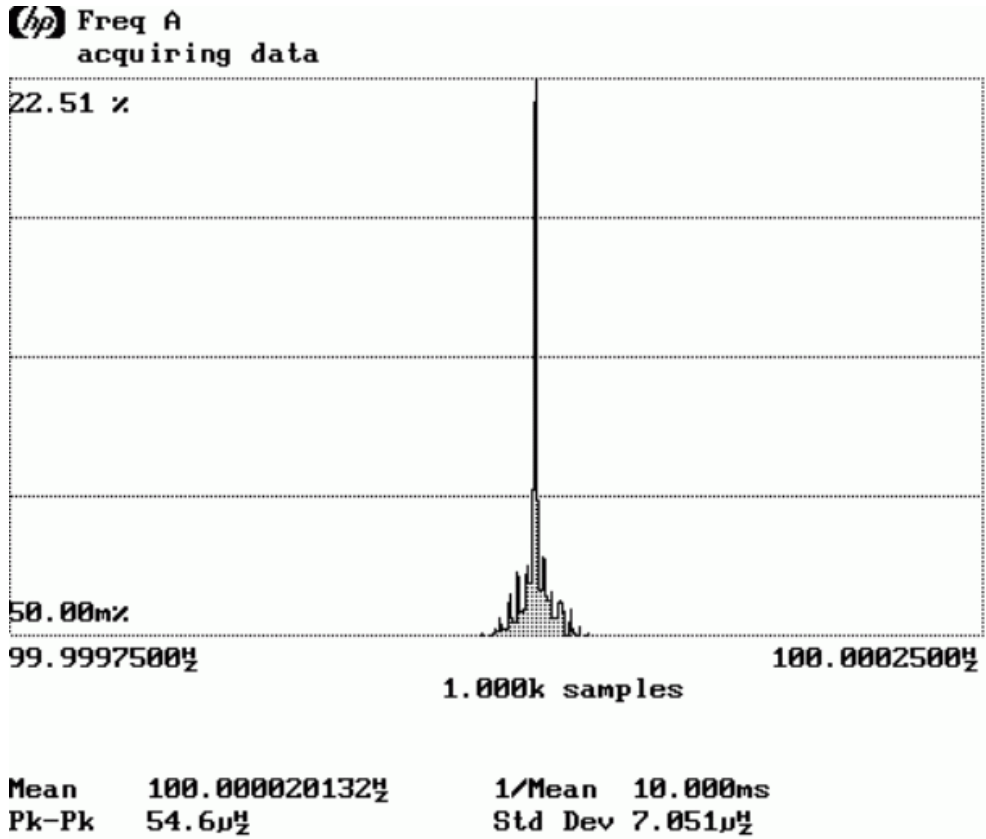

Frame Repetition Stability, Gated over 100 Frames

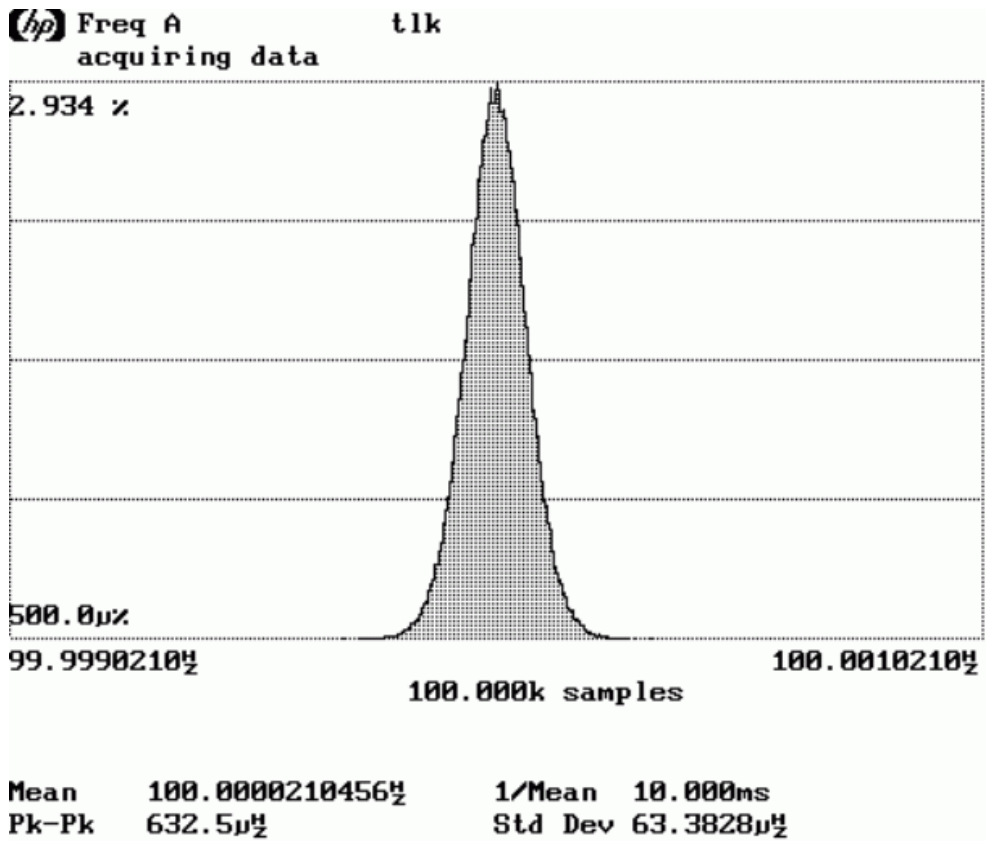

Frame Period and Jitter

4.16 Monitoring Threshold, Least Interfered Channel

Monitoring Threshold Limits:

Lower Threshold:

$$T_L = 15 \log B - 184 + 30 - P_{EUT} \quad (\text{dBm})$$

Upper Threshold:

$$T_U = 15 \log B - 184 + 50 - P_{EUT} \quad (\text{dBm})$$

B is measured Emission Bandwidth in Hz
 P_{EUT} is measured Transmitter Power in dBm

Calculated values:

Lower Threshold	-80.6 dBm
Upper Threshold	-60.6 dBm

The Lower Threshold is applicable for systems which have defined less than 40 duplex system access channels. The Upper Threshold is applicable for systems with more than 40 duplex system access channels and that implements the Least Interfered Channel Procedure (LIC).

Measurement Procedure:

The Upper or Lower Threshold is found by the procedure defined in ANSI C63.17 clause 7.3.1 or 7.3.2.

Least Interfered Channel Procedure NOT used:	
Lower Threshold	NA dBm
Least Interfered Channel Procedure:	
Upper Threshold	-60.6 dBm

Least Interfered Channel (LIC) Procedure Test, FCC 15.323(b), (c)(2) and (c)(5)

ANSI C63.17 clause 7.3.3 ref.	Observation	Verdict
b) f_1 $T_L + 13$ dB, f_2 at $T_L + 6$ dB	Transmission always on f_2	Pass
c) f_1 $T_L + 6$ dB, f_2 at $T_L + 13$ dB	Transmission always on f_1	Pass
d) f_1 $T_L + 7$ dB, f_2 at T_L	Transmission always on f_2	Pass
e) f_1 T_L , f_2 at $T_L + 7$ dB	Transmission always on f_1	Pass

Selected Channel Confirmation, FCC 15.323(c)(1) and (5)

ANSI C63.17 clause 7.3.4	Observation	Verdict
b) Shall not transmit on f_1	EUT transmits on f_2	Pass
d) Shall not transmit on f_2	EUT transmits on f_1	Pass

Limits:

Lower Threshold + 6 dB margin	-74.6 dBm
Upper Threshold + 6 dB margin	-54.6 dBm

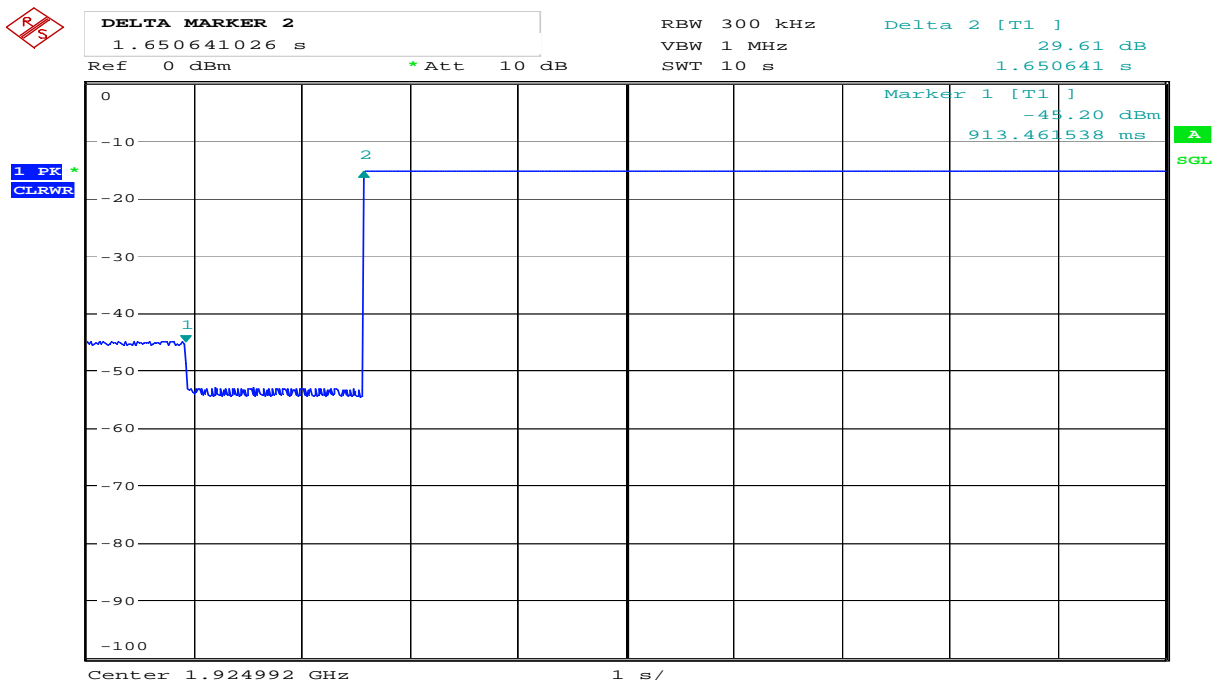

Date: 28.APR.2008 15:48:21

7.3.4 Selected Channel Confirmation, Connection 1.65s After Interferer Removed

4.17 Threshold Monitoring Bandwidth

This test is only required if a dedicated monitoring receiver is used. However, if the test is not carried out the manufacturer shall declare and provide proper evidence that the monitoring is made through the radio receiver used for communication.

Measurement Procedure:

Simple Compliance Test, ANSI C63.17, clause 7.4.1

More Detailed Test, ANSI C63.17, clause 7.4.2

The test is passed if **either** the Simple Compliance Test or the More Detailed test is passed.

During this test the spectrum analyzer is observed visually to see if the EUT transmits or not.

Test Results:

Test performed	Observation	Verdict
Simple Compliance test, at $\pm 30\%$ of B	No transmissions	Pass
More Detailed Test, at -6 dB points	N/A	N/A
More Detailed Test, at -12 dB points	N/A	N/A

The more detailed test must be pass at both the -6 and -12 dB points if the Simple Compliance test fails.

Comment: The Simple Compliance Test was performed with the level at $T_U + U_M + 10$ dB to check that the EUT did not transmit at all.

The tested EUT uses the same receiver for monitoring and communication, this test is therefore not required. However the test has been performed nonetheless and the test is passed.

Limits, FCC 15.323(c)(7):

The monitoring system bandwidth must be equal to or greater than the emission bandwidth of the intended transmission.

4.18 Reaction Time and Monitoring Interval

Measurement Procedure

ANSI C63.17, clause 7.5

Test results:

By administrative commands and out-of-operating region interference, the EUT is restricted to operate on a single carrier frequency.

Time-synchronized pulsed interference was then applied on the carrier at pulsed levels $T_U + U_M$ to check that the EUT does not transmit at all. The level was raised 6 dB for part d) with 35 μ s pulses.

The pulses are synchronized with the EUT timeslots and applied centered within all timeslots.

Pulse Width, ref. to ANSI C63.17 clause 7.5	Observation	Verdict
c) $>$ largest of 50 μ s and $50 \cdot \text{SQRT}(1.25/B)$	No transmissions	Pass
d) $>$ largest of 35 μ s and $35 \cdot \text{SQRT}(1.25/B)$, and with interference level raised 6 dB	No transmissions	Pass

Comment: Since B is larger than 1.25 MHz the test was performed with pulse lengths of 50 μ s and 35 μ s.

Limits, FCC 15.323(c)(1), (5) and (7)

The maximum reaction time must be less than $50 \cdot \text{SQRT}(1.25/\text{emission bandwidth in MHz})$ microseconds for signals at the applicable threshold level but shall not be required to be less than 50 microseconds.

If a signal is detected that is 6 dB or more above the applicable threshold level, the maximum reaction time shall be $35 \cdot \text{SQRT}(1.25/\text{emission bandwidth in MHz})$ microseconds but shall not be required to be less than 35 microseconds.



CENTER FREQUENCY
1.924992 GHz
Ref 0 dBm * Att 10 dB

RBW 300 kHz
VBW 1 MHz
SWT 10 ms

1 PK *
CLRWR

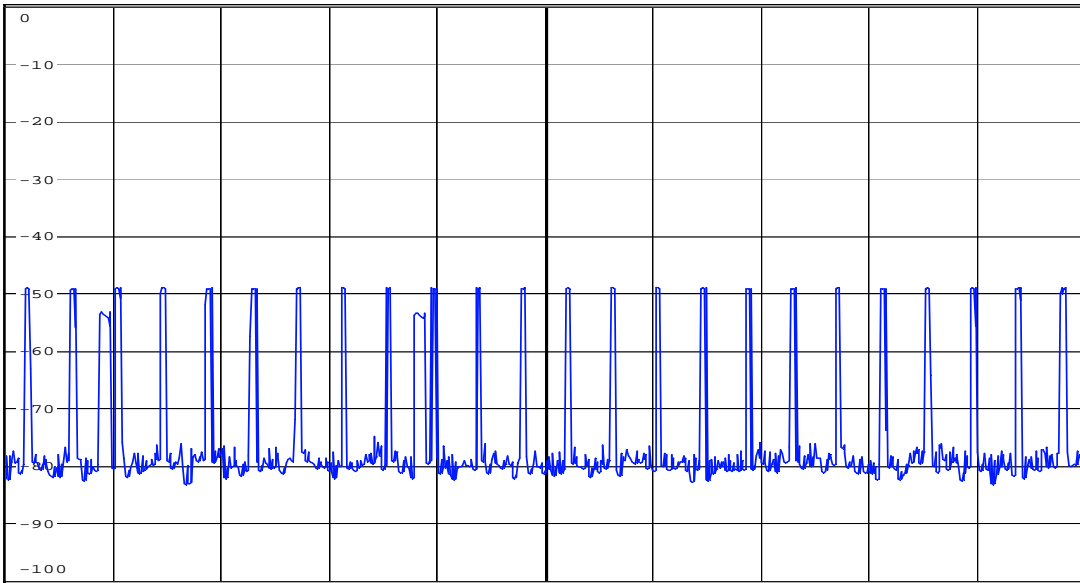

A
TRG

Center 1.924992 GHz 1 ms/

Date: 28.APR.2008 16:30:24

50 μs Pulses



CENTER FREQUENCY
1.924992 GHz
Ref 0 dBm * Att 10 dB

RBW 300 kHz
VBW 1 MHz
SWT 10 ms

1 PK *
CLRWR

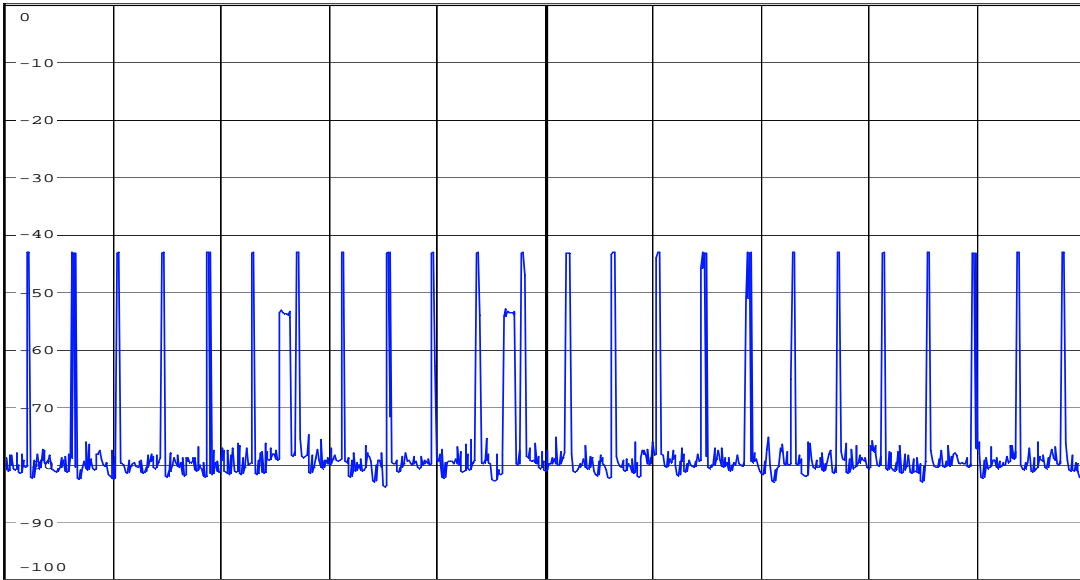

A
TRG

Center 1.924992 GHz 1 ms/

Date: 28.APR.2008 16:31:28

35 μs Pulses

4.19 Time and Spectrum Window Access Procedure

This requirement is only for EUTs which transmit unacknowledged control and signaling information.

Measurement Procedure:

Timing for EUTs using control and signaling channel type transmissions: ANSI C63.17, clause 8.1

Test results:

Access Criteria, ref. to ANSI C63.17 clause 8.1.1	Observation	Verdict
b) Check that the EUT transmits on the interference free time-slot	N/A	N/A
b) The EUT must terminate or pause in its repetitive transmission of the control and signalling channel on the open channel to repeat the access criteria not less frequently than every 30 s	N/A	N/A

If FCC 15.323(c)(6) option, **If Random Waiting Interval is NOT implemented**

Access Criteria, ref. to ANSI C63.17 clause 8.1.2	Observation	Verdict
b) Check that the EUT changes to an interference-free slot when interference is introduced on the time slot in use	N/A	N/A

If FCC 15.323(c)(6) option, **Only if Random Waiting Interval is implemented**

Access Criteria, ref. to ANSI C63.17 clause 8.1.3	Observation	Verdict
b-d) Check that the EUT uses random waiting interval before continuing transmission on an interfered time slot	N/A	N/A

Comment: The tested EUT does not transmit unacknowledged control and signaling information.

Limits:

FCC 15.323(c)(4):

Once access to specific combined time and spectrum windows is obtained an acknowledgement from a system participant must be received by the initiating transmitter within one second or transmission must cease. Periodic acknowledgements must be received at least every 30 seconds or transmission must cease. Channels used exclusively for control and signaling information may transmit continuously for 30 seconds without receiving an acknowledgement, at which time the access criteria must be repeated.

FCC 15.323(c)(6):

If the selected combined time and spectrum windows are unavailable, the device may either monitor and select different windows or seek to use the same windows after waiting an amount of time, randomly chosen from a uniform random distribution between 10 and 150 milliseconds, commencing when the channel becomes available

4.20 Acknowledgements and Transmission Duration

Measurement Procedure:

Acknowledgements: ANSI C63.17, clause 8.2.1

Transmission Duration: ANSI C63.17, clause 8.2.2

During the test **Initial transmission without acknowledgements** the signal from the EUT to the companion device is blocked by circulators in addition to the tunable attenuator.

The test **Transmission time after loss of acknowledgements** is performed by cutting-off the signal from the companion device by a RF switch and measuring the time until the EUT stops transmitting.

The **Transmission Duration** test is performed by monitoring the slot in use and measuring the time until the EUT changes to a different slot.

Test Results:

Acknowledgements

Test ref. to ANSI C63.17 clause 8.2.1	Observation	Verdict
a) Initial transmission without acknowledgements	0.27s	Pass
c) Transmission time after loss of acknowledgements	5.0s	Pass

Transmission Duration

Test ref. to ANSI C63.17 clause 8.2.2	Observation	Verdict
b) Transmission duration on same time and frequency window	7.0 hours	Pass

Comment: /

Limits, FCC 15.323(c)(3) and (4)

Occupation of the same combined time and spectrum windows by a device or group of cooperating devices continuously over a period of time longer than 8 hours is not permitted without repeating the access criteria.

Once access to specific combined time and spectrum windows is obtained an acknowledgement from a system participant must be received by the initiating transmitter within one second or transmission must cease.

Periodic acknowledgements must be received at least every 30 seconds or transmission must cease. Channels used exclusively for control and signaling information may transmit continuously for 30 seconds without receiving an acknowledgement, at which time the access criteria must be repeated.

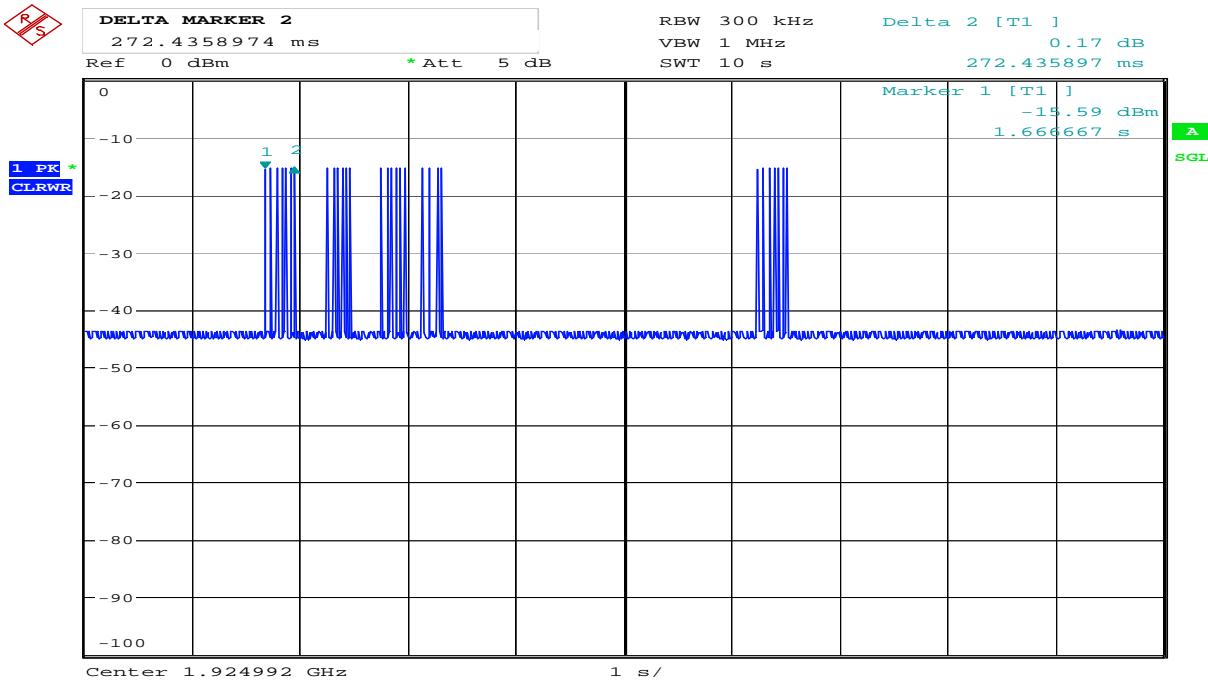

Date: 28.APR.2008 17:51:32

8.2.1a) Initial Transmission Time Without Acknowledgements

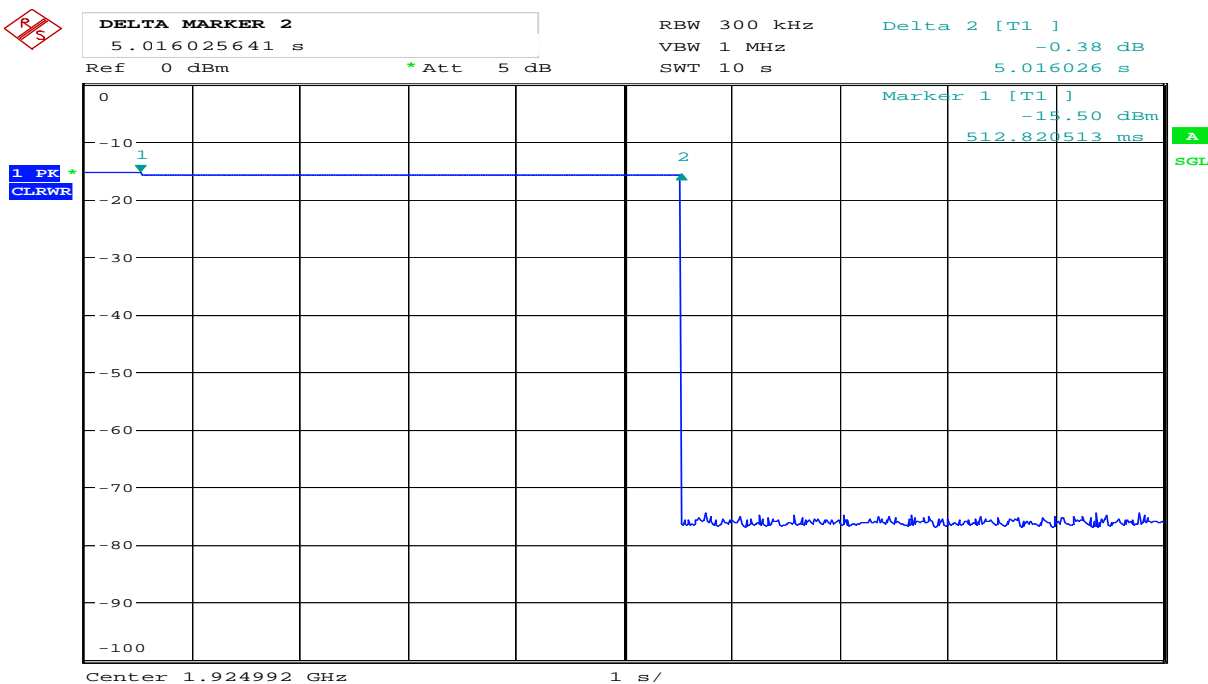

Date: 28.APR.2008 17:42:26

8.2.1c) Transmission Time After Loss of Acknowledgements

4.21 Dual Access Criteria Check

Measurement Procedure:

EUTs that does not implement the Upper Threshold: ANSI C63.17, clause 8.3.1

EUTs that implement the Upper Threshold: ANSI C63.17, clause 8.3.2

This test is required for equipment that uses the access criteria in FCC 15.323(c)(10).

Test Results:

EUTs that do NOT Implement the Upper Threshold:

Test ref. to ANSI C63.17 clause 8.3.1	Observation	Verdict
b) EUT is restricted to a single carrier f_i for TDMA systems. The Test is Pass if EUT can transmit	N/A	N/A
c) d) No transmissions on interference-free receive time/spectrum window. All transmit slots blocked.	N/A	N/A
e) f) No transmission on interference-free transmit time/spectrum window. All receive slots blocked.	N/A	N/A

EUTs that Implements the Upper Threshold:

Test ref. to ANSI C63.17 clause 8.3.2	Observation	Verdict
b) EUT is restricted to a single carrier f_i for TDMA systems. The Test is Pass if EUT can transmit	EUT can transmit	Pass
c) d) Transmission on interference-free receive time/spectrum window	EUT transmits on interference free receive slot	Pass
e) f) Transmission on interference-free transmit time/spectrum window	EUT transmits on interference free transmit slot	Pass
g) Transmission not possible on any time/spectrum window	No connection possible	Pass

Comment: See plots.

Limits, FCC 15.323(c)(10)

An initiating device may attempt to establish a duplex connection by monitoring both its intended transmit and receive time and spectrum windows. If both the intended transmit and receive time and spectrum windows meet the access criteria, then the initiating device can initiate a transmission in the intended transmit time and spectrum window. If the power detected by the responding device can be decoded as a duplex connection signal from the initiating device, then the responding device may immediately begin transmitting on the receive time and spectrum window monitored by the initiating device.



RESOLUTION BANDWIDTH
 200 kHz
 Ref -10 dBm * Att 5 dB

RBW 200 kHz
 VBW 500 kHz
 SWT 10 ms

1 PK *
 CLRWR

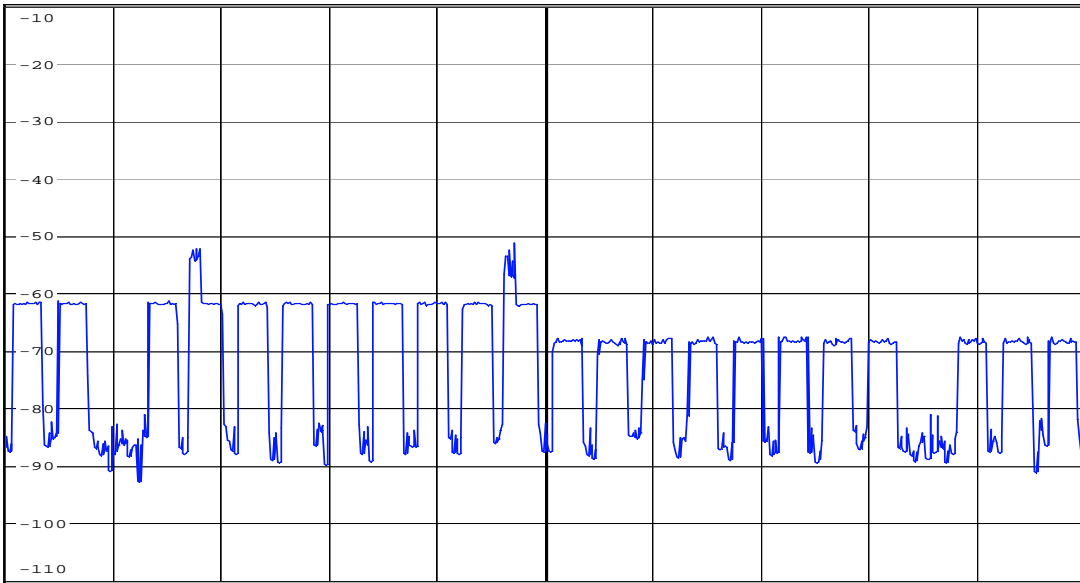

Center 1.924992 GHz 1 ms/

Date: 28.APR.2008 17:23:08

8.3.2c) EUT Transmits on Interference Free RECEIVE Slot, BEFORE



RESOLUTION BANDWIDTH
 200 kHz
 Ref -10 dBm * Att 5 dB

RBW 200 kHz
 VBW 500 kHz
 SWT 10 ms

1 PK *
 CLRWR

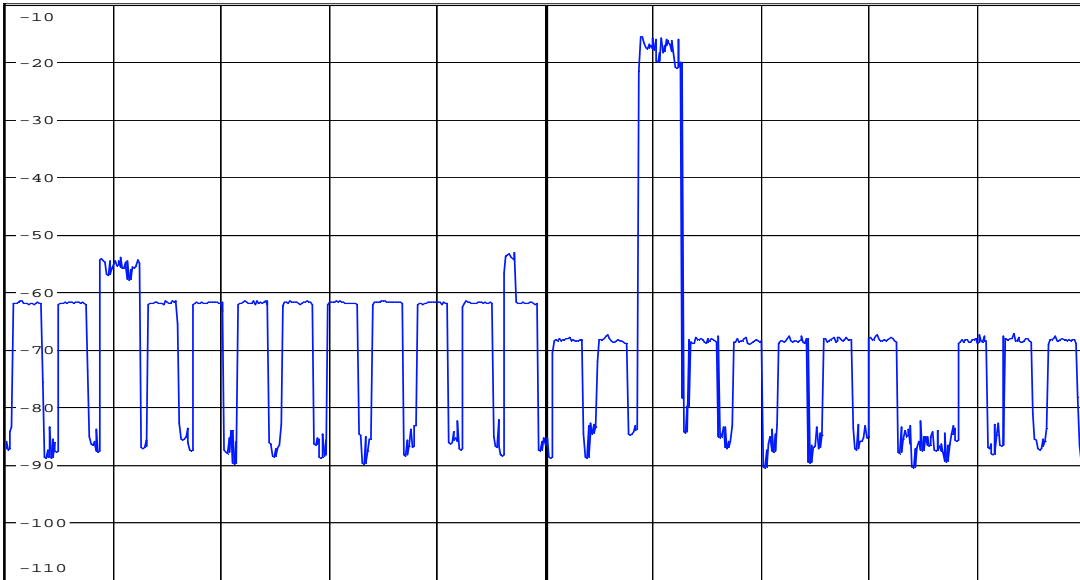

Center 1.924992 GHz 1 ms/

Date: 28.APR.2008 17:24:02

8.3.2c) EUT Transmits on Interference Free RECEIVE Slot, AFTER

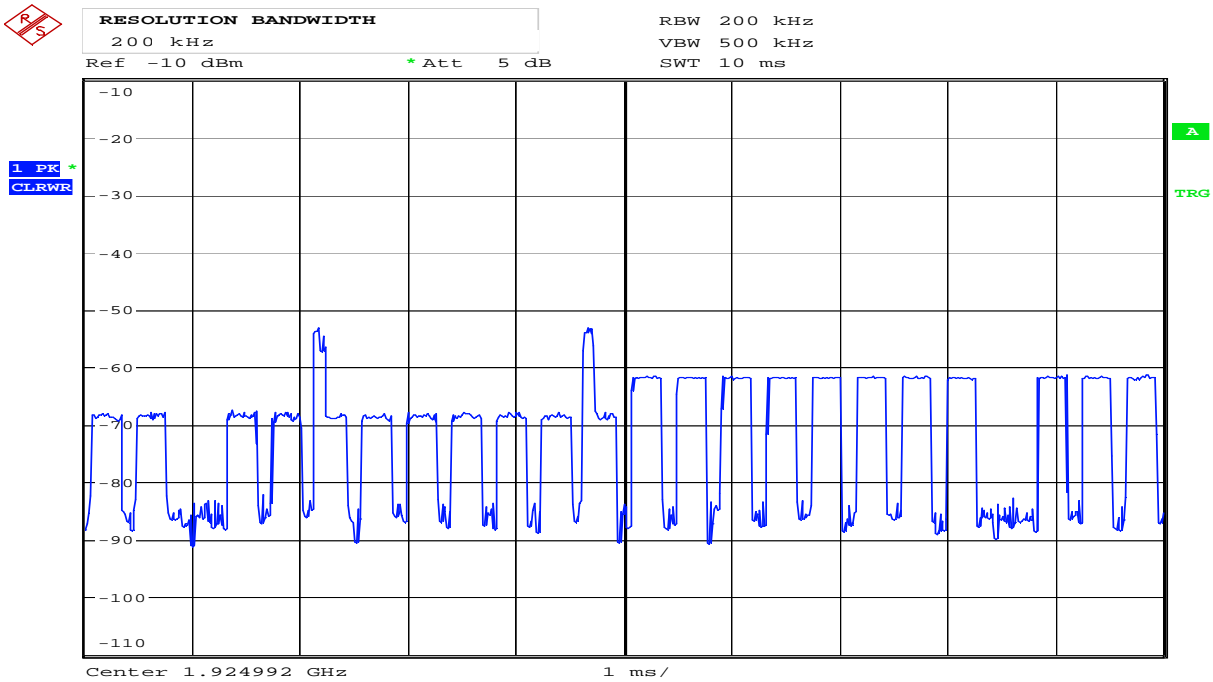

Date: 28.APR.2008 17:26:18

8.3.2e) EUT Transmits on Interference Free TRANSMIT Slot, BEFORE

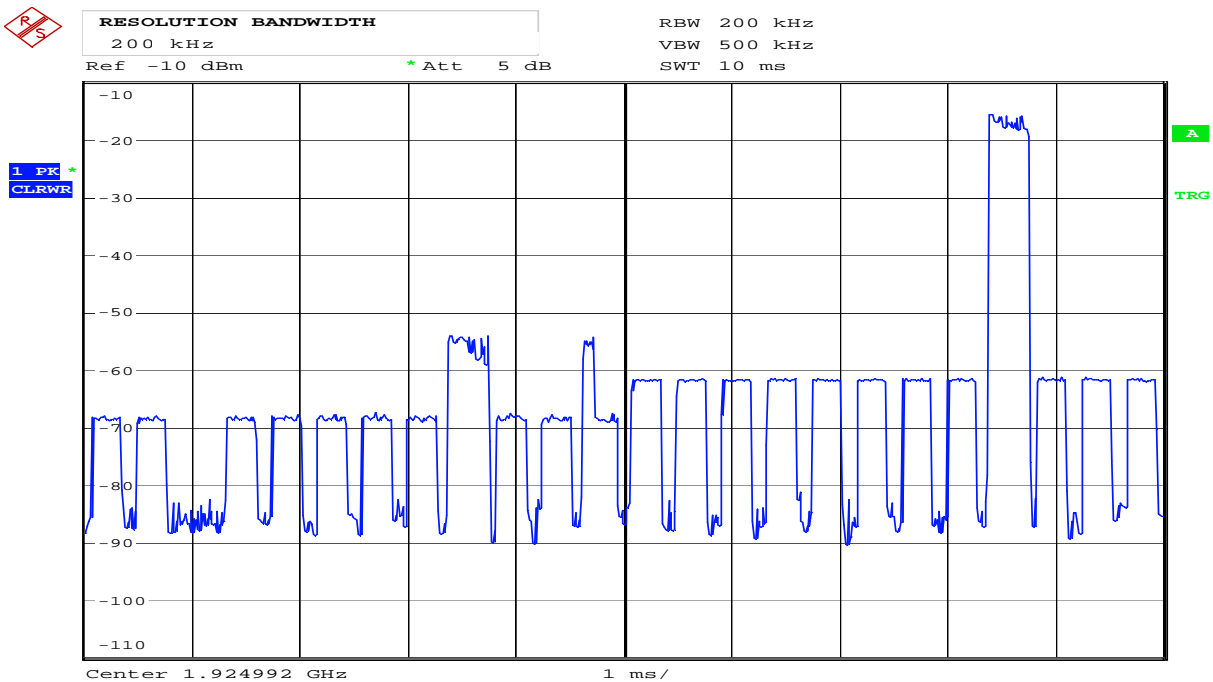

Date: 28.APR.2008 17:26:45

8.3.2e) EUT Transmits on Interference Free TRANSMIT Slot, AFTER



RESOLUTION BANDWIDTH
200 kHz
Ref -10 dBm * Att 5 dB

RBW 200 kHz
VBW 500 kHz
SWT 10 ms

1 PK *
CLRWR

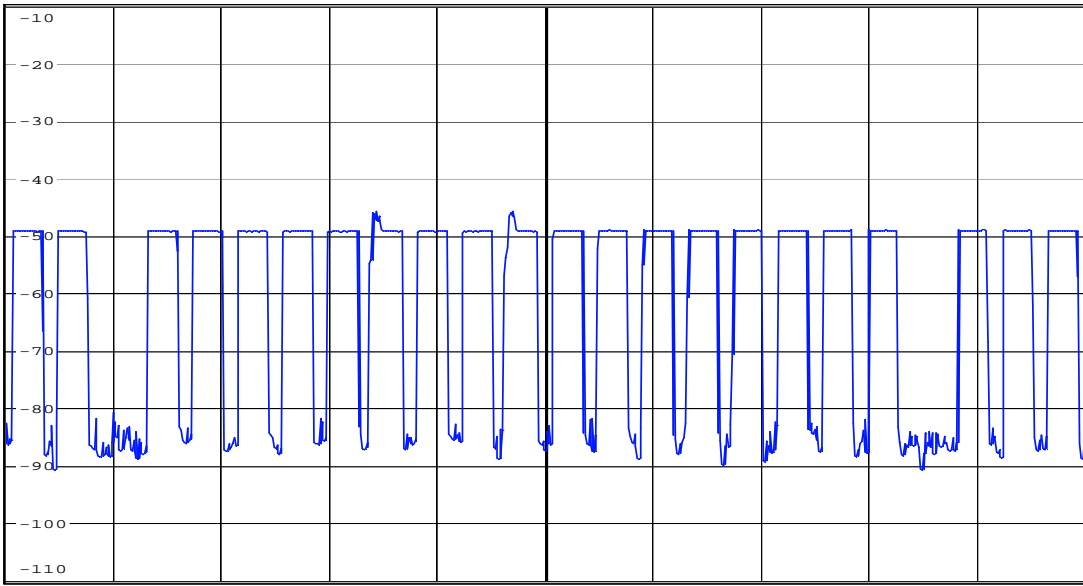

Center 1.924992 GHz 1 ms/

Date: 28.APR.2008 17:28:07

8.3.2g) No Connection

4.22 Alternative Monitoring Interval

Test procedure described in ANSI C63.17 clause 8.4.

This test is required if the EUT implements the provisions of FCC 15.323(c)(11).

Test result:

Not Tested. The tested EUT does not implement this provision. See manufacturers' declaration.

4.23 Receiver Spurious Emissions

Measurement Procedure:

Industry Canada RSS-213 paragraph 6.8 and RSS-GEN paragraphs 4.8 and 6.

Test results:

Frequency MHz	Carrier No.	Measured Value Conducted dBm	Conducted Limit dBm	Margin dB
30 - 1000	all	< -75	-57	>18
> 1000	all	< -73	-53	>20

The Receiver Spurious Emissions are covered by paragraph 4.23 Spurious Emissions Radiated. No separate Spurious Emissions which could be related to the receiver were detected during the radiated test.

Requirements, RSS-GEN Issue 2, clause 6

The measurement can be performed either radiated or conducted.

When measured Conducted: no spurious signals appearing at the antenna terminals shall exceed 2 nW per any 4 kHz spurious frequency in the band 30-1000 MHz, or 5 nW above 1 GHz.

When measured Radiated: See Table 1 in RSS-GEN Issue 2, clause 6.

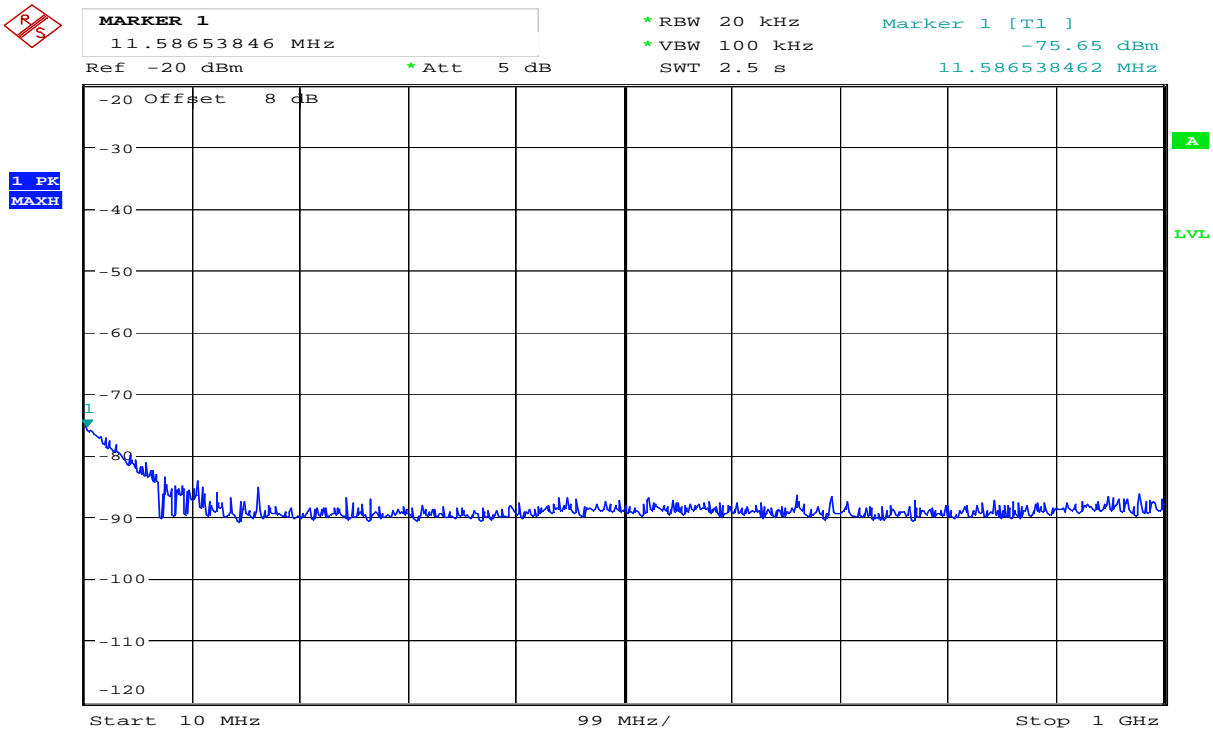

Date: 6.MAY.2008 12:56:58

Receiver Emissions, Conducted, 10 – 1000 MHz

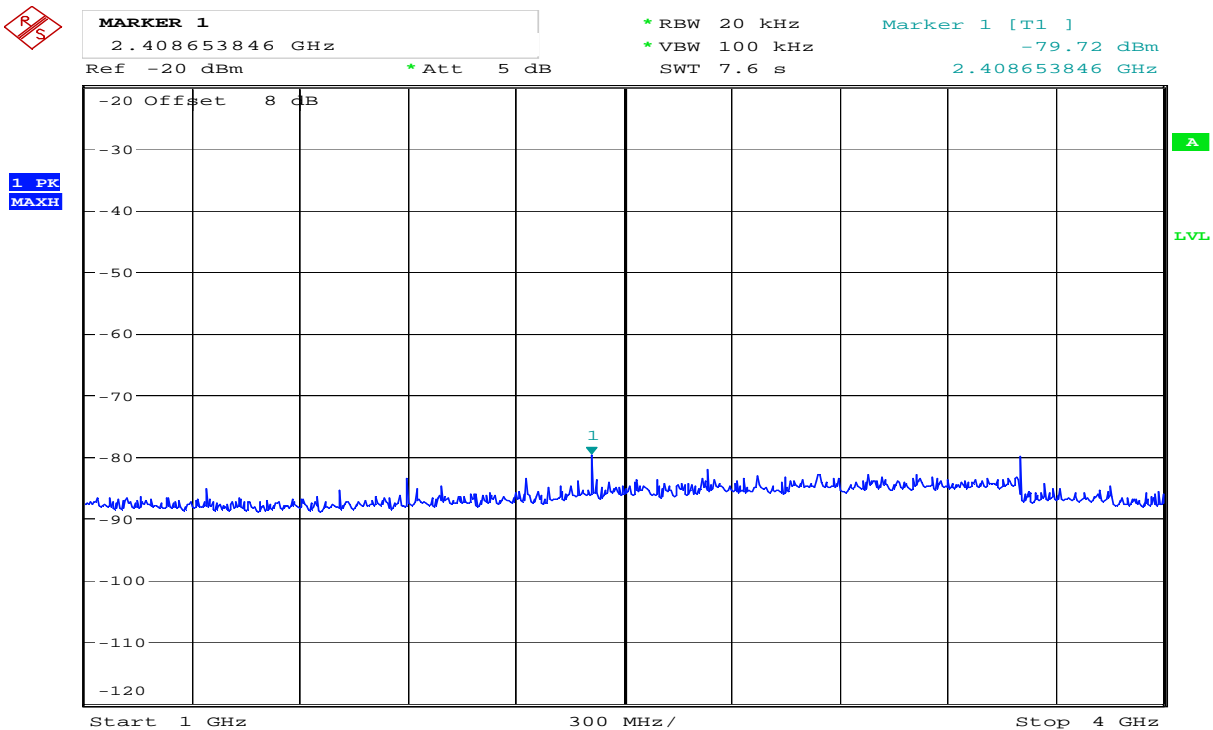

Date: 6.MAY.2008 12:58:47

Receiver Emissions, Conducted, 1 – 4 GHz

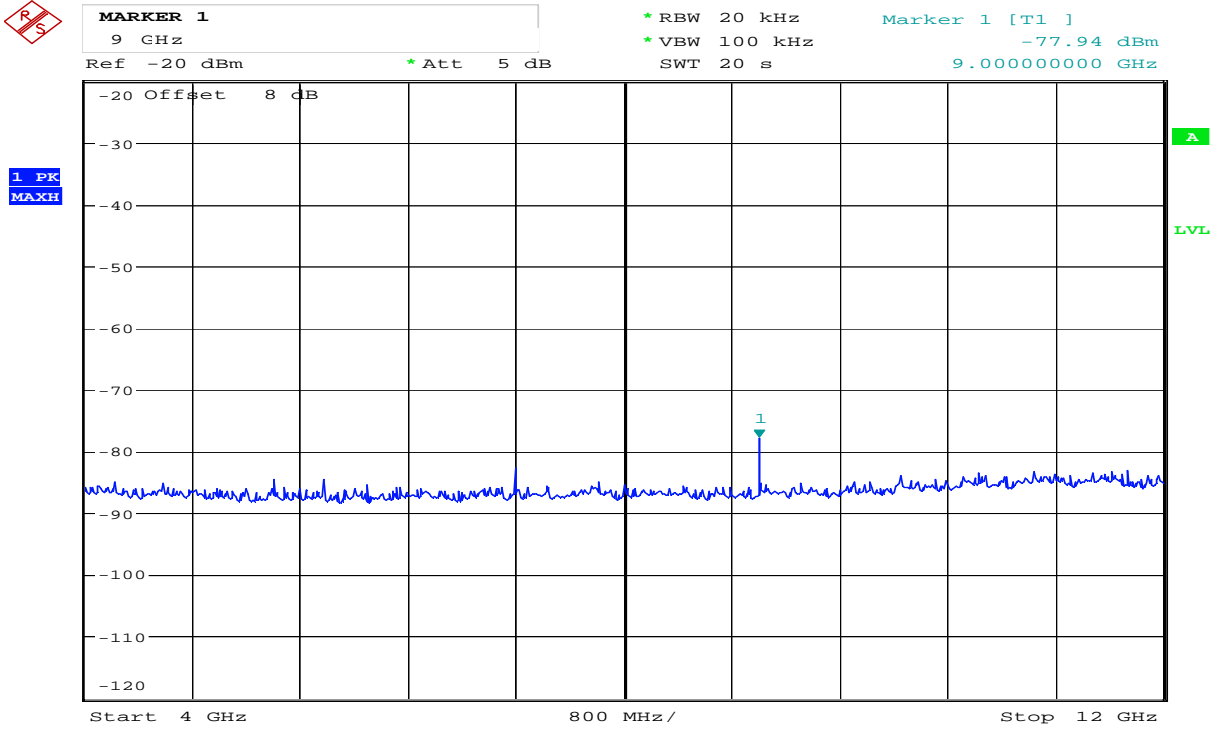

Date: 6.MAY.2008 13:00:31

Receiver Emissions, Conducted, 4 – 12 GHz

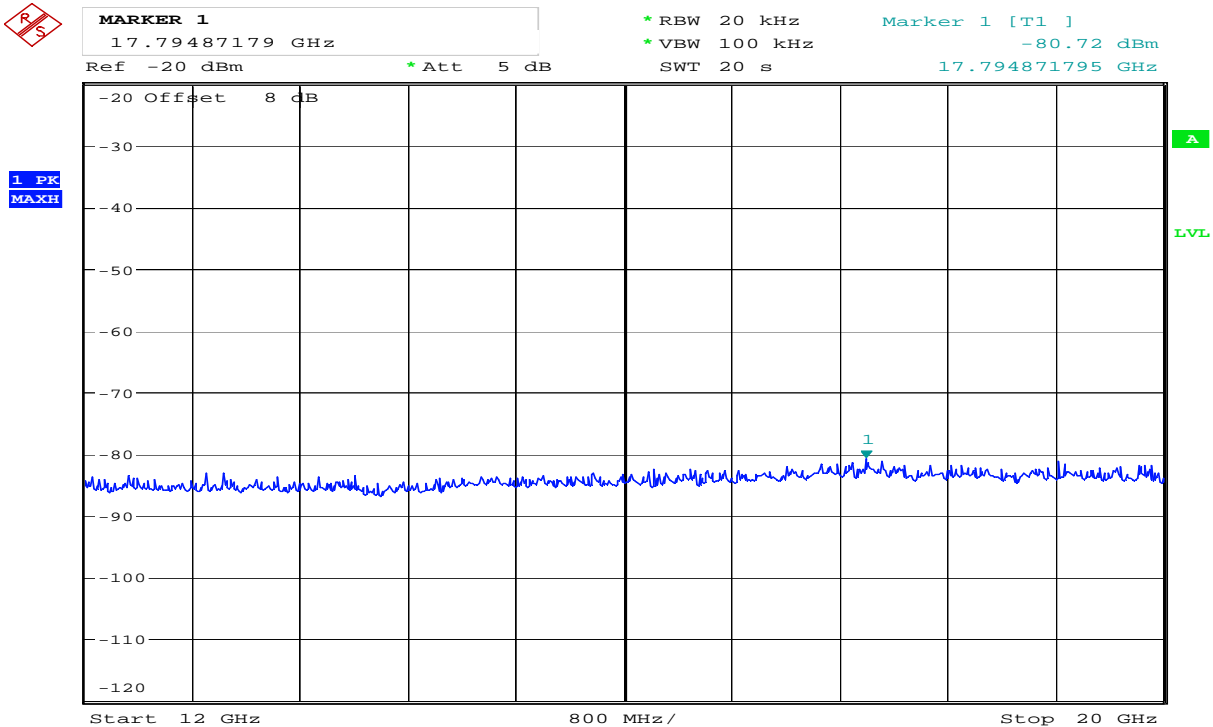

Date: 6.MAY.2008 13:01:53

Receiver Emissions, Conducted, 12 – 20 GHz

5 Test Setups

5.1 Frequency Measurements



Test equipment included: 3, 5

Test Set-up 1

This setup is used for measuring Carrier frequency stability at normal and extreme temperatures.

The EUT was in loopback-mode and was controlled with the CMD60 for this test. The modulation pattern was set to 01010101...

5.2 Timing Measurements

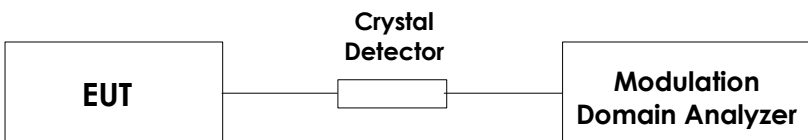

Test equipment included: 3, 5, 7

Test Set-up 2

This setup is used for measuring Frame repetition stability, Frame period and Jitter.

The EUT was in loopback-mode and was controlled with the CMD60 for this test. The modulation pattern was set to 01010101...

5.3 Conducted Emission Test

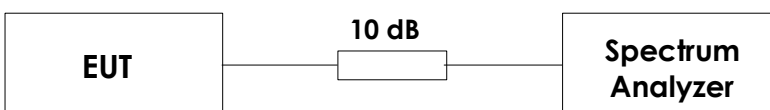

Test equipment included: 1, 3, 13, 29

Test Set-up 3

This setup is used for all conducted emission tests.

The EUT was in loopback-mode and was controlled with the CMD60 for this test. The modulation pattern was set to Pseudo-Random bit sequence to simulate normal speech.

5.4 Radiated Emissions Test

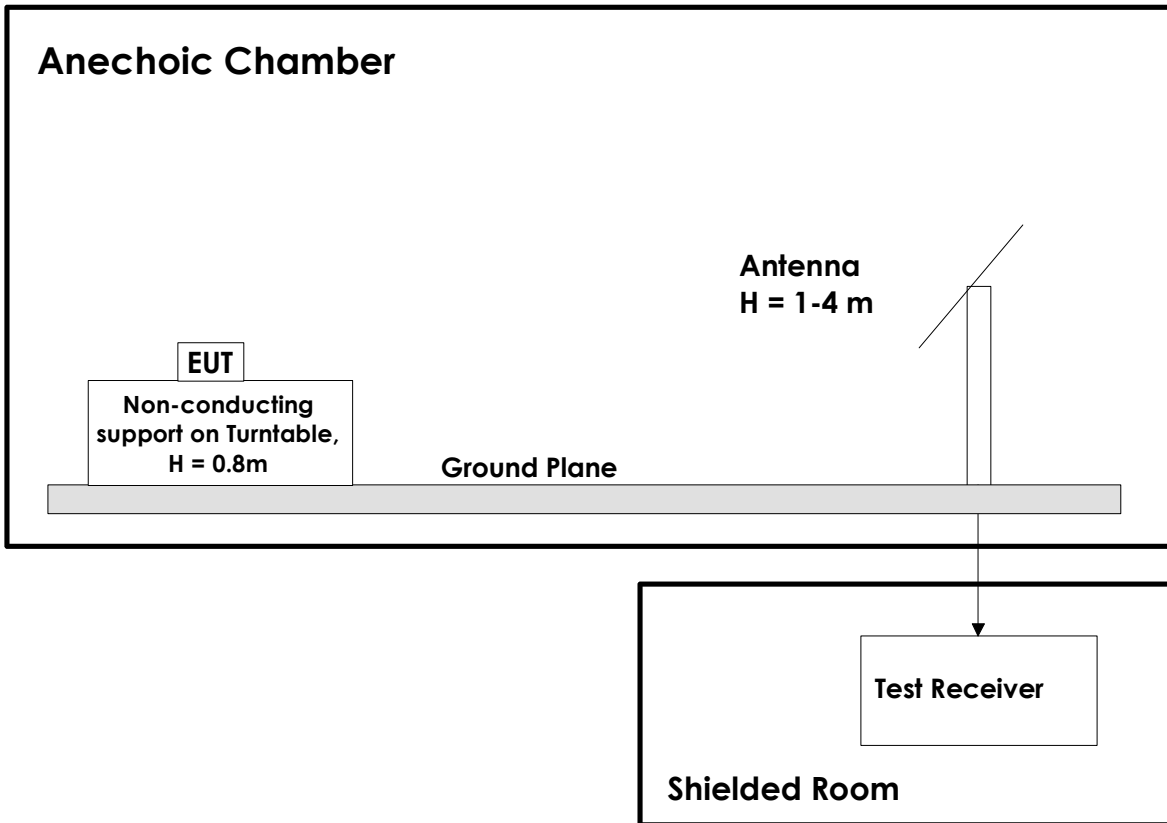

Test equipment: 1, 8, 9, 10, 11, 20, 21, 22, 23, 24, 25, 26

Test Set-Up 4

This test setup is used for all radiated emissions tests. For frequencies below 30 MHz the measuring distance is 10 m, for all other frequencies it is 3m or 1m. Emissions above 1 GHz were measured with a Spectrum Analyzer and Horn Antenna and with the preamplifier after the antenna. For measurements above 18 GHz the test receiver is moved inside the anechoic chamber and located next to the antenna to minimize the cable loss.

5.5 Power Line Conducted Emissions Test

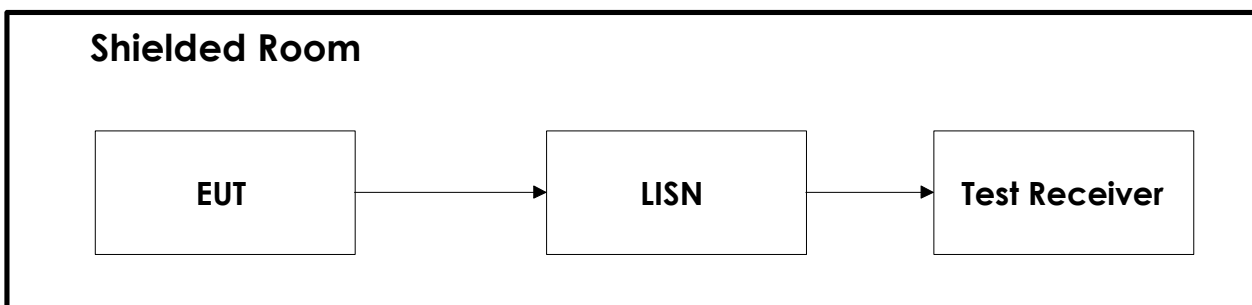

Test equipment: 12, 27, 28

Test Set-Up 5

5.6 Monitoring Tests

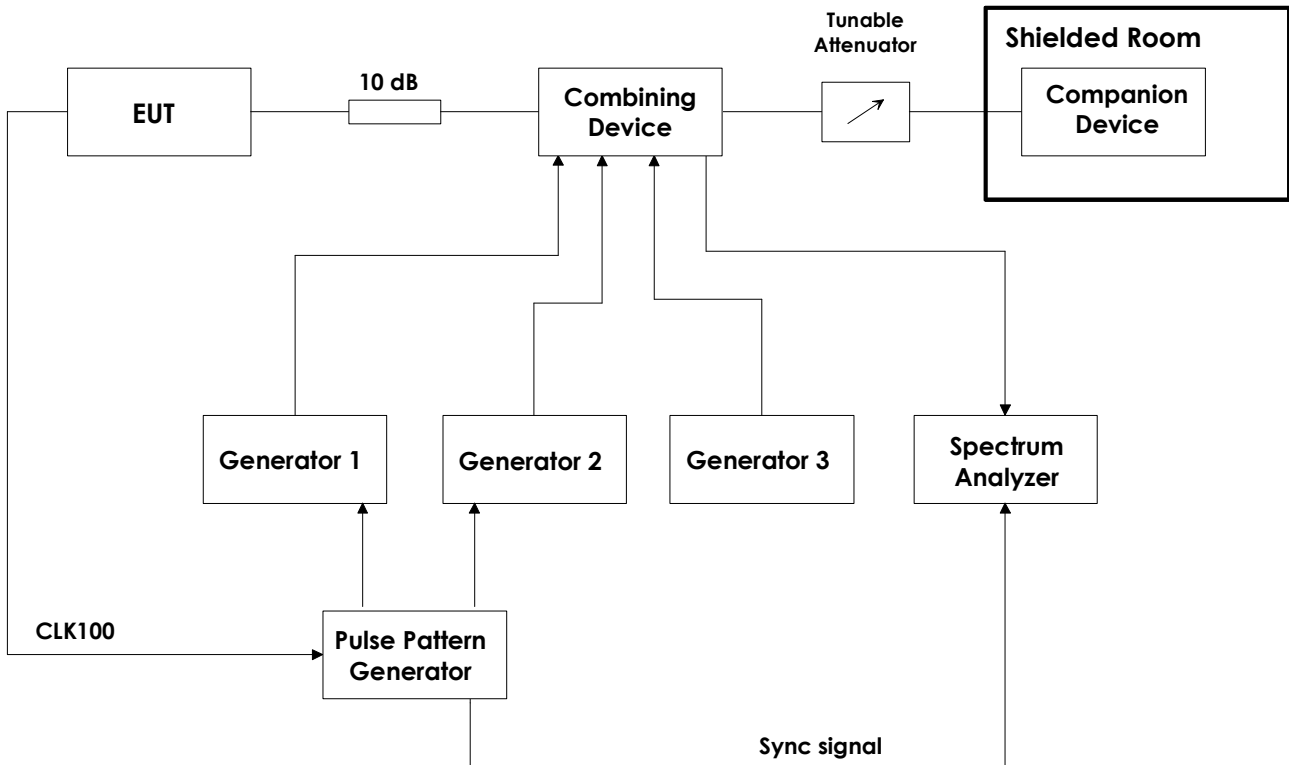

Test equipment: 1, 2, 4, 6, 13, 14, 15, 16, 17, 18, 19, 29

Test Set-Up 6

This test setup is used for all Monitoring and Time and Spectrum Access Procedure tests. The path loss from the signal generators to the EUT is measured with a power meter before the testing is started.

The CLK100 is used to synchronize the Pulse-/ Pattern generator to the start of the DECT frame, this signal always comes from the base station. If the EUT is a DECT Portable Part (i.e. a handset) the CLK100 signal will come from the Companion Device.

The sync signal to the Spectrum Analyzer is the CLK100 signal that is regenerated in the Pulse-/ Pattern Generator, this is used to synchronize the Spectrum Analyzer to the DECT frame when in zero span. The Pulse-/ Pattern Generator is used for tests that require time synchronized pulses or blocking of specific time slots.

6 Test Equipment Used

To facilitate inclusion on each page of the test equipment used for related tests, each item of test equipment and ancillaries are identified (numbered) by the Testhouse.

No.	Instrument/ancillary	Type of instrument/ancillary	Manufacturer	Ref. no.
1	FSEK30	Spectrum Analyzer	Rohde & Schwarz	LR 1337
2	SME03	Signal generator	Rohde & Schwarz	LR 1238
3	CMD60	DECT Tester	Rohde & Schwarz	LR 1335
4	SMP22	Signal generator	Rohde & Schwarz	LR 1287
5	53310A	Modulation Domain Analyzer	Hewlett Packard	LR 1483
6	81104A	Pulse-/ Pattern Generator	Agilent	LR 1502
7	8470B	Crystal Detector	Hewlett Packard	LR 1207
8	8449B	Preamplifier	Hewlett Packard	LR 1322
9	4HC3000/18000	High-pass filter	Trilithic	S.No.: 9849045
10	ESVS30	Measuring Receiver	Rohde & Schwarz	LR 1101
11	ESN	Measuring Receiver	Rohde & Schwarz	LR 1237
12	ESAI	Measuring Receiver	Rohde & Schwarz	LR 1090
13	6810.17B	Attenuator	Narda	LR1212
14	745-69	Step Attenuator	Narda	LR 1442
15	WE 1506A	Power Splitter	Weinchel	LR 244
16	WE 1506A	Power Splitter	Weinchel	LR 245
17	H-9	Hybrid	Anzac	LR 86
18	H-9	Hybrid	Anzac	LR 257
19	S212DS	RF Switch	Narda	LR 1244
20	3115	Horn Antenna	EMCO	LR 1226
21	PM7320-X	Horn Antenna	Sivers Lab	LR 102
22	DBF-520-20	Horn Antenna	Systron Donner	LR 100
23	638	Horn Antenna	Narda	LR 1480
24	HL223	Log-period Antenna	Rohde & Schwarz	LR 1261
25	HK116	Biconical Antenna	Rohde & Schwarz	LR 1260
26	HFH2-Z2	Loop Antenna	Rohde & Schwarz	LR 285
27	ESH3-Z5	Two Line V-Network	Rohde & Schwarz	LR 1076
28	80S	Signal Generator	Powertron	LT 502
29	FSU26	Spectrum Analyzer	Rohde & Schwarz	LR 1504
30	6812B	AC Power Source	Agilent	LR 1515