

MEASUREMENT REPORT of CORDLESS TELEPHONE

Applicant : DBTEL INCORPORATED
Model No. : DB-8228, DB-8232
EUT : 900 MHz S.S.T. Cordless Phone
FCC ID : BW3DB-8228
Report No. : D0415973

Test by :

Training Research Co., Ltd.

TEL : 886-2-26935155 FAX : 886-2-26934440
No. 5-3, Lane 21, Yen Chiu Yuan Rd., Sec. 4, Taipei, 11521 Taiwan R.O.C.

CERTIFICATION

We here by verify that:

The test data, data evaluation, test procedures and equipment configurations shown in this report were made mainly in accordance with the procedures given in ANSI C63.4 (1992) as a reference. All test were conducted by *Training Research Co., Ltd.*, No. 5-3, Lane 21, Yen-Chiu-Yuan Rd., Sec. 4, Taipei, 11521 Taiwan, R.O.C. Also, we attest to the accuracy of each.

We further submit that the energy emitted by the sample EUT tested as described in the report is **in compliance with** the technical requirements set forth in the FCC Rules Part 15 Subpart C Section 15.233.

Applicant : DBTEL INCORPORATED
Model No. : DB-8228, DB-8232
EUT : 900 MHz S.S.T. Cordless Phone
FCC ID : BW3DB-8228
Report No. : D0415973
Test Date : APR. 07, 1999

Prepared by:

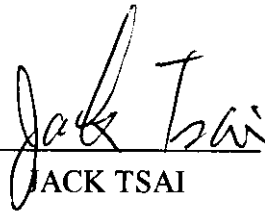
JACK TSAI

Approved by:

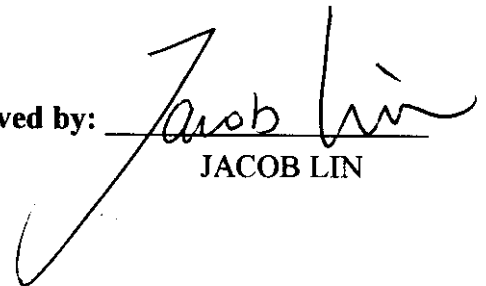
JACOB LIN

Test by :

Training Research Co., Ltd.

TEL: 886-2-26935155

FAX: 886-2-26934440

No. 5-3, Lane 21, Yen Chiu Yuan Rd., Sec. 4, Taipei, 11521 Taiwan R.O.C.

Tables of Contents

I . GENERAL	3
1.1 Introduction	3
1.2 Description of EUT	3
1.3 Description of Support Equipment	3
1.4 Configuration of System Under Test	4
1.5 Verify the Frequency and Channel	4
1.5.1 Verify the Frequency Pairs	4
1.6 Test Procedure	5
1.7 Location of the Test Site	5
1.8 General Test Condition	5
 II . Section 15.207: Power Line Conducted Emissions for AC Powered Units	 6
2.1 Test Condition & Setup	6
2.2 List of Test Instruments	6
2.3 Test Configuration	7
2.4 Test Result of Conducted Emissions	8
2.4.1 Base Station Transmit Only	8
 III . Section 15.247(a)(2): Bandwidth for Direct Sequence System	 14
3.1 Test Condition & Setup	14
3.2 Test Instruments Configuration	14
3.3 List of Test Instruments	14
3.4 Test Result of Bandwidth	15
 IV . Section 15.247(a) (2) : Power Output	 16
4.1 Test Condition & Setup	16
4.2 List of Test Instruments	17
4.3 Test Result of Fundamental Emission	18

V. Section 15.247(c) (2) : Spurious Emissions (Radiated)	19
5.1 Test Condition & Setup	19
5.2 List of Test Instruments	20
5.2.1 Duty Cycle Factor Measurement	20
5.3 Test Instruments Configuration	21
5.4 Test Result of Second Harmonic	23
5.5 Test Result of Spurious Radiated Emissions	24
5.5.1 Base and Handset Station Transmit Only	24
VI. Section 15.247(d) : Power Spectral Density	50
6.1 Test Condition & Setup	50
6.2 Test Instruments Configuration	51
6.3 List of Test Instruments	51
6.4 Required of Carrier Frequency	52
6.5 Test Result of Power Spectral Density	53
VII. Section 15.247(e): Processing Gain	54
7.1 Test Condition & Setup	54
7.2 Test Instruments Configuration	56
7.3 List of Test Instruments	57
7.4 Test Procedure	57
7.5 Test Result of Processing Gain	58
Appendix A : Set Up Procedure	60
Appendix B : Antenna Sketch	61
Appendix C : Part15.203	62
Appendix D : Security Code	63

I . GENERAL

1.1 Introduction

The following measurement report is submitted on behalf of Applicant in support of a Cordless Telephone certification in accordance with Part 2 Subpart J and Part 15 Subpart A and C of the Commission's Rules and Regulations.

1.2 Description of EUT

EUT : 900MHz S.S.T. Cordless Phone
Model No. : DB-8228, DB-8232
FCC ID : BW3DB-8228
Frequency Range : Base : 902 - 928 MHz
Handset : 902 - 928 MHz
Support Channel : 20 Channel
Modulation Skill : TDMA / Spread spectrum
Security Code : 12-bit P/N code, 8-bit scramble, 16-bit 2D
Power Type : Base Powered by 120 Vac 60 Hz / 9 Vdc 800 mA
Handset powered by 3.6 V / 600 mAh.
Power Cord : Non-shielded
Data Cable : RJ-11C x 1 => Non-shielded, 7' long, Plastic hoods, No bead
Headset & MIC. => Non-shielded, 217cm long, Plastic hoods,
No bead
Applicant : DBTEL INCORPORATED
29 Tzu-Chiang Street, Tu-Cheng, Taipei Hsien,
Taiwan, R. O. C.

1.3 Description of Support Equipment

In order to construct the minimum testing, following equipment were used as the support units.

PSTN Simulator : King Design Public Switched Telephone Network Simulator
Model No. : 8705-A
Serial No. : N/A

Notebook : CER Notebook
Model No. : 386SL
Serial No. : 001855
Power Type : Linear
Power Core : Non-shielded, 6' long, Plastic hoods, No ferrite bead
FCC ID : Q8V486S

1.4 Configuration of System Under Test

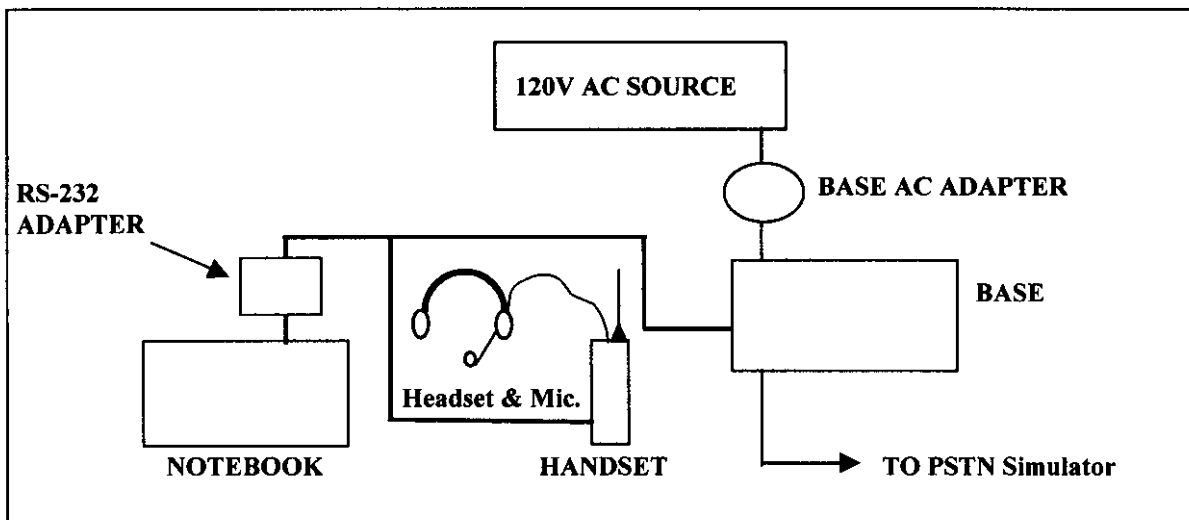

Fig. 1 Configuration of system under test

The tests below are run with the DCT transmitter set at high power in TDD mode .A serial port from a computer to the DCT UUT is needed to force selection of output power level and channel number.

The setting up procedure was recorded in Appendix A.

1.5 Verify the Frequency and Channel

1.5.1 Verify the Frequency Pairs

Channel	Base(MHz)	Handset(MHz)	Channel	Base(MHz)	Handset(MHz)
1	904.510	904.690	11	915.600	915.600
2	904.800	904.800	12	916.800	916.800
3	906.000	906.000	13	918.000	918.000
4	907.200	907.200	14	919.200	919.200
5	908.400	908.400	15	920.400	920.400
6	909.600	909.600	16	921.600	921.600
7	910.800	910.800	17	922.800	922.800
8	912.000	912.000	18	924.000	924.000
9	913.200	913.200	19	925.200	925.200
10	914.870	914.870	20	926.270	926.260

Note:

- 1.This is for sure that all frequencies are in 902 MHz to 928 MHz.
- 2.Section 15.31(m): Measurements on intentional radiators or receivers shall be performed at three frequencies for operating frequency range over 10 MHz. (The locations of these frequencies one near the top, one near the middle and one near the bottom.)
- 3.After test, the EUT operating frequencies are in 904.510 MHz to 926.270 MHz. So all the items as followed in testing report are need to test these three frequencies: top: channel 1, middle: channel 10, bottom: channel 20.

1.6 Test Procedure

All measurements contained in this report were performed mainly according to the techniques described in ANSI C63.4 (1992) and the pre-setup was written on Appendix A, the detail setup was written on each test item.

1.7 Location of the Test Site

The radiated emissions measurements required by the rules were performed on the three-meter, open-field test site maintained by *Training Research Co., Ltd.* No. 5-3, Lane 21, Yen-Chiu-Yuan Rd., Sec. 4, Taipei, Taiwan, R.O.C. Complete description and measurement data have been placed on file with the commission. The conducted power line emissions tests and other test items were performed in a shielded enclosure also located at *Training Research Co., Ltd.* 1F, No. 2, Lane 194, Huan-Ho Street, Hsichih, Taipei Hsien 221, Taiwan, R.O.C. *Training Research Co., Ltd.* is listed by the FCC as a facility available to do measurement work for others on a contract basis.

1.8 General Test Condition

The conditions under which the EUT operates were varied to determine their effect on the equipment's emission characteristics. The final configuration of the test system and the mode of operation used during these tests was chosen as that which produced the highest emission levels. However, only those conditions which the EUT was considered likely to encounter in normal use were investigated.

In test, the base and handset are tested separately. They were set in high power and continuously transmitting mode that controlled by computer. The ch01, ch10 and ch20 of base and handset were all tested. The setting up procedure is recorded on Appendix A.

II. Section 15.207: Power Line Conducted Emissions for AC Powered Units

2.1 Test Condition & Setup

The power line conducted emission measurements were performed in a shielded enclosure. The EUT was assembled on a wooden table which is 80 centimeters high, was placed 40 centimeters from the backwall and at least 1 meter from the sidewall.

Power was fed to the EUT from the public utility power grid through a line filter and EMCO Model 3825/2 Line Impedance Stabilization Networks (LISNs). The LISN housing, measuring instrumentation case, ground plane, etc., were electrically bonded together at the same RF potential. The Spectrum analyzer was connected to the AC line through an isolation transformer. The 50-ohm output of the LISN was connected to the spectrum analyzer directly. Conducted emission levels were in the CISPER quasi-peak detection mode. The analyzer's 6 dB bandwidth was set to 9 KHz. No post-detector video filter was used.

The spectrum was scanned from 450 KHz to 30 MHz. The physical arrangement of the test system and associated cabling was varied (within the scope of arrangements likely to be encountered in actual use) to determine the effect on the unit's emanations in amplitude and frequency. All spurious emission frequencies were observed. The highest emission amplitudes relative to the appropriate limit were measured and have been recorded in paragraph 2.4.

There are three test conditions apply in this test item, the test procedure description as the following :

1. Base station transmit only:

Using the RS-232 port of notebook and Rockwell software to control the base, handset.

Then making access to the mode of continuous transmission. Three channels are tested, one in the top (CH01), one in the middle (CH10) and the other in bottom (CH20).

2. Idle state (handset park, on hook mode)

The setting up procedure is recorded on Appendix A.

2.2 List of Test Instruments

Manufacturer	Device	Model	Input impedance
Hewlett Packard	100Hz-1.5GHz Spectrum Analyzer	HP8591EM	50.00
EMCO	Line Impedance Stabilization Network	3825/2	50.00
TRC	Shielded Room	TRC-SR1	N/A

2.4 Test Result of Conducted Emissions

2.4.1 Base station transmit only

The following table shows a summary of the highest emissions of power line conducted emissions on the HOT and NATURAL conductors of the EUT power cord.

Model No. : DB-8228, DB-8232
EUT : 900MHz S.S.T. Cordless Phone

Table 1 Power Line Conducted Emissions (Channel 1)

<i>Power</i>	<i>Connected</i>	<i>Emissions</i>	<i>FCC Class B</i>	
<i>Conductor</i>	<i>Frequency (KHz)</i>	<i>Peak Amplitude (dBuV)</i>	<i>Limit (dBuV)</i>	<i>Margin (dB)</i>
Line 1	464.00	39.96	48.00	-8.04
	477.00	39.67	48.00	-8.33
	489.00	39.34	48.00	-8.66
	499.00	39.29	48.00	-8.71
	527.00	38.51	48.00	-9.49
	538.00	38.43	48.00	-9.57
	556.00	37.96	48.00	-10.04
	568.00	37.81	48.00	-10.19
	593.00	36.82	48.00	-11.18
	612.00	36.56	48.00	-11.44
LINE 2	489.00	34.05	48.00	-13.95
	502.00	34.07	48.00	-13.93
	524.00	33.27	48.00	-14.73
	534.00	32.63	48.00	-15.37
	549.00	32.55	48.00	-15.45
	568.00	32.27	48.00	-15.73
	586.00	32.31	48.00	-15.69
	620.00	32.24	48.00	-15.76
	645.00	31.31	48.00	-16.69
	684.00	30.15	48.00	-17.85

NOTE:

- Margin = Peak Amplitude - Limit
- A "+" sign in the margin column means the emission is OVER the Class B Limit and "-" sign of means UNDER the Class B limit.

Table 2 Power Line Conducted Emissions (Channel 10)

<i>Power</i>	<i>Connected</i>	<i>Emissions</i>	<i>FCC</i>	<i>Class B</i>
<i>Conductor</i>	<i>Frequency (KHz)</i>	<i>Peak Amplitude (dBuV)</i>	<i>Limit (dBuV)</i>	<i>Margin (dB)</i>
Line 1	464.00	39.91	48.00	-8.09
	477.00	39.81	48.00	-8.19
	489.00	39.50	48.00	-8.50
	512.00	39.19	48.00	-8.81
	545.00	38.40	48.00	-9.60
	579.00	37.15	48.00	-10.85
	586.00	37.15	48.00	-10.85
	612.00	36.30	48.00	-11.70
	633.00	35.96	48.00	-12.04
	654.00	35.14	48.00	-12.86
LINE 2	457.00	35.50	48.00	-12.50
	483.00	34.36	48.00	-13.64
	512.00	33.81	48.00	-14.19
	527.00	32.61	48.00	-15.39
	542.00	32.64	48.00	-15.36
	575.00	32.25	48.00	-15.75
	593.00	31.08	48.00	-16.92
	615.00	32.48	48.00	-15.52
	628.00	31.21	48.00	-16.79
	650.00	31.25	48.00	-16.75

Table 3 Power Line Conducted Emissions (Channel 20)

<i>Power Conductor</i>	<i>Connected Frequency (KHz)</i>	<i>Emissions Peak Amplitude (dBuV)</i>	<i>FCC Limit (dBuV)</i>	<i>Class B Margin (dB)</i>
Line 1	461.00	39.86	48.00	-8.14
	480.00	39.43	48.00	-8.57
	489.00	39.48	48.00	-8.52
	512.00	39.03	48.00	-8.97
	521.00	38.55	48.00	-9.45
	530.00	38.51	48.00	-9.49
	549.00	38.05	48.00	-9.95
	575.00	37.63	48.00	-10.37
	604.00	36.72	48.00	-11.28
	641.00	35.56	48.00	-12.44
LINE 2	457.00	35.38	48.00	-12.62
	473.00	34.66	48.00	-13.34
	486.00	34.12	48.00	-13.88
	505.00	33.51	48.00	-14.49
	515.00	33.48	48.00	-14.52
	560.00	32.48	48.00	-15.52
	582.00	32.47	48.00	-15.53
	620.00	32.10	48.00	-15.90
	654.00	31.45	48.00	-16.55
	688.00	30.39	48.00	-17.61

Table 4 Power Line Conducted Emissions (Charge)

<i>Power</i>	<i>Connected</i>	<i>Emissions</i>	<i>FCC</i>	<i>Class B</i>
<i>Conductor</i>	<i>Frequency</i> <i>(KHz)</i>	<i>Peak Amplitude</i> <i>(dBuV)</i>	<i>Limit</i> <i>(dBuV)</i>	<i>Margin</i> <i>(dB)</i>
Line 1	452.00	40.12	48.00	-7.88
	480.00	39.74	48.00	-8.26
	496.00	39.55	48.00	-8.45
	524.00	38.73	48.00	-9.27
	542.00	38.15	48.00	-9.85
	553.00	38.12	48.00	-9.88
	571.00	37.81	48.00	-10.19
	590.00	37.42	48.00	-10.58
	604.00	36.70	48.00	-11.30
	658.00	35.63	48.00	-12.37
LINE 2	455.00	35.20	48.00	-12.80
	467.00	34.87	48.00	-13.13
	496.00	34.45	48.00	-13.55
	524.00	33.39	48.00	-14.61
	534.00	33.18	48.00	-14.82
	553.00	33.24	48.00	-14.76
	597.00	32.75	48.00	-15.25
	620.00	32.58	48.00	-15.42
	654.00	31.18	48.00	-16.82
	680.00	30.22	48.00	-17.78

Table 5 Power Line Conducted Emissions (Play)

<i>Power</i>	<i>Connected</i>	<i>Emissions</i>	<i>FCC</i>	<i>Class B</i>
<i>Conductor</i>	<i>Frequency (KHz)</i>	<i>Peak Amplitude (dBuV)</i>	<i>Limit (dBuV)</i>	<i>Margin (dB)</i>
Line 1	464.00	39.96	48.00	-8.04
	473.00	39.23	48.00	-8.77
	496.00	39.27	48.00	-8.73
	505.00	38.89	48.00	-9.11
	524.00	38.84	48.00	-9.16
	545.00	38.45	48.00	-9.55
	575.00	37.90	48.00	-10.10
	586.00	36.78	48.00	-11.22
	608.00	36.77	48.00	-11.23
	641.00	35.91	48.00	-12.09
LINE 2	457.00	35.08	48.00	-12.92
	477.00	34.22	48.00	-13.78
	515.00	32.99	48.00	-15.01
	545.00	32.55	48.00	-15.45
	556.00	32.48	48.00	-15.52
	593.00	31.97	48.00	-16.03
	608.00	31.00	48.00	-17.00
	628.00	31.39	48.00	-16.61
	645.00	30.45	48.00	-17.55
	667.00	30.25	48.00	-17.75

Table 6 Power Line Conducted Emissions (ICM)

<i>Power</i>	<i>Connected</i>	<i>Emissions</i>	<i>FCC</i>	<i>Class B</i>
<i>Conductor</i>	<i>Frequency</i> <i>(KHz)</i>	<i>Peak Amplitude</i> <i>(dBuV)</i>	<i>Limit</i> <i>(dBuV)</i>	<i>Margin</i> <i>(dB)</i>
Line 1	455.00	39.17	48.00	-8.83
	473.00	39.16	48.00	-8.84
	499.00	38.69	48.00	-9.31
	527.00	38.04	48.00	-9.96
	545.00	37.68	48.00	-10.32
	564.00	36.86	48.00	-11.14
	579.00	36.71	48.00	-11.29
	593.00	35.83	48.00	-12.17
	608.00	35.96	48.00	-12.04
645.00	35.07	48.00	-12.93	
LINE 2	455.00	34.63	48.00	-13.37
	467.00	34.77	48.00	-13.23
	499.00	33.47	48.00	-14.53
	515.00	32.91	48.00	-15.09
	530.00	32.47	48.00	-15.53
	549.00	32.55	48.00	-15.45
	601.00	32.08	48.00	-15.92
	624.00	31.37	48.00	-16.63
	680.00	29.78	48.00	-18.22
	705.00	29.61	48.00	-18.39

III. Section 15.247(a)(2): Bandwidth for Direct Sequence System.

3.1 Test Condition & Setup

The transmitter bandwidth measurements were performed in a shielded enclosure. The EUT was placed on a wooded table which is 0.8 meters height. The EUT was set to transmit continuously. Various channels were also investigated to find the maximum occupied bandwidth. The minimum 6 dB bandwidth shall be at least 500 KHz.

Make the measurement with the spectrum analyzer's resolution bandwidth (RBW) = 100 KHz. Set the span >> RBW. The detector function was set to peak and hold mode to clearly observe the components.

Setting up procedure is written on Appendix A.

3.2 Test Instruments Configuration

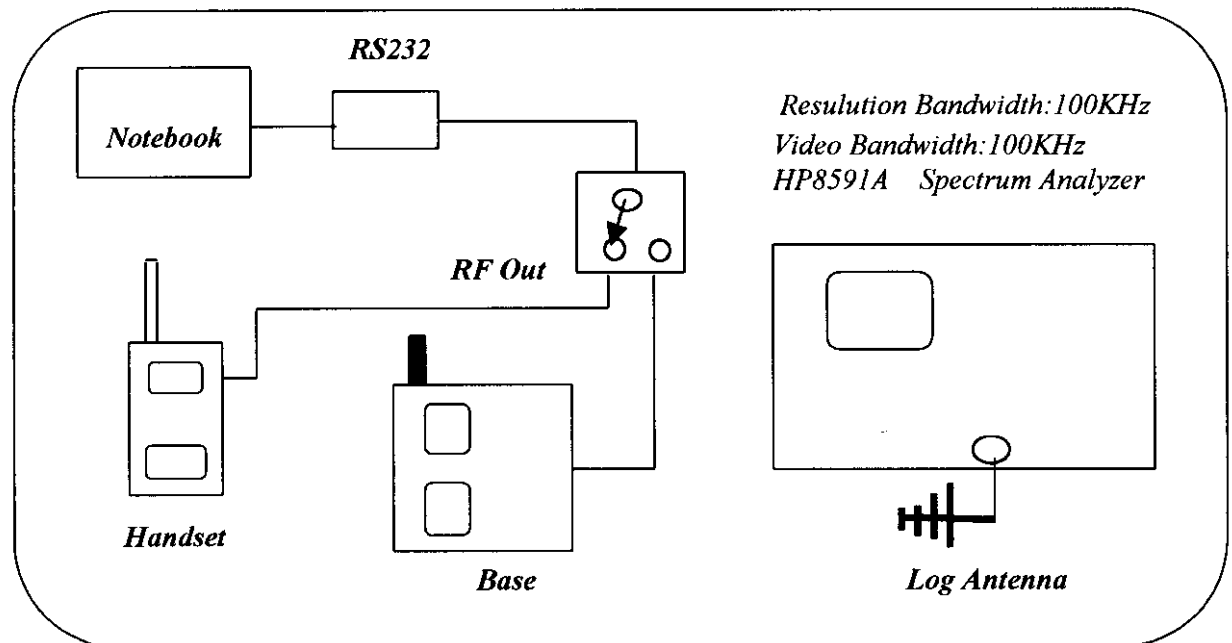

P.S.A serial port from notebook computer to control the EUT at maximal power output and channel Number.

Fig 10. Test Configuration of bandwidth for direct sequence system

3.3 List of Test Instruments

Manufacturer	Device	Model	Input Impedance
Hewlett Packard	0.9KHz – 40 GHz Spectrum Analyzer	HP8591A	50.00
EMCO	Log-Antenna	3146	50.00

3.4 Test Result of Bandwidth

Bandwidth of Channel 1

Bandwidth of Base : 1.50 MHz
Bandwidth of Handset : 1.48 MHz
The min. 6 dB BW at least : 500 KHz

Bandwidth of Channel 10

Bandwidth of Base : 1.50 MHz
Bandwidth of Handset : 1.45 MHz
The min. 6 dB BW at least : 500 KHz

Bandwidth of Channel 20

Bandwidth of Base : 1.50 MHz
Bandwidth of Handset : 1.48 MHz
The min. 6 dB BW at least : 500 KHz

Note:

1. The data in the above table are summarize the following attachment spectrum analyzer hard copy.
2. The attachment follow by this page and there is no page number.

17:11:26 MAR 31, 1999
DB_8228 B/S CH01
REF 109.0 dB μ V AT 20 dB

MKR Δ 500 kHz
-7.04 dB

PEAK
LOG
10
dB/

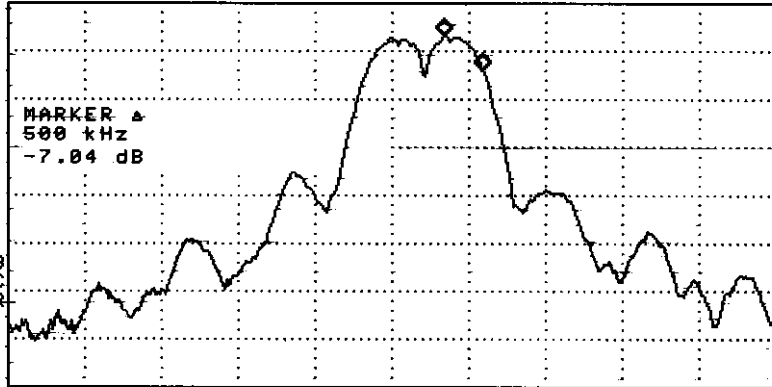

MARKER
NORMAL

MARKER
AMPTD

SELECT
1 2 3 4

MARKER 1
ON OFF

More
1 of 3

17:12:09 MAR 31, 1999
DB_8228 B/S CH01
REF 109.0 dB μ V AT 20 dB

MKR Δ -1.50 MHz
-.09 dB

PEAK
LOG
10
dB/

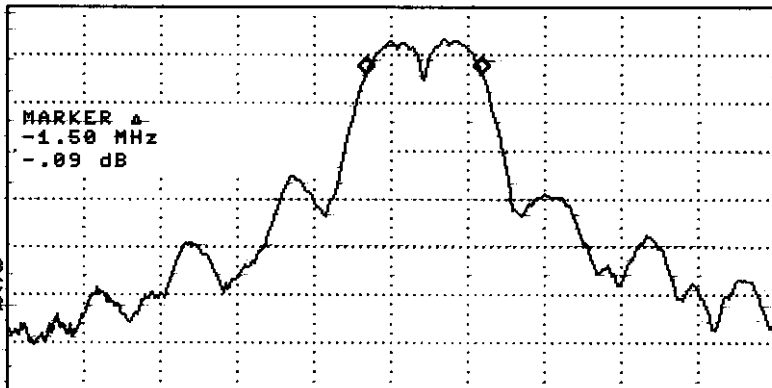

MARKER
NORMAL

MARKER
AMPTD

SELECT
1 2 3 4

MARKER 1
ON OFF

More
1 of 3

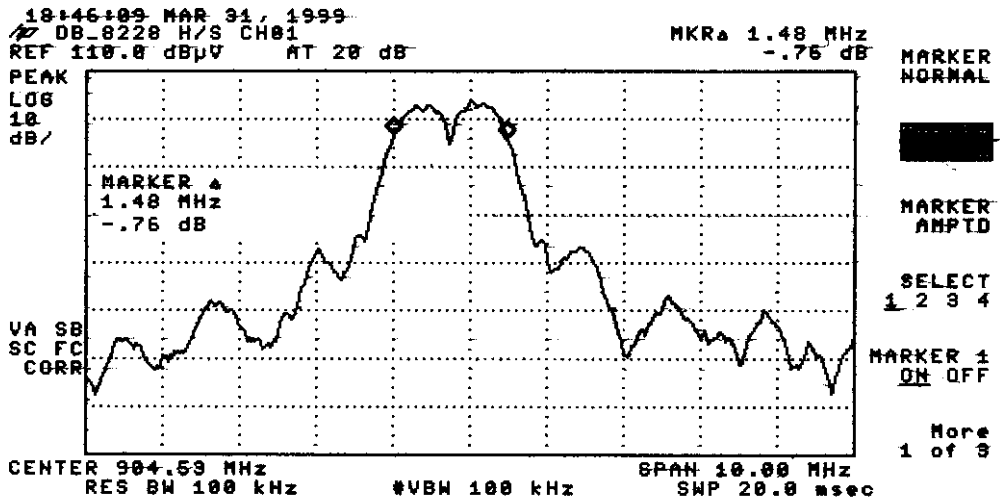
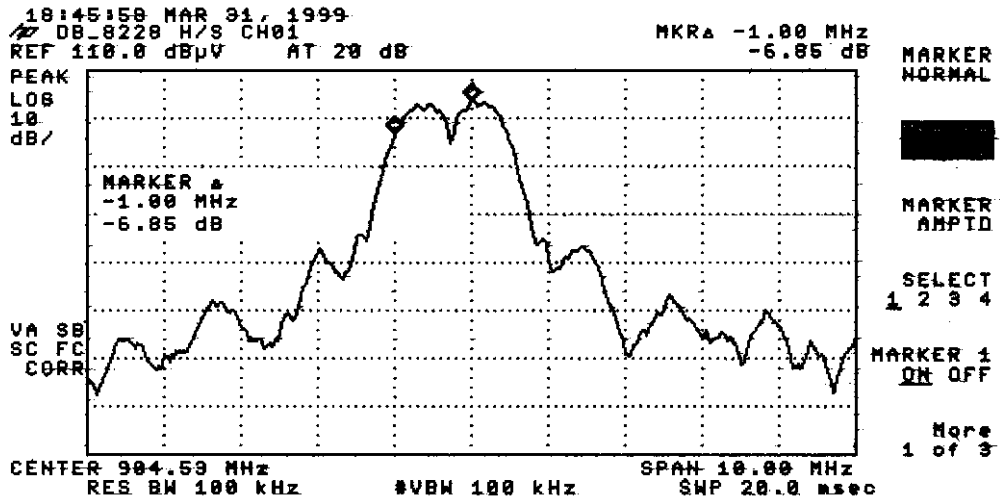

17:26:07 MAR 31, 1999
DB_8228 B/S CH10
REF 109.0 dBµV AT 20 dB

MKR Δ 330 kHz
-6.84 dB

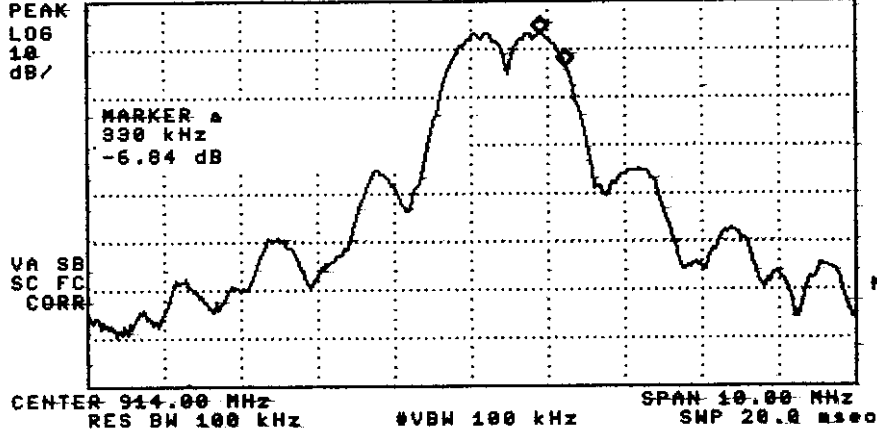

MARKER NORMAL

MARKER AMPTD

SELECT 1 2 3 4

MARKER 1 ON OFF

More 1 of 3

17:26:26 MAR 31, 1999
DB_8228 B/S CH10
REF 109.0 dBµV AT 20 dB

MKR Δ -1.50 MHz
-.25 dB

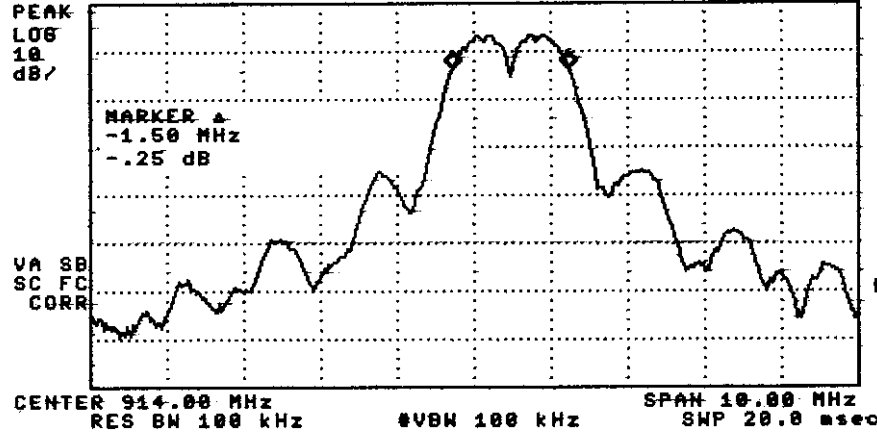

MARKER NORMAL

MARKER AMPTD

SELECT 1 2 3 4

MARKER 1 ON OFF

More 1 of 3

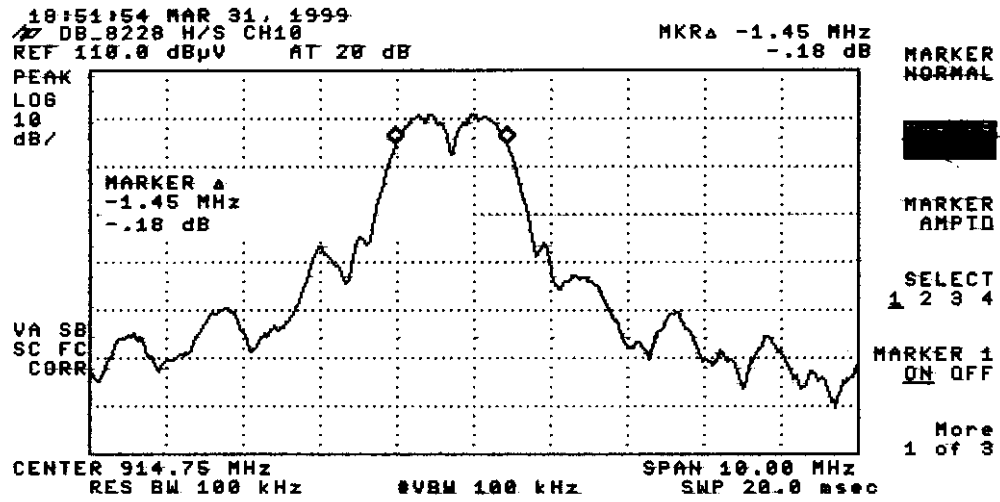
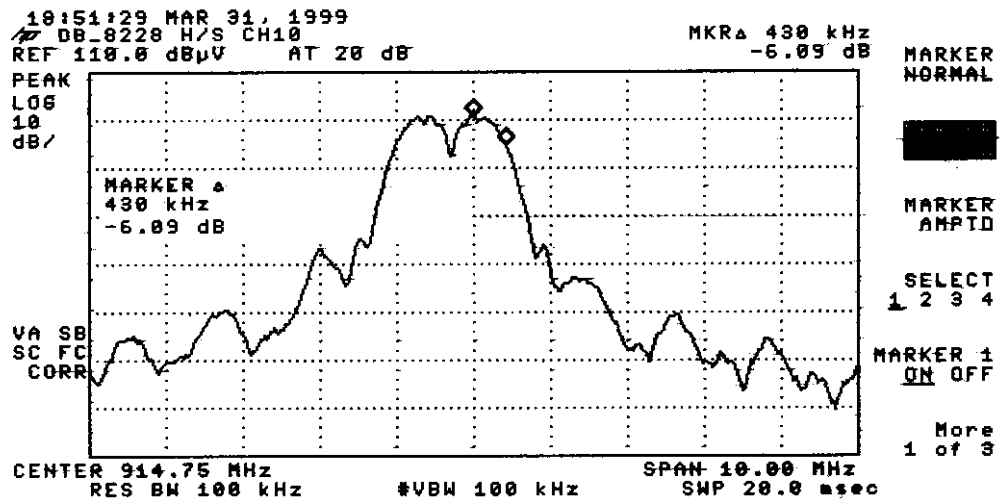

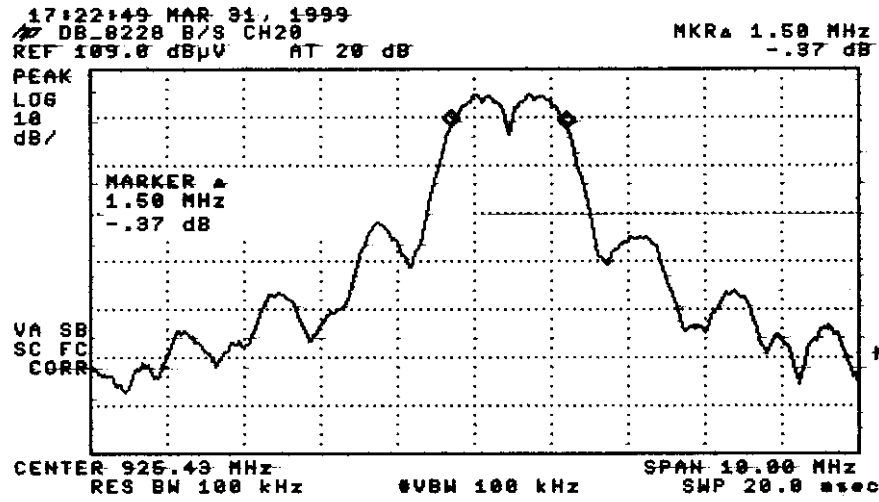
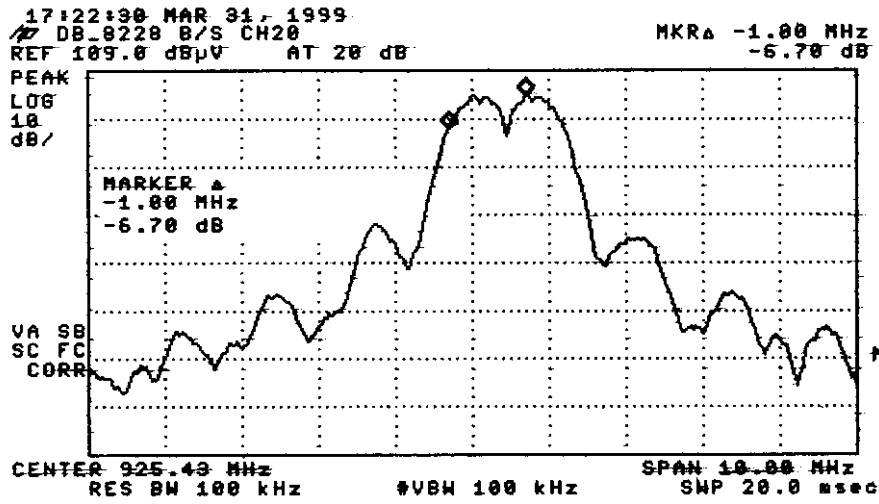

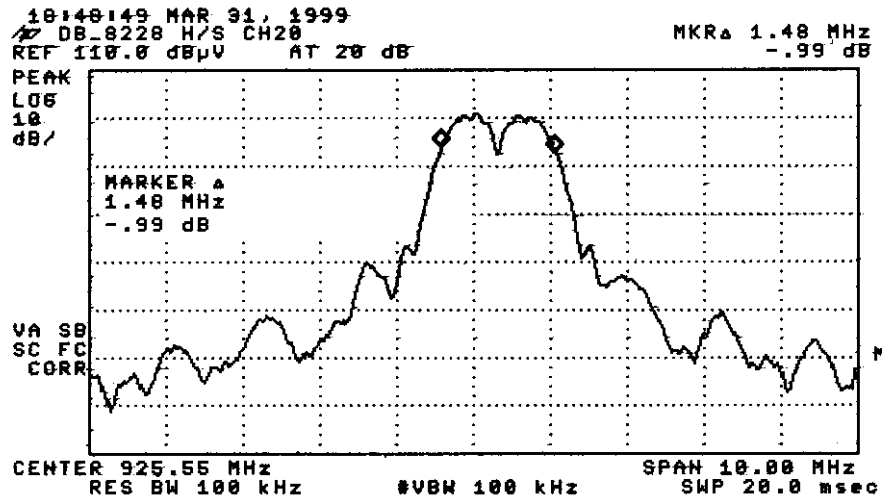
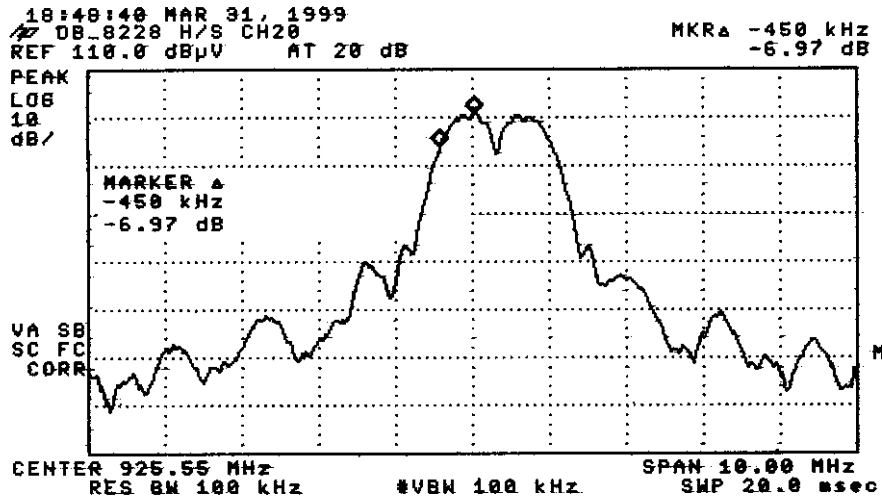

IV. Section 15.247(B) : Power Output

4.1 Test Condition & Setup

Prior to open-field testing, the EUT was placed in a shielded enclosure and scanned at a close distance to determine its emission characteristics. The physical arrangement of the EUT was varied (within the scope of arrangements likely to be encountered in actual use) to determine the effect on the unit's emanations in amplitude, directivity, and frequency. The exact system configuration which produced the highest emissions was noted so it could be reproduced later during the open-field tests. This was done to ensure that the final measurements would demonstrate the worst-case interference potential of the EUT.

Final radiation measurements were made on a three-meter, open-field test site. The EUT system was placed on a nonconductive turntable which is 0.8 meters height, top surface 1.0 x 1.5 meter.

The spectrum was examined from 30 MHz to 1000 MHz using an Hewlett Packard 8591A Spectrum Analyzer, EMCO Biconical Antenna (Model 3110) for 30 - 200 MHz, EMCO Log-Periodic Antenna (Model 3146) for 200 - 1000 MHz.

At each frequency, the EUT was rotated 360 degrees, and the antenna was raised and lowered from one to four meters to find the maximum emission levels. Measurements were taken using both horizontal and vertical antenna polarization.

Appropriate preamplifiers were used for improving sensitivity and precautions were taken to avoid overloading or desensitizing the spectrum analyzer. The spectrum analyzer HP8568b used on this testing for frequency 30MHz to 1000MHz. No post-detector video filters were used in the test. Set the RB= 3 MHz, VB = 3MHz and the span = 5 MHz. The analyzer was operated in the maximum hold mode.

There are two test condition apply in this test item, the test procedure description as the following:

(1) Base and handset station transmit only:

Using the RS-232 port of notebook and Rockwell software to control the base, handset. Then making access to the mode of continuous transmission. Three channel is tested, one in the top (CH01), one in the middle (CH10) and the other in bottom (CH20).

With the transmitter operating from a fully charged battery and using the internal antenna,

Radiates spurious emissions falling within the restricted bands of 15.209 were measured at operating frequencies corresponding to low, mid and high channels in the 902-928 MHz band.

The actual field intensity in decibels referenced to 1 microvolt per meter (dBuV/m) is determined by algebraically adding the measured reading in dBuV, the antenna factor (dB), and cable loss (dB) at the appropriate frequency.

4.2 List of Test Instruments

Manufacturer	Device	Model	Input Impedance
Hewlett Packard	100Hz-1.5GHz Spectrum Analyze	HP8568B	50.00
Hewlett Packard	50kHz-22GHz Spectrum Analyzer	HP8592B	50.00
Hewlett Packard	10KHz-1GHz Quasi-peak Adapte	HP85650A	50.00
Hewlett Packard	20Hz-2GHz RF Preselector	HP85685A	50.00
Anritsu	0.1-1200MHz Preamplifier	MH648A	50.00
EMCO	20-300MHz Biconical Antenna	3110.00	50.00
EMCO	200-1000MHz Log-Periodic Antenna	3146.00	50.00
TRC	Open Field Test Site	TRC-OFTS1	N/A
TRC	Notch Filter	N/A	50.00

4.3 Test Result of Fundamental Emissions

The peak values of fundamental emissions from the EUT at various antenna heights, antenna polarization, EUT orientation, etc. are recorded on the following.

Model No. : DB-8228, DB-8232

EUT : 900MHz S.S.T. Cordless Phone

Table 6 Open Field Fundamental Emissions

Channel	Frequency (MHz)	A.P. (H/V)	A.H. (M)	Table (degree)	Amplitude (dBuV/m)	CF (dB)	Corrected Amplitude (dBuV/m)	E.R.P.(Peak)	
								mW	dBm
Base 01	904.510	H	1.00	209	86.30	8.19	94.49	0.844	-0.739
		V	1.00	203	95.20	8.19	103.39	6.548	8.161
Base 10	914.870	H	1.00	238	87.90	8.15	96.05	1.208	0.821
		V	1.00	195	95.50	8.15	103.65	6.952	8.421
Base 20	926.270	H	1.00	99	91.60	7.82	99.42	2.625	4.191
		V	1.00	154	95.60	7.82	103.42	6.594	8.191
Handset 01	904.690	H	1.00	128	84.70	8.19	92.89	0.584	-2.339
		V	1.00	165	94.70	8.19	102.89	5.836	7.661
Handset 10	914.870	H	1.00	187	86.70	8.15	94.85	0.916	-0.379
		V	1.00	152	93.60	8.15	101.75	4.489	6.521
Handset 20	926.260	H	1.00	123	88.00	7.82	95.82	1.146	0.591
		V	1.00	237	94.20	7.82	102.02	4.777	6.791

Note:

1. A.P. means antenna polarization, horizontal and vertical.
2. A.H. means antenna height.
3. Table means turntable turning position.
4. Corrected Factor (C. F.) = Cable Loss + Antenna Factor – Amplified Gain
Corrected Amplitude = Peak Amplitude + Corrected Factor
5. Amplitude means the fundamental emission measured.
6. Effective Radiation Power (E.R.P.) = (E d) ² / 30G

E is the measured maximum field strength in V/m utilizing the maximum hold mode RBW (3MHz).

G is the numeric gain of the transmitting antenna over an isotropic radiator (1.00).

d is the distance in meters from which the field strength was measured (3M).

Example: the Max Radiation Emission of base ch01 = 94.49 dBuV/m

$$10^{(94.49/20)} \times 10^{-6} = 0.053027 \text{ V}$$

$$\text{E.R.P.} = (0.053027 \times 3)^2 / 30 = 0.844 \text{ mW} = 10 \times \log (0.844 \text{ mW}/1\text{mW}) = -0.739 \text{ dBm}$$

V. Section 15.247 (C)(2): Spurious Emissions (Radiated)

5.1 Test Condition & Setup

Prior to open-field testing, the EUT was placed in a shielded enclosure and scanned at a close distance to determine its emission characteristics. The physical arrangement of the EUT was varied (within the scope of arrangements likely to be encountered in actual use) to determine the effect on the unit's emanations in amplitude, directivity, and frequency. The exact system configuration which produced the highest emissions was noted so it could be reproduced later during the open-field tests. This was done to ensure that the final measurements would demonstrate the worst-case interference potential of the EUT.

Final radiation measurements were made on a three-meter, open-field test site. The EUT system was placed on a nonconductive turn table which is 0.8 meters height, top surface 1.0 x 1.5 meter.

The spectrum was examined from 30 MHz to 1000 MHz using an Hewlett Packard 8591A Spectrum Analyzer, EMCO Biconical Antenna (Model 3110) for 30 - 200 MHz, EMCO Log-Periodic Antenna (Model 3146) for 200 - 1000 MHz and spectrum was examined from 1 GHz to 18GHz using an Hewlett Packard 8592A Spectrum Analyzer, EMCO Horn Antenna (Model 3115) for 1 - 18 GHz.

At each frequency, the EUT was rotated 360 degrees, and the antenna was raised and lowered from one to four meters to find the maximum emission levels. Measurements were taken using both horizontal and vertical antenna polarizations.

Appropriate preamplifiers were used for improving sensitivity and precautions were taken to avoid overloading or desensitizing the spectrum analyzer. There are two spectrum analyzers use on this testing ,HP8568b for frequency 30MHz to 1000MHz, and HP8592A for frequency 1 GHz to 18 GHz. No post-detector video filters were used in the test. The spectrum analyzer's 6 dB bandwidth was set to 120 KHz (spectrum was examined from 30 MHz to 1000 MHz), the spectrum analyzer's 6 dB bandwidth was set to 1 MHz (spectrum was examined from 1 GHz to 18GHz) and the analyzer was operated in the maximum hold mode.

There are two test condition apply in this test item, the test procedure description as the following:

(1) Base and handset station transmit only:

Using the RS-232 port of notebook and Rockwell software to control the base, handset. Then making access to the mode of continuous transmission. Three channels is tested, one in the top (CH01), one in the middle (CH10) and the other in bottom (CH20).

With the transmitter operating from a fully charged battery and using the internal antenna, radiates spurious emissions falling within the restricted bands of 15.209 were measured at operating frequencies corresponding to low, mid and high channels in the 902-928 MHz band.

The actual field intensity in decibels referenced to 1 microvolt per meter (dBuV/m) is determined by algebraically adding the measured reading in dBuV, the antenna factor (dB), and cable loss (dB) at the appropriate frequency.

For frequency between 30MHz to 1000MHz

$$F_{Ia} (\text{dBuV/m}) = F_{Ir} (\text{dBuV}) + \text{Correction Factors}$$

F_{Ia} : Actual Field Intensity

F_{Ir} : Reading of the Field Intensity

$$\text{Correction Factors} = \text{Antenna Factor} + \text{Cable Loss}$$

For frequency between 1 GHz to 18 GHz

$$F_{Ia} (\text{dBuV/m}) = F_{Ir} (\text{dBuV}) + \text{Correction Factor} - \text{Duty Cycle}$$

F_{Ia} : Actual Field Intensity

F_{Ir} : Reading of the Field Intensity

$$\text{Correction Factors} = \text{Antenna Factor} + \text{Cable Loss} - \text{Distance Factor (9.54dB)} - \text{Amplifier Gain}$$

The setting up procedure is recorded on Appendix A.

5.2 List of Test Instruments

Manufacturer	Device	Model	Input Impedance
Hewlett Packard	9KHz-2.9 GHz Spectrum Analyze	HP8594EM	50.00
Hewlett Packard	50kHz-22GHz Spectrum Analyzer	HP8592A	50.00
Hewlett Packard	10KHz-1GHz Quasi-peak Adapte	HP85650A	50.00
Hewlett Packard	20Hz-2GHz RF Preselector	HP85685A	50.00
Hewlett Packard	1GHz-26.5GHz Preamplifier	HP8449B	50.00
Anritsu	0.1-1200MHz Preamplifier	MH648A	50.00
EMCO	20-300MHz Biconical Antenna	3110.00	50.00
EMCO	200-1000MHz Log-Periodic Antenna	3146.00	50.00
EMCO	1G-18GMHz Double Ridge Antenna	3115.00	50.00
TRC	Open Field Test Site	TRC-OFTS1	N/A
TRC	Notch Filter	N/A	50.00
TRC	Horn Antenna with Amplifier	TRC1	50.00

5.2.1 Duty Cycle Factor Measurement

The duty cycle factor measurement is performed in a shield enclosure. The test condition and setup is as same as paragraph III. Set the RB = 1MHz, VB=1MHz, and span = 0 MHz. Link the base and handset ,then get the Time of duty and cycle as follow page.

$$\text{The duty cycle factor} = 20 \log (T_{\text{duty}} / T_{\text{cycle}}) = 20 \log (0.9500 / 2.0000) = - 6.46$$

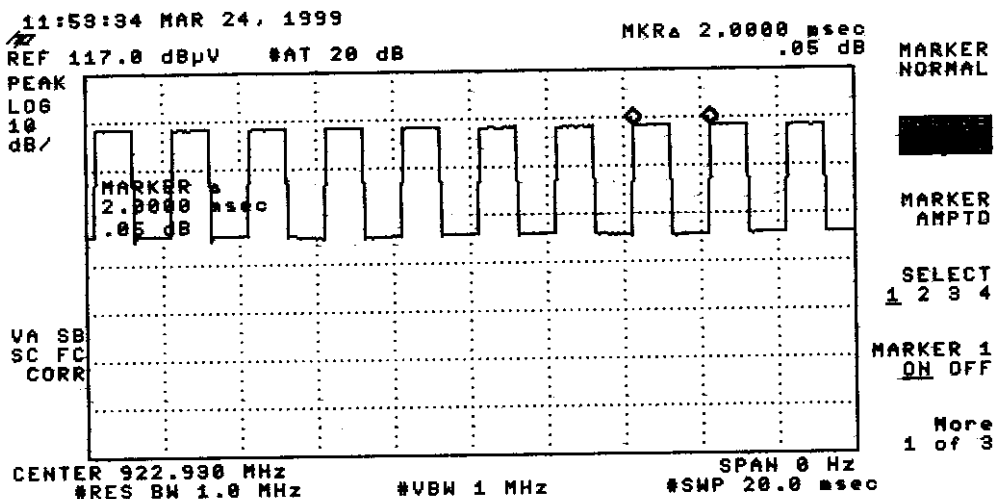
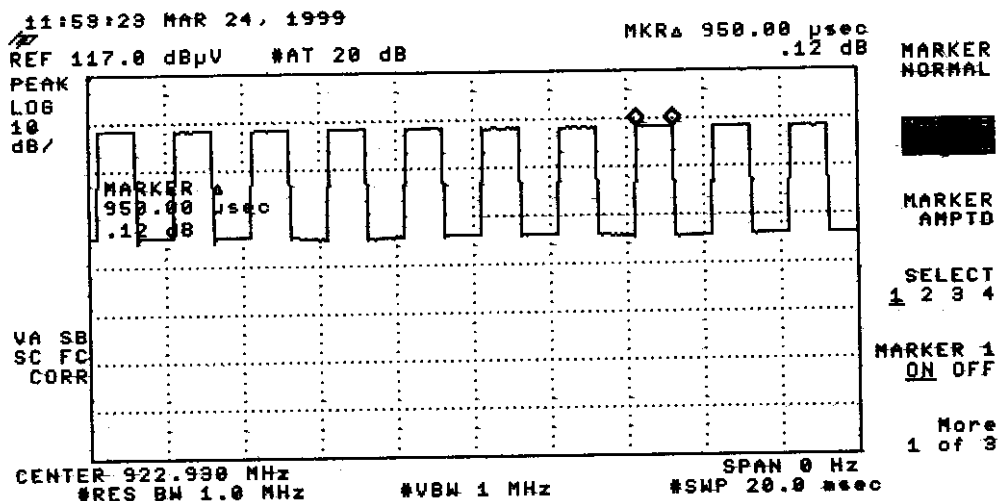

5.4 Test Result of Second Harmonic

Set the spectrum RB= 3 MHz, VB = 3MHz and span = 5MHz. The correction factors of the second harmonic is the second harmonic must lower 20 dB than the fundamental.

Model No. : DB-8228, DB-8232
EUT : 900MHz S.S.T. Cordless Phone

Table 7 Second Harmonic Attenuation

<i>Channel</i>	<i>Fundamental (MHz)</i>	<i>Fundamental (dBuV/m)</i>	<i>2nd Harmonic (GHz)</i>	<i>2nd Har. (dBuV/m)</i>	<i>Result (F/H dB)</i>	<i>Limit (dB)</i>	<i>Margin (dB)</i>
B/S CH 01	904.510	103.39	1.808	50.66	52.73	20.00	32.73
B/S CH 10	914.870	103.65	1.828	48.82	54.83	20.00	34.83
B/S CH 20	926.270	103.42	1.851	50.99	52.43	20.00	32.43
H/S CH 01	904.690	102.89	1.808	42.82	60.07	20.00	40.07
H/S CH 10	914.870	101.75	1.829	43.82	57.93	20.00	37.93
H/S CH 20	926.260	102.02	1.851	45.16	56.86	20.00	36.86

Note:

1. The data in the above table are summarize the following attachment spectrum-analyzer hard copy.
2. Result = Fundamental – 2nd Harmonic must over 20 dB.

5.5 Test Result of Spurious Radiated Emissions

5.5.1 Base and handset station transmit only

The highest peak values of radiated emissions from the EUT at various antenna heights, antenna polarizations, EUT orientation, etc. are recorded on the following.

Model No. : DB-8228, DB-8232

EUT : 900MHz S.S.T. Cordless Phone

Table 8 Open Field Radiated Emissions For 30MHz ~ 1GHz [Channel 1, Base Horizontal]

Radiated Emission				Correction Factors (dB)	Corrected Amplitude (dBuV/m)	FCC Class B (3 M)	
Frequency (MHz)	Amplitude (dBuV/m)	Ant.H. (cm)	Table (°)			Limit (dBuV/m)	Margin (dB)
326.410	44.60	1.00	195	-6.45	38.15	46.00	-7.85
336.010	45.00	1.00	109	-6.28	38.72	46.00	-7.28
345.610	43.40	1.00	167	-6.06	37.34	46.00	-8.66
355.210	44.60	1.00	152	-5.67	38.93	46.00	-7.07
364.810	46.00	1.00	165	-5.20	40.80	46.00	-5.20
374.410	49.50	4.00	337	-4.73	44.77	46.00	-1.23
384.010	46.40	1.00	38	-4.53	41.87	46.00	-4.13
393.610	47.20	1.00	148	-4.48	42.72	46.00	-3.28

Note:

1. Margin = Corrected - Limit.
2. Peak Amplitude + Correction Factors = Corrected

Table 9 Open Field Radiated Emissions For 1GHz ~ 18GHz [Channel 1, Base Horizontal]

Radiated Emission				Correction Factors (dB)	Duty Cycle (dB)	Corrected Amplitude (dBuV/m)	FCC Class B (3M)	
Frequency (GHz)	Amplitude (dBuV/m)	Ant.H. (cm)	Table (°)				Limit (dBuV/m)	Margin (dB)
2.68	49.29	100.00	125	-8.67	-6.46	34.16	54	-19.84
3.59	41.79	100.00	225	-6.84	-6.46	28.49	54	-25.51
4.50	46.04	100.00	147	3.91	-6.46	43.49	54	-10.51
5.41	27.56	100.00	254	9.72	-6.46	30.82	54	-23.18
6.31	30.90	100.00	320	9.72	-6.46	34.16	54	-19.84
7.47	27.73	100.00	205	9.72	-6.46	30.99	54	-23.01

Note:

1. Margin = Corrected - Limit.
2. Peak Amplitude + Correction Factor + Duty Cycle = Corrected

Table 10 Open Field Radiated Emissions For 30MHz ~ 1GHz [Channel 1, Base Vertical]

Radiated Emission				Correction Factors (dB)	Corrected Amplitude (dBuV/m)	FCC Class B (3 M)	
Frequency (MHz)	Amplitude (dBuV/m)	Ant.H. (cm)	Table (°)			Limit (dBuV/m)	Margin (dB)
412.810	42.00	1.00	230	-4.19	37.81	46.00	-8.19
422.410	47.10	4.00	121	-3.88	43.22	46.00	-2.78
432.010	41.50	1.00	187	-3.54	37.96	46.00	-8.04
894.620	35.60	1.00	119	8.09	43.69	46.00	-2.31
933.020	32.70	1.00	114	7.76	40.46	46.00	-5.54

Table 11 Open Field Radiated Emissions For 1GHz ~ 18GHz [Channel 1, Base Vertical]

Radiated Emission				Correction Factors (dB)	Duty Cycle (dB)	Corrected Amplitude (dBuV/m)	FCC Class B (3M)	
Frequency (GHz)	Amplitude (dBuV/m)	Ant.H. (cm)	Table (°)				Limit (dBuV/m)	Margin (dB)
2.68	57.79	100.00	41	-8.67	-6.46	42.66	54	-11.34
3.59	44.96	100.00	136	-6.84	-6.46	31.66	54	-22.34
4.50	41.54	100.00	298	3.91	-6.46	38.99	54	-15.01
5.41	30.06	100.00	226	9.72	-6.46	33.32	54	-20.68
6.31	31.56	100.00	88	9.72	-6.46	34.82	54	-19.18
7.47	29.90	100.00	164	9.72	-6.46	33.16	54	-20.84

Table 12 Open Field Radiated Emissions For 30MHz ~ 1GHz [Channel 10, Base Horizontal]

Radiated Emission				Correction Factors (dB)	Corrected Amplitude (dBuV/m)	FCC Class B (3 M)	
Frequency (MHz)	Amplitude (dBuV/m)	Ant.H. (cm)	Table (°)			Limit (dBuV/m)	Margin (dB)
326.410	44.80	1.00	108	-6.45	38.35	46.00	-7.65
336.010	46.80	1.00	215	-6.28	40.52	46.00	-5.48
345.610	44.00	1.00	124	-6.06	37.94	46.00	-8.06
355.210	43.60	1.00	35	-5.67	37.93	46.00	-8.07
364.810	45.00	1.00	25	-5.20	39.80	46.00	-6.20
374.410	44.60	1.00	19	-4.73	39.87	46.00	-6.13
384.010	45.20	1.00	30	-4.53	40.67	46.00	-5.33
393.610	48.20	1.00	151	-4.48	43.72	46.00	-2.28

Table 13 Open Field Radiated Emissions For 1GHz ~ 18GHz [Channel 10, Base Horizontal]

Radiated Emission				Correction Factors (dB)	Duty Cycle (dB)	Corrected Amplitude (dBuV/m)	FCC Class B (3M)	
Frequency (GHz)	Amplitude (dBuV/m)	Ant.H. (cm)	Table (°)				Limit (dBuV/m)	Margin (dB)
2.71	51.29	100.00	33	-6.84	-6.46	37.99	54	-16.01
3.65	41.59	100.00	105	-5.64	-6.46	29.49	54	-24.51
4.55	45.74	100.00	28	3.91	-6.46	43.19	54	-10.81
5.46	28.56	100.00	116	9.72	-6.46	31.82	54	-22.18
6.40	31.06	100.00	339	9.72	-6.46	34.32	54	-19.68

Table 14 Open Field Radiated Emissions For 30MHz ~ 1GHz [Channel 10, Base Vertical]

Radiated Emission				Correction Factors	Corrected Amplitude	FCC Class B (3 M)	
Frequency (MHz)	Amplitude (dBuV/m)	Ant.H. (cm)	Table (°)			Limit (dBuV/m)	Margin (dB)
412.810	42.10	1.00	195	-4.19	37.91	46.00	-8.09
422.410	48.60	4.00	311	-3.88	44.72	46.00	-1.28
432.010	40.30	1.00	180	-3.54	36.76	46.00	-9.24
895.220	24.60	1.00	123	8.09	32.69	46.00	-13.31
943.220	30.40	1.00	111	7.87	38.27	46.00	-7.73

Table 15 Open Field Radiated Emissions For 1GHz ~ 18GHz [Channel 10, Base Vertical]

Radiated Emission				Correction Factors (dB)	Duty Cycle (dB)	Corrected Amplitude (dBuV/m)	FCC Class B (3M)	
Frequency (GHz)	Amplitude (dBuV/m)	Ant.H. (cm)	Table (°)				Limit (dBuV/m)	Margin (dB)
2.71	53.96	100.00	33	-6.84	-6.46	40.66	54	-13.34
3.65	44.59	100.00	105	-5.64	-6.46	32.49	54	-21.51
4.55	42.04	100.00	28	3.91	-6.46	39.49	54	-14.51
5.46	31.73	100.00	116	9.72	-6.46	34.99	54	-19.01
6.40	32.40	100.00	339	9.72	-6.46	35.66	54	-18.34

Table 16 Open Field Radiated Emissions For 30MHz ~ 1GHz [Channel 20, Base Horizontal]

Radiated Emission				Correction Factors (dB)	Corrected Amplitude (dBuV/m)	FCC Class B (3 M)	
Frequency (MHz)	Amplitude (dBuV/m)	Ant.H. (cm)	Table (°)			Limit (dBuV/m)	Margin (dB)
316.810	49.50	1.00	124	-6.67	42.83	46.00	-3.17
326.410	50.10	1.00	200	-6.45	43.65	46.00	-2.35
336.010	49.90	1.00	109	-6.28	43.62	46.00	-2.38
355.210	47.20	1.00	17	-5.67	41.53	46.00	-4.47
364.810	45.00	1.00	294	-5.20	39.80	46.00	-6.20
374.410	46.20	4.00	51	-4.73	41.47	46.00	-4.53
384.010	46.70	1.00	38	-4.53	42.17	46.00	-3.83

Table 17 Open Field Radiated Emissions For 1GHz ~ 18GHz [Channel 20, Base Horizontal]

Radiated Emission				Correction Factors (dB)	Duty Cycle (dB)	Corrected Amplitude (dBuV/m)	FCC Class B (3M)	
Frequency (GHz)	Amplitude (dBuV/m)	Ant.H. (cm)	Table (°)				Limit (dBuV/m)	Margin (dB)
2.77	52.96	100.00	66	-6.84	-6.46	39.66	54	-14.34
3.67	42.76	100.00	119	-5.64	-6.46	30.66	54	-23.34
4.61	43.87	100.00	124	3.91	-6.46	41.32	54	-12.68
5.54	29.56	100.00	331	9.72	-6.46	32.82	54	-21.18
6.48	29.23	100.00	175	9.72	-6.46	32.49	54	-21.51

Table 18 Open Field Radiated Emissions For 30MHz ~ 1GHz [Channel 20, Base Vertical]

Radiated Emission				Correction Factors (dB)	Corrected Amplitude (dBuV/m)	FCC Class B (3 M)	
Frequency (MHz)	Amplitude (dBuV/m)	Ant.H. (cm)	Table (°)			Limit (dBuV/m)	Margin (dB)
412.810	42.70	1.00	232	-4.19	38.51	46.00	-7.49
422.410	42.90	4.00	311	-3.88	39.02	46.00	-6.98
432.010	41.00	1.00	180	-3.54	37.46	46.00	-8.54
508.810	42.40	1.00	124	-1.40	41.00	46.00	-5.00
954.620	33.90	4.00	101	8.01	41.91	46.00	-4.09

Table 19 Open Field Radiated Emissions For 1GHz ~ 18GHz [Channel 20, Base Vertical]

Radiated Emission				Correction Factors (dB)	Duty Cycle (dB)	Corrected Amplitude (dBuV/m)	FCC Class B (3M)	
Frequency (GHz)	Amplitude (dBuV/m)	Ant.H. (cm)	Table (°)				Limit (dBuV/m)	Margin (dB)
2.77	55.96	100.00	251	-6.84	-6.46	42.66	54	-11.34
3.67	45.59	100.00	26	-5.64	-6.46	33.49	54	-20.51
4.61	39.37	100.00	148	3.91	-6.46	36.82	54	-17.18
5.54	32.90	100.00	38	9.72	-6.46	36.16	54	-17.84
6.48	33.73	100.00	159	9.72	-6.46	36.99	54	-17.01

Table 20 Open Field Radiated Emissions For 30MHz ~ 1GHz [Channel 1, Handset Horizontal]

Radiated Emission				Correction Factors (dB)	Corrected Amplitude (dBuV/m)	FCC Class B (3 M)	
Frequency (MHz)	Amplitude (dBuV/m)	Ant.H. (cm)	Table (°)			Limit (dBuV/m)	Margin (dB)
300.680	29.90	4.00	92	-6.79	23.11	46.00	-22.89
336.010	34.40	1.00	0	-6.28	28.12	46.00	-17.88
384.010	33.30	1.00	281	-4.53	28.77	46.00	-17.23
403.210	31.50	1.00	138	-4.36	27.14	46.00	-18.86
489.610	39.00	1.00	98	-1.90	37.10	46.00	-8.90
508.810	40.40	1.00	117	-1.40	39.00	46.00	-7.00

Table 21 Open Field Radiated Emissions For 1GHz ~ 18GHz [Channel 1, Handset Horizontal]

Radiated Emission				Correction Factors (dB)	Duty Cycle (dB)	Corrected Amplitude (dBuV/m)	FCC Class B (3M)	
Frequency (GHz)	Amplitude (dBuV/m)	Ant.H. (cm)	Table (°)				Limit (dBuV/m)	Margin (dB)
2.68	61.29	100.00	334	-8.67	-6.46	46.16	54	-7.84
3.59	59.12	100.00	129	-6.84	-6.46	45.82	54	-8.18
4.50	43.87	100.00	54	3.91	-6.46	41.32	54	-12.68
5.41	36.73	100.00	171	9.72	-6.46	39.99	54	-14.01
6.31	31.56	100.00	221	9.72	-6.46	34.82	54	-19.18

Table 22 Open Field Radiated Emissions For 30MHz ~ 1GHz [Channel 1, Handset Vertical]

Radiated Emission				Correction Factors (dB)	Corrected Amplitude (dBuV/m)	FCC Class B (3 M)	
Frequency (MHz)	Amplitude (dBuV/m)	Ant.H. (cm)	Table (°)			Limit (dBuV/m)	Margin (dB)
402.210	39.90	1.00	78	-4.37	35.53	46.00	-10.47
422.410	40.70	1.00	132	-3.88	36.82	46.00	-9.18
489.610	44.30	1.00	205	-1.90	42.40	46.00	-3.60
566.410	38.30	1.00	201	0.41	38.71	46.00	-7.29
585.610	37.70	1.00	130	1.03	38.73	46.00	-7.27
894.620	35.70	1.00	86	8.09	43.79	46.00	-2.21
933.020	29.70	1.00	151	7.76	37.46	46.00	-8.54

Table 23 Open Field Radiated Emissions For 1GHz ~ 18GHz [Channel 1, Handset Vertical]

Radiated Emission				Correction Factors (dB)	Duty Cycle (dB)	Corrected Amplitude (dBuV/m)	FCC Class B (3M)	
Frequency (GHz)	Amplitude (dBuV/m)	Ant.H. (cm)	Table (°)				Limit (dBuV/m)	Margin (dB)
2.68	54.79	100.00	208	-8.67	-6.46	39.66	54	-14.34
3.59	58.62	100.00	114	-6.84	-6.46	45.32	54	-8.68
4.50	45.87	100.00	322	3.91	-6.46	43.32	54	-10.68
5.41	36.56	100.00	55	9.72	-6.46	39.82	54	-14.18
6.31	27.73	100.00	97	9.72	-6.46	30.99	54	-23.01

Table 24 Open Field Radiated Emissions For 30MHz ~ 1GHz [Channel 10, Handset Horizontal]

Radiated Emission				Correction Factors (dB)	Corrected Amplitude (dBuV/m)	FCC Class B (3 M)	
Frequency (MHz)	Amplitude (dBuV/m)	Ant.H. (cm)	Table (°)			Limit (dBuV/m)	Margin (dB)
364.740	31.80	1.00	0	-5.20	26.60	46.00	-19.40
384.010	33.60	1.00	197	-4.53	29.07	46.00	-16.93
403.210	33.30	1.00	64	-4.36	28.94	46.00	-17.06
489.610	39.50	1.00	103	-1.90	37.60	46.00	-8.40
528.010	36.10	1.00	203	-0.65	35.45	46.00	-10.55
547.210	36.70	1.00	117	-0.07	36.63	46.00	-9.37
837.610	31.20	1.00	134	6.55	37.75	46.00	-8.25

Table 25 Open Field Radiated Emissions For 1GHz ~ 18GHz [Channel 10, Handset Horizontal]

Radiated Emission				Correction Factors (dB)	Duty Cycle (dB)	Corrected Amplitude (dBuV/m)	FCC Class B (3M)	
Frequency (GHz)	Amplitude (dBuV/m)	Ant.H. (cm)	Table (°)				Limit (dBuV/m)	Margin (dB)
2.71	56.79	100.00	330	-6.84	-6.46	43.49	54	-10.51
3.65	57.76	100.00	205	-5.64	-6.46	45.66	54	-8.34
4.55	39.71	100.00	115	3.91	-6.46	37.16	54	-16.84
5.46	34.73	100.00	107	9.72	-6.46	37.99	54	-16.01
6.37	30.73	100.00	291	9.72	-6.46	33.99	54	-20.01

Table 26 Open Field Radiated Emissions For 30MHz ~ 1GHz [Channel 10, Handset Vertical]

Radiated Emission				Correction Factors (dB)	Corrected Amplitude (dBuV/m)	FCC Class B (3 M)	
Frequency (MHz)	Amplitude (dBuV/m)	Ant. H. (cm)	Table (°)			Limit (dBuV/m)	Margin (dB)
403.210	38.90	1.00	161	-4.36	34.54	46.00	-11.46
422.410	39.00	1.00	226	-3.88	35.12	46.00	-10.88
441.610	39.20	1.00	249	-3.27	35.93	46.00	-10.07
508.810	40.60	1.00	117	-1.40	39.20	46.00	-6.80
895.220	31.30	1.00	160	8.09	39.39	46.00	-6.61

Table 27 Open Field Radiated Emissions For 1GHz ~ 18GHz [Channel 10, Handset Vertical]

Radiated Emission				Correction Factors (dB)	Duty Cycle (dB)	Corrected Amplitude (dBuV/m)	FCC Class B (3M)	
Frequency (GHz)	Amplitude (dBuV/m)	Ant.H. (cm)	Table (°)				Limit (dBuV/m)	Margin (dB)
2.71	49.46	100.00	110	-6.84	-6.46	36.16	54	-17.84
3.65	57.76	100.00	22	-5.64	-6.46	45.66	54	-8.34
4.55	46.04	100.00	258	3.91	-6.46	43.49	54	-10.51
5.46	33.90	100.00	320	9.72	-6.46	37.16	54	-16.84
6.37	27.73	100.00	48	9.72	-6.46	30.99	54	-23.01

Table 28 Open Field Radiated Emissions For 30MHz ~ 1GHz [Channel 20, Handset Horizontal]

Radiated Emission				Correction Factors (dB)	Corrected Amplitude (dBuV/m)	FCC Class B (3 M)	
Frequency (MHz)	Amplitude (dBuV/m)	Ant.H. (cm)	Table (°)			Limit (dBuV/m)	Margin (dB)
193.540	29.70	1.00	103	-12.33	17.37	43.50	-26.13
201.600	43.20	4.00	268	-12.14	31.06	43.50	-12.44
204.600	31.80	1.00	3	-12.02	19.78	43.50	-23.72
836.730	21.10	1.00	193	6.52	27.62	46.00	-18.38

Table 29 Open Field Radiated Emissions For 1GHz ~ 18GHz [Channel 20, Handset Horizontal]

Radiated Emission				Correction Factors (dB)	Duty Cycle (dB)	Corrected Amplitude (dBuV/m)	FCC Class B (3 M)	
Frequency (GHz)	Amplitude (dBuV/m)	Ant.H. (cm)	Table (°)				Limit (dBuV/m)	Margin (dB)
2.77	57.12	100.00	339	-6.84	-6.46	43.82	54	-10.18
3.67	55.92	100.00	47	-5.64	-6.46	43.82	54	-10.18
4.61	41.54	100.00	219	3.91	-6.46	38.99	54	-15.01
5.54	35.06	100.00	34	9.72	-6.46	38.32	54	-15.68
6.48	30.23	100.00	227	9.72	-6.46	33.49	54	-20.51

Table 30 Open Field Radiated Emissions For 30MHz ~ 1GHz [Channel 20, Handset Vertical]

Radiated Emission				Correction Factors (dB)	Corrected Amplitude (dBuV/m)	FCC Class B (3 M)	
Frequency (MHz)	Amplitude (dBuV/m)	Ant.H. (cm)	Table (°)			Limit (dBuV/m)	Margin (dB)
364.810	41.40	1.00	122	-5.20	36.20	46.00	-9.80
384.010	40.60	1.00	180	-4.53	36.07	46.00	-9.93
422.410	39.20	1.00	83	-3.88	35.32	46.00	-10.68
518.410	33.70	1.00	199	-0.91	32.79	46.00	-13.21
585.610	37.50	1.00	131	1.03	38.53	46.00	-7.47
887.430	23.40	1.00	117	7.97	31.37	46.00	-14.63
935.420	36.70	1.00	85	7.80	44.50	46.00	-1.50
954.620	30.40	1.00	92	8.01	38.41	46.00	-7.59

Table 31 Open Field Radiated Emissions For 1GHz ~ 18GHz [Channel 20, Handset Vertical]

Radiated Emission				Correction Factors (dB)	Duty Cycle (dB)	Corrected Amplitude (dBuV/m)	FCC Class B (3M)	
Frequency (GHz)	Amplitude (dBuV/m)	Ant.H. (cm)	Table (°)				Limit (dBuV/m)	Margin (dB)
2.77	52.12	100.00	339	-6.84	-6.46	38.82	54	-15.18
3.67	53.76	100.00	47	-5.64	-6.46	41.66	54	-12.34
4.61	40.87	100.00	219	3.91	-6.46	38.32	54	-15.68
5.54	34.56	100.00	34	9.72	-6.46	37.82	54	-16.18
6.48	27.90	100.00	227	9.72	-6.46	31.16	54	-22.84

Table 32 Open Field Radiated Emissions For 30MHz ~ 1GHz [ICM Horizontal]

Radiated Emission				Correction Factors (dB)	Corrected Amplitude (dBuV/m)	FCC Class B (3 M)	
Frequency (MHz)	Amplitude (dBuV/m)	Ant. H. (cm)	Table (°)			Limit (dBuV/m)	Margin (dB)
364.810	44.00	1.00	205	-5.20	38.80	46.00	-7.20
374.410	46.30	4.00	62	-4.73	41.57	46.00	-4.43
384.010	44.30	1.00	211	-4.53	39.77	46.00	-6.23
393.610	45.90	1.00	124	-4.48	41.42	46.00	-4.58
403.210	44.50	1.00	194	-4.36	40.14	46.00	-5.86
412.810	44.40	1.00	122	-4.19	40.21	46.00	-5.79
489.610	34.20	1.00	50	-1.90	32.30	46.00	-13.70

Table 33 Open Field Radiated Emissions For 30MHz ~ 1GHz [ICM Vertical]

Radiated Emission				Correction Factors (dB)	Corrected Amplitude (dBuV/m)	FCC Class B (3 M)	
Frequency (MHz)	Amplitude (dBuV/m)	Ant.H. (cm)	Table (°)			Limit (dBuV/m)	Margin (dB)
393.610	46.10	1.00	73	-4.48	41.62	46.00	-4.38
412.810	44.40	1.00	232	-4.19	40.21	46.00	-5.79
422.410	46.68	4.00	323	-3.88	42.80	46.00	-3.20
432.010	42.80	1.00	286	-3.54	39.26	46.00	-6.74
489.610	40.00	1.00	60	-1.90	38.10	46.00	-7.90
508.810	39.00	1.00	253	-1.40	37.60	46.00	-8.40
528.010	36.80	1.00	70	-0.65	36.15	46.00	-9.85

VI. Section 15.247(d): Power Spectral Density

6.1 Test Condition & Setup

The tests below are running with the DCT transmitter set at high power in TDD mode. A serial port from a computer to the DCT UUT is needed to force selection of output power level and channel number. While testing, EUT was set to transmit continuously. A log antenna was connected with the spectrum analyzer.

The EUT is tested in open field site. Put EUT on the middle of a wooden table. Set spectrum analyzer RBW = 3 KHz, VBW > RBW (e.g. VBW = 10 KHz), Span = 1.5 MHz. Turn around the table to find maximum emission. Then set the Span = 300 KHz and sweep time = 100 sec. Peak the maximum emission again. The peak level measured must be no greater than + 8 dBm.

The setting up procedure is recorded on Appendix A.

6.2 Test Instruments Configuration

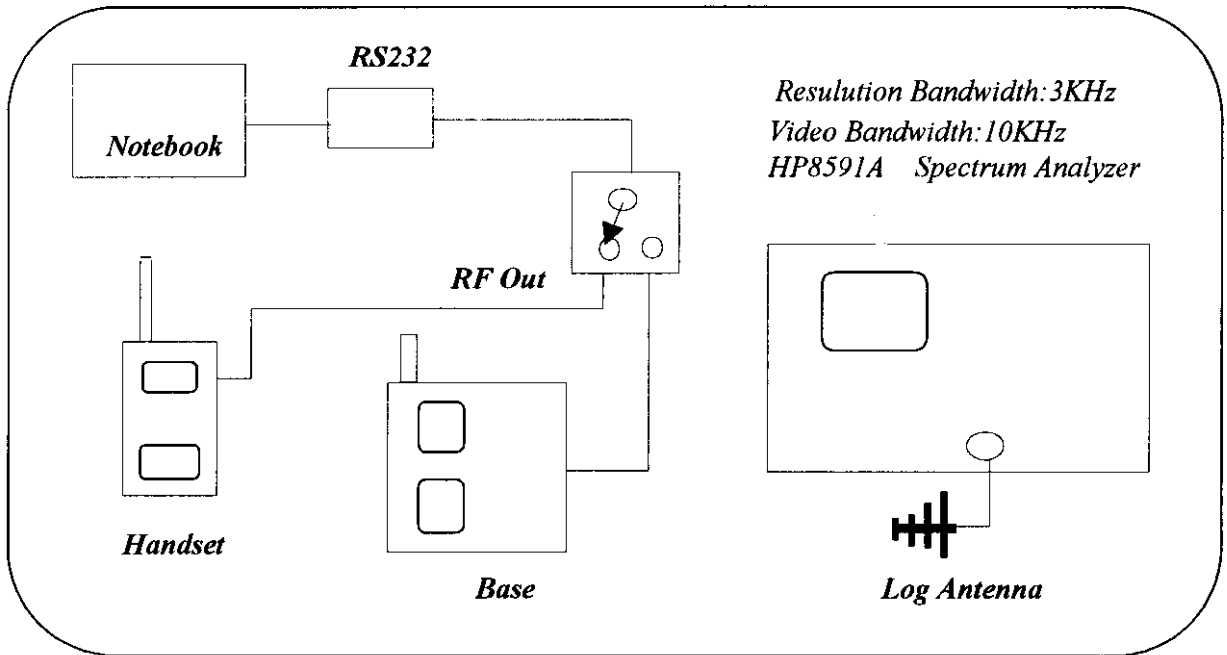

P.S.A serial port from notebook computer to control the EUT at maximal power output and channel Number.

Fig 12. Test Configuration of power spectral density

6.3 List of Test Instruments

Manufacturer	Device	Model	Input Impedance
Hewlett Packard	9KHz-2.9 GHz Spectrum Analyze	HP8594EM	50.00

6.4 Required of Carrier frequency

If any 100 kHz bandwidth outside these frequency bands, the radio frequency power that is produced by the modulation products of the spreading sequence, the information sequence and the carrier frequency shall be either at least 20 dB below that in any 100 kHz bandwidth within the band that contains the highest level of the desired power or shall not exceed the general levels specified in § 15.209(a), whichever results in the lesser attenuation.

Test Condition & Setup: same as 3.1

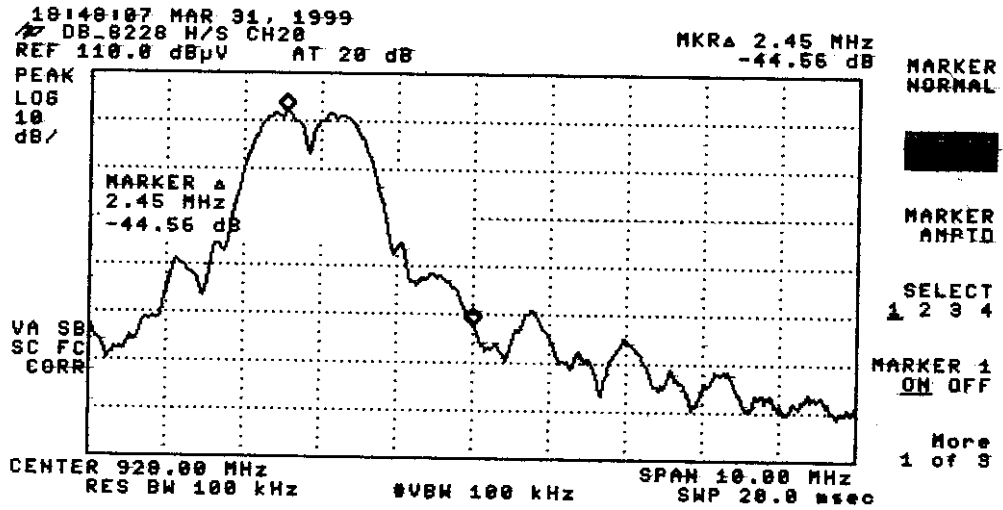
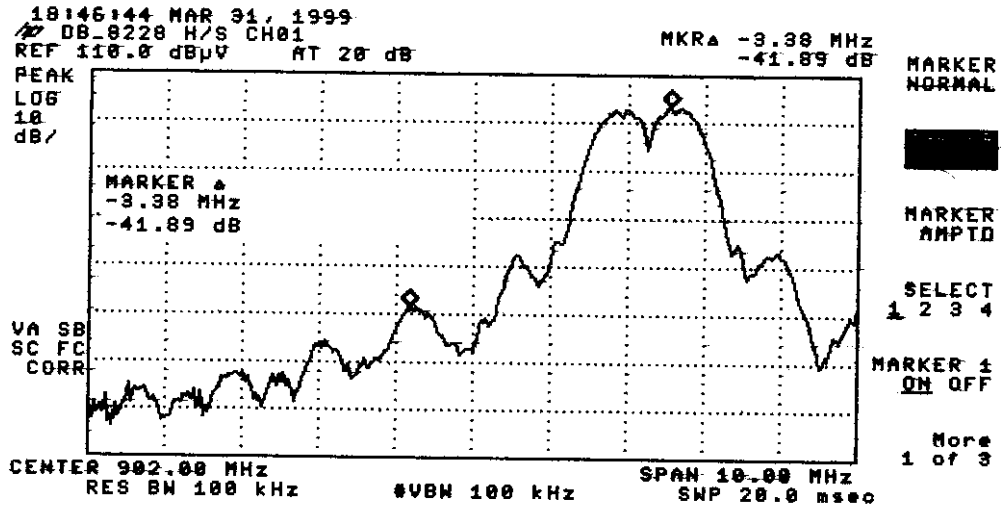

17:17:26 MAR 31, 1999
DB_8228 B/S CH01
REF 109.0 dBµV AT 20 dB

MKRΔ -3.33 MHz
-42.29 dB

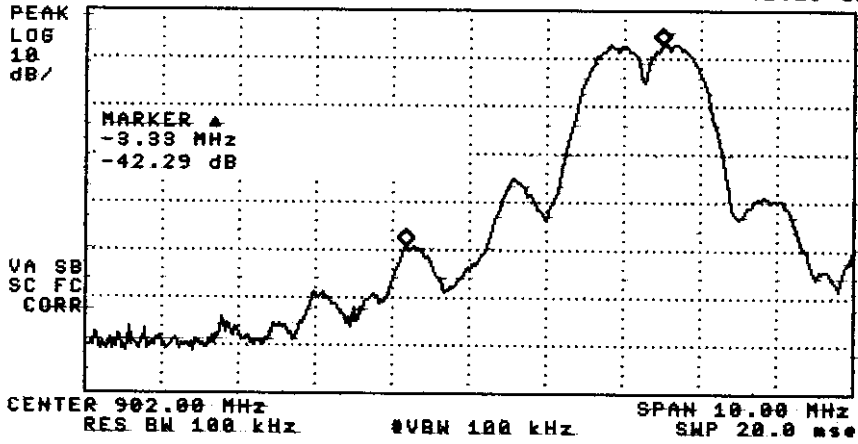

MARKER NORMAL

MARKER AMPIQ

SELECT 1 2 3 4

MARKER 1 ON OFF

More 1 of 3

17:20:33 MAR 31, 1999
DB_8228 B/S CH20
REF 109.0 dBµV AT 20 dB

MKRΔ 1.88 MHz
-41.78 dB

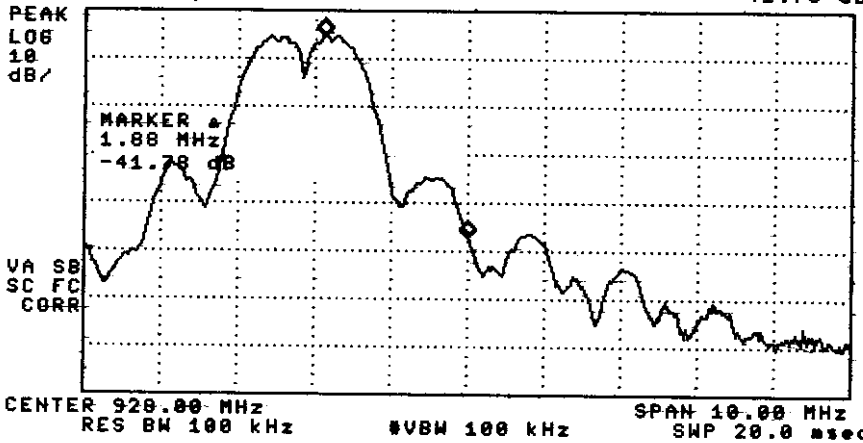

MARKER NORMAL

MARKER AMPIQ

SELECT 1 2 3 4

MARKER 1 ON OFF

More 1 of 3

6.5 Test Result of Power spectral density.

The following table shows a summary of the highest power out of UT.

Model No. : DB-8228, DB-8232
EUT : 900MHz S.S.T. Cordless Phone

Table 34 Power Spectral Density

<i>Channel</i>	<i>Frequency (MHz)</i>	<i>Ppr (dBuV)</i>	<i>CF (dB)</i>	<i>Ppq (dBm)</i>	<i>Limit (dB)</i>	<i>Margin (dB)</i>
B/S CH 01	904.667	88.50	8.19	1.461	8.00	-6.539
B/S CH 10	914.868	88.30	8.15	1.221	8.00	-6.779
B/S CH 20	926.268	88.10	7.82	0.691	8.00	-7.309
H/S CH 01	904.667	88.30	8.19	1.261	8.00	-6.739
H/S CH 10	914.867	88.10	8.15	1.021	8.00	-6.979
H/S CH 20	926.266	88.40	7.82	0.991	8.00	-7.009

Note:

1. The attachment follow by this page and there is no page number.
2. Ppr: spectrum read power density (using peak search mode), CF: correct factor, Ppq: actual peak power density in the spread spectrum band.
3. Ppq = Ppr + CF
4. Effective Radiation Power (E.R.P.) = (E d)² / 30G

E is the measured maximum field strength in V/m utilizing the maximum hold mode RBW (3KHz).

G is the numeric gain of the transmitting antenna over an isotropic radiator (1.00).

d is the distance in meters from which the field strength was measured (3M).

Example: the Max Radiation Emission of base ch01 = 88.50 + 8.19 = 96.69 dBuV/m

$$10^{(96.69/20)} \times 10^{-6} = 0.06831 \text{ V}$$

$$\begin{aligned} \text{E.R.P.} &= (0.06831 \times 3)^2 / 30 = 1.399 \text{ mW} = 10 \times \log (1.399 \text{ mW}/1\text{mW}) \\ &= 1.461 \text{ dBm} \end{aligned}$$

Connector Pane

53-1



900Mza.vi

Front Panel

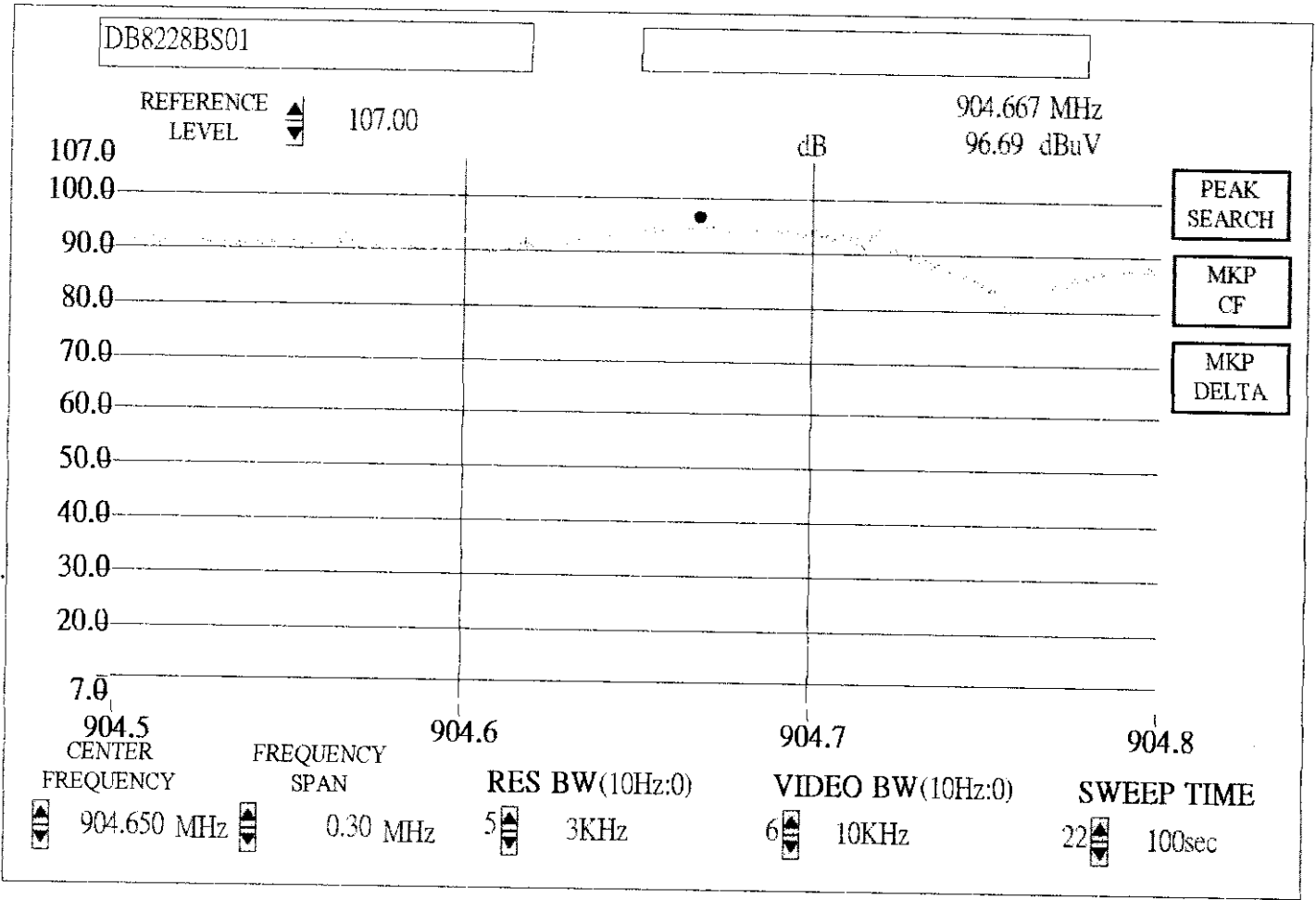



Connector Pane



900Mza.vi

Front Panel

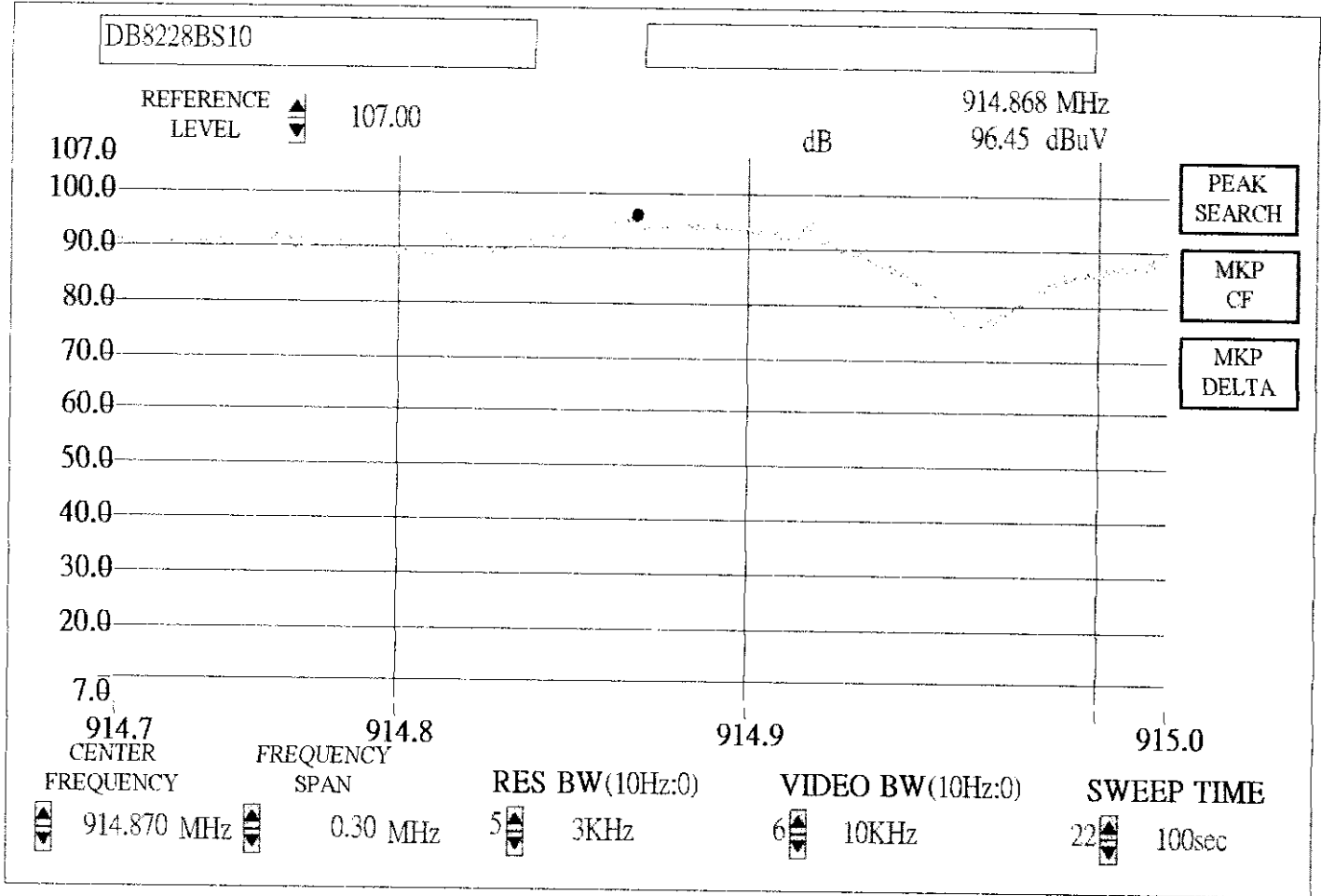

Connector Pane



900Mza.vi

Front Panel

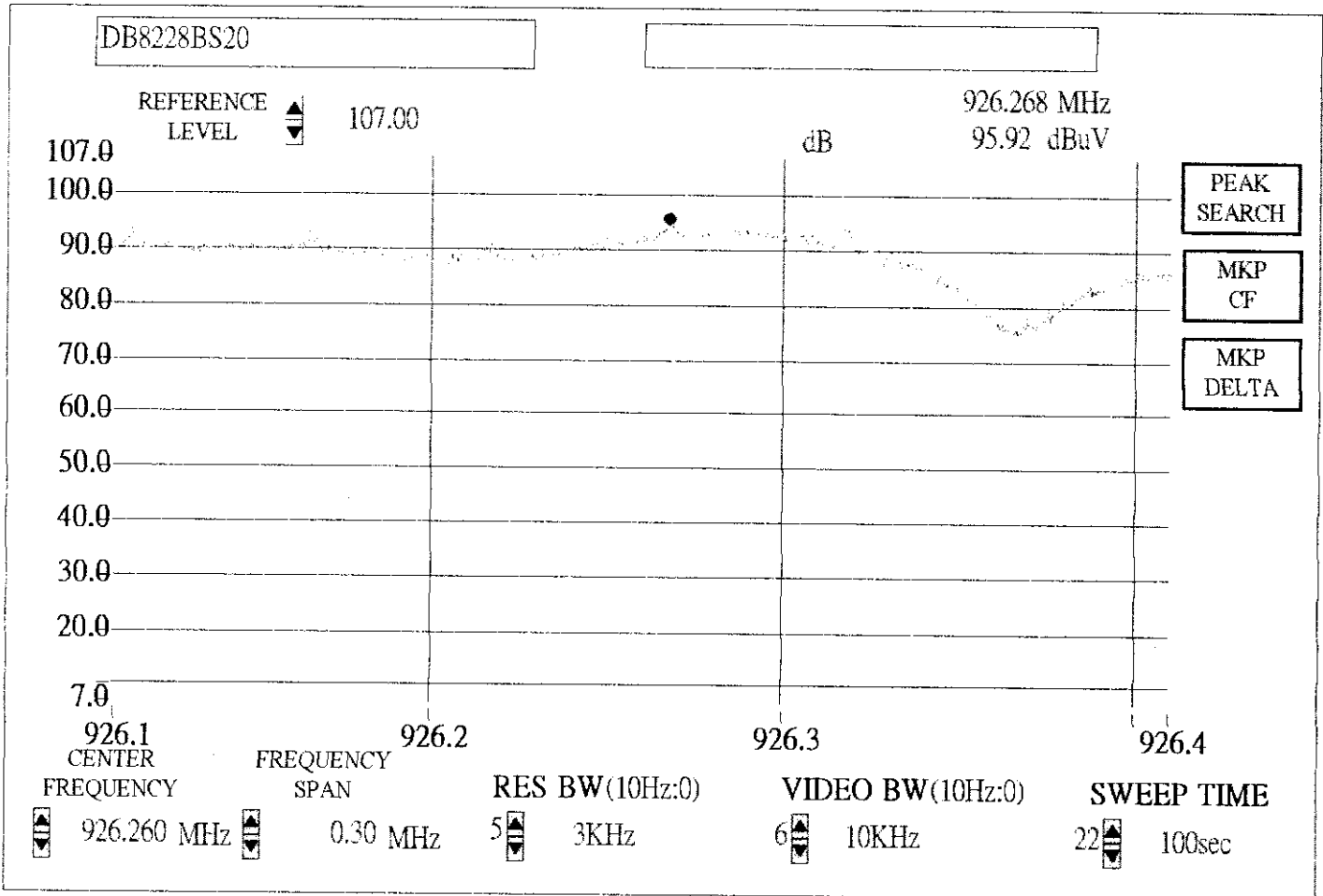



Connector Pane



900Mza.vi

Front Panel

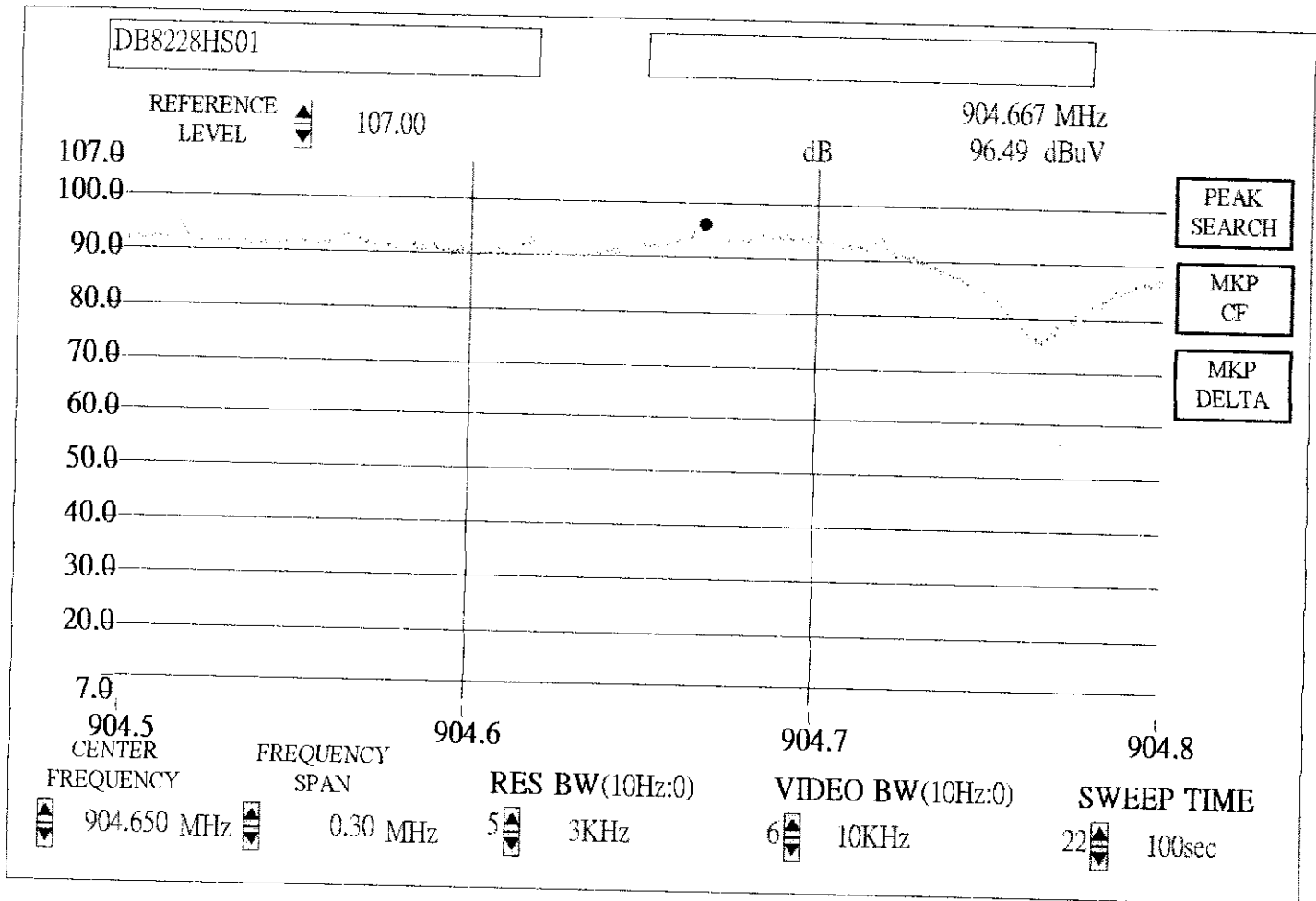



Connector Pane



900MZa.vi

Front Panel

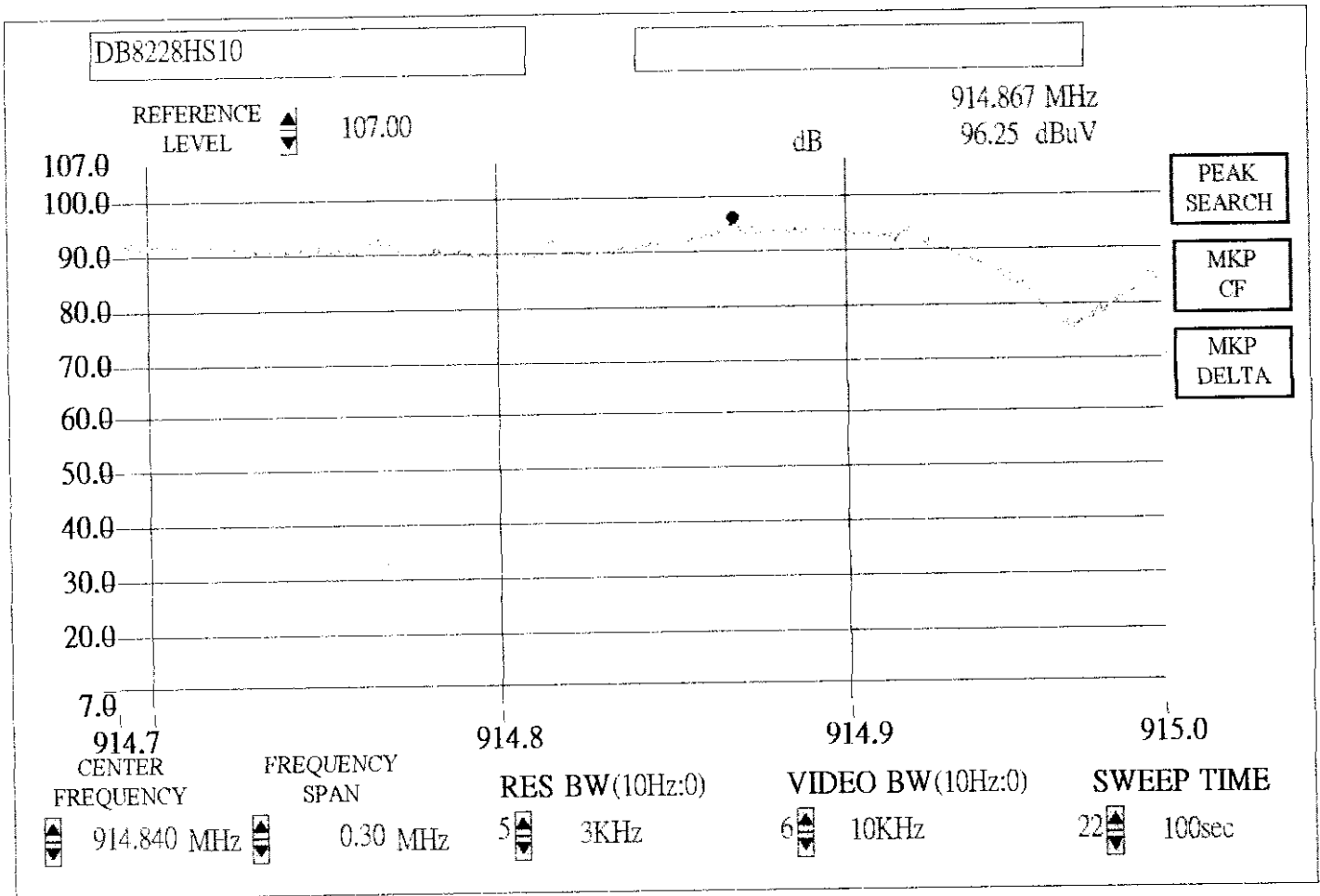

Connector Pane



900MZa.vi

Front Panel

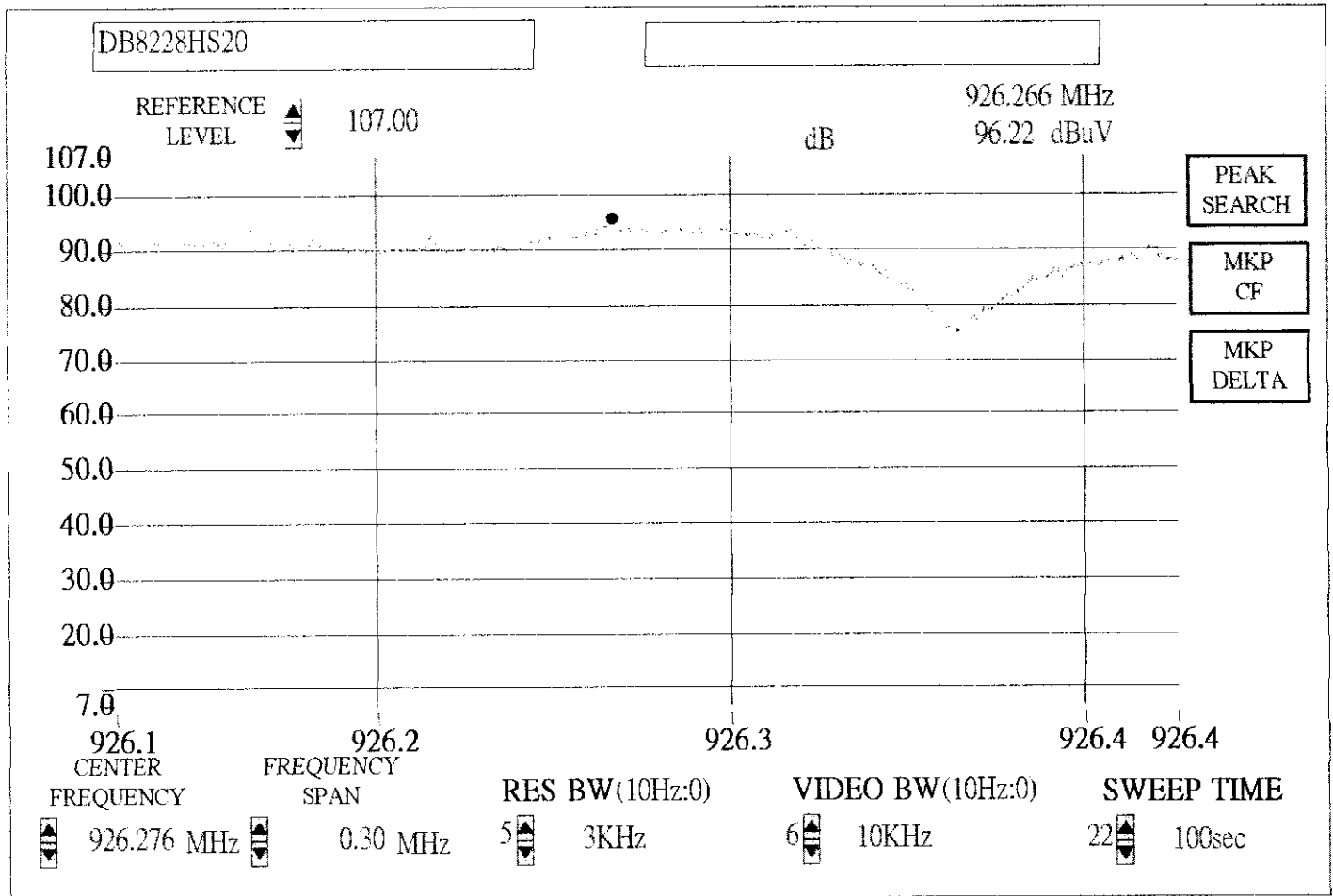

VII. Section 15.247(e): Processing Gain

7.1 Test Condition & Setup

A. Bit Error Rate (Pe)

The subjective device RF module (base & handset) digital modulation by Differential Phase -Shift Keying (DPSK), the DPSK can use it's previous waveform as the phase reference for demodulation and thus requires no coherent detection, which greatly simplifies the receiver structure but with some Bit Error Rate (BER) degradation because of noisy phase reference. There is tradeoff between system complexity and system performance. In order to driver the DPSK error probability , we observe that DPSK using differential coding , we observable that DPSK using different coding is essentially an orthogonal signal scheme. A binary 1 is transmitted a sequence of two pulse (P,P) or (-P,-P) over 2 To seconds (no transition). Similarly, a binary 0 is transmitted by a sequence of two plus (P,-P) or (-P,P) over 2 TO seconds (transition). Either of the pulse sequences used for binary 1 is orthogonal to either of the pulse sequences used for binary 0. Because no local carrier is generated for demodulation, the detection is noncoherent , with an effective pulse energy equal to 2 Ep (twice the energy of pulse P). The actual energy transmitted per digit only Ep, however, the same as in noncoherent FSK, Consequently, the performance of DPSK is 3 dB superior to that of noncoherent FSK, We can write Pe for DPSK as :

The major component inside the subjective device are supplied by Rock well , Included RF block transmitter (RF101), Receiver (RF 100), and Base band block ASIC (c8502-13), CODEC (10497-14), above 4 IC chips are affected the processing gain as following :

$$J/S = (W/RD) / (ED/NO) \text{ [without CODING]}$$

Where: W= Spread Chip Rate = Required Transmitted Base band Bandwidth.

Rb = Information Data Rate

Eb/No = Require Energy per Bit over noise Spectral Density for a Specific Bit Error Probability.

The subjective Device Information Data Rate are 80k and the Spread Chip Rate are 960k So the processing gain ($10 \log w/Rb$) at least 10.79 dB(without Coding).

The ASIC (c8502-13) and CODEC (10497-14) these two chip included the coding function, So, it is great improve the processing gain and also improve the J/S ratio.

The Engineer work for Rock well System in Taiwan had pass us the information about the probability of error rate (Pe) must be lower than 0.001 that the system performance will satisfy for communication between Handset and Base station.

Why we need the Pe lower than 0.001, the Rockwell Semiconductor System is not explained , Since it relative with ASIC and Codec, it is confidential area that Rockwell is not allow to disdouse to the public.

When Pe = 0.001 and then Signal to Noise Ratio (S/N) = 6.2194 = 7.9dB.

B. Jamming Margin Method

The Rockwell Semiconductor System give us a software operated in the personal computer, and use the computer series port COM1 and COM2 connect Handset and Base than we can measure the Bit Error Rate.

Using this software we can perform Jamming Margin method testing, The test consists of stepping a signal generator in 50 KHz increments across the pass band of the system (up to 960 KHz away in RI's DCT). At each point, the generator level required to produce the recommend Bit Error Rate ($BER = 10e - 3$) is recorded. This level is the jamming level. The maximum implementation loss a system can claim in calculating processing gain is 2 dB. The equation to calculate the processing gain (Gp) is the following:

$$Gp = (S/N) + Mj + Lsys$$

$$Gp = 8 \text{ dB} + Mj + 2 \text{ dB}$$

FCC regulation section 15.247 (e) require the processing gain of a direct sequence system shall be at least 10 dB, when Gp must be greater than 10 dB, then the Jammer must be greater than 0 dB.

The processing gain may be measured using the CW jamming margin method. The Jammer to Signal (J/S) ratio is then calculated. Discard the worst 20% of the J/S data points.

1. For avoid the handset and basestation are situation, so, the UUT were in low power mode.
2. The signal generator was selected in interference band, using this software we can perform Jamming Margin method testing, the test consists of stepping a signal generator is 50 KHz increments across the pass band of the system (up to 960 KHz away in RI's DCT). So, the BER will keep in 0.1%.

The setting up procedure is recorded on Appendix A.

7.2 Test Instruments Configuration

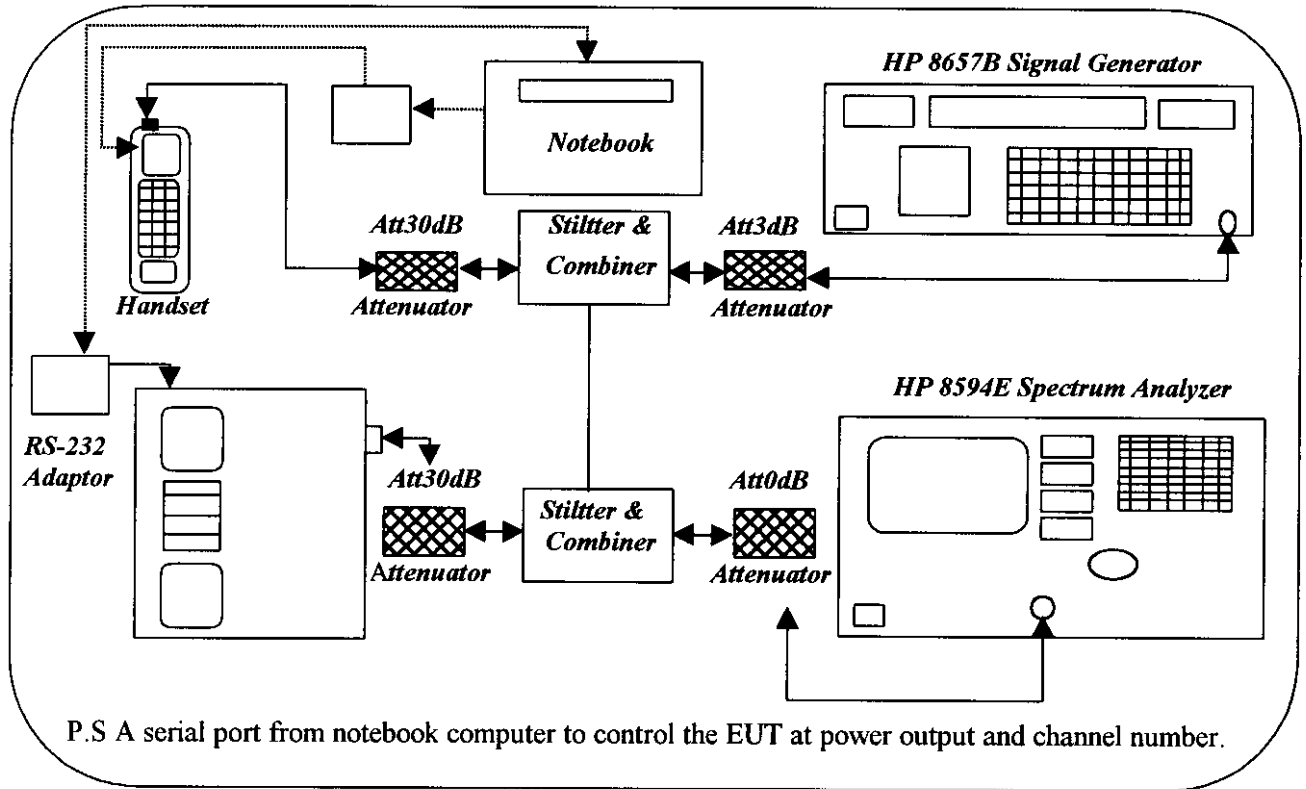

Fig. 13. Test Configuration of processing gain for base station

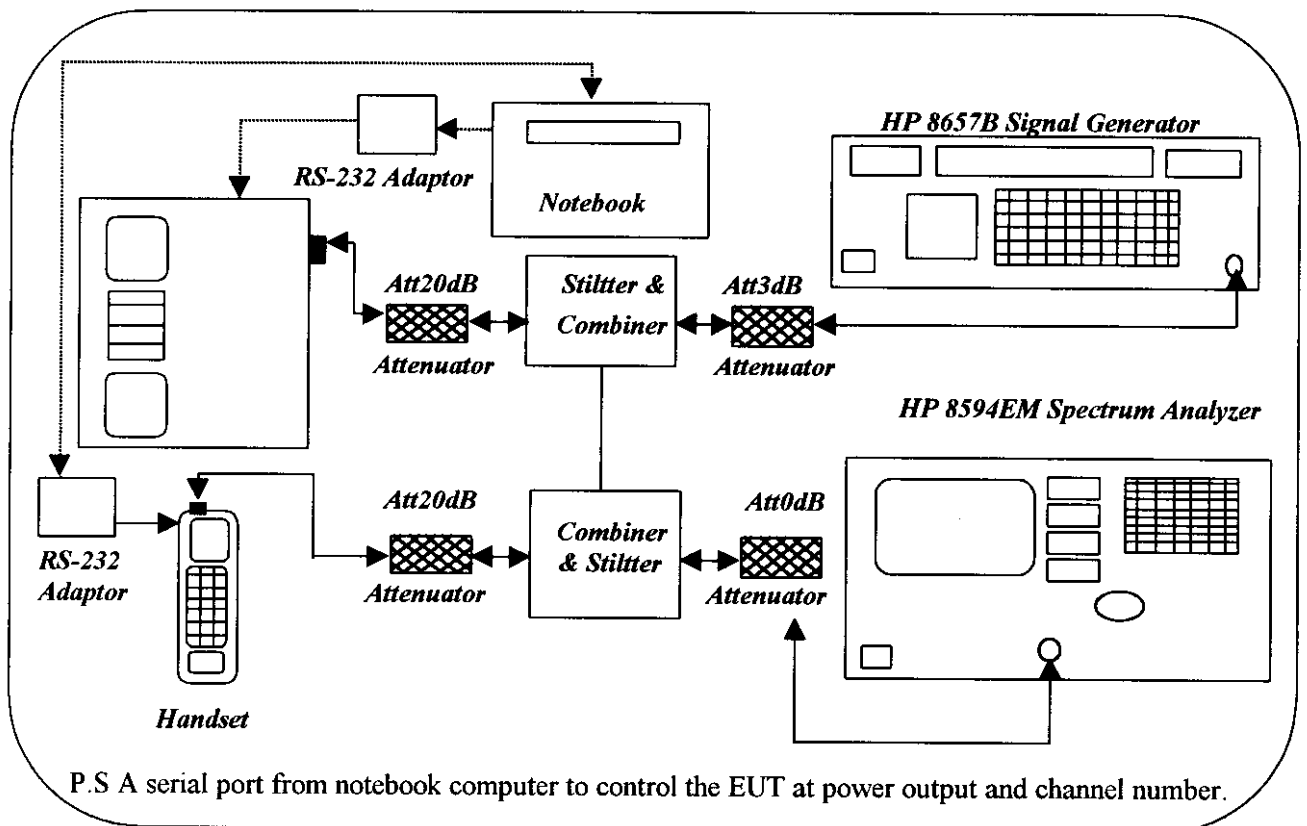

Fig. 14 Test Configuration of processing gain for handset

7.3 List of Test Instruments

Manufacturer	Device	Model	Input Impedance
Hewlett Packard	100Hz-1.8GHz Spectrum Analyzer	HP8592A	50.00
Hewlett Packard	100Hz-2.6GHz Signal Generator	HP8657B	50.00
Mini Circuits	10MHz-2GHz Power Splitter/Combiner	ZESC-2-11	50.00
Mini Circuits	DC-1.5GHz 3dB Attenuator	CAT-3	50.00
Mini Circuits	DC-1.5GHz 20dB Attenuator	CAT-20	50.00
Mini Circuits	DC-1.5GHz 30dB Attenuator	CAT-30	50.00

7.4 Test Procedure

According to the Fig. 13 of the page 56, combine the stuffs.

Measure the low power output of the channel 10 of the handset while the handset is in "Transmit-Only-Test" and the whole circuit is as same as Fig. 13. What we measure in this step is "S".

Change to the "BER Test " program. Increase the RF output of the signal generator till the BER is close to the 0.1% but under 0.1%.

Stop the program and turn off the base, handset then record the highest point of the spectrum. What we measure in this step is "J".

Star the Program again and test the next point.

7.5 Test Result of Processing Gain.

Model No. : DB-8228, DB-8232

EUT : 900MHz S.S.T. Cordless Phone

Table 35 Processing Gain [Channel 10, Handset]

Jammer Frequency (MHz)	S (dBm)	J (dBm)	Mj (J/S)	Process Gain (dB)
914.600	-48.88	-47.13	1.75	11.65
914.650	-48.88	-46.15	2.73	12.63
914.700	-48.88	-46.25	2.63	12.53
914.750	-48.88	-45.97	2.91	12.81
914.800	-48.88	-45.22	3.66	13.56
914.850	-48.88	-45.27	3.61	13.51
914.900	-48.88	-46.68	2.20	12.10
914.950	-48.88	-45.96	2.92	12.82
915.000	-48.88	-45.35	3.53	13.43
915.050	-48.88	-45.33	3.55	13.45
915.100	-48.88	-45.28	3.60	13.50
915.150	-48.88	-45.16	3.72	13.62
915.200	-48.88	-45.79	3.09	12.99
915.250	-48.88	-45.17	3.71	13.61
915.300	-48.88	-45.55	3.33	13.23
915.350	-48.88	-45.23	3.65	13.55
915.400	-48.88	-45.89	2.99	12.89
915.450	-48.88	-45.88	3.00	12.90
915.500	-48.88	-45.07	3.81	13.71
915.550	-48.88	-44.55	4.33	14.23
915.600	-48.88	-44.45	4.43	14.33
915.650	-48.88	-44.48	4.40	14.30
915.700	-48.88	-44.68	4.20	14.10
915.750	-48.88	-44.69	4.19	14.09
915.800	-48.88	-44.97	3.91	13.81
915.850	-48.88	-44.88	4.00	13.90
915.900	-48.88	-44.74	4.14	14.04
915.950	-48.88	-44.35	4.53	14.43
916.000	-48.88	-44.25	4.63	14.53
916.050	-48.88	-44.14	4.74	14.64

Test Result : Processing Gain: 12.89 dBNote: 1. $GP = (S/No) + Mj + L_{sys} = 7.9dB + Mj + 2 dB$

2. S = Signal Level

3. J = Signal Generator RF Output

Table 36 Processing Gain [Channel 10, Base]

Jammer Frequency (MHz)	S (dBm)	J (dBm)	Mj (J/S)	Process Gain (dB)
914.600	-45.98	-44.81	1.17	11.07
914.650	-45.98	-44.75	1.23	11.13
914.700	-45.98	-44.77	1.21	11.11
914.750	-45.98	-43.66	2.32	12.22
914.800	-45.98	-43.43	2.55	12.45
914.850	-45.98	-43.45	2.53	12.43
914.900	-45.98	-43.18	2.80	12.70
914.950	-45.98	-43.89	2.09	11.99
915.000	-45.98	-43.79	2.19	12.09
915.050	-45.98	-43.97	2.01	11.91
915.100	-45.98	-43.84	2.14	12.04
915.150	-45.98	-43.69	2.29	12.19
915.200	-45.98	-43.21	2.77	12.67
915.250	-45.98	-43.55	2.43	12.33
915.300	-45.98	-43.18	2.80	12.70
915.350	-45.98	-43.04	2.94	12.84
915.400	-45.98	-42.98	3.00	12.90
915.450	-45.98	-42.45	3.53	13.43
915.500	-45.98	-42.35	3.63	13.53
915.550	-45.98	-42.31	3.67	13.57
915.600	-45.98	-42.21	3.77	13.67
915.650	-45.98	-42.69	3.29	13.19
915.700	-45.98	-42.14	3.84	13.74
915.750	-45.98	-42.04	3.94	13.84
915.800	-45.98	-41.97	4.01	13.91
915.850	-45.98	-41.85	4.13	14.03
915.900	-45.98	-41.84	4.14	14.04
915.950	-45.98	-41.61	4.37	14.27
916.000	-45.98	-41.05	4.93	14.83
916.050	-45.98	-41.04	4.94	14.84

Test Result : Processing Gain: 12.09 dB

Note: 1. $GP = (S/No) + Mj + L_{sys} = 7.9dB + Mj + 2 dB$

2. S = Signal Level

3. J = Signal Generator RF Output

Appendix A

Setting up Procedure

1. Using an RS-232 Adaptor that is given by customer connected with the COM 1 of the computer.
2. The other end of the RS-232 Adaptor is connected with the EUT.
3. Use the software that is given by the customer and operated in the windows to control the EUT's continuous transmission.

Appendix B

Antenna Sketch

9480 8228 此为大修设计图

NO.	PART NAME	MATERIAL	TREATMENT
①	COVER(A)	ABS	TEXTURE
②	ANT. TUBE	PC+ABS	TEXTURE
③	WIRE	PVC	FINISH
④	BRACKET	ABS	FINISH
⑤	COVER(B)	ABS	TEXTURE

REVISIONS		
REV	DESCRIPTION	ENGR
△		

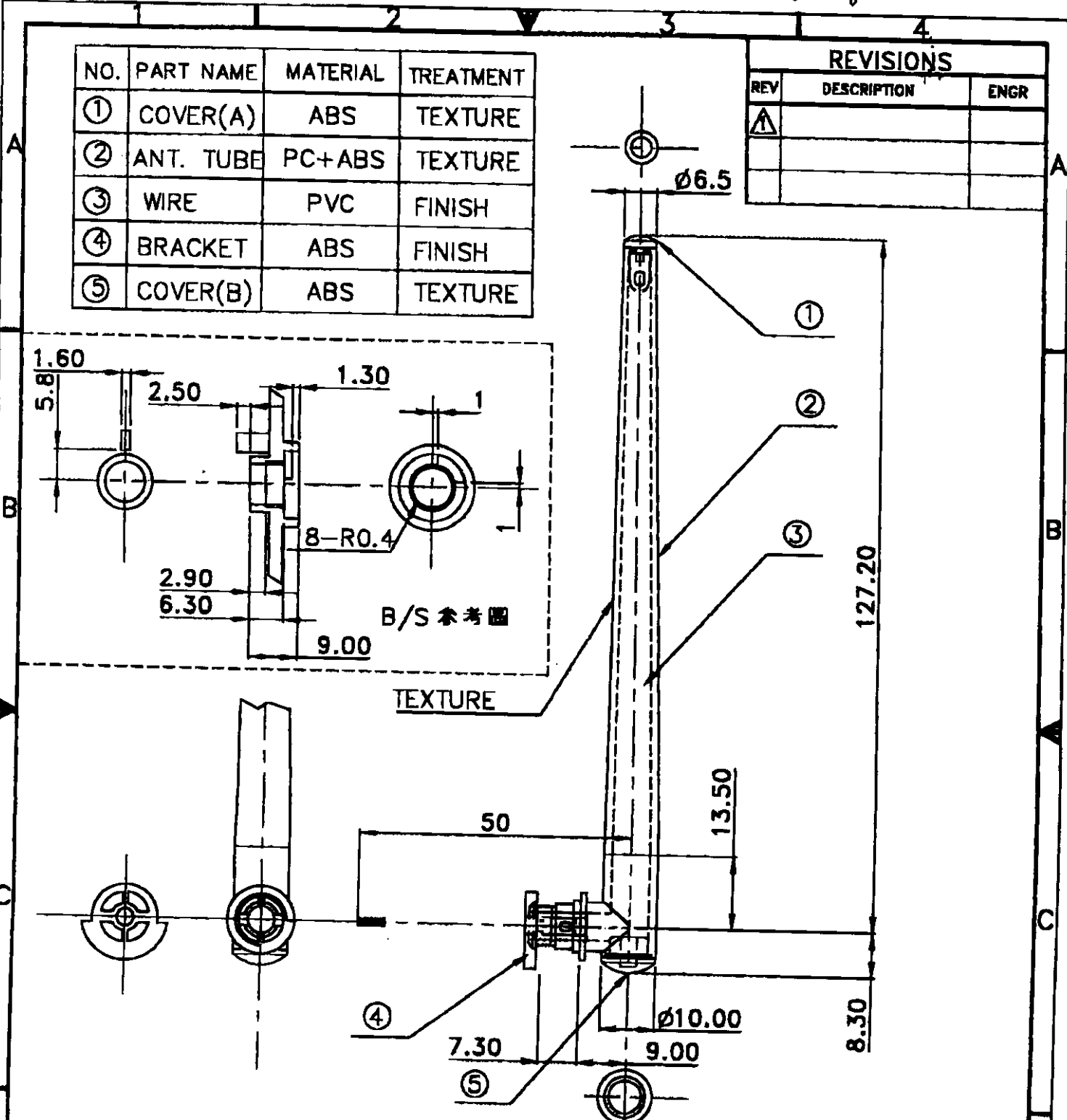

UNLESS OTHERWISE SPECIFIED
ALL DIMENSIONS ARE IN MM
TOLERANCE ON:
LINEAR : X ± 0.2
 X.X ± 0.15
 X.XX ± 0.1
ANGULAR: X ± 1°
 X.X ± 0.5°

ENGR	SHEU	MODEL	DB-8112 DB-8228	
DRN	SHEU/JERRY	DRAWING TITLE	ANT. ASS'Y (B/S)	
CHK	<i>[Signature]</i>	DWG. NO.	8112-MAT31	
APRV		CAD FILE	8112AT31	
M'TL		SCALE	2:1	ISSUE DATE 99/03/30
FINISH		SIZE	A4	SHEET OF
DO NOT SCALE				

DBTEL
DBTEL Incorporated

WARNING
PROPRIETARY INFORMATION
CANNOT BE DISCLOSED
WITHOUT PRIOR AUTHORIZATION

9450 H/S DB-8228

REVISIONS		
REV	DESCRIPTION	ENGR
△		

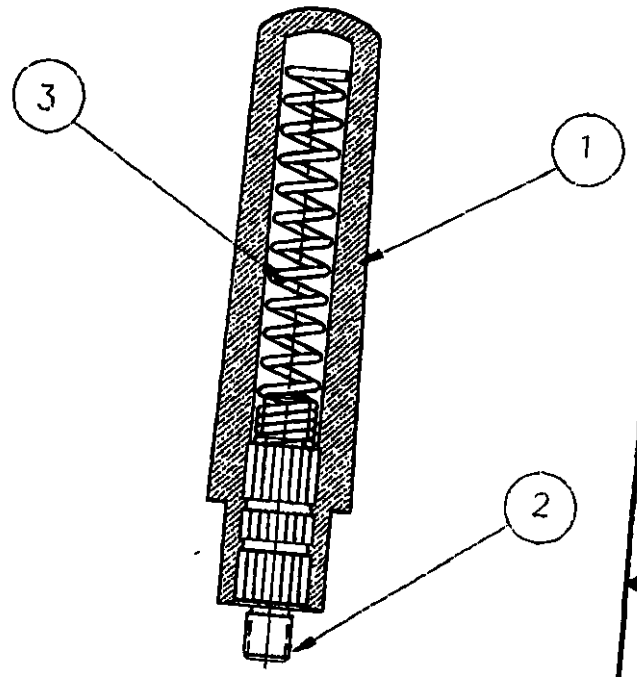
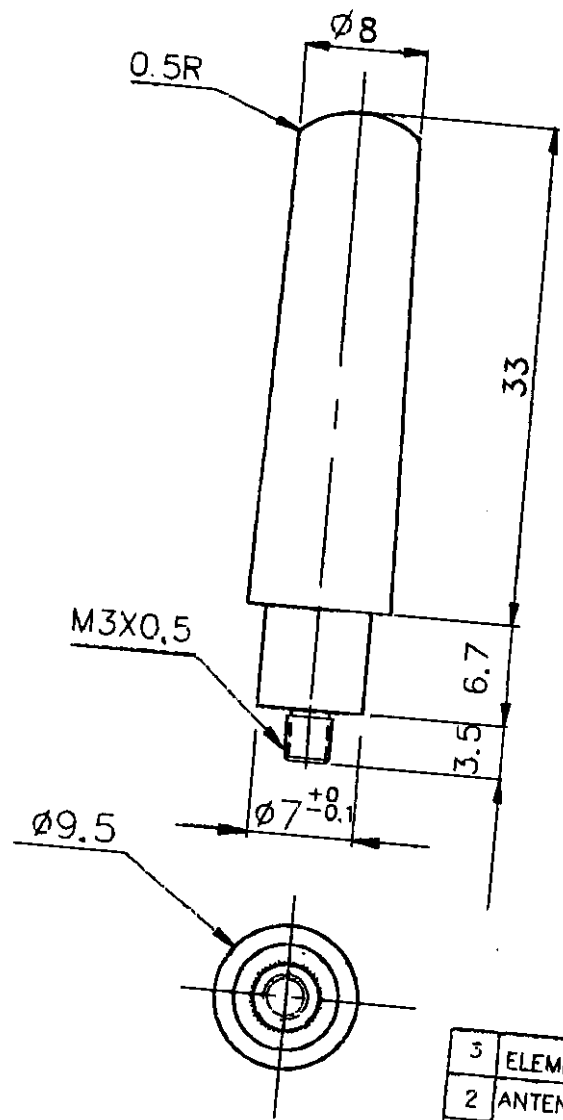

NO.	PARTS NAME	MATERIAL	QTY	FINISH	NOTE
3	ELEMENT	SWC			
2	ANTENNA BASE	BSBM	1		
1	TUBE	PU	1	NI	

UNLESS OTHERWISE SPECIFIED
ALL DIMENSIONS ARE IN MM
TOLERANCE ON:
LINEAR : X ± 0.2
 X.X ± 0.15
 X.XX ± 0.1
ANGULAR: X ± 1°
 X.X ± 0.5°

DBTEL
DIALER AND BUSINESS
ELECTRONICS CO., LTD.
大顯電子
股份有限公司

WARNING
PROPRIETARY INFORMATION
CANNOT BE DISCLOSED
WITHOUT PRIOR AUTHORIZATION
專利所有
不得洩密

ENGR	SHEU	MODEL	DB- 8112 8228 P228
DRN	SHEU	DRAWING TITLE	ANTENNA ASSEMBLY (H/S)
CHK		DWG. NO.	
APRV		CAD FILE	
M'TL		SCALE	2:1
FINISH		SIZE	A4
DO NOT SCALE		ISSUE DATE	99/1/12
		SHEET	OF

Appendix C

The antenna of the device is screwed inside the device, the user can not remove it freely without any tools from outside the device. This is comply with the FCC rules part 15.203

Appendix D

Security Code

Description of 900 MHz Direct Spectrum Cordless Phone

The subject device's 20 independent channels, autoscans at link establishment and smart channel hopping combine to find the clearest channels at all times, automatically.

Spread spectrum technology ensures the highest level of security available in a cordless phone.

The spread spectrum technique provides better security than other solutions since only the receiver has a copy of the pre-assigned spreading code, making interception virtually impossible. The transmitting signal is diluted over a large bandwidth with power density at any point being very light, so the signal goes unnoticed by other systems since they are not tuned to receive it. Moreover the scrambling code changes every 8 times the phone is parked, and there are millions of codes.

Scrambler / Descrambler A 16-code randomizes the voice and supervisory data for transmission and reception, more than 64K scramble codes are available from the 16-bit maximal length pseudo-noise sequencer generator.

Spread Spectrum Spreader Each transmitted bit is multiplied with a 12-chip spreading code, meeting FCC Part 15.247 requirements.