

SAR Test Report

Product Name : GSM900/DCS1800/PCS1900
GSM/GPRS Mobile Phone
Model No. : J9
FCC ID : BW3DB-2072A

Applicant : DBTEL INC.

Address : 29 Tzu Chiang ST., Tu-Cheng, Taipei, Taiwan, R.O.C.

Date of Receipt : 2004/12/15
Issued Date : 2004/12/20
Report No. : 04BL048SF

The test results relate only to the samples tested.

The test report shall not be reproduced except in full without the written approval of Quietek Corporation.

SAR test report is for production unit.

Test Report Certification

Issued Date: 2004/12/20

Report No.:04BL048SF



Product Name : GSM900/DCS1800/PCS1900 GSM/GPRS Mobile Phone
 Applicant : DBTEL INC.
 Address : 29 Tzu Chiang ST.,Tu-Cheng,Taipei,Taiwan,R.O.C.
 Manufacturer : DBTEL INC.
 Model No. : J9
 Trade Name : DBTEL
 Applicable Standard : FCC Oet65 Supplement C June 2001
 IEEE Std. 1528-2003
 47CFR § 2.1093
 Test Result : Max. SAR Measurement (1g)
 Head: 0.46 W/kg
 Body: 0.41 W/kg
 Application Type : Certification

The test results relate only to the samples tested.

The test report shall not be reproduced except in full without the written approval of Quietek Corporation.

Documented By : Grace Ltn
 (Grace Lin)

Tested By : Shine Hsu
 (Shine Hsu)

Approved By : Gene Chang
 (Gene Chang)

TABLE OF CONTENTS

Description	Page
1. General Information.....	5
1.1 EUT Description	5
1.2 Test Environment	5
2. SAR Measurement System.....	6
2.1 ALSAS-10U System Description	6
2.1.1 Applications	6
2.1.2 Area Scans.....	6
2.1.3 Zoom Scan (Cube Scan Averaging).....	7
2.1.4 ALSAS-10U Interpolation and Extrapolation Uncertainty.....	7
2.2 Isotropic E-Field Probe	7
2.2.1 Isotropic E-Field Probe Specification.....	9
2.3 Boundary Detection Unit and Probe Mounting Device	9
2.4 Daq-Paq (Analog to Digital Electronics).....	10
2.5 Axis Articulated Robot	10
2.6 ALSAS Universal Workstation.....	11
2.7 Universal Device Positioner.....	11
2.8 Phantom Types.....	11
2.8.1 APREL SAM Phantoms	12
2.8.2 APREL Laboratories Universal Phantom	12
3. Tissue Simulating Liquid	13
3.1 The composition of the tissue simulating liquid	13
3.2 Tissue Calibration Result	13
3.3 Tissue Dielectric Parameters for Head and Body Phantoms	15
4. SAR Measurement Procedure.....	16
4.1 SAR System Validation.....	16
4.1.1 Validation Dipoles.....	16
4.1.2 Validation Result	16
4.2 Arrangement Assessment Setup	17
4.2.1 Test Positions of Device Relative to Head.....	17
4.2.1.1 Definition of the “Cheek” Position	17
4.2.1.2 Definition of the “Tilted” Position.....	18
4.2.2 Test Positions for body-worn.....	19
4.3 SAR Measurement Procedure	19
5. SAR Exposure Limits	21
6. Test Equipment List.....	22

7. **Measurement Uncertainty**..... **23**

8. **Test Results** **24**

 8.1 SAR Test Results Summary 24

 8.2 SAR System Validation Data 26

 8.3 SAR Measurement Data..... 30

 Test Setup Photographs 88

 EUT Photographs 91

 Probe Calibration 93

 Dipole Calibration..... 114

1. General Information

1.1 EUT Description

Product Name	GSM900/DCS1800/PCS1900 GSM/GPRS Mobile Phone
Trade Name	DBTEL
Model No.	J9
FCC ID	BW3DB-2072A
IMEI No.	35527500000012
TX Frequency	1850MHz ~ 1910MHz
RX Frequency	1930MHz ~ 1990MHz
Antenna Type	Internal
Device Category	Portable
RF Exposure Environment	Uncontrolled
Max. Output Power (Conducted)	29.8dBm
Test Mode	GSM Mode: Voice GPRS Mode: Data Note: It is not intended to be used by the head during the data operation mode.

1.2 Test Environment

Ambient conditions in the laboratory:

Items	Required	Actual
Temperature (°C)	18-25	24.5
Humidity (%RH)	30-70	57

2. SAR Measurement System

2.1 ALSAS-10U System Description

ALSAS-10-U is fully compliant with the technical and scientific requirements of IEEE 1528, IEC 62209, CENELEC, ARIB, ACA, and the Federal Communications Commission. The system comprises of a six axes articulated robot which utilizes a dedicated controller.

ALSAS-10U uses the latest methodologies and FDTD modeling to provide a platform which is repeatable with minimum uncertainty.

2.1.1 Applications

Predefined measurement procedures compliant with the guidelines of CENELEC, IEEE, IEC, FCC, etc are utilized during the assessment for the device. Automatic detection for all SAR

maxima are embedded within the core architecture for the system, ensuring that peak locations used for centering the zoom scan are within a 1mm resolution and a 0.05mm repeatable position. System operation range currently available up-to 6 GHz in simulated tissue.

2.1.2 Area Scans

Area scans are defined prior to the measurement process being executed with a user defined variable spacing between each measurement point (integral) allowing low uncertainty measurements to be conducted. Scans defined for FCC applications utilize a 10mm² step integral, with 1mm interpolation used to locate the peak SAR area used for zoom scan assessments.

Where the system identifies multiple SAR peaks (which are within 25% of peak value) the system will provide the user with the option of assessing each peak location individually for zoom scan averaging.



2.1.3 Zoom Scan (Cube Scan Averaging)

The averaging zoom scan volume utilized in the ALSAS-10U software is in the shape of a cube and the side dimension of a 1 g or 10 g mass is dependent on the density of the liquid representing the simulated tissue. A density of 1000 kg/m³ is used to represent the head and body tissue density and not the phantom liquid density, in order to be consistent with the definition of the liquid dielectric properties, i.e. the side length of the 1 g cube is 10mm, with the side length of the 10 g cube 21,5mm.

When the cube intersects with the surface of the phantom, it is oriented so that 3 vertices touch the surface of the shell or the center of a face is tangent to the surface. The face of the cube closest to the surface is modified in order to conform to the tangent surface.

The zoom scan integer steps can be user defined so as to reduce uncertainty, but normal practice for typical test applications (including FCC) utilize a physical step of 5x5x8 (8mmx8mmx5mm) providing a volume of 32mm in the X & Y axis, and 35mm in the Z axis.

2.1.4 ALSAS-10U Interpolation and Extrapolation Uncertainty

The overall uncertainty for the methodology and algorithms the used during the SAR calculation was evaluated using the data from IEEE 1528 based on the example f3 algorithm:

$$f_3(x, y, z) = A \frac{a^2}{\frac{a^2}{4} + x'^2 + y'^2} \cdot \left(e^{-\frac{2z}{a}} + \frac{a^2}{2(a + 2z)^2} \right)$$

2.2 Isotropic E-Field Probe

The isotropic E-Field probe has been fully calibrated and assessed for isotropicity, and boundary effect within a controlled environment. Depending on the frequency for which the probe is calibrated the method utilized for calibration will change. A number of methods is used for calibrating probes, and these are outlined in the table below:

Calibration Frequency	Air Calibration	Tissue Calibration
1900MHz	TEM Cell	Temperature

The E-Field probe utilizes a triangular sensor arrangement as detailed in the diagram below:

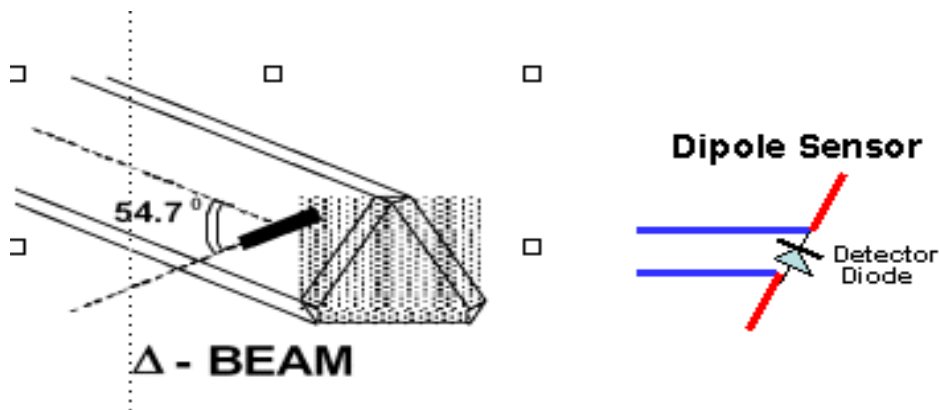

SAR is assessed with a calibrated probe which moves at a default height of 5mm from the center of the diode, which is mounted to the sensor, to the phantom surface (in the Z Axis). The 5mm offset height has been selected so as to minimize any resultant boundary effect due to the probe being in close proximity to the phantom surface.

The following algorithm is an example of the function used by the system for linearization of the output from the probe when measuring complex modulation schemes.

$$V_i = U_i + U_i^2 \cdot \frac{cf}{dcp_i}$$

2.2.1 Isotropic E-Field Probe Specification

Calibration in Air	Frequency Dependent Below 2GHz Calibration in air performed in a TEM Cell Above 2GHz Calibration in air performed in waveguide
Sensitivity	0.70 $\mu\text{V}/(\text{V}/\text{m})^2$ to 0.85 $\mu\text{V}/(\text{V}/\text{m})^2$
Dynamic Range	0.0005 W/kg to 100W/kg
Isotropic Response	Better than 0.2dB
Diode Compression point (DCP)	Calibration for Specific Frequency
Probe Tip Radius	< 5mm
Sensor Offset	1.56 (+/- 0.02mm)
Probe Length	290mm
Video Bandwidth	@ 500 Hz: 1dB @1.02 KHz: 3dB
Boundary Effect	Less than 2% for distance greater than 2.4mm
Spatial Resolution	Diameter less than 5mm Compliant with Standards

2.3 Boundary Detection Unit and Probe Mounting Device

ALSAS-10U incorporates a boundary detection unit with a sensitivity of 0.05mm for detecting all types of surfaces. The robust design allows for detection during probe tilt (probe normalize) exercises, and utilizes a second stage emergency stop. The signal electronics are fed directly into the robot controller for high accuracy surface detection in lateral and axial detection modes (X, Y, & Z).

The probe is mounted directly onto the Boundary Detection unit for accurate tooling and displacement calculations controlled by the robot kinematics. The probe is connect to an isolated probe interconnect where the output stage of the probe is fed directly into the amplifier stage of the Daq-Paq

2.4 Daq-Paq (Analog to Digital Electronics)

ALSAS-10U incorporates a fully calibrated Daq-Paq (analog to digital conversion system) which has a 4 channel input stage, sent via a 2 stage auto-set amplifier module. The input signal is amplified accordingly so as to offer a dynamic range from 5µV to 800mV. Integration of the fields measured is carried out at board level utilizing a Co-Processor which then sends the measured fields down into the main computational module in digitized form via an RS232 communications port. Probe linearity and duty cycle compensation is carried out within the main Daq-Paq module.

ADC	12 Bit
Amplifier Range	20mV to 200mV and 150mV to 800mV
Field Integration	Local Co-Processor utilizing proprietary integration algorithms
Number of Input Channels	4 in total 3 dedicated and 1 spare
Communication	Packet data via RS232

2.5 Axis Articulated Robot



ALSAS-10U utilizes a six axis articulated robot, which is controlled using a Pentium based real-time movement controller. The movement kinematics engine utilizes proprietary (Thermo CRS) interpolation and extrapolation algorithms, which allow full freedom of movement for each of the six joints within the working envelope. Utilization of joint 6 allows for full probe rotation with a tolerance better than 0.05mm around the central axis.

Robot/Controller Manufacturer	Thermo CRS
Number of Axis	Six independently controlled axis
Positioning Repeatability	0.05mm
Controller Type	Single phase Pentium based C500C
Robot Reach	710mm
Communication	RS232 and LAN compatible

2.6 ALSAS Universal Workstation

ALSAS Universal workstation allows for repeatability and fast adaptability. It allows users to do calibration, testing and measurements using different types of phantoms with one set up, which significantly speeds up the measurement process.

2.7 Universal Device Positioner

The universal device positioner allow complete freedom of movement of the EUT. Developed to hold a EUT in a free-space scenario any additional loading attributable to the material used in the construction of the positioner has been eliminated. Repeatability has been enhanced through the linear scales which form the design used to indicate positioning for any given test scenario in all major axes. A 15° tilt indicator is included for the of aid cheek to tilt movements for head SAR analysis. Overall uncertainty for measurements have been reduced due to the design of the Universal device positioner, which allows positioning of a device in as near to a free-space scenario as possible, and by providing the means for complete repeatability.



2.8 Phantom Types

The ALSAS-10U allows the integration of multiple phantom types. SAM Phantoms fully compliant with IEEE 1528, Universal Phantom, and Universal Flat.

2.8.1 APREL SAM Phantoms

The SAM phantoms developed using the IEEE SAM CAD file. They are fully compliant with the requirements for both IEEE 1528 and FCC Supplement C. Both the left and right SAM phantoms are interchangeable, transparent and include the IEEE 1528 grid with visible NF and MB lines.

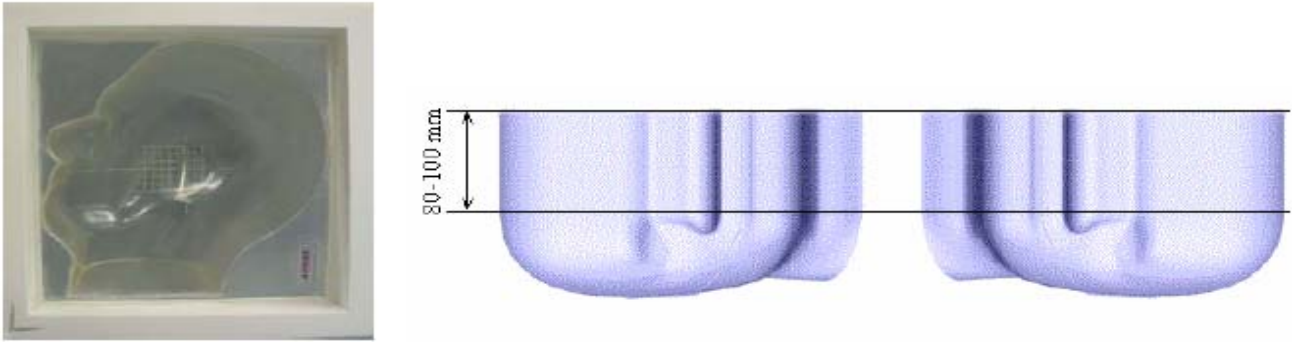

2.8.2 APREL Laboratories Universal Phantom

The Universal Phantom is used on the ALSAS-10U as a system validation phantom. The Universal Phantom has been fully validated both experimentally from 800MHz to 6GHz and numerically using XFDTD numerical software. The shell thickness is 2mm overall, with a 4mm spacer located at the NF/MB intersection providing an overall thickness of 6mm in line with the requirements of IEEE-1528.



The design allows for fast and accurate measurements, of handsets, by allowing the conservative SAR to be evaluated at on frequency for both left and right head experiments in one measurement.

3. Tissue Simulating Liquid

3.1 The composition of the tissue simulating liquid

INGREDIENT (% Weight)	900MHz Head	1800MHz Head	1900MHz Head	1900MHz Body
Water	--	--	54.90	40.5
Salt	--	--	0.18	0.50
Sugar	--	--	0.00	58.0
HEC	--	--	0.00	0.50
Preventol	--	--	0.00	0.50
DGBE	--	--	44.92	0.00

3.2 Tissue Calibration Result

The dielectric parameters of the liquids were verified prior to the SAR evaluation using APREL Dielectric Probe Kit and Anritsu MS4623B Vector Network Analyzer

Head Tissue Simulant Measurement				
Frequency [MHz]	Description	Dielectric Parameters		Temp. [°C]
		ϵ_r	σ [s/m]	
1900 MHz	Reference result ± 5% window	40.0 38 to 42	1.4 1.33 to 1.47	N/A
	16-Dec-04	39.14	1.44	23.6
1850 MHz	Low channel	39.41	1.39	23.6
1880 MHz	Mid channel	39.23	1.42	23.6
1910 MHz	High channel	39.10	1.45	23.6

Body Tissue Simulant Measurement				
Frequency [MHz]	Description	Dielectric Parameters		Temp. [°C]
		ϵ_r	σ [s/m]	
1900 MHz	Reference result ± 5% window	53.3 50.635 to 55.965	1.52 1.444 to 1.596	N/A
	16-Dec-04	52.31	1.56	23.6
1850 MHz	Low channel	52.60	1.51	23.6
1880 MHz	Mid channel	52.42	1.53	23.6
1910 MHz	High channel	52.25	1.57	23.6

3.3 Tissue Dielectric Parameters for Head and Body Phantoms

The head tissue dielectric parameters recommended by the IEEE SCC-34/SC-2 in P1528 have been incorporated in the following table. These head parameters are derived from planar layer models simulating the highest expected SAR for the dielectric properties and tissue thickness variations in a human head. Other head and body tissue parameters that have not been specified in P1528 are derived from the tissue dielectric parameters computed from the 4-Cole-Cole equations described in Reference [12] and extrapolated according to the head parameters specified in P1528.

Target Frequency (MHz)	Head		Body	
	ϵ_r	σ (S/m)	ϵ_r	σ (S/m)
150	52.3	0.76	61.9	0.80
300	45.3	0.87	58.2	0.92
450	43.5	0.87	56.7	0.94
835	41.5	0.90	55.2	0.97
900	41.5	0.97	55.0	1.05
915	41.5	0.98	55.0	1.06
1450	40.5	1.20	54.0	1.30
1610	40.3	1.29	53.8	1.40
1800 – 2000	40.0	1.40	53.3	1.52
2450	39.2	1.80	52.7	1.95
3000	38.5	2.40	52.0	2.73
5800	35.3	5.27	48.2	6.00

(ϵ_r = relative permittivity, σ = conductivity and $\rho = 1000 \text{ kg/m}^3$)

4. SAR Measurement Procedure

4.1 SAR System Validation

4.1.1 Validation Dipoles

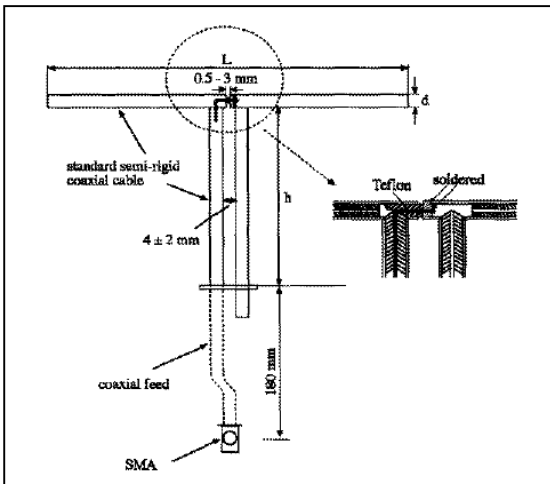

The dipoles used is based on the IEEE-1528 standard, and is complied with mechanical and electrical specifications in line with the requirements of both IEEE and FCC Supplement C. the table below provides details for the mechanical and electrical specifications for the dipoles.

Frequency	L (mm)	h (mm)	d (mm)
1900MHz	68.0	39.5	3.6

4.1.2 Validation Result

System Performance Check at 1900MHz					
Validation Kit: ASL-D-1900-S-2					
Frequency [MHz]	Actual Power	Description	SAR [w/kg] 1g	SAR [w/kg] 10g	Temp. [°C]
1900 MHz	1W	Reference result ± 5% window	39.7 37.715 to 41.685	20.5 19.475 to 21.525	N/A
		16-Dec-04	39.18	20.42	22.5
Note: All SAR values are normalized to 1W forward power.					

4.2 Arrangement Assessment Setup

4.2.1 Test Positions of Device Relative to Head

This specifies exactly two test positions for the handset against the head phantom, the “cheek” position and the “tilted” position. The handset should be tested in both positions on the left and right sides of the SAM phantom. If the handset construction is such that it cannot be positioned using the handset positioning procedures described in 4.2.2.1 and 4.2.2.2 to represent normal use conditions (e.g., asymmetric handset), alternative alignment procedures should be considered with details provided in the test report.

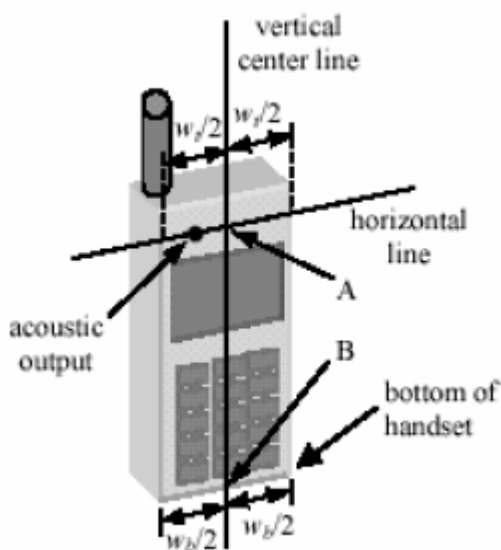

Figure 4.1a Fixed Case

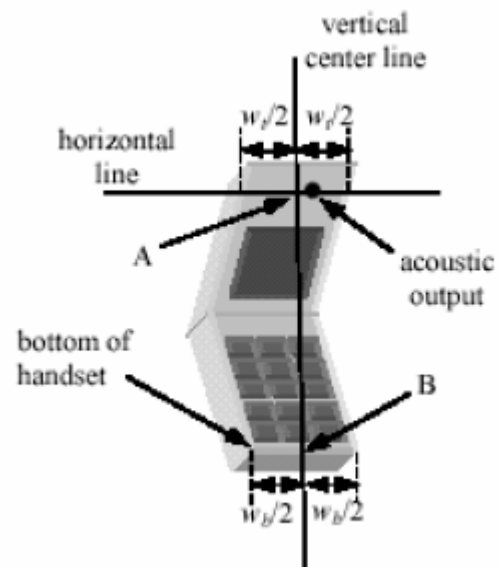

Figure 4.1b Clam Shell

4.2.1.1 Definition of the “Cheek” Position

The “cheek” position is defined as follows:

- a. Ready the handset for talk operation, if necessary. For example, for handsets with a cover piece, open the cover. (If the handset can also be used with the cover closed both configurations must be tested.)
- b. Define two imaginary lines on the handset: the vertical centerline and the horizontal line. The vertical centerline passes through two points on the front side of the handset: the midpoint of the width w_f of the handset at the level of the acoustic output (point A on Figures 4.1a and 4.1b), and the midpoint of the width w_b of the bottom of the handset (point B). The horizontal line is perpendicular to the vertical centerline and passes through the center of the acoustic output (see Figure 4.1a). The two lines intersect at point A. Note that for many handsets, point A coincides with the center of the acoustic output. However, the acoustic output may be located elsewhere on the horizontal line. Also note that the vertical centerline is not necessarily parallel to the front face of the handset (see Figure 4.1b), especially for clamshell handsets, handsets with flip pieces,

- and other irregularly-shaped handsets.
- c. Position the handset close to the surface of the phantom such that point A is on the (virtual) extension of the line passing through points RE and LE on the phantom (see Figure 4.2), such that the plane defined by the vertical center line and the horizontal line of the handset is approximately parallel to the sagittal plane of the phantom.
 - d. Translate the handset towards the phantom along the line passing through RE and LE until the handset touches the pinna.
 - e. While maintaining the handset in this plane, rotate it around the LE-RE line until the vertical centerline is in the plane normal to MB-NF including the line MB (called the reference plane).
 - f. Rotate the handset around the vertical centerline until the handset (horizontal line) is symmetrical with respect to the line NF.
 - g. While maintaining the vertical centerline in the reference plane, keeping point A on the line passing through RE and LE and maintaining the handset contact with the pinna, rotate the handset about the line NF until any point on the handset is in contact with a phantom point below the pinna (cheek). See Figure 4.2 the physical angles of rotation should be noted.

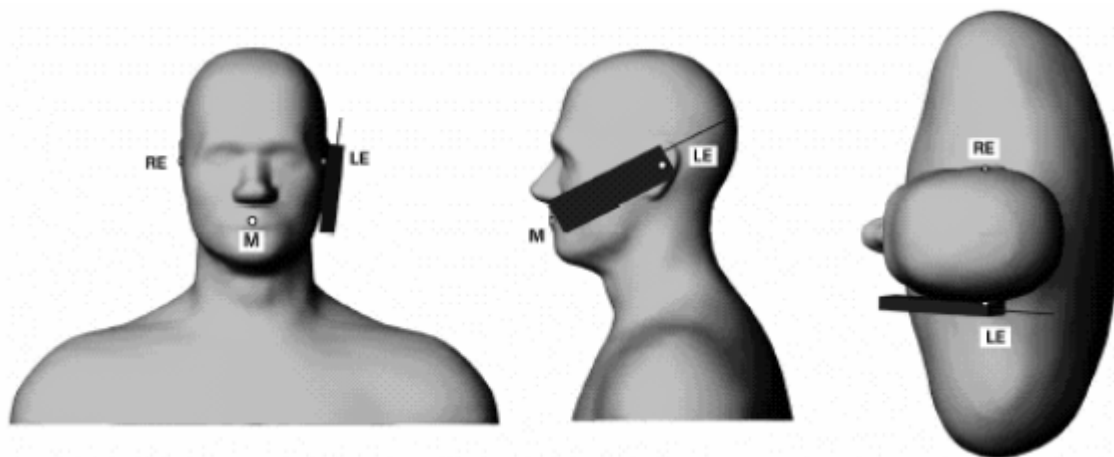

Figure 4.2 – Phone position 1, “cheek” or “touch” position.

4.2.1.2 Definition of the “Tilted” Position

The “tilted” position is defined as follows:

- a. Repeat steps (a) – (g) of 4.2.1.1 to place the device in the “cheek position.”
- b. While maintaining the orientation of the handset move the handset away from the pinna along the line passing through RE and LE in order to enable a rotation of the handset by 15 degrees.
- c. Rotate the handset around the horizontal line by 15 degrees.

d. While maintaining the orientation of the handset, move the handset towards the phantom on a line passing through RE and LE until any part of the handset touches the ear. The tilted position is obtained when the contact is on the pinna. If the contact is at any location other than the pinna (e.g., the antenna with the back of the phantom head), the angle of the handset should be reduced. In this case, the tilted position is obtained if any part of the handset is in contact with the pinna as well as a second part of the handset is contact with the phantom (e.g., the antenna with the back of the head).

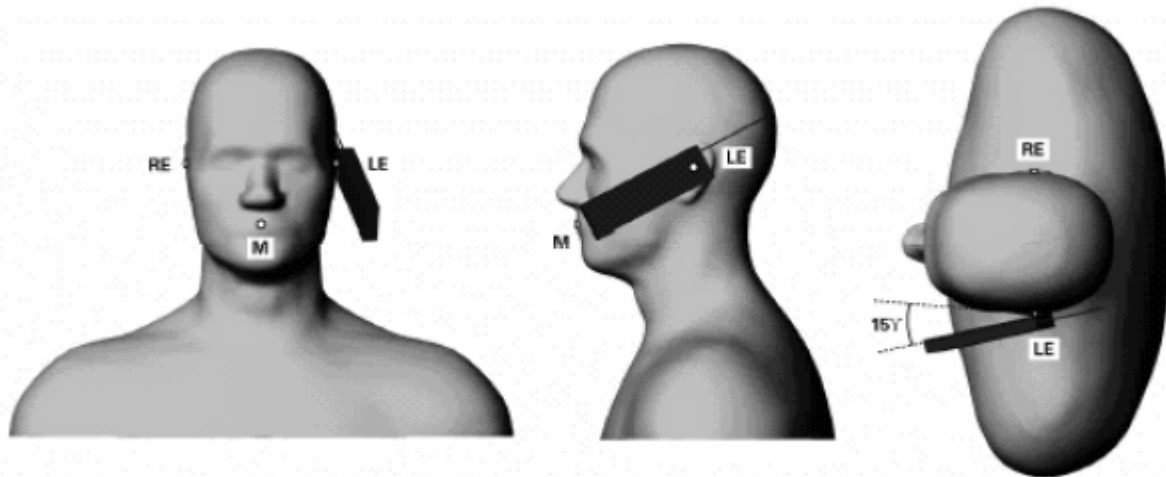

Figure 4.3 – Phone position 2, “tilted” position.

4.2.2 Test Positions for body-worn

Body-worn operating configurations should be tested with the belt-clips and holsters attached to the device and positioned against a flat phantom in normal use configurations. A separation distance of 1.5 cm between the back of the device and a flat phantom is recommended for testing body-worn SAR compliance under such circumstances. Other separation distance may be use, but not exceed 2.5 cm.

4.3 SAR Measurement Procedure

The ALSAS-10U calculates SAR using the following equation,

$$SAR = \frac{\sigma |E|^2}{\rho}$$

σ : represents the simulated tissue conductivity

ρ : represents the tissue density

The EUT is set to transmit at the required power in line with product specification, at each frequency relating to the LOW, MID, and HIGH channel settings.

Pre-scans are made on the device to establish the location for the transmitting antenna, using a large area scan in either air or tissue simulation fluid.

The EUT is placed against the Universal Phantom where the maximum area scan dimensions are larger than the physical size of the resonating antenna. When the scan size is not large enough to cover the peak SAR distribution, it is modified by either extending the area scan size in both the X and Y directions, or the device is shifted within the predefined area.

The area scan is then run to establish the peak SAR location (interpolated resolution set at 1mm^2) which is then used to orient the center of the zoom scan. The zoom scan is then executed and the 1g and 10g averages are derived from the zoom scan volume (interpolated resolution set at 1mm^3).

5. SAR Exposure Limits

SAR assessments have been made in line with the requirements of IEEE-1528, FCC Supplement C, and comply with ANSI/IEEE C95.1-1992 “Uncontrolled Environments” limits. These limits apply to a location which is deemed as “Uncontrolled Environment” which can be described as a situation where the general public may be exposed to an RF source with no prior knowledge or control over their exposure.

Limits for General Population/Uncontrolled Exposure (W/kg)

Type Exposure	Uncontrolled Environment Limit
Spatial Peak SAR (1g cube tissue for brain or body)	1.60 W/kg
Spatial Average SAR (whole body)	0.08 W/kg
Spatial Peak SAR (10g for hands, feet, ankles and wrist)	4.00 W/kg

6. Test Equipment List

Instrument	Manufacturer	Model No.	Serial No.	Last Calibration
Data Acquisition Package	Apral	ALS-DAQ-PAQ-1	QTK-313	Jun. 2004
Apral Laboratories Probe	Apral	ALS-E020	222	Nov. 2004
Apral Laboratories Probe	Apral	ALS-E020	225	Jun. 2004
Apral Reference Dipole 1900Mhz	Apral	ALS-D-1900-S-2	QTK-318	Jun. 2004
Boundary Detection Sensor System	Apral	ALS-PMDPS-1	QTK-314	N/A
Dielectric Probe Kit	Apral	ALS-PR-DIEL	QTK-296	N/A
Universal Work Station	Apral	ALS-UWS	QTK-326	N/A
Device Holder 2.0	Apral	ALS-H-E-SET-2	QTK-294	N/A
Left Ear SAM Phantom	Apral	ALS-P-SAM-L	QTK-292	N/A
Right Ear SAM Phantom	Apral	ALS-P-SAM-R	QTK-288	N/A
Universal Phantom	Apral	ALS-P-UP-1	QTK-246	N/A
Apral Dipole Spacer	Apral	ALS-DS-U	QTK-295	N/A
SAR Software	Apral	ALSAS-10	Ver. 1.1.14	N/A
CRS C500C Controller	Thermo	ALS-C500	RCF0404433	N/A
CRF F3 Robot	Thermo	ALS-F3	RAF0412222	N/A
Power Amplifier	Mini-Circuit	ZHL-42	D051404-20	N/A
Directional Coupler	Agilent	778D-012	50550	N/A
Universal Radio Communication Tester	Rohde & Schwarz	CMU 200	104846	Mar. 2004
Radio Communication Analyzer	Anritsu	MT8820A	6200323183	Jun. 2004
Vector Network	Anritsu	MS4623B	992801	Mar 2004
Signal Generator	Anritsu	MG3692A	042319	Jun. 2004
Power Meter	Anritsu	ML2487A	6K00001447	Jan. 2005
Wide Bandwidth Sensor	Anritsu	MA2491	030677	Nov. 2004

Note: All equipment upon which need to be calibrated are with calibration period of 1 year.

7. Measurement Uncertainty

Exposure Assessment Measurement Uncertainty

Source of Uncertainty	Tolerance Value %	Probability Distribution	Divisor	c_1^1 (1-g)	c_1^1 (10-g)	Standard Uncertainty (1-g) %	Standard Uncertainty (10-g) %
Measurement System							
Probe Calibration	3.5	normal	1	1	1	3.5	3.5
Axial Isotropy	3.7	rectangular	$\sqrt{3}$	$(1-cp)^{1/2}$	$(1-cp)^{1/2}$	1.5	1.5
Hemispherical Isotropy	10.9	rectangular	$\sqrt{3}$	\sqrt{cp}	\sqrt{cp}	4.4	4.4
Boundary Effect	1.0	rectangular	$\sqrt{3}$	1	1	0.6	0.6
Linearity	4.7	rectangular	$\sqrt{3}$	1	1	2.7	2.7
Detection Limit	1.0	rectangular	$\sqrt{3}$	1	1	0.6	0.6
Readout Electronics	1.0	normal	1	1	1	1.0	1.0
Response Time	0.8	rectangular	$\sqrt{3}$	1	1	0.5	0.5
Integration Time	1.7	rectangular	$\sqrt{3}$	1	1	1.0	1.0
RF Ambient Condition	3.0	rectangular	$\sqrt{3}$	1	1	1.7	1.7
Probe Positioner Mech.	0.4	rectangular	$\sqrt{3}$	1	1	0.2	0.2
Restriction							
Probe Positioning with respect to Phantom Shell	2.9	rectangular	$\sqrt{3}$	1	1	1.7	1.7
Extrapolation and Integration	3.7	rectangular	$\sqrt{3}$	1	1	2.1	2.1
Test Sample Positioning	4.0	normal	1	1	1	4.0	4.0
Device Holder Uncertainty	2.0	normal	1	1	1	2.0	2.0
Drift of Output Power	0.1	rectangular	$\sqrt{3}$	1	1	0.0	0.0
Phantom and Setup							
Phantom Uncertainty(shape & thickness tolerance)	3.4	rectangular	$\sqrt{3}$	1	1	2.0	2.0
Liquid Conductivity(target)	5.0	rectangular	$\sqrt{3}$	0.7	0.5	2.0	1.4
Liquid Conductivity(meas.)	0.1	rectangular	$\sqrt{3}$	0.7	0.5	0.0	0.0
Liquid Permittivity(target)	2.0	rectangular	$\sqrt{3}$	0.6	0.5	0.7	0.6
Liquid Permittivity(meas.)	4.2	rectangular	$\sqrt{3}$	0.6	0.5	1.4	1.2
Combined Uncertainty		RSS				9.2	9.1
Combined Uncertainty (coverage factor=2)		Normal (k=2)				18.4	18.1

8. Test Results

8.1 SAR Test Results Summary

SAR MEASUREMENT						
Ambient Temperature (°C) : 24.5 ±2			Relative Humidity (%): 57			
Liquid Temperature (°C) : 23.6 ±2			Depth of Liquid (cm):>15			
Product: GSM900/DCS1800/PCS1900 GSM/GPRS Mobile Phone						
Test Mode: PCS1900						
Test Position Head	Antenna Position	Frequency		Conducted Power (dBm)	SAR 1g (W/kg)	Limit (W/kg)
		Channel	MHz			
Right-Cheek	Internal	512	1850.2	29.8	0.42	1.6
Right-Cheek	Internal	661	1880.0	29.7	0.34	1.6
Right-Cheek	Internal	810	1909.8	29.8	0.46	1.6
Right-Tilted	Internal	512	1850.2	29.8	0.17	1.6
Right-Tilted	Internal	661	1880.0	29.7	0.23	1.6
Right-Tilted	Internal	810	1909.8	29.8	0.19	1.6
Left-Cheek	Internal	512	1850.2	29.8	0.38	1.6
Left-Cheek	Internal	661	1880.0	29.7	0.43	1.6
Left-Cheek	Internal	810	1909.8	29.8	0.36	1.6
Left-Tilted	Internal	512	1850.2	29.8	0.13	1.6
Left-Tilted	Internal	661	1880.0	29.7	0.11	1.6
Left-Tilted	Internal	810	1909.8	29.8	0.14	1.6

Note: The EUT test position is touch & tilted 15 degrees.

SAR MEASUREMENT						
Ambient Temperature (°C) :24.5 ±2				Relative Humidity (%): 57		
Liquid Temperature (°C) : 23.6 ±2				Depth of Liquid (cm):>15		
Product: GSM900/DCS1800/PCS1900 GSM/GPRS Mobile Phone						
Test Mode: PCS1900(GSM)						
Test Position Body	Antenna Position	Frequency		Conducted Power (dBm)	SAR 1g (W/kg)	Limit (W/kg)
		Channel	MHz			
Body-wore	Internal	512	1850.2	29.8	0.37	1.6
Body-wore	Internal	661	1880.0	29.7	0.37	1.6
Body-wore	Internal	810	1909.8	29.8	<u>0.41</u>	1.6
Test Mode: PCS1900(GPRS)						
Body-wore	Internal	512	1850.2	29.8	0.26	1.6
Body-wore	Internal	661	1880.0	29.7	0.26	1.6
Body-wore	Internal	810	1909.8	29.8	0.26	1.6
Note: A separation distance of 1.5 cm between the back of the device and a flat phantom for test.						

8.2 SAR System Validation Data

ALSAS-10U VER 1.5.14APREL Laboratories
SAR Test ReportValidation Date : 16-Dec-2004
Measurement Date : 16-Dec-2004

Product Data

Type : Dipole
Frequency : 1900.00 MHz
Max. Transmit Pwr : 1 W
Drift Time : 0 min(s)
Length : 68mm
Width : 3.6mm
Depth : 39.5mm
Power Drift-Start : 37.65 mV
Power Drift-Finish: 37.65 mV
Power Drift : 0.00 mV

Phantom Data

Type : Uni-Phantom
Size : 280mm x 280mm x 200mm
Location : Center

Tissue Data

Type : Head
Serial No. : 324-H
Frequency : 1900 MHz
Last Calibration Date : 16-Dec-2004
Temperature : 23.6 °C
Ambient Temp. : 24.5 °C
Humidity : 57 RH%
Epsilon : 39.14 F/m
Sigma : 1.44 S/m
Density : 1000 kg/cu. m

Probe Data

Model : E020
Type : E-Field Triangle
Serial No. : 222
Last Calibration Date : 28-Jun-2004
Frequency : 1900 MHz
Duty Cycle Factor: 1
Conversion Factor: 6
Probe Sensitivity: 1.30 1.30 1.30 $\mu\text{V}/(\text{V}/\text{sq. m})$
Compression Point: 95 mV
Offset : 1.56mm

Measurement Data

Crest Factor : 1

Frequency : 1900MHz

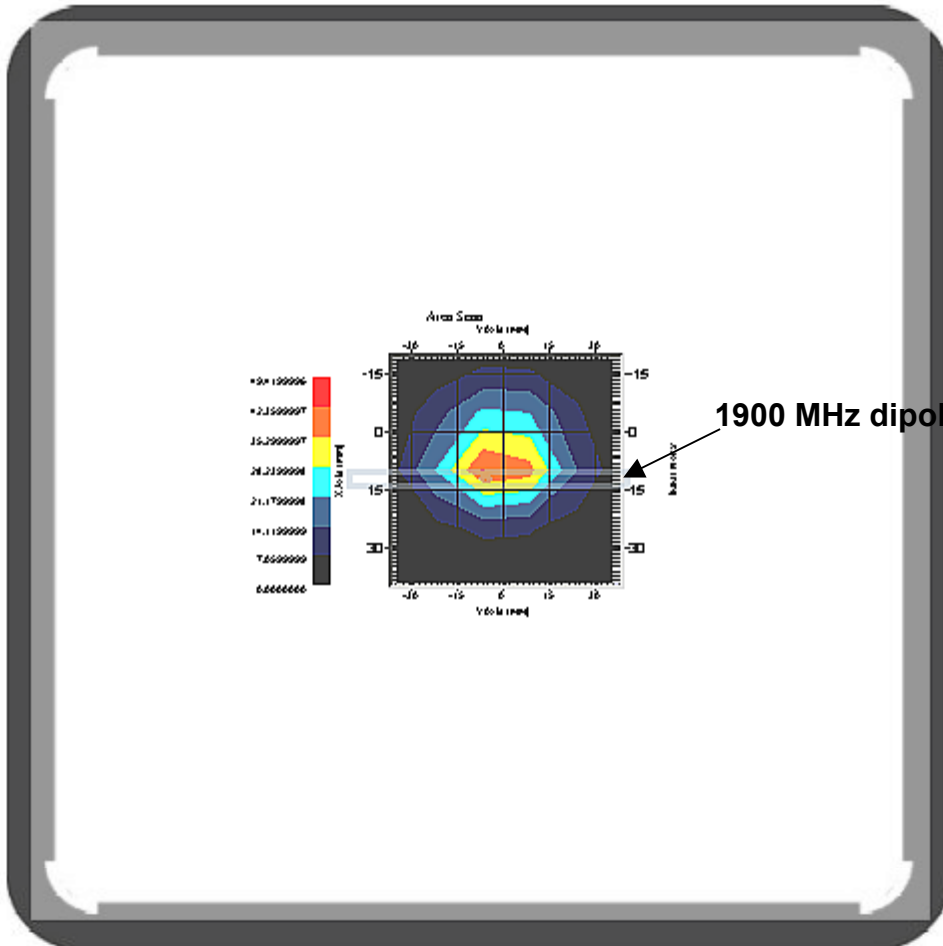

1 gram SAR value : 39.18 W/kg

10 gram SAR value : 20.42 W/kg

Area Scan Peak SAR : 42.39

Zoom Scan Peak SAR : 71.36

This is previous page plot (zoom in)

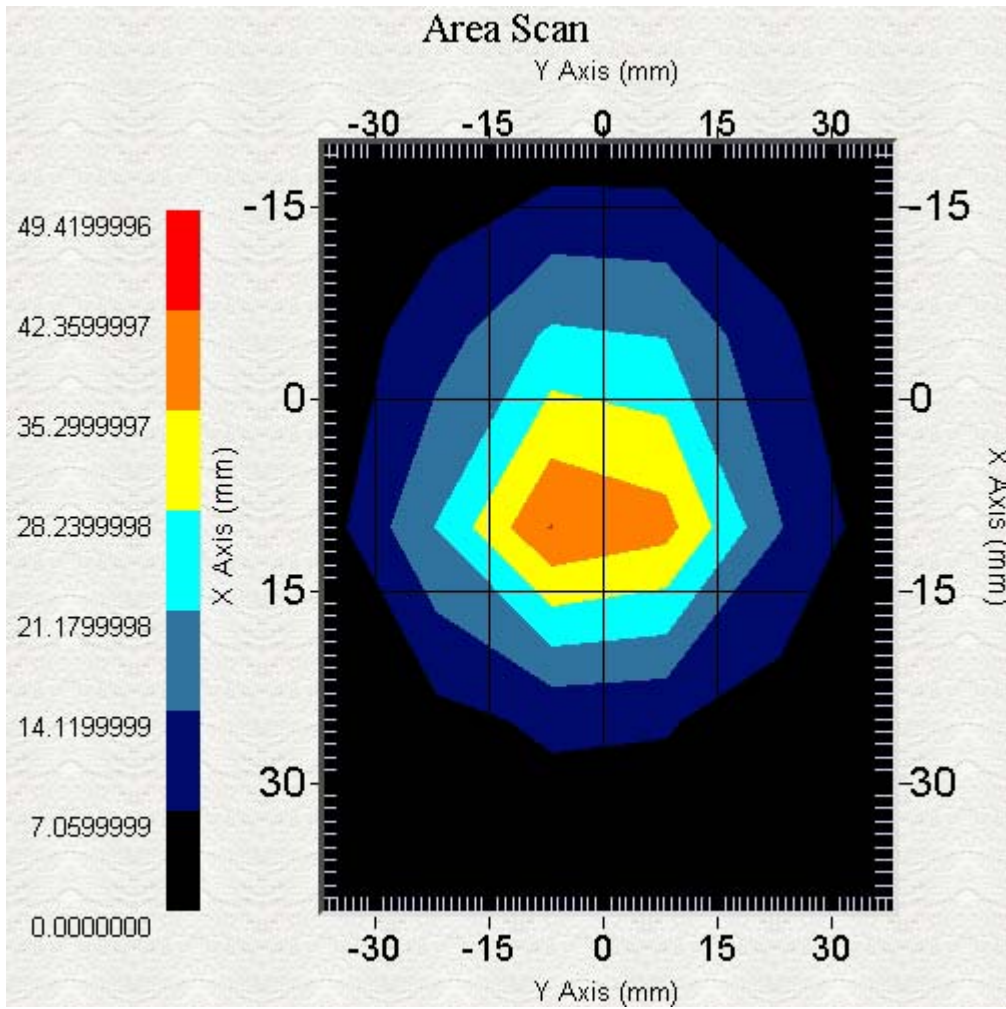

8.3 SAR Measurement Data

ALSAS-10U VER 1.5.14APREL Laboratories
SAR Test Report

Validation Date : 16-Dec-2004
Measurement Date : 16-Dec-2004

Product Data

Device Name : Dbtel_J9
Model : J9
Frequency : 1900.00 MHz
Max. Transmit Pwr : 1 W
Drift Time : 0 min(s)
Length : 151mm
Width : 45mm
Depth : 17.5mm
Power Drift-Start : 0.23 mV
Power Drift-Finish: 0.23 mV
Power Drift : 0.00 mV

Phantom Data

Type : SAM-Right
Size : 280mm x 280mm x 280mm
Location : Right

Tissue Data

Type : Head
Serial No. : 324-H
Frequency : 1900 MHz
Last Calibration Date : 16-Dec-2004
Temperature : 23.6 °C
Ambient Temp. : 24.5 °C
Humidity : 57 RH%
Epsilon : 39.14 F/m
Sigma : 1.44 S/m
Density : 1000 kg/cu. m

Probe Data

Model : E020
Type : E-Field Triangle
Serial No. : 222
Last Calibration Date : 18-Nov-2004
Frequency : 1900 MHz
Duty Cycle Factor: 8
Conversion Factor: 6
Probe Sensitivity: 1.30 1.30 1.30 $\mu\text{V}/(\text{V}/\text{sq. m})$
Compression Point: 95 mV
Offset : 1.56mm

Measurement Data

Crest Factor : 8
DUT Position : Touch
Channel : 512

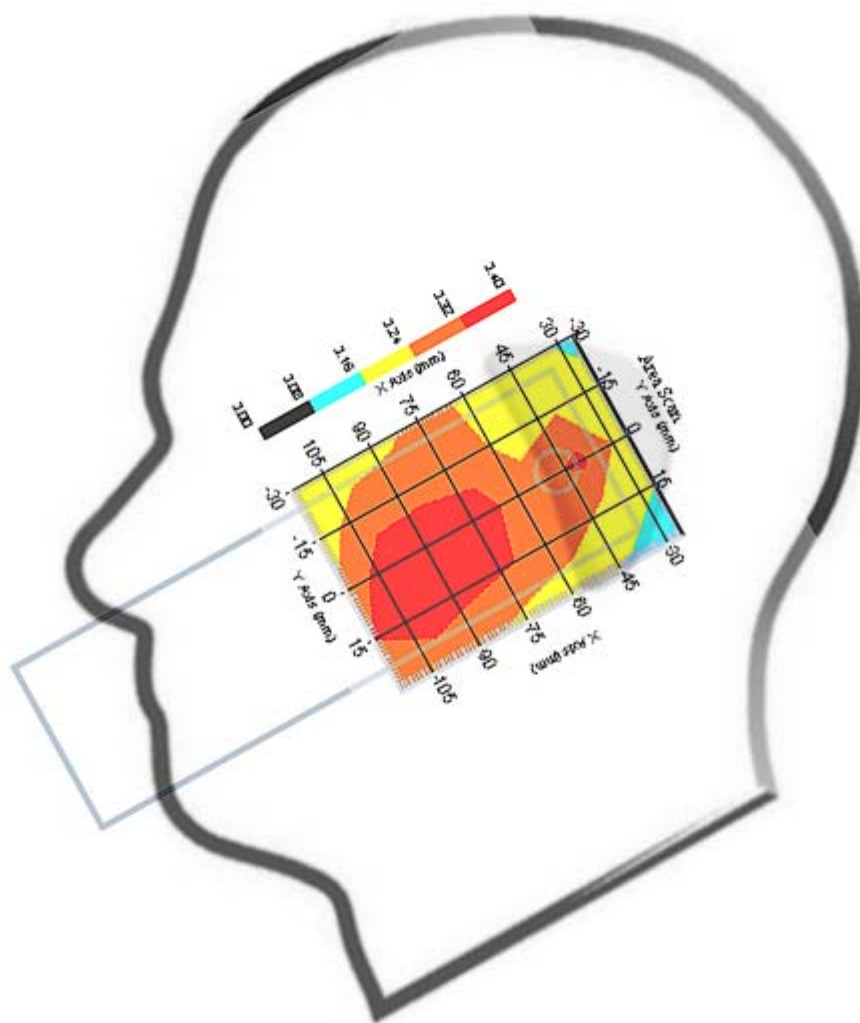

1 gram SAR value : 0.42 W/kg
10 gram SAR value : 0.35 W/kg
Area Scan Peak SAR : 0.39
Zoom Scan Peak SAR : 0.56

This is previous page plot (zoom in)

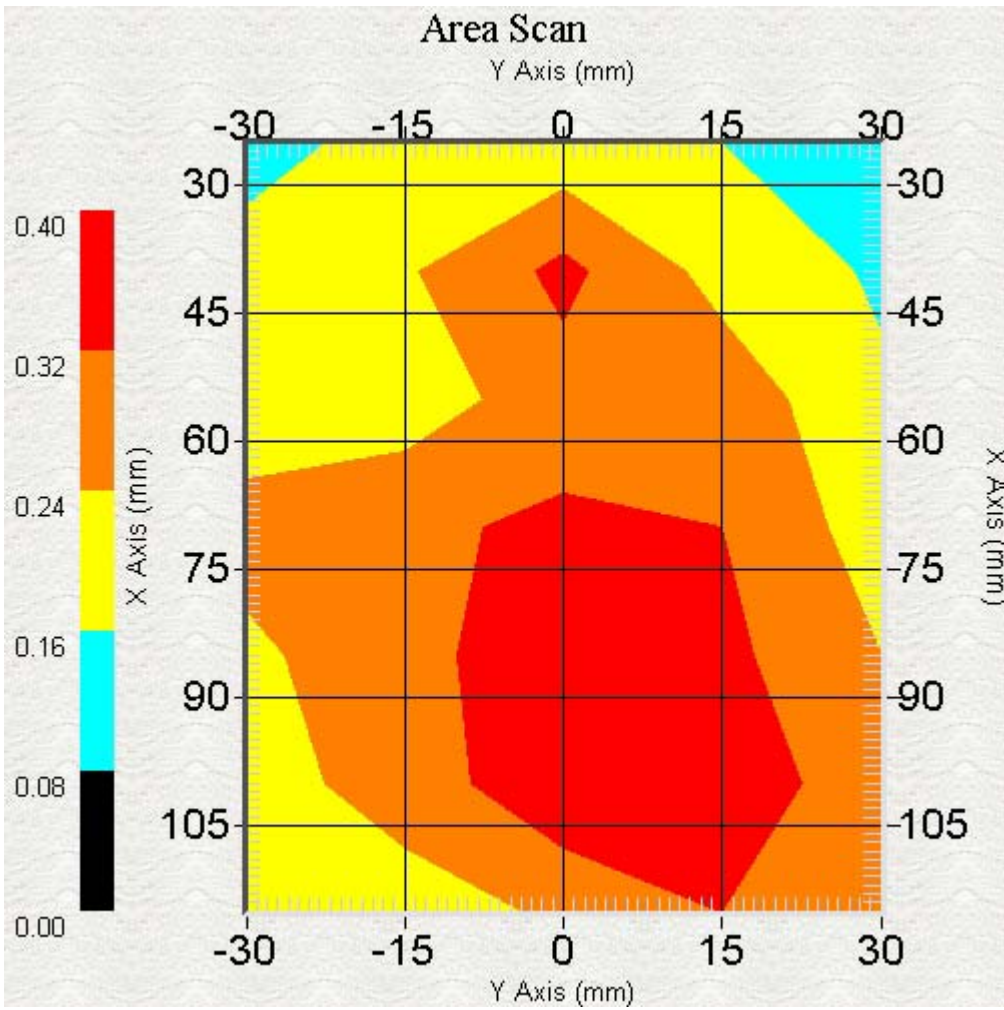

ALSAS-10U VER 1.5.14APREL Laboratories
SAR Test Report

Validation Date : 16-Dec-2004
Measurement Date : 16-Dec-2004

Product Data

Device Name : Dbtel_J9
Model : J9
Frequency : 1900.00 MHz
Max. Transmit Pwr : 1 W
Drift Time : 0 min(s)
Length : 151mm
Width : 45mm
Depth : 17.5mm
Power Drift-Start : 0.23
Power Drift-Finish: 0.20
Power Drift : 0.03

Phantom Data

Type : SAM-Right
Size : 280mm x 280mm x 280mm
Location : Right

Tissue Data

Type : Head
Serial No. : 324-H
Frequency : 1900 MHz
Last Calibration Date : 16-Dec-2004
Temperature : 23.6 °C
Ambient Temp. : 24.5 °C
Humidity : 57 RH%
Epsilon : 39.14 F/m
Sigma : 1.44 S/m
Density : 1000 kg/cu. m

Probe Data

Model : E020
Type : E-Field Triangle
Serial No. : 222
Last Calibration Date : 18-Nov-2004
Frequency : 1900 MHz
Duty Cycle Factor: 8
Conversion Factor: 6
Probe Sensitivity: 1.30 1.30 1.30 $\mu\text{V}/(\text{V}/\text{sq. m})$
Compression Point: 95 mV
Offset : 1.56mm

Measurement Data

Crest Factor : 8
DUT Position : Touch
Channel : 661

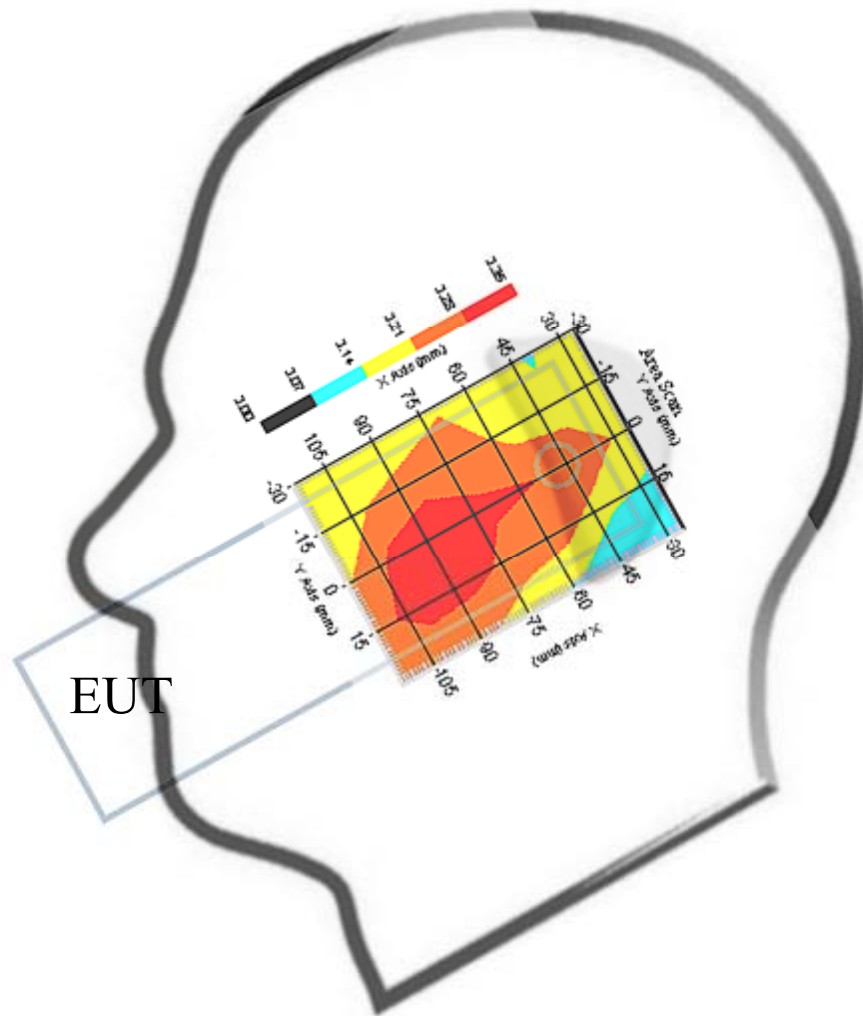

1 gram SAR value : 0.34 W/kg
10 gram SAR value : 0.27 W/kg
Area Scan Peak SAR : 0.35
Zoom Scan Peak SAR : 0.45

This is previous page plot (zoom in)

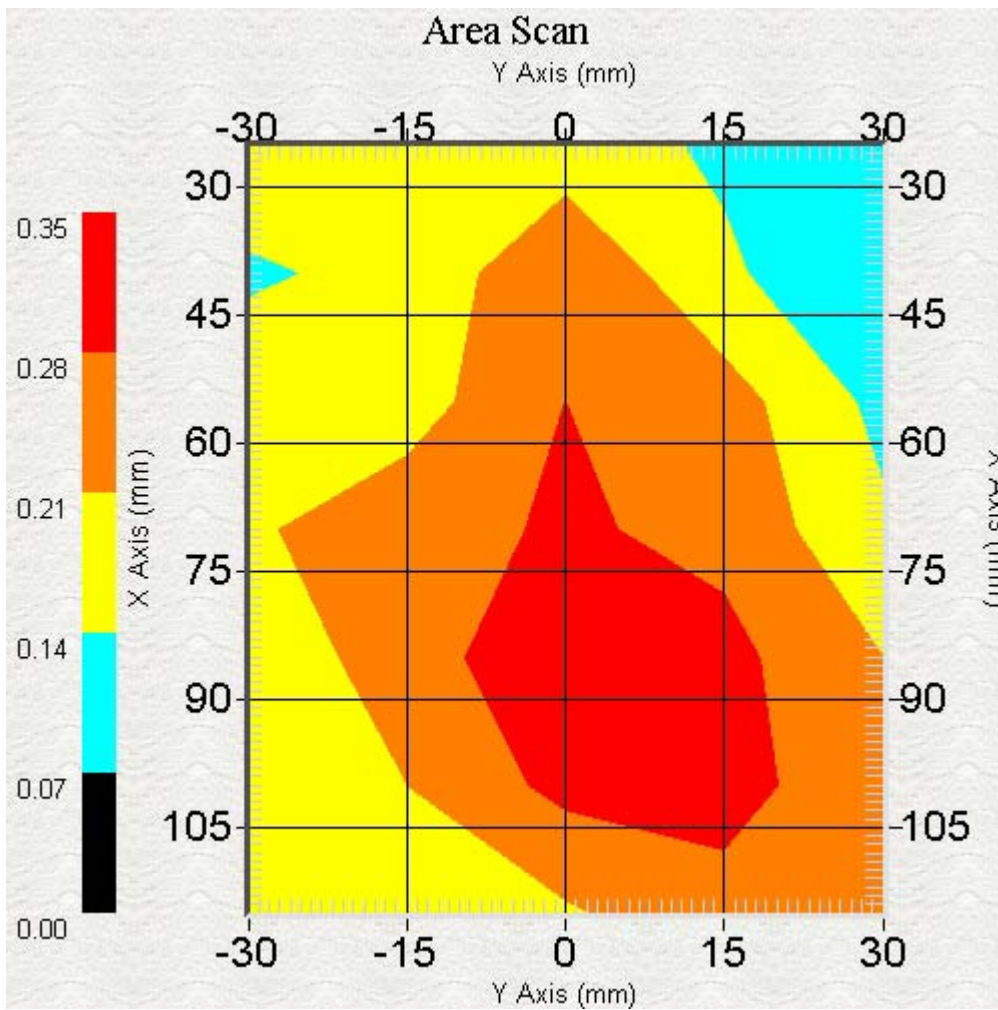

ALSAS-10U VER 1.5.14APREL Laboratories
SAR Test Report

Validation Date : 16-Dec-2004
Measurement Date : 16-Dec-2004

Product Data

Device Name : Dbtel_J9
Model : J9
Frequency : 1900.00 MHz
Max. Transmit Pwr : 1 W
Drift Time : 0 min(s)
Length : 151mm
Width : 45mm
Depth : 17.5mm
Power Drift-Start : 0.21 mV
Power Drift-Finish: 0.22 mV
Power Drift : 0.01 mV

Phantom Data

Type : SAM-Right
Size : 280mm x 280mm x 280mm
Location : Right

Tissue Data

Type : Head
Serial No. : 324-H
Frequency : 1900 MHz
Last Calibration Date : 16-Dec-2004
Temperature : 23.6 °C
Ambient Temp. : 24.5 °C
Humidity : 57 RH%
Epsilon : 39.14 F/m
Sigma : 1.44 S/m
Density : 1000 kg/cu. m

Probe Data

Model : E020
Type : E-Field Triangle
Serial No. : 222
Last Calibration Date : 18-Nov-2004
Frequency : 1900 MHz
Duty Cycle Factor: 8
Conversion Factor: 6
Probe Sensitivity: 1.30 1.30 1.30 $\mu\text{V}/(\text{V}/\text{sq. m})$
Compression Point: 95 mV
Offset : 1.56mm

Measurement Data

Crest Factor : 8
DUT Position : Touch
Channel : 810

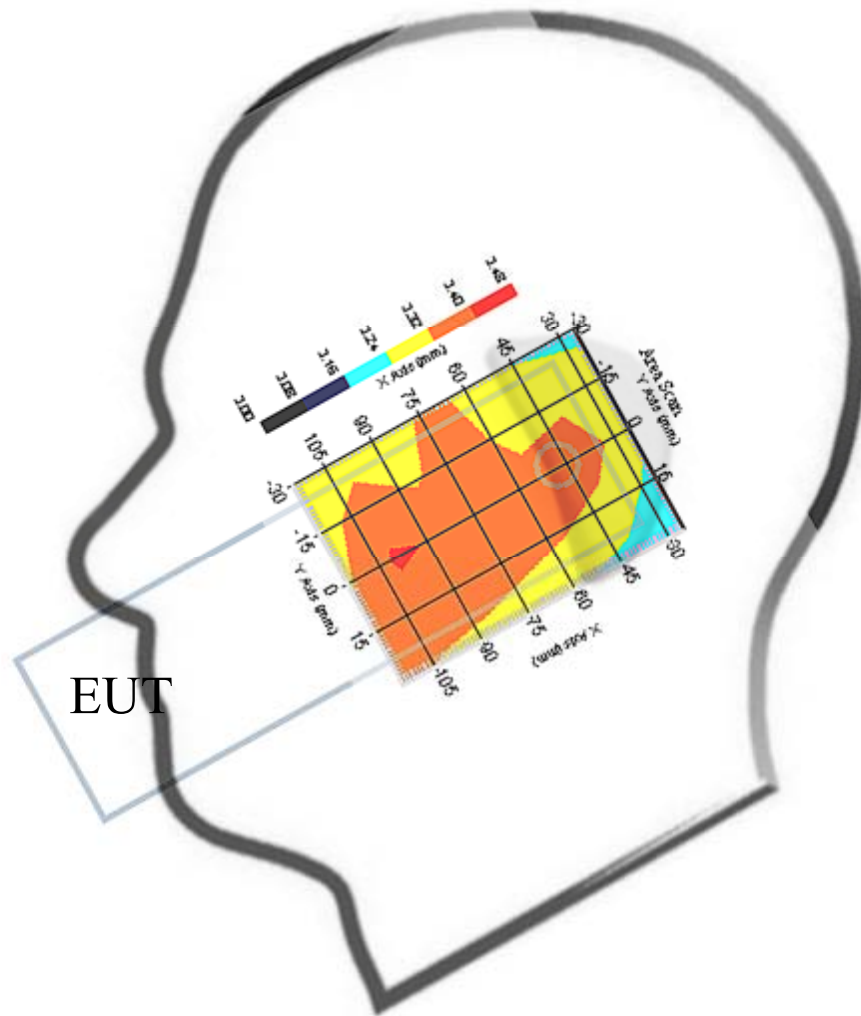

1 gram SAR value : 0.46 W/kg
10 gram SAR value : 0.40 W/kg
Area Scan Peak SAR : 0.41
Zoom Scan Peak SAR : 0.54

This is previous page plot (zoom in)

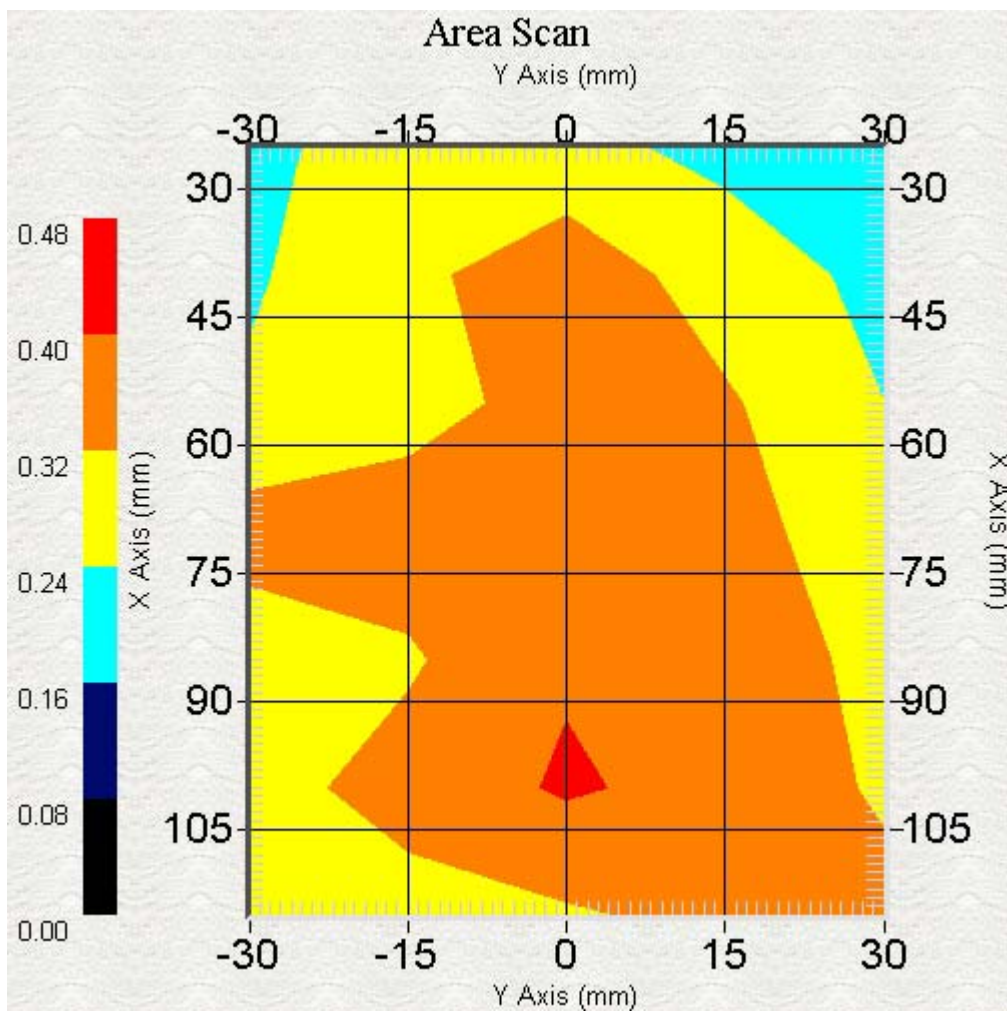

ALSAS-10U VER 1.5.14APREL Laboratories
SAR Test Report

Validation Date : 16-Dec-2004
Measurement Date : 16-Dec-2004

Product Data

Device Name : Dbtel_J9
Model : J9
Frequency : 1900.00 MHz
Max. Transmit Pwr : 1 W
Drift Time : 0 min(s)
Length : 151mm
Width : 45mm
Depth : 17.5mm
Power Drift-Start : 0.09 mV
Power Drift-Finish: 0.10 mV
Power Drift : 0.01 mV

Phantom Data

Type : SAM-Right
Size : 280mm x 280mm x 280mm
Location : Right

Tissue Data

Type : Head
Serial No. : 324-H
Frequency : 1900 MHz
Last Calibration Date : 16-Dec-2004
Temperature : 23.6 °C
Ambient Temp. : 24.5 °C
Humidity : 57 RH%
Epsilon : 39.14 F/m
Sigma : 1.44 S/m
Density : 1000 kg/cu. m

Probe Data

Model : E020
Type : E-Field Triangle
Serial No. : 222
Last Calibration Date : 18-Nov-2004
Frequency : 1900 MHz
Duty Cycle Factor: 8
Conversion Factor: 6
Probe Sensitivity: 1.30 1.30 1.30 $\mu\text{V}/(\text{V}/\text{sq. m})$
Compression Point: 95 mV
Offset : 1.56mm

Measurement Data

Crest Factor : 8
DUT Position : 15° Tilt
Channel : 512

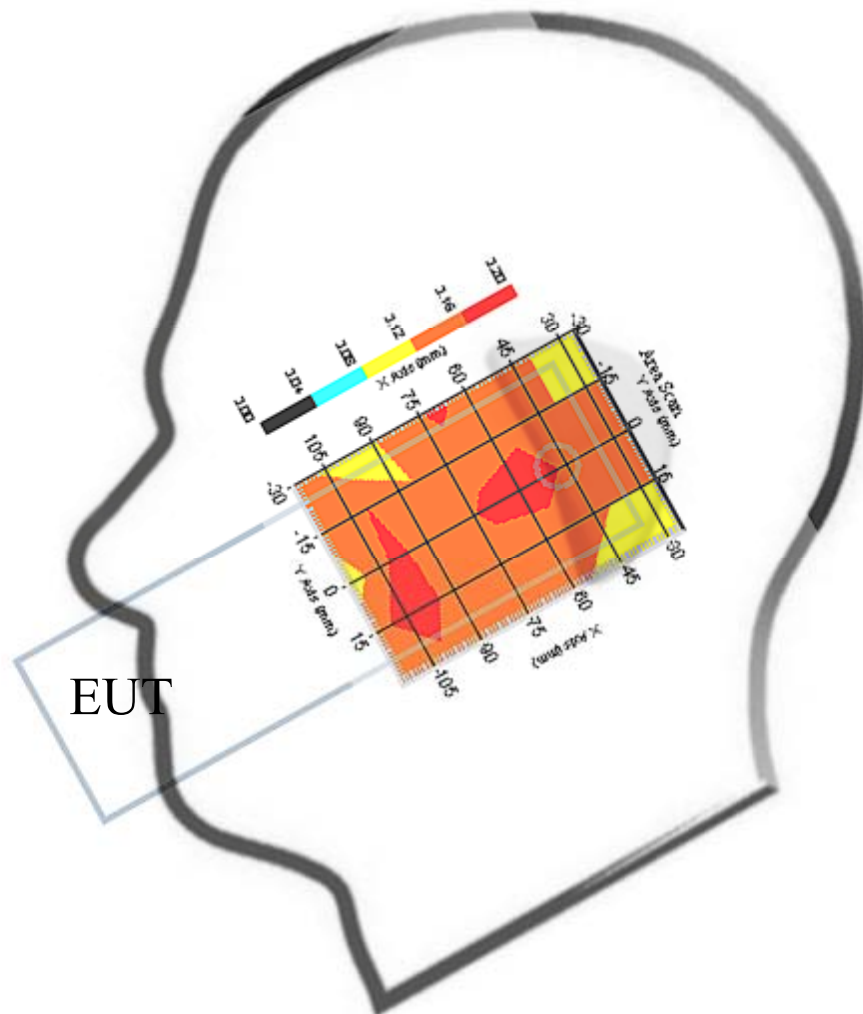

1 gram SAR value : 0.17 W/kg
10 gram SAR value : 0.15 W/kg
Area Scan Peak SAR : 0.18
Zoom Scan Peak SAR : 0.20
This is previous page plot (zoom in)

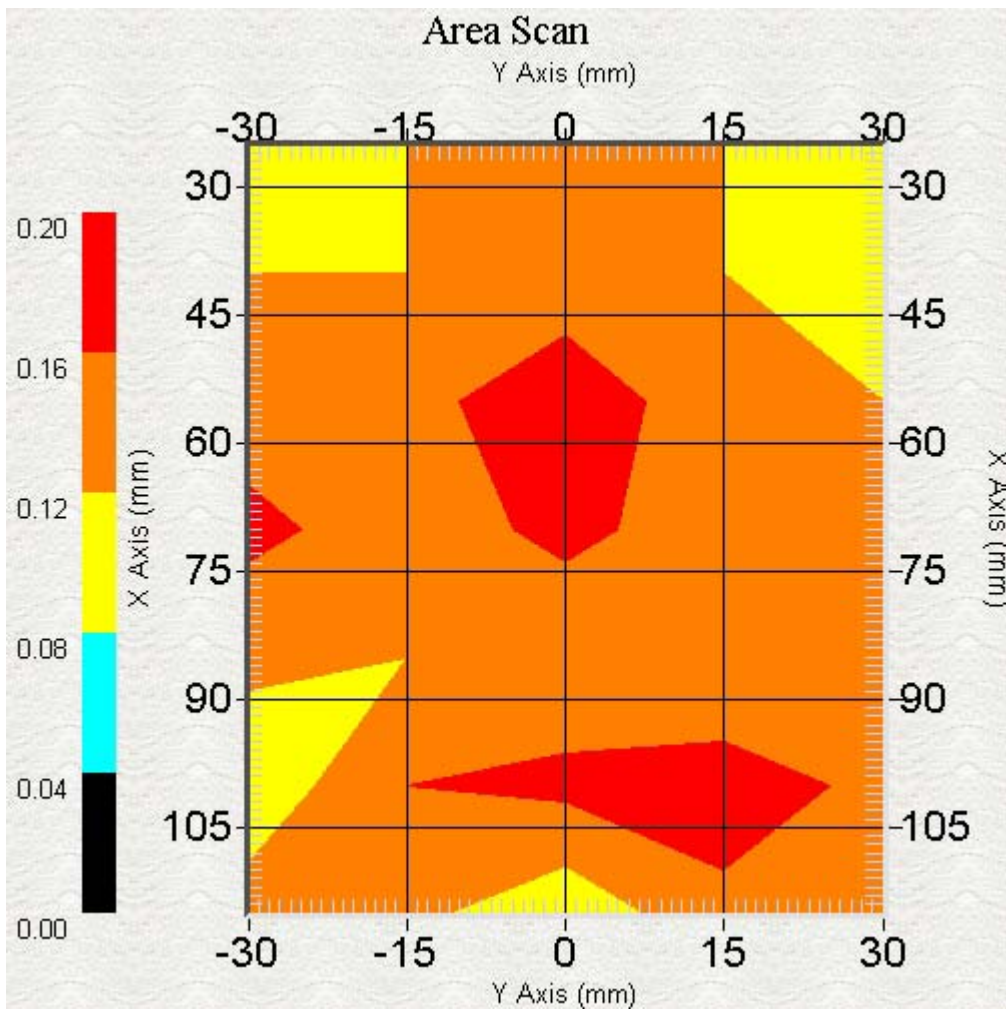

ALSAS-10U VER 1.5.14APREL Laboratories SAR Test Report

Validation Date : 16-Dec-2004
Measurement Date : 16-Dec-2004

Product Data

Device Name : Dbtel_J9
Model : J9
Frequency : 1900.00 MHz
Max. Transmit Pwr : 1 W
Drift Time : 0 min(s)
Length : 151mm
Width : 45mm
Depth : 17.5mm
Power Drift-Start : 0.07 mV
Power Drift-Finish: 0.10 mV
Power Drift : 0.03 mV

Phantom Data

Type : SAM-Right
Size : 280mm x 280mm x 280mm
Location : Right

Tissue Data

Type : Head
Serial No. : 324-H
Frequency : 1900 MHz
Last Calibration Date : 16-Dec-2004
Temperature : 23.6 °C
Ambient Temp. : 24.5 °C
Humidity : 57 RH%
Epsilon : 39.14 F/m
Sigma : 1.44 S/m
Density : 1000 kg/cu. m

Probe Data

Model : E020
Type : E-Field Triangle
Serial No. : 222
Last Calibration Date : 18-Nov-2004
Frequency : 1900 MHz
Duty Cycle Factor: 8
Conversion Factor: 6
Probe Sensitivity: 1.30 1.30 1.30 $\mu\text{V}/(\text{V}/\text{sq. m})$
Compression Point: 95 mV
Offset : 1.56mm

Measurement Data

Crest Factor : 8
DUT Position : 15° Tilt
Channel : 661

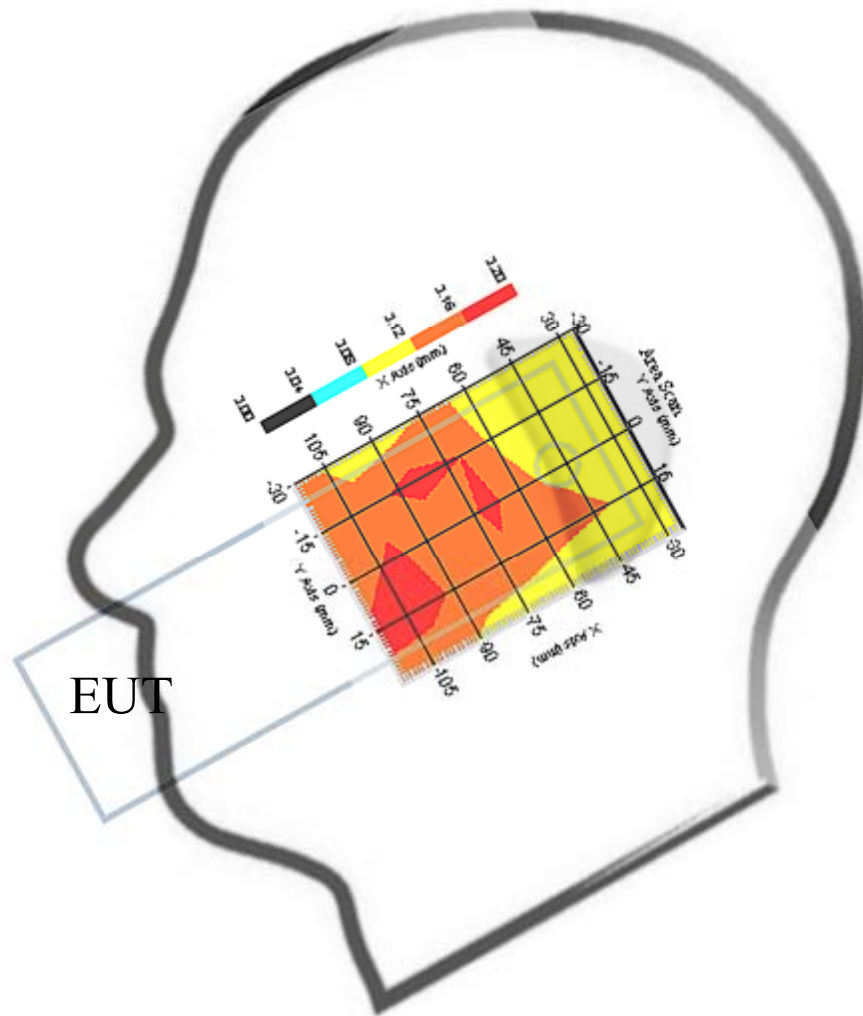

1 gram SAR value : 0.23 W/kg
10 gram SAR value : 0.19 W/kg
Area Scan Peak SAR : 0.18
Zoom Scan Peak SAR : 0.30

This is previous page plot (zoom in)

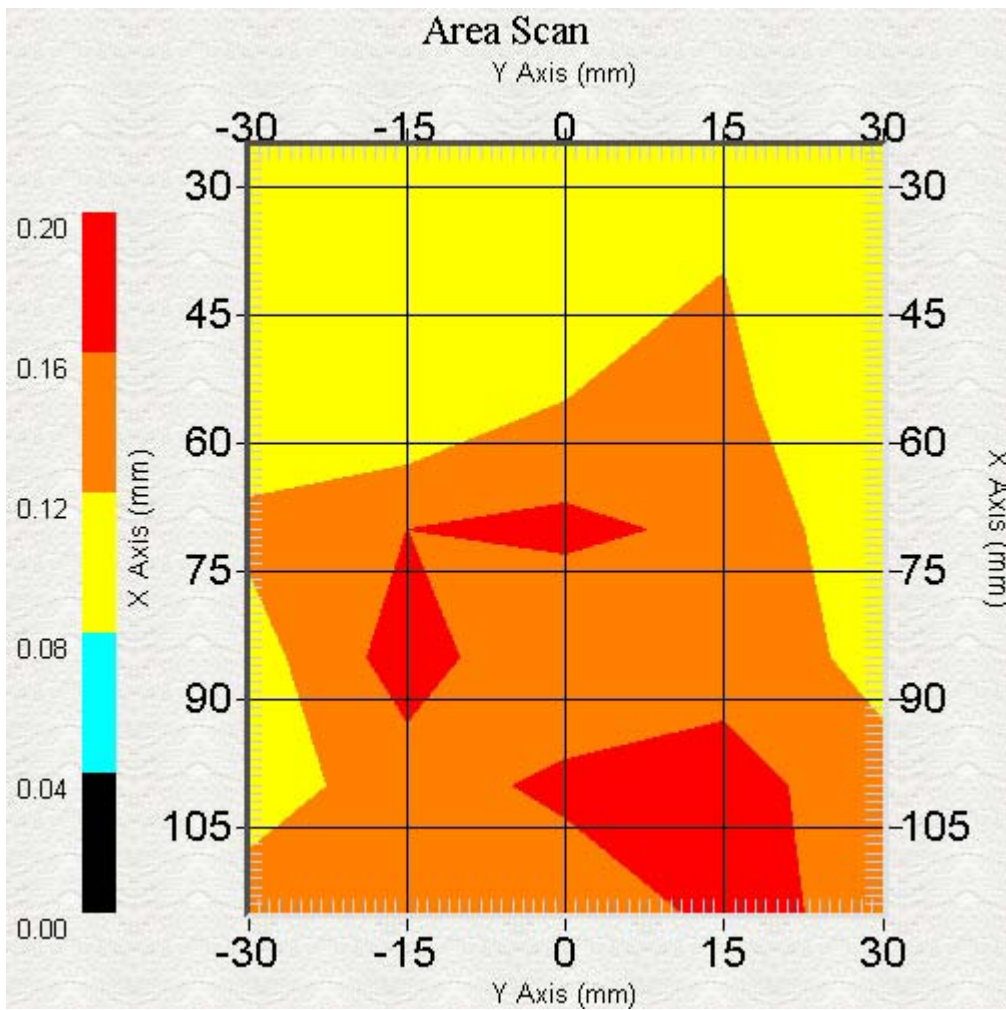

ALSAS-10U VER 1.5.14APREL Laboratories
SAR Test Report

Validation Date : 16-Dec-2004
Measurement Date : 16-Dec-2004

Product Data

Device Name : Dbtel_J9
Model : J9
Frequency : 1900.00 MHz
Max. Transmit Pwr : 1 W
Drift Time : 0 min(s)
Length : 151mm
Width : 45mm
Depth : 17.5mm
Power Drift-Start : 0.16 mV
Power Drift-Finish: 0.14 mV
Power Drift : 0.02 mV

Phantom Data

Type : SAM-Right
Size : 280mm x 280mm x 280mm
Location : Right

Tissue Data

Type : Head
Serial No. : 324-H
Frequency : 1900 MHz
Last Calibration Date : 16-Dec-2004
Temperature : 23.6 °C
Ambient Temp. : 24.5 °C
Humidity : 57 RH%
Epsilon : 39.14 F/m
Sigma : 1.44 S/m
Density : 1000 kg/cu. m

Probe Data

Model : E020
Type : E-Field Triangle
Serial No. : 222
Last Calibration Date : 18-Nov-2004
Frequency : 1900 MHz
Duty Cycle Factor: 8
Conversion Factor: 6
Probe Sensitivity: 1.30 1.30 1.30 $\mu\text{V}/(\text{V}/\text{sq. m})$
Compression Point: 95 mV
Offset : 1.56mm

Measurement Data

Crest Factor : 8
DUT Position : 15° Tilt
Channel : 810

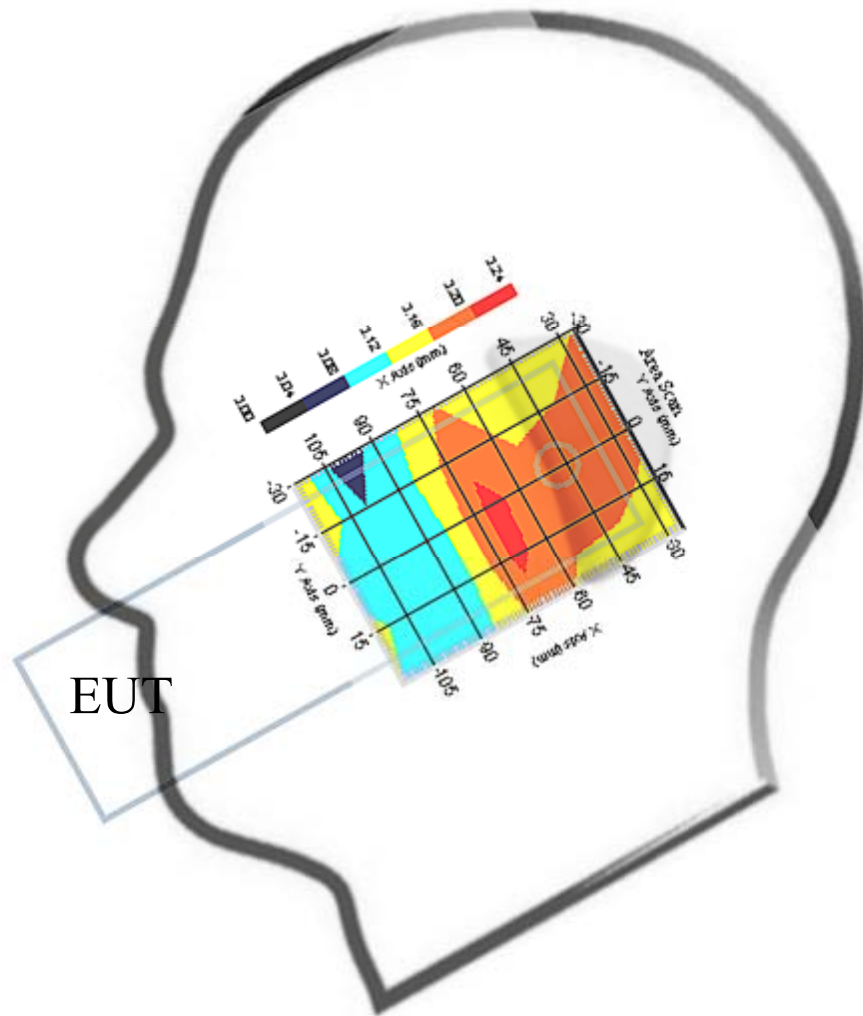

1 gram SAR value : 0.19 W/kg
10 gram SAR value : 0.16 W/kg
Area Scan Peak SAR : 0.21
Zoom Scan Peak SAR : 0.19

This is previous page plot (zoom in)

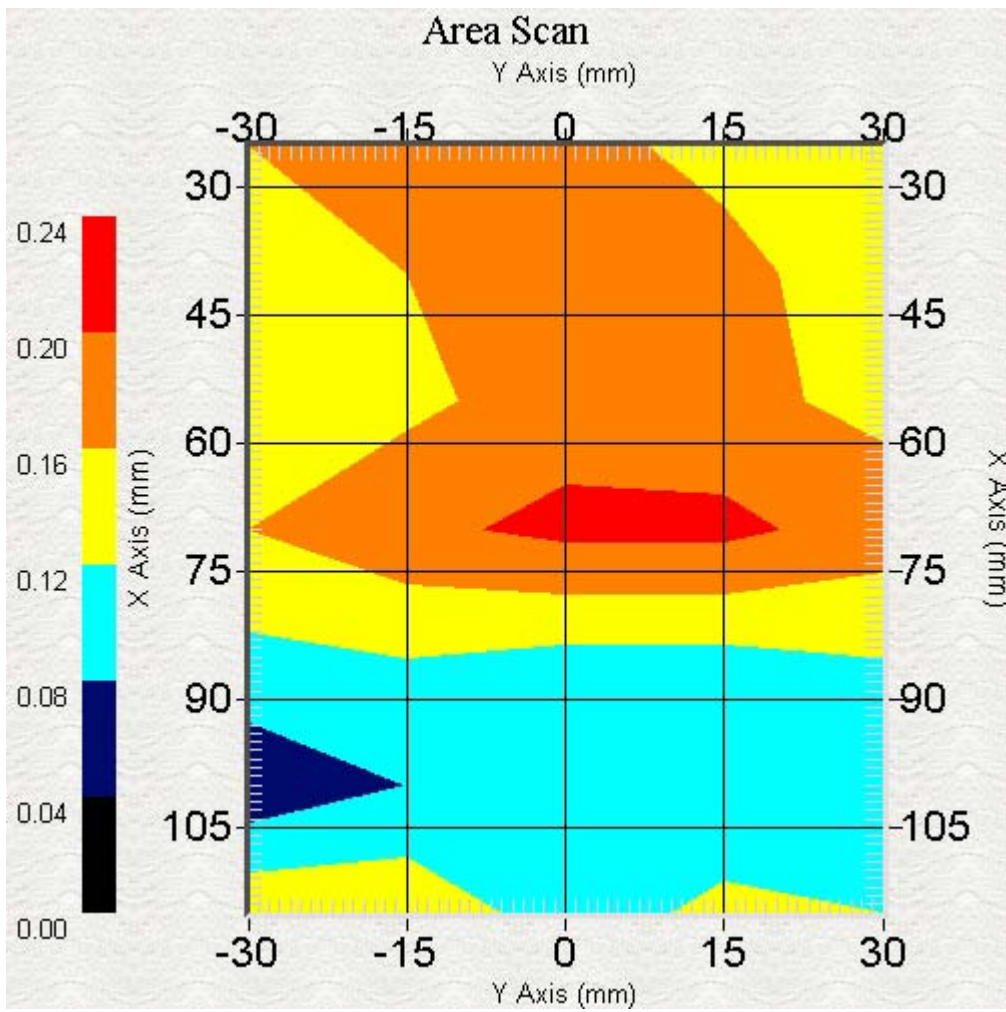

ALSAS-10U VER 1.5.14APREL Laboratories
SAR Test ReportValidation Date : 16-Dec-2004
Measurement Date : 16-Dec-2004

Product Data

Device Name : Dbtel_J9
Model : J9
Frequency : 1900.00 MHz
Max. Transmit Pwr : 1 W
Drift Time : 0 min(s)
Length : 151mm
Width : 45mm
Depth : 17.5mm
Power Drift-Start : 0.10 mV
Power Drift-Finish: 0.09 mV
Power Drift : 0.01 mV

Phantom Data

Type : SAM-Left
Size : 280mm x 280mm x 280mm
Location : Left

Tissue Data

Type : Head
Serial No. : 324-H
Frequency : 1900 MHz
Last Calibration Date : 16-Dec-2004
Temperature : 23.6 °C
Ambient Temp. : 24.5 °C
Humidity : 57 RH%
Epsilon : 39.14 F/m
Sigma : 1.44 S/m
Density : 1000 kg/cu. m

Probe Data

Model : E020
Type : E-Field Triangle
Serial No. : 222
Last Calibration Date : 18-Nov-2004
Frequency : 1900 MHz
Duty Cycle Factor: 8
Conversion Factor: 6
Probe Sensitivity: 1.30 1.30 1.30 $\mu\text{V}/(\text{V}/\text{sq. m})$
Compression Point: 95 mV
Offset : 1.56mm

Measurement Data

Crest Factor : 8
DUT Position : Touch
Channel : 512

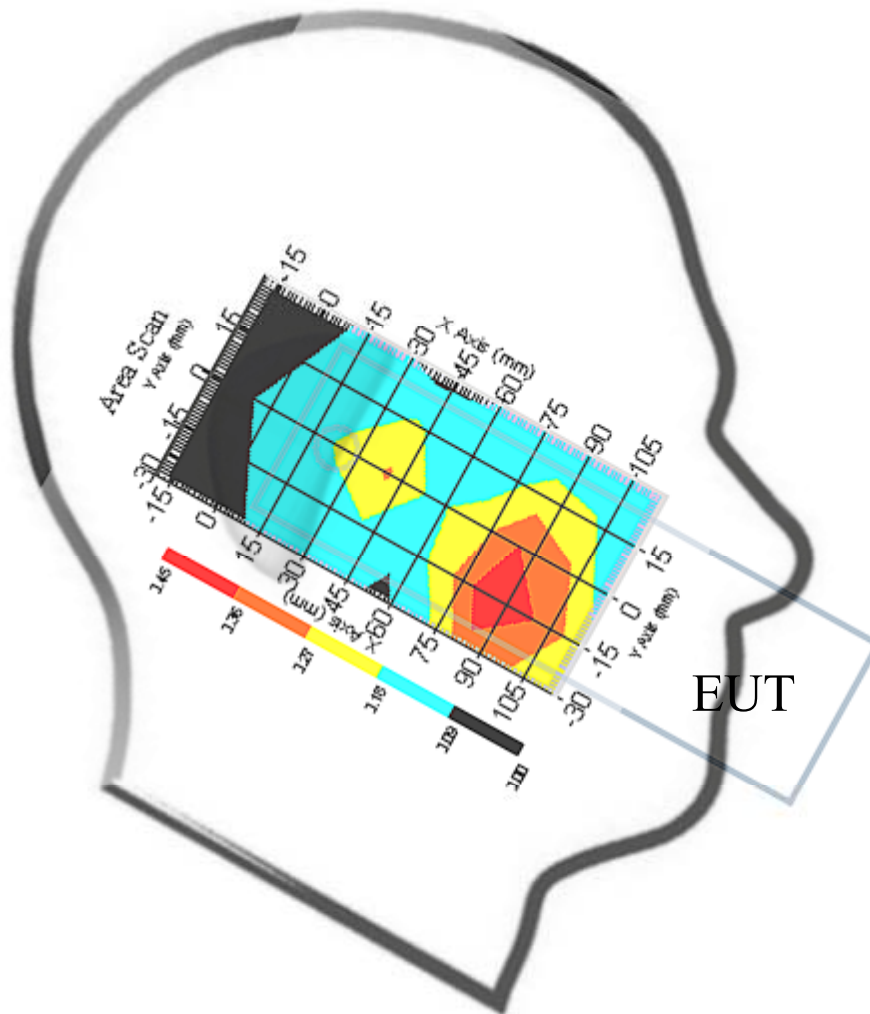

1 gram SAR value : 0.38 W/kg
10 gram SAR value : 0.27 W/kg
Area Scan Peak SAR : 0.45
Zoom Scan Peak SAR : 0.65

This is previous page plot (zoom in)

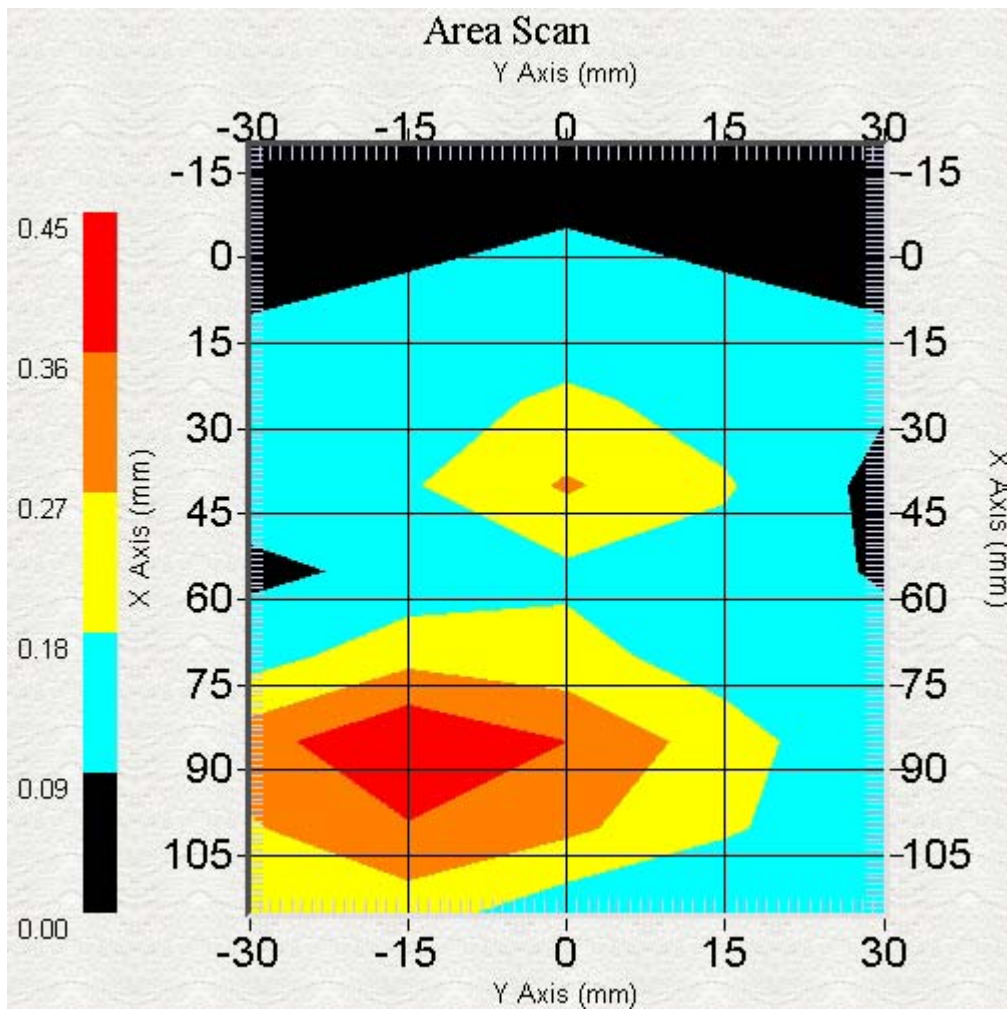

ALSAS-10U VER 1.5.14APREL Laboratories
SAR Test ReportValidation Date : 16-Dec-2004
Measurement Date : 16-Dec-2004

Product Data

Device Name : Dbtel_J9
Model : J9
Frequency : 1900.00 MHz
Max. Transmit Pwr : 1 W
Drift Time : 0 min(s)
Length : 151mm
Width : 45mm
Depth : 17.5mm
Power Drift-Start : 0.26 mV
Power Drift-Finish: 0.24 mV
Power Drift : 0.02 mV

Phantom Data

Type : SAM-Left
Size : 280mm x 280mm x 280mm
Location : Left

Tissue Data

Type : Head
Serial No. : 324-H
Frequency : 1900 MHz
Last Calibration Date : 16-Dec-2004
Temperature : 23.6 °C
Ambient Temp. : 24.5 °C
Humidity : 57 RH%
Epsilon : 39.14 F/m
Sigma : 1.44 S/m
Density : 1000 kg/cu. m

Probe Data

Model : E020
Type : E-Field Triangle
Serial No. : 222
Last Calibration Date : 18-Nov-2004
Frequency : 1900 MHz
Duty Cycle Factor: 8
Conversion Factor: 6
Probe Sensitivity: 1.30 1.30 1.30 $\mu\text{V}/(\text{V}/\text{sq. m})$
Compression Point: 95 mV
Offset : 1.56mm

Measurement Data

Crest Factor : 8
 DUT Position : Touch
 Channel : 661

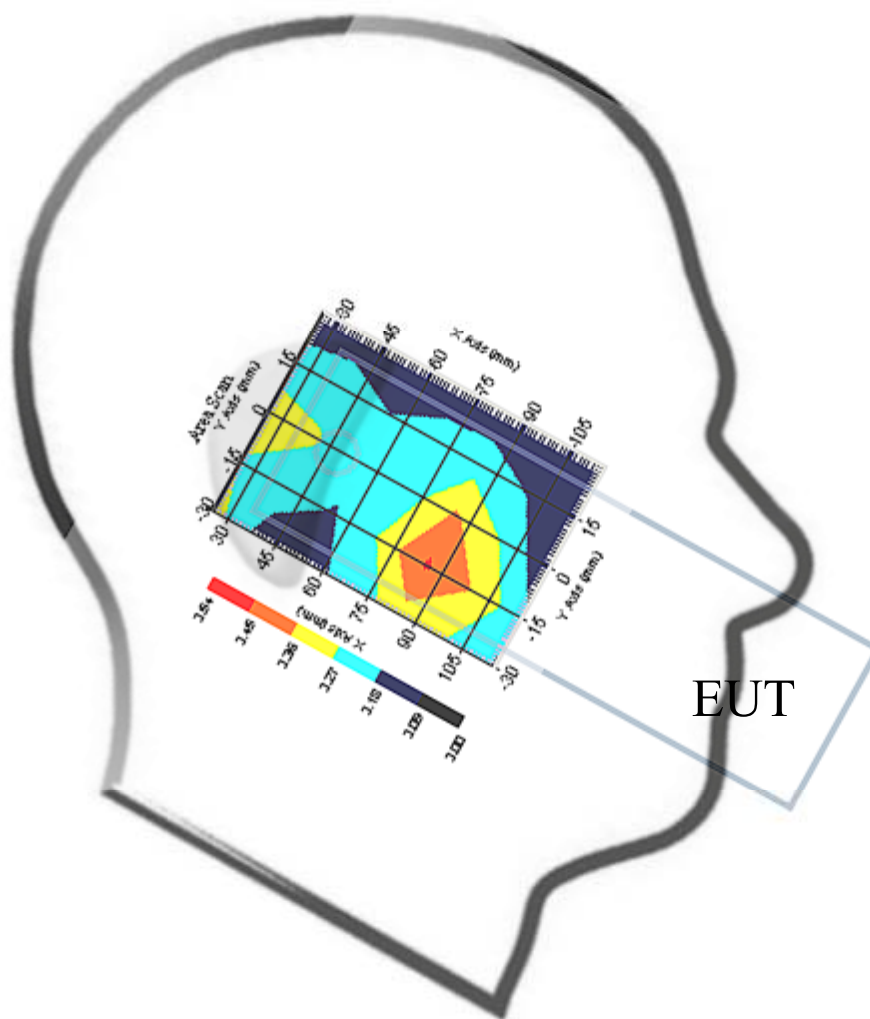

1 gram SAR value : 0.43 W/kg
 10 gram SAR value : 0.29 W/kg
 Area Scan Peak SAR : 0.46
 Zoom Scan Peak SAR : 0.70

This is previous page plot (zoom in)

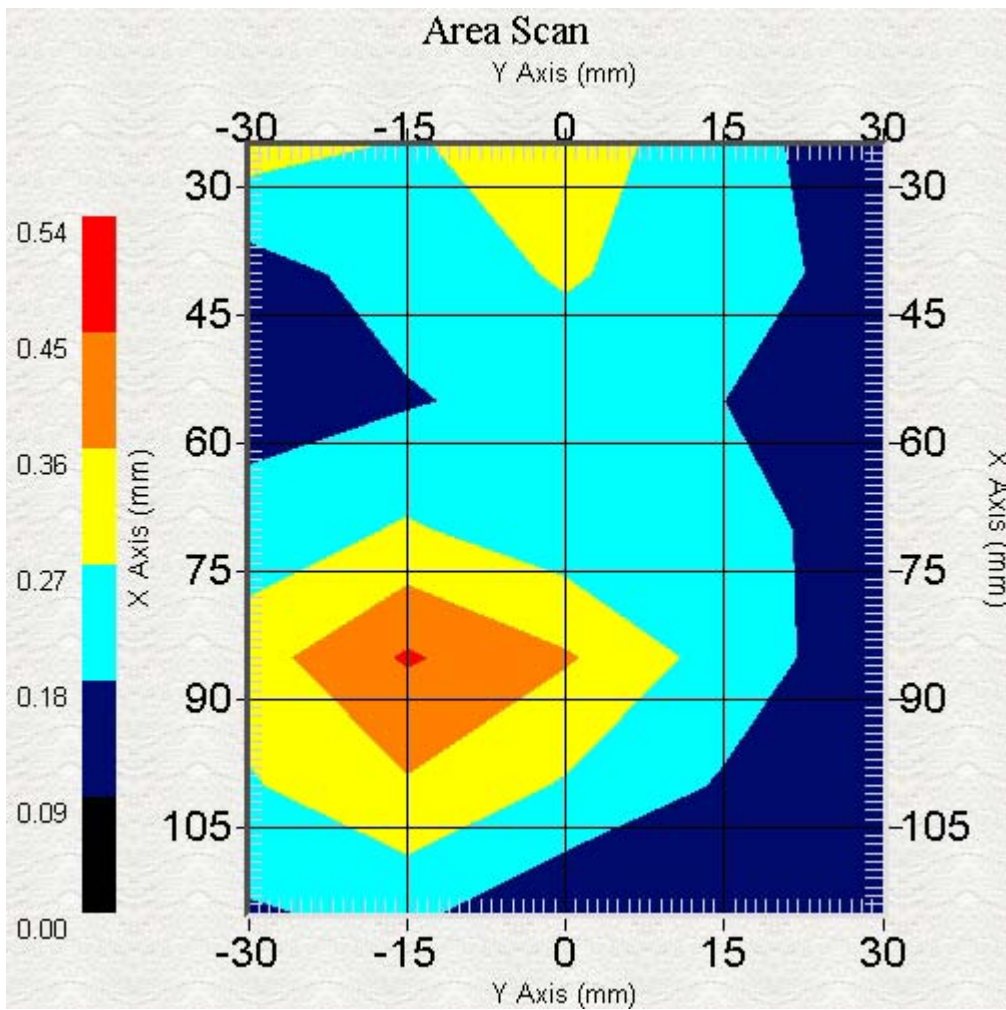

ALSAS-10U VER 1.5.14APREL Laboratories
SAR Test Report

Validation Date : 16-Dec-2004
Measurement Date : 16-Dec-2004

Product Data

Device Name : Dbtel_J9
Model : J9
Frequency : 1900.00 MHz
Max. Transmit Pwr : 1 W
Drift Time : 0 min(s)
Length : 151mm
Width : 45mm
Depth : 17.5mm
Power Drift-Start : 0.22 mV
Power Drift-Finish: 0.24 mV
Power Drift : 0.02 mV

Phantom Data

Type : SAM-Left
Size : 280mm x 280mm x 280mm
Location : Left

Tissue Data

Type : Head
Serial No. : 324-H
Frequency : 1900 MHz
Last Calibration Date : 16-Dec-2004
Temperature : 23.6 °C
Ambient Temp. : 24.5 °C
Humidity : 57 RH%
Epsilon : 39.14 F/m
Sigma : 1.44 S/m
Density : 1000 kg/cu. m

Probe Data

Model : E020
Type : E-Field Triangle
Serial No. : 222
Last Calibration Date : 18-Nov-2004
Frequency : 1900 MHz
Duty Cycle Factor: 8
Conversion Factor: 6
Probe Sensitivity: 1.30 1.30 1.30 $\mu\text{V}/(\text{V}/\text{sq. m})$
Compression Point: 95 mV
Offset : 1.56mm

Measurement Data

Crest Factor : 8
DUT Position : Touch
Channel : 810

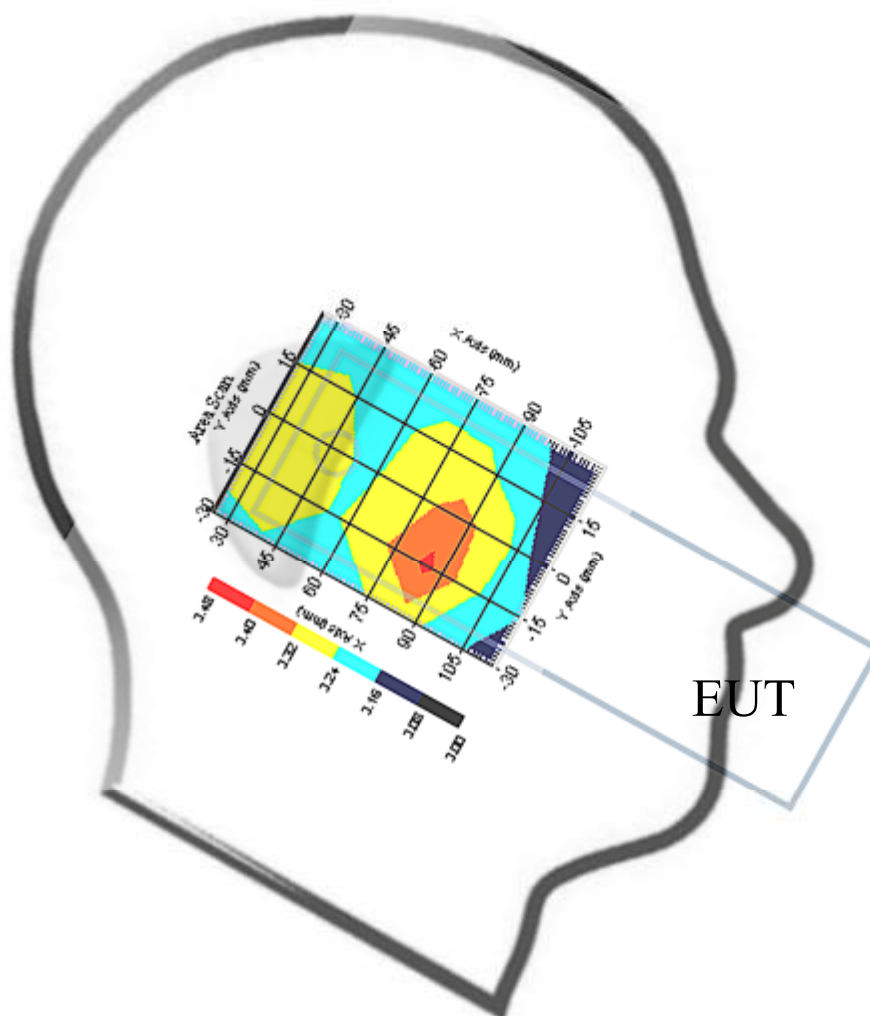

1 gram SAR value : 0.36 W/kg
10 gram SAR value : 0.25 W/kg
Area Scan Peak SAR : 0.42
Zoom Scan Peak SAR : 0.52

This is previous page plot (zoom in)

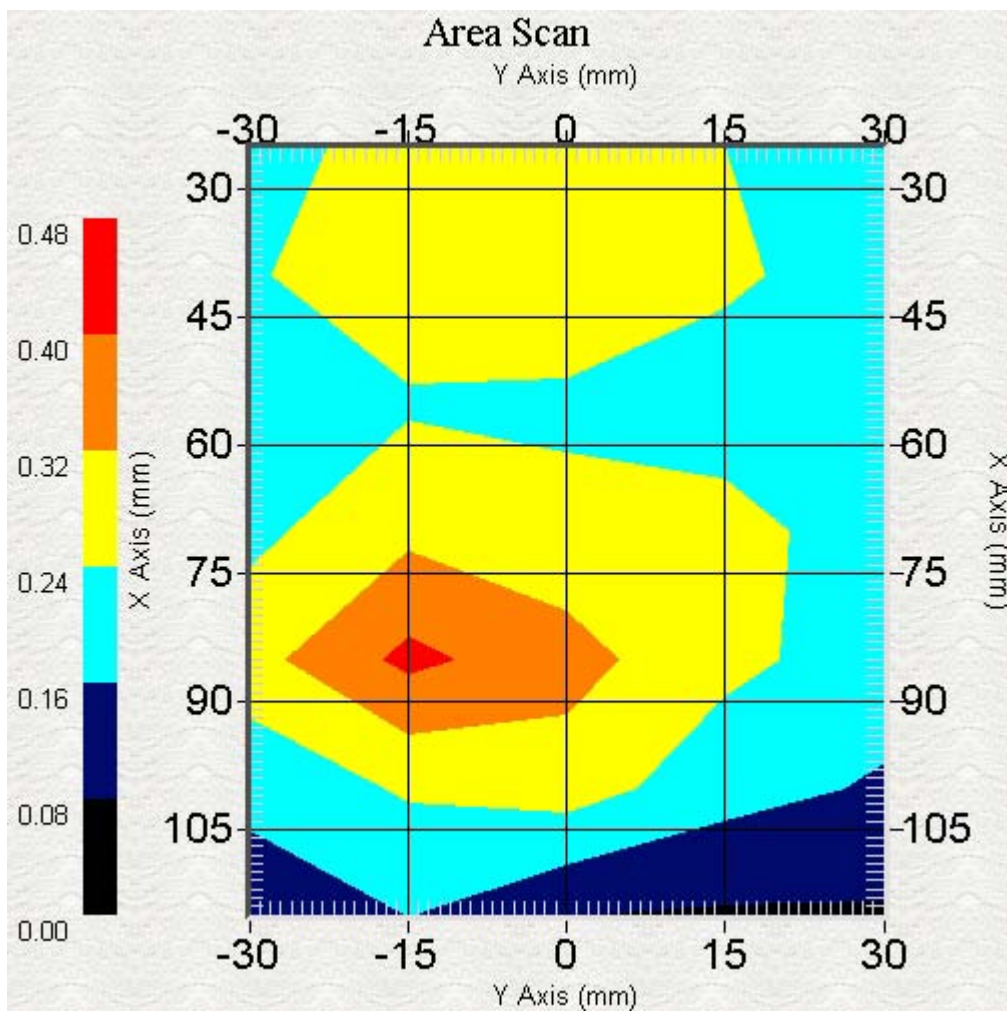

ALSAS-10U VER 1.5.14APREL Laboratories
SAR Test Report

Validation Date : 16-Dec-2004
Measurement Date : 16-Dec-2004

Product Data

Device Name : Dbtel_J9
Model : J9
Frequency : 1900.00 MHz
Max. Transmit Pwr : 1 W
Drift Time : 0 min(s)
Length : 151mm
Width : 45mm
Depth : 17.5mm
Power Drift-Start : 0.08 mV
Power Drift-Finish: 0.10 mV
Power Drift : 0.02 mV

Phantom Data

Type : SAM-Left
Size : 280mm x 280mm x 280mm
Location : Left

Tissue Data

Type : Head
Serial No. : 324-H
Frequency : 1900 MHz
Last Calibration Date : 16-Dec-2004
Temperature : 23.6 °C
Ambient Temp. : 24.5 °C
Humidity : 57 RH%
Epsilon : 39.14 F/m
Sigma : 1.44 S/m
Density : 1000 kg/cu. m

Probe Data

Model : E020
Type : E-Field Triangle
Serial No. : 222
Last Calibration Date : 18-Nov-2004
Frequency : 1900 MHz
Duty Cycle Factor: 8
Conversion Factor: 6
Probe Sensitivity: 1.30 1.30 1.30 $\mu\text{V}/(\text{V}/\text{sq. m})$
Compression Point: 95 mV
Offset : 1.56mm

Measurement Data

Crest Factor : 8
 DUT Position : 15° Tilt
 Channel : 512

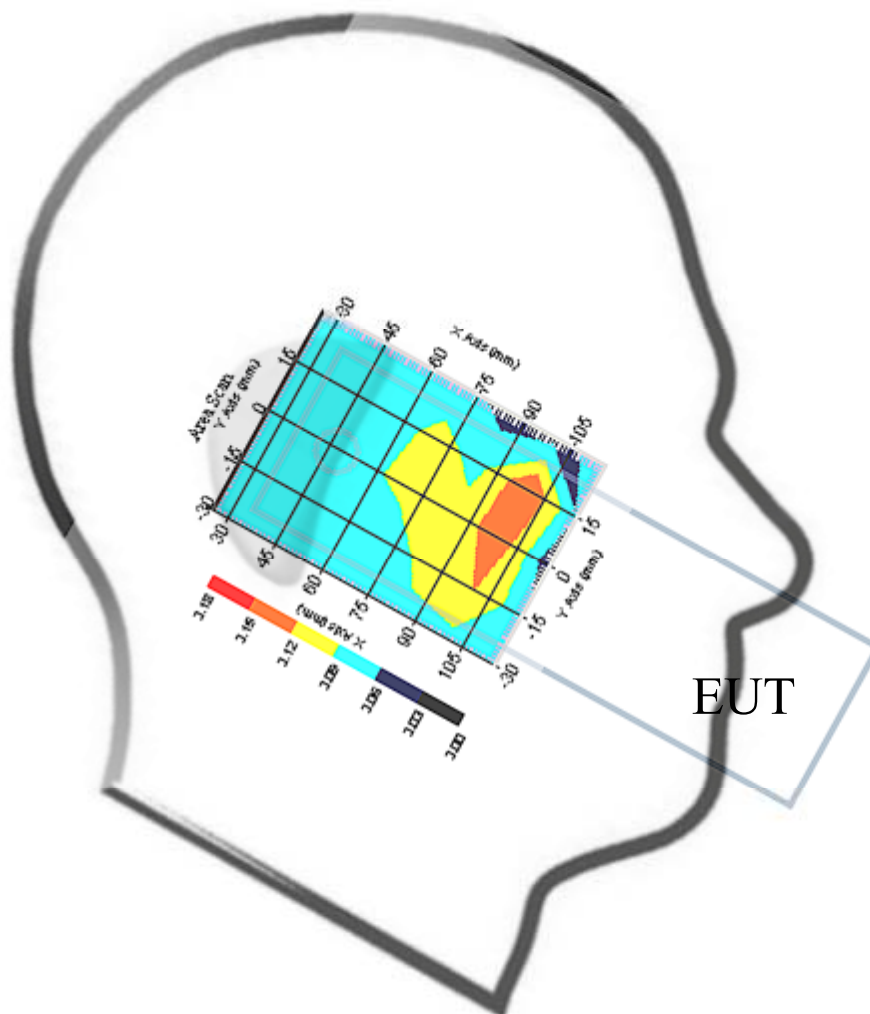

1 gram SAR value : 0.13 W/kg
 10 gram SAR value : 0.11 W/kg
 Area Scan Peak SAR : 0.15
 Zoom Scan Peak SAR : 0.17

This is previous page plot (zoom in)

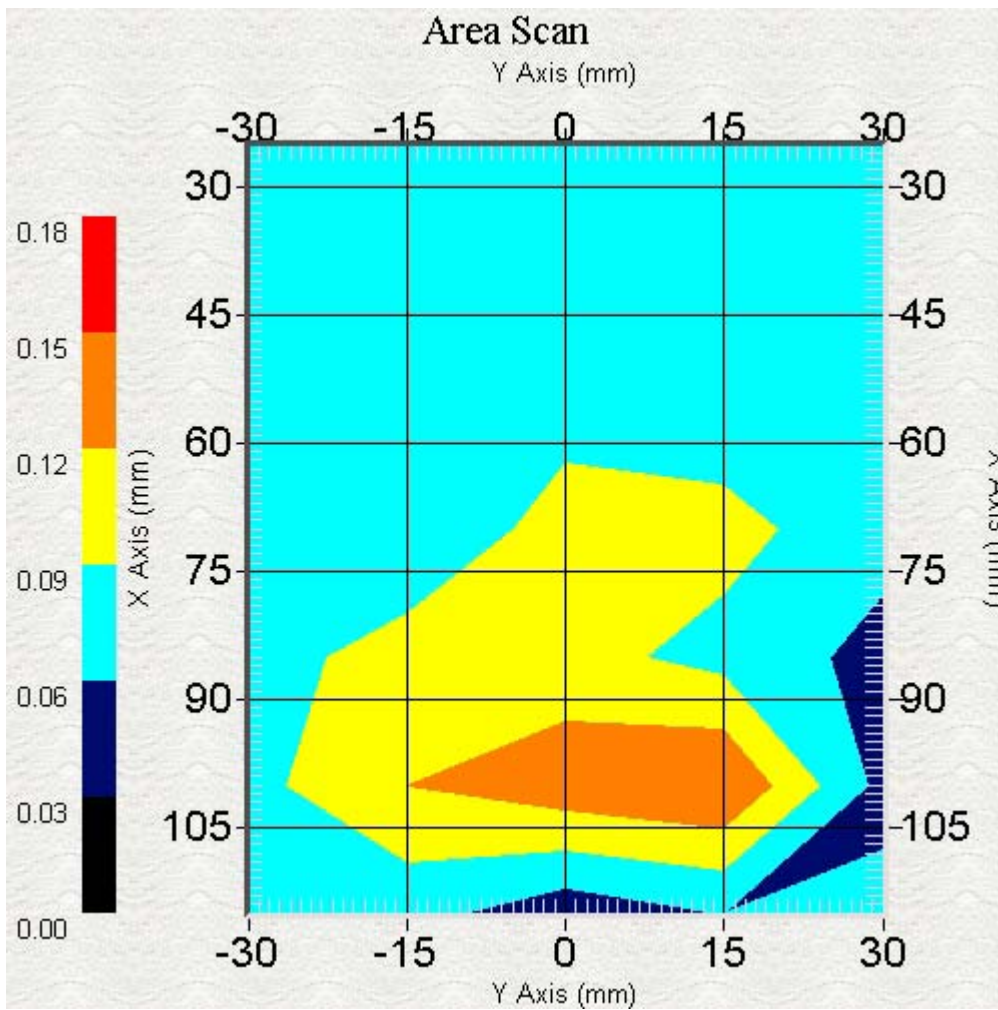

ALSAS-10U VER 1.5.14APREL Laboratories SAR Test Report

Validation Date : 16-Dec-2004
Measurement Date : 16-Dec-2004

Product Data

Device Name : Dbtel_J9
Model : J9
Frequency : 1900.00 MHz
Max. Transmit Pwr : 1 W
Drift Time : 0 min(s)
Length : 151mm
Width : 45mm
Depth : 17.5mm
Power Drift-Start : 0.09 mV
Power Drift-Finish: 0.07 mV
Power Drift : 0.02 mV

Phantom Data

Type : SAM-Left
Size : 280mm x 280mm x 280mm
Location : Left

Tissue Data

Type : Head
Serial No. : 324-H
Frequency : 1900 MHz
Last Calibration Date : 16-Dec-2004
Temperature : 23.6 °C
Ambient Temp. : 24.5 °C
Humidity : 57 RH%
Epsilon : 39.14 F/m
Sigma : 1.44 S/m
Density : 1000 kg/cu. m

Probe Data

Model : E020
Type : E-Field Triangle
Serial No. : 222
Last Calibration Date : 18-Nov-2004
Frequency : 1900 MHz
Duty Cycle Factor: 8
Conversion Factor: 6
Probe Sensitivity: 1.30 1.30 1.30 $\mu\text{V}/(\text{V}/\text{sq. m})$
Compression Point: 95 mV
Offset : 1.56mm

Measurement Data

Crest Factor : 8
DUT Position : 15° Tilt
Channel : 661

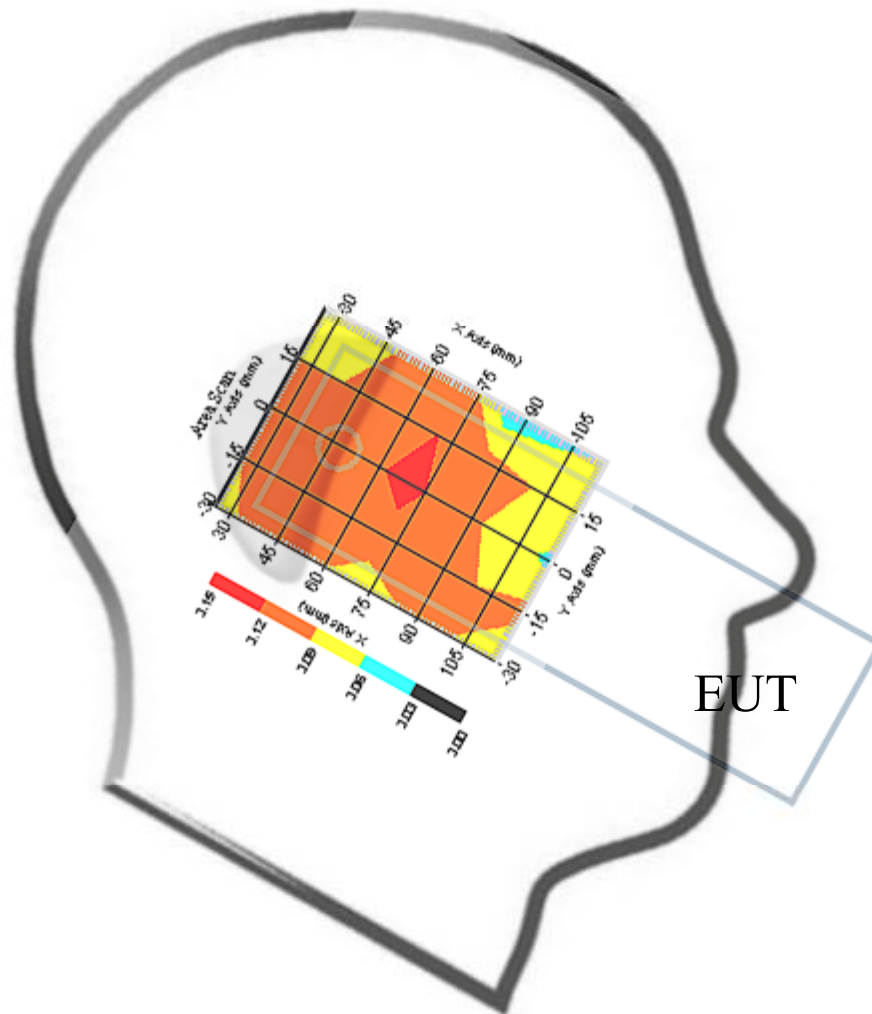

1 gram SAR value : 0.11 W/kg
10 gram SAR value : 0.09 W/kg
Area Scan Peak SAR : 0.13
Zoom Scan Peak SAR : 0.17

This is previous page plot (zoom in)

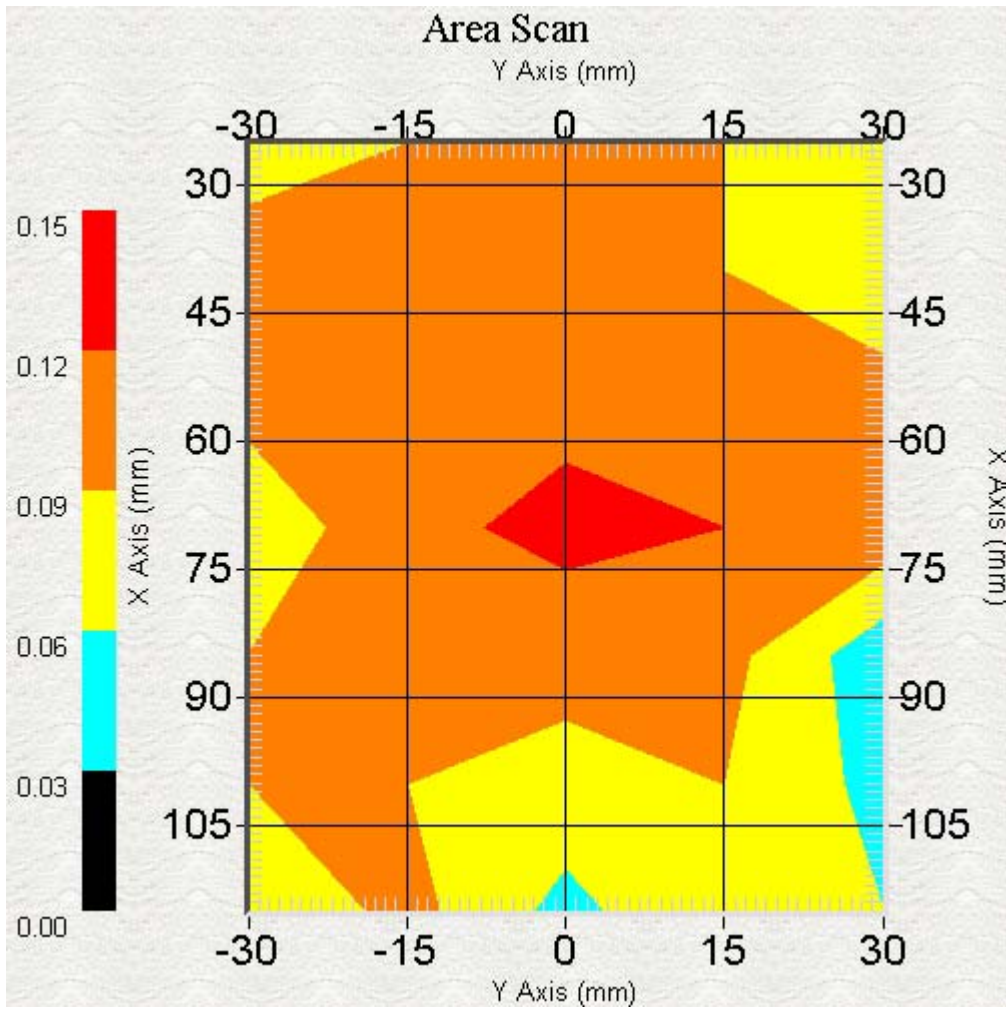

ALSAS-10U VER 1.5.14APREL Laboratories
SAR Test Report

Validation Date : 16-Dec-2004
Measurement Date : 16-Dec-2004

Product Data

Device Name : Dbtel_J9
Model : J9
Frequency : 1900.00 MHz
Max. Transmit Pwr : 1 W
Drift Time : 0 min(s)
Length : 151mm
Width : 45mm
Depth : 17.5mm
Power Drift-Start : 0.07 mV
Power Drift-Finish: 0.10 mV
Power Drift : 0.03 mV

Phantom Data

Type : SAM-Left
Size : 280mm x 280mm x 280mm
Location : Left

Tissue Data

Type : Head
Serial No. : 324-H
Frequency : 1900 MHz
Last Calibration Date : 16-Dec-2004
Temperature : 23.6 °C
Ambient Temp. : 24.5 °C
Humidity : 57 RH%
Epsilon : 39.14 F/m
Sigma : 1.44 S/m
Density : 1000 kg/cu. m

Probe Data

Model : E020
Type : E-Field Triangle
Serial No. : 222
Last Calibration Date : 18-Nov-2004
Frequency : 1900 MHz
Duty Cycle Factor: 8
Conversion Factor: 6
Probe Sensitivity: 1.30 1.30 1.30 $\mu\text{V}/(\text{V}/\text{sq. m})$
Compression Point: 95 mV
Offset : 1.56mm

Measurement Data

Crest Factor : 8
DUT Position : 15° Tilt
Channel : 810

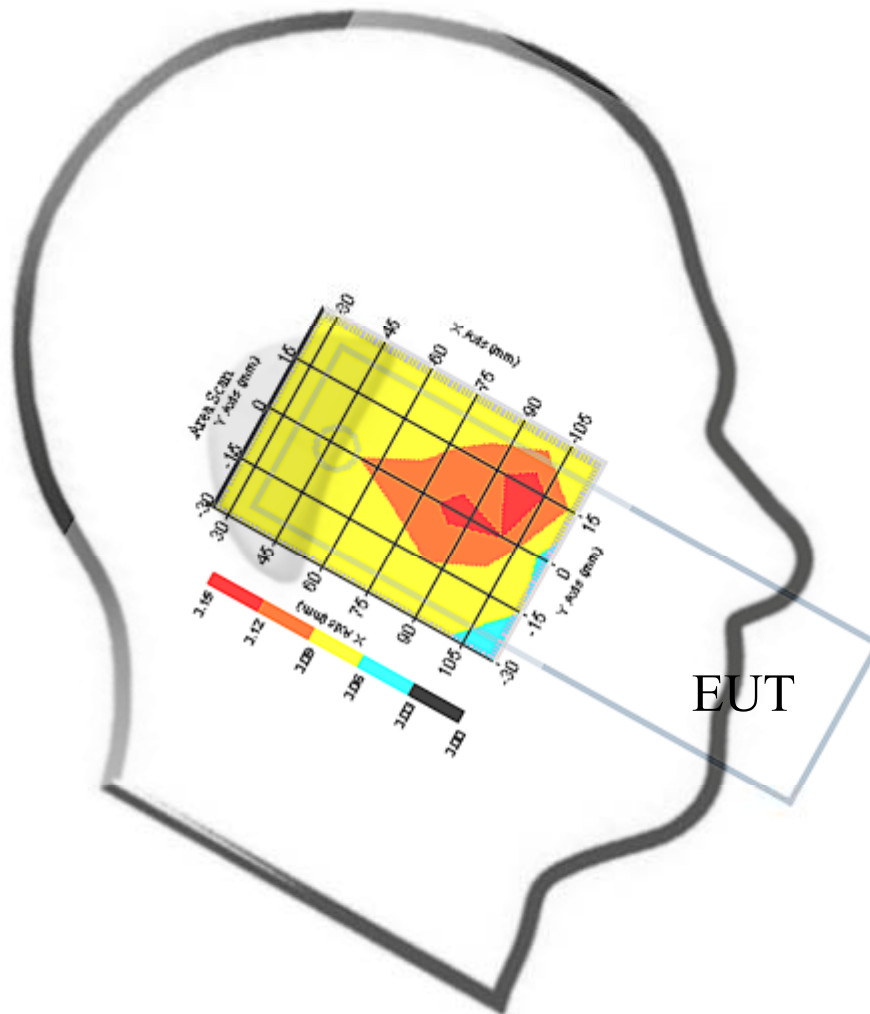

1 gram SAR value : 0.14 W/kg
10 gram SAR value : 0.11 W/kg
Area Scan Peak SAR : 0.14
Zoom Scan Peak SAR : 0.18

This is previous page plot (zoom in)

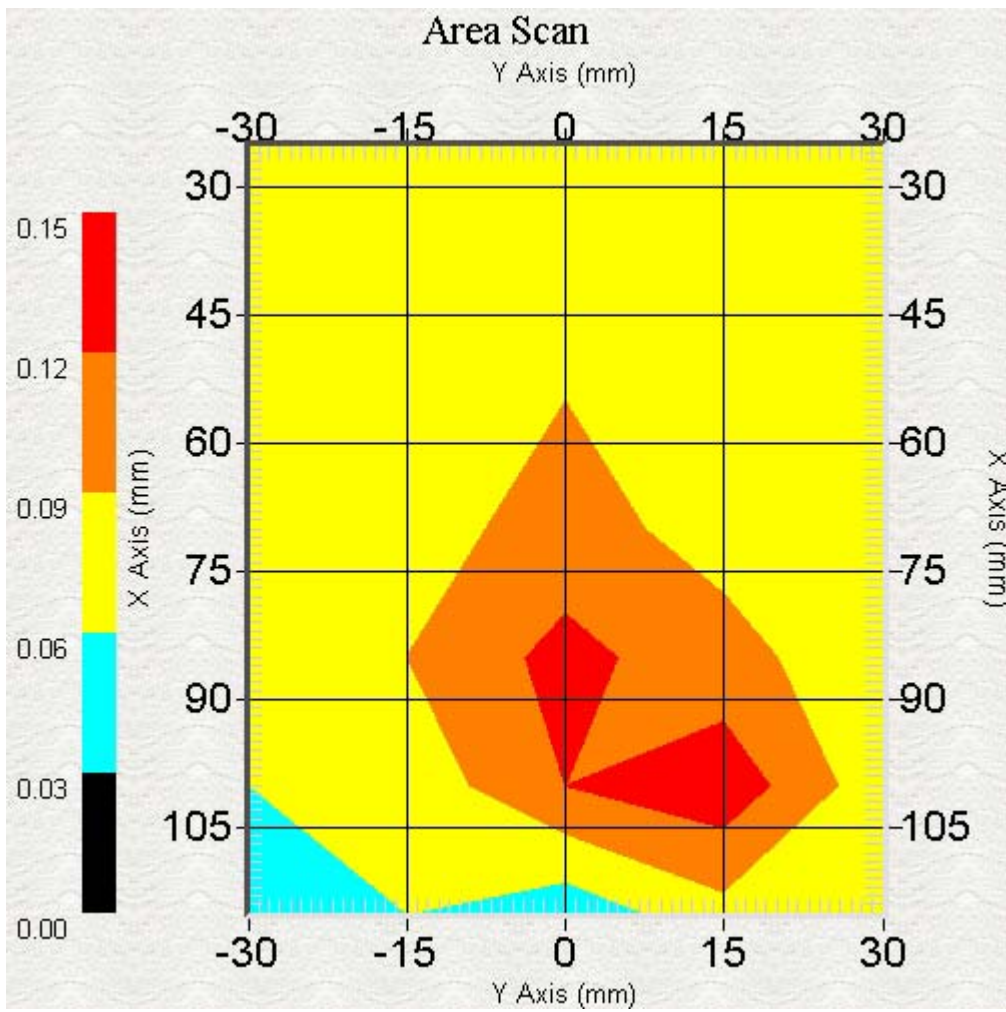

ALSAS-10U VER 1.5.14APREL Laboratories
SAR Test Report

Validation Date : 16-Dec-2004
Measurement Date : 16-Dec-2004

Product Data

Device Name : Dbtel_J9
Model : J9
Frequency : 1900.00 MHz
Max. Transmit Pwr : 1 W
Drift Time : 0 min(s)
Length : 151mm
Width : 45mm
Depth : 17.5mm
Power Drift-Start : 0.27 mV
Power Drift-Finish: 0.25 mV
Power Drift : 0.02 mV

Phantom Data

Type : Uni-Phantom
Size : 280mm x 280mm x 200mm
Location : Center

Tissue Data

Type : Body
Serial No. : 324-B
Frequency : 1900 MHz
Last Calibration Date : 16-Dec-2004
Temperature : 23.6 °C
Ambient Temp. : 24.5 °C
Humidity : 57 RH%
Epsilon : 52.31 F/m
Sigma : 1.56 S/m
Density : 1000 kg/cu. m

Probe Data

Model : E020
Type : E-Field Triangle
Serial No. : 222
Last Calibration Date : 18-Nov-2004
Frequency : 1900 MHz
Duty Cycle Factor: 8
Conversion Factor: 6.1
Probe Sensitivity: 1.30 1.30 1.30 $\mu\text{V}/(\text{V}/\text{sq. m})$
Compression Point: 95 mV
Offset : 1.56mm

Measurement Data

Crest Factor : 8

DUT Position : Body worn(distance 15mm)

Channel : 512(GSM)

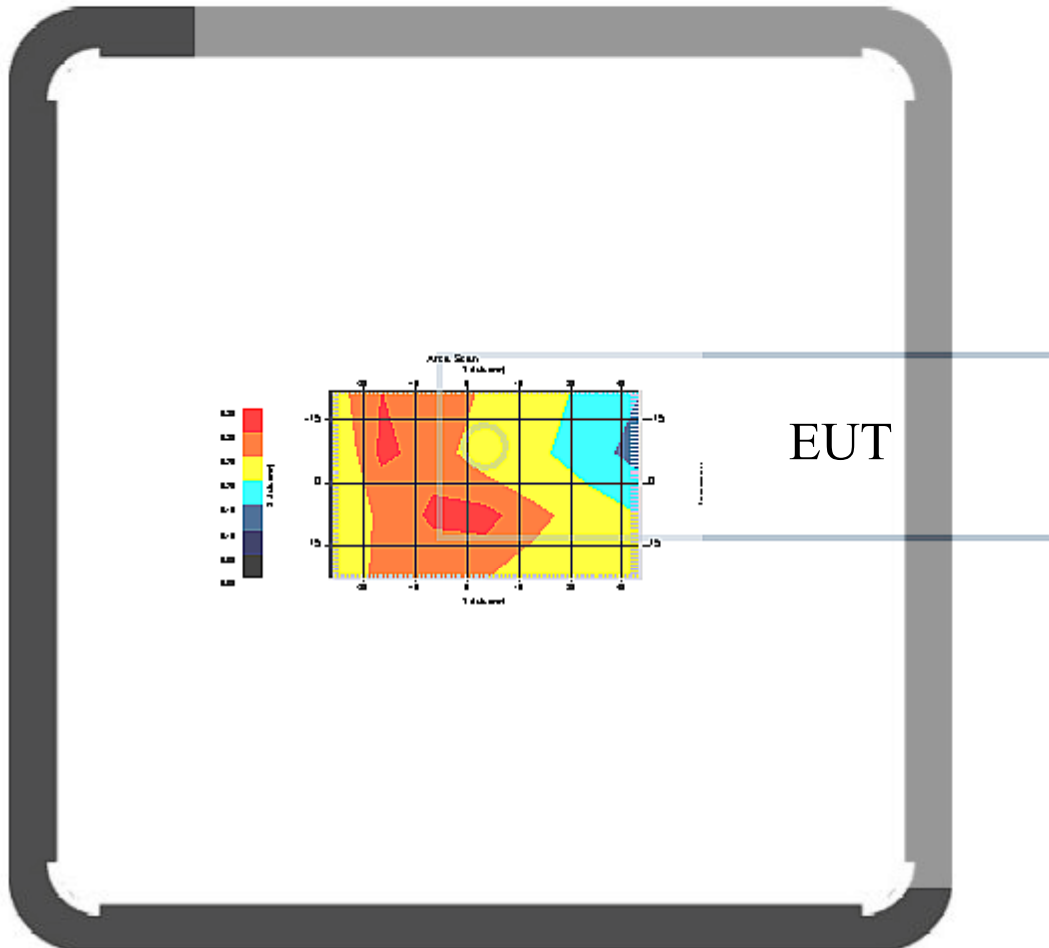

1 gram SAR value : 0.37 W/kg

10 gram SAR value : 0.29 W/kg

Area Scan Peak SAR : 0.32

Zoom Scan Peak SAR : 0.60

This is previous page plot (zoom in)

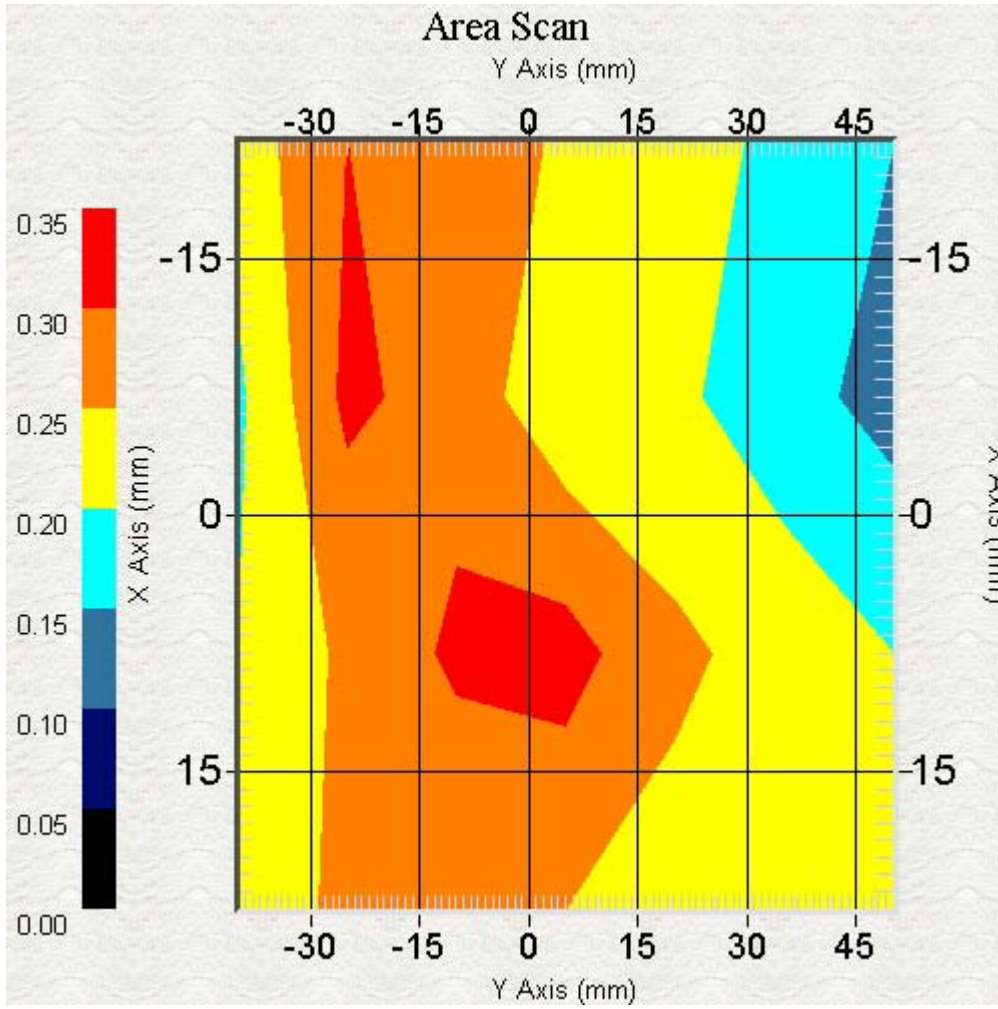

ALSAS-10U VER 1.5.14APREL Laboratories
SAR Test Report

Validation Date : 16-Dec-2004
Measurement Date : 16-Dec-2004

Product Data

Device Name : Dbtel_J9
Model : J9
Frequency : 1900.00 MHz
Max. Transmit Pwr : 1 W
Drift Time : 0 min(s)
Length : 151mm
Width : 45mm
Depth : 17.5mm
Power Drift-Start : 0.22 mV
Power Drift-Finish: 0.23 mV
Power Drift : 0.01 mV

Phantom Data

Type : Uni-Phantom
Size : 280mm x 280mm x 200mm
Location : Center

Tissue Data

Type : Body
Serial No. : 324-B
Frequency : 1900 MHz
Last Calibration Date : 16-Dec-2004
Temperature : 23.6 °C
Ambient Temp. : 24.5 °C
Humidity : 57 RH%
Epsilon : 52.31 F/m
Sigma : 1.56 S/m
Density : 1000 kg/cu. m

Probe Data

Model : E020
Type : E-Field Triangle
Serial No. : 222
Last Calibration Date : 18-Nov-2004
Frequency : 1900 MHz
Duty Cycle Factor: 8
Conversion Factor: 6.1
Probe Sensitivity: 1.30 1.30 1.30 $\mu\text{V}/(\text{V}/\text{sq. m})$
Compression Point: 95 mV
Offset : 1.56mm

Measurement Data

Crest Factor : 8

DUT Position : Body worn(distance 15mm)

Channel : 661(GSM)

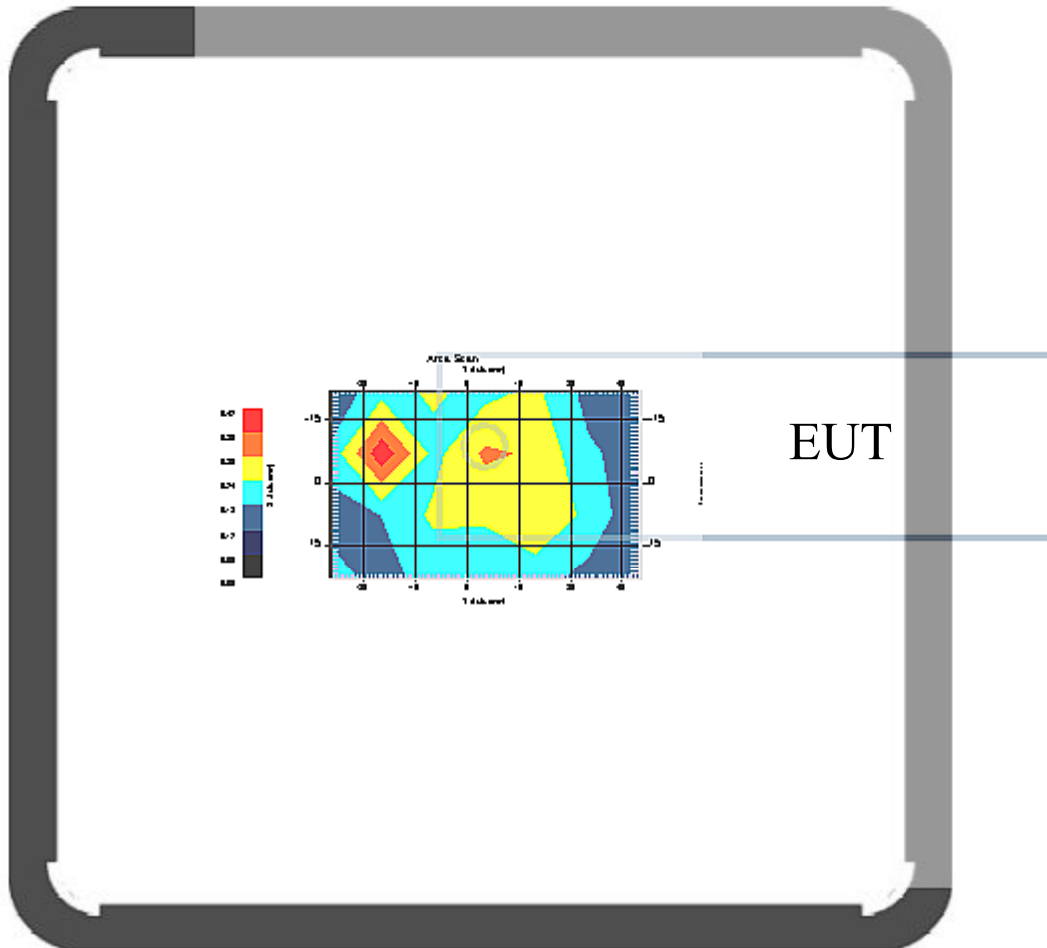

1 gram SAR value : 0.37 W/kg

10 gram SAR value : 0.26 W/kg

Area Scan Peak SAR : 0.40

Zoom Scan Peak SAR : 0.63

This is previous page plot (zoom in)

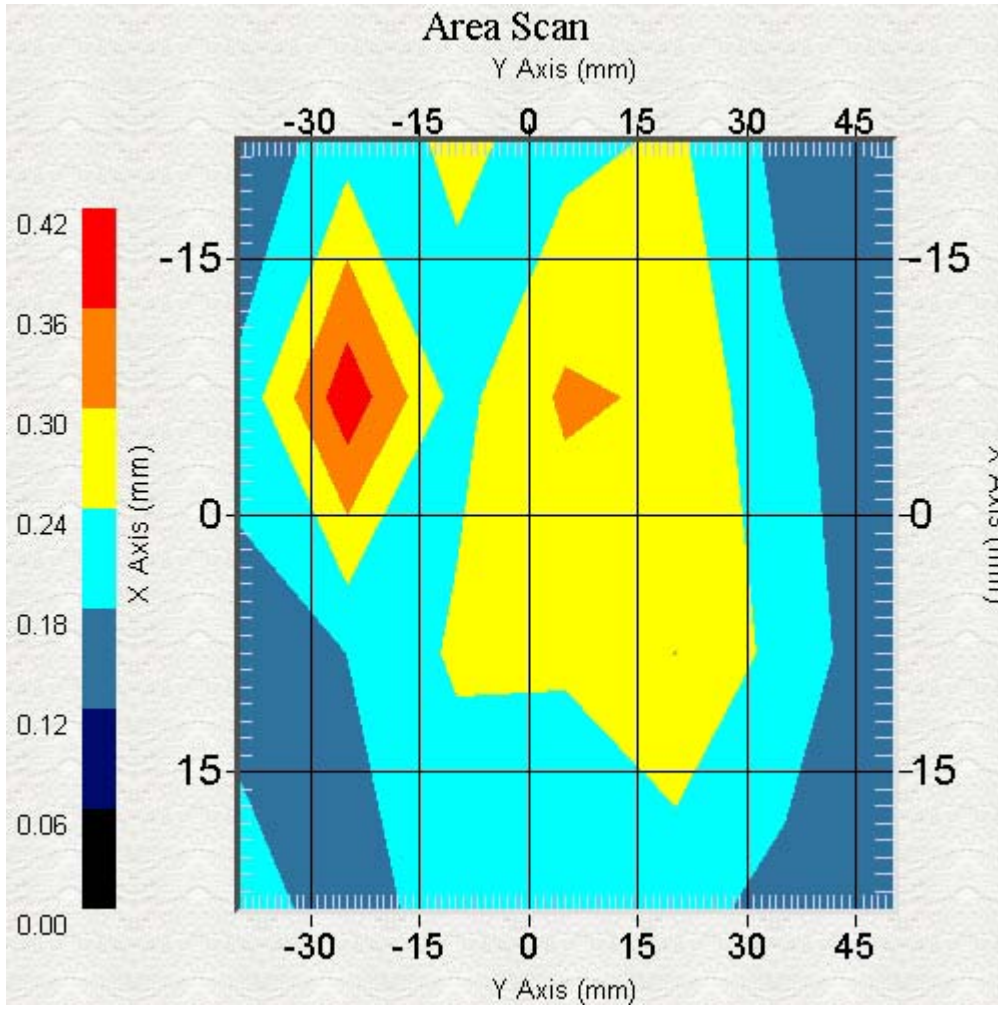

ALSAS-10U VER 1.5.14APREL Laboratories
SAR Test Report

Validation Date : 16-Dec-2004
Measurement Date : 16-Dec-2004

Product Data

Device Name : Dbtel_J9
Model : J9
Frequency : 1900.00 MHz
Max. Transmit Pwr : 1 W
Drift Time : 0 min(s)
Length : 151mm
Width : 45mm
Depth : 17.5mm
Power Drift-Start : 0.31 mV
Power Drift-Finish: 0.30 mV
Power Drift : 0.01 mV

Phantom Data

Type : Uni-Phantom
Size : 280mm x 280mm x 200mm
Location : Center

Tissue Data

Type : Body
Serial No. : 324-B
Frequency : 1900 MHz
Last Calibration Date : 16-Dec-2004
Temperature : 23.6 °C
Ambient Temp. : 24.5 °C
Humidity : 57 RH%
Epsilon : 52.31 F/m
Sigma : 1.56 S/m
Density : 1000 kg/cu. m

Probe Data

Model : E020
Type : E-Field Triangle
Serial No. : 222
Last Calibration Date : 18-Nov-2004
Frequency : 1900 MHz
Duty Cycle Factor: 8
Conversion Factor: 6.1
Probe Sensitivity: 1.30 1.30 1.30 $\mu\text{V}/(\text{V}/\text{sq. m})$
Compression Point: 95 mV
Offset : 1.56mm

Measurement Data

Crest Factor : 8

DUT Position : Body worn(distance 15mm)

Channel : 810(GSM)

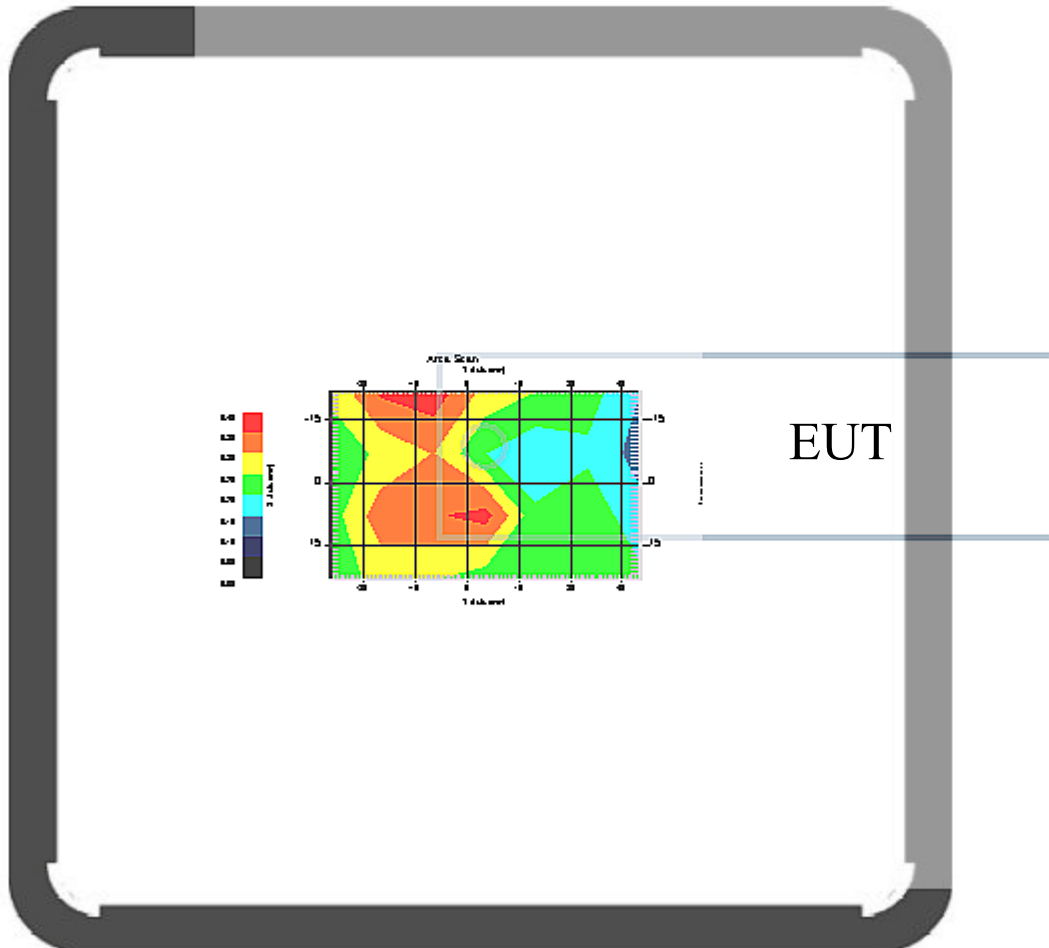

1 gram SAR value : 0.41 W/kg

10 gram SAR value : 0.34 W/kg

Area Scan Peak SAR : 0.38

Zoom Scan Peak SAR : 0.68

This is previous page plot (zoom in)

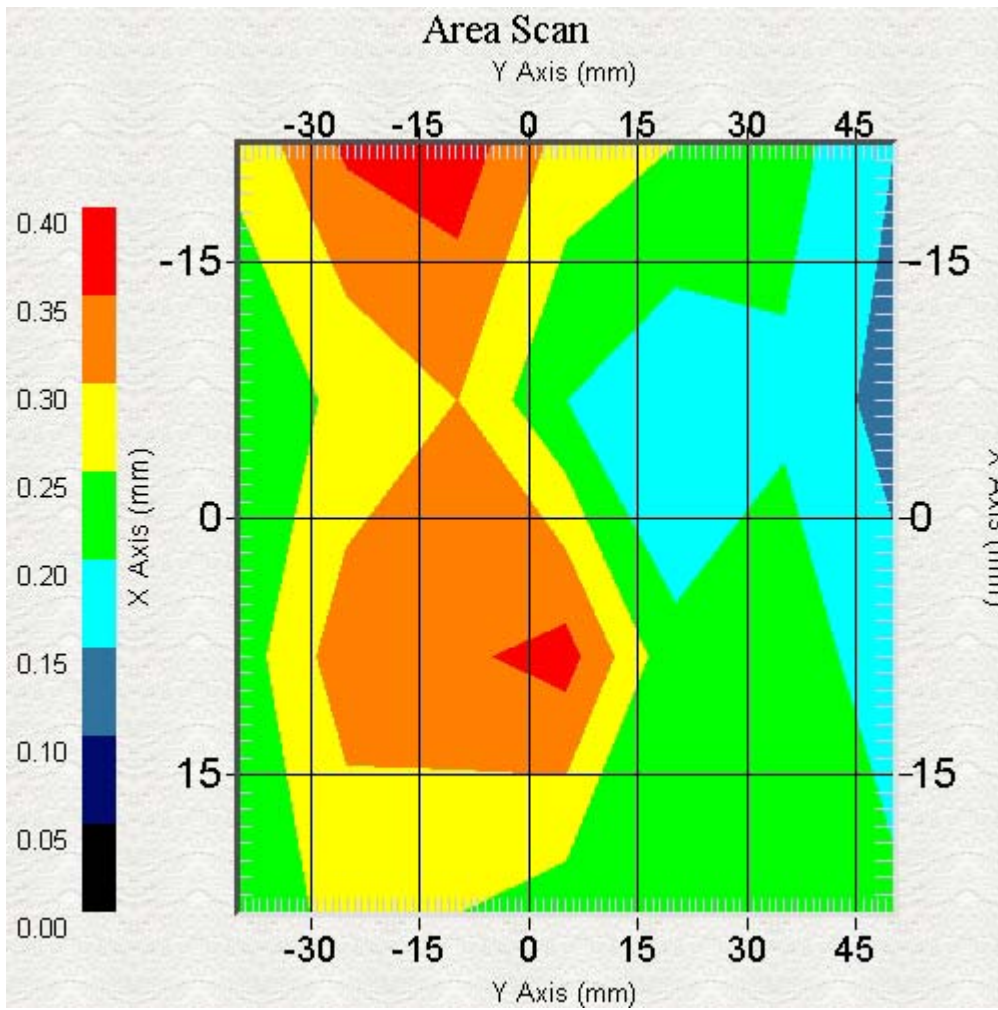

ALSAS-10U VER 1.5.14APREL Laboratories
SAR Test Report

Validation Date : 16-Dec-2004
Measurement Date : 16-Dec-2004

Product Data

Device Name : Dbtel_J9
Model : J9
Frequency : 1900.00 MHz
Max. Transmit Pwr : 1 W
Drift Time : 0 min(s)
Length : 151mm
Width : 45mm
Depth : 17.5mm
Power Drift-Start : 0.22 mV
Power Drift-Finish: 0.20 mV
Power Drift : 0.02 mV

Phantom Data

Type : Uni-Phantom
Size : 280mm x 280mm x 200mm
Location : Center

Tissue Data

Type : Body
Serial No. : 324-B
Frequency : 1900 MHz
Last Calibration Date : 16-Dec-2004
Temperature : 23.6 °C
Ambient Temp. : 24.5 °C
Humidity : 57 RH%
Epsilon : 52.31 F/m
Sigma : 1.56 S/m
Density : 1000 kg/cu. m

Probe Data

Model : E020
Type : E-Field Triangle
Serial No. : 222
Last Calibration Date : 18-Nov-2004
Frequency : 1900 MHz
Duty Cycle Factor: 4
Conversion Factor: 6.1
Probe Sensitivity: 1.30 1.30 1.30 $\mu\text{V}/(\text{V}/\text{sq. m})$
Compression Point: 95 mV
Offset : 1.56mm

Measurement Data

Crest Factor : 4

DUT Position : Body worn(distance 15mm)

Channel : 512(GPRS)

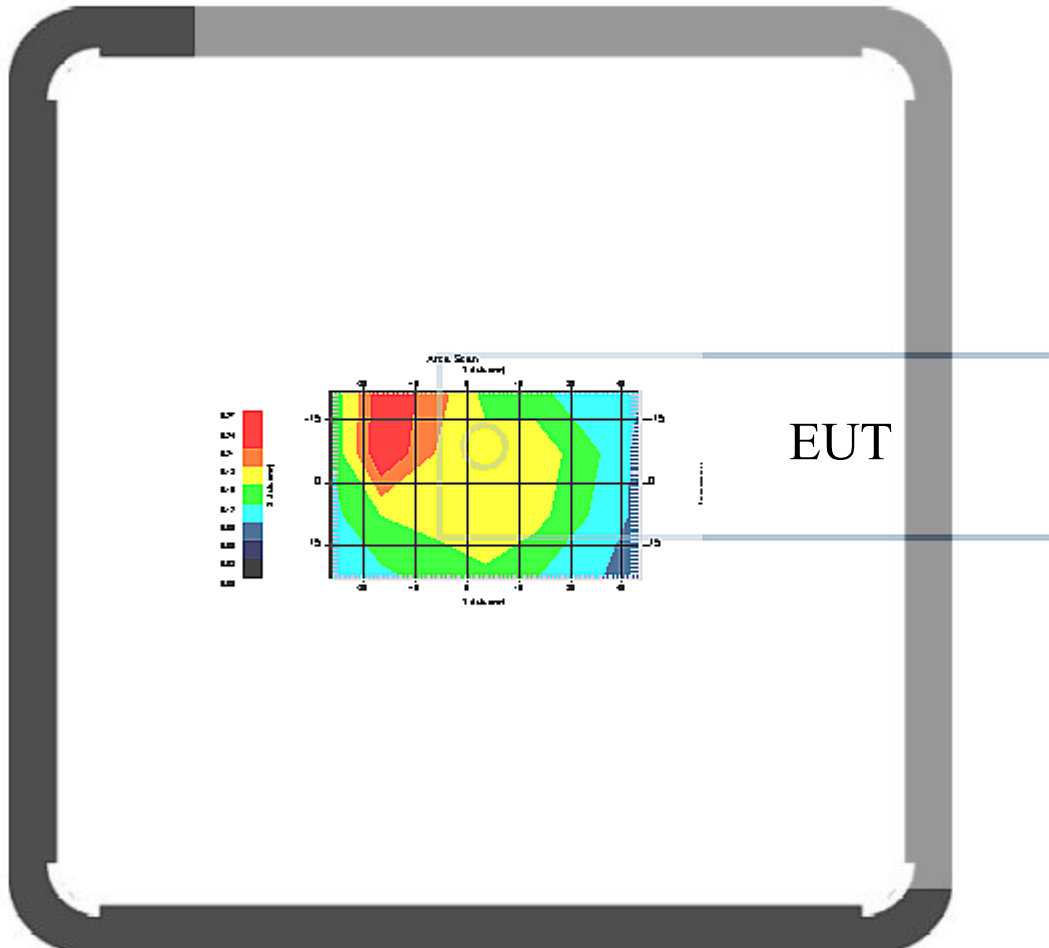

1 gram SAR value : 0.26 W/kg
10 gram SAR value : 0.18 W/kg
Area Scan Peak SAR : 0.24
Zoom Scan Peak SAR : 0.40

This is previous page plot (zoom in)

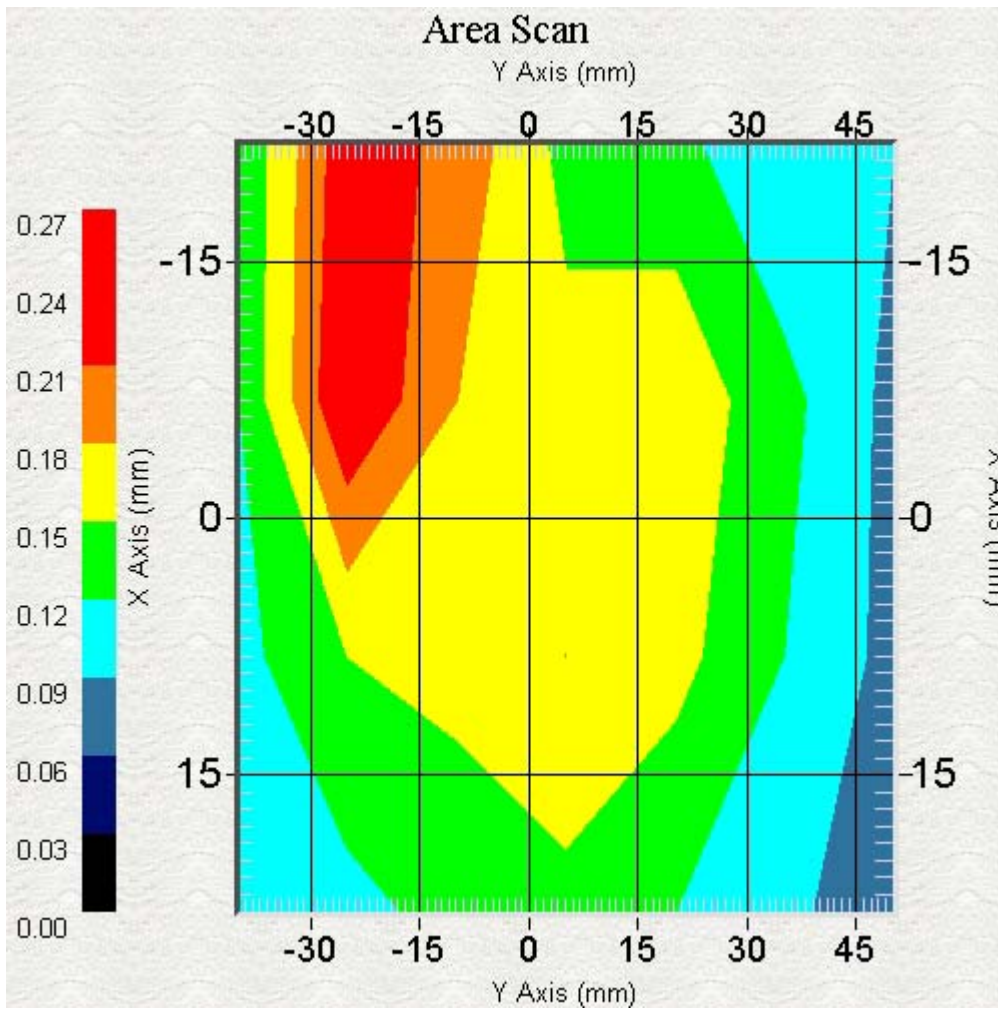

ALSAS-10U VER 1.5.14APREL Laboratories SAR Test Report

Validation Date : 16-Dec-2004
Measurement Date : 16-Dec-2004

Product Data

Device Name : Dbtel_J9
Model : J9
Frequency : 1900.00 MHz
Max. Transmit Pwr : 1 W
Drift Time : 0 min(s)
Length : 151mm
Width : 45mm
Depth : 17.5mm
Power Drift-Start : 0.23 mV
Power Drift-Finish: 0.21 mV
Power Drift : 0.02 mV

Phantom Data

Type : Uni-Phantom
Size : 280mm x 280mm x 200mm
Location : Center

Tissue Data

Type : Body
Serial No. : 324-B
Frequency : 1900 MHz
Last Calibration Date : 16-Dec-2004
Temperature : 23.6 °C
Ambient Temp. : 24.5 °C
Humidity : 57 RH%
Epsilon : 52.31 F/m
Sigma : 1.56 S/m
Density : 1000 kg/cu. m

Probe Data

Model : E020
Type : E-Field Triangle
Serial No. : 222
Last Calibration Date : 18-Nov-2004
Frequency : 1900 MHz
Duty Cycle Factor: 4
Conversion Factor: 6.1
Probe Sensitivity: 1.30 1.30 1.30 $\mu\text{V}/(\text{V}/\text{sq. m})$
Compression Point: 95 mV
Offset : 1.56mm

Measurement Data

Crest Factor : 4
DUT Position : Body worn(distance 15mm)
Channel : 661(GPRS)

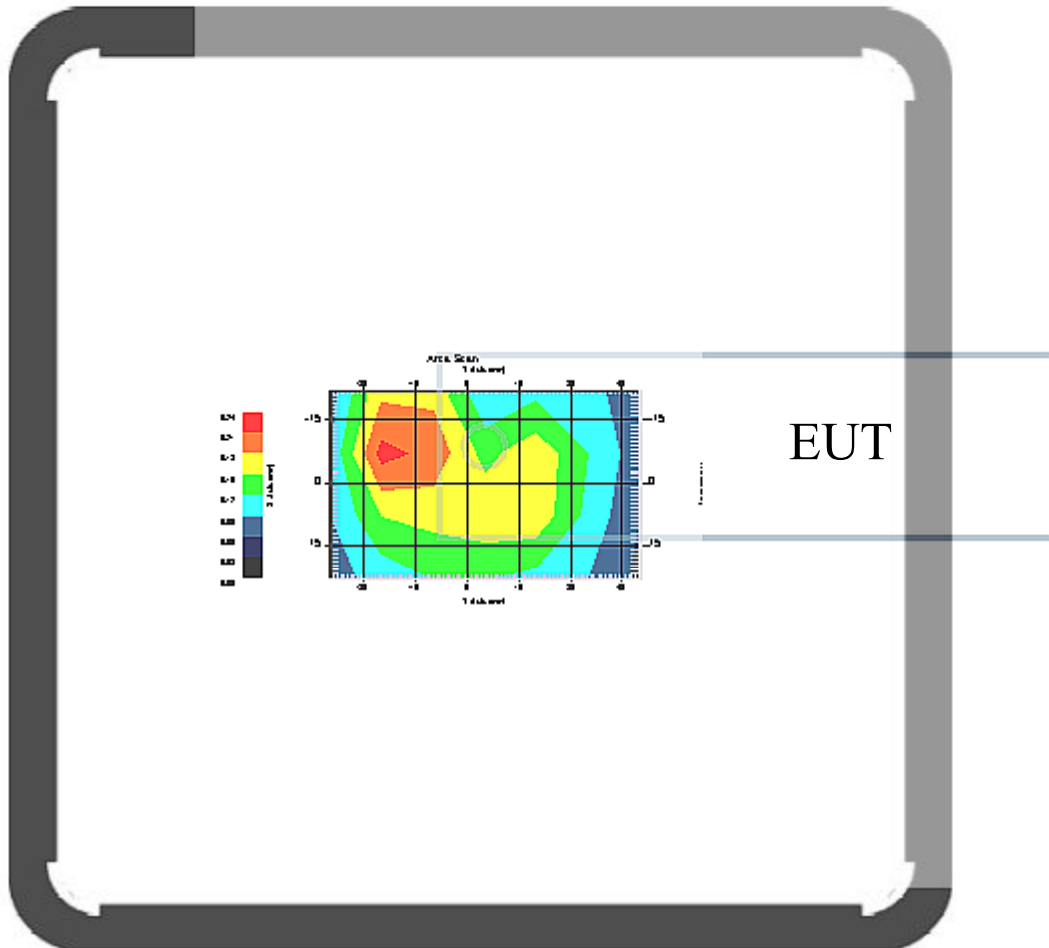

1 gram SAR value : 0.26 W/kg
10 gram SAR value : 0.16 W/kg
Area Scan Peak SAR : 0.22
Zoom Scan Peak SAR : 0.42

This is previous page plot (zoom in)

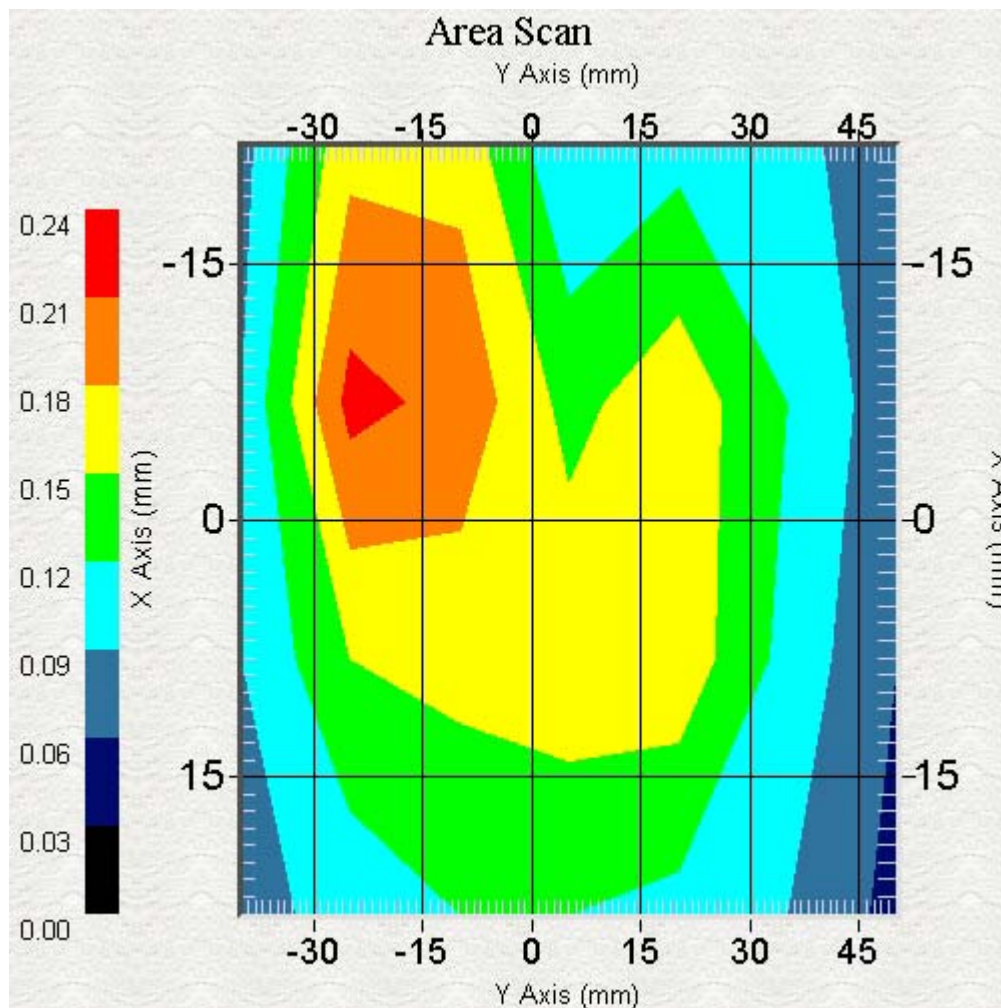

ALSAS-10U VER 1.5.14APREL Laboratories SAR Test Report

Validation Date : 16-Dec-2004
Measurement Date : 16-Dec-2004

Product Data

Device Name : Dbtel_J9
Model : J9
Frequency : 1900.00 MHz
Max. Transmit Pwr : 1 W
Drift Time : 0 min(s)
Length : 151mm
Width : 45mm
Depth : 17.5mm
Power Drift-Start : 0.16 mV
Power Drift-Finish: 0.14 mV
Power Drift : 0.02 mV

Phantom Data

Type : Uni-Phantom
Size : 280mm x 280mm x 200mm
Location : Center

Tissue Data

Type : Body
Serial No. : 324-B
Frequency : 1900 MHz
Last Calibration Date : 16-Dec-2004
Temperature : 23.6 °C
Ambient Temp. : 24.5 °C
Humidity : 57 RH%
Epsilon : 52.31 F/m
Sigma : 1.56 S/m
Density : 1000 kg/cu. m

Probe Data

Model : E020
Type : E-Field Triangle
Serial No. : 222
Last Calibration Date : 18-Nov-2004
Frequency : 1900 MHz
Duty Cycle Factor: 4
Conversion Factor: 6.1
Probe Sensitivity: 1.30 1.30 1.30 $\mu\text{V}/(\text{V}/\text{sq. m})$
Compression Point: 95 mV
Offset : 1.56mm

Measurement Data

Crest Factor : 4

DUT Position : Body worn(distance 15mm)

Channel : 810(GPRS)

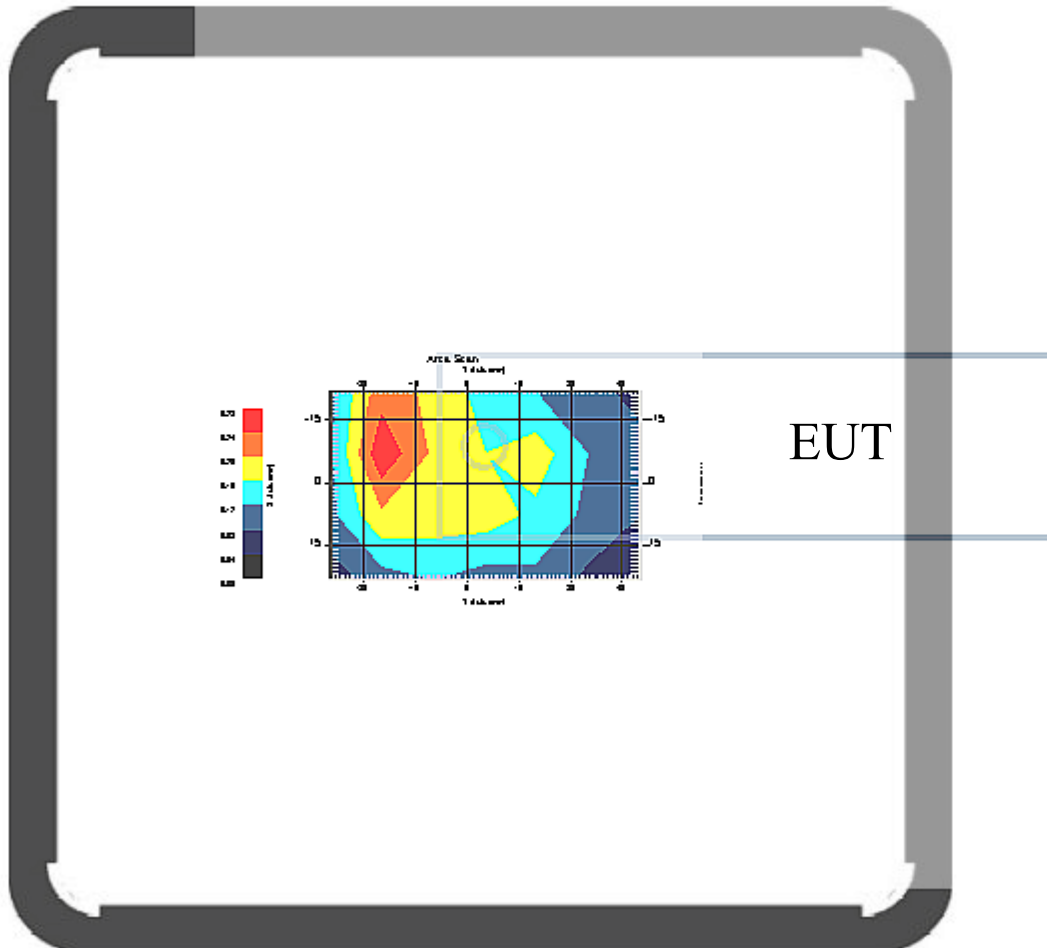

1 gram SAR value : 0.26 W/kg

10 gram SAR value : 0.17 W/kg

Area Scan Peak SAR : 0.27

Zoom Scan Peak SAR : 0.42

This is previous page plot (zoom in)

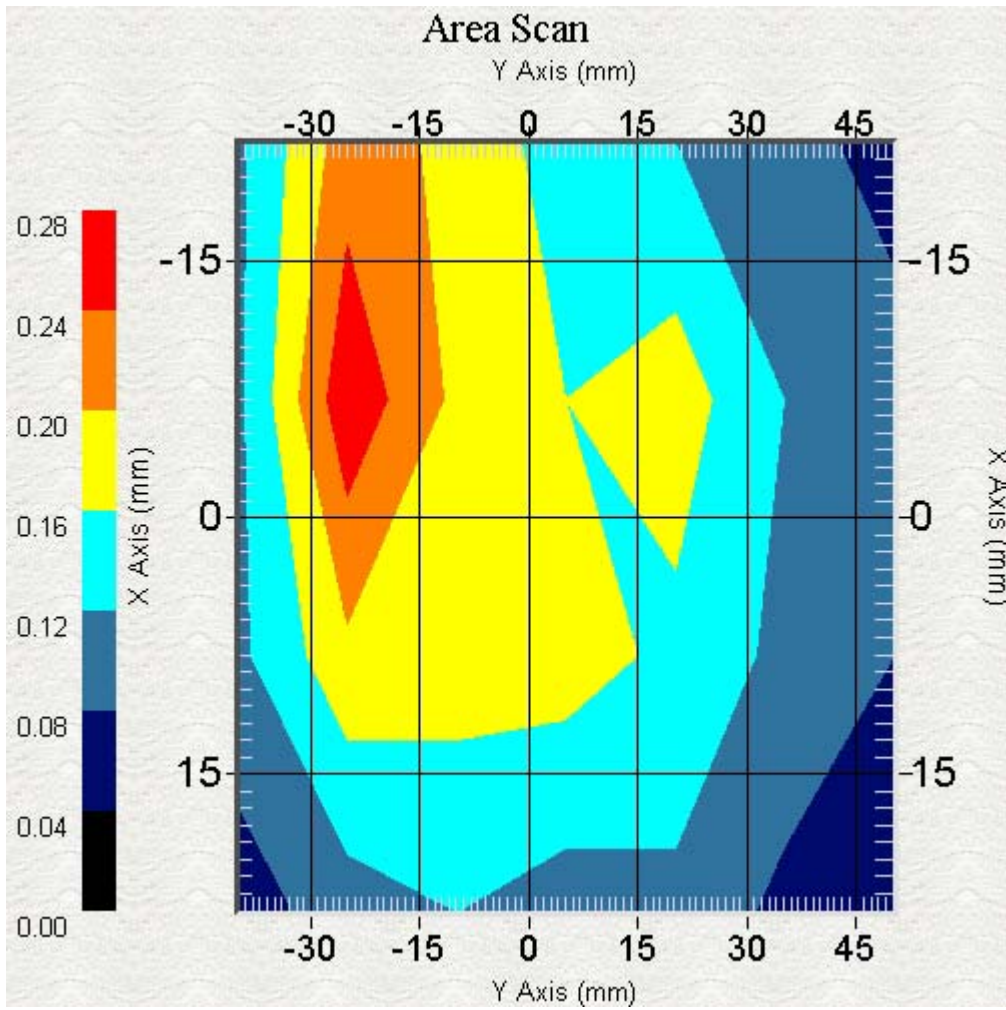

SAR System 1900MHz Validation Z-Axis plot (16-Dec-04)

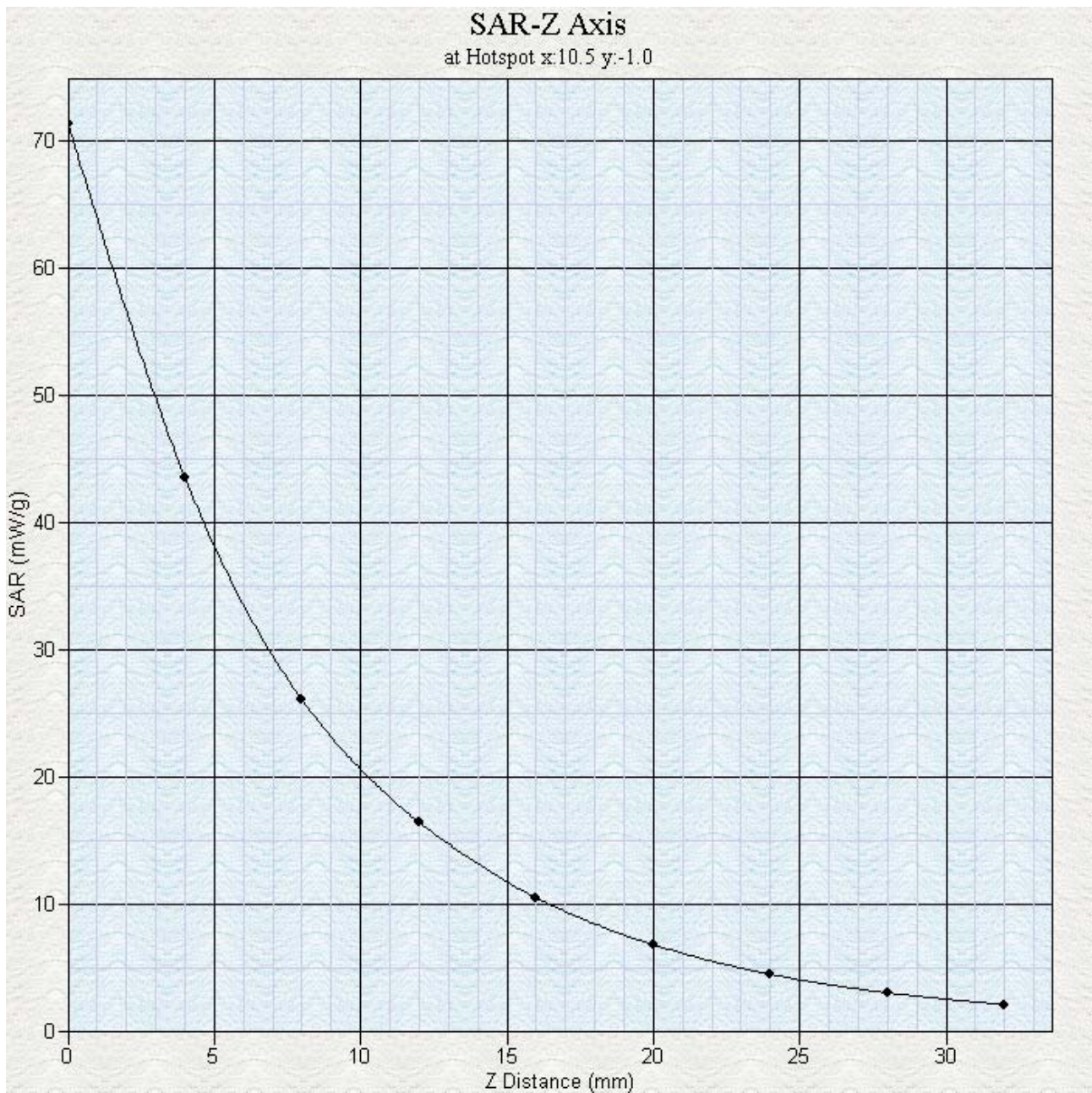

EUT 1900MHz(Head) SAR test Z-Axis plot (16-Dec-04)
(Right Head, Touch, Channel 810)

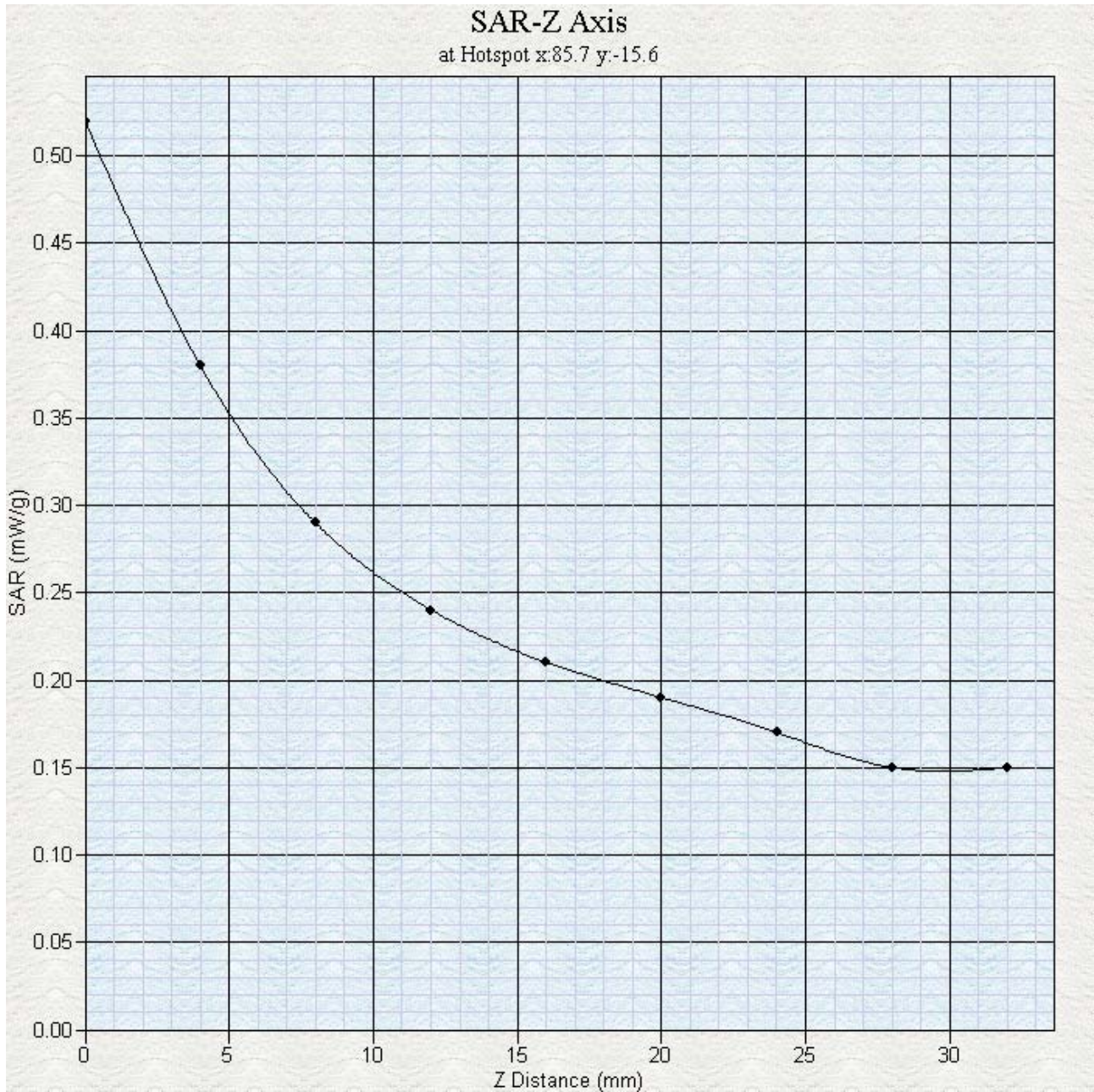

EUT 1900MHz(Body) SAR test Z-Axis plot (16-Dec-04)

(Body worn, channel 810)

