

FCC Test Report

REPORT NO.: RF921224R02

MODEL NO.: 8055T(2042S3)

RECEIVED: December 24, 2003

TESTED: December 29, 2003 ~ January 05, 2004

APPLICANT: DBTEL Incorporated

ADDRESS: No. 29, Tzu Chiang St., Tu-Cheng, Taipei,
Taiwan, R.O.C.

ISSUED BY: Advance Data Technology Corporation

LAB LOCATION: 47 14th Lin, Chiapau Tsun, Linko, Taipei,
Taiwan, R.O.C.

This test report consists of 62 pages in total. It may be duplicated completely for legal use with the approval of the applicant. It should not be reproduced except in full, without the written approval of our laboratory. The client should not use it to claim product endorsement by CNLA or any government agencies. The test results in the report only apply to the tested sample.



0528
ILAC MRA

Table of Contents

1	CERTIFICATION	4
2	SUMMARY OF TEST RESULTS	5
3	GENERAL INFORMATION	6
3.1	GENERAL DESCRIPTION OF EUT	6
3.2	DESCRIPTION OF TEST MODES	7
3.3	GENERAL DESCRIPTION OF APPLIED STANDARDS	7
3.4	DESCRIPTION OF SUPPORT UNITS	8
4	TEST TYPES AND RESULTS	9
4.1	MODULATION CHARACTERISTICS	9
4.1.1	DESCRIPTION OF MODULATION TECHNIQUE	9
4.1.2	THE ACTIVE TIME SLOT 8 MODULATED FRAME PLOT	9
4.2	OUTPUT POWER MEASUREMENT	11
4.2.1	LIMITS OF OUTPUT POWER MEASUREMENT	11
4.2.2	TEST INSTRUMENTS	11
4.2.3	TEST PROCEDURES	12
4.2.4	TEST SETUP	13
4.2.5	EUT OPERATING CONDITIONS	14
4.2.6	TEST RESULTS	15
4.3	FREQUENCY STABILITY MEASUREMENT	17
4.3.1	LIMITS OF FREQUENCY STABILITY MEASUREMENT	17
4.3.2	TEST INSTRUMENTS	17
4.3.3	TEST PROCEDURE	18
4.3.4	TEST SETUP	18
4.3.5	TEST RESULTS	19
4.4	OCCUPIED BANDWIDTH MEASUREMENT	21
4.4.1	LIMITS OF OCCUPIED BANDWIDTH MEASUREMENT	21
4.4.2	TEST INSTRUMENTS	21
4.4.3	TEST SETUP	21
4.4.4	TEST PROCEDURES	22
4.4.5	EUT OPERATING CONDITION	22
4.4.6	TEST RESULTS	22
4.5	BAND EDGE MEASUREMENT	29
4.5.1	LIMITS OF BAND EDGE MEASUREMENT	29
4.5.2	TEST INSTRUMENTS	29

4.5.3	TEST SETUP.....	29
4.5.4	TEST PROCEDURES.....	30
4.5.5	EUT OPERATING CONDITION.....	30
4.5.6	TEST RESULTS.....	31
4.6	CONDUCTED SPURIOUS EMISSIONS.....	33
4.6.1	LIMITS OF CONDUCTED SPURIOUS EMISSIONS MEASUREMENT.....	33
4.6.2	TEST INSTRUMENTS.....	33
4.6.3	TEST PROCEDURE.....	34
4.6.4	TEST SETUP.....	34
4.6.5	EUT OPERATING CONDITIONS.....	34
4.6.6	TEST RESULTS.....	35
4.7	RADIATED EMISSION MEASUREMENT.....	47
4.7.1.	LIMITS OF RADIATED EMISSION MEASUREMENT.....	47
4.7.2.	TEST INSTRUMENTS.....	48
4.7.3.	TEST PROCEDURES.....	49
4.7.4.	DEVIATION FROM TEST STANDARD.....	49
4.7.5.	TEST SETUP.....	50
4.7.6.	EUT OPERATING CONDITIONS.....	50
4.7.7.	TEST RESULTS.....	51
4.8	EFFECTIVE RADIATED POWER MEASUREMENT.....	52
4.8.1.	LIMITS OF RADIATED EMISSION MEASUREMENT.....	52
4.8.2.	TEST INSTRUMENTS.....	53
4.8.3.	TEST PROCEDURES.....	54
4.8.4.	DEVIATION FROM TEST STANDARD.....	54
4.8.5.	TEST SETUP.....	55
4.8.6.	EUT OPERATING CONDITIONS.....	55
4.8.7.	TEST RESULTS.....	56
5	PHOTOGRAPHS OF THE TEST CONFIGURATION.....	59
6	INFORMATION ON THE TESTING LABORATORIES.....	62

1 CERTIFICATION

PRODUCT : Mobile Phone
BRAND NAME : 8055T(2042S3)
MODEL NO. : DBTEL
TEST ITEM: ENGINEERING SAMPLE
APPLICANT : DBTEL Incorporated
TEST STANDARDS : FCC Part 24, Subpart E,
ANSI C63.4-1992

We, **Advance Data Technology Corporation**, hereby certify that one sample of the designation has been tested in our facility from December 29, 2003 to January 05, 2004. The test record, data evaluation and Equipment Under Test (EUT) configurations represented herein are true and accurate accounts of the measurements of the sample's EMC characteristics under the conditions herein specified.

PREPARED BY: Stacy Hsueh. , **DATE:** January 06, 2004
Stacy Hsueh

APPROVED BY: Ellis Wu , **DATE:** January 06, 2004
Ellis Wu / Manager

2 SUMMARY OF TEST RESULTS

The EUT has been tested according to the following specifications:

APPLIED STANDARD: FCC 47 CFR Part 24 & Part 2 / IC RSS-133			
Standard Section	Test Type and Limit	Result	REMARK
2.1047(d)	Modulation Characteristics	PASS	NA
2.1046, 24.232	Maximum Peak Output Power Limit: max. 2 watts e.i.r.p peak power	PASS	Meet the requirement of limit Minimum passing margin is -29.70dBm at 1850.20MHz
2.1055, 24.235	Frequency Stability AFC Freq. Error vs. Voltage AFC Freq. Error vs. Temperature Limit: max. ± 0.1 ppm	PASS	Meet the requirement of limit
2.1049, 24.238(b)	Occupied Bandwidth	PASS	Meet the requirement of limit
24.238(b)	Band Edge Measurements	PASS	NA
2.1051, 24.238	Conducted Spurious Emissions	PASS	Meet the requirement of limit Minimum passing margin is -12.38dB at 3200.00MHz
2.1053, 24.238	Radiated Spurious Emissions	PASS	Meet the requirement of limit Minimum passing margin is -37.71dB at 494.59MHz

3 GENERAL INFORMATION

3.1 GENERAL DESCRIPTION OF EUT

PRODUCT	Mobile Phone
MODEL NO.	8055T(2042S3)
POWER SUPPLY	3.8Vdc from Battery
MODULATION TYPE	GMSK
FREQUENCY RANGE	Tx Frequency : 1850.2MHz~1909.8MHz (PCS band) Rx Frequency : 1930.2MHz~1989.8MHz (PCS band)
NUMBER OF CHANNEL	299
MAX. CONDUCTED PEAK OUTPUT POWER	29.70dBm(0.933Watts)
MAX. RADITED EIRP PEAK OUTPUT POWER	27.30dBm(0.912Watts)
ANTENNA TYPE	External Antenna
DATA CABLE	NA
I/O PORTS	NA
ASSOCIATED DEVICES	Earphone plus Microphone
EUT Extreme Vol. Range	3.2Vdc to 4.4Vdc

NOTE

1. For more detailed features description, please refer to the manufacturer's specifications or User's Manual.
1. IMEI Code: 35317500000012.
2. The hardware version: 1PT-SYSOL 3-06A
3. The software version: DV10D

3.2 DESCRIPTION OF TEST MODES

299 channels are provided to this EUT in the PCS1900 band. Therefore choice the low, middle and high channel to testing.

Channel	Frequency	Channel	Frequency
512(low cha.)	1850.2MHz	661(middle cha.)	1880.0 MHz
810(high cha.)	1909.8 MHz	NA	

NOTE:

1. Below 1 GHz, the channel 512, 661, and 810 were pre-tested in chamber. The channel 512, worst case one, was chosen for final test.
2. Above 1 GHz, the channel 512, 661, and 810 were tested individually.
3. When the Power Control Level set 0, the worst case, was chosen for final test.
4. The channel space is 0.2MHz.

3.3 GENERAL DESCRIPTION OF APPLIED STANDARDS

The EUT is a Mobile Phone. According to the specifications of the manufacturer, it must comply with the requirements of the following standards:

FCC 47 CFR Part 2

FCC 47 CFR Part 24

IC RSS-133

ANSI C63.4 : 1992

All test items have been performed and recorded as per the above standards.

3.4 DESCRIPTION OF SUPPORT UNITS

The EUT has been tested as an independent unit together with other necessary accessories or support units. The following support units or accessories were used to form a representative test configuration during the tests.

NO.	PRODUCT	BRAND	MODEL NO.	SERIAL NO.	CAL. DATE
1	GSM MS SET	ROHDE &SCHWARZ	CMU 200	8360721086	2004/04/21

NO.	SIGNAL CABLE DESCRIPTION OF THE ABOVE SUPPORT UNITS
1	NA

NOTE: All power cords of the above support units are non shielded (1.8m).

4 TEST TYPES AND RESULTS

4.1 MODULATION CHARACTERISTICS

4.1.1 DESCRIPTION OF MODULATION TECHNIQUE

According to FCC 2.1047(d), the system is used the digital modulation and accomplished with the PCS requirement as defined in the 3GGP TS 05:01, TS 05:02, TS 05:04. It uses narrowband TDMA. Eight simultaneous calls can occupy the same radio frequency.

There are 299 channels and channel space is 200kHz. The frequency band 1850~1910MHz is allocated to the uplink and 1930~1990MHz to the downlink. The uplink and downlink channel space is 80MHz and is duplex at the same time.

The modulation scheme used the GMSK (Gaussian Minimum Shift Keying) that is the special case of FSK (frequency Shift Keying). The each time slot is last about 580 μ s and data length is 156.25bits. A frame contains the eight time slots.

4.1.2 THE ACTIVE TIME SLOT 8 MODULATED FRAME PLOT

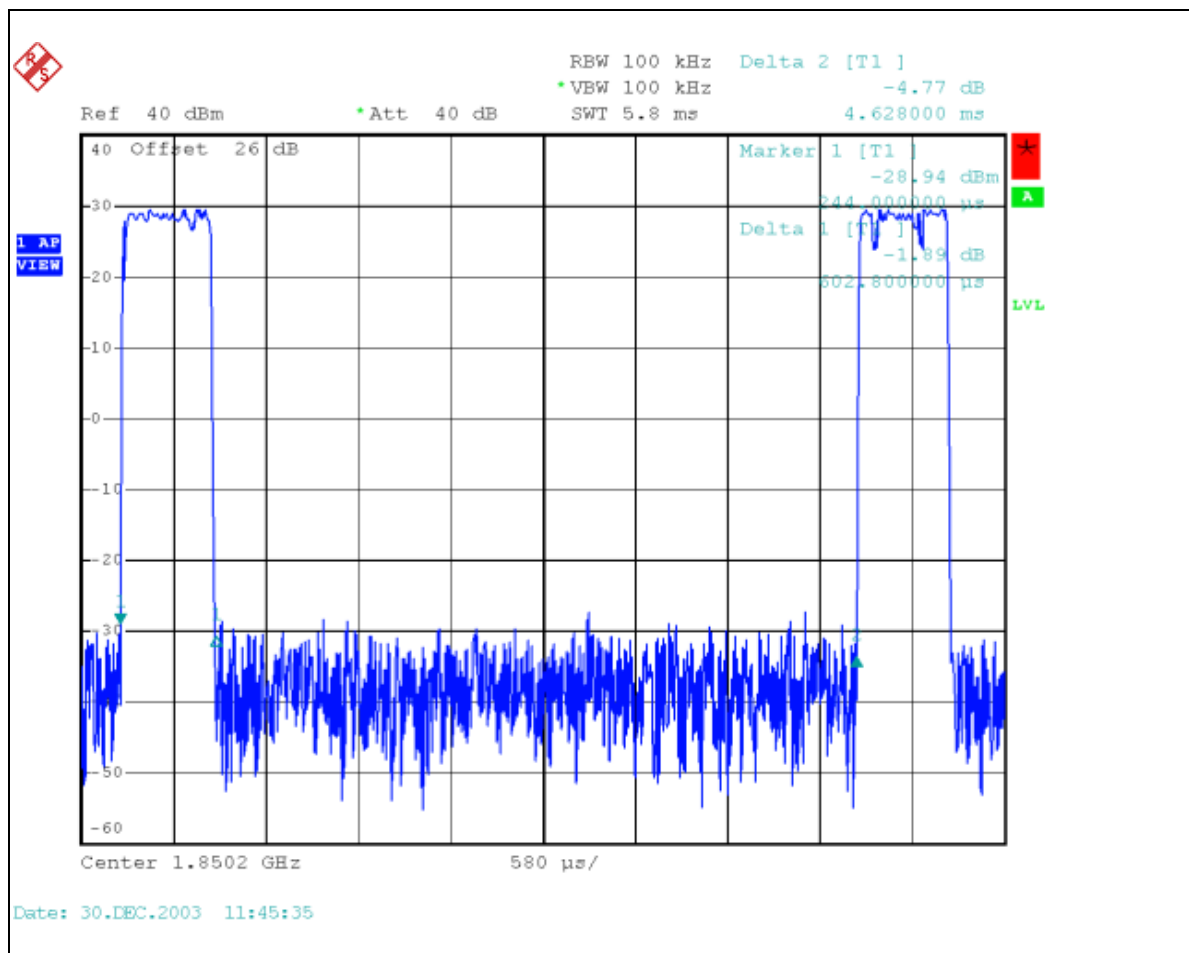

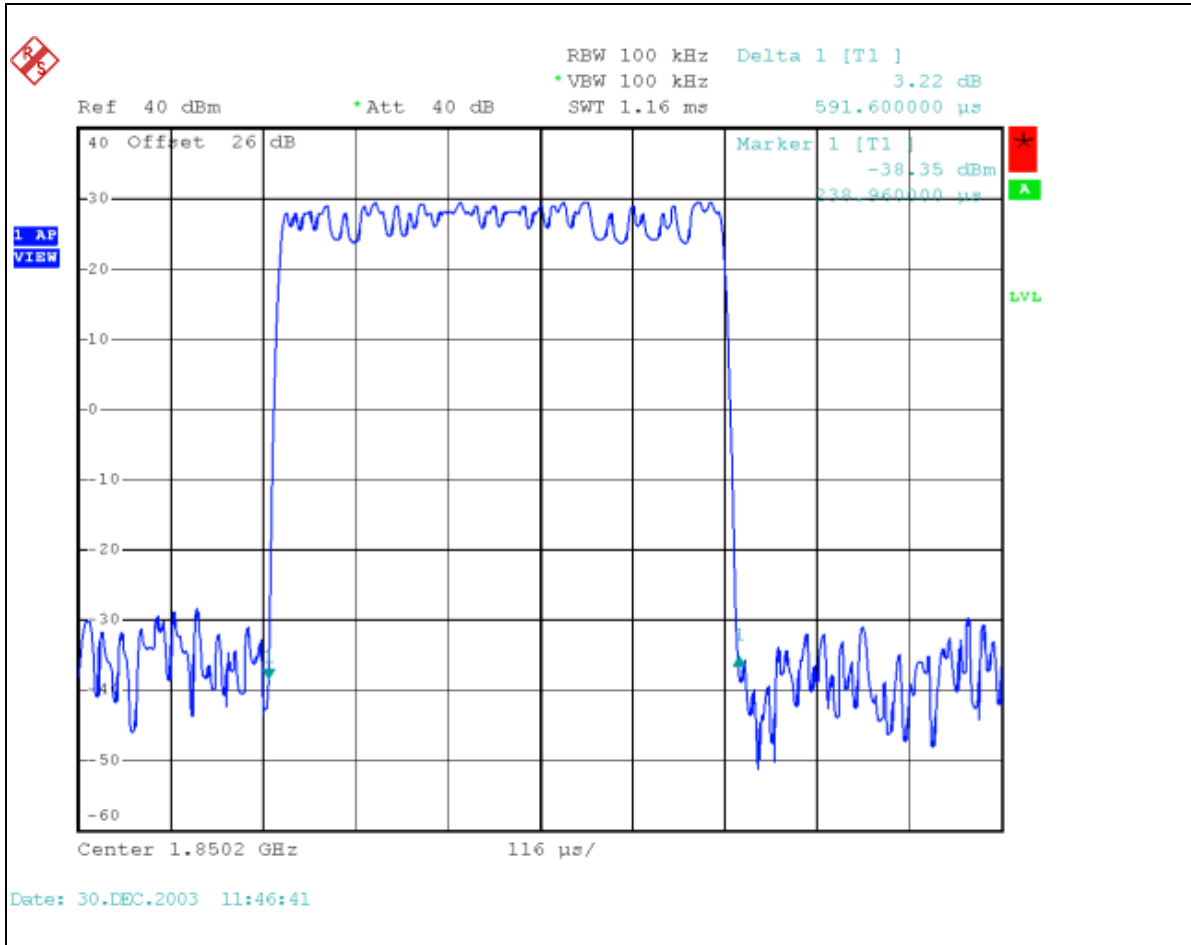

4.2 OUTPUT POWER MEASUREMENT

4.2.1 LIMITS OF OUTPUT POWER MEASUREMENT

The radiated peak output power shall be according to the specific rule Part 24.232(b) that “Mobile / Portable station are limited to 2 watts e.i.r.p” and 24.232(c) specific that “Peak transmit power must be measure over any interval of continuous transmission using instrumentation calibration in terms of rms-equivalent voltage.”

4.2.2 TEST INSTRUMENTS

DESCRIPTION & MANUFACTURER	MODEL NO.	SERIAL NO.	CALIBRATED UNTIL
* ROHDE & SCHWARZ Spectrum Analyzer	FSP40	100035	Apr. 15, 2004
* ROHDE & SCHWARZ Signal Generator	SMP04	10001	May 05, 2004
* ROHDE & SCHWARZ Universal Radio Communication Tester	CMU200	836072/086	Apr. 21, 2004
* EMCO Horn Antenna	3115	9811-5623	Jul. 27, 2004
* EMCO Horn Antenna	3115	9811-5619	Jul. 15, 2004
* EMCO Turn Table & Tower Controller	2090	NA	NA
* Software	ADT_Radiated_V 5.14	NA	NA
* Mini-Circuits Power Splitter	ZAPD-4	400005	NA
* Hewlett Packard RF cable	8120-6192	01428251	NA
* JFW 20dB attenuation	50HF-020-SMA	NA	NA
* Suhner RF cable	Sucoflex104	204850/4	NA

- NOTE:** 1. The calibration interval of the above test instruments is 12 months. And the calibrations are traceable to NML/ROC and NIST/USA.
 2. “*” = These equipments are used for the final measurement.
 3. The test was performed in ADT RF fully anechoic chamber No. 2.

4.2.3 TEST PROCEDURES

- a. The EUT was set up for the maximum peak power with GPRS link data modulation. The power was measured with R&S Spectrum Analyzer. All measurements were done at 3 channels, 512, 661 and 810(low, middle and high operational frequency range.)
- b. The conducted peak output power used the power splitter via EUT RF power connector between simulation base station and spectrum analyzer. The path loss included the splitter loss, cable loss and 20dB pad loss. The spectrum set RB/VB 3MHz, then read peak power value and record to the test. (All transmitted path loss shall be considered in the test report data.)
- c. E.I.R.P peak power measurement. In the fully anechoic chamber, EUT placed on the 1.5m height of Turn Table, rotated the table around 360 degrees to search the maximum radiation power and receiver antenna shall be rotated vertical and horizontal polarization to find the maximum polar radiated power. The "Read Value" is the spectrum reading the maximum power value.
- d. The substitution horn antenna is substituted for EUT at the same position and signal generator export the CW signal to the calibration antenna. Rotated the Turn Table to find the maximum radiation power. "Raw" is the spectrum reading value, "SG" is signal generator export power, "TX Gain" is calibration antenna isotropic gain value, "TX cable" is the transmitted cable loss between the calibration antenna and signal generator. The "Factor" means that the transmission path loss is equal to "SG" - "TX cable" + "TX Gain" - "Raw".
- e. Actually the real E.I.R.P peak power is equal to "Read Value" + "Factor"
- f. E.R.P power can be calculated form E.I.R.P power by subtracting the gain of dipole, $E.R.P \text{ power} = E.I.P.R \text{ power} - 2.15\text{dBi}$.

NOTE:

1. The resolution bandwidth and video bandwidth of test receiver/spectrum analyzer is 3MHz for Peak detection (PK)

4.2.4 TEST SETUP

EIRP Power Measurement

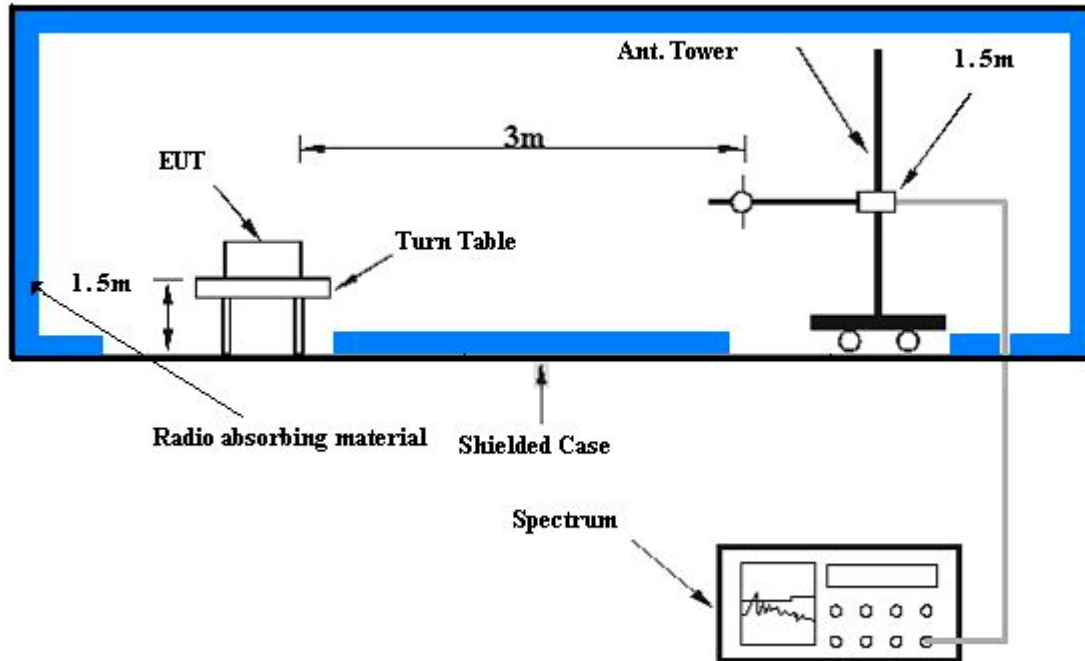

For the actual test configuration, please refer to the related item – Photographs of the Test Configuration.

Conducted Power Measurement

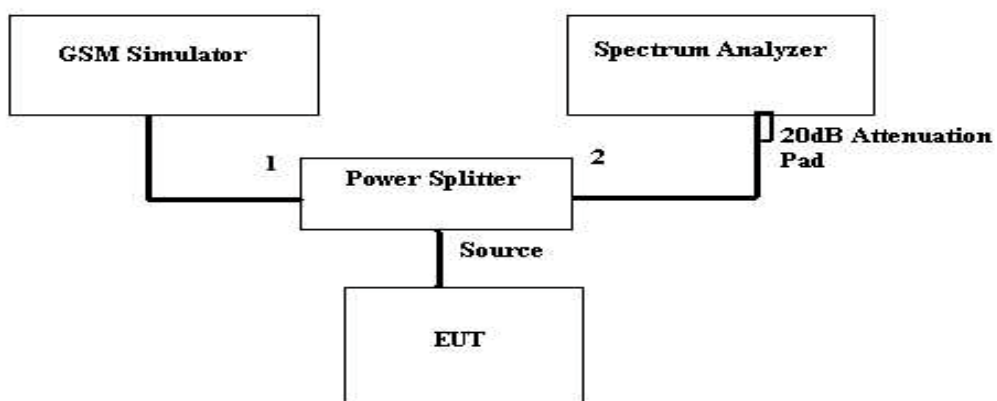

For the actual test configuration, please refer to the related item – Photographs of the Test Configuration.

4.2.5 EUT OPERATING CONDITIONS

- a. The EUT makes a phone call to the GSM simulator.
- b. The GSM simulator station system controlled a EUT to export maximum output power under transmission mode and specific channel frequency.

4.2.6 TEST RESULTS

EUT	Mobile Phone	MODEL	8055T(2042S3)
MODE	TX connected	POWER CONTROL LEVEL	0
INPUT POWER (SYSTEM)	120Vac, 60 Hz	DETECTOR FUNCTION	Peak
ENVIRONMENTAL CONDITIONS	24 deg. C, 62 % RH, 999 hPa	TESTED BY: Cody Chang	

CONDUCTED PEAK OUTPUT POWER					
Channel No.	Frequency (MHz)	Raw Value (dBm)	Correction Factor (dB)	Peak Output Power	
				dBm	Watt
512	1850.2	26.30	3.40	29.70	0.933
661	1880.0	26.20	3.40	29.60	0.912
810	1909.8	26.24	3.36	29.60	0.912

REMARKS:

1. Peak Output Power(dBm)=Raw Value(dBm) + Correction Factor(dB)
2. Correction Factor(dB) = Power Splitter Loss(dB) + Cable Loss(dB)

FCC ID: BW3DB-2042S3

EUT	Mobile Phone	MODEL	8055T(2042S3)
MODE	Tx	POWER CONTORL LEVEL	0
INPUT POWER (SYSTEM)	120Vac, 60 Hz	DETECTOR FUNCTION	Peak
ENVIRONMENTAL CONDITIONS	24 deg. C, 62 % RH, 999 hPa	TESTED BY: Cody Chang	

EIRP RADIATED PEAK OUTPUT POWER					
Channel No.	Frequency (MHz)	Raw Value (dBm)	Correction Factor (dB)	Peak Output Power	
				dBm	Watt
512	1850.2	-9.00	36.20	27.20	0.525
661	1880.0	-9.40	36.50	27.10	0.513
810	1909.8	-9.00	36.30	27.30	0.537

REMARKS:

1. Peak Output Power(dBm)=Raw Value(dBm) + Correction Factor(dB)
2. Correction Factor(dB) = Receiver Antenna Gain(dBi) + Cable Loss(dB) + Free Space Loss(dB)

4.3 FREQUENCY STABILITY MEASUREMENT

4.3.1 LIMITS OF FREQUENCY STABILITY MEASUREMENT

According to the FCC part 2.4235 shall be tested the frequency stability. The rule is defined that "The frequency stability shall be sufficient to ensure that the fundamental emission stays within the authorized frequency block." The frequency error rate is according to the JTC standard that the frequency error rate shall be accurate to within 0.1 ppm of the received frequency from the base station. The test extreme voltage is according to the 2.1055(d)(1) Vary primary supply voltage from 85 to 115 percent of the nominal value for other than hand carried battery equipment and the extreme temperature rule is comply with the 2.1055(a)(1) $-30^{\circ}\text{C} \sim 50^{\circ}\text{C}$.

4.3.2 TEST INSTRUMENTS

DESCRIPTION & MANUFACTURER	MODEL NO.	SERIAL NO.	CALIBRATED UNTIL
<input type="checkbox"/> ROHDE & SCHWARZ Universal Radio Communication Tester	CMU200	836072/086	Apr. 21, 2004
* Hewlett Packard RF cable	8120-6192	01428251	NA
* Suhner RF cable	Sucoflex104	204850/4	NA
*WIT Standard Temperature & Humidity Chamber	TH-4S-C	W981030	Jul. 12, 2004

NOTE: 1. The calibration interval of the above test instruments is 12 months. And the calibrations are traceable to NML/ROC and NIST/USA.

2. "*" = These equipments are used for the final measurement.
3. The test was performed in ADT RF OVEN room.

4.3.3 TEST PROCEDURE

- a. Because of the measure the carrier frequency under the condition of the AFC lock, it shall be used the mobile station in the GRRP link mode. This is accomplished with the use of the R&S CMU200 simulator station. The oven room could control the temperatures and humidity. The GPRS link channel is the 661.
- b. Power must be removed when changing from one temperature to another or one voltage to another voltage. Power warm up is at least 15 min and power applied should perform before recording frequency error.
- c. EUT is connected the external power supply to control the DC input power. The various Volts from the minimum 3.3 Volts to 4.2 Volts. Each step shall be record the frequency error rate.
- d. The temperature range step is 10 degrees in this test items. All temperature levels shall be hold the $\pm 0.5^{\circ}\text{C}$ during the measurement testing.
- e. The each temperature step shall be at least 0.5 hours, consider the EUT could be test under the stability condition.

REMARKS: 1. The frequency error was recorded frequency error from the GSM simulator.

4.3.4 TEST SETUP

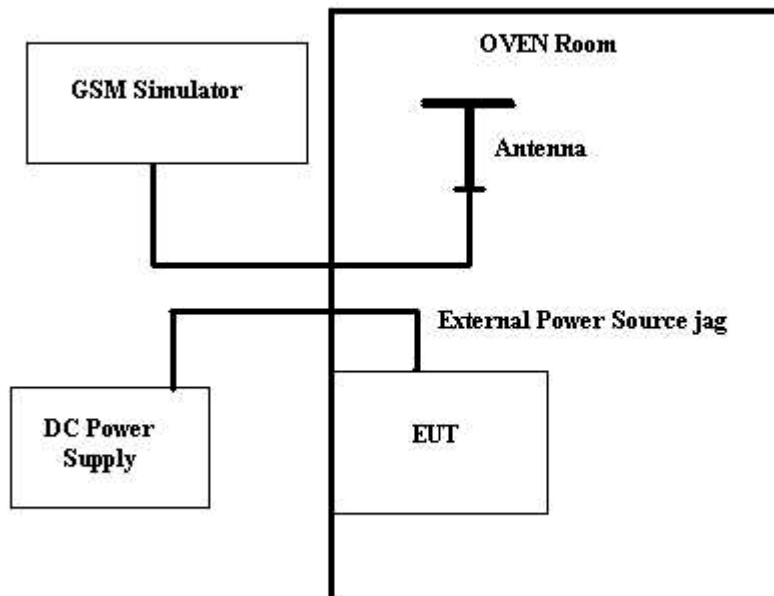

4.3.5 TEST RESULTS

EUT	Mobile Phone	MODEL	8055T(2042S3)
MODE	TX connected	POWER CONTROL LEVEL	0
INPUT POWER (SYSTEM)	120Vac, 60 Hz	DETECTOR FUNCTION	500 Bursts
ENVIRONMENTAL CONDITIONS	23 deg. C, 65 % RH, 999 hPa	TESTED BY: Cody Chang	

AFC FREQUENCY ERROR vs. VOLTAGE			
Voltage (Volts)	Frequency Error (Hz)	Frequency Error (ppm)	Limit(ppm)
3.4	43	0.0229	0.1
3.5	41	0.0218	0.1
3.6	28	0.0149	0.1
3.7	26	0.0138	0.1
3.8	28	0.0149	0.1
3.9	29	0.0154	0.1
4.0	28	0.0149	0.1
4.1	31	0.0165	0.1
4.2	29	0.0154	0.1
3.3	43	0.0229	0.1
3.2	47	0.0250	0.1
4.3	27	0.0144	0.1
4.4	30	0.0160	0.1

EUT	Mobile Phone	MODEL	8055T(2042S3)
MODE	TX channel 661	POWER CONTROL LEVEL	0
INPUT POWER (SYSTEM)	120Vac, 60 Hz	DETECTOR FUNCTION	500 Bursts
ENVIRONMENTAL CONDITIONS	23 deg. C, 65 % RH, 999 hPa	TESTED BY: Cody Chang	

AFC FREQUENCY ERROR vs. TEMPERATURE			
Temp. (°C)	Frequency Error (Hz)	Frequency Error (ppm)	Limit(ppm)
50	42	0.022	0.1
40	32	0.017	0.1
30	23	0.012	0.1
20	10	0.005	0.1
10	32	0.017	0.1
0	29	0.015	0.1
-10	6	0.003	0.1
-20	18	0.010	0.1
-30	21	0.011	0.1

4.4 OCCUPIED BANDWIDTH MEASUREMENT

4.4.1 LIMITS OF OCCUPIED BANDWIDTH MEASUREMENT

According to FCC 24.238(b) specified that emission bandwidth is defined as the width of the signal between two points, one below the carrier center frequency and one above the carrier center frequency, outside of which all emissions are attenuated at least 26 dB below the transmitter power.

4.4.2 TEST INSTRUMENTS

DESCRIPTION & MANUFACTURER	MODEL NO.	SERIAL NO.	CALIBRATED UNTIL
* ROHDE & SCHWARZ Spectrum Analyzer	FSP40	100035	Apr. 15, 2004
* ROHDE & SCHWARZ Universal Radio Communication Tester	CMU200	836072/086	Apr. 21, 2004
* Mini-Circuits Power Splitter	ZAPD-4	400005	NA
* Hewlett Packard RF cable	8120-6192	01428251	NA
* JFW 20dB attenuation	50HF-020-SMA	NA	NA
* Suhner RF cable	Sucoflex104	204850/4	NA

NOTE: 1. The calibration interval of the above test instruments is 12 months. And the calibrations are traceable to NML/ROC and NIST/USA.

2. "*" = These equipments are used for the final measurement.

4.4.3 TEST SETUP

Same as Item 4.2.4 (Conducted Power Setup)

4.4.4 TEST PROCEDURES

- a. The EUT was set up for the maximum peak power with GPRS link data modulation. The power was measured with R&S Spectrum Analyzer. All measurements were done at 3 channels, 512, 661 and 810(low, middle and high operational frequency range.)
- b. The conducted occupied bandwidth used the power splitter via EUT RF power connector between simulation base station and spectrum analyzer. This splitter loss and cable loss are the worst loss 4dB in the transmitted path track.
- c. FCC 24.238(b) required a measurement bandwidth is the fundamental emission below 26dB bandwidth.

4.4.5 EUT OPERATING CONDITION

- a. The EUT makes a phone call to the GSM simulator.
- b. The GSM simulator station system controlled a EUT to export maximum and minimum output power under transmission mode and specific channel frequency Same as Item 4.4.5

4.4.6 TEST RESULTS

Frequency (MHz)	Max. Output Power -26 dBc Bandwidth (kHz)	Min. Output Power -26 dBc Bandwidth (kHz)
1850.2	314	310
1880.0	308	308
1909.8	316	316

**Channel 512 Max. Power
-26 dBc Bandwidth**

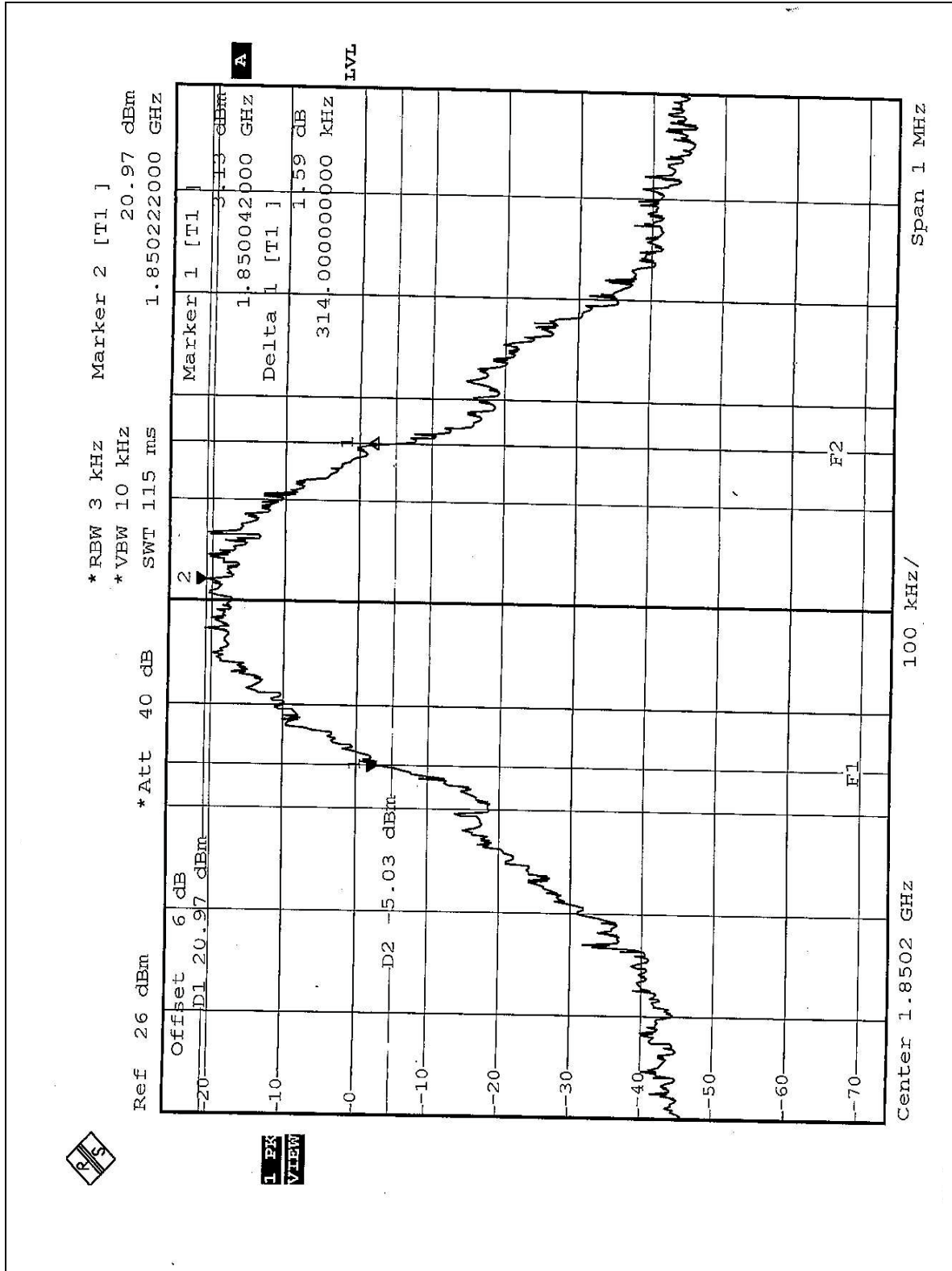

Channel 512 Min. Power -26 dBc Bandwidth

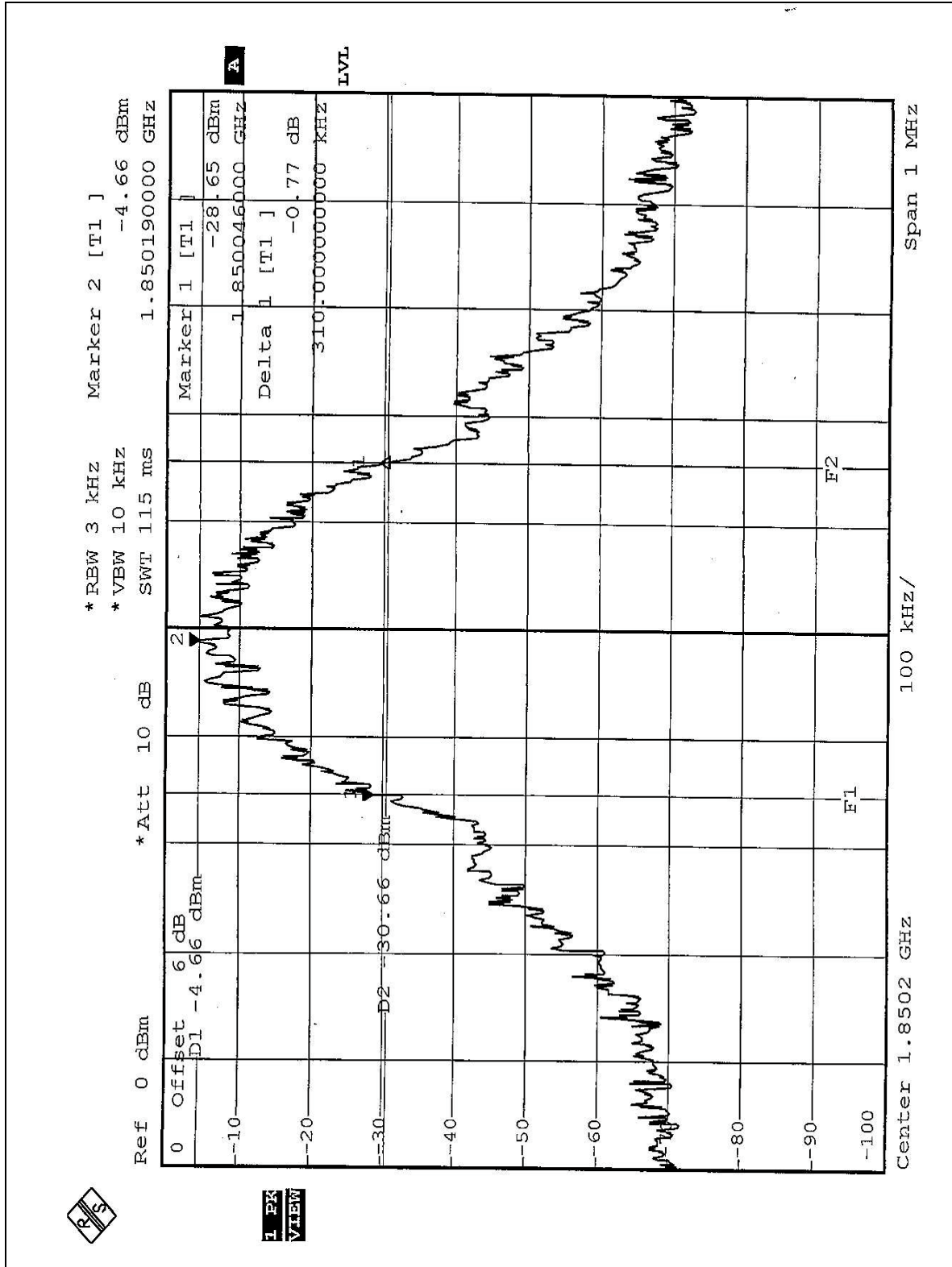

**Channel 661 Max. Power
-26 dBc Bandwidth**

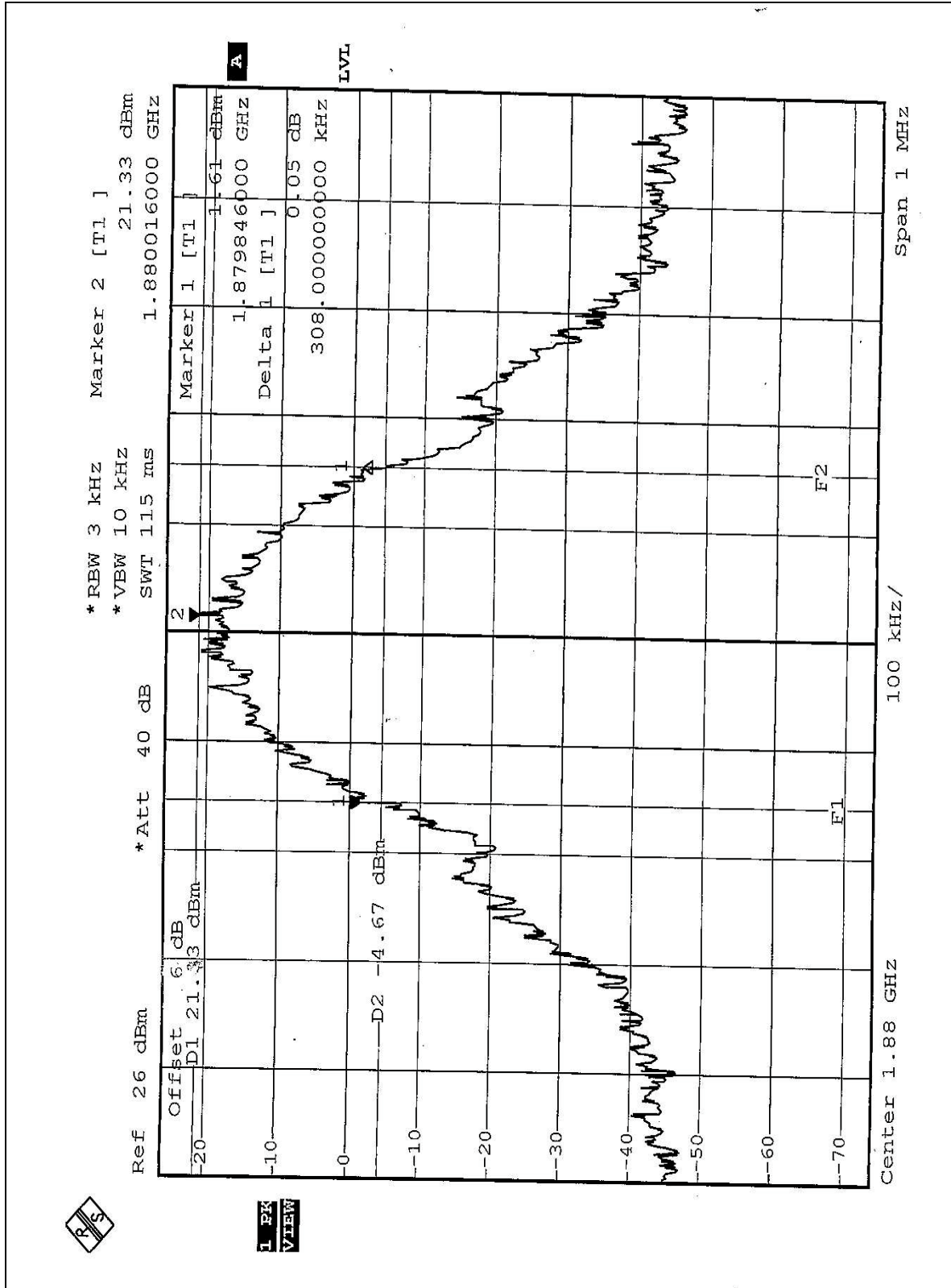

Channel 661 Min. Power -26 dBc Bandwidth

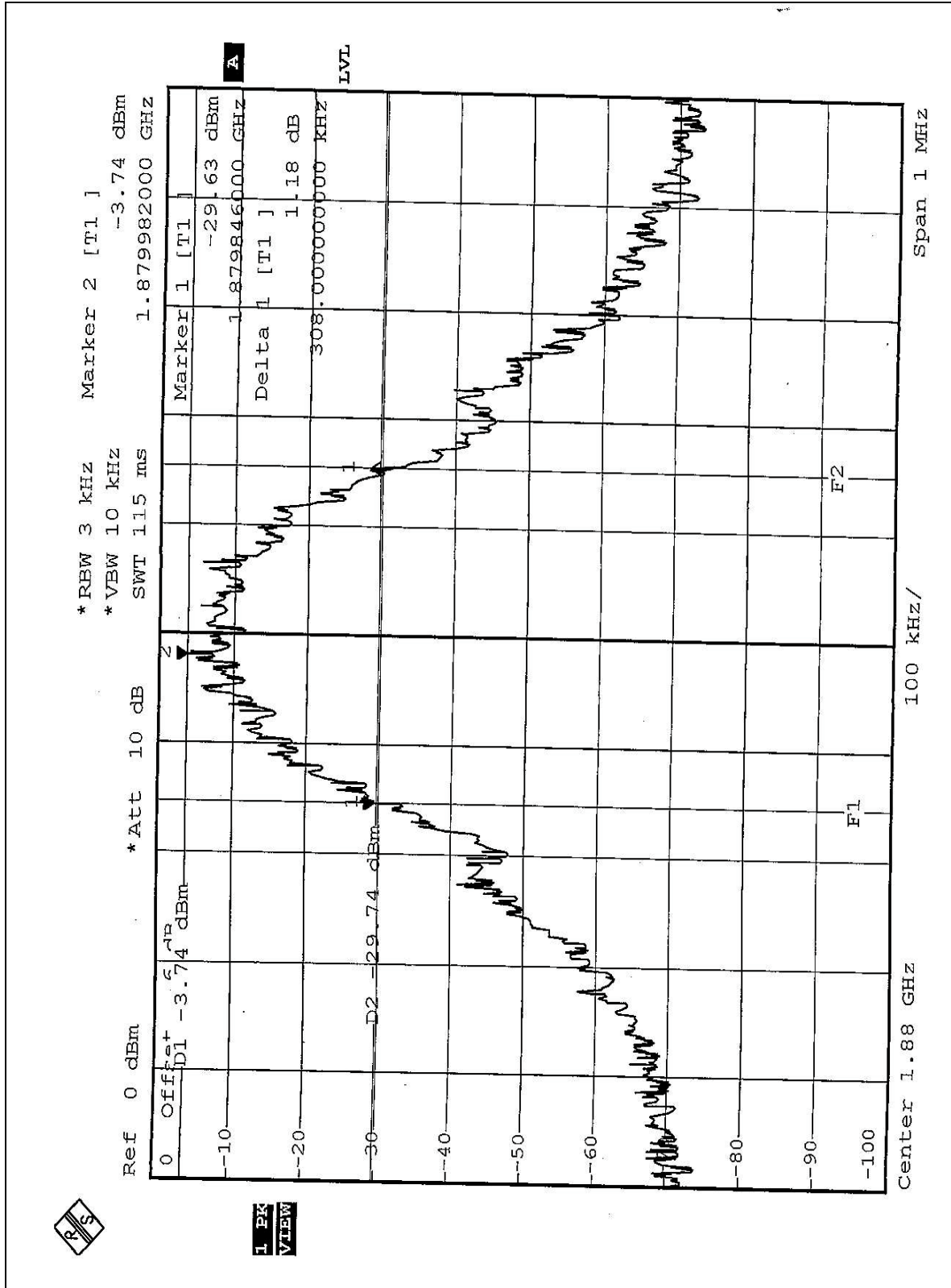

**Channel 810 Max. Power
-26 dBc Bandwidth**

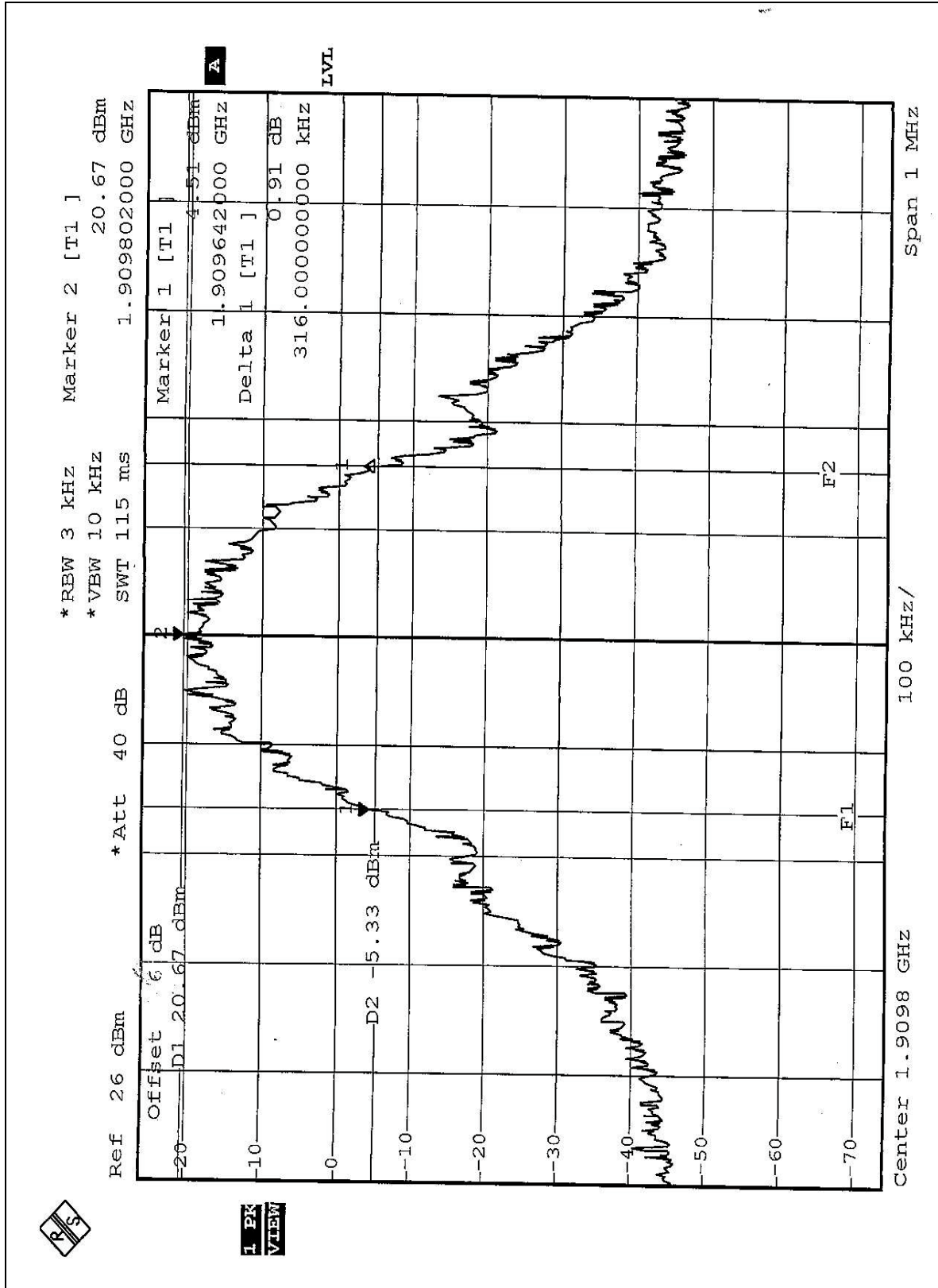

**Channel 810 Min. Power
-26 dBc Bandwidth**

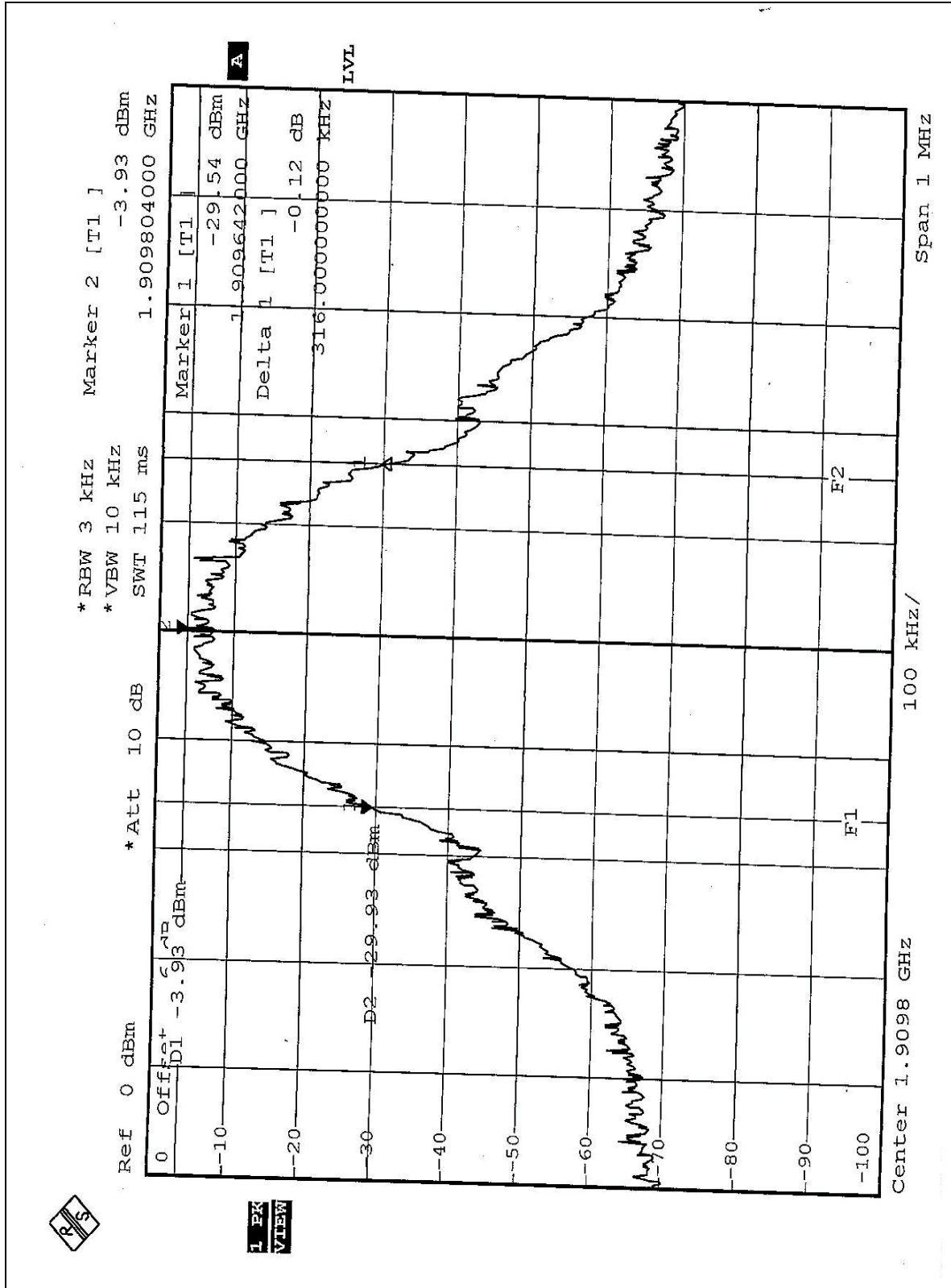

4.5 BAND EDGE MEASUREMENT

4.5.1 LIMITS OF BAND EDGE MEASUREMENT

The PCS frequency bands refer to the FCC 24.229 rule. According to FCC 24.238(b) specified that emission bandwidth is defined as the width of the signal between two points, one below the carrier center frequency and one above the carrier center frequency, outside of which all emissions are attenuated at least 26 dB below the transmitter power. In the 1 MHz bands immediately outside and adjacent to the frequency block a resolution bandwidth of at least one percent of the emission bandwidth of the fundamental emission of the transmitter may be employed. Then we measure that the bandwidth is about 300kHz and the resolution bandwidth is 3kHz.

4.5.2 TEST INSTRUMENTS

DESCRIPTION & MANUFACTURER	MODEL NO.	SERIAL NO.	CALIBRATED UNTIL
* ROHDE & SCHWARZ Spectrum Analyzer	FSP40	100035	Apr. 15, 2004
* ROHDE & SCHWARZ Universal Radio Communication Tester	CMU200	836072/086	Apr. 21, 2004
* Mini-Circuits Power Splitter	ZAPD-4	400005	NA
* Hewlett Packard RF cable	8120-6192	01428251	NA
* JFW 20dB attenuation	50HF-020-SMA	NA	NA
* Suhner RF cable	Sucoflex104	204850/4	NA

- NOTE:** 1. The calibration interval of the above test instruments is 12 months. And the calibrations are traceable to NML/ROC and NIST/USA.
 2. "*" = These equipments are used for the final measurement.

4.5.3 TEST SETUP

Same as Item 4.2.4 (Conducted Power Setup)

4.5.4 TEST PROCEDURES

- a. The EUT was set up for the maximum peak power with GPRS link data modulation. The power was measured with R&S Spectrum Analyzer. All measurements were done at 2 channels, 512 and 810(low and high operational frequency range.)
- b. The band edge measurement used the power splitter via EUT RF power connector between simulation base station and spectrum analyzer. This splitter loss and cable loss are the worst loss 4dB in the transmitted path track.
- c. The center frequency of spectrum is the band edge frequency and span is 2 MHz. RB of the spectrum is 3kHz and VB of the spectrum is 10KHz.
- d. Record the max trace plot into the test report.

4.5.5 EUT OPERATING CONDITION

- a. The EUT makes a phone call to the GSM simulator.
- b. The GSM simulator station system controlled a EUT to export maximum output power under transmission mode and specific channel frequency Same as Item 4.4.5.

4.5.6 TEST RESULTS

Lower Band Edge

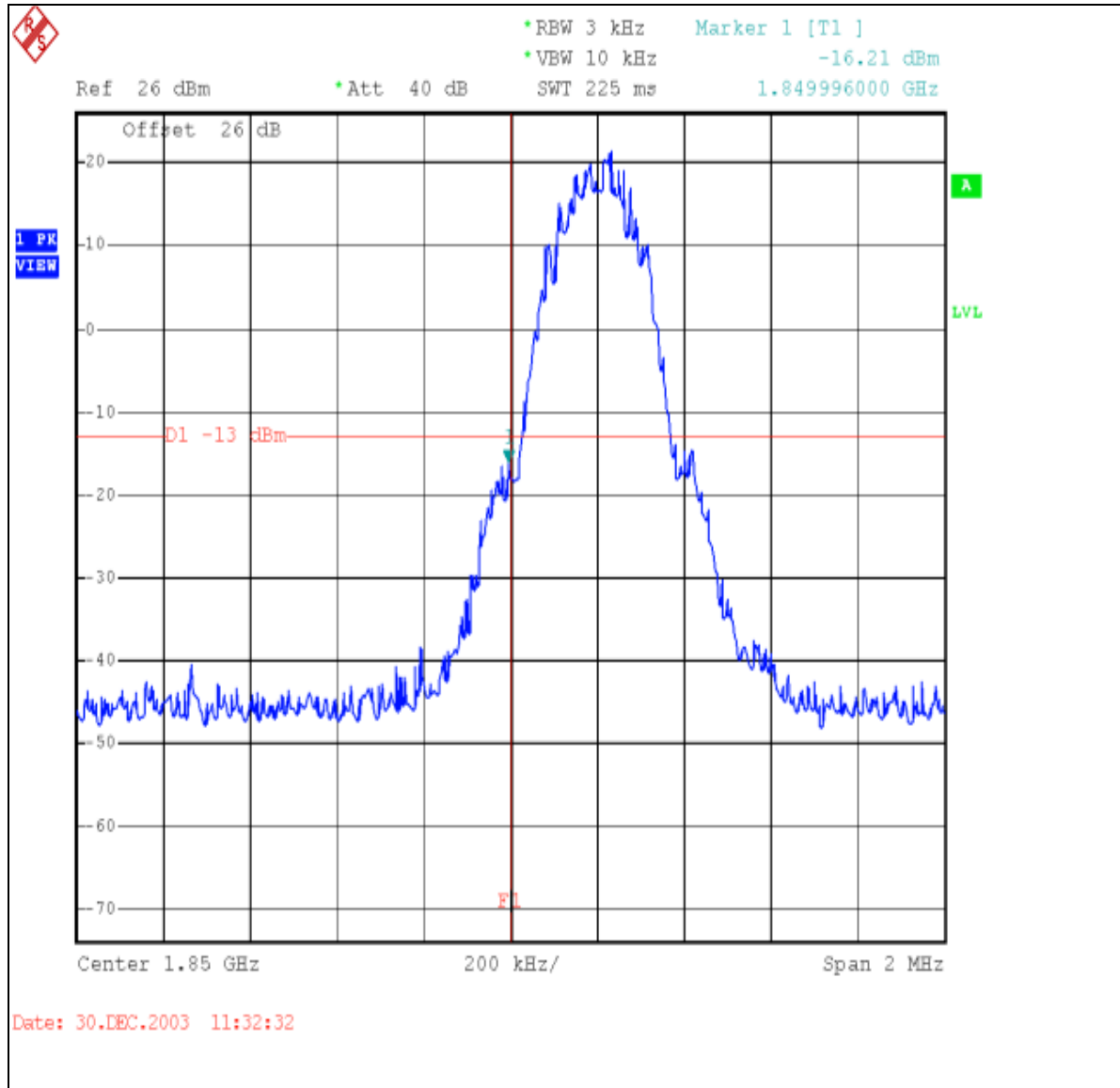

Higher Band Edge

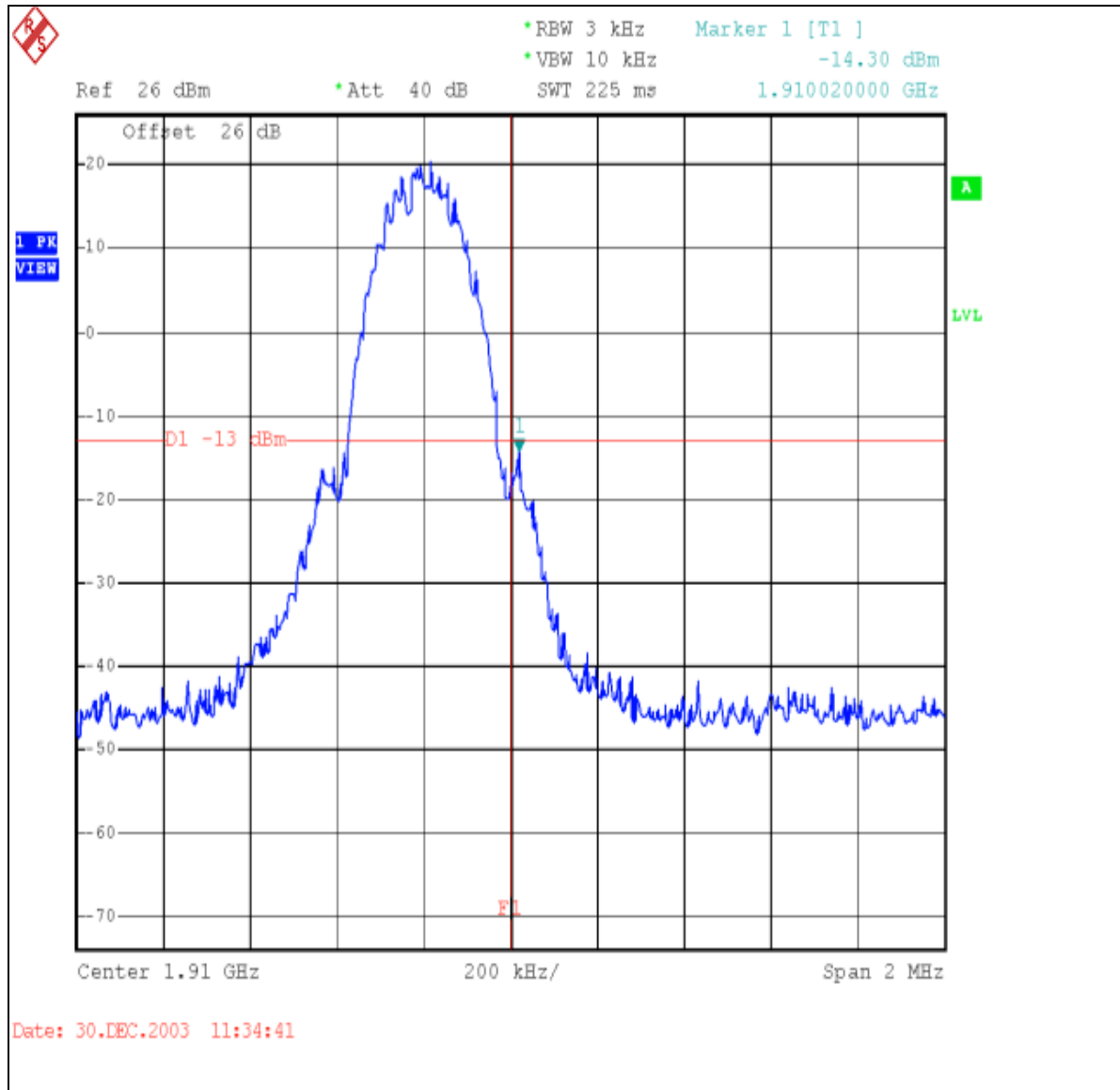

4.6 CONDUCTED SPURIOUS EMISSIONS

4.6.1 LIMITS OF CONDUCTED SPURIOUS EMISSIONS MEASUREMENT

In the FCC 24.238(a), On any frequency outside a licensee’s frequency block within USPCS spectrum, the power of any emission shall be attenuated below the transmitter power (P) by at least $43 + 10 \log (P)$ dB. The limit translates in the relevant power range (1 to 0.001W). At 1W(Power Control Level 0) the specified minimum attenuation becomes 43dB and the limit of emission equal to -13dBm . At 0.001W(Power Control Level 15) the specified minimum attenuation becomes 13dB and the emission of limit equal to -13dBm . So the limit of emission is the same absolute specified line. In the FCC 24.238(c), When measuring the emission limits, the nominal carrier frequency shall be adjusted as close to the licensee’s frequency block edges (low channel 512 and high channel 810), both upper and lower edges are compliance with FCC 24.238(b), Adjacent to the frequency block a resolution bandwidth of at least one percent of the emission bandwidth of the fundamental emission of the transmitter may be employed.

4.6.2 TEST INSTRUMENTS

DESCRIPTION & MANUFACTURER	MODEL NO.	SERIAL NO.	CALIBRATED UNTIL
* ROHDE & SCHWARZ Spectrum Analyzer	FSP40	100035	Apr. 15, 2004
* ROHDE & SCHWARZ Signal Generator	SMP04	10001	May 05, 2004
* ROHDE & SCHWARZ Universal Radio Communication Tester	CMU200	836072/086	Apr. 21, 2004
* Wainwright Instruments Band Reject Filter	WRCG1850/1910- 1830/1930- 60/10SS	SN1	NA
* Wainwright Instruments High Pass Filter	WHK3.1/18G-10SS	SN1	NA
* Mini-Circuits Power Splitter	ZAPD-4	400005	NA
* Hewlett Packard RF cable	8120-6192	01428251	NA
* JFW 20dB attenuation	50HF-020-SMA	NA	NA
* Suhner RF cable	Sucoflex104	204850/4	NA

- NOTE:** 1. The calibration interval of the above test instruments is 12 months. And the calibrations are traceable to NML/ROC and NIST/USA.
 2. “*” = These equipments are used for the final measurement.

4.6.3 TEST PROCEDURE

- a. The EUT was set up for the maximum peak power with GPRS link data modulation. The power was measured with R&S Spectrum Analyzer. All measurements were done at 3 channels, 512, 661 and 810(low, middle and high operational frequency range.)
- b. The conducted spurious emission used the power splitter via EUT RF power connector between simulation base station and spectrum analyzer. This splitter loss and cable loss are the worst loss 4dB in the transmitted path track.
- c. When the spectrum scanned from 9kHz to 3GHz, it shall be connected to the band reject filter attenuated the carried frequency. The spectrum set RB/VB 1MHz.
- d. When the spectrum scanned from 3kHz to 20GHz, it shall be connected to the high pass filter attenuated the carried frequency. The spectrum set RB/VB 1MHz.

4.6.4 TEST SETUP

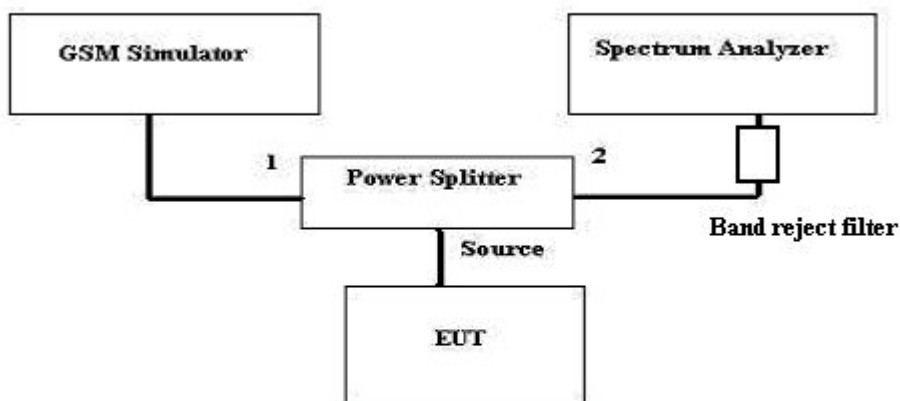

4.6.5 EUT OPERATING CONDITIONS

- a. The EUT makes a phone call to the GSM simulator.
- b. The GSM simulator station system controlled a EUT to export maximum output power under transmission mode and specific channel frequency.

4.6.6 TEST RESULTS

Channel 512 9kHz~3GHz

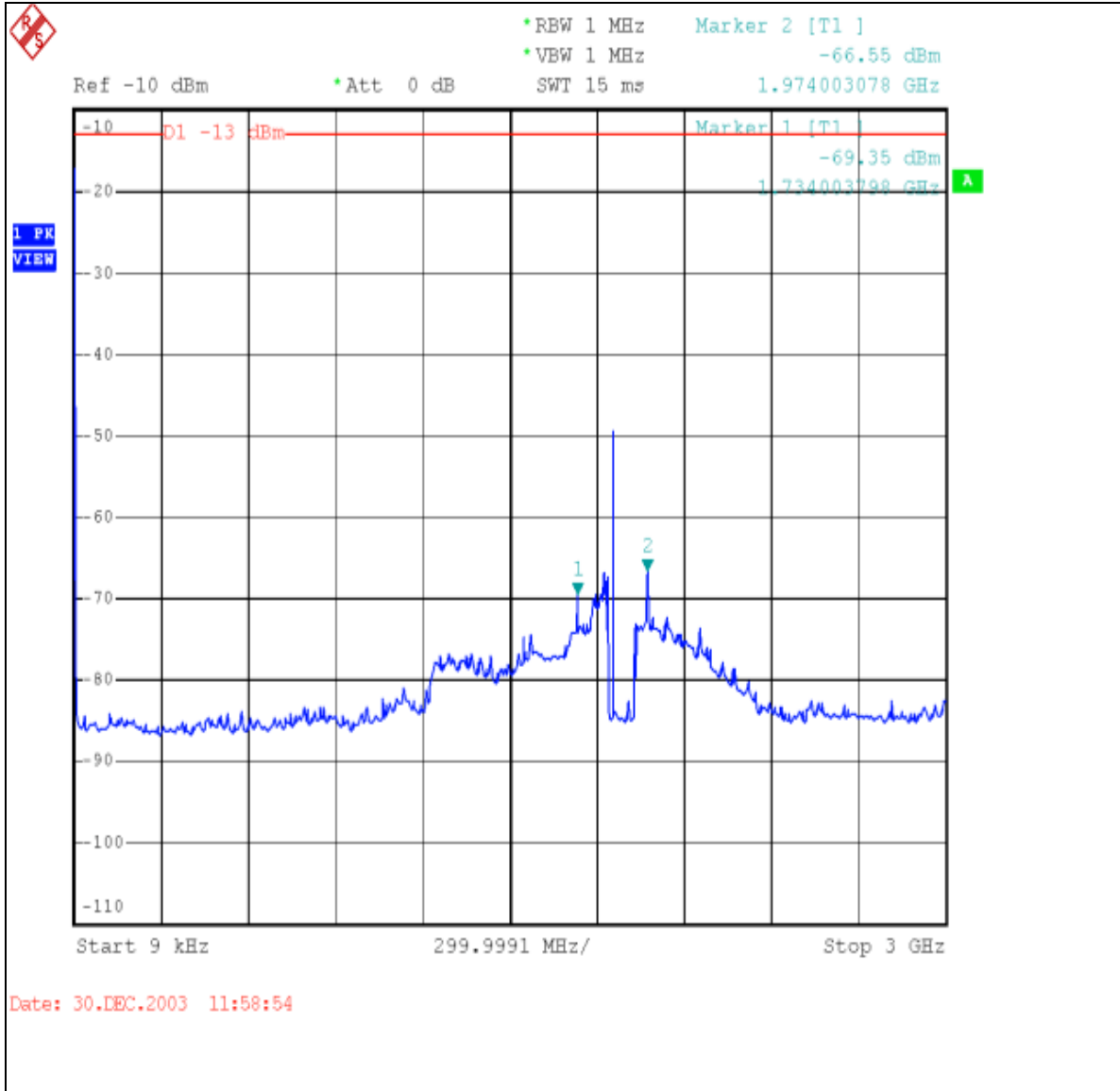

Channel 512 3GHz~10GHz

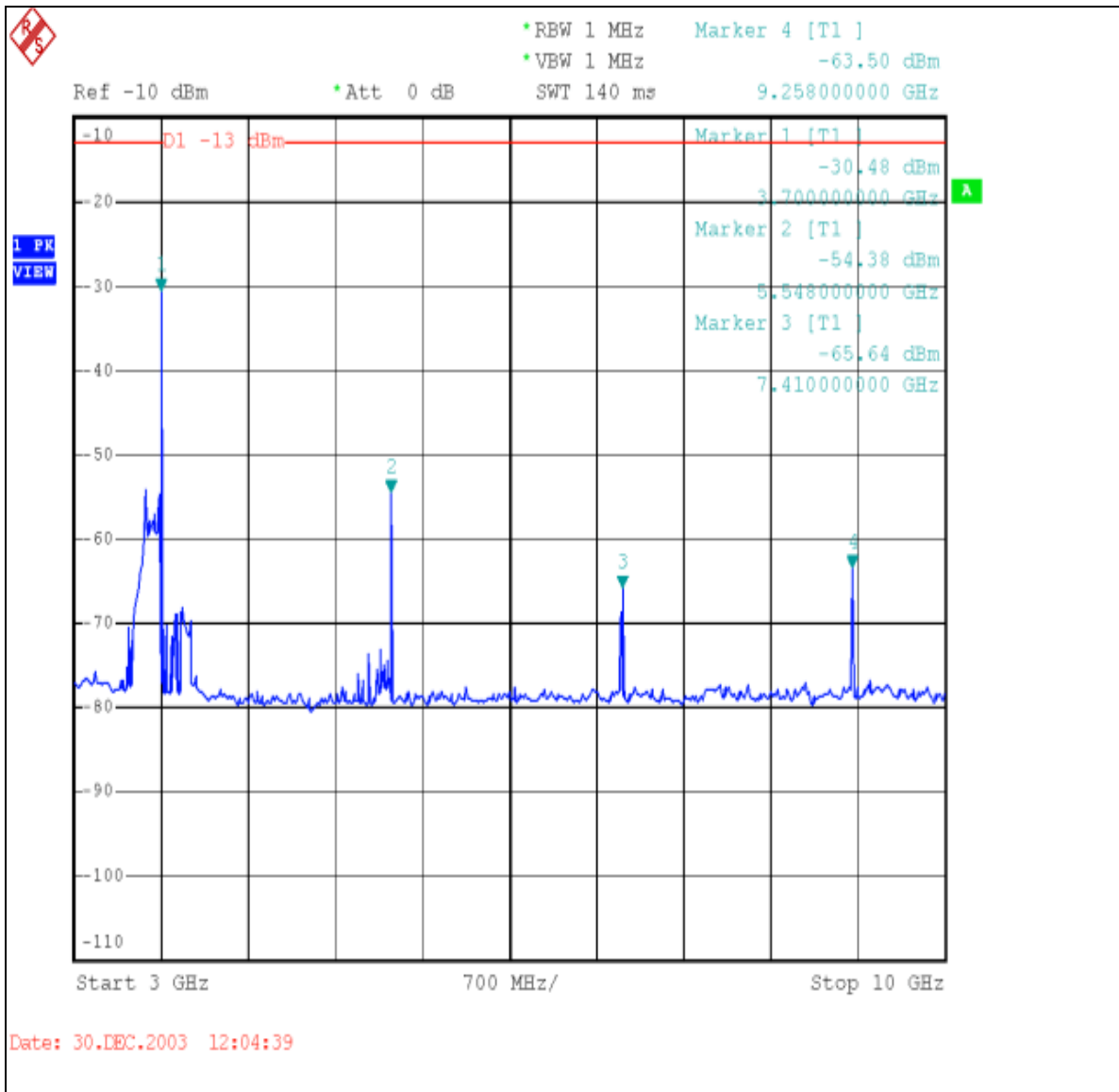

Channel 512 10GHz~20GHz

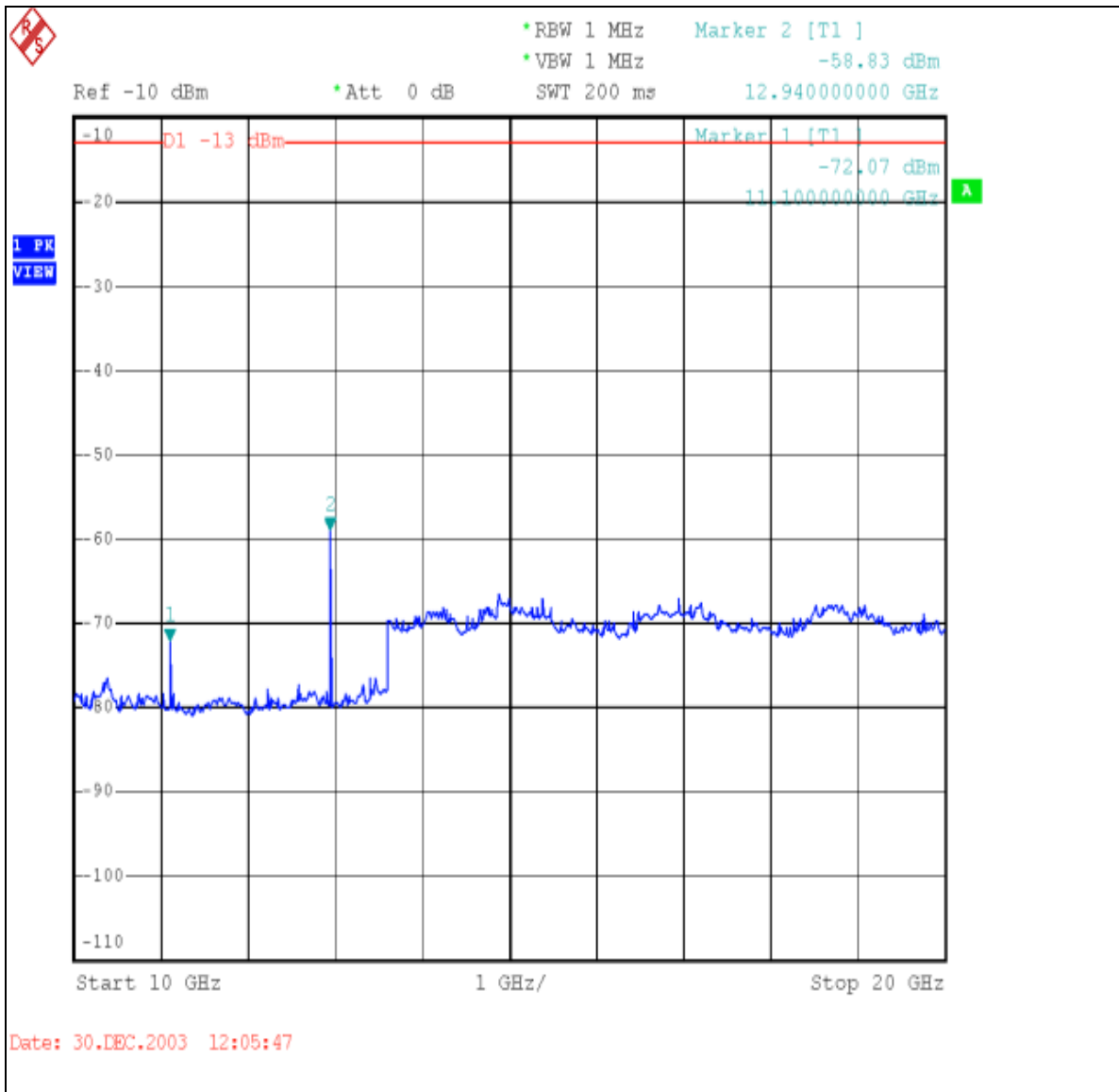

Channel 661 9kHz~3GHz

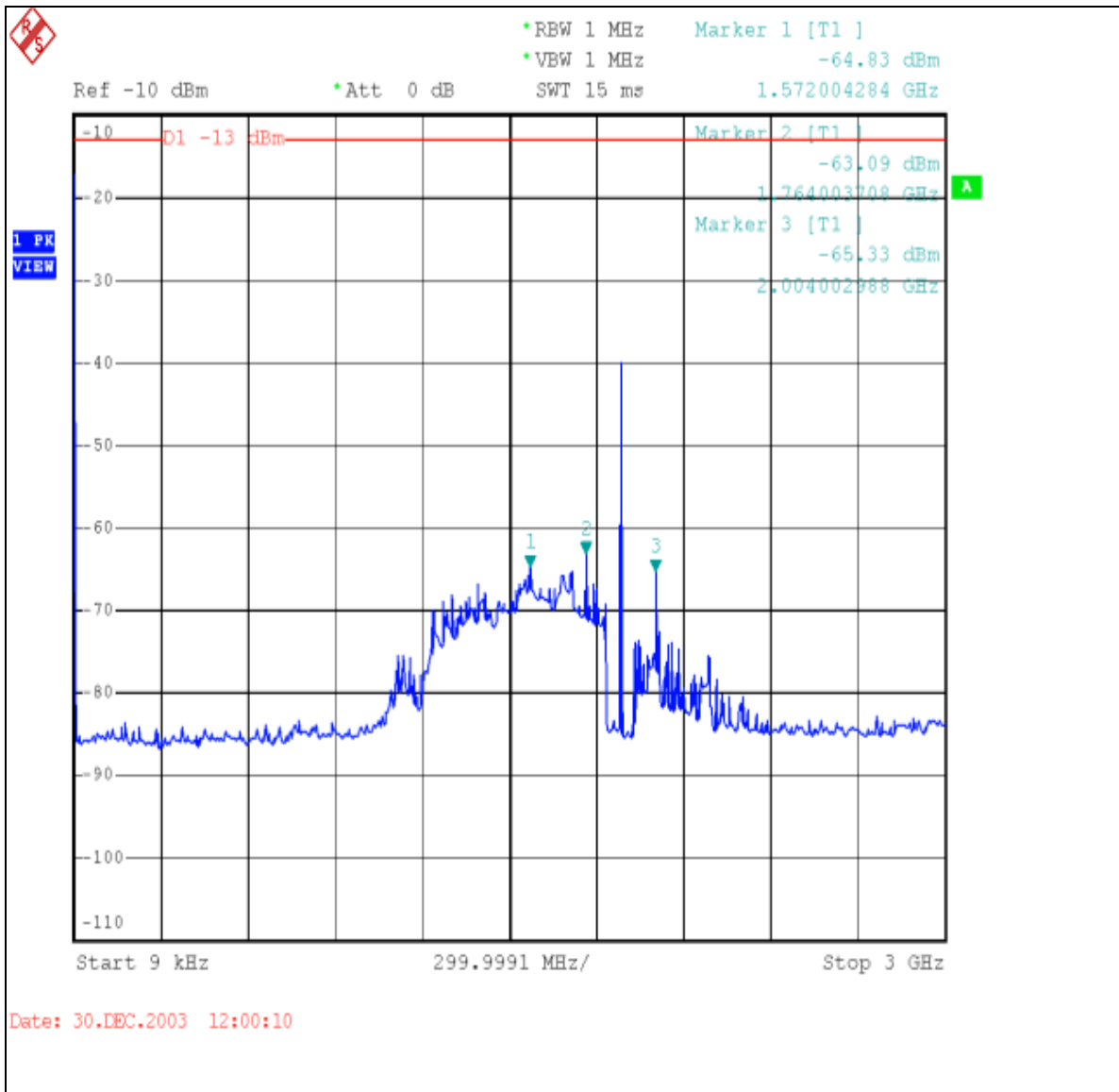

Channel 661 3GHz~10GHz

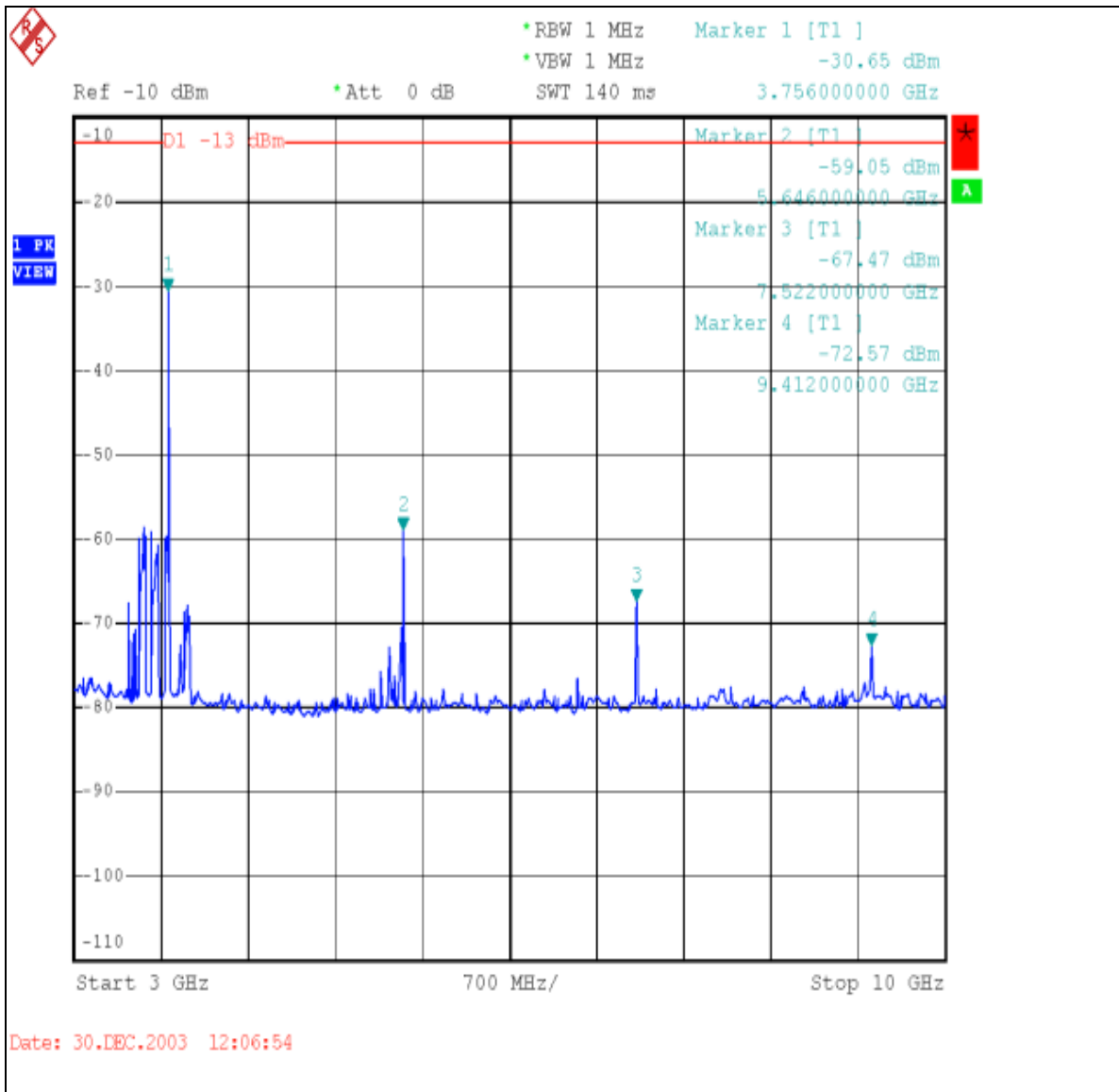

Channel 661
10GHz~20GHz

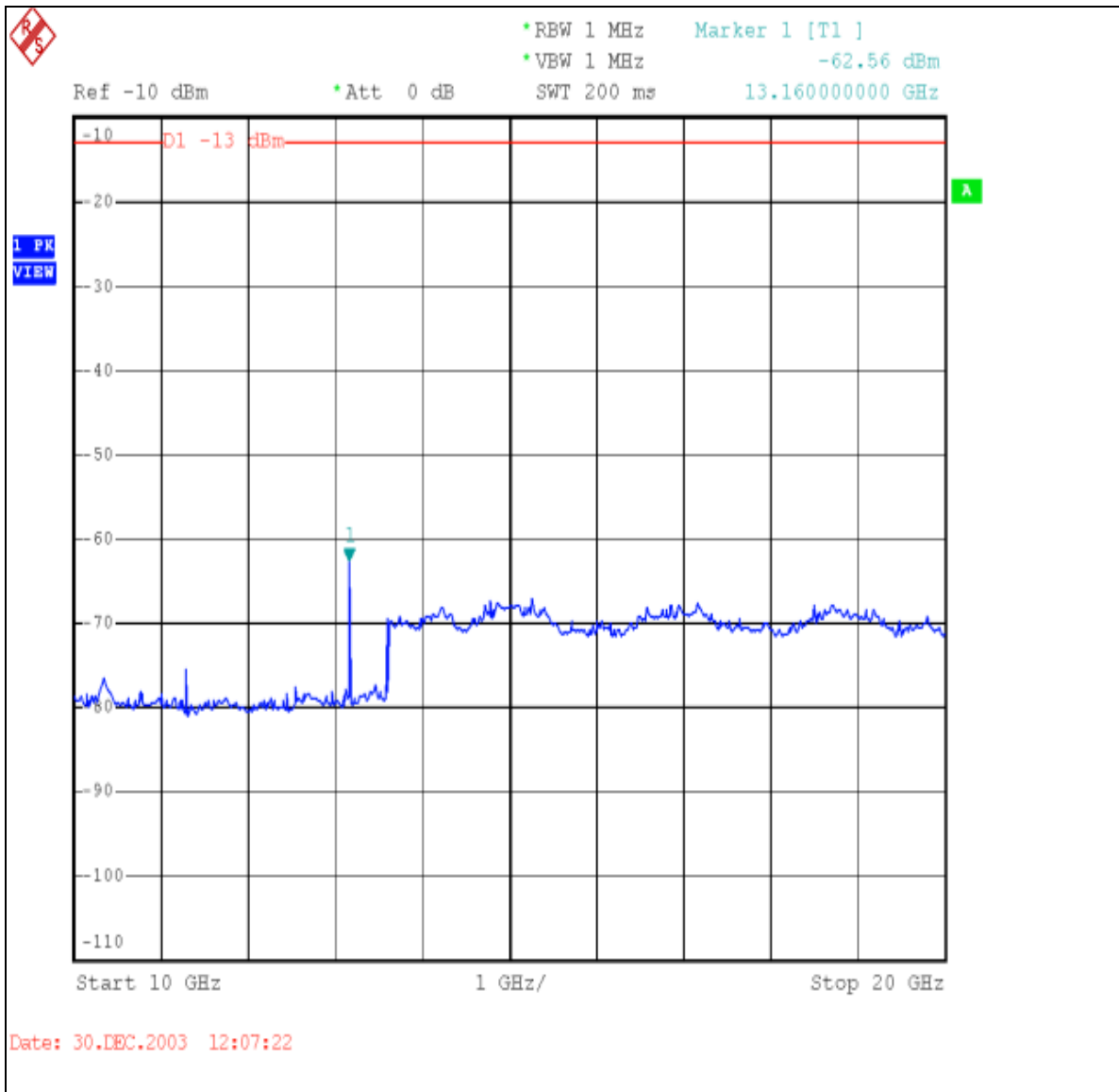

Channel 810 9kHz~3GHz

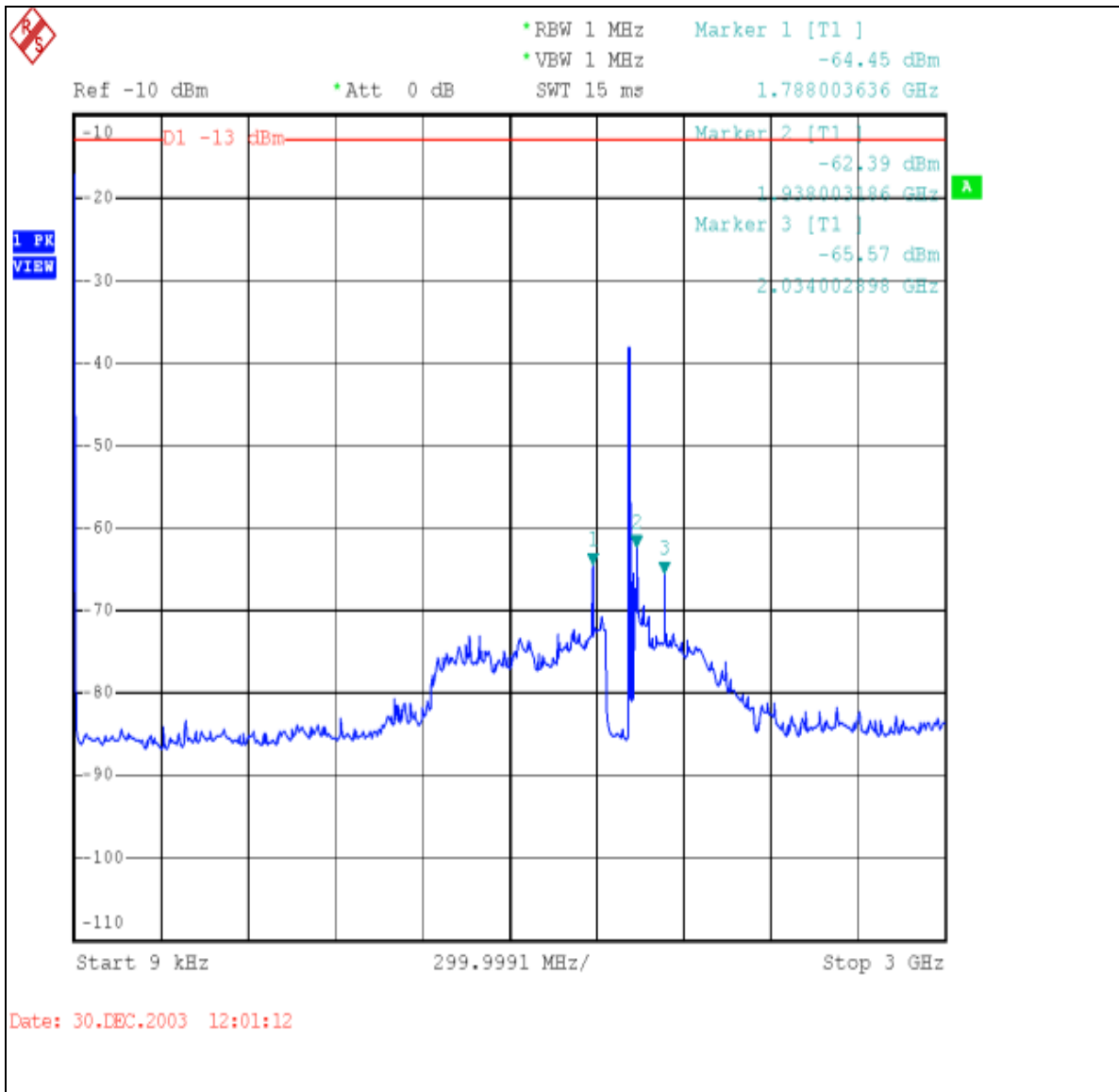

Channel 810 3GHz~10GHz

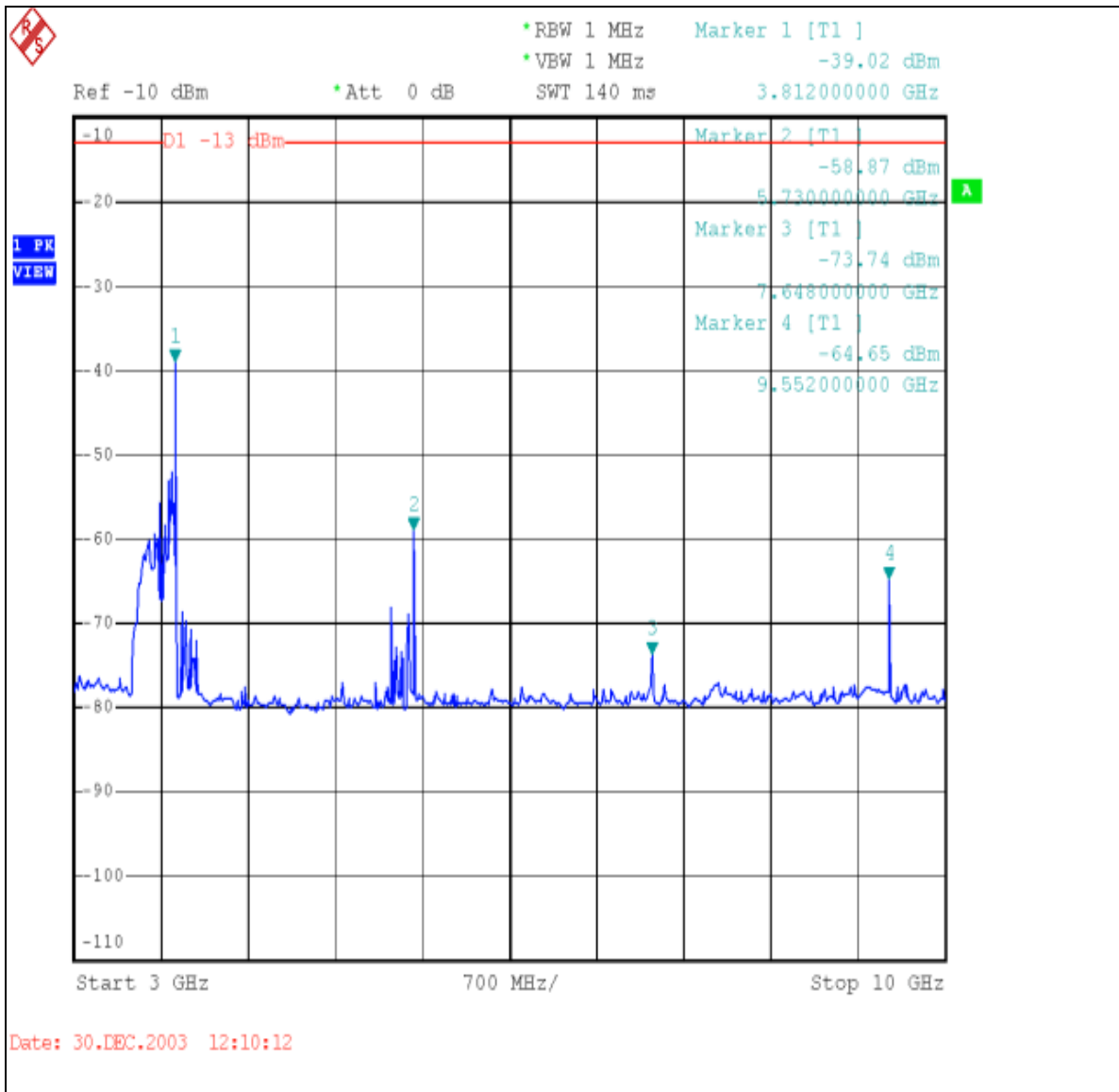

Channel 810 10GHz~20GHz

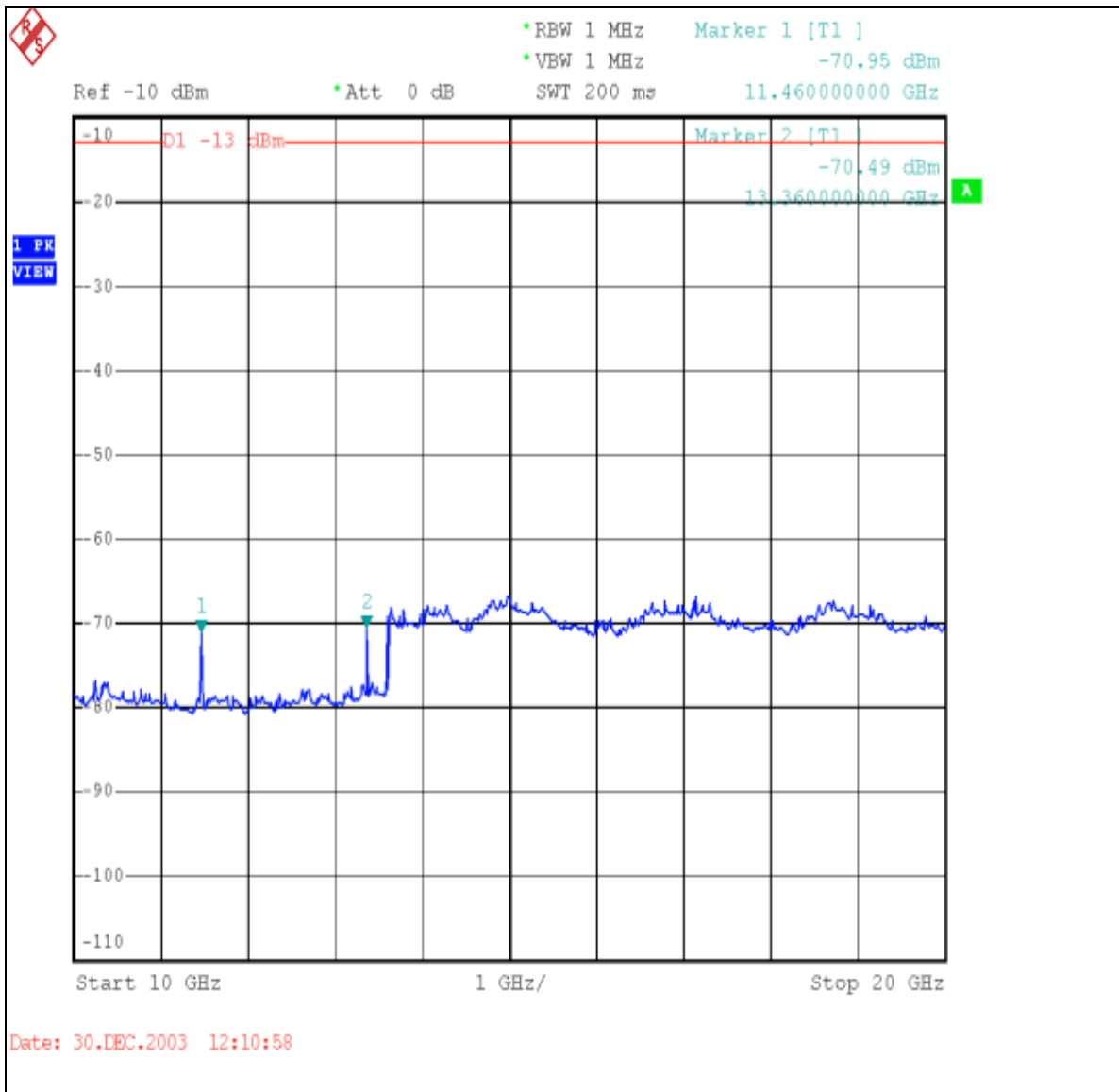

EUT	Mobile Phone	MODEL	8055T(2042S3)
MODE	Tx Channel 512	POWER CONTROL LEVEL	0
INPUT POWER (SYSTEM)	120Vac, 60 Hz	DETECTOR FUNCTION	Peak
ENVIRONMENTAL CONDITIONS	23 deg. C, 65 % RH, 991 hPa	TESTED BY: Cody Chang	

CONDUCTED SPURIOUS EMISSION					
Frequency (MHz)	Raw (dBm)	Correction Factor(dB)	Conducted Level(dBm)	Limit (dBm)	Margin
1974	-66.55	4.20	-62.35	-13.00	-49.35
1734	-69.35	4.10	-65.25	-13.00	-52.25
3200	-30.48	5.10	-25.38	-13.00	-12.38
5548	-54.38	11.40	-42.98	-13.00	-29.98
7410	-65.64	9.10	-56.54	-13.00	-43.54
9258	-63.50	8.20	-55.30	-13.00	-42.30
11100	-58.83	10.30	-48.53	-13.00	-35.53
12940	-72.07	8.00	-64.07	-13.00	-51.07

REMARKS:

1. Peak Output Power(dBm)=Raw Value(dBm) + Correction Factor(dB)
2. Correction Factor(dB) = Power Splitter Loss(dB) + Cable Loss(dB)

EUT	Mobile Phone	MODEL	8055T(2042S3)
MODE	Tx Channel 661	POWER CONTROL LEVEL	0
INPUT POWER (SYSTEM)	120Vac, 60 Hz	DETECTOR FUNCTION	Peak
ENVIRONMENTAL CONDITIONS	23 deg. C, 65 % RH, 991 hPa	TESTED BY: Cody Chang	

CONDUCTED SPURIOUS EMISSION					
Frequency (MHz)	Raw (dBm)	Correction Factor(dB)	Conducted Level(dBm)	Limit (dBm)	Margin
1572	-64.83	6.20	-58.63	-13.00	-45.63
1764	-63.09	4.20	-58.89	-13.00	-45.89
2004	-65.33	4.40	-60.93	-13.00	-47.93
3756	-30.65	5.10	-25.55	-13.00	-12.55
5646	-59.05	10.10	-48.95	-13.00	-35.95
7522	-67.47	9.10	-58.37	-13.00	-45.37
9412	-72.57	8.30	-64.27	-13.00	-51.27
13160	-62.56	7.60	-54.96	-13.00	-41.96

REMARKS:

1. Peak Output Power(dBm)=Raw Value(dBm) + Correction Factor(dB)
2. Correction Factor(dB) = Power Splitter Loss(dB) + Cable Loss(dB)

EUT	Mobile Phone	MODEL	8055T(2042S3)
MODE	Tx Channel 810	POWER CONTROL LEVEL	0
INPUT POWER (SYSTEM)	120Vac, 60 Hz	DETECTOR FUNCTION	Peak
ENVIRONMENTAL CONDITIONS	23 deg. C, 65 % RH, 991 hPa	TESTED BY: Cody Chang	

CONDUCTED SPURIOUS EMISSION					
Frequency (MHz)	Raw (dBm)	Correction Factor(dB)	Conducted Level(dBm)	Limit (dBm)	Margin
1788	-64.45	4.20	-60.25	-13.00	-47.25
1938	-62.39	4.20	-58.19	-13.00	-45.19
2034	-65.57	4.40	-61.17	-13.00	-48.17
3812	-39.02	5.20	-33.82	-13.00	-20.82
2730	-58.87	12.30	-46.57	-13.00	-33.57
7648	-73.74	9.20	-64.54	-13.00	-51.54
9552	-64.65	8.50	-56.15	-13.00	-43.15

REMARKS:

1. Peak Output Power(dBm)=Raw Value(dBm) + Correction Factor(dB)
2. Correction Factor(dB) = Power Splitter Loss(dB) + Cable Loss(dB)

4.7 RADIATED EMISSION MEASUREMENT

4.7.1. LIMITS OF RADIATED EMISSION MEASUREMENT

In the FCC 24.238(a), On any frequency outside a licensee's frequency block within USPCS spectrum, the power of any emission shall be attenuated below the transmitter power (P) by at least $43 + 10 \log (P)$ dB. The limit translates in the relevant power range (1 to 0.001W). At 1W(Power Control Level 0) the specified minimum attenuation becomes 43dB and the limit of emission equal to -13dBm . At 0.001W(Power Control Level 15) the specified minimum attenuation becomes 13dB and the emission of limit equal to -13dBm . So the limit of emission is the same absolute specified line.

4.7.2. TEST INSTRUMENTS

DESCRIPTION & MANUFACTURER	MODEL NO.	SERIAL NO.	CALIBRATED UNTIL
* HP Spectrum Analyzer	8594E	3911A07465	July 07, 2004
* HP Preamplifier	8447D	2432A03504	June 10, 2004
HP Preamplifier	8449B	3008A01201	Dec. 11, 2004
* HP Preamplifier	8449B	3008A01292	Aug. 11, 2004
SCHAFFNER Tunable Dipole Antenna	VHBA 9123	459	Jun. 26, 2004
SCHWARZBECK Tunable Dipole Antenna	UHA 9105	977	
* ROHDE & SCHWARZ TEST RECEIVER	ESMI	839013/007 839379/002	Feb. 13, 2004
*Schwarzbeck Antenna	VULB9168	137	Apr. 03, 2004
* SCHWARZBECK Horn Antenna	BBHA9120-D1	D130	June 30, 2004
*ADT. Turn Table	TT100	0306	NA
*ADT. Tower	AT100	0306	NA
*Software	ADT_Radiated_V 5.14	NA	NA
*TIMES RF cable	LL142	CABLE-CH6-01	Apr. 30, 2004

- NOTE:** 1. The calibration interval of the above test instruments is 12 months. And the calibrations are traceable to NML/ROC and NIST/USA.
2. "*" = These equipment are used for the final measurement.
3. The horn antenna and HP preamplifier (model: 8449B) are used only for the measurement of emission frequency above 1GHz if tested.
4. The test was performed in ADT Chamber No. 6.

4.7.3. TEST PROCEDURES

- a. The EUT was placed on the top of a rotating table 0.8 meters above the ground. The table was rotated 360 degrees to determine the position of the highest radiation.
- b. The EUT was set 10 meters away from the receiving antenna, which was mounted on antenna tower and its position at 0.8 m above the ground.
- c. For each suspected emission, the EUT was arranged to its worst case and the rotatable table was turned from 0 degrees to 360 degrees to find the maximum reading and recorded the value.
- d. The EUT is replaced by a horn antenna connected to a signal generator tuned to the frequency of emission.
- e. The signal generator level has to be adjusted to have the same emission nature.
- f. The radiated power can be calculated via the factor and antenna gain.
- g. Repeat step 1-6 for horizontal polarization.

NOTE: 1. The resolution bandwidth of spectrum analyzer is 10 kHz and the video bandwidth is 300 kHz for spurious emission below 1GHz.
2. The resolution bandwidth of spectrum analyzer is 1 MHz and the video bandwidth is 3 MHz for spurious emission above 1GHz.
3. The resolution bandwidth of spectrum analyzer is 100kHz and the video bandwidth is 100kHz for the transmitter output measurement.

4.7.4. DEVIATION FROM TEST STANDARD

No deviation

4.7.5. TEST SETUP

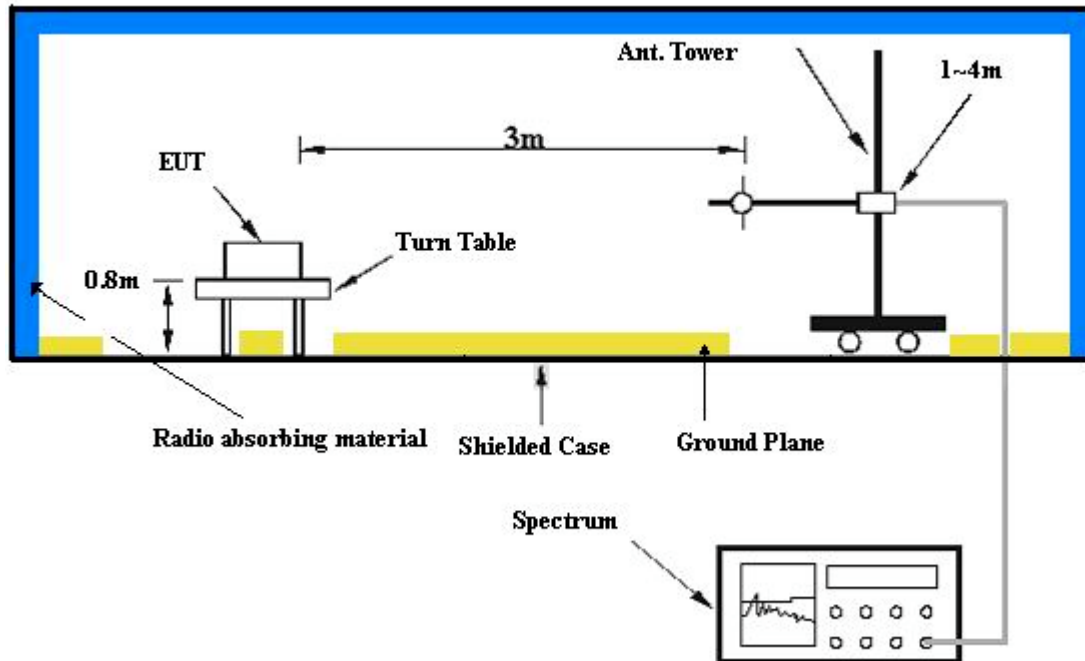

For the actual test configuration, please refer to the related item – Photographs of the Test Configuration.

4.7.6. EUT OPERATING CONDITIONS

- Plug the EUT in a notebook system placed on a testing table.
- The notebook system makes a phone call to the GSM simulator.
- The GSM simulator station system controlled an EUT to export maximum output power under transmission mode and specific channel frequency.
- The notebook system sent "H" messages to its screen.
- The notebook system sent "H" messages to modem.
- The notebook system sent "H" messages to printer, and the printer prints them on paper.
- Repeated d ~ f.

4.7.7. TEST RESULTS

EUT	Mobile Phone	MODEL	8055T(2042S3)
MODE	TX connected Mode A Channel 512	FREQUENCY RANGE	Below 1000 MHz
INPUT POWER (SYSTEM)	120Vac, 60 Hz	DETECTOR FUNCTION	Quasi-Peak
ENVIRONMENTAL CONDITIONS	25 deg. C, 60 % RH, 991 hPa	TESTED BY: Gary Chang	

ANTENNA POLARITY & TEST DISTANCE: HORIZONTAL AT 3 M								
No.	Freq. (MHz)	Emission Level (dBuV/m)	Limit (dBuV/m)	Margin (dB)	Antenna Height (m)	Table Angle (Degree)	Raw Value (dBuV)	Correction Factor (dB/m)
1	35.83	36.75 QP	80.84	-44.09	4.00 H	211	21.00	15.74
2	428.50	35.69 QP	80.84	-45.15	1.00 H	172	16.77	18.92
3	494.59	40.49 QP	80.84	-40.35	2.00 H	160	20.41	20.09
4	572.34	37.34 QP	80.84	-43.50	3.00 H	172	15.63	21.71
5	727.86	33.61 QP	80.84	-47.23	1.00 H	163	9.28	24.33
6	768.68	31.94 QP	80.84	-48.90	1.00 H	196	7.00	24.94

ANTENNA POLARITY & TEST DISTANCE: VERTICAL AT 3 M								
No.	Freq. (MHz)	Emission Level (dBuV/m)	Limit (dBuV/m)	Margin (dB)	Antenna Height (m)	Table Angle (Degree)	Raw Value (dBuV)	Correction Factor (dB/m)
1	49.44	39.03 QP	80.84	-41.81	1.00 V	7	23.16	15.87
2	428.50	35.01 QP	80.84	-45.83	1.00 V	130	16.09	18.92
3	494.59	42.07 QP	80.84	-38.77	1.00 V	247	21.98	20.09
4	558.74	40.31 QP	80.84	-40.53	1.00 V	253	18.96	21.36
5	624.83	34.75 QP	80.84	-46.09	1.00 V	343	12.02	22.73
6	663.71	31.32 QP	80.84	-49.52	1.00 V	148	8.11	23.21

NOTE:

1. Emission level (dBuV/m) = Raw Value (dBuV) + Correction Factor (dB).
2. Correction Factor (dB/m) = Antenna Factor (dB/m) + Cable Factor (dB).
3. The other emission levels were very low against the limit.
4. Margin value = Emission level – Limit value.
1. This is valid for all 3 channels.

4.8 EFFECTIVE RADIATED POWER MEASUREMENT

4.8.1. LIMITS OF RADIATED EMISSION MEASUREMENT

In the FCC 24.238(a), On any frequency outside a licensee's frequency block within USPCS spectrum, the power of any emission shall be attenuated below the transmitter power (P) by at least $43 + 10 \log (P)$ dB. The limit translates in the relevant power range (1 to 0.001W). At 1W(Power Control Level 0) the specified minimum attenuation becomes 43dB and the limit of emission equal to -13dBm . At 0.001W(Power Control Level 15) the specified minimum attenuation becomes 13dB and the emission of limit equal to -13dBm . So the limit of emission is the same absolute specified line.

4.8.2. TEST INSTRUMENTS

DESCRIPTION & MANUFACTURER	MODEL NO.	SERIAL NO.	CALIBRATED UNTIL
* HP Spectrum Analyzer	8594E	3911A07465	July 07, 2004
* HP Preamplifier	8447D	2432A03504	June 10, 2004
HP Preamplifier	8449B	3008A01201	Dec. 11, 2004
* HP Preamplifier	8449B	3008A01292	Aug. 11, 2004
SCHAFFNER Tunable Dipole Antenna	VHBA 9123	459	Jun. 26, 2004
SCHWARZBECK Tunable Dipole Antenna	UHA 9105	977	
* ROHDE & SCHWARZ TEST RECEIVER	ESMI	839013/007 839379/002	Feb. 13, 2004
*Schwarzbeck Antenna	VULB9168	137	Apr. 03, 2004
* SCHWARZBECK Horn Antenna	BBHA9120-D1	D130	June 30, 2004
*ADT. Turn Table	TT100	0306	NA
*ADT. Tower	AT100	0306	NA
*Software	ADT_Radiated_V 5.14	NA	NA
*TIMES RF cable	LL142	CABLE-CH6-01	Apr. 30, 2004

- NOTE:**
1. The calibration interval of the above test instruments is 12 months. And the calibrations are traceable to NML/ROC and NIST/USA.
 2. "*" = These equipment are used for the final measurement.
 3. The horn antenna and HP preamplifier (model: 8449B) are used only for the measurement of emission frequency above 1GHz if tested.
 4. The test was performed in ADT Chamber No. 6.

4.8.3. TEST PROCEDURES

- h. The EUT was placed on the top of a rotating table 0.8 meters above the ground. The table was rotated 360 degrees to determine the position of the highest radiation.
- i. The EUT was set 10 meters away from the receiving antenna, which was mounted on antenna tower and its position at 0.8 m above the ground.
- j. For each suspected emission, the EUT was arranged to its worst case and the rotatable table was turned from 0 degrees to 360 degrees to find the maximum reading and recorded the value.
- k. The EUT is replaced by a horn antenna connected to a signal generator tuned to the frequency of emission.
- l. The signal generator level has to be adjusted to have the same emission nature.
- m. The radiated power can be calculated via the factor and antenna gain.
- n. Repeat step 1-6 for horizontal polarization.

NOTE: 1. The resolution bandwidth of spectrum analyzer is 10 kHz and the video bandwidth is 300 kHz for spurious emission below 1GHz.
2. The resolution bandwidth of spectrum analyzer is 1 MHz and the video bandwidth is 3 MHz for spurious emission above 1GHz.
2. The resolution bandwidth of spectrum analyzer is 100kHz and the video bandwidth is 100kHz for the transmitter output measurement,.

4.8.4. DEVIATION FROM TEST STANDARD

No deviation

4.8.5. TEST SETUP

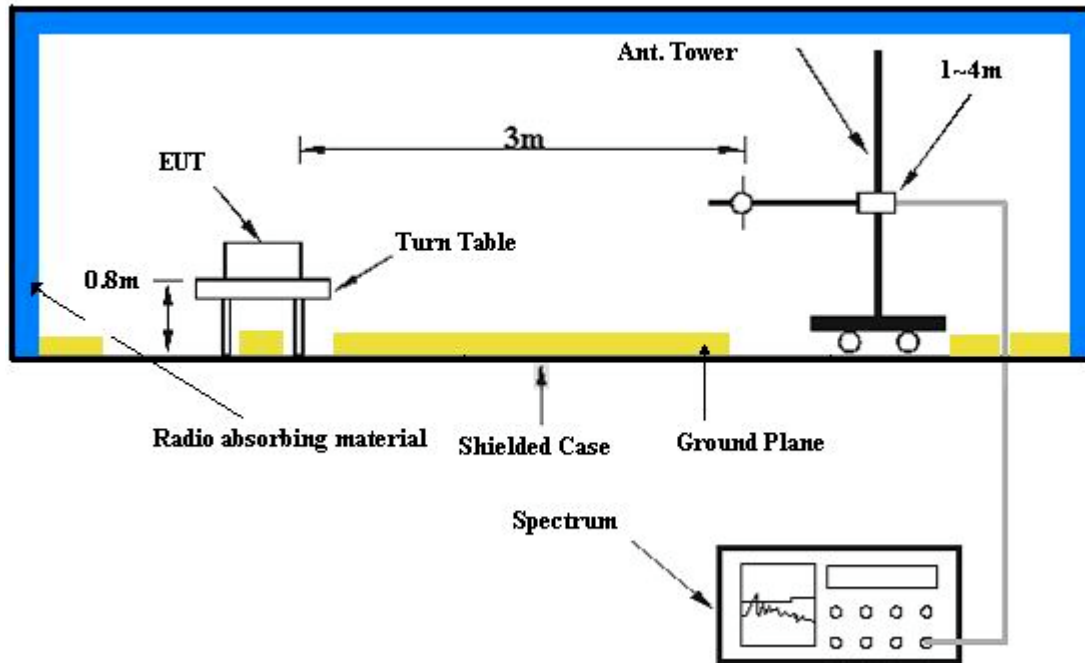

For the actual test configuration, please refer to the related item – Photographs of the Test Configuration.

4.8.6. EUT OPERATING CONDITIONS

- h. Plug the EUT in a notebook system placed on a testing table.
- i. The notebook system makes a phone call to the GSM simulator.
- j. The GSM simulator station system controlled an EUT to export maximum output power under transmission mode and specific channel frequency.
- k. The notebook system sent "H" messages to its screen.
- l. The notebook system sent "H" messages to modem.
- m. The notebook system sent "H" messages to printer, and the printer prints them on paper.
- n. Repeated d ~ f.

4.8.7. TEST RESULTS

EUT	Mobile Phone	MODEL	8055T(2042S3)
MODE	TX connected Mode A Channel 512	FREQUENCY RANGE	Above 1000 MHz
INPUT POWER (SYSTEM)	120Vac, 60 Hz	ENVIRONMENTAL CONDITIONS	25 deg. C, 60 % RH, 991 hPa
TESTED BY	Gary Chang		

ANTENNA POLARITY & TEST DISTANCE: HORIZONTAL AT 3 M						
No.	Freq. (MHz)	Emission Level (dBuV)	Limit (dBm)	S.G Power Value (dBm)	Correction Factor (dB)	Power Value (dBm)
1	3704.00	54.99	-13.00	-49.42	9.19	-40.23
2	5550.00	51.87	-13.00	-53.64	10.29	-43.35
3	7400.40	60.33	-13.00	-41.54	10.13	-31.41
4	9250.40	55.85	-13.00	-49.57	10.20	-39.37
5	11104.00	58.89	-13.00	-47.66	11.33	-36.33
6	12952.10	60.88	-13.00	-46.14	11.80	-34.34

ANTENNA POLARITY & TEST DISTANCE: VERTICAL AT 3 M						
No.	Freq. (MHz)	Emission Level (dBuV)	Limit (dBm)	S.G Power Value (dBm)	Correction Factor (dB)	Power Value (dBm)
1	3703.00	51.03	-13.00	-53.38	9.19	-44.19
2	5550.60	51.23	-13.00	-54.28	10.29	-43.99
3	7401.10	58.81	-13.00	-46.54	10.13	-36.41
4	9251.40	57.41	-13.00	-47.61	10.20	-37.41
5	11101.30	58.61	-13.00	-47.94	11.33	-36.61
6	12951.00	60.80	-13.00	-46.22	11.80	-34.42

NOTE: Power Value (dBum) = S.G Power Value (dBm) + Correction Factor (dB).

EUT	Mobile Phone	MODEL	8055T(2042S3)
MODE	TX connected Mode A Channel 661	FREQUENCY RANGE	Above 1000 MHz
INPUT POWER (SYSTEM)	120Vac, 60 Hz	ENVIRONMENTAL CONDITIONS	25 deg. C, 60 % RH, 991 hPa
TESTED BY	Gary Chang		

ANTENNA POLARITY & TEST DISTANCE: HORIZONTAL AT 3 M						
No.	Freq. (MHz)	Emission Level (dBUV)	Limit (dBm)	S.G Power Value (dBm)	Correction Factor (dB)	Power Value (dBm)
1	3760.00	58.34	-13.00	-46.06	9.18	-36.88
2	5640.00	53.58	-13.00	-51.65	10.28	-41.37
3	7519.10	62.01	-13.00	-43.34	10.13	-33.21
4	9400.10	54.94	-13.00	-50.83	10.55	-40.28
5	11280.20	57.37	-13.00	-49.88	12.03	-37.85
6	13160.00	57.21	-13.00	-49.54	11.53	-38.01
7	15040.00	59.60	-13.00	-48.20	12.58	-35.62

ANTENNA POLARITY & TEST DISTANCE: VERTICAL AT 3 M						
No.	Freq. (MHz)	Emission Level (dBUV)	Limit (dBm)	S.G Power Value (dBm)	Correction Factor (dB)	Power Value (dBm)
1	3760.00	54.94	-13.00	-49.46	9.18	-40.28
2	5640.00	52.46	-13.00	-53.04	10.28	-42.76
3	7519.00	56.42	-13.00	-48.93	10.13	-38.80
4	9400.70	54.99	-13.00	-50.78	10.55	-40.23
5	11292.00	58.81	-13.00	-48.44	12.03	-36.41
6	13159.00	62.27	-13.00	-48.48	11.53	-36.95

NOTE: Power Value (dBum) = S.G Power Value (dBm) + Correction Factor (dB).

EUT	Mobile Phone	MODEL	8055T(2042S3)
MODE	TX connected Mode A Channel 810	FREQUENCY RANGE	Above 1000 MHz
INPUT POWER (SYSTEM)	120Vac, 60 Hz	ENVIRONMENTAL CONDITIONS	25 deg. C, 60 % RH, 991 hPa
TESTED BY	Gary Chang		

ANTENNA POLARITY & TEST DISTANCE: HORIZONTAL AT 3 M						
No.	Freq. (MHz)	Emission Level (dBuV)	Limit (dBm)	S.G Power Value (dBm)	Correction Factor (dB)	Power Value (dBm)
1	3819.00	56.95	-13.00	-47.54	9.27	-38.27
2	5729.10	52.19	-13.00	-53.50	10.47	-43.03
3	7639.10	59.77	-13.00	-45.69	10.24	-35.45
4	9549.20	56.68	-13.00	-48.87	10.53	-38.34
5	11456.20	54.05	-13.00	-52.41	11.24	-41.17
6	13368.10	58.86	-13.00	-47.46	11.10	-36.36

ANTENNA POLARITY & TEST DISTANCE: VERTICAL AT 3 M						
No.	Freq. (MHz)	Emission Level (dBuV)	Limit (dBm)	S.G Power Value (dBm)	Correction Factor (dB)	Power Value (dBm)
1	3819.00	50.69	-13.00	-53.80	9.27	-44.53
2	5729.10	57.59	-13.00	-48.10	10.47	-37.63
3	7639.10	54.82	-13.00	-50.64	10.24	-40.40
4	9549.00	55.61	-13.00	-50.14	10.53	-39.61
5	11458.10	54.43	-13.00	-52.03	11.24	-40.79
6	13369.00	58.66	-13.00	-47.66	11.10	-36.56

NOTE: Power Value (dBum) = S.G Power Value (dBm) + Correction Factor (dB).

5 PHOTOGRAPHS OF THE TEST CONFIGURATION

RADIATED EMISSION TEST

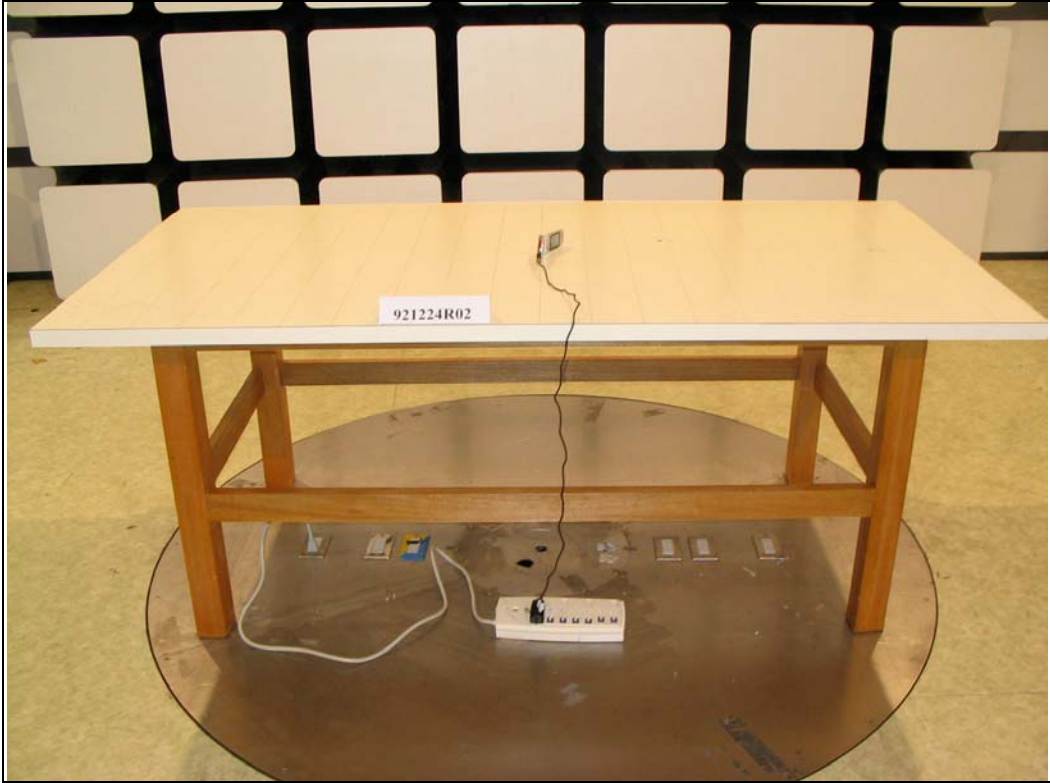

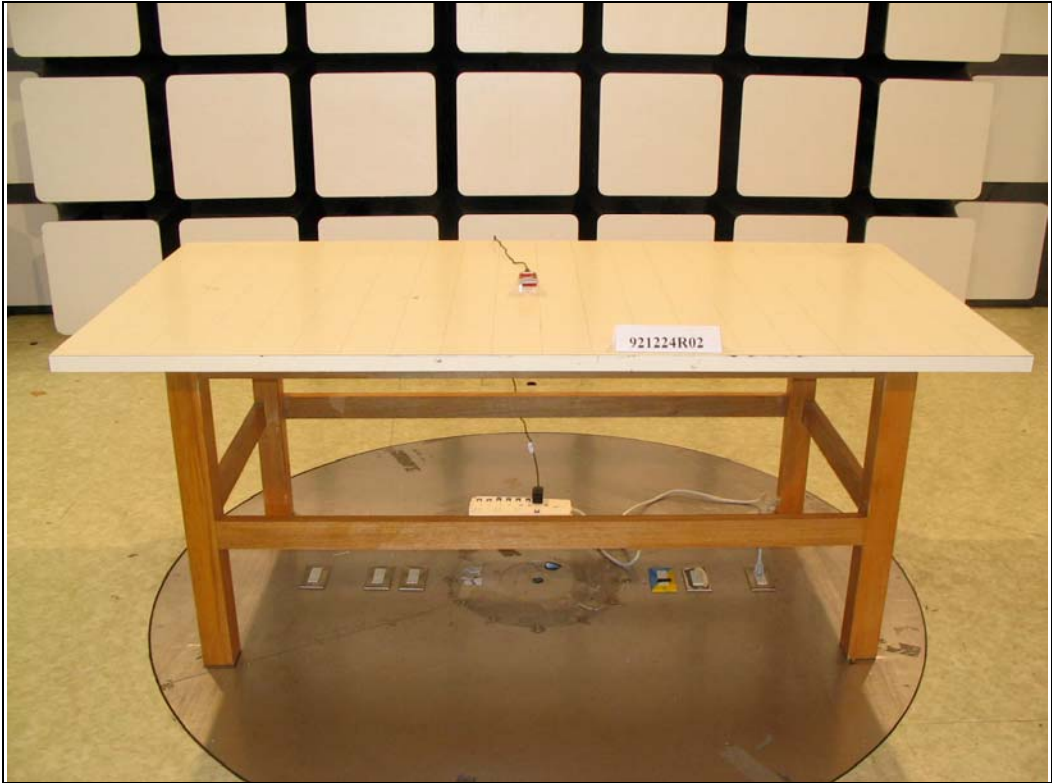
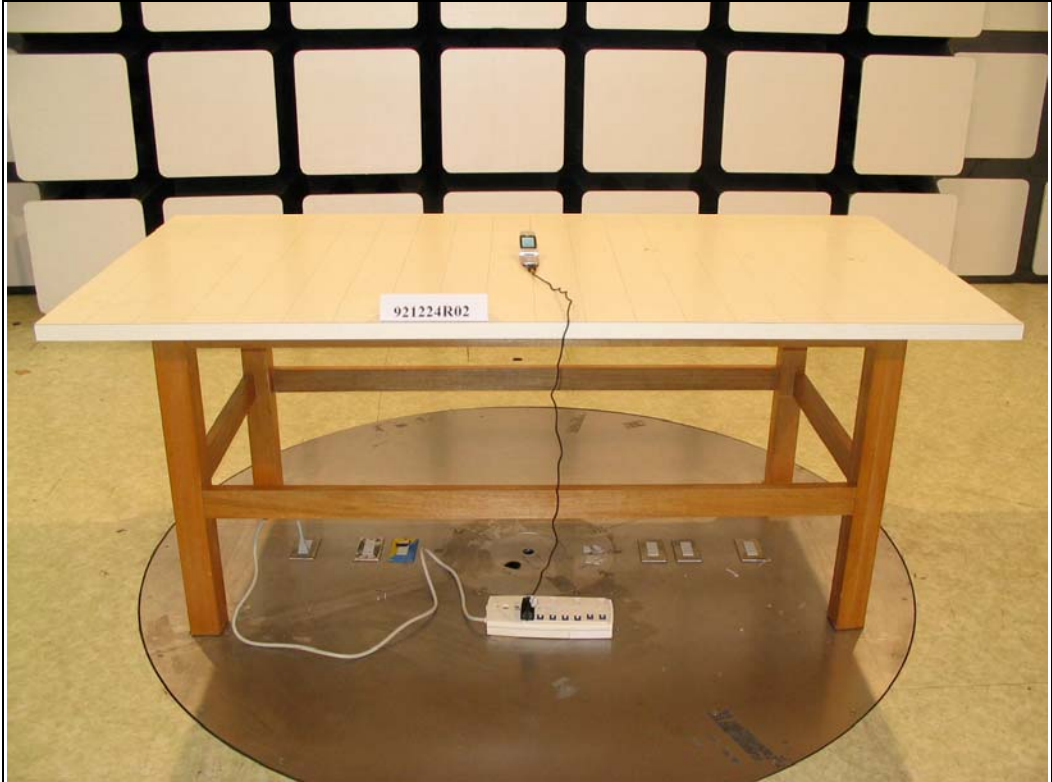

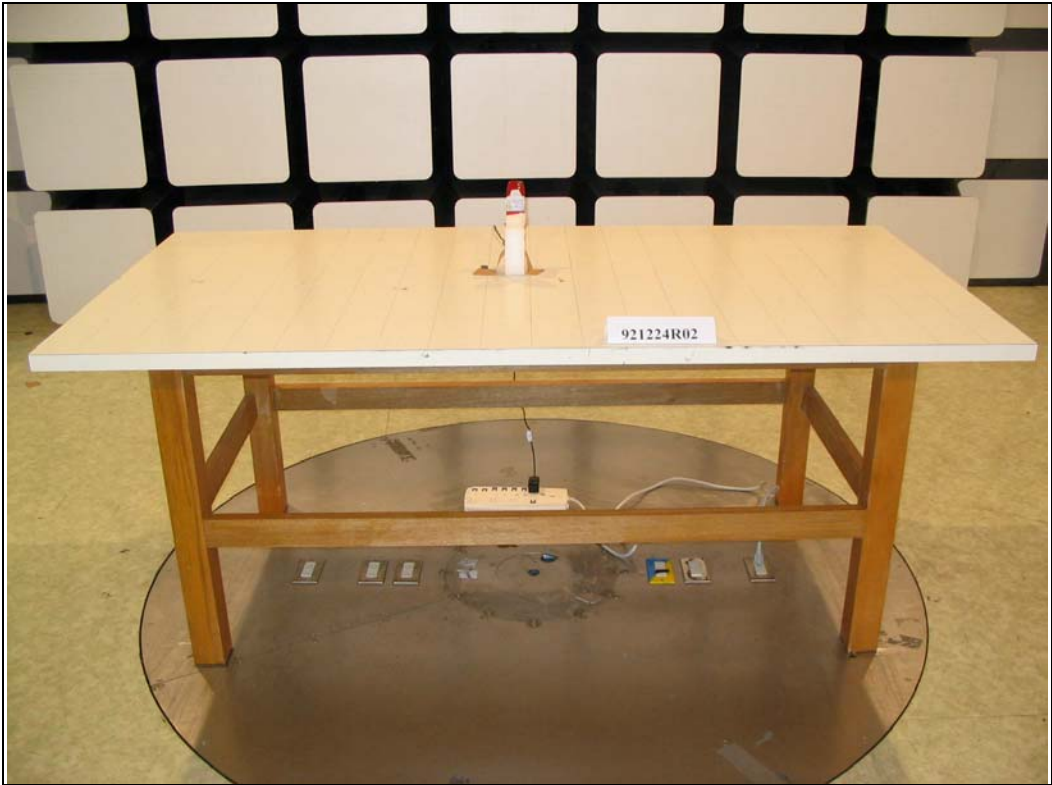
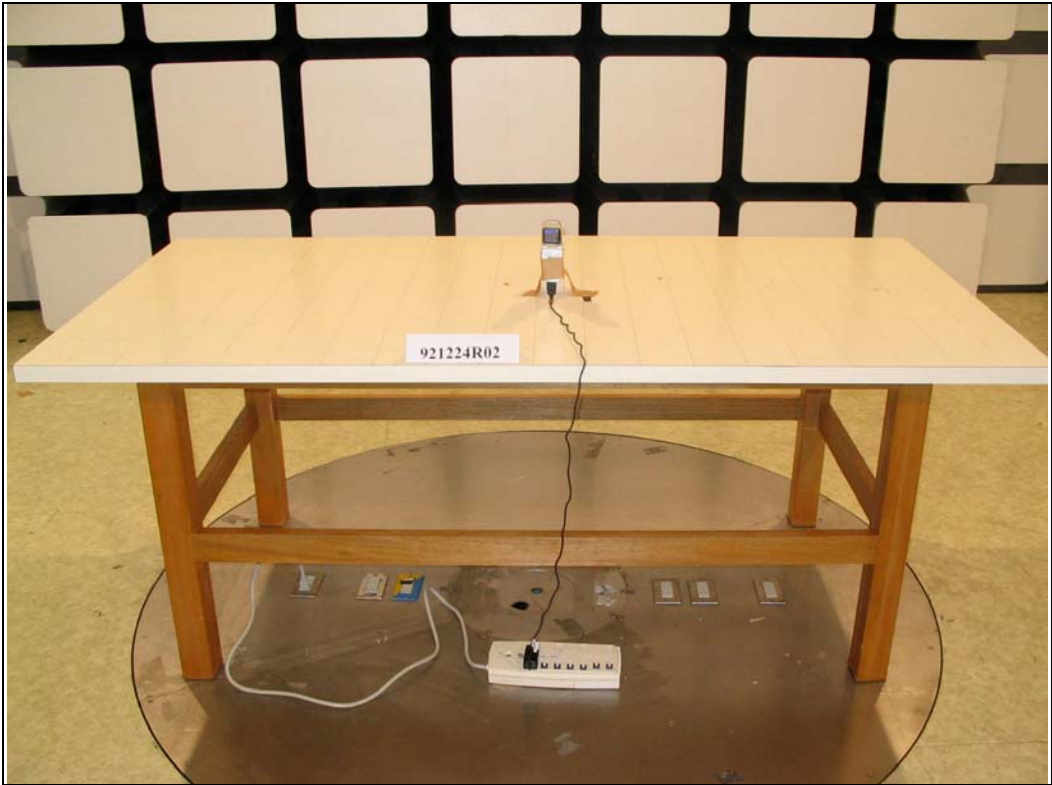

6 INFORMATION ON THE TESTING LABORATORIES

We, ADT Corp., were founded in 1988 to provide our best service in EMC, Radio, Telecom and Safety consultation. Our laboratories are accredited and approved by the following approval agencies according to ISO/IEC 17025, Guide 25 or EN 45001:

USA	FCC, NVLAP, UL
Germany	TUV Rheinland
Japan	VCCI
Norway	NEMKO
Canada	INDUSTRY CANADA , CSA
R.O.C.	CNLA, BSMI, DGT
Netherlands	Telefication
Singapore	PSB , GOST-ASIA(MOU)
Russia	CERTIS(MOU)

Copies of accreditation certificates of our laboratories obtained from approval agencies can be downloaded from our web site:

www.adt.com.tw/index.5/phtml. If you have any comments, please feel free to contact us at the following:

Linko EMC/RF Lab:

Tel: 886-2-26052180

Fax: 886-2-26052943

Hsin Chu EMC/RF Lab:

Tel: 886-3-5935343

Fax: 886-3-5935342

Hwa Ya EMC/RF/Safety Lab:

Tel: 886-3-3183232

Fax: 886-3-3185050

Linko RF & Telecom Lab.

Tel: 886-3-3270910

Fax: 886-3-3270892

Email: service@mail.adt.com.tw

Web Site: www.adt.com.tw

The address and road map of all our labs can be found in our web site also.