

WLAN IP Phone

DB-6645

Quickly Operational Manual

Issue 1.0

Issued : 18, Mar., 2004









Revision History

Version	Date	Remarks
1.0	18. Mar. 2004	Initial operational manual: Draft issue (for MMI ver.06)









1.Outline

1.1 On the handset

➤ Definition of the icons on the display

- ▶ Next page.
- ◀ Previously page.
-  is blinking, indicating new incoming call.
-  Handset is ready to make a call.
-  Handset is linked to AP
-  is blinking, indicating new unanswered Caller ID information exists.
-  is on steady, indicating old Caller ID information exists.
-  Keypad locked.
- A** The capitalized mode during editing.
- a** The small letter mode during editing.
- 1** The Numeral mode during editing.
-  Battery is low.
-  Battery is fully charged.
-  It is steady on when handset speaker is on.(Option)

➤ Definition of the keys









- [] Move up/down.(As a backspace key during editing)
- []/[] Redial/The cursor jump to right in message mode.
- []/[] Phone book/The cursor jump to left in message mode.
- [] Softkey1.
- [] Softkey2.
- [] Phone off/Escape to the last step/ Power on, off.(Press it for over 3 seconds)
- [] Phone on.
- [HOLD] Hold on the call during conversation.
- [TRF] Transfer the call to the other IP phone during conversation.
- [SHIFT] Change the lower case or upper case mode during editing
- [FNC] Setup a function or confirm a setup.

[LOCK] Keypad locked in standby mode.

[0~9,*,#]/[N] Numeral (The contrast table is below).

Mode	Capitalized					Small letter				
Time Key	1	2	3	4	5	1	2	3	4	5
1	,	1				,	1			
2	A	B	C	2		a	b	c	2	
3	D	E	F	3		d	e	f	3	
4	G	H	I	4		g	h	i	4	
5	J	K	L	5		j	k	l	5	
6	M	N	O	6		m	n	o	6	
7	P	Q	R	S	7	p	q	r	s	7
8	T	U	V	8		t	u	v	8	
9	W	X	Y	Z	9	w	x	y	z	9
0	Space	-	0			Space	-	0		
*	*	.	@	(*	.	@	(
#	#)	:			#)	:		

1.2 Handset LCD display

HS LCD	Mode Status
 No service 2003/09/20 11:50	Searching mode
  DB168-user 2003/09/20 11:50	Standby mode
  Battery Low	Low battery mode
   DB168-user 2003/09/20 11:50	New message

2.Programming menu

Menu at handset on hook mode

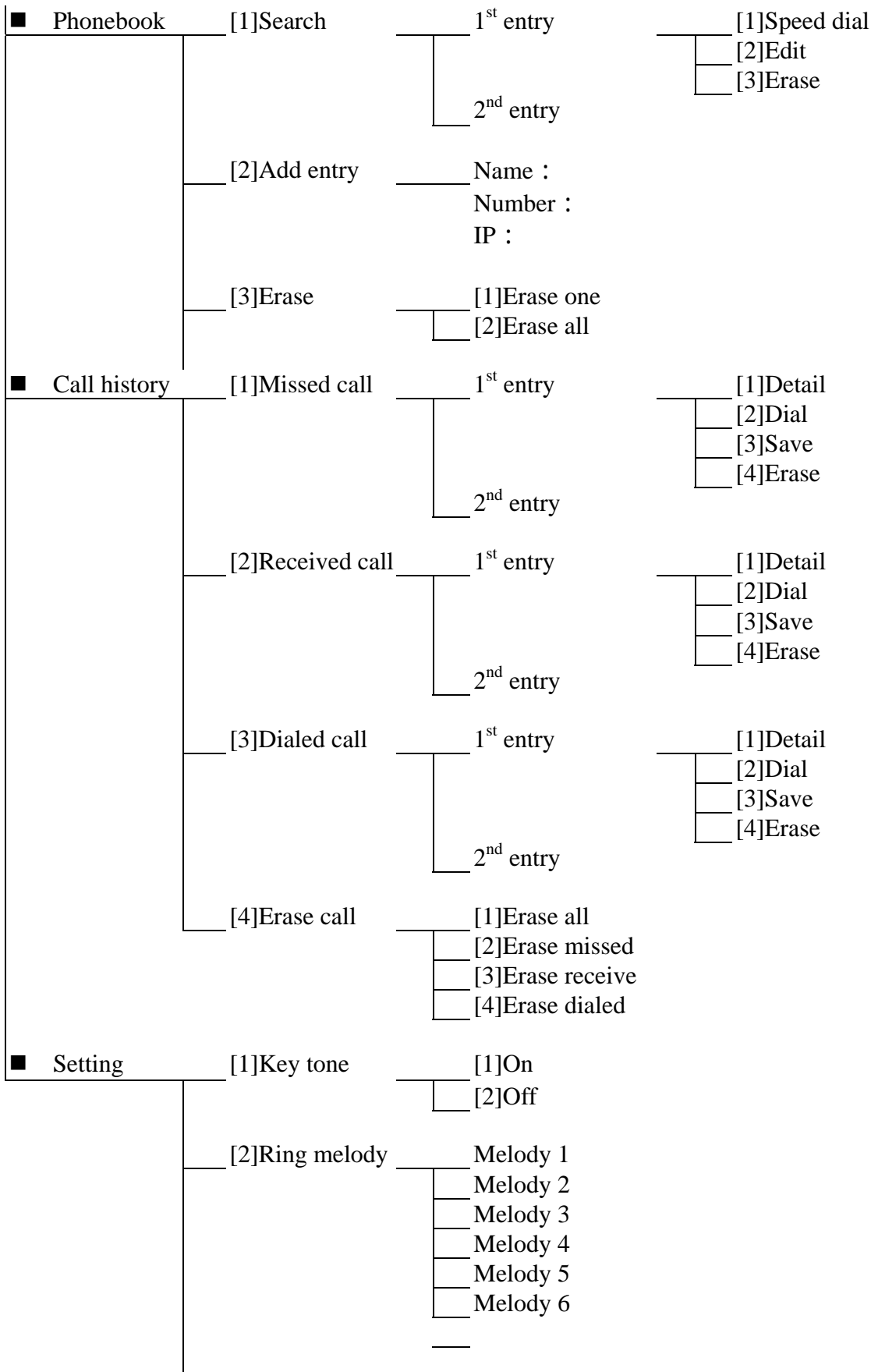

Note:
If there is no entry, "No Number!" shows instead.

Note:
If there is no entry, "No Number!" shows instead.

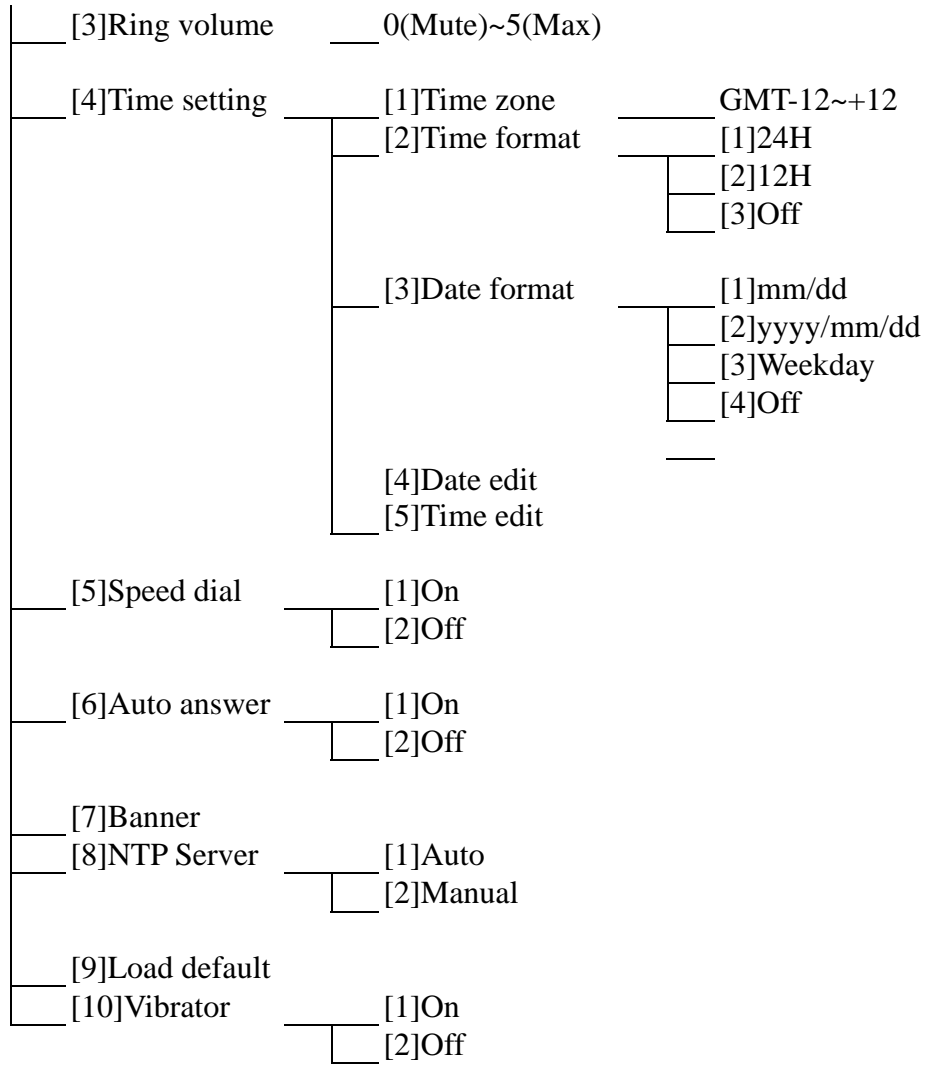

3.Basic phone function

3.1 Power on / off

Press [] for over 3 seconds.
Ex. Power on

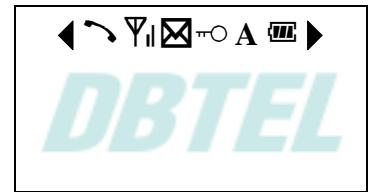



Ex. Power off

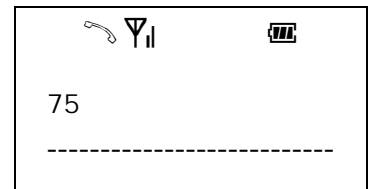

3.2 Receiving a call

◆Calling from another handset Ex. Handset 69 is calling from handset 75.
handset  is blinking.



Press [] ⇒ Conversation

3.3 Making a call

3.3.1 Manual input

◆With pre-dial

Press [N]
Ex. It is dialing to handset 75.

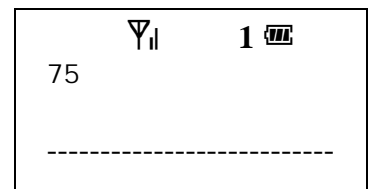

Press [] ⇒ dial

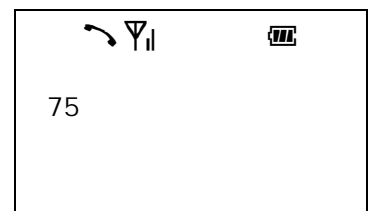

Press [] ⇒ to end the call.

◆Without pre-dial

Press []

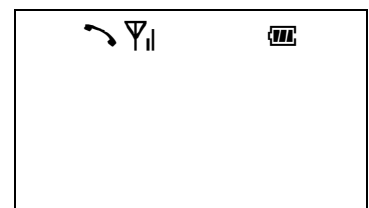

Press [N] ⇨ to dialing

Ex.75

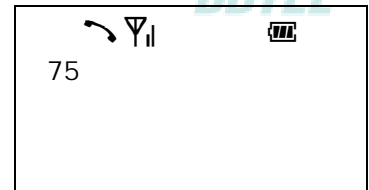

Wait for 3 sec to show the dialing.

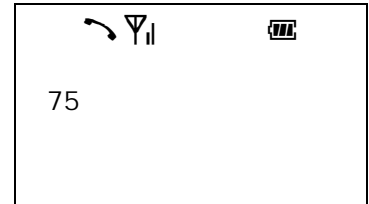

Press [PWR] ⇨ to end the call.

3.3.2 From phone book Press [BOOK]

The LCD is show the name or phone no.

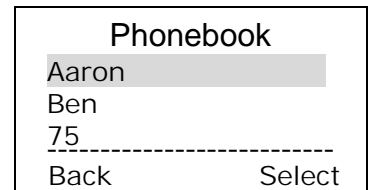

Note:

If there is no phonebook entry previously saved in the Phonebook list, the LCD will shows “No number”.

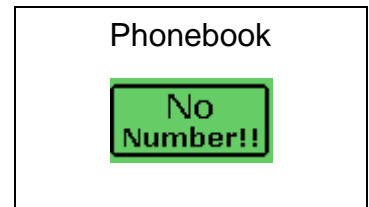

Press [▲]/[▼] to choose number.

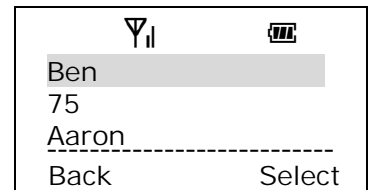

Press [CALL] ⇨ Conversation

Ex. Ben

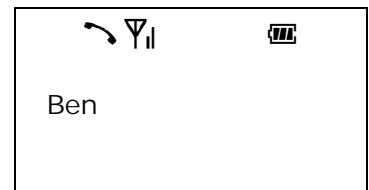

Press [PWR] ⇨ to end the call.

3.3.3 Re-dial

Press [RECALL]

To dial the last 20 numbers.

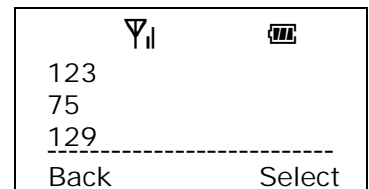

Press [▲]/[▼] to choose redial number

Press [📞] ⇒ Conversation
Ex. Ben

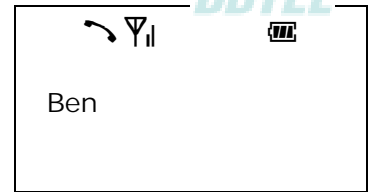

Press [PWR] ⇒ to end the call.

3.4 HS volume

(To be modify in next F/W version)

During the conversation:
Press [◀] / [▶] ⇒ to adjust volume
Press Select [▶] ⇒ to confirm the setting.

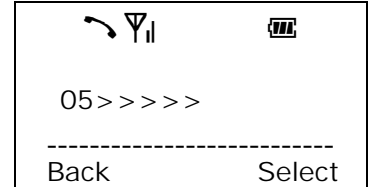

3.5 Keypad locked

Press [LOCK] ⇒ Lock Keypad in standby mode.
Press [LOCK] again ⇒ to release.

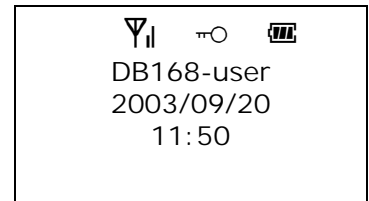

In this mode, only incoming calls can be accepted.

3.6 Caller ID

Total caller ID memory: 30 sets.
Calling party number will be displayed on LCD. If name information is also provided, it will be displayed on LCD.

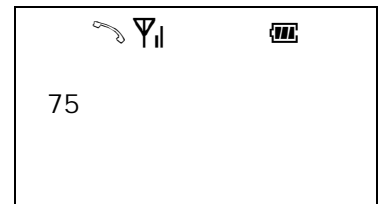

Federal Communication Commission Interference Statement

This equipment has been tested and found to comply with the limits for a Class B digital device, pursuant to Part 15 of the FCC Rules. These limits are designed to provide reasonable protection against harmful interference in a residential installation. This equipment generates, uses and can radiate radio frequency energy and, if not installed and used in accordance with the instructions, may cause harmful interference to radio communications. However, there is no guarantee that interference will not occur in a particular installation. If this equipment does cause harmful interference to radio or television reception, which can be determined by turning the equipment off and on, the user is encouraged to try to correct the interference by one of the following measures:

- Reorient or relocate the receiving antenna.
- Increase the separation between the equipment and receiver.
- Connect the equipment into an outlet on a circuit different from that to which the receiver is connected.
- Consult the dealer or an experienced radio/TV technician for help.

This device complies with Part 15 of the FCC Rules. Operation is subject to the following two conditions: (1) This device may not cause harmful interference, and (2) this device must accept any interference received, including interference that may cause undesired operation.

FCC Caution: Any changes or modifications not expressly approved by the party responsible for compliance could void the user's authority to operate this equipment.

IMPORTANT NOTE:

FCC Radiation Exposure Statement:

This equipment complies with FCC radiation exposure limits set forth for an uncontrolled environment. End users must follow the specific operating instructions for satisfying RF exposure compliance.

This transmitter must not be co-located or operating in conjunction with any other antenna or transmitter.