



FCC RADIO TEST REPORT

FCC ID : BV2-EW21DM
Equipment : DENON Wireless Module 5G
Brand Name : DENON
Model Name : EW21DM
Applicant : D&M Holdings Inc.
2-1 Nisshin-cho, Kawasaki-ku, Kawasaki, 210-8569, Japan
Manufacturer : Rayson Technology Co., Ltd.
1F, No. 9, R&D Rd II, Science Based Industrial Park,
Hsin-chu, 300 Taiwan
Standard : 47 CFR FCC Part 15.407

The product was received on Apr. 16, 2020, and testing was started from Apr. 16, 2020 and completed on Jun. 15, 2020. We, SPORTON INTERNATIONAL INC. EMC & Wireless Communications Laboratory, would like to declare that the tested sample has been evaluated in accordance with the procedures given in ANSI C63.10-2013 and shown compliance with the applicable technical standards.

The report must not be used by the client to claim product certification, approval, or endorsement by TAF or any agency of government.

The test results in this report apply exclusively to the tested model / sample. Without written approval of SPORTON INTERNATIONAL INC. EMC & Wireless Communications Laboratory, the test report shall not be reproduced except in full.

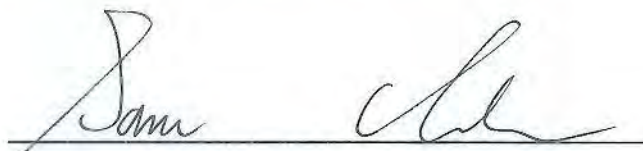
Approved by: Sam Chen

SPORTON INTERNATIONAL INC. EMC & Wireless Communications Laboratory
No. 52, Huaya 1st Rd., Guishan Dist., Taoyuan City, Taiwan (R.O.C.)



Table of Contents

History of this test report.....3

Summary of Test Result.....4

1 General Description5

1.1 Information.....5

1.2 Applicable Standards6

1.3 Testing Location Information.....6

1.4 Measurement Uncertainty6

2 Test Configuration of EUT7

2.1 Test Channel Mode7

2.2 The Worst Case Measurement Configuration.....8

2.3 EUT Operation during Test8

2.4 Accessories8

2.5 Support Equipment.....9

2.6 Test Setup Diagram10

3 Transmitter Test Result12

3.1 AC Power-line Conducted Emissions12

3.2 Emission Bandwidth.....14

3.3 Maximum Conducted Output Power15

3.4 Peak Power Spectral Density.....17

3.5 Unwanted Emissions.....20

4 Test Equipment and Calibration Data25

Appendix A. Test Results of AC Power-line Conducted Emissions

Appendix B. Test Results of Emission Bandwidth

Appendix C. Test Results of Maximum Conducted Output Power

Appendix D. Test Results of Peak Power Spectral Density

Appendix E. Test Results of Unwanted Emissions

Appendix F. Test Photos

Photographs of EUT v01



Summary of Test Result

Report Clause	Ref Std. Clause	Test Items	Result (PASS/FAIL)	Remark
1.1.2	15.203	Antenna Requirement	PASS	-
3.1	15.207	AC Power-line Conducted Emissions	PASS	-
3.2	15.407(a)	Emission Bandwidth	PASS	-
3.3	15.407(a)	Maximum Conducted Output Power	PASS	-
3.4	15.407(a)	Peak Power Spectral Density	PASS	-
3.5	15.407(b)	Unwanted Emissions	PASS	-

Note: Reference to Sporton Project No.: 041026

Declaration of Conformity:

The test results with all measurement uncertainty excluded are presented in accordance with the regulation limits or requirements declared by manufacturers.

Comments and Explanations:

The declared of product specification for EUT presented in the report are provided by the manufacturer, and the manufacturer takes all the responsibilities for the accuracy of product specification.

Reviewed by: Sam Chen

Report Producer: Viola Huang



1 General Description

1.1 Information

1.1.1 RF General Information

Frequency Range (MHz)	Channel Spacing (MHz)	Ch. Frequency (MHz)	Channel Number
5150-5250	2	5157-5243	1-44 [44]
5725-5850	2	5726-5848	46-107 [62]

Band (MHz)	Mode	BWch (MHz)	Nant
5150-5250	FSK	2	1TX
5725-5850	FSK	2	1TX

Note:

- ◆ Uses a combination of FSK modulation.
- ◆ BWch is the nominal channel bandwidth.

1.1.2 Antenna Information

Ant.	Brand	Model Name	Antenna Type	Connector	Gain (dBi)	Remark
1	N/A	N/A	Printed Antenna	N/A	2	TX
2	N/A	N/A	Printed Antenna	N/A	2	RX

Note: The above information was declared by manufacturer.

1.1.3 Mode Test Duty Cycle

Mode	DC	DCF(dB)	T(s)	VBW(Hz) ≥ 1/T
FSK	1	0	n/a (DC>=0.98)	n/a (DC>=0.98)

Note:

- ◆ DC is Duty Cycle.
- ◆ DCF is Duty Cycle Factor.

1.1.4 EUT Operational Condition

EUT Power Type	From host system			
Beamforming Function	<input type="checkbox"/> With beamforming	<input checked="" type="checkbox"/>	Without beamforming	
Function	<input type="checkbox"/> Outdoor P2M	<input type="checkbox"/>	Indoor P2M	
	<input type="checkbox"/> Fixed P2P	<input checked="" type="checkbox"/>	Client	
Test Software Version	EMI Tool (V9_2020_04_08_RsUse)			

Note: The above information was declared by manufacturer.



1.2 Applicable Standards

According to the specifications of the manufacturer, the EUT must comply with the requirements of the following standards:

- ◆ 47 CFR FCC Part 15
- ◆ ANSI C63.10-2013
- ◆ FCC KDB 789033 D02 v02r01

The following reference test guidance is not within the scope of accreditation of TAF.

- ◆ FCC KDB 412172 D01 v01r01
- ◆ FCC KDB 414788 D01 v01r01

1.3 Testing Location Information

Testing Location		
<input type="checkbox"/>	HWA YA	ADD : No. 52, Huaya 1st Rd., Guishan Dist., Taoyuan City, Taiwan (R.O.C.) TEL : 886-3-327-3456 FAX : 886-3-327-0973
<input checked="" type="checkbox"/>	JHUBEI	ADD : No.8, Lane 724, Bo-ai St., Jhubei City, HsinChu County 302, Taiwan, R.O.C. TEL : 886-3-656-9065 FAX : 886-3-656-9085

Test Condition	Test Site No.	Test Engineer	Test Environment	Test Date
RF Conducted	TH03-CB	Paul Chen	22.4-23.4°C / 51-55 %	Jun. 08, 2020
Radiated<1GHz	03CH05-CB	Eason Chen	25-27.3°C / 72-74%	Jun. 15, 2020
Radiated>1GHz	03CH05-CB	Eason Chen	21.6-23.1°C / 55-58%	Apr. 28, 2020 ~ Jun. 08, 2020
AC Conduction	CO01-CB	Max Lin	23~24°C / 59~60%	Apr. 16, 2020

Test site Designation No. TW0006 with FCC
Test site registered number IC 4086D with Industry Canada.

1.4 Measurement Uncertainty

ISO/IEC 17025 requires that an estimate of the measurement uncertainties associated with the emissions test results be included in the report. The measurement uncertainties given below are based on a 95% confidence level (based on a coverage factor (k=2))

Test Items	Uncertainty	Remark
Conducted Emission (150kHz ~ 30MHz)	2.0 dB	Confidence levels of 95%
Radiated Emission (30MHz ~ 1,000MHz)	4.3 dB	Confidence levels of 95%
Radiated Emission (1GHz ~ 18GHz)	4.3 dB	Confidence levels of 95%
Radiated Emission (18GHz ~ 40GHz)	5.1 dB	Confidence levels of 95%
Conducted Emission	2.4 dB	Confidence levels of 95%
Output Power Measurement	1.5 dB	Confidence levels of 95%
Power Density Measurement	2.4 dB	Confidence levels of 95%
Bandwidth Measurement	2%	Confidence levels of 95%



2 Test Configuration of EUT

2.1 Test Channel Mode

Mode	Power Setting
FSK_1TX	-
5157MHz	7
5201MHz	2
5243MHz	2
5726MHz	1
5786MHz	1
5848MHz	0



2.2 The Worst Case Measurement Configuration

The Worst Case Mode for Following Conformance Tests	
Tests Item	AC power-line conducted emissions
Condition	AC power-line conducted measurement for line and neutral
Operating Mode	CTX

The Worst Case Mode for Following Conformance Tests	
Tests Item	Emission Bandwidth Maximum Conducted Output Power Peak Power Spectral Density
Test Condition	Conducted measurement at transmit chains

The Worst Case Mode for Following Conformance Tests	
Tests Item	Unwanted Emissions
Test Condition	Radiated measurement If EUT consist of multiple antenna assembly (multiple antenna are used in EUT regardless of spatial multiplexing MIMO configuration), the radiated test should be performed with highest antenna gain of each antenna type.
The EUT was performed at X axis, Y axis and Z axis position for Unwanted Emissions above 1GHz test , and the worst case was found at Z axis. So the measurement will follow this same test configuration.	
Operating Mode < 1GHz	CTX - EUT at Z axis
The EUT was performed at X axis, Y axis and Z axis position , and the worst case was found at Z axis. So the measurement will follow this same test configuration.	
Operating Mode > 1GHz	CTX - EUT at Z axis

2.3 EUT Operation during Test

The EUT was programmed to be in continuously transmitting mode.

2.4 Accessories

N/A



2.5 Support Equipment

For AC Conduction:

Support Equipment				
No.	Equipment	Brand Name	Model Name	FCC ID
A	Fixture	everestek	EVB_TRX	N/A
B	Notebook	DELL	E6430	N/A
C	Earphone	e-Power	S90W	N/A
D	Mouse	HP	FM100	N/A

For Radiated:

Support Equipment				
No.	Equipment	Brand Name	Model Name	FCC ID
A	Fixture	everestek	EVB_TRX	N/A
B	Notebook	DELL	E4300	N/A

For RF Conducted:

Support Equipment				
No.	Equipment	Brand Name	Model Name	FCC ID
A	Notebook	DELL	E4300	N/A
B	Fixture	Abocom	AM7221T-X10	N/A

2.6 Test Setup Diagram

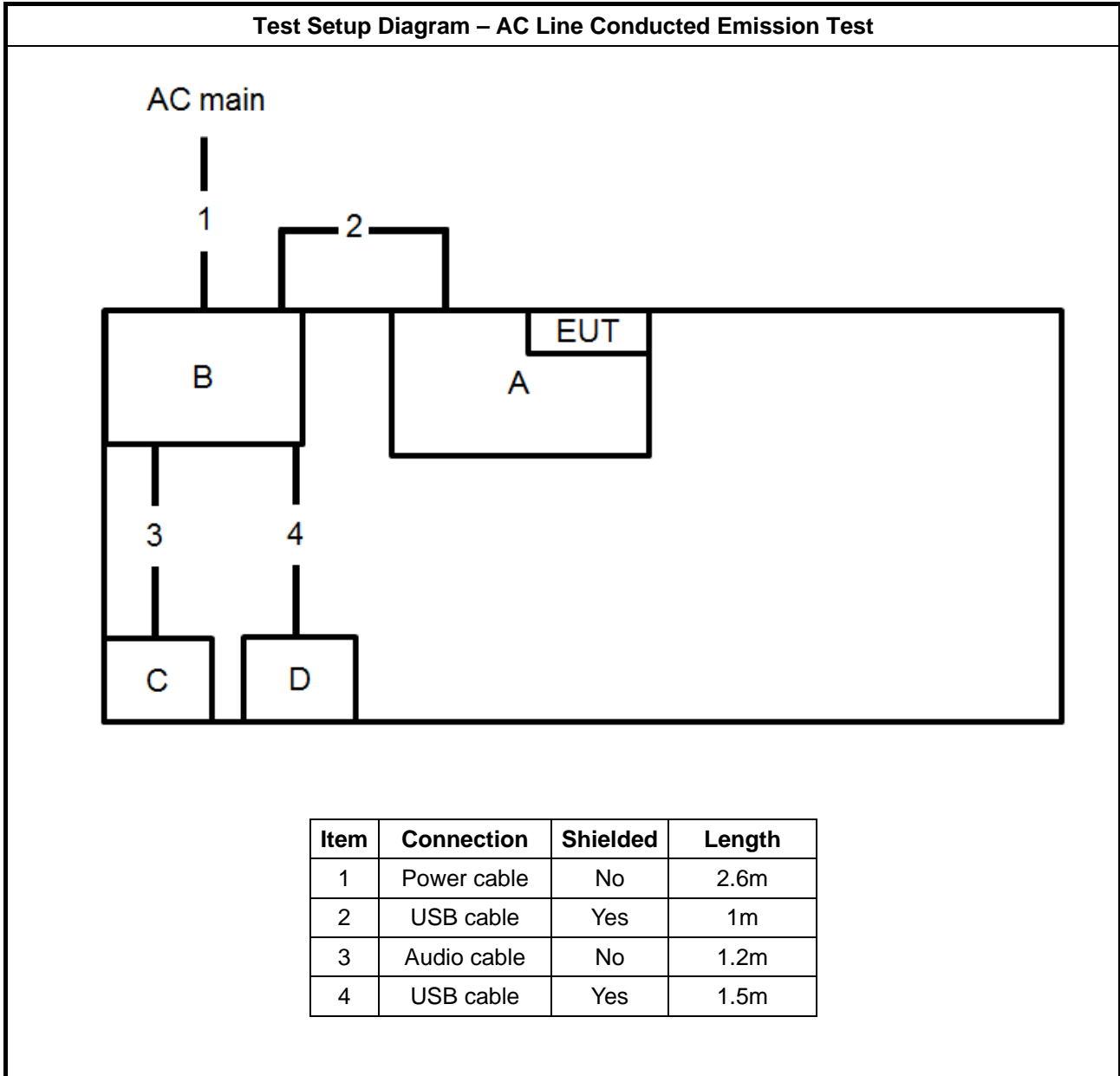

Test Setup Diagram - Radiated Test

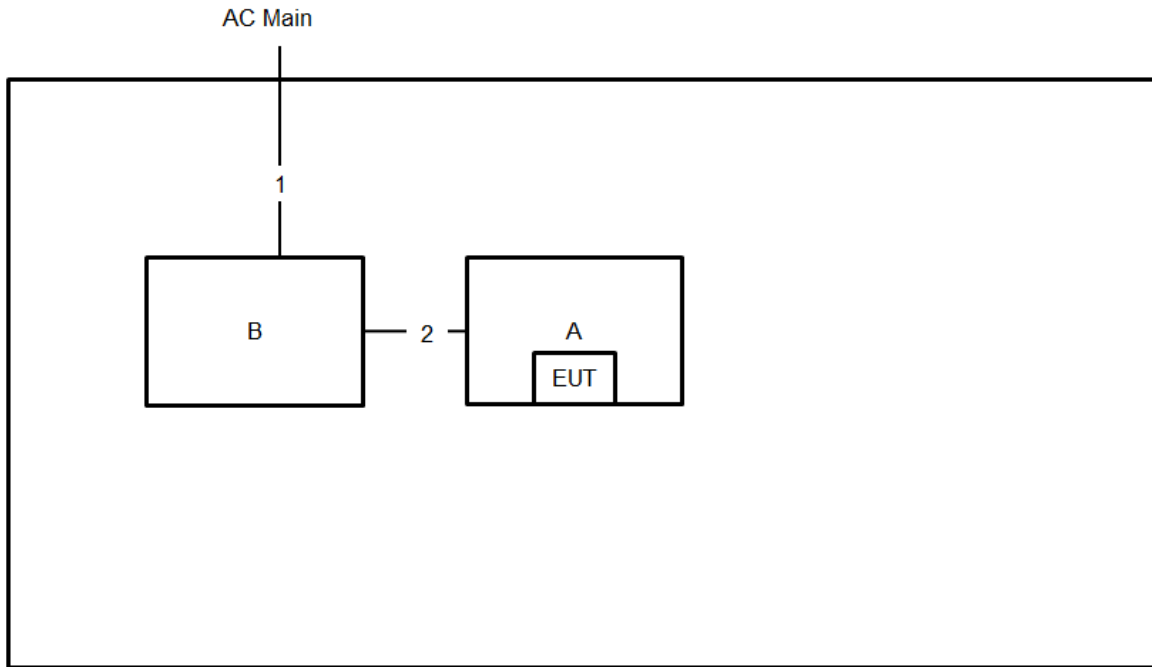

Item	Connection	Shielded	Length
1	Power cable	No	2.6m
2	USB cable	Yes	1.5m



3 Transmitter Test Result

3.1 AC Power-line Conducted Emissions

3.1.1 AC Power-line Conducted Emissions Limit

AC Power-line Conducted Emissions Limit		
Frequency Emission (MHz)	Quasi-Peak	Average
0.15-0.5	66 - 56 *	56 - 46 *
0.5-5	56	46
5-30	60	50

Note 1: * Decreases with the logarithm of the frequency.

3.1.2 Measuring Instruments

Refer a test equipment and calibration data table in this test report.

3.1.3 Test Procedures

Test Method
<input checked="" type="checkbox"/> Refer as ANSI C63.10-2013, clause 6.2 for AC power-line conducted emissions.

3.1.4 Test Setup

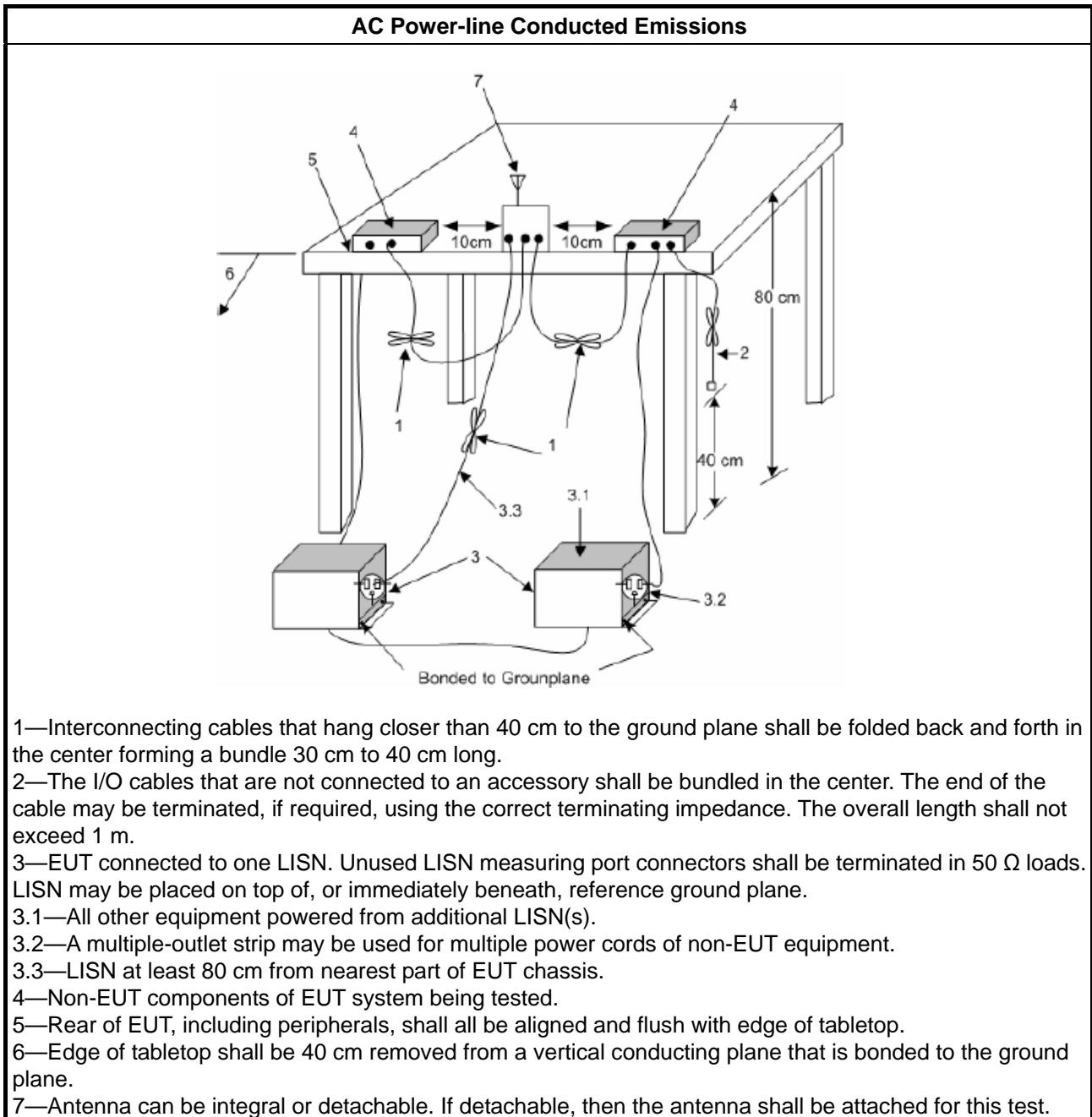

3.1.5 Measurement Results Calculation

The measured Level is calculated using:

- a. Corrected Reading (dBuV) = LISN Factor + Cable Loss + Read Level = Level
- b. Margin = - Limit + (Read Level + LISN Factor + Cable Loss)

3.1.6 Test Result of AC Power-line Conducted Emissions

Refer as Appendix A

3.2 Emission Bandwidth

3.2.1 Emission Bandwidth Limit

Emission Bandwidth Limit	
UNII Devices	
<input checked="" type="checkbox"/>	For the 5.15-5.25 GHz band, N/A
<input type="checkbox"/>	For the 5.25-5.35 GHz band, the maximum conducted output power shall not exceed the lesser of 250 mW or 11 dBm + 10 log B, where B is the 26 dB emission bandwidth in MHz.
<input type="checkbox"/>	For the 5.47-5.725 GHz band, the maximum conducted output power shall not exceed the lesser of 250 mW or 11 dBm + 10 log B, where B is the 26 dB emission bandwidth in MHz.
<input checked="" type="checkbox"/>	For the 5.725-5.85 GHz band, 6 dB emission bandwidth ≥ 500kHz.
LE-LAN Devices	
<input type="checkbox"/>	For the band 5.15-5.25 GHz, the maximum e.i.r.p. shall not exceed 200 mW or 10 + 10 log B, dBm, whichever power is less. B is the 99% emission bandwidth in MHz.
<input type="checkbox"/>	For the 5.25-5.35 GHz band, the maximum e.i.r.p. shall not exceed 1.0 W or 17 + 10 log B, dBm, whichever power is less. B is the 99% emission bandwidth in MHz
<input type="checkbox"/>	For the 5.47-5.6 GHz band and 5.65-5.725 GHz band, the maximum e.i.r.p. shall not exceed 1.0 W or 17 + 10 log B, dBm, whichever power is less. B is the 99% emission bandwidth in MHz
<input type="checkbox"/>	For the 5.725-5.85 GHz band, 6 dB emission bandwidth ≥ 500kHz.

3.2.2 Measuring Instruments

Refer a test equipment and calibration data table in this test report.

3.2.3 Test Procedures

Test Method							
<ul style="list-style-type: none"> ▪ For the emission bandwidth shall be measured using one of the options below: <table border="1" style="width: 100%; border-collapse: collapse;"> <tr> <td style="width: 30px;"><input checked="" type="checkbox"/></td> <td>Refer as FCC KDB 789033, clause C for EBW and clause D for OBW measurement.</td> </tr> <tr> <td><input type="checkbox"/></td> <td>Refer as ANSI C63.10, clause 6.9.1 for occupied bandwidth testing.</td> </tr> <tr> <td><input type="checkbox"/></td> <td>Refer as IC RSS-Gen, clause 4.6 for bandwidth testing.</td> </tr> </table> 		<input checked="" type="checkbox"/>	Refer as FCC KDB 789033, clause C for EBW and clause D for OBW measurement.	<input type="checkbox"/>	Refer as ANSI C63.10, clause 6.9.1 for occupied bandwidth testing.	<input type="checkbox"/>	Refer as IC RSS-Gen, clause 4.6 for bandwidth testing.
<input checked="" type="checkbox"/>	Refer as FCC KDB 789033, clause C for EBW and clause D for OBW measurement.						
<input type="checkbox"/>	Refer as ANSI C63.10, clause 6.9.1 for occupied bandwidth testing.						
<input type="checkbox"/>	Refer as IC RSS-Gen, clause 4.6 for bandwidth testing.						

3.2.4 Test Setup

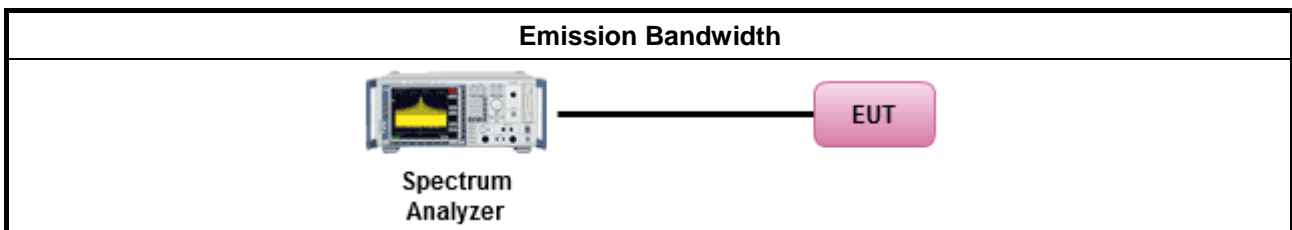

3.2.5 Test Result of Emission Bandwidth

Refer as Appendix B



3.3 Maximum Conducted Output Power

3.3.1 Maximum Conducted Output Power Limit

Maximum Conducted Output Power Limit	
UNII Devices	
<input checked="" type="checkbox"/> For the 5.15-5.25 GHz band:	
<input type="checkbox"/>	<ul style="list-style-type: none"> ▪ Outdoor AP: the maximum conducted output power (P_{Out}) shall not exceed the lesser of 1 W. If $G_{TX} > 6$ dBi, then $P_{Out} = 30 - (G_{TX} - 6)$. e.i.r.p. at any elevation angle above 30 degrees $\leq 125mW$ [21dBm] ▪ Indoor AP: the maximum conducted output power (P_{Out}) shall not exceed the lesser of 1 W. If $G_{TX} > 6$ dBi, then $P_{Out} = 30 - (G_{TX} - 6)$ ▪ Point-to-point AP: the maximum conducted output power (P_{Out}) shall not exceed the lesser of 1 W. If $G_{TX} > 23$ dBi, then $P_{Out} = 30 - (G_{TX} - 23)$. ▪ Mobile or Portable Client: the maximum conducted output power (P_{Out}) shall not exceed the lesser of 250 mW. If $G_{TX} > 6$ dBi, then $P_{Out} = 24 - (G_{TX} - 6)$.
<input type="checkbox"/>	For the 5.25-5.35 GHz band, the maximum conducted output power (P_{Out}) shall not exceed the lesser of 250 mW or $11 \text{ dBm} + 10 \log B$, where B is the 26 dB emission bandwidth in MHz. If $G_{TX} > 6$ dBi, then $P_{Out} = 24 - (G_{TX} - 6)$.
<input type="checkbox"/>	For the 5.47-5.725 GHz band, the maximum conducted output power (P_{Out}) shall not exceed the lesser of 250 mW or $11 \text{ dBm} + 10 \log B$, where B is the 26 dB emission bandwidth in MHz. If $G_{TX} > 6$ dBi, then $P_{Out} = 24 - (G_{TX} - 6)$.
<input checked="" type="checkbox"/> For the 5.725-5.85 GHz band:	
<input type="checkbox"/>	<ul style="list-style-type: none"> ▪ Point-to-multipoint systems (P2M): the maximum conducted output power (P_{Out}) shall not exceed the lesser of 1 W. If $G_{TX} > 6$ dBi, then $P_{Out} = 30 - (G_{TX} - 6)$. ▪ Point-to-point systems (P2P): the maximum conducted output power (P_{Out}) shall not exceed the lesser of 1 W.
LE-LAN Devices	
<input type="checkbox"/>	For the 5.15-5.25 GHz band, the maximum e.i.r.p. shall not exceed 200 mW or $10 + 10 \log B$, dBm, whichever power is less. B is the 99% emission bandwidth in MHz.
<input type="checkbox"/>	For the 5.25-5.35 GHz band, the maximum e.i.r.p. shall not exceed 1.0 W or $17 + 10 \log B$, dBm, whichever power is less. B is the 99% emission bandwidth in MHz
<input type="checkbox"/>	For the 5.47-5.6 GHz band and 5.65-5.725 GHz band, the maximum e.i.r.p. shall not exceed 1.0 W or $17 + 10 \log B$, dBm, whichever power is less. B is the 99% emission bandwidth in MHz
<input type="checkbox"/> For the 5.725-5.85 GHz band:	
<input type="checkbox"/>	<ul style="list-style-type: none"> ▪ Point-to-multipoint systems (P2M): the maximum conducted output power (P_{Out}) shall not exceed the lesser of 1 W. If $G_{TX} > 6$ dBi, then $P_{Out} = 30 - (G_{TX} - 6)$. ▪ Point-to-point systems (P2P): the maximum conducted output power (P_{Out}) shall not exceed the lesser of 1 W.
P_{Out} = maximum conducted output power in dBm, G_{TX} = the maximum transmitting antenna directional gain in dBi.	

3.3.2 Measuring Instruments

Refer a test equipment and calibration data table in this test report.

3.3.3 Test Procedures

Test Method	
<ul style="list-style-type: none"> Maximum Conducted Output Power 	
Average over on/off periods with duty factor	
<input type="checkbox"/>	Refer as FCC KDB 789033, clause E Method SA-2 (spectral trace averaging).
<input type="checkbox"/>	Refer as FCC KDB 789033, clause E Method SA-2 Alt. (RMS detection with slow sweep speed)
Wideband RF power meter and average over on/off periods with duty factor	
<input checked="" type="checkbox"/>	Refer as FCC KDB 789033, clause E Method PM-G (using an RF average power meter).
<ul style="list-style-type: none"> For conducted measurement. 	
<ul style="list-style-type: none"> If the EUT supports multiple transmit chains using options given below: Refer as FCC KDB 662911, In-band power measurements. Using the measure-and-sum approach, measured all transmit ports individually. Sum the power (in linear power units e.g., mW) of all ports for each individual sample and save them. 	
<ul style="list-style-type: none"> If multiple transmit chains, EIRP calculation could be following as methods: $P_{total} = P_1 + P_2 + \dots + P_n$ (calculated in linear unit [mW] and transfer to log unit [dBm]) $EIRP_{total} = P_{total} + DG$ 	

3.3.4 Test Setup

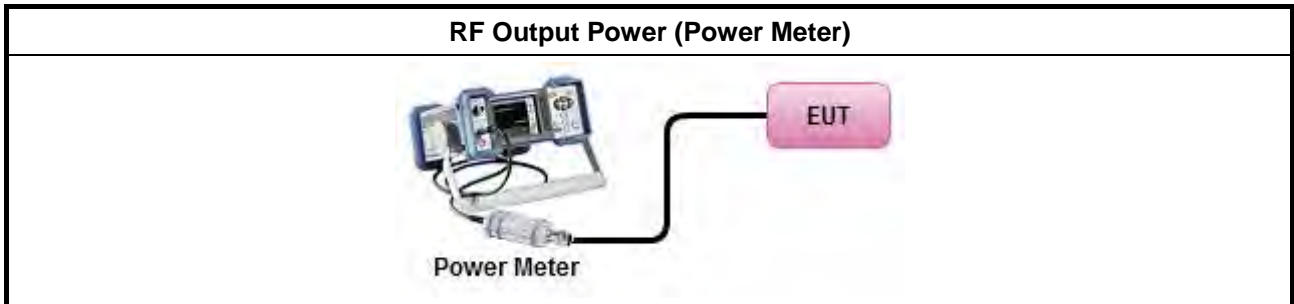

3.3.5 Test Result of Maximum Conducted Output Power

Refer as Appendix C



3.4 Peak Power Spectral Density

3.4.1 Peak Power Spectral Density Limit

Peak Power Spectral Density Limit	
UNII Devices	
<input checked="" type="checkbox"/> For the 5.15-5.25 GHz band:	
<input type="checkbox"/>	<ul style="list-style-type: none"> Outdoor AP: the peak power spectral density (PPSD) shall not exceed the lesser of 17dBm/MHz. If $G_{TX} > 6$ dBi, then $P_{Out} = 17 - (G_{TX} - 6)$. Indoor AP: the peak power spectral density (PPSD) shall not exceed the lesser of 17dBm/MHz. If $G_{TX} > 6$ dBi, then $P_{Out} = 17 - (G_{TX} - 6)$. Point-to-point AP: the peak power spectral density (PPSD) shall not exceed the lesser of 17dBm/MHz. If $G_{TX} > 23$ dBi, then $P_{Out} = 17 - (G_{TX} - 23)$. Mobile or Portable Client: the peak power spectral density (PPSD) ≤ 11 dBm/MHz. If $G_{TX} > 6$ dBi, then $PPSD = 11 - (G_{TX} - 6)$.
<input type="checkbox"/> For the 5.25-5.35 GHz band, the peak power spectral density (PPSD) ≤ 11 dBm/MHz. If $G_{TX} > 6$ dBi, then $PPSD = 11 - (G_{TX} - 6)$.	
<input type="checkbox"/> For the 5.47-5.725 GHz band, the peak power spectral density (PPSD) ≤ 11 dBm/MHz. If $G_{TX} > 6$ dBi, then $PPSD = 11 - (G_{TX} - 6)$.	
<input checked="" type="checkbox"/> For the 5.725-5.85 GHz band:	
<input type="checkbox"/>	<ul style="list-style-type: none"> Point-to-multipoint systems (P2M): the peak power spectral density (PPSD) ≤ 30 dBm/500kHz. If $G_{TX} > 6$ dBi, then $PPSD = 30 - (G_{TX} - 6)$. Point-to-point systems (P2P): the peak power spectral density (PPSD) ≤ 30 dBm/500kHz.
LE-LAN Devices	
<input type="checkbox"/> For the 5.15-5.25 GHz band, the e.i.r.p. peak power spectral density (PPSD) ≤ 10 dBm/MHz.	
<input type="checkbox"/> For the 5.25-5.35 GHz band, the peak power spectral density (PPSD) ≤ 11 dBm/MHz.	
<input type="checkbox"/>	<ul style="list-style-type: none"> e.i.r.p. greater than 200 mW shall comply with the following e.i.r.p. at different elevations, where θ is the angle above the local horizontal plane (of the Earth) as shown below: -13 dBW/MHz for $0^\circ \leq \theta < 8^\circ$; -13 - 0.716 ($\theta-8$) dBW/MHz for $8^\circ \leq \theta < 40^\circ$ -35.9 - 1.22 ($\theta-40$) dBW/MHz for $40^\circ \leq \theta \leq 45^\circ$; -42 dBW/MHz for $\theta > 45^\circ$
<input type="checkbox"/> For the 5.47-5.6 GHz band and 5.65-5.725 GHz band, the peak power spectral density (PPSD) ≤ 11 dBm/MHz.	
<input type="checkbox"/> For the 5.725-5.85 GHz band:	
<input type="checkbox"/>	<ul style="list-style-type: none"> Point-to-multipoint systems (P2M): the peak power spectral density (PPSD) ≤ 30 dBm/500kHz. If $G_{TX} > 6$ dBi, then $PPSD = 30 - (G_{TX} - 6)$. Point-to-point systems (P2P): the peak power spectral density (PPSD) ≤ 30 dBm/500kHz.
PPSD = peak power spectral density that he same method as used to determine the conducted output power shall be used to determine the power spectral density. And power spectral density in dBm/MHz G_{TX} = the maximum transmitting antenna directional gain in dBi.	

3.4.2 Measuring Instruments

Refer a test equipment and calibration data table in this test report.



3.4.3 Test Procedures

Test Method	
<ul style="list-style-type: none"> ▪ Peak power spectral density procedures that the same method as used to determine the conducted output power shall be used to determine the peak power spectral density and use the peak search function on the spectrum analyzer to find the peak of the spectrum. For the peak power spectral density shall be measured using below options: 	
<input type="checkbox"/>	Refer as FCC KDB 789033, F5) power spectral density can be measured using resolution bandwidths < 1 MHz provided that the results are integrated over 1 MHz bandwidth
[duty cycle ≥ 98% or external video / power trigger]	
<input checked="" type="checkbox"/>	Refer as FCC KDB 789033, clause E Method SA-1 (spectral trace averaging).
<input type="checkbox"/>	Refer as FCC KDB 789033, clause E Method SA-1 Alt. (RMS detection with slow sweep speed)
duty cycle < 98% and average over on/off periods with duty factor	
<input checked="" type="checkbox"/>	Refer as FCC KDB 789033, clause E Method SA-2 (spectral trace averaging).
<input type="checkbox"/>	Refer as FCC KDB 789033, clause E Method SA-2 Alt. (RMS detection with slow sweep speed)
<ul style="list-style-type: none"> ▪ For conducted measurement. 	
<ul style="list-style-type: none"> ▪ If the EUT supports multiple transmit chains using options given below: 	
<input type="checkbox"/>	Option 1: Measure and sum the spectra across the outputs. Refer as FCC KDB 662911, In-band power spectral density (PSD). Sample all transmit ports simultaneously using a spectrum analyzer for each transmit port. Where the trace bin-by-bin of each transmit port summing can be performed. (i.e., in the first spectral bin of output 1 is summed with that in the first spectral bin of output 2 and that from the first spectral bin of output 3, and so on up to the NTX output to obtain the value for the first frequency bin of the summed spectrum.). Add up the amplitude (power) values for the different transmit chains and use this as the new data trace.
<input type="checkbox"/>	Option 2: Measure and sum spectral maxima across the outputs. With this technique, spectra are measured at each output of the device at the required resolution bandwidth. The maximum value (peak) of each spectrum is determined. These maximum values are then summed mathematically in linear power units across the outputs. These operations shall be performed separately over frequency spans that have different out-of-band or spurious emission limits,
<input type="checkbox"/>	Option 3: Measure and add 10 log(N) dB, where N is the number of transmit chains. Refer as FCC KDB 662911, In-band power spectral density (PSD). Performed at each transmit chains and each transmit chains shall be compared with the limit have been reduced with 10 log(N). Or each transmit chains shall be add 10 log(N) to compared with the limit.
<ul style="list-style-type: none"> ▪ If multiple transmit chains, EIRP PPSD calculation could be following as methods: $PPSD_{total} = PPSD_1 + PPSD_2 + \dots + PPSD_n$ (calculated in linear unit [mW] and transfer to log unit [dBm]) $EIRP_{total} = PPSD_{total} + DG$ 	

3.4.4 Test Setup

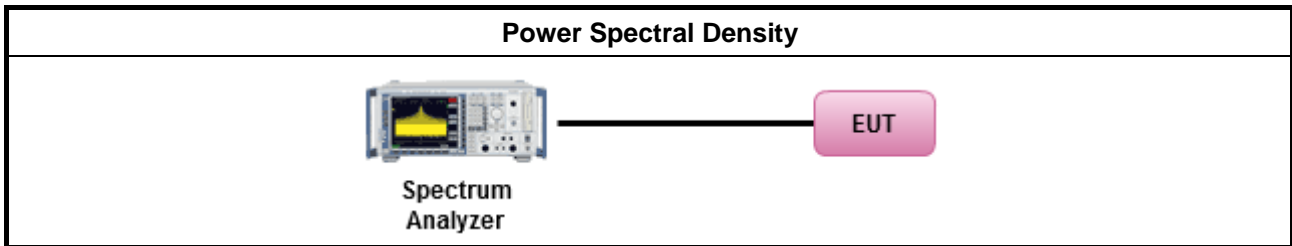

3.4.5 Test Result of Peak Power Spectral Density

Refer as Appendix D



3.5 Unwanted Emissions

3.5.1 Transmitter Unwanted Emissions Limit

Unwanted emissions below 1 GHz and restricted band emissions above 1GHz limit			
Frequency Range (MHz)	Field Strength (uV/m)	Field Strength (dBuV/m)	Measure Distance (m)
0.009~0.490	2400/F(kHz)	48.5 - 13.8	300
0.490~1.705	24000/F(kHz)	33.8 - 23	30
1.705~30.0	30	29	30
30~88	100	40	3
88~216	150	43.5	3
216~960	200	46	3
Above 960	500	54	3

Note 1: Test distance for frequencies at or above 30 MHz, measurements may be performed at a distance other than the limit distance provided they are not performed in the near field and the emissions to be measured can be detected by the measurement equipment. When performing measurements at a distance other than that specified, the results shall be extrapolated to the specified distance using an extrapolation factor of 20 dB/decade (inverse of linear distance for field-strength measurements, inverse of linear distance-squared for power-density measurements).

Note 2: Test distance for frequencies at below 30 MHz, measurements may be performed at a distance closer than the EUT limit distance; however, an attempt should be made to avoid making measurements in the near field. When performing measurements below 30 MHz at a closer distance than the limit distance, the results shall be extrapolated to the specified distance by either making measurements at a minimum of two or more distances on at least one radial to determine the proper extrapolation factor or by using the square of an inverse linear distance extrapolation factor (40 dB/decade). The test report shall specify the extrapolation method used to determine compliance of the EUT.

Note 3: Using the distance of 1m during the test for above 18 GHz, and the test value to correct for the distance factor at 3m.



Un-restricted band emissions above 1GHz Limit	
Operating Band	Limit
<input checked="" type="checkbox"/> 5.15 - 5.25 GHz	e.i.r.p. -27 dBm [68.2 dBuV/m@3m]
<input type="checkbox"/> 5.25 - 5.35 GHz	e.i.r.p. -27 dBm [68.2 dBuV/m@3m]
<input type="checkbox"/> 5.47 - 5.725 GHz	e.i.r.p. -27 dBm [68.2 dBuV/m@3m]
<input checked="" type="checkbox"/> 5.725 - 5.85 GHz	all emissions shall be limited to a level of -27 dBm/MHz at 75 MHz or more above or below the band edge increasing linearly to 10 dBm/MHz at 25 MHz above or below the band edge, and from 25 MHz above or below the band edge increasing linearly to a level of 15.6 dBm/MHz at 5 MHz above or below the band edge, and from 5 MHz above or below the band edge increasing linearly to a level of 27 dBm/MHz at the band edge.

Note 1: Measurements may be performed at a distance other than the limit distance provided they are not performed in the near field and the emissions to be measured can be detected by the measurement equipment. When performing measurements at a distance other than that specified, the results shall be extrapolated to the specified distance using an extrapolation factor of 20 dB/decade (inverse of linear distance for field-strength measurements, inverse of linear distance-squared for power-density measurements).

3.5.2 Measuring Instruments

Refer a test equipment and calibration data table in this test report.



3.5.3 Test Procedures

Test Method	
<ul style="list-style-type: none"> ▪ Measurements may be performed at a distance other than the limit distance provided they are not performed in the near field and the emissions to be measured can be detected by the measurement equipment. Measurements shall not be performed at a distance greater than 30 m for frequencies above 30 MHz, unless it can be further demonstrated that measurements at a distance of 30 m or less are impractical. When performing measurements at a distance other than that specified, the results shall be extrapolated to the specified distance using an extrapolation factor of 20 dB/decade (inverse of linear distance for field-strength measurements, inverse of linear distance-squared for power-density measurements). 	
<ul style="list-style-type: none"> ▪ The average emission levels shall be measured in [duty cycle ≥ 98 or duty factor]. 	
<ul style="list-style-type: none"> ▪ For the transmitter unwanted emissions shall be measured using following options below: 	
	<ul style="list-style-type: none"> ▪ Refer as FCC KDB 789033, clause G)2) for unwanted emissions into non-restricted bands.
	<ul style="list-style-type: none"> ▪ Refer as FCC KDB 789033, clause G)1) for unwanted emissions into restricted bands.
	<input type="checkbox"/> Refer as FCC KDB 789033, G)6) Method AD (Trace Averaging).
	<input checked="" type="checkbox"/> Refer as FCC KDB 789033, G)6) Method VB (Reduced VBW).
	<input type="checkbox"/> Refer as ANSI C63.10, clause 11.12.2.5.3 (Reduced VBW). $VBW \geq 1/T$, where T is pulse time.
	<input type="checkbox"/> Refer as ANSI C63.10, clause 7.5 average value of pulsed emissions.
	<input checked="" type="checkbox"/> Refer as FCC KDB 789033, clause G)5) measurement procedure peak limit.
	<input type="checkbox"/> Refer as ANSI C63.10, clause 4.1.4.2.2 measurement procedure peak limit.
<ul style="list-style-type: none"> ▪ For radiated measurement. 	
	<ul style="list-style-type: none"> ▪ Refer as ANSI C63.10, clause 6.4 for radiated emissions below 30 MHz and test distance is 3m.
	<ul style="list-style-type: none"> ▪ Refer as ANSI C63.10, clause 6.5 for radiated emissions 30 MHz to 1 GHz and test distance is 3m.
	<ul style="list-style-type: none"> ▪ Refer as ANSI C63.10, clause 6.6 for radiated emissions above 1GHz.
<ul style="list-style-type: none"> ▪ The any unwanted emissions level shall not exceed the fundamental emission level. 	
<ul style="list-style-type: none"> ▪ All amplitude of spurious emissions that are attenuated by more than 20 dB below the permissible value has no need to be reported. 	

3.5.4 Test Setup

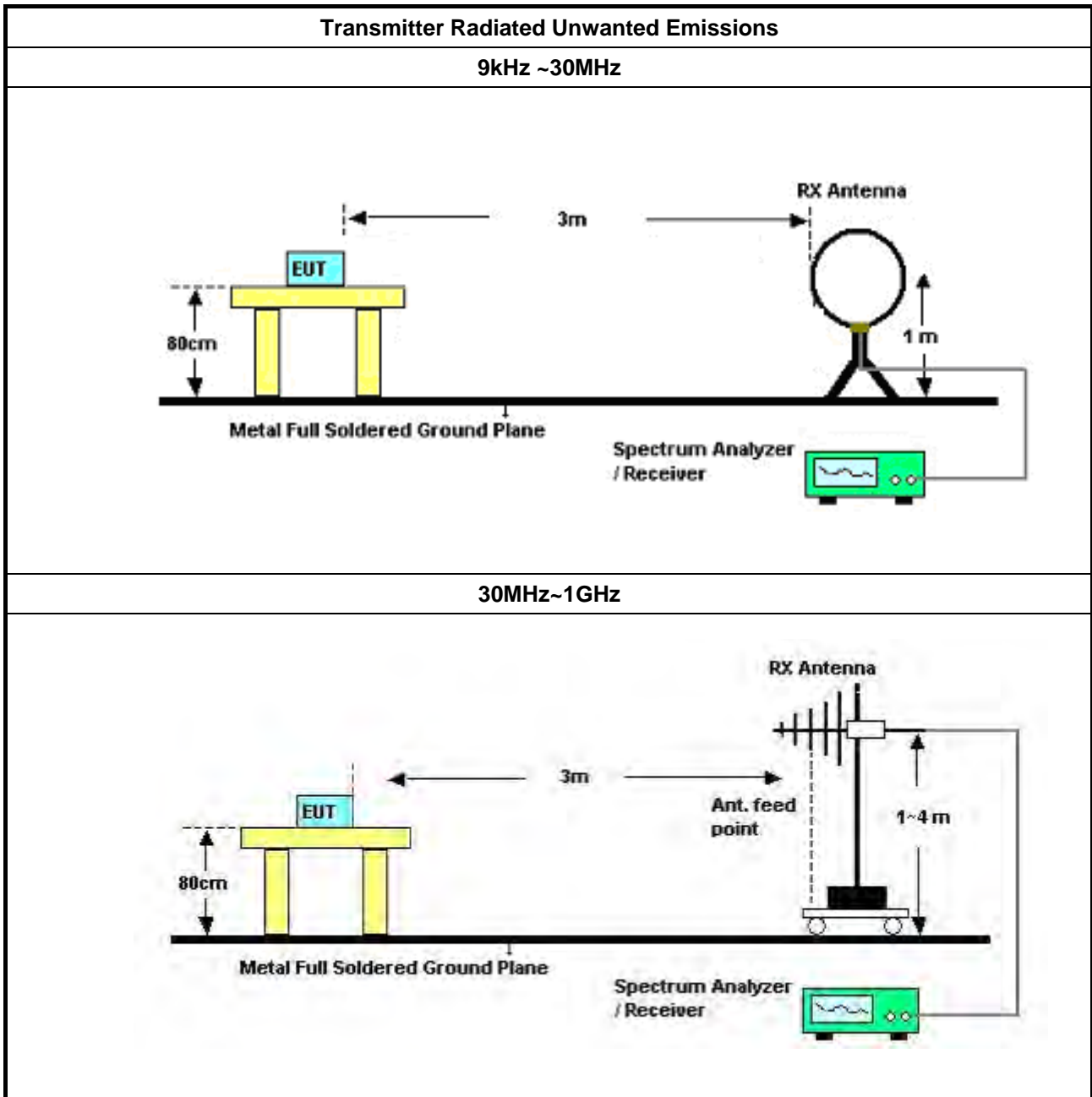

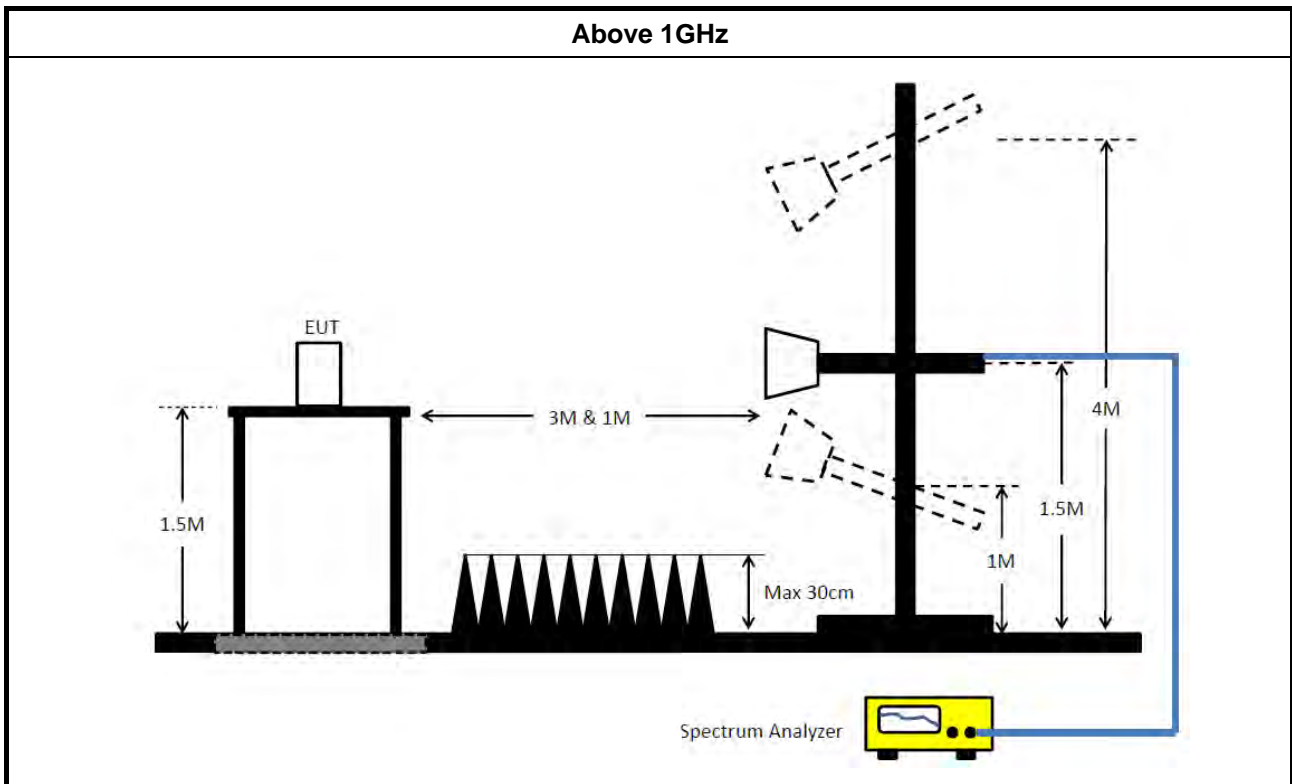

3.5.5 Measurement Results Calculation

The measured Level is calculated using:

Corrected Reading: Antenna Factor + Cable Loss + Read Level - Preamp Factor (if applicable) = Level.

3.5.6 Transmitter Unwanted Emissions (Below 30MHz)

There is a comparison data of both open-field test site and alternative test site - semi-Anechoic chamber according to KDB414788 Radiated Test Site, and the result came out very similar.

All amplitude of spurious emissions that are attenuated by more than 20 dB below the permissible value has no need to be reported.

The radiated emissions were investigated from 9 kHz or the lowest frequency generated within the device, up to the 10 harmonic or 40 GHz, whichever is appropriate.

3.5.7 Test Result of Transmitter Unwanted Emissions

Refer as Appendix E



4 Test Equipment and Calibration Data

Instrument	Manufacturer	Model No.	Serial No.	Characteristics	Calibration Date	Calibration Due Date	Remark
EMI Receiver	Agilent	N9038A	My52260123	9kHz ~ 8.45GHz	Feb. 26, 2020	Feb. 25, 2021	Conduction (CO01-CB)
LISN	F.C.C.	FCC-LISN-50-16-2	04083	150kHz ~ 100MHz	Dec. 25, 2019	Dec. 24, 2020	Conduction (CO01-CB)
LISN	Schwarzbeck	NSLK 8127	8127647	9kHz ~ 30MHz	Feb. 25, 2020	Feb. 24, 2021	Conduction (CO01-CB)
COND Cable	Woken	Cable	Low cable-CO01	9kHz ~ 30MHz	May 21, 2019	May 20, 2020	Conduction (CO01-CB)
Software	Audix	E3	6.120210n	-	N.C.R.	N.C.R.	Conduction (CO01-CB)
Bilog Antenna with 6dB Attenuator	TESEQ & EMCI	CBL 6112D & N-6-06	35236 & AT-N0610	30MHz ~ 2GHz	Mar. 27, 2020	Mar. 26, 2021	Radiation (03CH05-CB)
Loop Antenna	Teseq	HLA 6120	24155	9kHz - 30 MHz	Apr. 13, 2020	Apr. 12, 2021	Radiation (03CH05-CB)
Horn Antenna	SCHWARZBECK	BBHA9120D	BBHA 9120D-1291	1GHz~18GHz	Oct. 05, 2019	Oct. 04, 2020	Radiation (03CH05-CB)
Horn Antenna	SCHWARZBECK	BBHA 9170	BBHA9170507	15GHz ~ 40GHz	Jun. 12, 2019	Jun. 11, 2020	Radiation (03CH05-CB)
Pre-Amplifier	EMCI	EMC330N	980331	20MHz ~ 3GHz	Apr. 28, 2020	Apr. 27, 2021	Radiation (03CH05-CB)
Pre-Amplifier	EMCI	EMC12630SE	980287	1GHz ~ 26.5GHz	Apr. 15, 2020	Apr. 14, 2021	Radiation (03CH05-CB)
Pre-Amplifier	MITEQ	TTA1840-35-HG	1864479	18GHz ~ 40GHz	Jul. 03, 2019	Jul. 02, 2020	Radiation (03CH05-CB)
Spectrum Analyzer	R&S	FSP40	100304	9kHz ~ 40GHz	Aug. 15, 2019	Aug. 14, 2020	Radiation (03CH05-CB)
EMI Test Receiver	R&S	ESCS	826547/017	9kHz ~ 2.75GHz	May 13, 2020	May 12, 2021	Radiation (03CH05-CB)
RF Cable-low	Woken	RG402	LOW Cable-04+23	30MHz~1GHz	Oct. 07, 2019	Oct. 06, 2020	Radiation (03CH05-CB)
RF Cable-high	Woken	RG402	High Cable-28	1GHz~18GHz	Oct. 07, 2019	Oct. 06, 2020	Radiation (03CH05-CB)
RF Cable-high	Woken	RG402	High Cable-04+28	1GHz~18GHz	Oct. 07, 2019	Oct. 06, 2020	Radiation (03CH05-CB)
RF Cable-high	Woken	RG402	High Cable-40G#1	18GHz ~ 40 GHz	Jul. 24, 2019	Jul. 23, 2020	Radiation (03CH05-CB)
RF Cable-high	Woken	RG402	High Cable-40G#2	18GHz ~ 40 GHz	Jul. 24, 2019	Jul. 23, 2020	Radiation (03CH05-CB)
Spectrum analyzer	R&S	FSV40	101028	9kHz~40GHz	Nov. 01, 2019	Oct. 31, 2020	Conducted (TH03-CB)
Power Sensor	Anritsu	MA2411B	1726195	300MHz~40GHz	Aug. 13, 2019	Aug. 12, 2020	Conducted (TH03-CB)
Power Meter	Anritsu	ML2495A	1035008	300MHz~40GHz	Aug. 13, 2019	Aug. 12, 2020	Conducted (TH03-CB)



Instrument	Manufacturer	Model No.	Serial No.	Characteristics	Calibration Date	Calibration Due Date	Remark
RF Cable-high	Woken	RG402	High Cable-11	1 GHz – 26.5 GHz	Oct. 07, 2019	Oct. 06, 2020	Conducted (TH03-CB)
RF Cable-high	Woken	RG402	High Cable-12	1 GHz – 26.5 GHz	Oct. 07, 2019	Oct. 06, 2020	Conducted (TH03-CB)
RF Cable-high	Woken	RG402	High Cable-13	1 GHz – 26.5 GHz	Oct. 07, 2019	Oct. 06, 2020	Conducted (TH03-CB)
RF Cable-high	Woken	RG402	High Cable-14	1 GHz – 26.5 GHz	Oct. 07, 2019	Oct. 06, 2020	Conducted (TH03-CB)
RF Cable-high	Woken	RG402	High Cable-15	1 GHz – 26.5 GHz	Oct. 07, 2019	Oct. 06, 2020	Conducted (TH03-CB)

Note: Calibration Interval of instruments listed above is one year.

N.C.R. means Non-Calibration required.



Summary

Mode	Result	Type	Freq (Hz)	Level (dBuV)	Limit (dBuV)	Margin (dB)	Factor (dB)	Condition
Mode 1	Pass	AV	500k	28.86	46.00	-17.14	9.92	Line

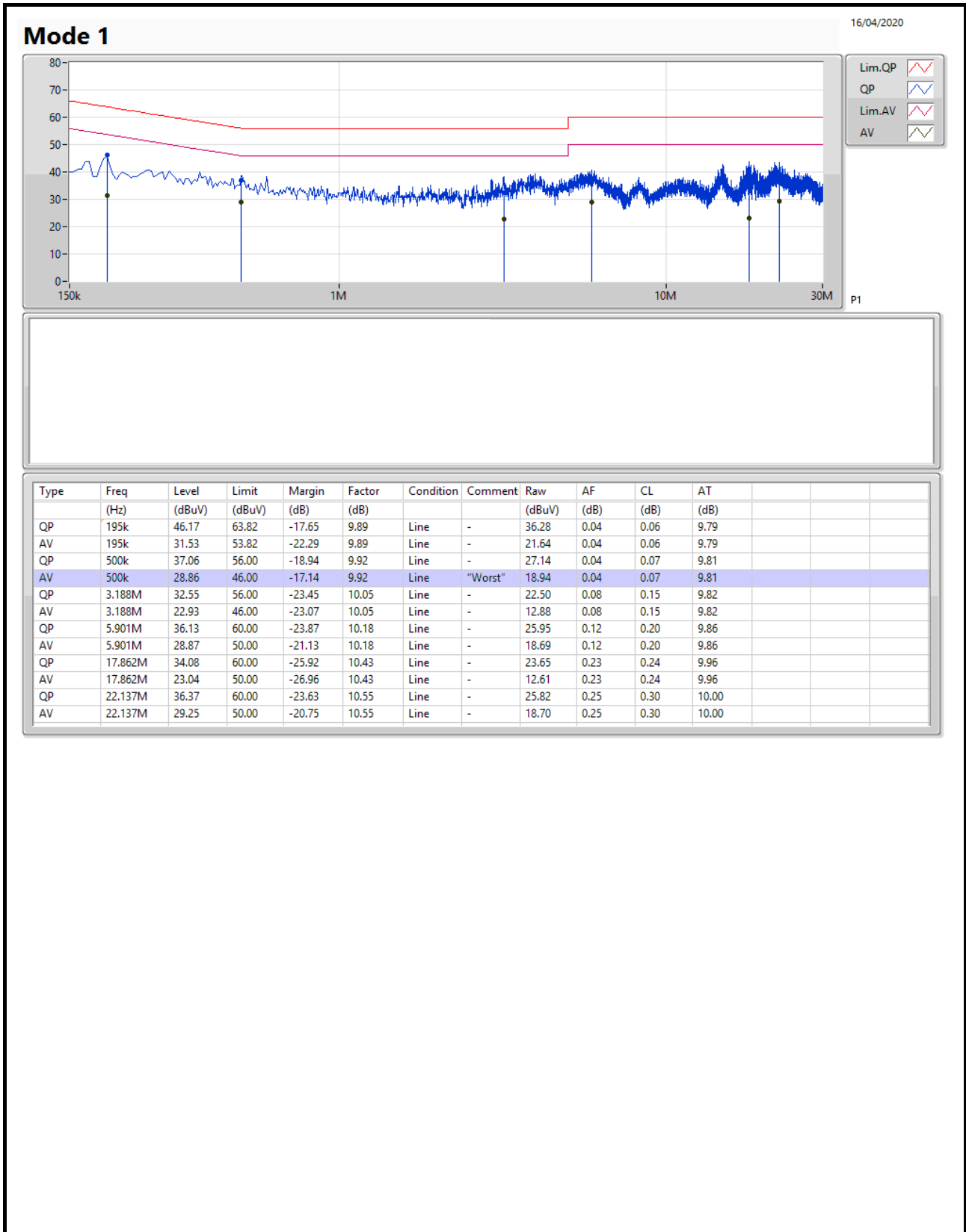

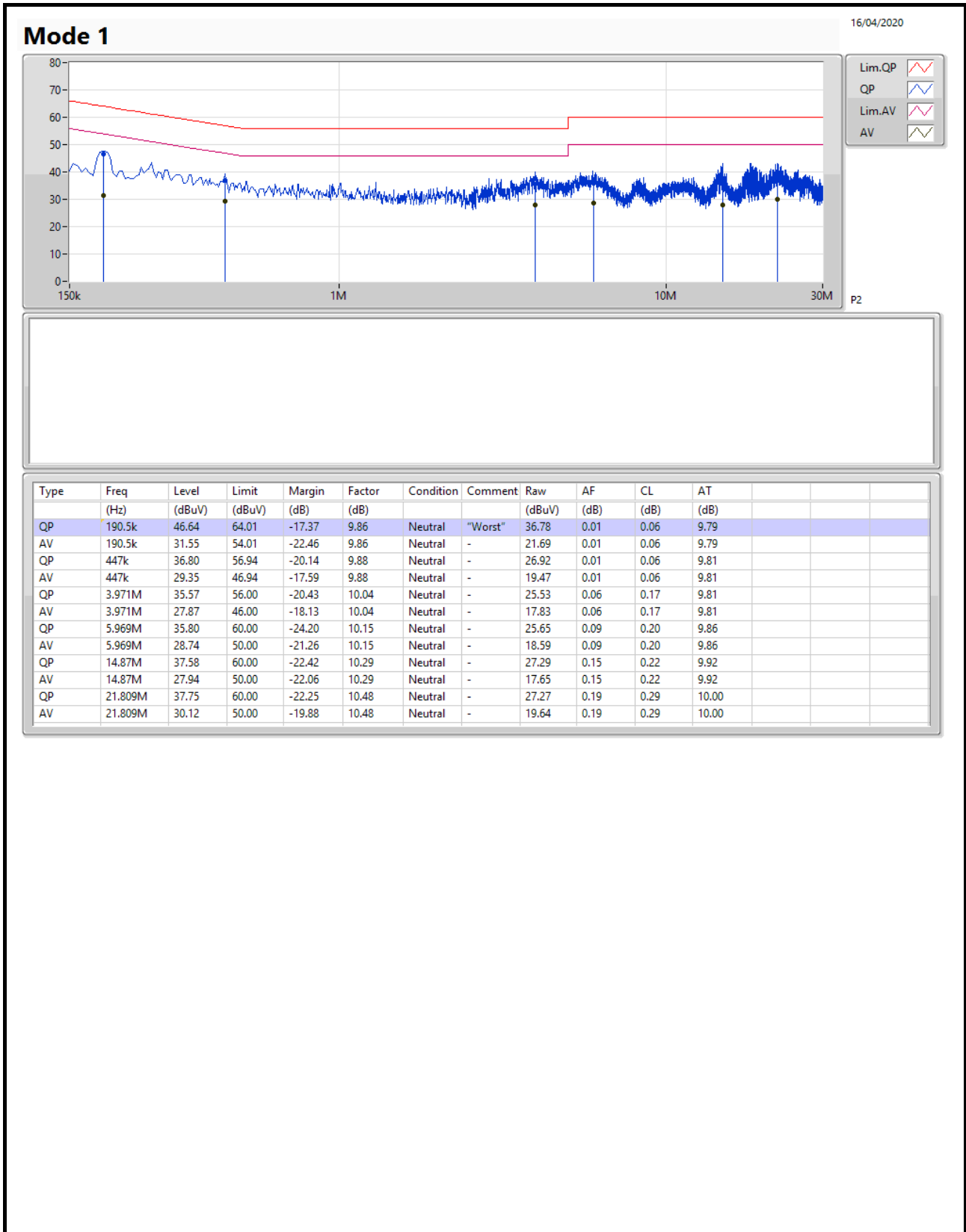



Summary

Mode	Max-N dB (Hz)	Max-OBW (Hz)	ITU-Code	Min-N dB (Hz)	Min-OBW (Hz)
5.15-5.25GHz	-	-	-	-	-
FSK_1TX	2.241M	1.904M	1M90F1D	2.127M	1.802M
5.725-5.85GHz	-	-	-	-	-
FSK_1TX	1.155M	1.889M	1M89F1D	1.071M	1.787M

Max-N dB = Maximum 6dB down bandwidth for 5.725-5.85GHz band / Maximum 26dB down bandwidth for other band;

Max-OBW = Maximum 99% occupied bandwidth;

Min-N dB = Minimum 6dB down bandwidth for 5.725-5.85GHz band / Maximum 26dB down bandwidth for other band;

Min-OBW = Minimum 99% occupied bandwidth;



Result

Mode	Result	Limit (Hz)	Port 1-N dB (Hz)	Port 1-OBW (Hz)
FSK_1TX	-	-	-	-
5157MHz	Pass	Inf	2.127M	1.802M
5201MHz	Pass	Inf	2.205M	1.892M
5243MHz	Pass	Inf	2.241M	1.904M
5726MHz	Pass	500k	1.071M	1.787M
5786MHz	Pass	500k	1.125M	1.859M
5848MHz	Pass	500k	1.155M	1.889M

Port X-N dB = Port X 6dB down bandwidth for 5.725-5.85GHz band / 26dB down bandwidth for other band

Port X-OBW = Port X 99% occupied bandwidth;

FSK_1TX

5157MHz

EBW

08/06/2020

CF
5.157GHz
Span
6MHz
RBW
20kHz
VBW
100kHz
Sweep Time
100ms
Detector Type
Peak
Port 1

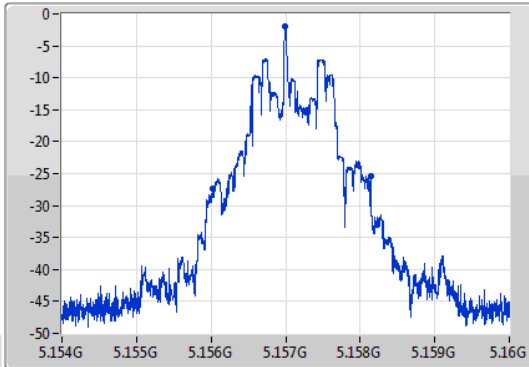

CF
5.157GHz
Span
6MHz
RBW
20kHz
VBW
100kHz
Sweep Time
100ms
Detector Type
Peak

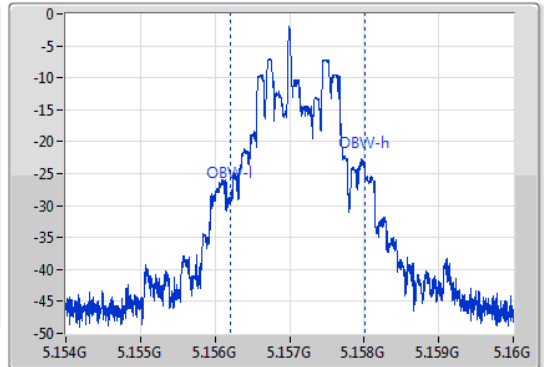

26dB(Hz)	Fl-26dB(Hz)	Fh-26dB(Hz)	OBW(Hz)	Fl-OBW(Hz)	Fh-OBW(Hz)	Limit(Hz)	Port
2.127M	5.156016G	5.158143G	1.802M	5.156202G	5.158004G	Inf	1

FSK_1TX

5201MHz

EBW

08/06/2020

CF
5.201GHz
Span
6MHz
RBW
20kHz
VBW
100kHz
Sweep Time
100ms
Detector Type
Peak
Port 1

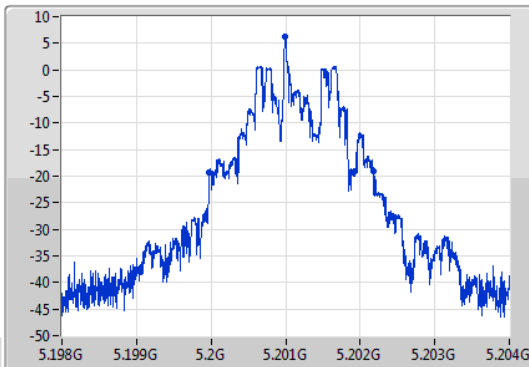

CF
5.201GHz
Span
6MHz
RBW
20kHz
VBW
100kHz
Sweep Time
100ms
Detector Type
Peak

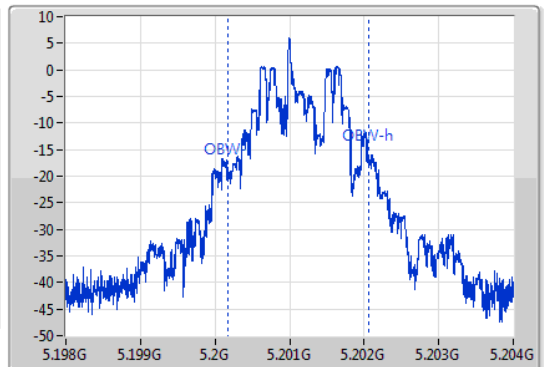

26dB(Hz)	Fl-26dB(Hz)	Fh-26dB(Hz)	OBW(Hz)	Fl-OBW(Hz)	Fh-OBW(Hz)	Limit(Hz)	Port
2.205M	5.199977G	5.202182G	1.892M	5.200172G	5.202064G	Inf	1

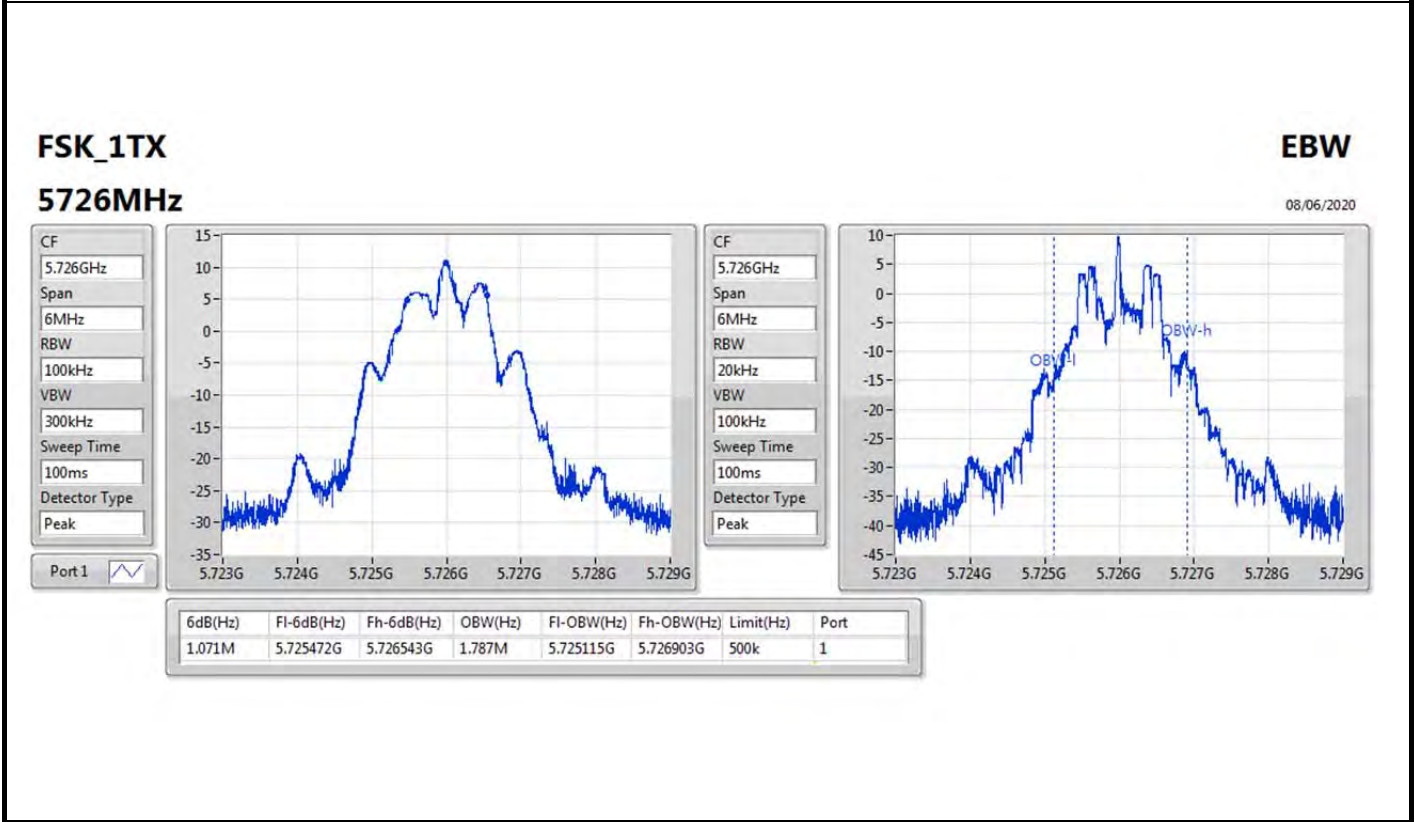
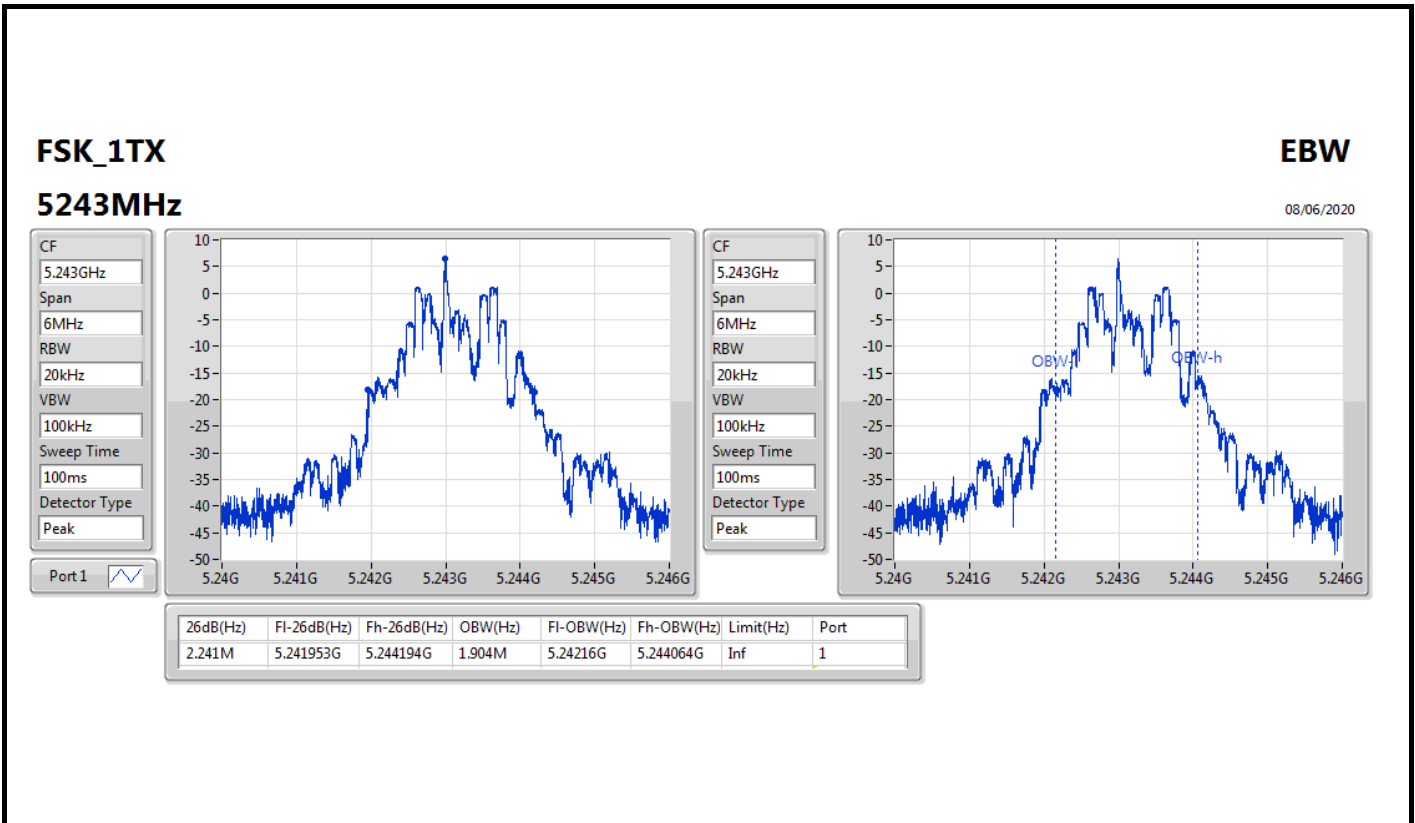

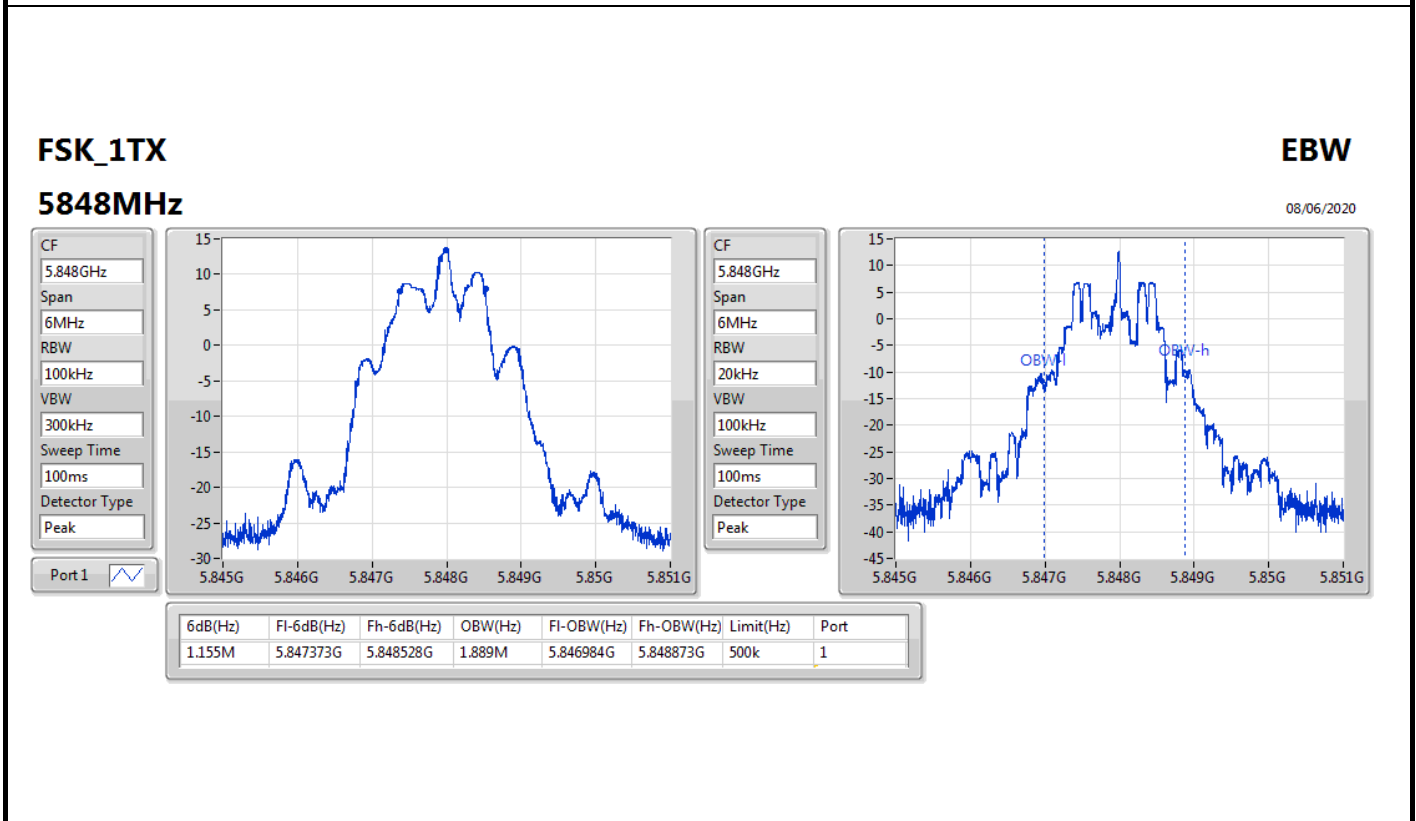
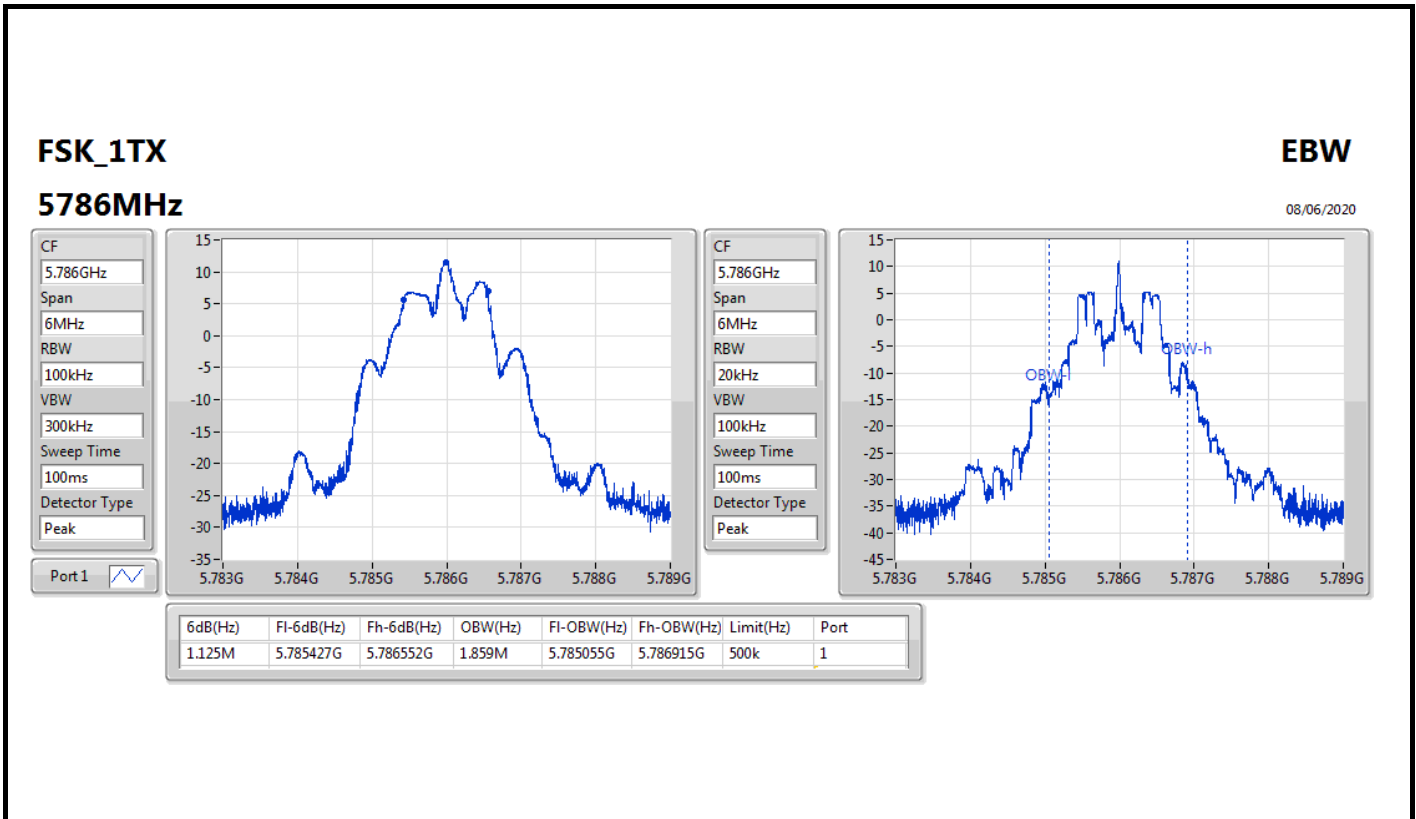



Summary

Mode	Total Power (dBm)	Total Power (W)
5.15-5.25GHz	-	-
FSK_1TX	7.41	0.00551
5.725-5.85GHz	-	-
FSK_1TX	13.61	0.02296



Result

Mode	Result	DG (dBi)	Port 1 (dBm)	Total Power (dBm)	Power Limit (dBm)
FSK_1TX	-	-	-	-	-
5157MHz	Pass	2.00	-1.41	-1.41	23.98
5201MHz	Pass	2.00	7.32	7.32	23.98
5243MHz	Pass	2.00	7.41	7.41	23.98
5726MHz	Pass	2.00	11.10	11.10	30.00
5786MHz	Pass	2.00	11.57	11.57	30.00
5848MHz	Pass	2.00	13.61	13.61	30.00

DG = Directional Gain; Port X = Port X output power



Summary

Mode	PD (dBm/RBW)
5.15-5.25GHz	-
FSK_1TX	4.09
5.725-5.85GHz	-
FSK_1TX	9.12

RBW = 500 kHz for 5.725-5.85GHz band / 1MHz for other band;



Result

Mode	Result	DG (dBi)	Port 1 (dBm/RBW)	PD (dBm/RBW)	PD Limit (dBm/RBW)
FSK_1TX	-	-	-	-	-
5157MHz	Pass	2.00	-4.14	-4.14	11.00
5201MHz	Pass	2.00	4.03	4.03	11.00
5243MHz	Pass	2.00	4.09	4.09	11.00
5726MHz	Pass	2.00	6.47	6.47	30.00
5786MHz	Pass	2.00	7.29	7.29	30.00
5848MHz	Pass	2.00	9.12	9.12	30.00

DG = Directional Gain; RBW = 500 kHz for 5.725-5.85GHz band / 1MHz for other band;

PD = trace bin-by-bin of each transmits port summing can be performed maximum power density; Port X = Port X power density;

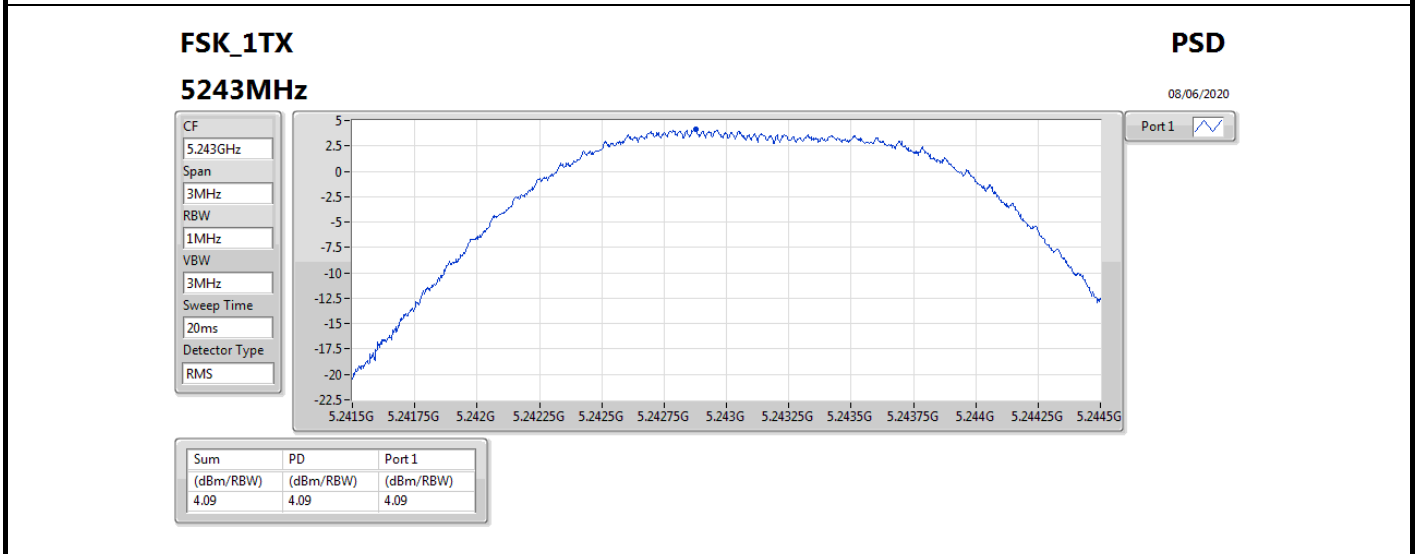
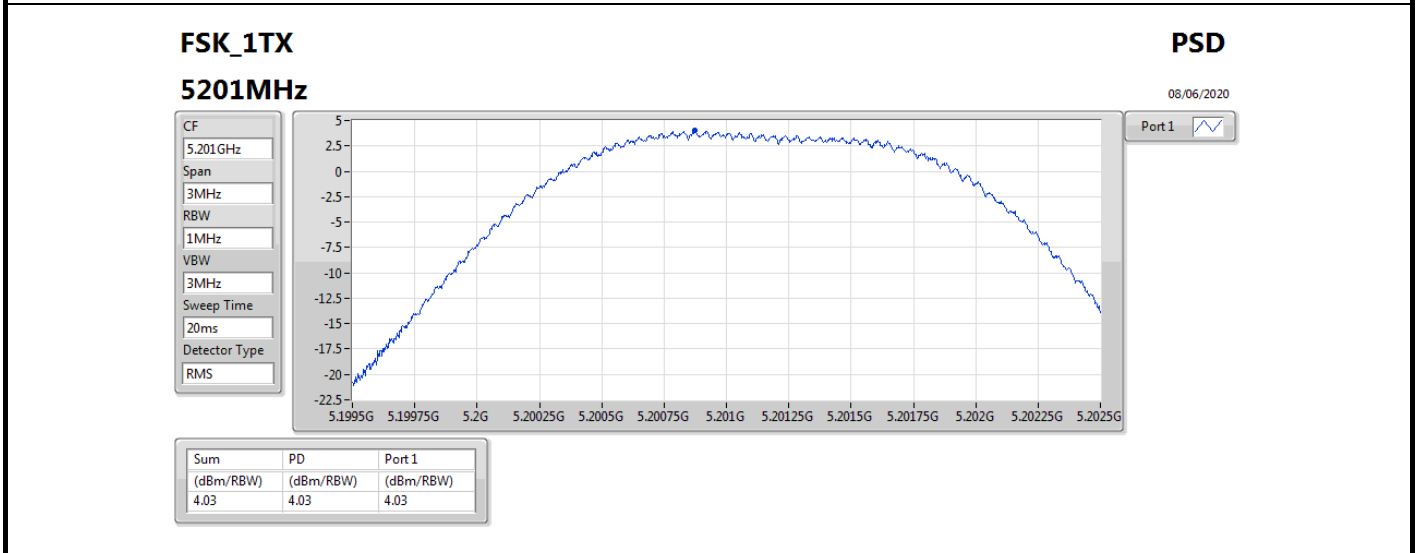
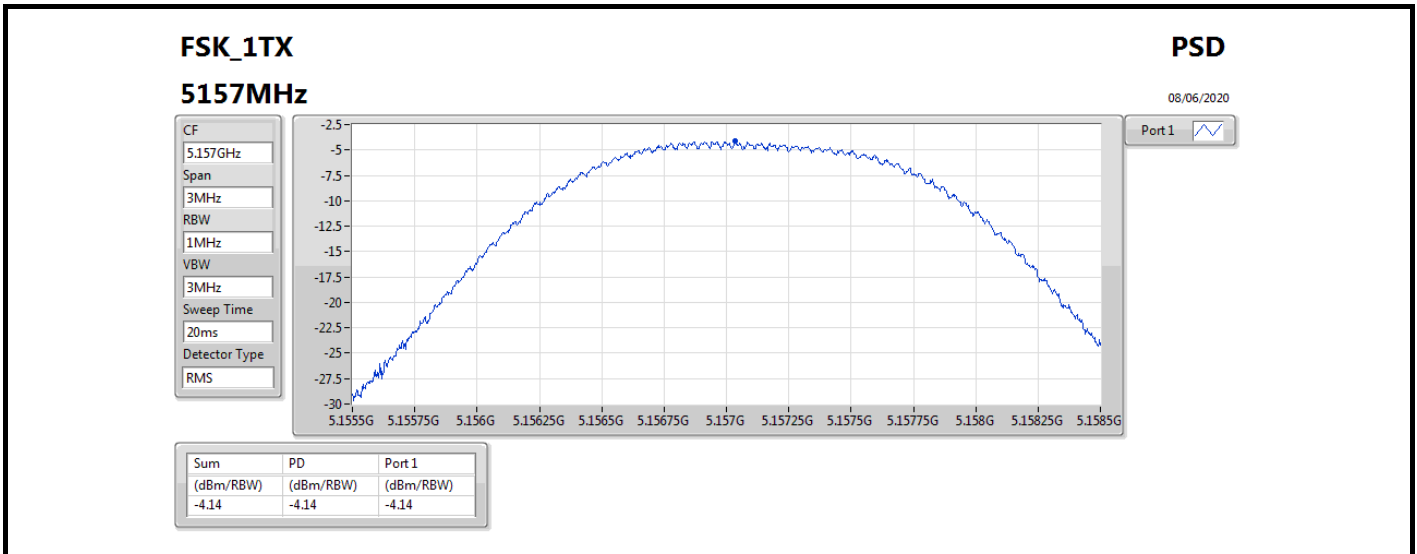

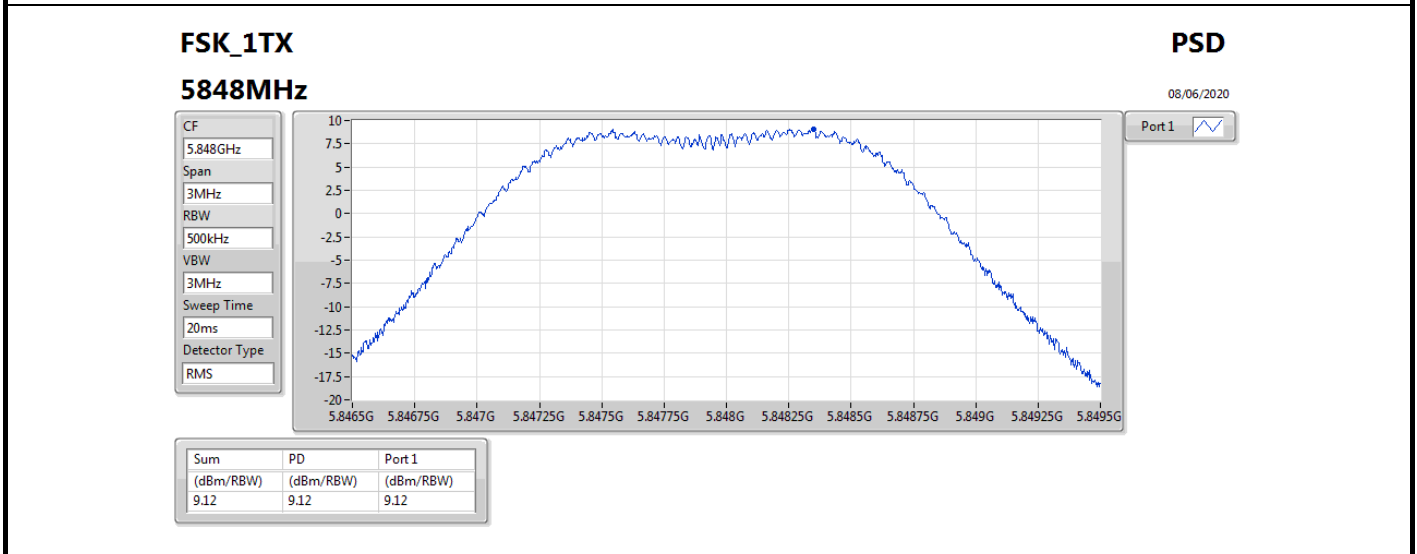
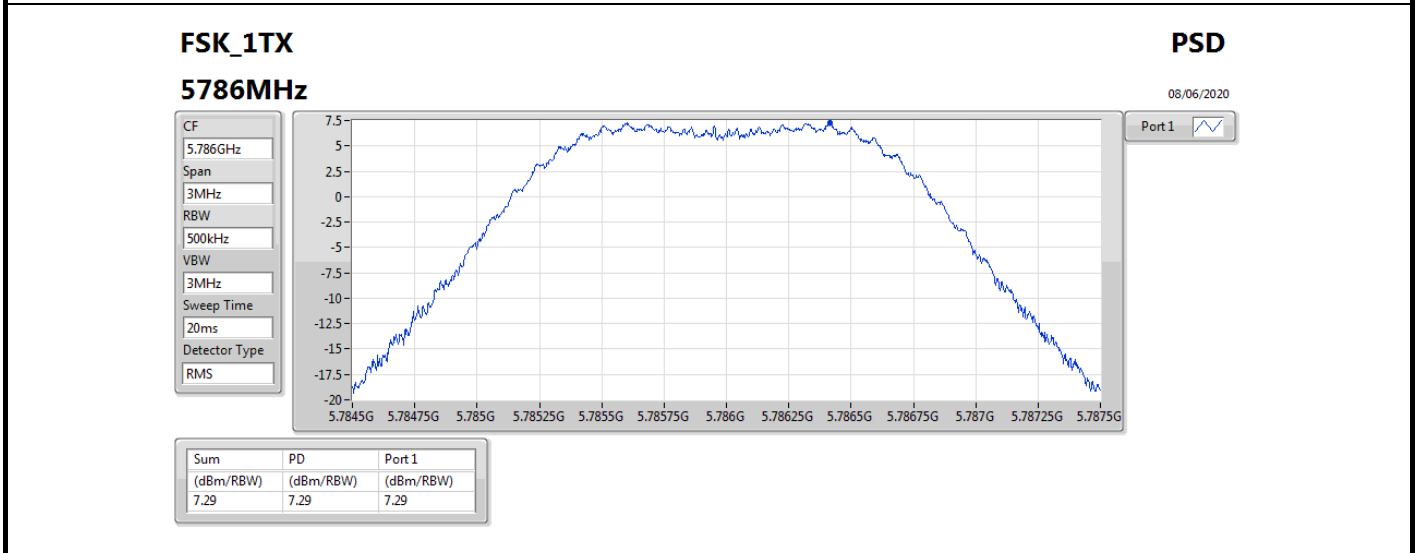
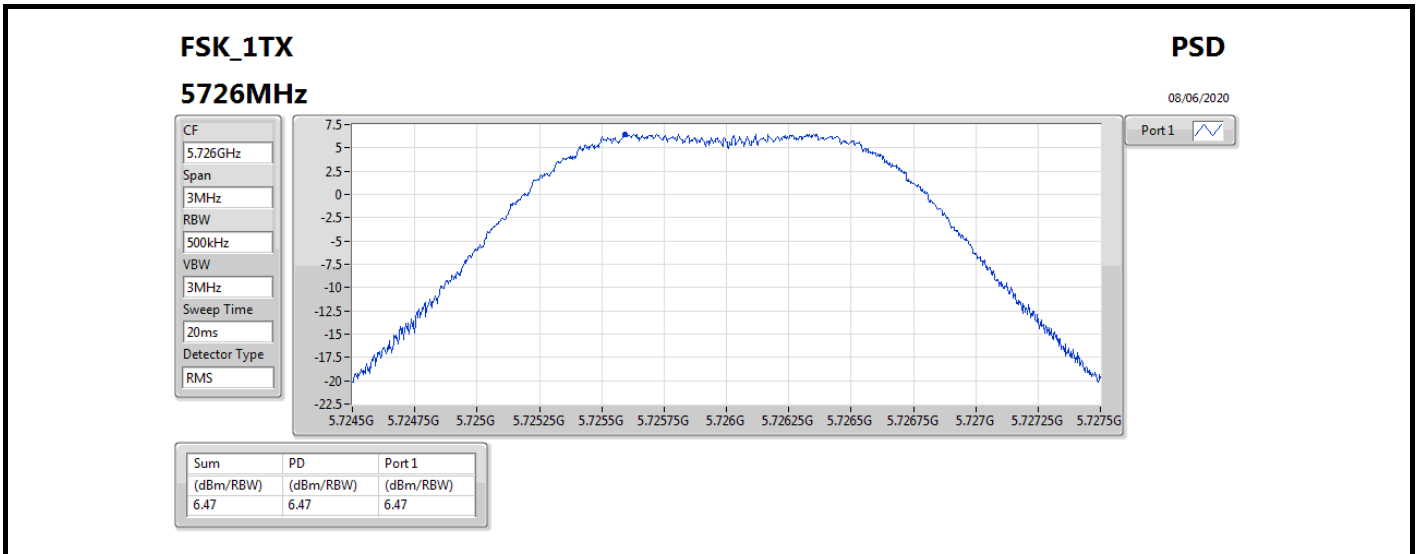



Summary

Mode	Result	Type	Freq (Hz)	Level (dBuV/m)	Limit (dBuV/m)	Margin (dB)	Condition
Mode 1	Pass	PK	146.4M	36.87	43.50	-6.63	Horizontal

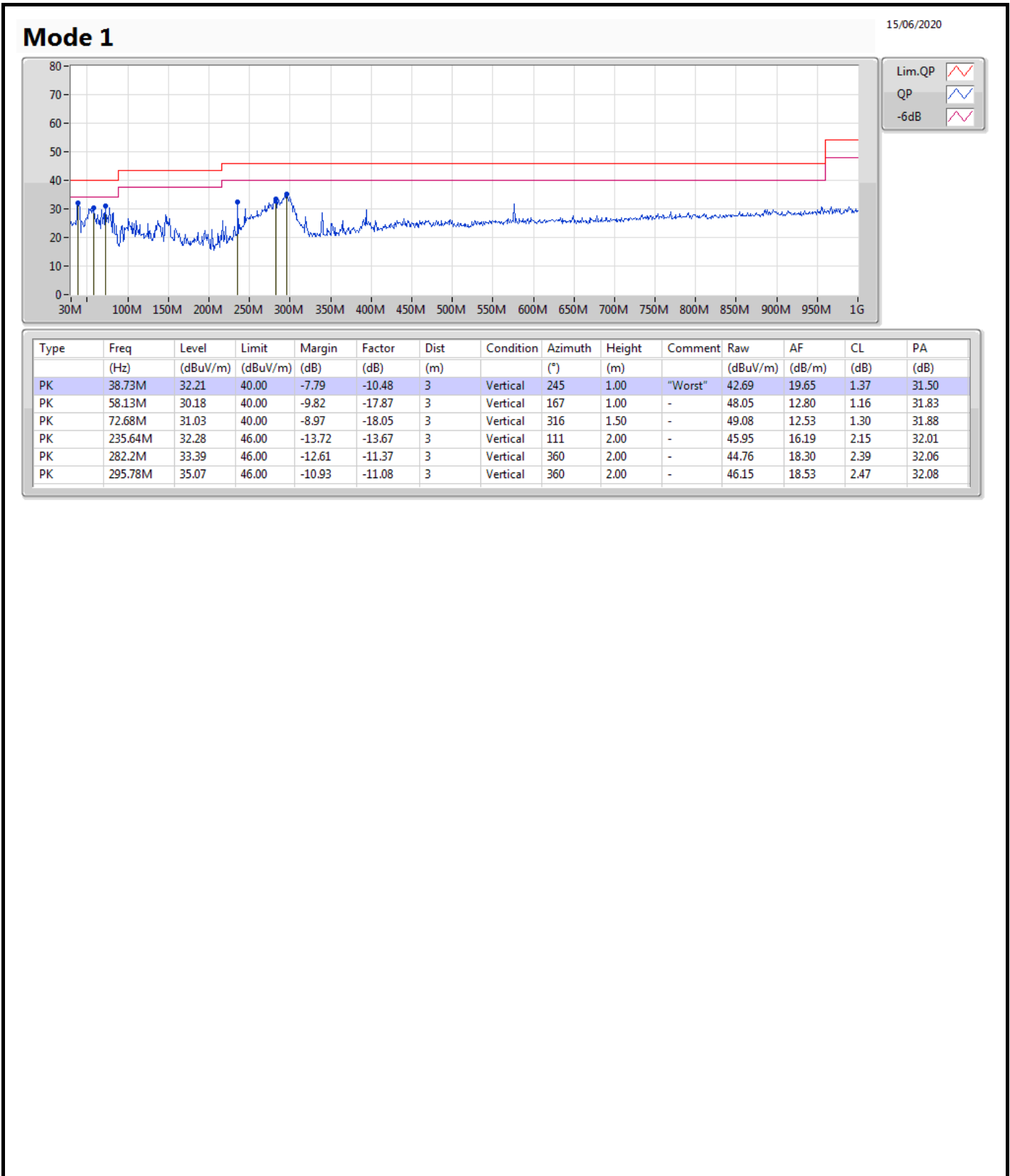

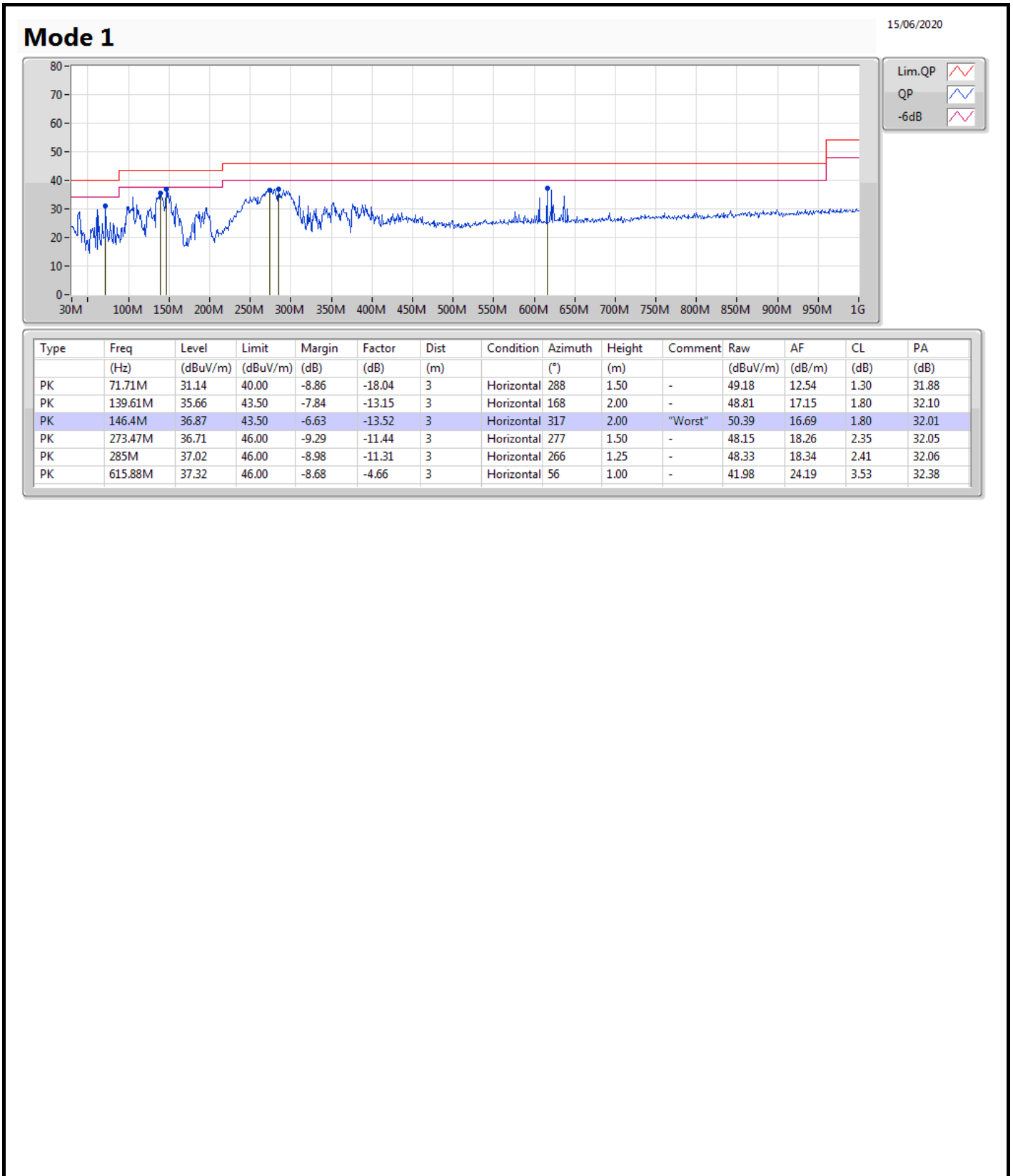



Summary

Mode	Result	Type	Freq (Hz)	Level (dBuV/m)	Limit (dBuV/m)	Margin (dB)	Dist (m)	Condition	Azimuth (°)	Height (m)	Comments
5.15-5.25GHz	-	-	-	-	-	-	-	-	-	-	-
FSK_1TX	Pass	AV	5.141G	53.65	54.00	-0.35	3	Horizontal	117	1.00	-



FSK_1TX

16/04/2020

5157MHz_TX

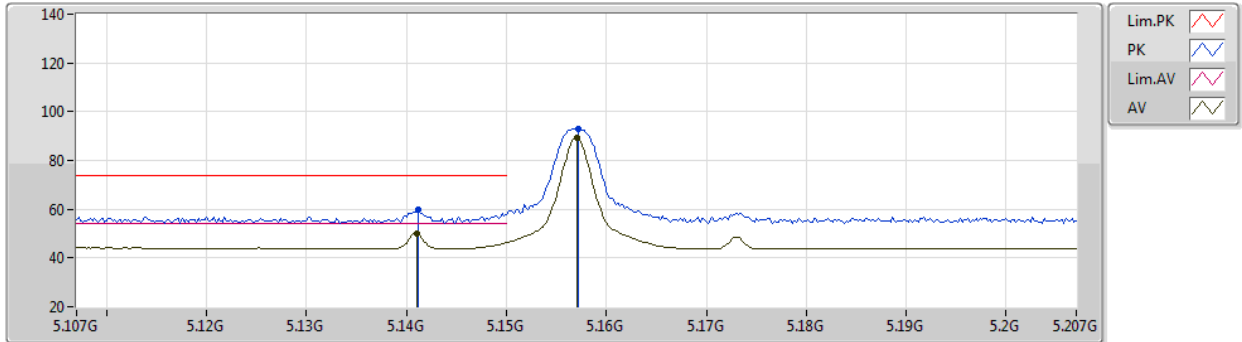

EUT Z_1TX
Setting 7
01-C-S-7 -10
EW21S-A5

Type	Freq (Hz)	Level (dBuV/m)	Limit (dBuV/m)	Margin (dB)	Raw (dBuV)	Dist (m)	Condition	Azimuth (°)	Height (m)	Comment	AF (dB)	CL (dB)	PA (dB)
PK	5.1412G	59.64	74.00	-14.36	55.60	3	Vertical	232	3.00	-	32.80	5.87	34.63
AV	5.141G	50.03	54.00	-3.97	45.99	3	Vertical	232	3.00	-	32.80	5.87	34.63
PK	5.1572G	93.17	Inf	-Inf	89.13	3	Vertical	232	3.00	-	32.80	5.88	34.64
AV	5.157G	89.32	Inf	-Inf	85.28	3	Vertical	232	3.00	-	32.80	5.88	34.64

FSK_1TX
5157MHz_TX

16/04/2020

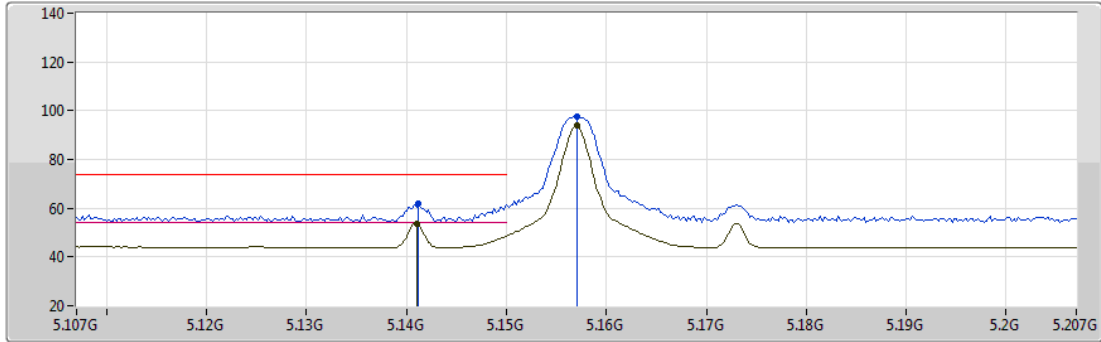

Lim.PK
 PK
 Lim.AV
 AV

EUT Z_1TX
Setting 7
01-C-5-7 -10
EW21S-A5

Type	Freq (Hz)	Level (dBuV/m)	Limit (dBuV/m)	Margin (dB)	Raw (dBuV)	Dist (m)	Condition	Azimuth (°)	Height (m)	Comment	AF (dB)	CL (dB)	PA (dB)
PK	5.1412G	61.91	74.00	-12.09	57.87	3	Horizontal	117	1.00	-	32.80	5.87	34.63
AV	5.141G	53.65	54.00	-0.35	49.61	3	Horizontal	117	1.00	-	32.80	5.87	34.63
PK	5.157G	97.73	Inf	-Inf	93.69	3	Horizontal	117	1.00	-	32.80	5.88	34.64
AV	5.157G	93.73	Inf	-Inf	89.69	3	Horizontal	117	1.00	-	32.80	5.88	34.64

FSK_1TX

16/04/2020

5157MHz_TX

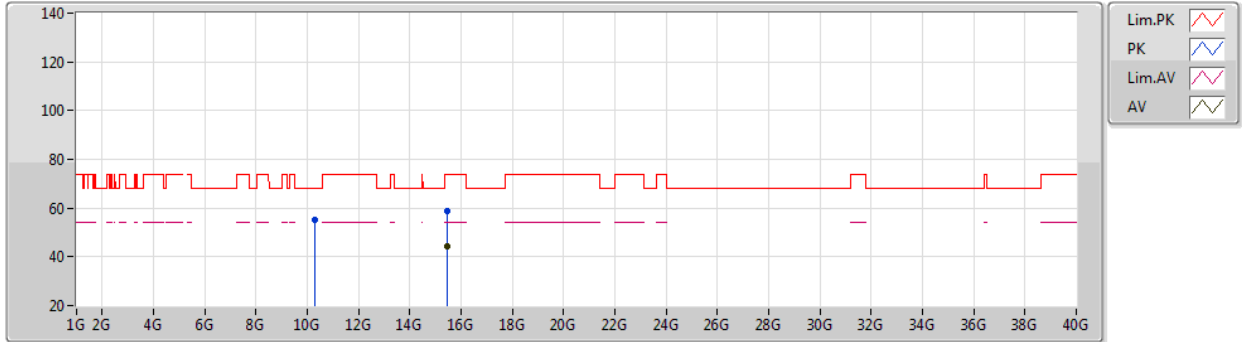

EUT Z_1TX
Setting 7
01-C-5-7
EW21S-A4

Type	Freq (Hz)	Level (dBuV/m)	Limit (dBuV/m)	Margin (dB)	Raw (dBuV)	Dist (m)	Condition	Azimuth (°)	Height (m)	Comment	AF (dB)	CL (dB)	PA (dB)
PK	10.31417G	55.06	68.20	-13.14	43.38	3	Vertical	254	1.81	-	38.19	8.90	35.41
PK	15.47217G	58.92	74.00	-15.08	45.00	3	Vertical	336	1.80	-	38.82	9.80	34.70
AV	15.47135G	44.34	54.00	-9.66	30.42	3	Vertical	336	1.80	-	38.82	9.80	34.70

FSK_1TX

16/04/2020

5157MHz_TX

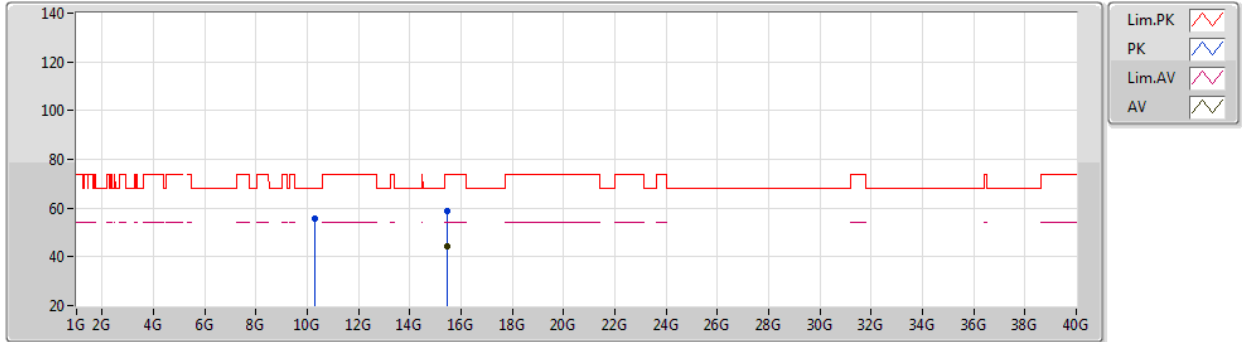

EUT Z_1TX
Setting 7
01-C-5-7
EW21S-A4

Type	Freq (Hz)	Level (dBuV/m)	Limit (dBuV/m)	Margin (dB)	Raw (dBuV)	Dist (m)	Condition	Azimuth (°)	Height (m)	Comment	AF (dB)	CL (dB)	PA (dB)
PK	10.31252G	55.66	68.20	-12.54	43.98	3	Horizontal	287	1.01	-	38.19	8.90	35.41
PK	15.4718G	58.98	74.00	-15.02	45.06	3	Horizontal	99	1.12	-	38.82	9.80	34.70
AV	15.47311G	44.48	54.00	-9.52	30.57	3	Horizontal	99	1.12	-	38.82	9.80	34.71

FSK_1TX
5201MHz_TX

16/04/2020

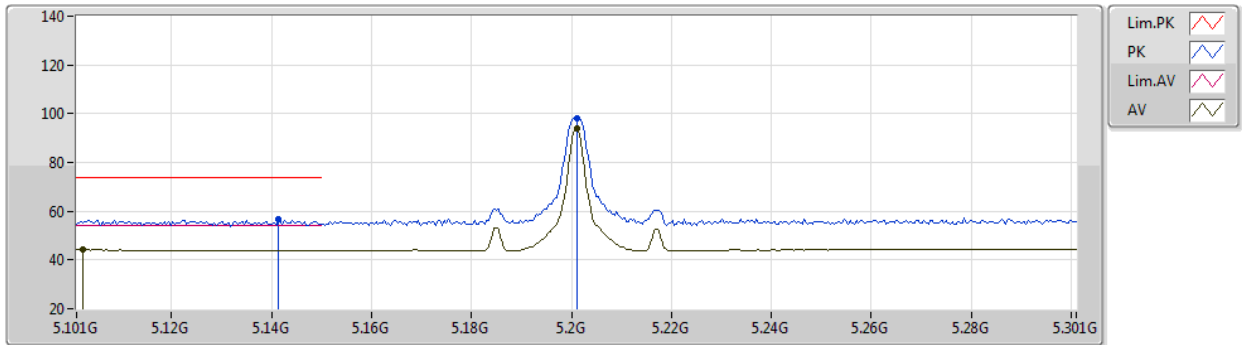

EUT Z_1TX
Setting 2
01-C-5-7 -10
EW21S-A5

Type	Freq (Hz)	Level (dBuV/m)	Limit (dBuV/m)	Margin (dB)	Raw (dBuV)	Dist (m)	Condition	Azimuth (°)	Height (m)	Comment	AF (dB)	CL (dB)	PA (dB)
PK	5.1414G	56.85	74.00	-17.15	52.81	3	Vertical	180	1.33	-	32.80	5.87	34.63
AV	5.1022G	44.12	54.00	-9.88	40.09	3	Vertical	180	1.33	-	32.80	5.85	34.62
PK	5.201G	98.10	Inf	-Inf	94.05	3	Vertical	180	1.33	-	32.80	5.90	34.65
AV	5.201G	94.13	Inf	-Inf	90.08	3	Vertical	180	1.33	-	32.80	5.90	34.65

FSK_1TX
5201MHz_TX

16/04/2020

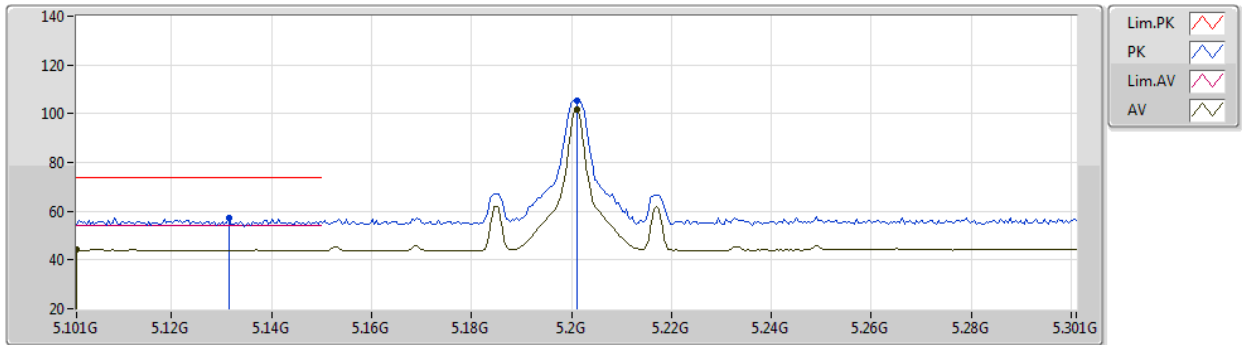

EUT Z_1TX
Setting 2
01-C-5-7 -10
EW21S-A5

Type	Freq (Hz)	Level (dBuV/m)	Limit (dBuV/m)	Margin (dB)	Raw (dBuV)	Dist (m)	Condition	Azimuth (°)	Height (m)	Comment	AF (dB)	CL (dB)	PA (dB)
PK	5.1314G	57.27	74.00	-16.73	53.23	3	Horizontal	115	1.03	-	32.80	5.87	34.63
AV	5.101G	44.20	54.00	-9.80	40.17	3	Horizontal	115	1.03	-	32.80	5.85	34.62
PK	5.201G	105.47	Inf	-Inf	101.42	3	Horizontal	115	1.03	-	32.80	5.90	34.65
AV	5.201G	101.50	Inf	-Inf	97.45	3	Horizontal	115	1.03	-	32.80	5.90	34.65

FSK_1TX

16/04/2020

5201MHz_TX

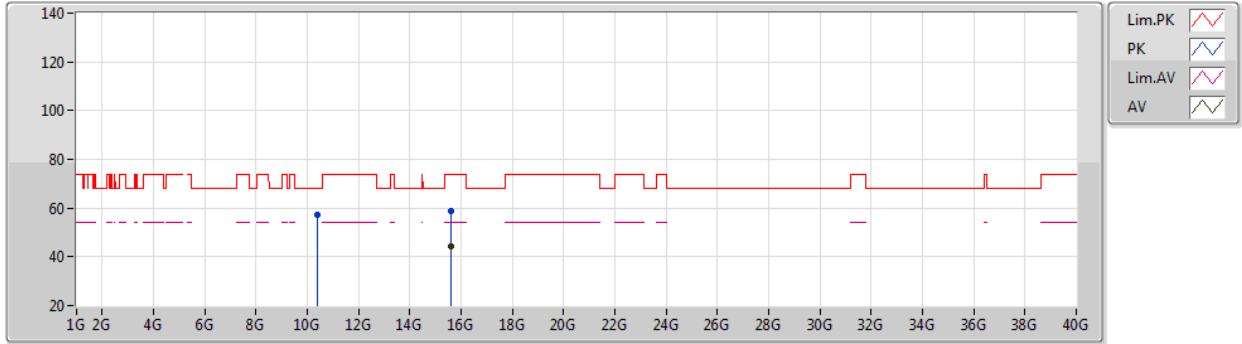

EUT Z_1TX
Setting 2
01-C-5-7
EW21S-A5

Type	Freq (Hz)	Level (dBuV/m)	Limit (dBuV/m)	Margin (dB)	Raw (dBuV)	Dist (m)	Condition	Azimuth (°)	Height (m)	Comment	AF (dB)	CL (dB)	PA (dB)
PK	10.40232G	57.09	68.20	-11.11	45.28	3	Vertical	193	2.97	-	38.22	8.92	35.33
PK	15.60238G	58.57	74.00	-15.43	44.92	3	Vertical	116	2.69	-	38.72	9.78	34.85
AV	15.6019G	44.54	54.00	-9.46	30.89	3	Vertical	116	2.69	-	38.72	9.78	34.85

FSK_1TX

16/04/2020

5201MHz_TX

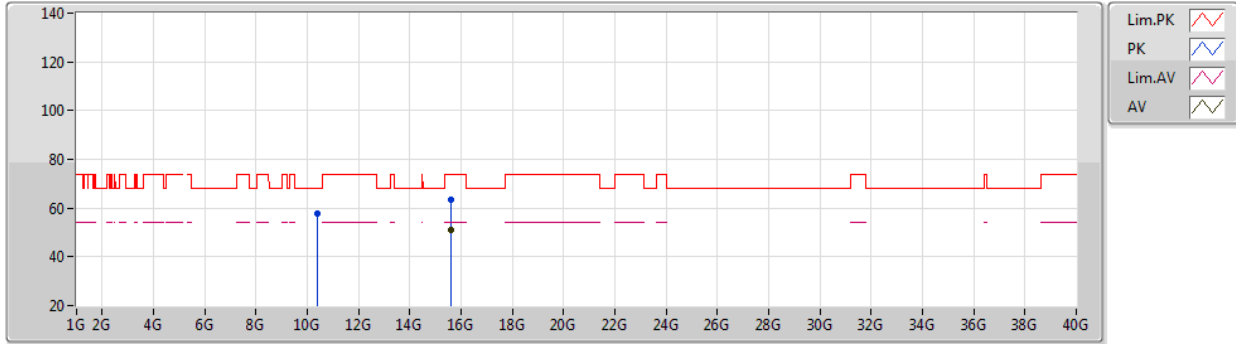

EUT Z_1TX
Setting 2
01-C-5-7
EW21S-A5

Type	Freq (Hz)	Level (dBuV/m)	Limit (dBuV/m)	Margin (dB)	Raw (dBuV)	Dist (m)	Condition	Azimuth (°)	Height (m)	Comment	AF (dB)	CL (dB)	PA (dB)
PK	10.40209G	57.54	68.20	-10.66	45.73	3	Horizontal	227	1.00	-	38.22	8.92	35.33
PK	15.60318G	63.58	74.00	-10.42	49.93	3	Horizontal	277	2.91	-	38.72	9.78	34.85
AV	15.60284G	50.90	54.00	-3.10	37.25	3	Horizontal	277	2.91	-	38.72	9.78	34.85

FSK_1TX

16/04/2020

5243MHz_TX

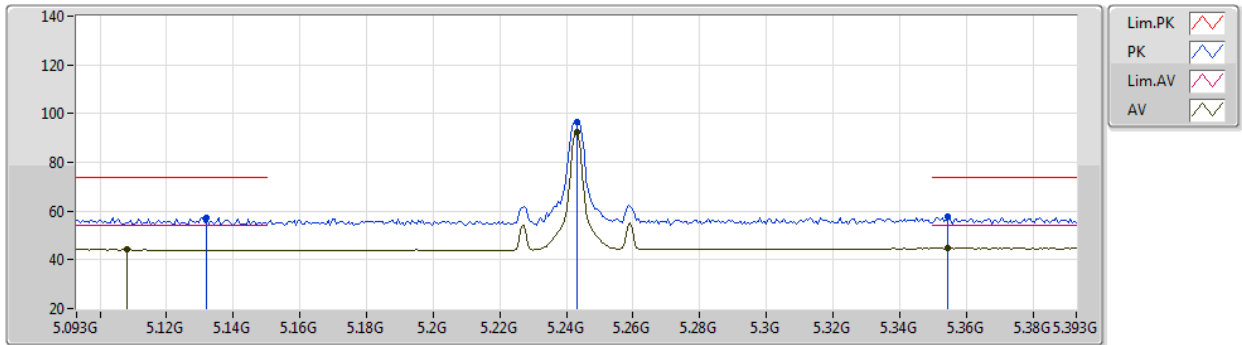

EUT Z_1TX
Setting 2
01-C-5-7 -10
EW21S-A5

Type	Freq (Hz)	Level (dBuV/m)	Limit (dBuV/m)	Margin (dB)	Raw (dBuV)	Dist (m)	Condition	Azimuth (°)	Height (m)	Comment	AF (dB)	CL (dB)	PA (dB)
PK	5.132G	57.21	74.00	-16.79	53.17	3	Vertical	177	1.62	-	32.80	5.87	34.63
AV	5.108G	44.25	54.00	-9.75	40.22	3	Vertical	177	1.62	-	32.80	5.85	34.62
PK	5.243G	96.65	Inf	-Inf	92.37	3	Vertical	177	1.62	-	32.93	6.02	34.67
AV	5.243G	92.21	Inf	-Inf	87.93	3	Vertical	177	1.62	-	32.93	6.02	34.67
PK	5.3546G	57.85	74.00	-16.15	53.11	3	Vertical	177	1.62	-	33.15	6.30	34.71
AV	5.3546G	44.73	54.00	-9.27	39.99	3	Vertical	177	1.62	-	33.15	6.30	34.71

FSK_1TX
5243MHz_TX

16/04/2020

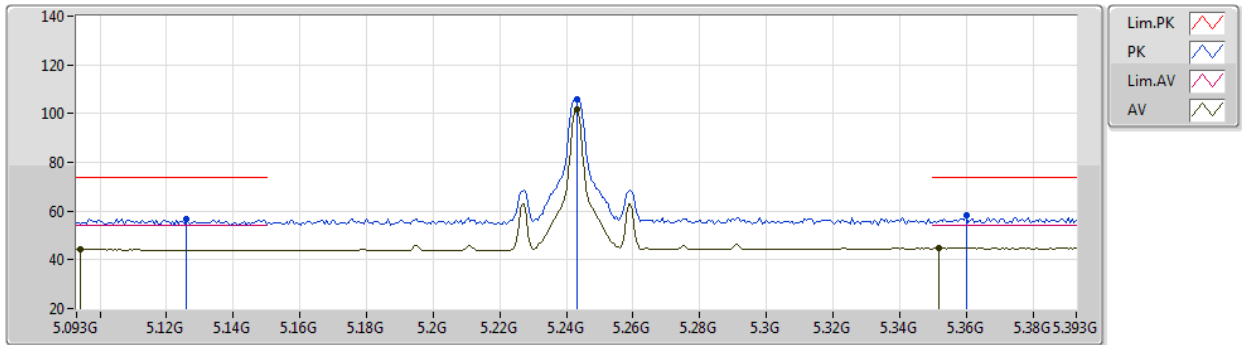

EUT Z_1TX
Setting 2
01-C-5-7 -10
EW21S-A5

Type	Freq (Hz)	Level (dBuV/m)	Limit (dBuV/m)	Margin (dB)	Raw (dBuV)	Dist (m)	Condition	Azimuth (°)	Height (m)	Comment	AF (dB)	CL (dB)	PA (dB)
PK	5.126G	56.85	74.00	-17.15	52.82	3	Horizontal	115	1.06	-	32.80	5.86	34.63
AV	5.0942G	44.23	54.00	-9.77	40.19	3	Horizontal	115	1.06	-	32.81	5.85	34.62
PK	5.243G	106.09	Inf	-Inf	101.81	3	Horizontal	115	1.06	-	32.93	6.02	34.67
AV	5.243G	101.71	Inf	-Inf	97.43	3	Horizontal	115	1.06	-	32.93	6.02	34.67
PK	5.36G	58.04	74.00	-15.96	53.28	3	Horizontal	115	1.06	-	33.16	6.31	34.71
AV	5.3516G	44.78	54.00	-9.22	40.05	3	Horizontal	115	1.06	-	33.15	6.29	34.71

FSK_1TX

16/04/2020

5243MHz_TX

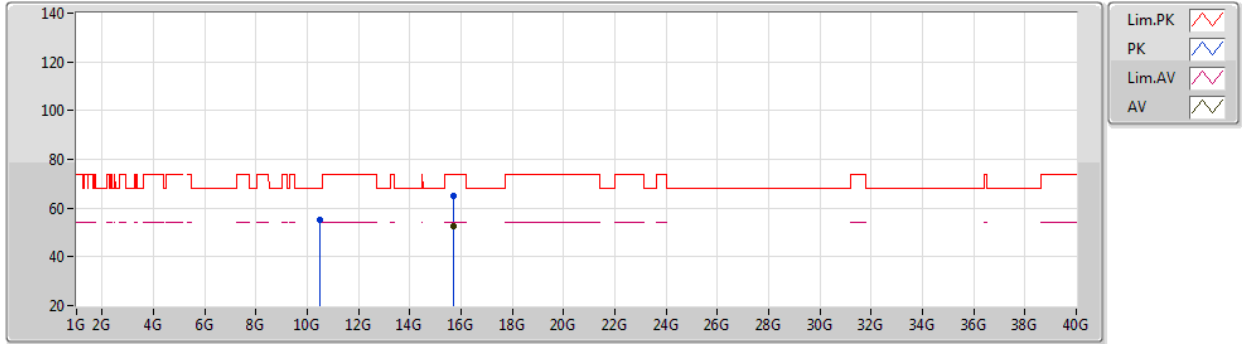

EUT Z_1TX
Setting 2
01-C-5-7
EW21S-A5

Type	Freq (Hz)	Level (dBuV/m)	Limit (dBuV/m)	Margin (dB)	Raw (dBuV)	Dist (m)	Condition	Azimuth (°)	Height (m)	Comment	AF (dB)	CL (dB)	PA (dB)
PK	10.48763G	55.29	68.20	-12.91	43.36	3	Vertical	159	2.38	-	38.25	8.95	35.27
PK	15.72858G	64.81	74.00	-9.19	51.43	3	Vertical	272	2.89	-	38.62	9.75	34.99
AV	15.72856G	52.80	54.00	-1.20	39.42	3	Vertical	272	2.89	-	38.62	9.75	34.99

FSK_1TX

16/04/2020

5243MHz_TX

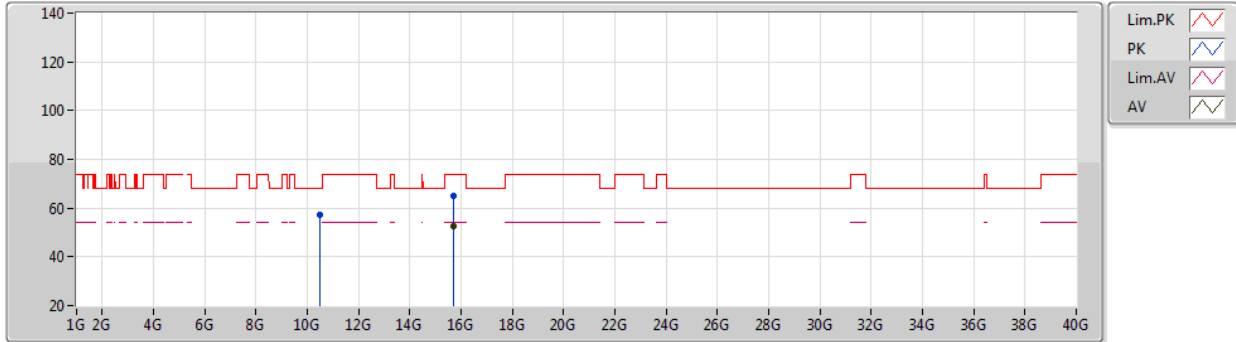

EUT Z_1TX
Setting 2
01-C-5-7
EW21S-A5

Type	Freq (Hz)	Level (dBuV/m)	Limit (dBuV/m)	Margin (dB)	Raw (dBuV)	Dist (m)	Condition	Azimuth (°)	Height (m)	Comment	AF (dB)	CL (dB)	PA (dB)
PK	10.48661G	57.07	68.20	-11.13	45.14	3	Horizontal	161	2.91	-	38.25	8.95	35.27
PK	15.72864G	64.98	74.00	-9.02	51.60	3	Horizontal	275	2.94	-	38.62	9.75	34.99
AV	15.72864G	52.74	54.00	-1.26	39.36	3	Horizontal	275	2.94	-	38.62	9.75	34.99

FSK_1TX

16/04/2020

5726MHz_TX

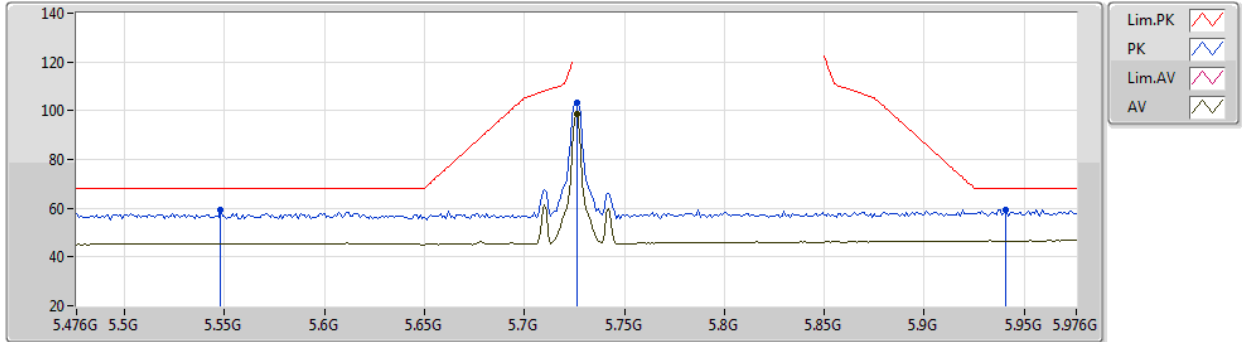

EUT Z_1TX
Setting 1
01-C-S-7 -10
EW21S-A5

Type	Freq (Hz)	Level (dBuV/m)	Limit (dBuV/m)	Margin (dB)	Raw (dBuV)	Dist (m)	Condition	Azimuth (°)	Height (m)	Comment	AF (dB)	CL (dB)	PA (dB)
PK	5.548G	59.08	68.20	-9.12	53.59	3	Vertical	233	2.88	-	33.90	6.33	34.74
PK	5.726G	103.48	Inf	-Inf	97.71	3	Vertical	233	2.88	-	34.08	6.36	34.67
AV	5.726G	98.39	Inf	-Inf	92.62	3	Vertical	233	2.88	-	34.08	6.36	34.67
PK	5.941G	59.51	68.20	-8.69	52.63	3	Vertical	233	2.88	-	35.00	6.47	34.59

FSK_1TX
5726MHz_TX

16/04/2020

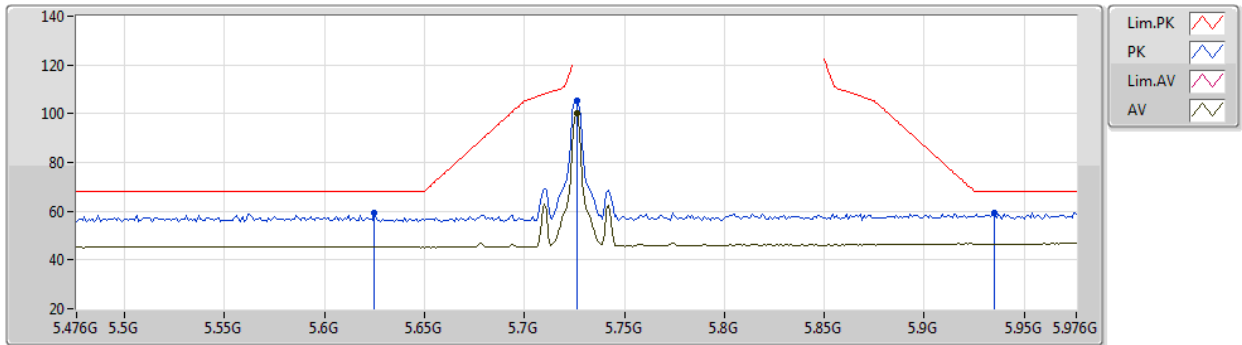

EUT Z_1TX
Setting 1
01-C-S-7 -10
EW21S-A5

Type	Freq (Hz)	Level (dBuV/m)	Limit (dBuV/m)	Margin (dB)	Raw (dBuV)	Dist (m)	Condition	Azimuth (°)	Height (m)	Comment	AF (dB)	CL (dB)	PA (dB)
PK	5.625G	59.23	68.20	-8.97	53.63	3	Horizontal	95	1.05	-	34.00	6.31	34.71
PK	5.726G	105.23	Inf	-Inf	99.46	3	Horizontal	95	1.05	-	34.08	6.36	34.67
AV	5.726G	100.20	Inf	-Inf	94.43	3	Horizontal	95	1.05	-	34.08	6.36	34.67
PK	5.935G	59.47	68.20	-8.73	52.63	3	Horizontal	95	1.05	-	34.97	6.47	34.60

FSK_1TX
5726MHz_TX

16/04/2020

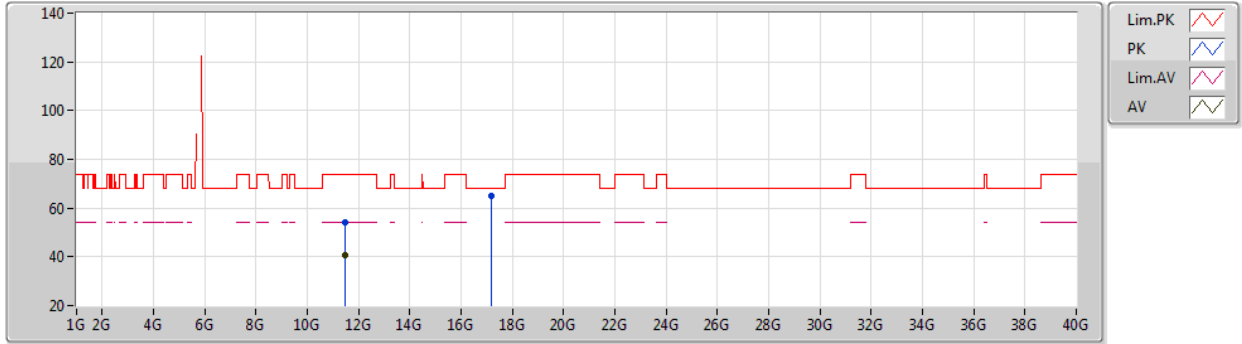

EUT Z_1TX
Setting 1
01-C-S-7
EW21S-A5

Type	Freq (Hz)	Level (dBuV/m)	Limit (dBuV/m)	Margin (dB)	Raw (dBuV)	Dist (m)	Condition	Azimuth (°)	Height (m)	Comment	AF (dB)	CL (dB)	PA (dB)
PK	11.45345G	54.38	74.00	-19.62	41.61	3	Vertical	278	1.11	-	38.45	9.24	34.92
AV	11.4512G	40.55	54.00	-13.45	27.78	3	Vertical	278	1.11	-	38.45	9.24	34.92
PK	17.17932G	64.86	68.20	-3.34	46.87	3	Vertical	138	1.17	-	41.47	10.24	33.72

FSK_1TX
5726MHz_TX

16/04/2020

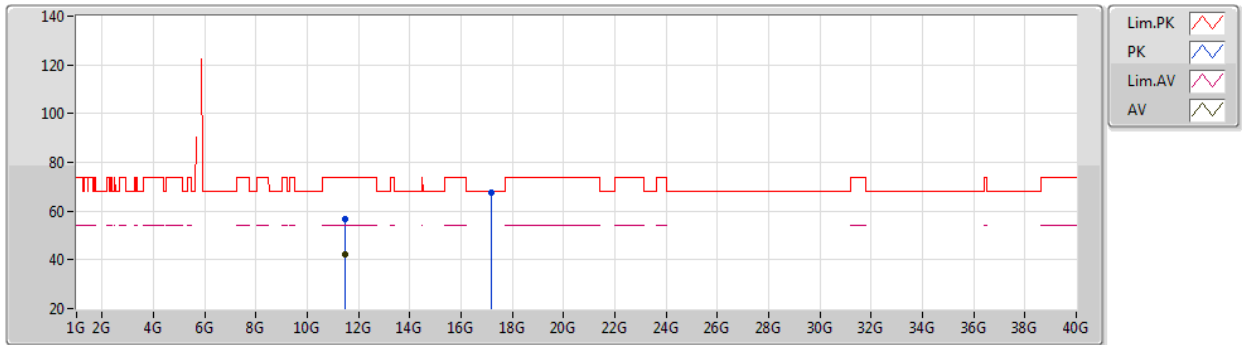

EUT Z_1TX
Setting 1
01-C-S-7
EW21S-A5

Type	Freq (Hz)	Level (dBuV/m)	Limit (dBuV/m)	Margin (dB)	Raw (dBuV)	Dist (m)	Condition	Azimuth (°)	Height (m)	Comment	AF (dB)	CL (dB)	PA (dB)
PK	11.45121G	56.64	74.00	-17.36	43.87	3	Horizontal	269	1.23	-	38.45	9.24	34.92
AV	11.45179G	42.30	54.00	-11.70	29.53	3	Horizontal	269	1.23	-	38.45	9.24	34.92
PK	17.17766G	67.76	68.20	-0.44	49.77	3	Horizontal	121	2.82	-	41.47	10.24	33.72

FSK_1TX

16/04/2020

5786MHz_TX

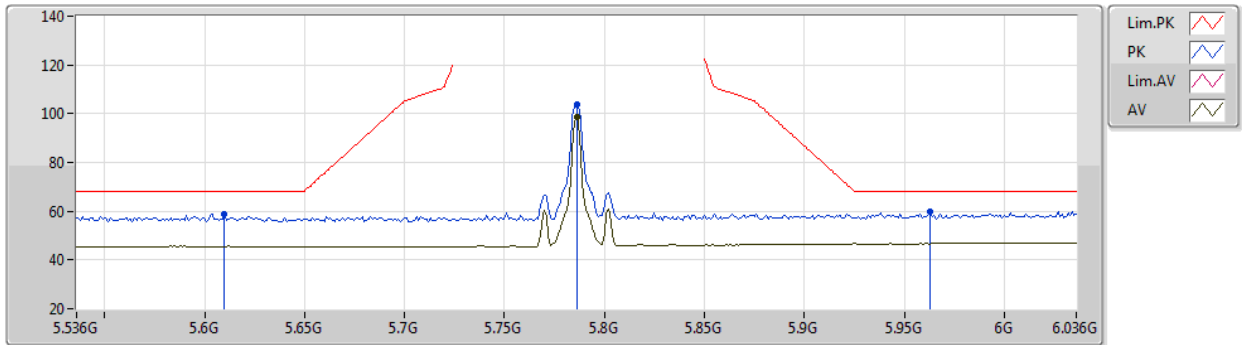

EUT Z_1TX
Setting 1
01-C-5-7 -10
EW21S-A5

Type	Freq (Hz)	Level (dBuV/m)	Limit (dBuV/m)	Margin (dB)	Raw (dBuV)	Dist (m)	Condition	Azimuth (°)	Height (m)	Comment	AF (dB)	CL (dB)	PA (dB)
PK	5.61G	58.67	68.20	-9.53	53.09	3	Vertical	233	2.80	-	34.00	6.30	34.72
PK	5.786G	103.77	Inf	-Inf	97.77	3	Vertical	233	2.80	-	34.26	6.39	34.65
AV	5.786G	98.39	Inf	-Inf	92.39	3	Vertical	233	2.80	-	34.26	6.39	34.65
PK	5.963G	59.69	68.20	-8.51	52.68	3	Vertical	233	2.80	-	35.11	6.48	34.58

FSK_1TX
5786MHz_TX

16/04/2020

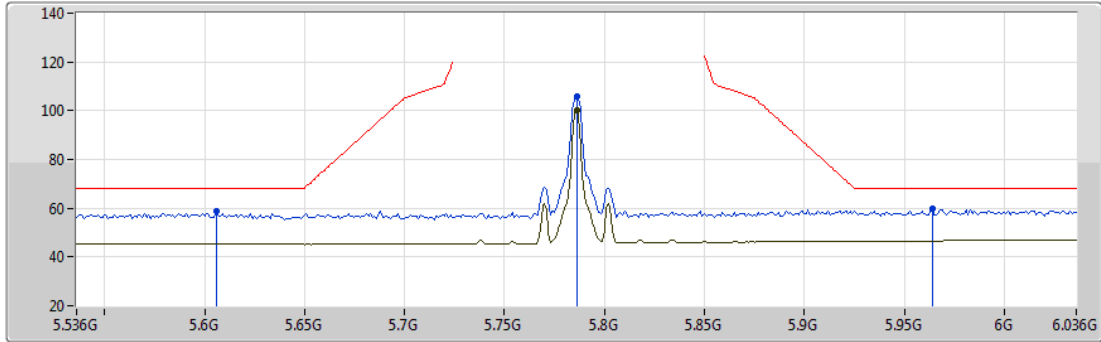

EUT Z_1TX
Setting 1
01-C-S-7 -10
EW21S-A5

Type	Freq (Hz)	Level (dBuV/m)	Limit (dBuV/m)	Margin (dB)	Raw (dBuV)	Dist (m)	Condition	Azimuth (°)	Height (m)	Comment	AF (dB)	CL (dB)	PA (dB)
PK	5.606G	58.62	68.20	-9.58	53.04	3	Horizontal	97	1.00	-	34.00	6.30	34.72
PK	5.786G	105.72	Inf	-Inf	99.72	3	Horizontal	97	1.00	-	34.26	6.39	34.65
AV	5.786G	100.23	Inf	-Inf	94.23	3	Horizontal	97	1.00	-	34.26	6.39	34.65
PK	5.964G	59.57	68.20	-8.63	52.55	3	Horizontal	97	1.00	-	35.12	6.48	34.58

FSK_1TX
5786MHz_TX

16/04/2020

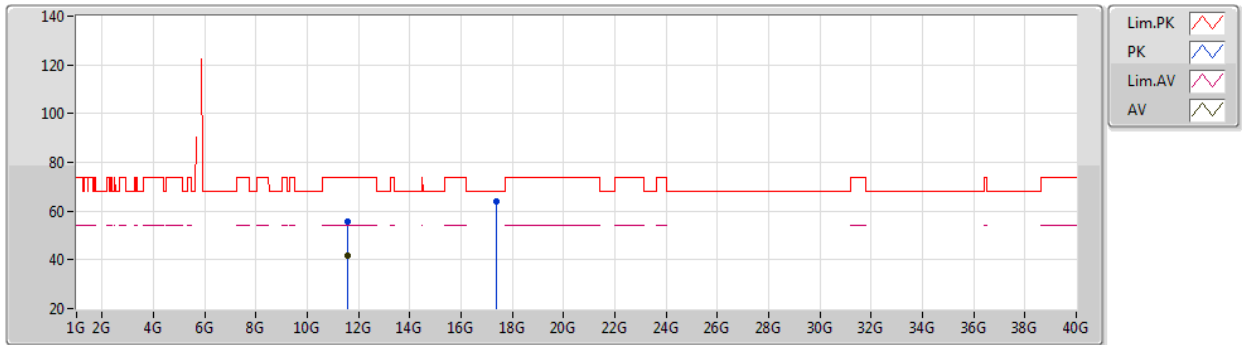

EUT Z_1TX
Setting 1
01-C-5-7
EW21S-A5

Type	Freq (Hz)	Level (dBuV/m)	Limit (dBuV/m)	Margin (dB)	Raw (dBuV)	Dist (m)	Condition	Azimuth (°)	Height (m)	Comment	AF (dB)	CL (dB)	PA (dB)
PK	11.57016G	55.51	74.00	-18.49	42.71	3	Vertical	218	2.99	-	38.46	9.28	34.94
AV	11.57212G	41.60	54.00	-12.40	28.80	3	Vertical	218	2.99	-	38.46	9.28	34.94
PK	17.3598G	64.22	68.20	-3.98	45.91	3	Vertical	297	1.08	-	41.74	10.32	33.75

FSK_1TX
5786MHz_TX

16/04/2020

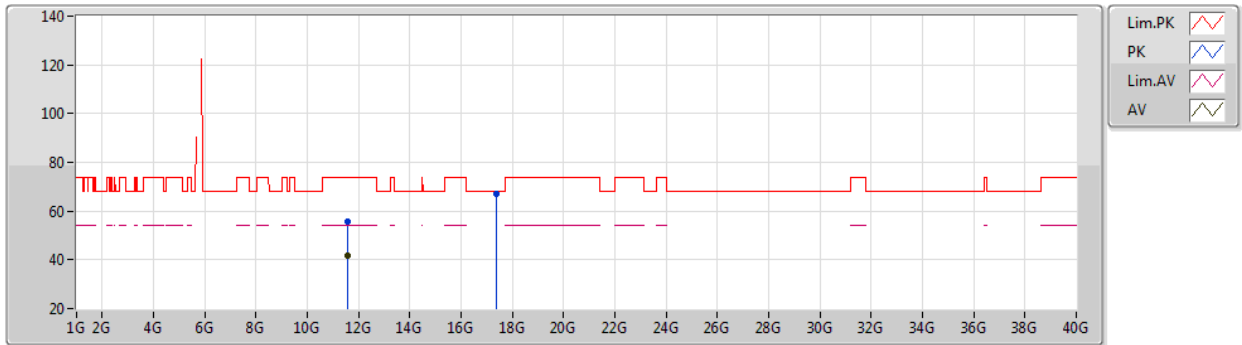





EUT Z_1TX
Setting 1
01-C-5-7
EW21S-A5

Type	Freq (Hz)	Level (dBuV/m)	Limit (dBuV/m)	Margin (dB)	Raw (dBuV)	Dist (m)	Condition	Azimuth (°)	Height (m)	Comment	AF (dB)	CL (dB)	PA (dB)
PK	11.57199G	55.58	74.00	-18.42	42.78	3	Horizontal	268	1.80	-	38.46	9.28	34.94
AV	11.57219G	41.67	54.00	-12.33	28.87	3	Horizontal	268	1.80	-	38.46	9.28	34.94
PK	17.35714G	66.96	68.20	-1.24	48.65	3	Horizontal	127	2.79	-	41.74	10.32	33.75

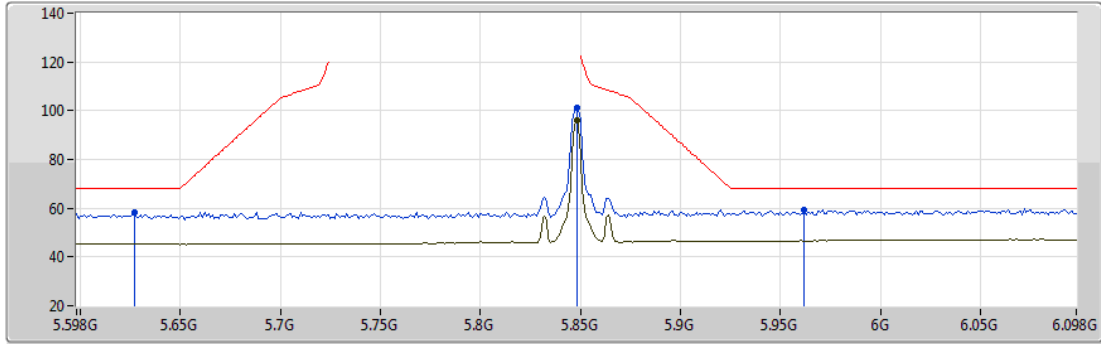
FSK_1TX
5848MHz_TX

16/04/2020



Lim.PK 
 PK 
 Lim.AV 
 AV 

EUT Z_1TX
Setting 0
01-C-S-7 -10
EW21S-A5

Type	Freq (Hz)	Level (dBuV/m)	Limit (dBuV/m)	Margin (dB)	Raw (dBuV)	Dist (m)	Condition	Azimuth (°)	Height (m)	Comment	AF (dB)	CL (dB)	PA (dB)
PK	5.627G	58.42	68.20	-9.78	52.82	3	Vertical	163	2.50	-	34.00	6.31	34.71
PK	5.848G	100.96	Inf	-Inf	94.63	3	Vertical	163	2.50	-	34.54	6.42	34.63
AV	5.848G	95.78	Inf	-Inf	89.45	3	Vertical	163	2.50	-	34.54	6.42	34.63
PK	5.962G	59.52	68.20	-8.68	52.52	3	Vertical	163	2.50	-	35.11	6.48	34.59

FSK_1TX

16/04/2020

5848MHz_TX

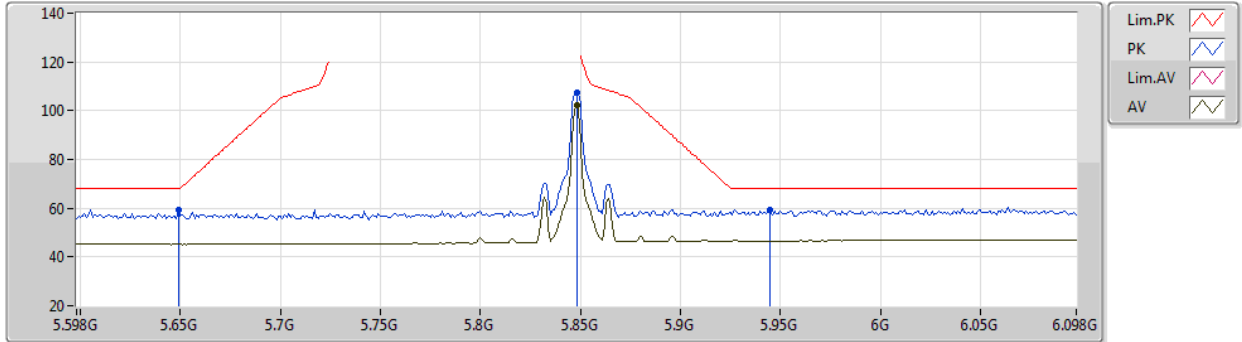

EUT Z_1TX
Setting 0
01-C-S-7 -10
EW21S-A5

Type	Freq (Hz)	Level (dBuV/m)	Limit (dBuV/m)	Margin (dB)	Raw (dBuV)	Dist (m)	Condition	Azimuth (°)	Height (m)	Comment	AF (dB)	CL (dB)	PA (dB)
PK	5.649G	59.44	68.20	-8.76	53.82	3	Horizontal	88	1.05	-	34.00	6.32	34.70
PK	5.848G	107.51	Inf	-Inf	101.18	3	Horizontal	88	1.05	-	34.54	6.42	34.63
AV	5.848G	102.23	Inf	-Inf	95.90	3	Horizontal	88	1.05	-	34.54	6.42	34.63
PK	5.945G	59.53	68.20	-8.67	52.63	3	Horizontal	88	1.05	-	35.02	6.47	34.59

FSK_1TX
5848MHz_TX

16/04/2020

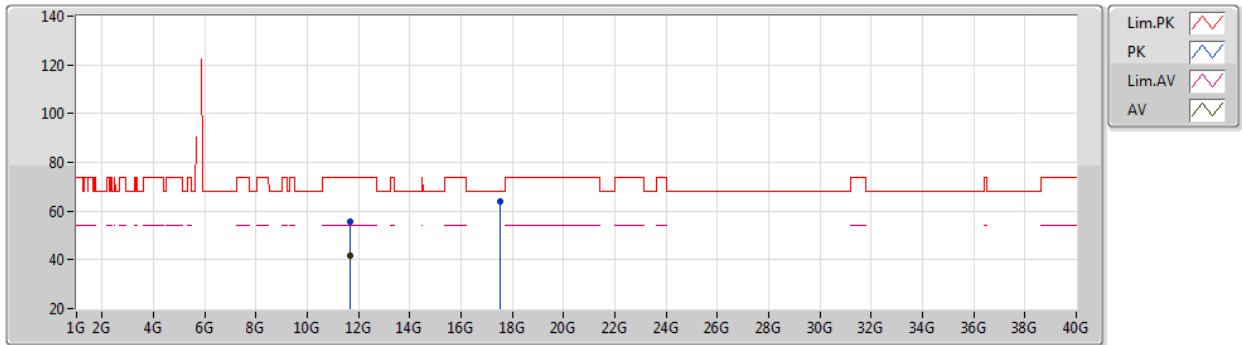

EUT Z_1TX
Setting 0
01-C-S-7
EW21S-A5

Type	Freq (Hz)	Level (dBuV/m)	Limit (dBuV/m)	Margin (dB)	Raw (dBuV)	Dist (m)	Condition	Azimuth (°)	Height (m)	Comment	AF (dB)	CL (dB)	PA (dB)
PK	11.69635G	55.75	74.00	-18.25	42.93	3	Vertical	154	2.81	-	38.47	9.31	34.96
AV	11.69562G	41.90	54.00	-12.10	29.08	3	Vertical	154	2.81	-	38.47	9.31	34.96
PK	17.54328G	64.21	68.20	-3.99	45.58	3	Vertical	298	1.00	-	42.01	10.40	33.78

FSK_1TX
5848MHz_TX

16/04/2020

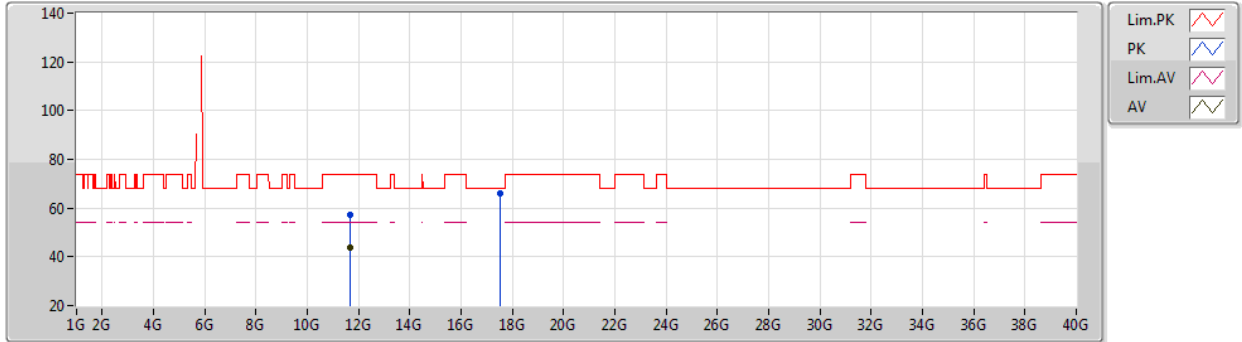

EUT Z_1TX
Setting 0
01-C-S-7
EW21S-A5

Type	Freq (Hz)	Level (dBuV/m)	Limit (dBuV/m)	Margin (dB)	Raw (dBuV)	Dist (m)	Condition	Azimuth (°)	Height (m)	Comment	AF (dB)	CL (dB)	PA (dB)
PK	11.69602G	57.28	74.00	-16.72	44.46	3	Horizontal	268	1.31	-	38.47	9.31	34.96
AV	11.69588G	43.79	54.00	-10.21	30.97	3	Horizontal	268	1.31	-	38.47	9.31	34.96
PK	17.54282G	66.13	68.20	-2.07	47.50	3	Horizontal	92	2.67	-	42.01	10.40	33.78