

Designated by Ministry of international Trade and industry

KANSAI ELECTRONIC INDUSTRY DEVELOPMENT CENTER

HEAD OFFICE
6-8-7 NISHITENMA
KITA-KU OSAKA 530-0047 JAPAN



IKOMA TESTING LABORATORY
12128 TAKAYAMA-CHO
IKOMA-CITY NARA 630-0101 JAPAN

Corporate Juridical Person

TEST REPORTReport No.A-030-01-C

Date: 26 July 2002

This test report is to certify that the tested device properly complies with the requirements of:

FCC Rules and Regulations Part 95 : Radio Control (R/C) Radio Service.

The tests necessary to show compliance to the requirements were performed and these results met the specifications of requirement. The results of this report should not be construed to imply compliance of equipment other than that, which was tested. Unless the laboratory permission, this report should not be copied in part.

1. Applicant

Company Name : JAPAN REMOTE CONTROL CO., LTD.

Mailing Address : 2-2-12, EIWA, HIGASHIOSAKA-CITY, OSAKA, 577-0809 JAPAN

2. Identification of Tested Device

Type of Device : Radio Control (R/C) Radio Service.
 Kind of Equipment Authorization : : DoC : Certification : Verification
 FCC ID : BRWX378
 Device Name : FM 7 - CHANNEL TRANSMITTER
 Trade Name : JR PROPO
 Model Number : X378
 Serial Number : No.1 : Prototype : Pre-production : Production
 Date of Manufacture : October 2001

3. Test Items and Procedure

: RF Power Output (Substitution Method)
: Modulation Characteristics
: Necessary Bandwidth
: Emission Bandwidth
: Field Strength of Spurious Radiation
: Frequency Stability Measurement

Above all tests were performed under: FCC Part 2 Sec2.1046, Sec2..1047, Sec2.1049, Sec2.1053, Sec2.1055 and Sec2.1057.

: without deviation, : with deviation(details are found inside of this report)

4. Date of Test

Receipt of Test Sample : 30 October 2001
 Test Completed on : 29 April 2002

Eizo Hariya
Associate Director of Ikoma Testing Laboratory

Table of Contents

1. GENERAL INFORMATION	3
1.1 Product Description	3
1.2 Description for Equipment Authorization	3
1.3 Test Facility	3
2. TESTED SYSTEM	4
2.1 Test Mode	4
2.2 Block Diagram of EUT System	4
2.3 List of EUT System.....	5
2.4 List of Antenna	5
3. RF OUTPUT POWER AND RADIATED SPURIOUS EMISSIONS	6
3.1 Reference Rule and Specification.....	6
3.2 Test Procedure	6
3.3 Test Configuration	7
3.4 Photographs of EUT System Configuration	9
3.5 Test Results.....	11
4. MODULATION CHARACTERISTICS.....	12
4.1 Reference Rule and Specification.....	12
4.2 Test Results.....	12
5. EMISSION BANDWIDTH.....	14
5.1 Reference Rule and Specification.....	14
5.2 Test Configuration	14
5.3 Test Results.....	15
6. FREQUENCY STABILITY MEASUREMENT	20
6.1 Reference Rule and Specification.....	20
6.2 Frequency vs Temperature Test	20
6.3 Frequency vs Voltage Test	21
7. USED TEST EQUIPMENTS AND CALIBRATION STATUS.....	22

1. GENERAL INFORMATION

1.1 Product Description

The JR PROPO Model No. X378 (referred to as EUT in this report) is the FM 7 - CHANNEL TRANSMITTER.

- (1) Transmitting Frequency : 72.01 ~ 72.99 MHz (72.550 MHz in EUT)
- (2) Contained Oscillator : 4th OVER-TONE
- (3) Rated Power Supply : DC 9.6 V (Ni-cd battery × 8)

1.2 Description for Equipment Authorization

- (1) Rules Part(s) under which Equipment operated

FCC Rule Part 95 ; Radio Control(R/C) Radio Service

- (2) Kind of Equipment Authorization

Certification Verification

- (3) Procedure of Application

Original Equipment Modification

1.3 Test Facility

Name : KANSAI ELECTRONIC INDUSTRY DEVELOPMENT CENTER (KEC)
IKOMA TESTING LABORATORY
Anechoic Chamber No.3

Address : 12128, Takayama-cho Ikoma-city, Nara, 630-0101 Japan

This test facility has been filed in FCC under the criteria in ANSI C63.4-1992.
The laboratory has been accredited by the NVLAP(Lab.Code:200207-0) based on ISO17025.

2. TESTED SYSTEM

2.1 Test Mode

The compliance tests were performed under the following operation mode.

(1) Measurement of Field Strength of Spurious Radiation :

The EUT was continuously transmitted in modulation mode.

(2) Frequency Stability Measurement :

The EUT was continuously transmitted in non-modulation mode.

(3) Except above two test items :

See the page of each test items.

2.2 Block Diagram of EUT System

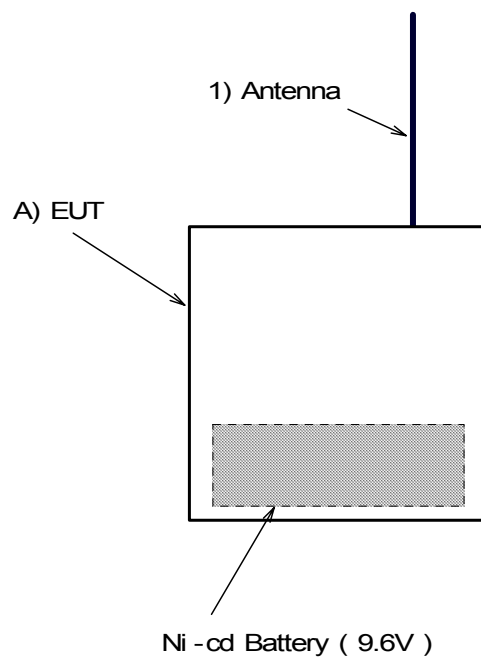

[Note]

See 2.3 List of EUT System and 2.4 List of Antenna.

2.3 List of EUT System

No	Device Name	Model Number (Serial Number)	FCC ID (Trade Name)	Note	Remark
A	FM 7 - CHANNEL TRANSMITTER	X378 (No.1)	BRWX378 (JR PROPO)		(1)

[Remark]

(1) : EUT

2.4 List of Antenna

No	Type	Length (m)	Note	Remark
1	Built-in Rod Antenna	1.05		(1)

[Remark]

(1) : Accessory of EUT

3. RF OUTPUT POWER AND RADIATED SPURIOUS EMISSIONS

3.1 Reference Rule and Specification

FCC Rule Part 95 [Section 95.635] and Part 2 Subpart J [Section 2.1053]

3.2 Test Procedure

- (1) Place the transmitter to be tested (EUT) on the turntable.
- (2) Measurements shall be made from the lowest radio frequency generated in the equipment to the tenth harmonic of the carrier.
- (3) For each spurious frequency, raise and lower the test antenna from 1m to 4m to obtain a maximum reading on the spectrum analyzer with the test antenna at horizontal polarity. Then the turntable should be rotated 360° to determine the maximum reading. Repeat this procedure to obtain the highest possible reading. Record this maximum reading.
- (4) Repeat step (3) for each spurious frequency with the test antenna polarized vertically.
- (5) Remove the transmitter and replace it with a substitution antenna (the antenna should be half-wavelength for each frequency involved). The center of the substitution antenna should be approximately at the same location as the center of the transmitter. At the lower frequencies, where the substitution antenna is very long, this will be impossible to achieve when the antenna is polarized vertically. In such case the lower end of the antenna should be 0.3m above the ground.
- (6) Feed the substitution antenna at the transmitter end with a signal generator connected to the antenna by means of a non-radiating cable. With the antennas at both ends horizontally polarized and with the signal generator tuned to a particular spurious frequency, raise and lower the test antenna to obtain a maximum reading at the spectrum analyzer. Adjust the level of the signal generator output until the previously recorded maximum reading for this set of conditions is obtained. This should be done carefully repeating the adjustment of the test antenna and generator output.
- (7) Repeat step (6) with both antennas vertically polarized for each spurious frequency.
- (8) Calculate power in dBm into a reference ideal half-wave dipole antenna by reducing the readings obtained in steps (6) and (7) by the power loss in the cable between the generator and the antenna and further corrected for the gain of the substitution antenna used relative to an ideal half-wave dipole antenna.
- (9) The levels record in step (8) are the absolute levels of radiated spurious emissions in dBm. The radiated spurious emissions in dB can be calculated by the following:

$$\text{Radiated spurious emissions (dB)} = 10 \log_{10} \left[\frac{\text{TX power in watts}}{0.001} \right] - \text{the levels in step (8)}$$

Note : It is permissible to use other antennas provided they can be referenced to a dipole.

3.3 Test Configuration

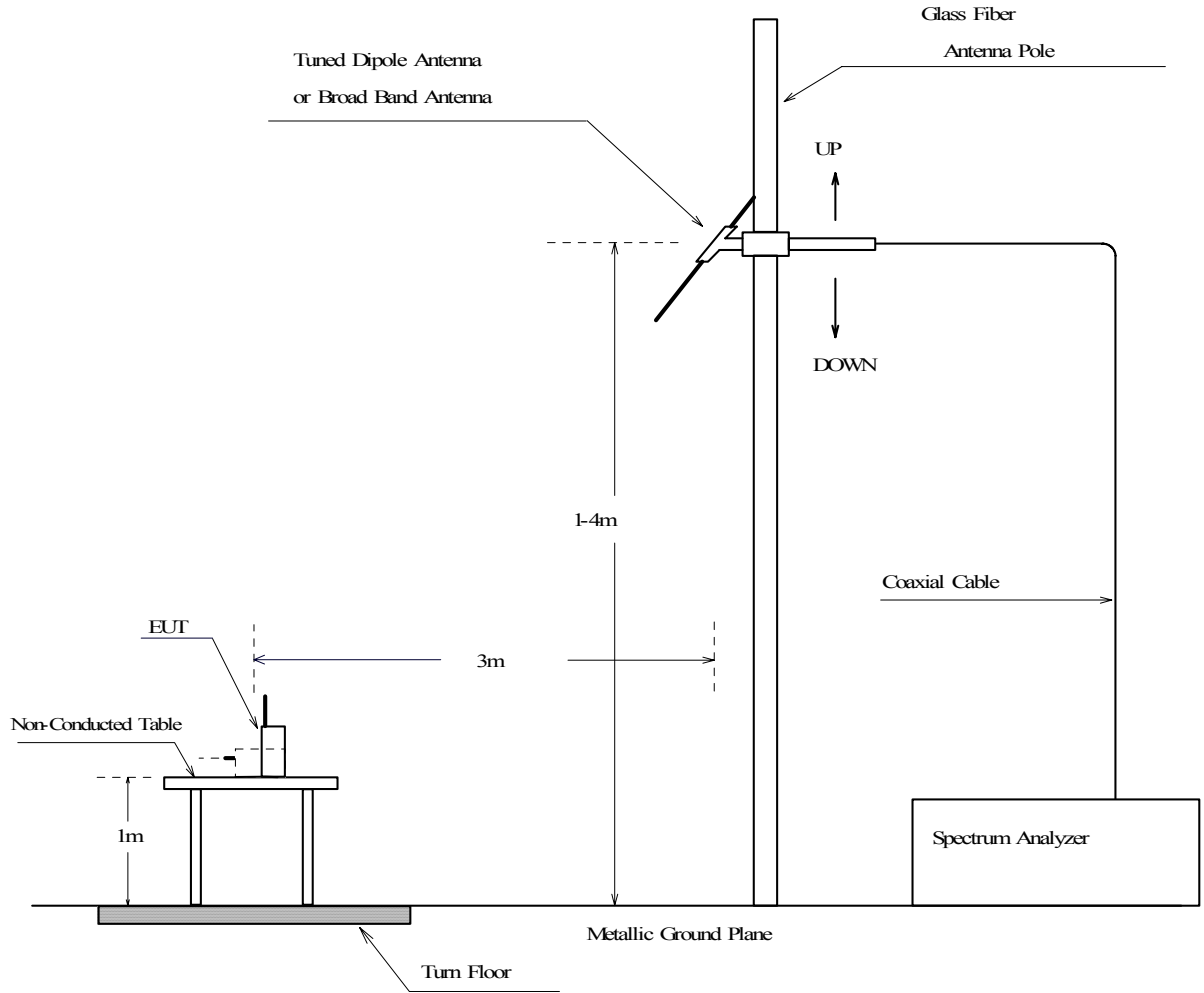

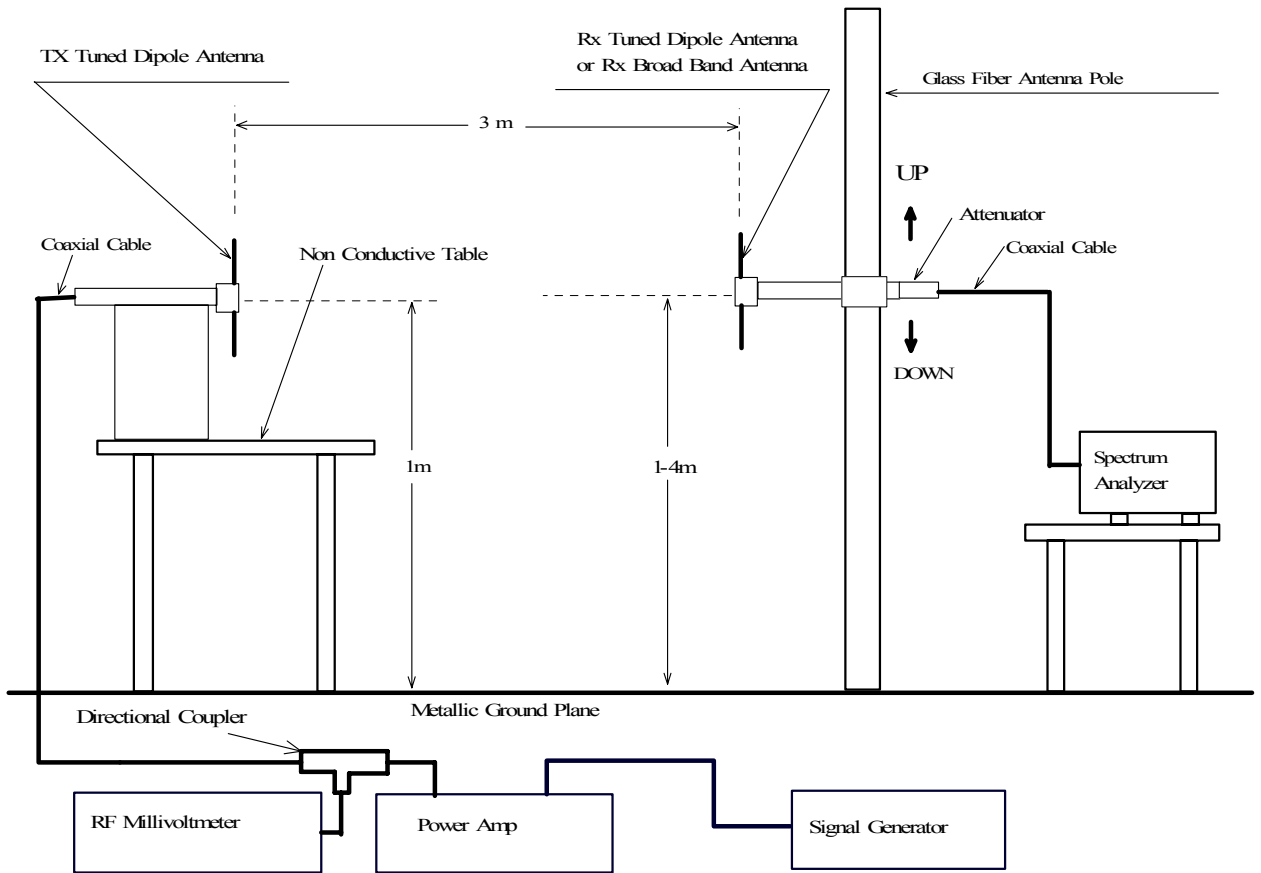

3.4 Photographs of EUT System Configuration

(1) EUT

Horizontal Placing

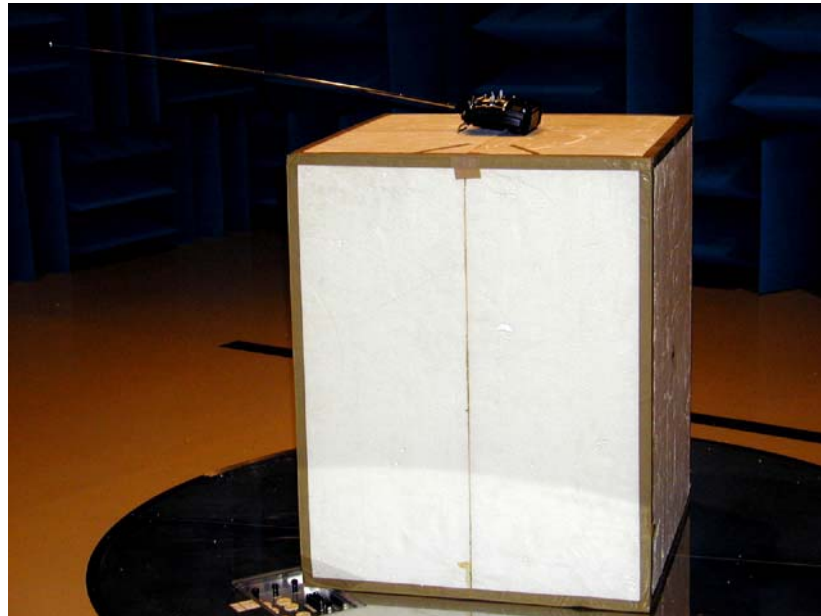

Vertical Placing



(2) Substitution Method

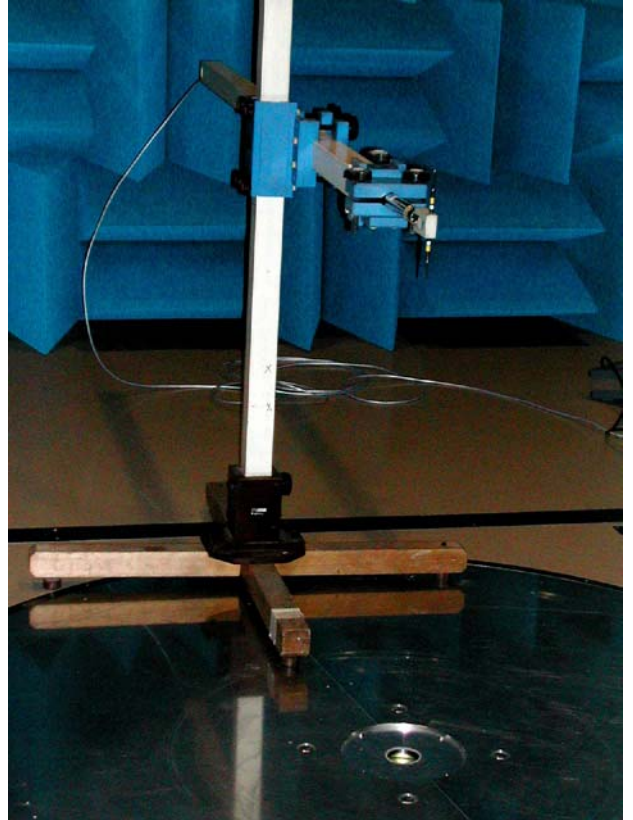
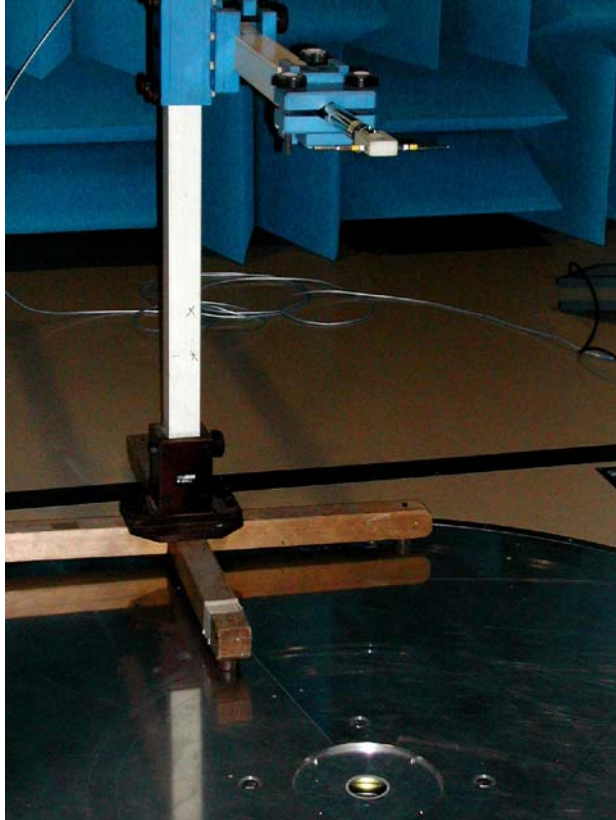

3.5 Test Results

Carrier Emission Frequency (MHz)	Spectrum Analyzer Reading		RF Meter Reading		Cable Loss (dB)	ERP (dBm)	RF Output Power (mW)	Limit (mW)
	Horizontal (dBuV)	Vertical (dBuV)	Horizontal (dBm)	Vertical (dBm)				
72.55	112.0	110.5	20.4	20.0	0.6	19.8	95.50	750.0

Spurious Emission Frequency (MHz)	Spectrum Analyzer Reading		RF Meter Reading		Cable Loss (dB)	ERP (dBm)	ERP (dBc)	Limit of ERP (dBc)	Margin (dB)
	Horizontal (dBuV)	Vertical (dBuV)	Horizontal (dBm)	Vertical (dBm)					
54.41	53.9	54.2	-31.5	-29.8	0.6	-30.4	-50.2	-45.8	4.4
90.69	45.6	42.9	-40.9	-43.8	0.7	-41.6	-61.4	-45.8	15.6
145.10	55.0	51.4	-28.2	-28.6	0.9	-29.1	-48.9	-45.8	3.1
217.65	48.3	41.8	-32.2	-35.5	0.9	-33.1	-52.9	-45.8	7.1
290.20	35.4	30.5	-41.3	-43.9	1.2	-42.5	-62.3	-45.8	16.5
435.30	35.7	31.8	-42.4	-45.7	1.5	-43.9	-63.7	-45.8	17.9
507.85	39.4	38.0	-38.2	-38.5	1.6	-39.8	-59.6	-45.8	13.8
580.40	39.7	33.7	-36.2	-38.6	1.7	-37.9	-57.7	-45.8	11.9
725.50	33.3	32.3	-39.5	-37.9	1.9	-39.8	-59.6	-45.8	13.8

[Note]

Limit of ERP in dBc:

$$-56 - 10\text{Log}(\text{Power}) = -56 - 10\text{Log}(0.09550) = -45.8\text{dB}$$

[Environment]

Temperature : 22°C Humidity : 34%

[Summary of Test Results]

Minimum Margin was 3.1 dB at 145.10 MHz, vertical polarization.

Tested Date : 29 April 2002

Tester Signature

Yasunari Kawai

4. MODULATION CHARACTERISTICS

4.1 Reference Rule and Specification

FCC Rule Part 2 Subpart J [Section 2.1047]

4.2 Test Results

Encoded Waveform

(1) Operation Mode of EUT

PPM Modulation

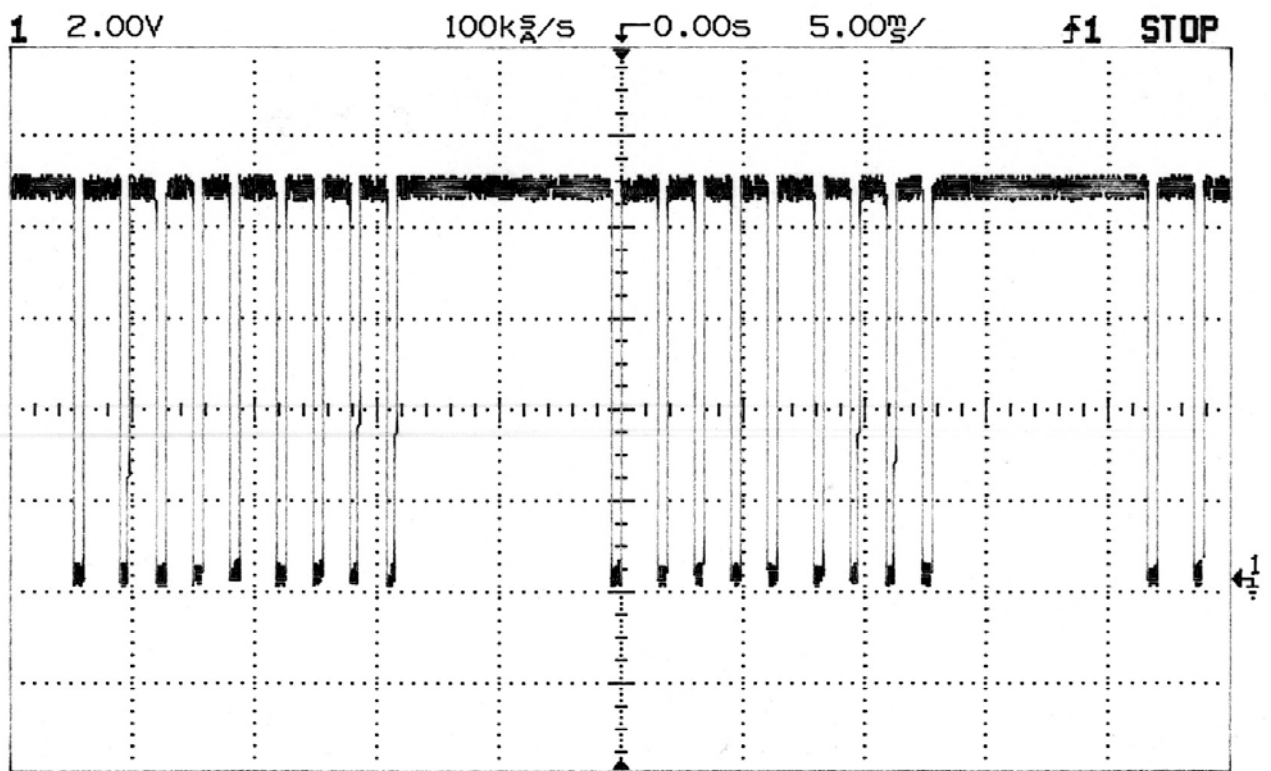

PCM Modulation

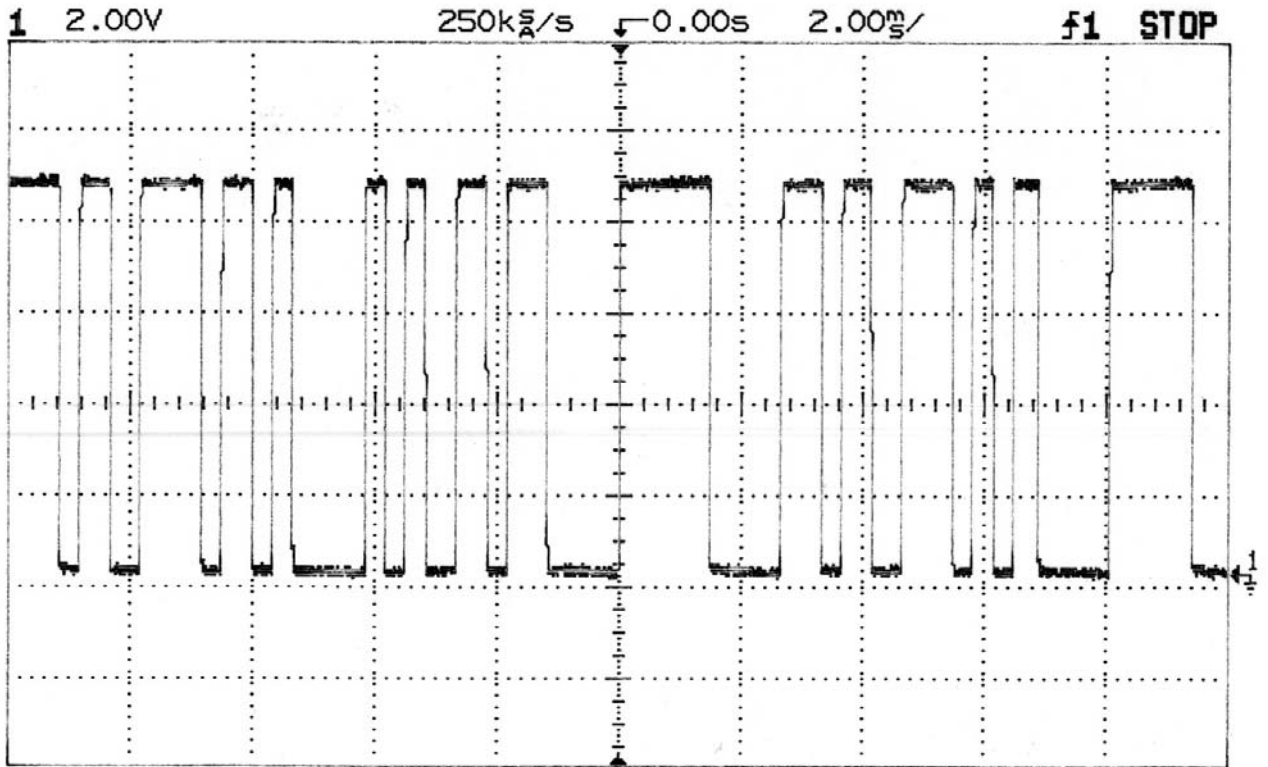

5. EMISSION BANDWIDTH

5.1 Reference Rule and Specification

FCC Rule Part 95 [Section95.633], [Section95.635] and Part 2 Subpart J [Section2.1049]

5.2 Test Configuration

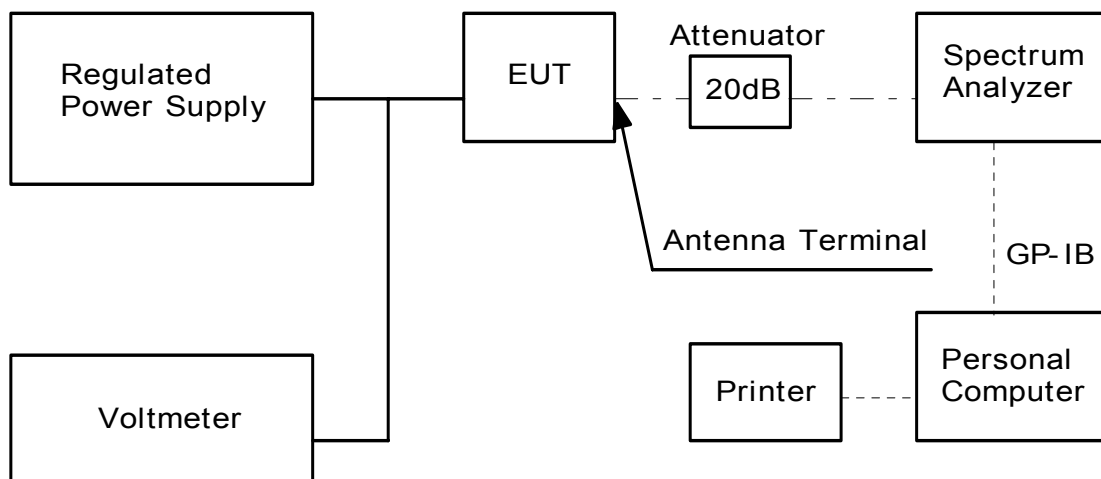

5.3 Test Results

See next figure (the picture of spectrum analyzer)

Occupied Bandwidth

I have measured the OBW by the spectrum analyzer R3261B which could measure 99% occupied bandwidth (OBW).

There are 701 data on horizontal axis of display.

One of them is V_n . Then total power P can be calculated from the following formula.

$$P = \sum_{n=1}^{701} \frac{V_n^2}{R} \quad \dots\dots\dots (1)$$

where, R is input impedance of R3261B.

Let, x is the point which gives 0.5% of the total power and y is the point which gives 99.5% of the total power. Then we can get the following formula.

$$0.005P = \sum_{n=1}^x \frac{V_n^2}{R} \quad \dots\dots\dots (2)$$

$$0.995P = \sum_{n=1}^y \frac{V_n^2}{R} \quad \dots\dots\dots (3)$$

From(1)- (3), OBW becomes .

$$OBW = \frac{Fspan(Y - X)}{1000}$$

where, F_{span} is frequency span of the spectrum analyzer.

Operation Mode of EUT

PPM modulation

EUT was operated the various positions of JOY STICK & OTHER SWITCHES.

(Reference level is the unmodulated level.)

Trace mode of Spectrum Analyzer : Maximum Hold

Ref Level	Start Frequency	Stop Frequency	Center Frequency	RBW	VBW
(dBm)	MHz	(MHz)	(MHz)	(kHz)	(kHz)
19.80	72.5	72.6	72.55	0.30	1000.00

M1/M2 Point	Level	Occupied Bandwith	Authorized Bandwith
(MHz)	(dBm)	(kHz)	(kHz)
72.54714	-0.8	5.72	8.00
72.55286	-0.2		

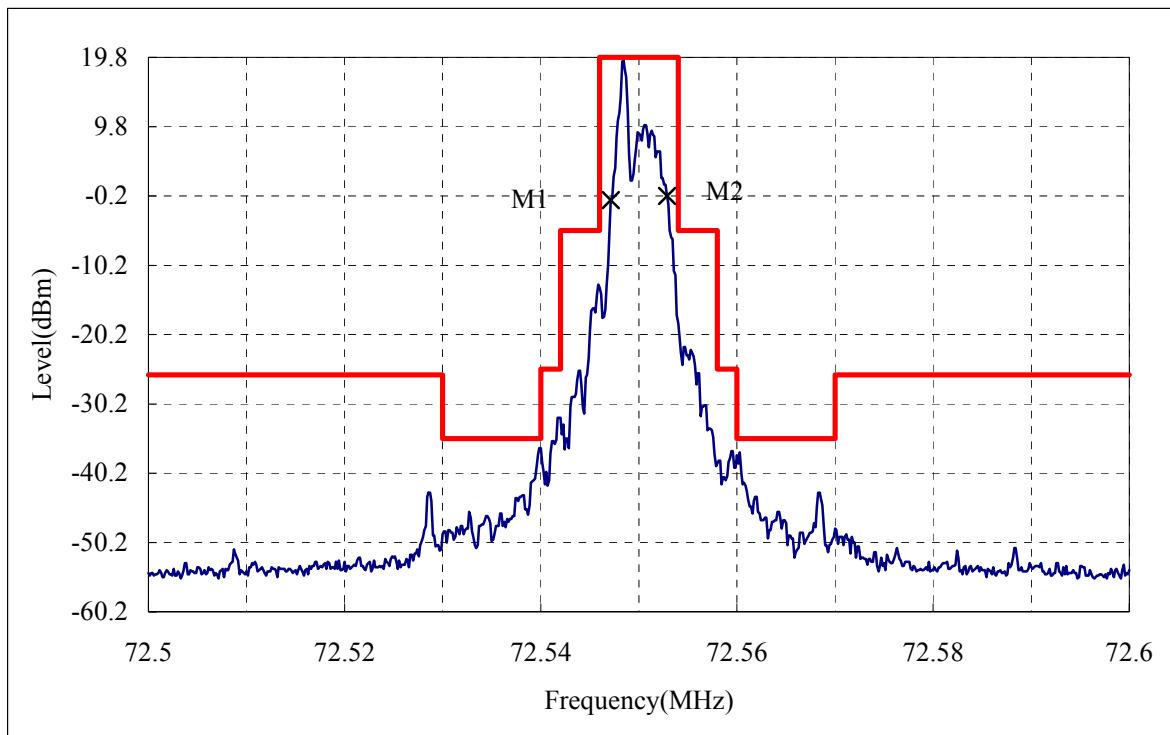

[Environment]

Temperature: 22°C

Humidity: 34%

[Summary of Test Results]

Above data shows that the test device complies with the requirements.

Tested Date : 29 November 2001

Tester Signature

Yasunari Kawai

Operation Mode of EUT

PCM modulation

EUT was operated the various positions of JOY STICK & OTHER SWITCHES.

(Reference level is the unmodulated level.)

Trace mode of Spectrum Analyzer : Maximum Hold

Ref Level	Start Frequency	Stop Frequency	Center Frequency	RBW	VBW
(dBm)	MHz	(MHz)	(MHz)	(kHz)	(kHz)
19.80	72.5	72.6	72.55	0.30	1000.00

M1/M2 Point	Level	Occupied Bandwith	Authorized Bandwith
(MHz)	(dBm)	(kHz)	(kHz)
72.54686	-0.2	6.14	8.00
72.55300	0.4		

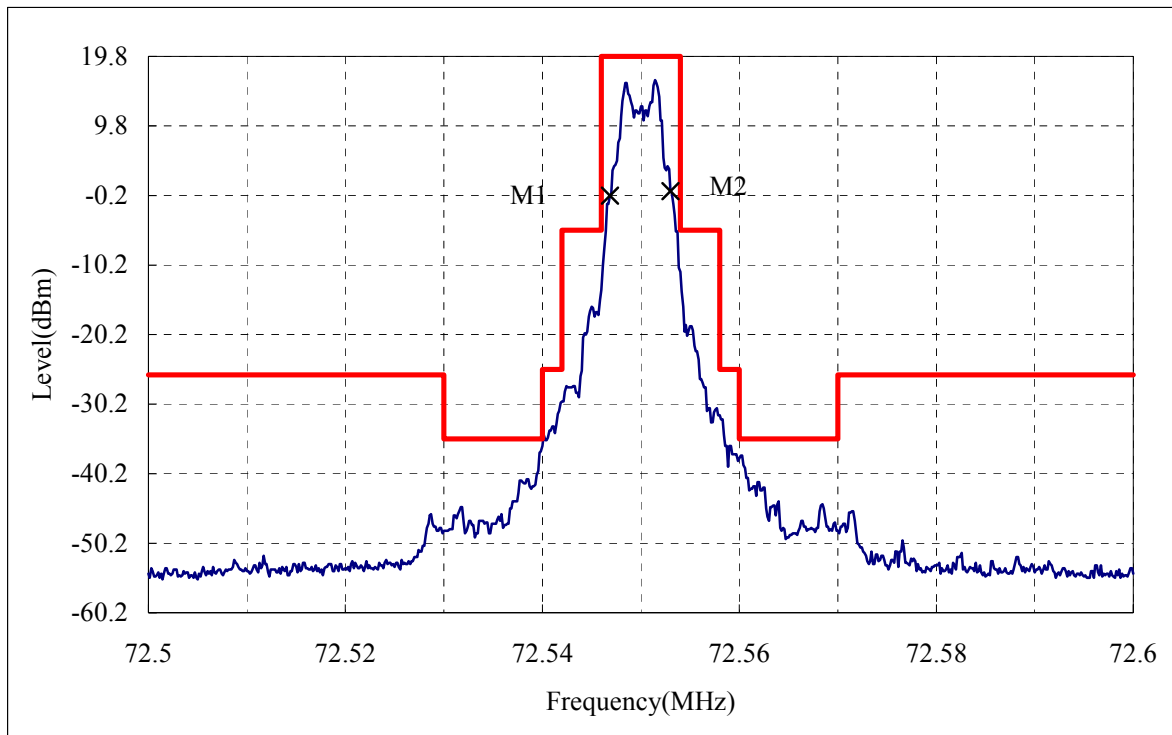

[Environment]

Temperature: 22°C

Humidity: 34%

[Summary of Test Results]

Above data shows that the test device complies with the requirements.

Tested Date : 29 November 2001

Tester Signature

Yasunari Kawai

Operation Mode of EUT

Non modulation (F Low)

Ref Level	Start Frequency	Stop Frequency	Center Frequency	RBW	VBW
(dBm)	MHz	(MHz)	(MHz)	(kHz)	(kHz)
19.80	72.5	72.6	72.55	0.30	1000.00

M1/M2 Point	Level	Occupied Bandwidth	Authorized Bandwidth
(MHz)	(dBm)	(kHz)	(kHz)
72.54786	0.0	1.14	8.00
72.54900	2.8		

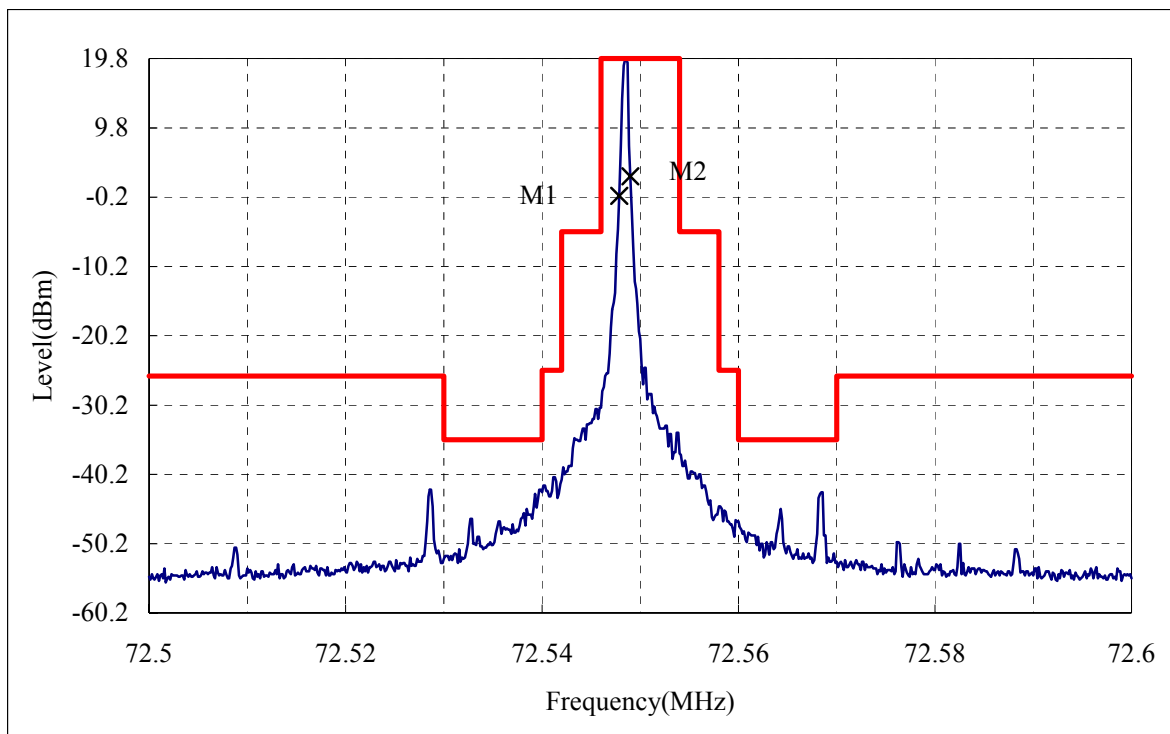

[Environment]

Temperature: 22°C

Humidity: 34%

[Summary of Test Results]

Above data shows that the test device complies with the requirements.

Tested Date : 29 November 2001

Tester Signature

Yasunari Kawai

Operation Mode of EUT

Non modulation (F High)

Ref Level	Start Frequency	Stop Frequency	Center Frequency	RBW	VBW
(dBm)	MHz	(MHz)	(MHz)	(kHz)	(kHz)
19.80	72.5	72.6	72.55	0.30	1000.00

M1/M2 Point	Level	Occupied Bandwith	Authorized Bandwith
(MHz)	(dBm)	(kHz)	(kHz)
72.55086	0.0	1.14	8.00
72.55200	5.6		

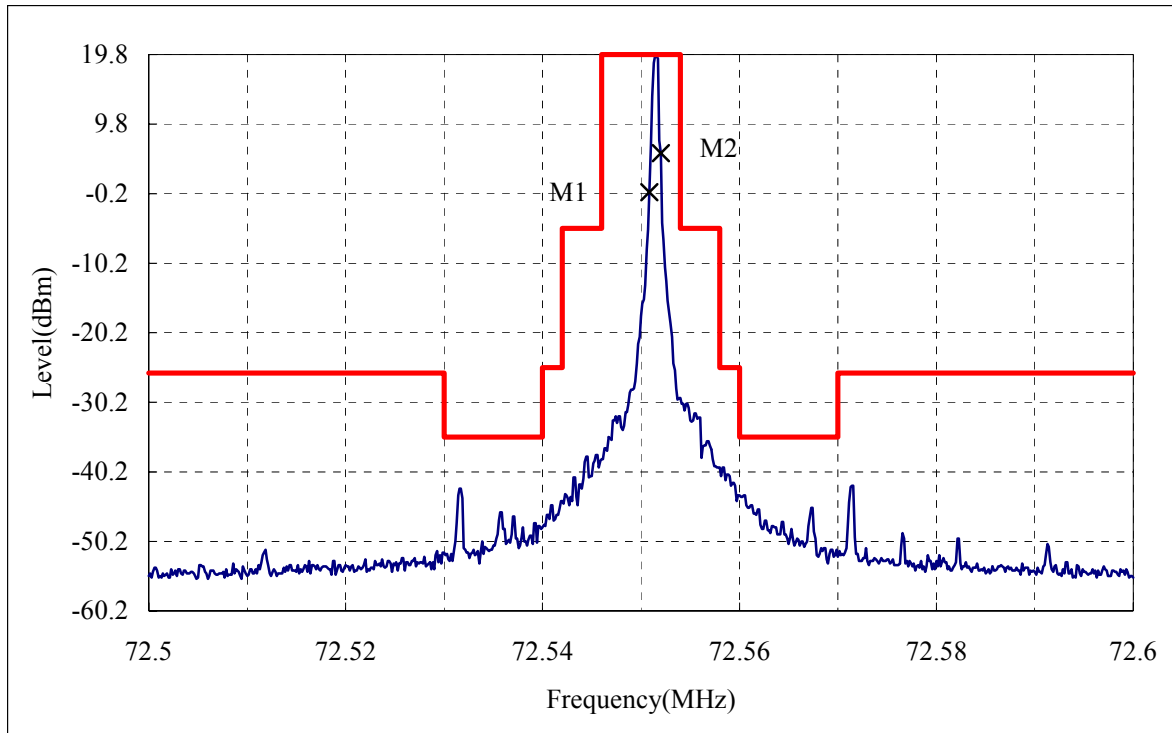

[Environment]

Temperature: 22°C

Humidity: 34%

[Summary of Test Results]

Above data shows that the test device complies with the requirements.

Tested Date : 29 November 2001

Tester Signature

Yasunari Kawai

6. FREQUENCY STABILITY MEASUREMENT

6.1 Reference Rule and Specification

FCC Rule Part 95 [Section95.623] and Part 2 Subpart J [Section2.1055]

6.2 Frequency vs Temperature Test

Test Setup Diagram

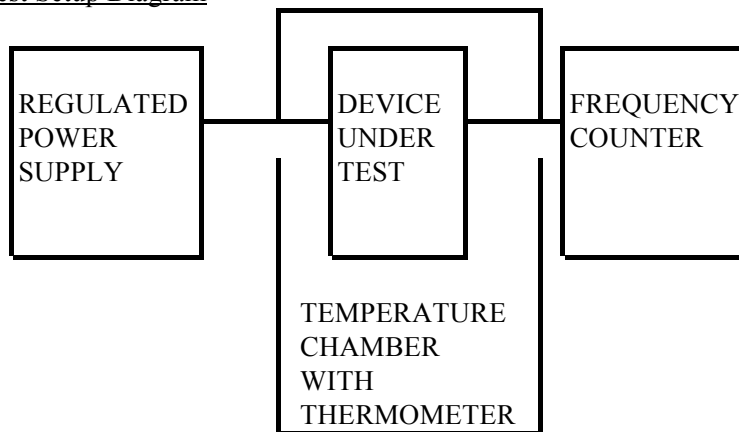

Test Result

Test Voltage: 9.6V

REFERENCE FREQUENCY [MHz]	TEMPERATURE [°C]	FREQUENCY DRIFT [%]	LIMIT [%]
<u>72.55</u>	-30	-0.000620	±0.002
	-20	-0.000192	
	-10	0.000291	
	0	0.000378	
	+10	0.000289	
	+20	0.000069	
	+30	-0.000172	
	+40	-0.000312	
	+50	-0.000387	

6.3 Frequency vs Voltage Test

Test Setup Diagram : Same as (1)

Test Result Temperature : +20°C

REFERENCE FREQUENCY [MHz]	SUPPLIED VOLTAGE [Volt]	FREQUENCY DRIFT [%]	LIMIT [%]
<u>72.55</u>	9.0	0.000053	±0.002

Note Reduced primary supply voltage to the operating and point which shall be specified by the manufacturer.

[Environment] Temperature : 25°C Humidity : 34%

[Summary of Test Results]

Above data shows that the test device complies with the requirements.

Tested Date : 4 December 2001

Tester Signature

Yasunari Kawai

7. USED TEST EQUIPMENTS AND CALIBRATION STATUS

Instrument	Manufacturer	Model No	Specifications	KEC Control No.	if used, checked by "X".	Last Cal.	Next Cal.
Spectrum Analyzer	Advantest	TR4172	Frequency Range 50 Hz - 1.8 GHz	SA-27	<input checked="" type="checkbox"/>	2001/7	2002/7
Biconical Antenna	Schwarzbeck	BBA9106	Frequency Range 30 MHz - 300 MHz	AN-99	<input checked="" type="checkbox"/>	2002/2	2003/2
Log-Periodic	Schwarzbeck	UHAL9108A	Frequency Range 300 MHz - 1 GHz	AN-249	<input checked="" type="checkbox"/>	2002/2	2003/2
Tuned Dipole Antenna (Tx)	Kyoritsu	KBA-511S	Frequency Range 25 MHz - 500 MHz	AN-135	<input checked="" type="checkbox"/>	2002/2	2003/2
	Kyoritsu	KBA-611S	Frequency Range 500 MHz - 1 GHz	AN-137	<input checked="" type="checkbox"/>	2002/2	2003/2
Signal Generator	Hewlett Packard	8662A	Frequency Range 10 kHz - 1280 MHz	SG-49	<input checked="" type="checkbox"/>	2001/4	2002/4
Power Amp.	ENI	601L	Frequency Range 0.8 MHz - 1 GHz	AM-24	<input checked="" type="checkbox"/>	2001/6	2002/6
RF Millivolt-Meter	Rohde & Schwarz	URV5	Frequency Range 10 kHz - 2 GHz	VV-29	<input checked="" type="checkbox"/>	2002/3	2003/3
Coaxial Cable	Suhner	SUCOFLEX 104	Length : 10m [SMA(p)-SMA(p)]	CL-45	<input checked="" type="checkbox"/>	2002/2	2003/2
Attenuator	Anritsu	M22665	Frequency Range 1 MHz - 20 GHz -10 dB	AT-44-3	<input checked="" type="checkbox"/>	2002/2	2003/2
	Anritsu	M45665	Frequency Range 1 MHz - 20GHz -20 dB	AT-44-4	<input checked="" type="checkbox"/>	2002/2	2003/2
Regurated DC Power Supply	Kikusui	PAB18-3A	Output 0-18V, 3A	PD-32	<input checked="" type="checkbox"/>	-	-
Temperature Chamber With Thermometer	Tabai Mfg.	MC-710	Temperature Range -75 - +100 °C	CH-31	<input checked="" type="checkbox"/>	-	-
Frequency Counter	Advantest	TR5823H	Freq.Range 1 mHz-1300 MHz	CU-17	<input checked="" type="checkbox"/>	2001/5	2002/5
Spectrum Analyzer	Advantest	R3261B	Frequency Range 9 kHz - 3.6 GHz	SA-32	<input checked="" type="checkbox"/>	2001/7	2002/7
Multimeter	John Fluke	37	Volt Range 0.1mV - 1000 V Ampere Range 0.01 mA - 20 A	MM-91	<input checked="" type="checkbox"/>	2002/2	2003/2
Digital Oscilloscope	Matsushita Communication Ind.	VP-5740A	Frequency Range DC -10 MHz	OS-22	<input checked="" type="checkbox"/>	2001/5	2002/5