



MEASUREMENT REPORT

FCC PART 15.249 / RSS-210

FCC ID: BRWSPMSR6200A
IC: 6157A-SPMSR6200A
Applicant: Horizon Hobby, LLC

Application Type: Certification
Product: 6CH AVC surface receiver
Model No.: SR6200A
Serial Model No.: SR631
Brand Name: Spektrum
FCC Classification: Part 15 Low Power Communication Device Transmitter (DXX)
FCC Rule Part(s): Part 15.249
ISED Rule(s): RSS-210 Issue 10, RSS-Gen Issue 5
Test Procedure(s): ANSI C63.10 - 2013
Test Date: June 30 ~ July 29, 2020

Reviewed By: Sunny Sun
 (Sunny Sun)

Approved By: Robin Wu
 (Robin Wu)



The test results relate only to the samples tested.
 This equipment has been shown to be capable of compliance with the applicable technical standards as indicated in the measurement report and was tested in accordance with the measurement procedures specified in ANSI C63.10-2013. Test results reported herein relate only to the item(s) tested.
 The test report shall not be reproduced except in full without the written approval of MRT Technology (Suzhou) Co., Ltd.

Revision History

Report No.	Version	Description	Issue Date	Note
2006RSU063-U1	Rev. 01	Initial Report	07-30-2020	Valid

CONTENTS

Description	Page
1. INTRODUCTION	6
1.1. Scope	6
1.2. MRT Test Location	6
2. PRODUCT INFORMATION	7
2.1. Equipment Description.....	7
2.2. Operation Frequency and Channel List.....	7
2.3. Description of Test Software.....	7
2.4. Duty Cycle	8
2.5. Labeling Requirements.....	8
3. DESCRIPTION OF TEST	10
3.1. Evaluation Procedure	10
3.2. AC Line Conducted Emissions	10
3.3. Radiated Emissions.....	11
4. ANTENNA REQUIREMENTS.....	12
5. TEST EQUIPMENT CALIBRATION DATE.....	13
6. MEASUREMENT UNCERTAINTY.....	15
7. TEST RESULT	16
7.1. Summary	16
7.2. Conducted Emission.....	17
7.2.1. Test Limit	17
7.2.2. Test Setup.....	17
7.2.3. Test Result.....	17
7.3. Radiated Emission.....	18
7.3.1. Test Limit	18
7.3.2. Test Procedure Used	19
7.3.3. Test Setting.....	19
7.3.4. Test Setup.....	21
7.3.5. Test Result.....	22
7.4. Radiated Restricted Band Edge Measurement	26
7.4.1. Test Limit	26
7.4.2. Test Procedure Used	29
7.4.3. Test Setting.....	29
7.4.4. Test Setup.....	30

7.4.5.	Test Result.....	31
7.5.	20dB Spectrum Bandwidth Measurement.....	35
7.5.1.	Test Limit	35
7.5.2.	Test Procedure used.....	35
7.5.3.	Test Setting.....	35
7.5.4.	Test Setup.....	35
7.5.5.	Test Result.....	36
7.6.	99% Bandwidth Measurement	37
7.6.1.	Test Limit	37
7.6.2.	Test Procedure used.....	37
7.6.3.	Test Setting.....	37
7.6.4.	Test Setup.....	37
7.6.5.	Test Result.....	38
8.	CONCLUSION.....	39
	Appendix A - Test Setup Photograph	40
	Appendix B - EUT Photograph.....	41

General Information

Applicant:	Horizon Hobby, LLC
Applicant Address:	2904 Research Rd., Champaign IL 61822
Manufacturer:	Horizon Hobby, LLC
Manufacturer Address:	2904 Research Rd., Champaign IL 61822
Test Site:	MRT Technology (Suzhou) Co., Ltd
Test Site Address:	D8 Building, No.2 Tian'edang Rd., Wuzhong Economic Development Zone, Suzhou, China

Test Facility / Accreditations

Measurements were performed at MRT Laboratory located in Tian'edang Rd., Suzhou, China.

- MRT facility is an FCC registered (MRT Designation No. CN1166) test facility with the site description report on file and has met all the requirements specified in ANSI C63.4-2014.
- MRT facility is an IC registered (MRT Reg. No. 11384A-1) test laboratory with the site description on file at Industry Canada.
- MRT facility is a VCCI registered (R-20025, G-20034, C-20020, T-20020) test laboratory with the site description on file at VCCI Council.
- MRT Lab is accredited to ISO 17025 by the American Association for Laboratory Accreditation (A2LA) under the American Association for Laboratory Accreditation Program (A2LA Cert. No. 3628.01) in EMC, Telecommunications, Radio and SAR testing.



1. INTRODUCTION

1.1. Scope

Measurement and determination of electromagnetic emissions (EMC) of radio frequency devices including intentional and/or unintentional radiators for compliance with the technical rules and regulations of the Federal Communications Commission and the Innovation, Science and Economic Development Canada and Certification and Engineering Bureau.

1.2. MRT Test Location

The map below shows the location of the MRT LABORATORY, its proximity to the Taihu Lake. These measurement tests were conducted at the MRT Technology (Suzhou) Co., Ltd. Facility located at D8 Building, No.2 Tian'edang Rd., Wuzhong Economic Development Zone, Suzhou, China. The measurement facility compliant with the test site requirements specified in ANSI C63.4-2014.



2. PRODUCT INFORMATION

2.1. Equipment Description

Product Name:	6CH AVC surface receiver
Model No.:	SR6200A
Serial Model No.:	SR631
PMN:	SR6200A, SR631
HVIN:	SR6200A, SR631
Brand Name:	Spektrum
Power Supply:	By Battery (DC 3.5V ~ 9.6V)
Frequency Range:	2404 ~ 2476 MHz
Channel Number:	23
Type of Modulation:	GFSK
Identification Number:	01

Note: The different models are only for marketing different clients, others are the same.

2.2. Operation Frequency and Channel List

Channel	Frequency	Channel	Frequency
00	2404 MHz	12	2442 MHz
01	2411 MHz	13	2446 MHz
02	2412 MHz	14	2450 MHz
03	2414 MHz	15	2452 MHz
04	2417 MHz	16	2456 MHz
05	2420 MHz	17	2459 MHz
06	2424 MHz	18	2463 MHz
07	2427 MHz	19	2466 MHz
08	2430 MHz	20	2469 MHz
09	2433 MHz	21	2473 MHz
10	2437 MHz	22	2476 MHz
11	2440 MHz	--	--

2.3. Description of Test Software

The test utility software used during testing was "RF Compliance Mode Setup", and the version was 4.1.

2.4. Duty Cycle

The maximum achievable duty cycles were determined based on measurements performed on a spectrum analyzer in zero-span mode with RBW = 8MHz, VBW = 50MHz, Sweep time = 100ms. The duty cycles are as follows:

Time On (ms)	One Period (ms)	Duty Cycle (%)	Duty Cycle Factor (dB)
12.6	100	12.6	-18.0

Note:

- Duty Cycle Factor = $20 * \text{Log}(\text{Duty Cycle})$
- Time On (ms) = $1.4 * 9 \text{ (ms)} = 12.6 \text{ (ms)}$.

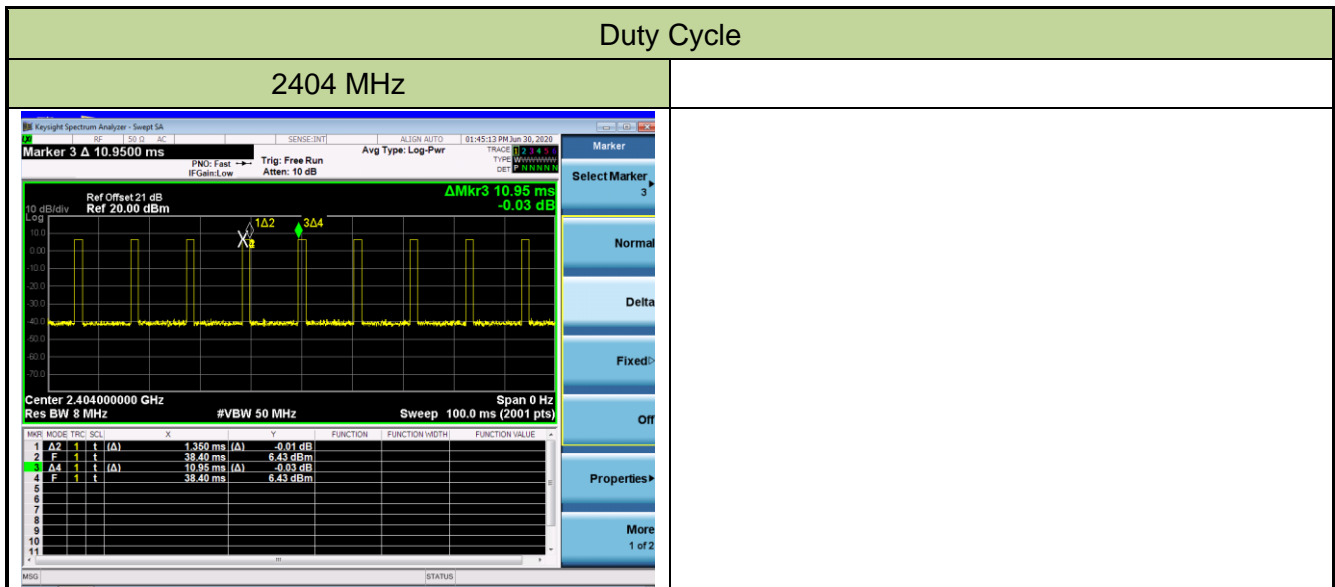

2.5. Labeling Requirements

Per 2.1074 & 15.19; Docket 95-19

The label shall be permanently affixed at a conspicuous location on the device; instruction manual or pamphlet supplied to the user and be readily visible to the purchaser at the time of purchase. However, when the device is so small wherein placement of the label with specified statement is not practical, only the FCC ID must be displayed on the device per Section 15.19(a)(5). Please see attachment for FCC ID label and label location.

RSS-Gen Issue 5 Section 4

In addition to complying with the applicable RSSs and RSP-100, each unit of a product model (i.e. of a radio apparatus) shall meet the labelling requirements set out in this section prior to being marketed in Canada or imported into Canada.

For information regarding the labelling option, see Section 4.1, 4.2, 4.3, 4.4. The label for the

certified product represents the manufacturer's or importer's compliance with Innovation, Science and Economic Development Canada's (ISED) regulatory requirements.

Please see attachment for IC label and label location.

3. DESCRIPTION OF TEST

3.1. Evaluation Procedure

The measurement procedures described in the American National Standard for Testing Unlicensed Wireless Devices (ANSI C63.10-2013) was used in the measurement of the device.

3.2. AC Line Conducted Emissions

The line-conducted facility is located inside an 8'x4'x4' shielded enclosure. A 1m x 2m wooden table 80cm high is placed 40cm away from the vertical wall and 80cm away from the sidewall of the shielded room. Two 10kHz-30MHz, 50 Ω /50 μ H Line-Impedance Stabilization Networks (LISNs) are bonded to the shielded room floor. Power to the LISNs is filtered by external high-current high-insertion loss power line filters. These filters attenuate ambient signal noise from entering the measurement lines. These filters are also bonded to the shielded enclosure.

The EUT is powered from one LISN and the support equipment is powered from the second LISN. All interconnecting cables more than 1 meter were shortened to a 1 meter length by non-inductive bundling (serpentine fashion) and draped over the back edge of the test table. All cables were at least 40cm above the horizontal reference ground-plane. Power cables for support equipment were routed down to the second LISN while ensuring that that cables were not draped over the second LISN.

Sufficient time for the EUT, support equipment, and test equipment was allowed in order for them to warm up to their normal operating condition. The RF output of the LISN was connected to the receiver and exploratory measurements were made to determine the frequencies producing the maximum emission from the EUT. The receiver was scanned from 150 kHz to 30 MHz. The detector function was set to peak mode for exploratory measurements while the bandwidth of the analyzer was set to 9 kHz. The EUT, support equipment, and interconnecting cables were arranged and manipulated to maximize each emission. Each emission was also maximized by varying: power lines, the mode of operation or data exchange speed, or support equipment whichever determined the worst-case emission. Once the worst case emissions have been identified, the one EUT cable configuration/arrangement and mode of operation that produced these emissions are used for final measurements on the same test site. The analyzer is set to CISPR quasi-peak and average detectors with a 9 kHz resolution bandwidth for final measurements.

An extension cord was used to connect to a single LISN which powered by EUT. The extension cord was calibrated with LISN, the impedance and insertion loss are compliance with the requirements as stated in ANSI C63.10-2013.

3.3. Radiated Emissions

The radiated test facilities consisted of an indoor 3 meter semi-anechoic chamber used for final measurements and exploratory measurements, when necessary. The measurement area is contained within the semi-anechoic chamber which is shielded from any ambient interference. For measurements above 1GHz absorbers are arranged on the floor between the turn table and the antenna mast in such a way so as to maximize the reduction of reflections. For measurements below 1GHz, the absorbers are removed. A MF Model 210SS turntable is used for radiated measurement. It is a continuously rotatable, remote controlled, metallic turntable and 2 meters (6.56 ft.) in diameter. The turn table is flush with the raised floor of the chamber in order to maintain its function as a ground plane. An 80cm high PVC support structure is placed on top of the turntable.

For all measurements, the spectrum was scanned through all EUT azimuths and from 1 to 4 meter receive antenna height using a broadband antenna from 30MHz up to the upper frequency shown in 15.33(b)(1) depending on the highest frequency generated or used in the device or on which the device operates or tunes. For frequencies above 1GHz, linearly polarized double ridge horn antennas were used. For frequencies below 30MHz, a calibrated loop antenna was used. When exploratory measurements were necessary, they were performed at 1 meter test distance inside the semi-anechoic chamber using broadband antennas, broadband amplifiers, and spectrum analyzers to determine the frequencies and modes producing the maximum emissions. Sufficient time for the EUT, support equipment, and test equipment was allowed in order for them to warm up to their normal operating condition. The test set-up for frequencies below 1GHz was placed on top of the 0.8 meter high, 1 x 1.5 meter table; and test set-up for frequencies 1-25GHz was placed on top of the 1.5 meter high, 1 x 1.5 meter table. The EUT, support equipment, and interconnecting cables were arranged and manipulated to maximize each emission. Appropriate precaution was taken to ensure that all emissions from the EUT were maximized and investigated. The system configuration, clock speed, mode of operation or video resolution, if applicable, turntable azimuth, and receive antenna height was noted for each frequency found.

Final measurements were made in the semi-anechoic chamber using calibrated, linearly polarized broadband and horn antennas. The test setup was configured to the setup that produced the worst case emissions. The spectrum analyzer was set to investigate all frequencies required for testing to compare the highest radiated disturbances with respect to the specified limits. The turntable containing the EUT was rotated through 360 degrees and the height of the receive antenna was varied 1 to 4 meters and stopped at the azimuth and height producing the maximum emission. Each emission was maximized by changing the orientation of the EUT through three orthogonal planes and changing the polarity of the receive antenna, whichever produced the worst-case emissions. According to 3dB Beam-Width of horn antenna, the horn antenna should be always directed to the EUT when rising height.

4. ANTENNA REQUIREMENTS

Excerpt from §15.203 of the FCC Rules/Regulations:

“An intentional radiator antenna shall be designed to ensure that no antenna other than that furnished by the responsible party can be used with the device. The use of a permanently attached antenna or of an antenna that uses a unique coupling to the intentional radiator shall be considered sufficient to comply with the provisions of this section.”

- The antenna of the EUT applies an IPEX connector coupling to the EUT.

Conclusion:

This unit complies with the requirement of §15.203.

5. TEST EQUIPMENT CALIBRATION DATE

Conducted Emissions - SR2

Instrument	Manufacturer	Type No.	Asset No.	Cali. Interval	Cali. Due Date
EMI Test Receiver	R&S	ESR3	MRTSUE06185	1 year	2021/01/18
Two-Line V-Network	R&S	ENV 216	MRTSUE06002	1 year	2021/06/11
Two-Line V-Network	R&S	ENV 216	MRTSUE06003	1 year	2021/06/11
Thermohygrometer	Testo	608-H1	MRTSUE06404	1 year	2020/08/08
Shielding Room	MIX-BEP	Chamber-SR2	MRTSUE06215	N/A	N/A

Radiated Emissions - AC1

Instrument	Manufacturer	Type No.	Asset No.	Cali. Interval	Cali. Due Date
EMI Test Receiver	R&S	ESR7	MRTSUE06001	1 year	2021/01/18
PXA Signal Analyzer	Keysight	9030B	MRTSUE06395	1 year	2020/09/03
Loop Antenna	Schwarzbeck	FMZB 1519	MRTSUE06025	1 year	2020/11/10
Bilog Period Antenna	Schwarzbeck	VULB 9168	MRTSUE06172	1 year	2021/04/03
Broad Band Horn Antenna	Schwarzbeck	BBHA 9120D	MRTSUE06023	1 year	2020/10/13
Broad Band Horn Antenna	Schwarzbeck	BBHA 9170	MRTSUE06597	1 year	2020/12/17
Microwave System Amplifier	Agilent	83017A	MRTSUE06076	1 year	2020/11/15
Preamplifier	Schwarzbeck	BBV 9721	MRTSUE06121	1 year	2021/06/11
Thermohygrometer	Testo	608-H1	MRTSUE06403	1 year	2020/08/08
Anechoic Chamber	TDK	Chamber-AC1	MRTSUE06212	1 year	2021/04/30

Radiated Emission - AC2

Instrument	Manufacturer	Type No.	Asset No.	Cali. Interval	Cali. Due Date
Spectrum Analyzer	Keysight	N9038A	MRTSUE06125	1 year	2020/08/01
Loop Antenna	Schwarzbeck	FMZB 1519	MRTSUE06025	1 year	2020/11/10
Bilog Period Antenna	Schwarzbeck	VULB 9162	MRTSUE06022	1 year	2020/10/13
Horn Antenna	Schwarzbeck	BBHA9120D	MRTSUE06171	1 year	2020/10/27
Broad Band Horn Antenna	Schwarzbeck	BBHA 9170	MRTSUE06597	1 year	2020/12/17
Broadband Coaxial Preamplifier	Schwarzbeck	BBV 9718	MRTSUE06176	1 year	2020/11/15
Preamplifier	Schwarzbeck	BBV 9721	MRTSUE06121	1 year	2021/06/11
Temperature/Humidity Meter	Minggao	ETH529	MRTSUE06170	1 year	2020/12/15
Anechoic Chamber	RIKEN	Chamber-AC2	MRTSUE06213	1 year	2021/04/30

Conducted Test Equipment - TR3

Instrument	Manufacturer	Type No.	Asset No.	Cali. Interval	Cali. Due Date
EXA Signal Analyzer	Agilent	N9020A	MRTSUE06106	1 year	2021/04/14
PXA Signal Analyzer	Keysight	N9030B	MRTSUE06395	1 year	2020/09/03
EXA Signal Analyzer	Keysight	N9010B	MRTSUE06607	1 year	2020/12/18
Signal Analyzer	R&S	FSV40	MRTSUE06218	1 year	2021/04/14
Power Meter	Agilent	U2021XA	MRTSUE06030	1 year	2020/11/18
USB wideband power sensor	Keysight	U2021XA	MRTSUE06446	1 year	2021/06/11
USB wideband power sensor	Keysight	U2021XA	MRTSUE06447	1 year	2021/06/11
Bluetooth Test Set	Anritsu	MT8852B-042	MRTSUE06389	1 year	2021/06/11
Audio Analyzer	Agilent	U8903B	MRTSUE06143	1 year	2021/06/11
Modulation Analyzer	HP	8901A	MRTSUE06098	1 year	2020/10/10
Wideband Radio Communication Tester	R&S	CMW 500	MRTSUE06243	1 year	2020/11/07
DC Power Supply	GWINSTEK	DPS-3303C	MRTSUE06064	N/A	N/A
Temperature & Humidity Chamber	BAOYT	BYH-150CL	MRTSUE06051	1 year	2020/11/07
Thermohygrometer	testo	608-H1	MRTSUE06401	1 year	2020/08/08

Software	Version	Function
EMI Software	V3	EMI Test Software

6. MEASUREMENT UNCERTAINTY

Where relevant, the following test uncertainty levels have been estimated for tests performed on the EUT as specified in CISPR 16-4-2. This uncertainty represents an expanded uncertainty expressed at approximately the 95% confidence level using a coverage factor of $k = 2$.

AC Conducted Emission Measurement
Measurement Uncertainty for a Level of Confidence of 95% ($U=2Uc(y)$): 9kHz~150kHz: 3.74dB 150kHz~30MHz: 3.44dB
Radiated Disturbance
Measurement Uncertainty for a Level of Confidence of 95% ($U=2Uc(y)$): Horizontal: 30MHz~300MHz: 5.04dB 300MHz~1GHz: 4.95dB 1GHz~25GHz: 6.40dB Vertical: 30MHz~300MHz: 5.24dB 300MHz~1GHz: 6.03dB 1GHz~25GHz: 6.40dB
Spurious Emissions, Conducted
Measurement Uncertainty for a Level of Confidence of 95% ($U=2Uc(y)$): 0.78dB
Output Power
Measurement Uncertainty for a Level of Confidence of 95% ($U=2Uc(y)$): 1.13dB
Power Spectrum Density
Measurement Uncertainty for a Level of Confidence of 95% ($U=2Uc(y)$): 1.15dB
Occupied Bandwidth
Measurement Uncertainty for a Level of Confidence of 95% ($U=2Uc(y)$): 0.28%

7. TEST RESULT

7.1. Summary

FCC Part Section(s)	RSS Section(s)	Test Description	Test Limit	Test Condition	Test Result	Reference
15.207	RSS-Gen Clause 8.8	AC Conducted Emissions 150kHz - 30MHz	< FCC 15.207 limits	Line Conducted	N/A	Section 7.2
15.209 15.249	RSS-Gen Clause 8.9; RSS-210 Annex B.10	General Field Strength Limits (Restricted Bands and Radiated Emission Limits)	Emissions in restricted bands must meet the radiated limits detailed in 15.209	Radiated	Pass	Section 7.3 & 7.4
15.215(c)	N/A	20dB Spectrum Bandwidth	20 dB bandwidth of the emission in the specific band	Conducted	Pass	Section 7.5
N/A	RSS-GEN Clause 6.7	99% Occupied Bandwidth	N/A		Pass	Section 7.6

Notes:

1. All modes of operation and data rates were investigated. For radiated emission test, every axis (X, Y, Z) was also verified. The test results shown in the following sections represent the worst case emissions.
2. The analyzer plots shown in this section were all taken with a correction table loaded into the analyzer. The correction table was used to account for the losses of the cables and attenuators used as part of the system to connect the EUT to the analyzer at all frequencies of interest.
3. "N/A" means that the test item is not applicable, and the detailed information refers to relevant section.

7.2. Conducted Emission

7.2.1. Test Limit

FCC Part 15.207 & RSS-GEN Limits		
Frequency (MHz)	QP (dBuV)	AV (dBuV)
0.15 ~ 0.50	66 ~ 56	56 ~ 46
0.50 ~ 5.0	56	46
5.0 ~ 30	60	50

Note 1: The lower limit shall apply at the transition frequencies.

Note 2: The limit decreases linearly with the logarithm of the frequency in the range 0.15MHz to 0.5MHz.

7.2.2. Test Setup

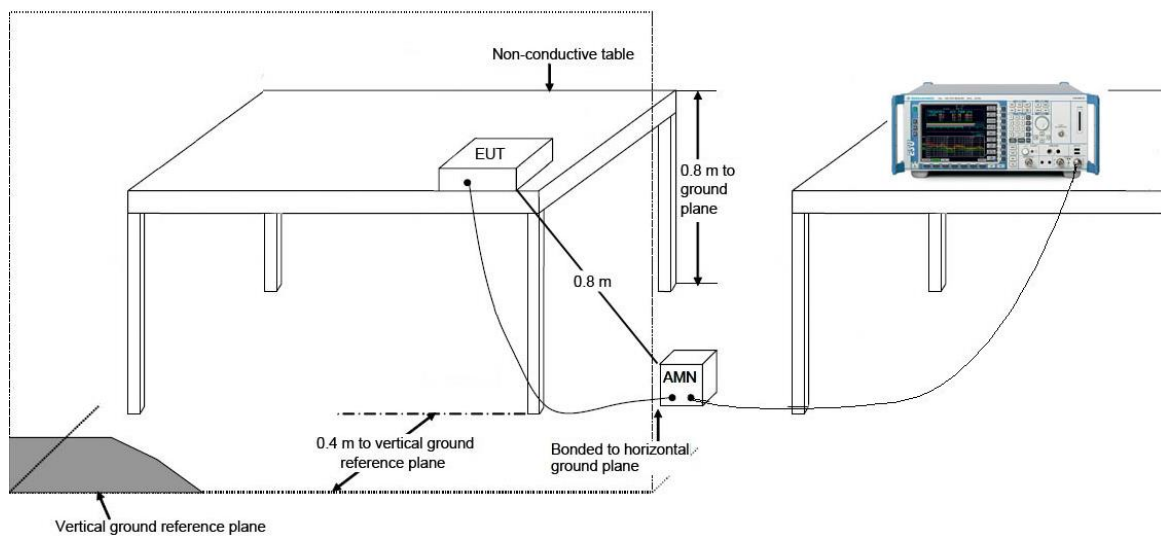

7.2.3. Test Result

The EUT is powered by battery, so this requirement does not apply.

7.3. Radiated Emission

7.3.1. Test Limit

FCC Part 15 Subpart C Paragraph 15.249 & RSS-210		
Fundamental Frequency (MHz)	Field Strength of Fundamental (mV/m)	Field Strength of Harmonics (uV/m)
902 ~ 928	50	500
2400 ~ 2483.5	50	500
5725 ~ 5875	50	500
24000 ~ 24250	250	2500

Note: FCC Part 15.249 (d), Emissions radiated outside of the specified frequency bands, except for harmonics, shall be attenuated by at least 50 dB below the level of the fundamental or to the general radiated emission limits in §15.209, whichever is the lesser attenuation.

FCC Part 15 Subpart C Paragraph 15.209 & RSS-GEN		
Frequency (MHz)	Field Strength (uV/m)	Measurement Distance (m)
0.009 ~ 0.490	2400/F(kHz)	300
0.490 ~ 1.705	24000/F(kHz)	30
1.705 ~ 30.0	30	30
30 ~ 88	100**	3
88 ~ 216	150**	3
216 ~ 960	200**	3
Above 960	500	3

Note 1: The lower limit shall apply at the transition frequency.
 Note 2: Distance refers to the distance in meters between the measuring instrument antenna and the closed point of any part of the device or system.
 Note 3: E field strength (dBuV/m) = 20 log E field strength (uV/m).

7.3.2. Test Procedure Used

ANSI C63.10-2013 Section 6.3

ANSI C63.10-2013 Section 6.4

ANSI C63.10-2013 Section 6.5

ANSI C63.10-2013 Section 6.6

ANSI C63.10-2013 Section 7.5

7.3.3. Test Setting

Table 1 - RBW as a function of frequency

Frequency	RBW
9 ~ 150 kHz	200 Hz
0.15 ~ 30 MHz	9 kHz
30 ~ 1000 MHz	120 kHz
> 1000 MHz	1 MHz

Measurements below 1GHz

1. Analyzer center frequency was set to the frequency of the radiated spurious emission of interest
3. RBW = as specified in Table 1
4. Detector = CISPR quasi-peak (a linear average detector for 9-90 kHz and 110-490 kHz)
5. Sweep time = auto couple
6. Trace was allowed to stabilize

Peak Measurements above 1GHz

1. Analyzer center frequency was set to the frequency of the radiated spurious emission of interest
2. RBW = 1MHz
3. VBW = 3MHz
4. Detector = peak
5. Sweep time = auto couple

6. Trace mode = max hold

7. Trace was allowed to stabilize

Average Measurement of pulsed emissions

1. Make EUT is transmitting to obtain the “worst-case” pulse ON time.
2. Couple the final radio frequency output signal to the input of a spectrum analyzer.
3. Adjust the center frequency of the spectrum analyzer to the center of the RF signal.
4. Set the spectrum analyzer for ZERO SPAN.
5. Sweep time = 100ms
6. Set the TRIGGER on the spectrum analyzer to capture at least one period of the pulse train, including any blanking intervals.
7. Determine the total maximum pulse “ON time” (t_{ON}) over one period of the pulse train.
8. The duty cycle is then determined by dividing the total maximum “ON time” by the period of the pulse train ($t_{ON}/100ms$).
9. Determine the duty cycle correction factor. Duty Cycle Factor = $20 * \text{Log}(\text{Duty Cycle})$
10. This correction factor may then be subtracted from the peak pulse amplitude (in dB) to find the average emission.

7.3.4. Test Setup

Below 1GHz Test Setup:

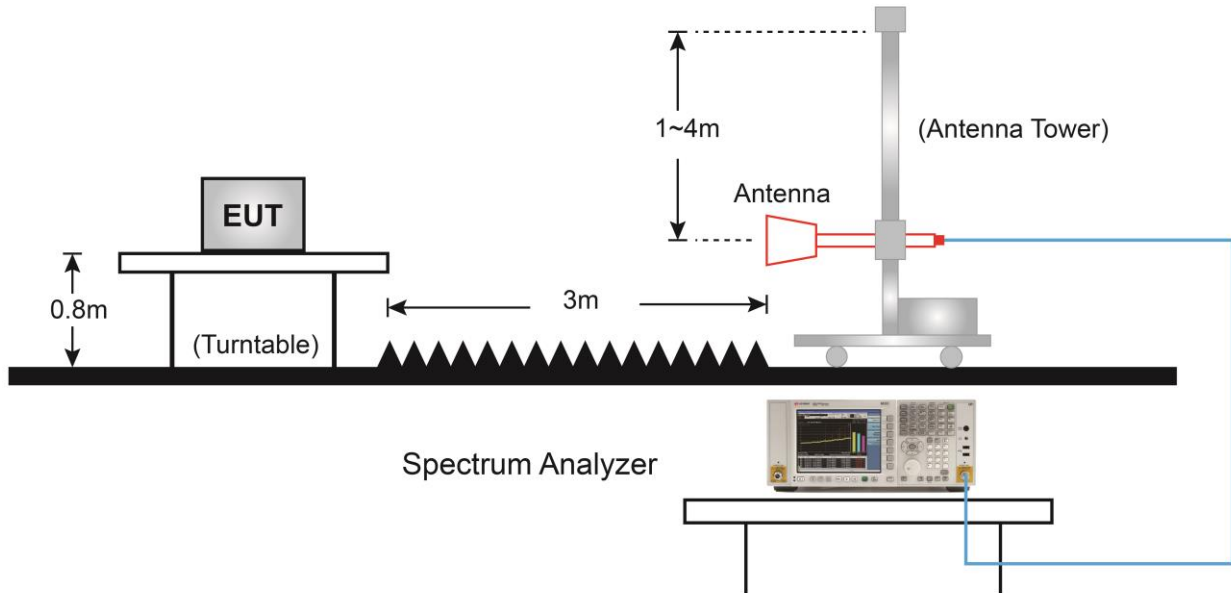

Above 1GHz Test Setup:

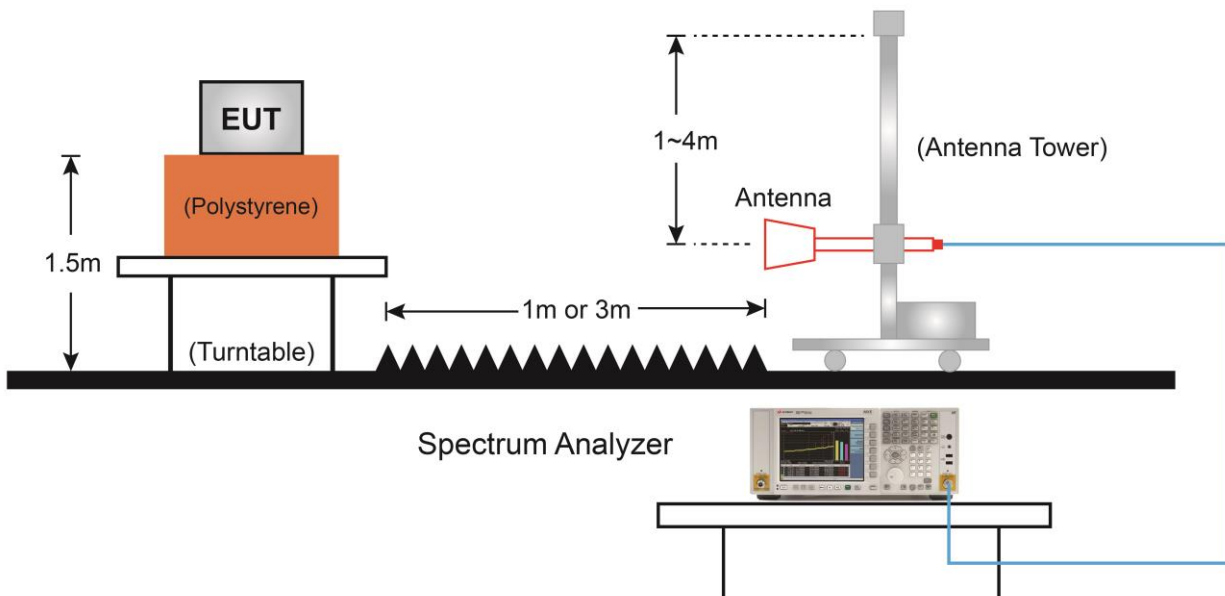

7.3.5. Test Result

Product	6CH AVC surface receiver	Temperature	24°C
Test Engineer	David Lv	Relative Humidity	59%
Test Site	AC1	Test Date	2020/07/07
Remark	Fundamental Radiated Emission		

Frequency (MHz)	Reading Level (dBμV)	Factor (dB)	Duty Cycle Factor (dB)	Measure Level (dBμV/m)	Limit (dBμV/m)	Margin (dB)	Detector	Polarization
2404	63.9	32.7	N/A	96.6	114.0	-17.4	PK	Horizontal
	63.9	32.7	-18.0	78.6	94.0	-15.4	AV	Horizontal
	60.5	32.7	N/A	93.2	114.0	-20.8	PK	Vertical
	60.5	32.7	-18.0	75.2	94.0	-18.8	AV	Vertical
2440	64.2	32.7	N/A	96.9	114.0	-17.1	PK	Horizontal
	64.2	32.7	-18.0	78.9	94.0	-15.1	AV	Horizontal
	60.9	32.7	N/A	93.6	114.0	-20.4	PK	Vertical
	60.9	32.7	-18.0	75.6	94.0	-18.4	AV	Vertical
2476	65.4	32.7	N/A	98.1	114.0	-15.9	PK	Horizontal
	65.4	32.7	-18.0	80.1	94.0	-13.9	AV	Horizontal
	61.2	32.7	N/A	93.9	114.0	-20.1	PK	Vertical
	61.2	32.7	-18.0	75.9	94.0	-18.1	AV	Vertical

Note: Peak Measure Level (dBμV/m) = Reading Level (dBμV) + Factor (dB)

Average Measure Level = Peak Measure Level + Duty Cycle Factor

Factor (dB) = Cable Loss (dB) + Antenna Factor (dB/m)

Product	6CH AVC surface receiver	Temperature	24°C
Test Engineer	David Lv	Relative Humidity	59%
Test Site	AC1	Test Date	2020/06/30
Remark:	Radiated Spurious Emission - Below 1GHz (Worst case mode)		

Frequency (MHz)	Reading Level (dBμV)	Factor (dB)	Measure Level (dBμV/m)	Limit (dBμV/m)	Margin (dB)	Detector	Polarization
34.4	11.3	13.2	24.5	40.0	-15.5	QP	Horizontal
71.7	9.2	12.0	21.2	40.0	-18.8	QP	Horizontal
155.6	9.7	14.6	24.3	43.5	-19.2	QP	Horizontal
179.9	14.2	12.9	27.1	43.5	-16.4	QP	Horizontal
275.9	7.9	14.1	22.0	46.0	-24.0	QP	Horizontal
501.9	2.0	19.7	21.7	46.0	-24.3	QP	Horizontal
47.9	17.0	14.5	31.5	40.0	-8.5	QP	Vertical
71.7	19.9	12.0	31.9	40.0	-8.1	QP	Vertical
108.1	14.2	10.9	25.1	43.5	-18.4	QP	Vertical
155.6	12.2	14.6	26.8	43.5	-16.7	QP	Vertical
251.6	8.7	13.0	21.7	46.0	-24.3	QP	Vertical
821.0	2.8	25.1	27.9	46.0	-18.1	QP	Vertical

Note:

- Measure Level (dBμV/m) = Reading Level (dBμV) + Factor (dB)
Factor (dB) = Cable Loss (dB) + Antenna Factor (dB/m)
- The test trace is same as the ambient noise (the test frequency range: 9kHz ~ 30MHz), therefore no data appear in the report.

Product	6CH AVC surface receiver	Temperature	24°C
Test Engineer	David Lv	Relative Humidity	59%
Test Site	AC1	Test Date	2020/06/30
Remark:	Radiated Spurious Emission - Above 1GHz		

Frequency (MHz)	Reading Level (dBμV)	Factor (dB)	Measure Level (dBμV/m)	Limit (dBμV/m)	Margin (dB)	Detector	Polarization
2404MHz							
4119.5	37.7	3.7	41.4	74.0	-32.6	PK	Horizontal
4808.0	39.4	5.9	45.3	74.0	-28.7	PK	Horizontal
9721.0	37.4	15.1	52.5	74.0	-21.5	PK	Horizontal
10392.5	36.8	16.0	52.8	74.0	-21.2	PK	Horizontal
4808.0	40.7	5.9	46.6	74.0	-27.4	PK	Vertical
7638.5	38.0	10.5	48.5	74.0	-25.5	PK	Vertical
9772.0	36.0	15.2	51.2	74.0	-22.8	PK	Vertical
10069.5	37.3	15.1	52.4	74.0	-21.6	PK	Vertical
2440MHz							
4731.5	37.2	5.8	43.0	74.0	-31.0	PK	Horizontal
7468.5	36.6	10.9	47.5	74.0	-26.5	PK	Horizontal
9772.0	36.3	15.2	51.5	74.0	-22.5	PK	Horizontal
10401.0	37.1	16.0	53.1	74.0	-20.9	PK	Horizontal
4880.0	36.6	5.9	42.5	74.0	-31.5	PK	Vertical
7570.5	36.2	10.8	47.0	74.0	-27.0	PK	Vertical
9763.5	36.2	15.2	51.4	74.0	-22.6	PK	Vertical
10435.0	36.2	16.4	52.6	74.0	-21.4	PK	Vertical
2476MHz							
4952.5	39.0	5.9	44.9	74.0	-29.1	PK	Horizontal
7477.0	37.5	10.8	48.3	74.0	-25.7	PK	Horizontal
9721.0	34.6	15.1	49.7	74.0	-24.3	PK	Horizontal
10367.0	37.5	16.0	53.5	74.0	-20.5	PK	Horizontal
4952.5	37.3	5.9	43.2	74.0	-30.8	PK	Vertical
7443.0	37.9	11.0	48.9	74.0	-25.1	PK	Vertical
9976.0	36.6	14.9	51.5	74.0	-22.5	PK	Vertical
10392.5	35.7	16.0	51.7	74.0	-22.3	PK	Vertical

Note:

1. Measure Level (dBμV/m) = Reading Level (dBμV) + Factor (dB)

Factor (dB) = Cable Loss (dB) + Antenna Factor (dB/m) - Pre Amplifier Gain (dB)

2. Average measurement was not performed when the peak level lower than average limit.
3. The amplitude of radiated emissions (frequency range from 9kHz to 30MHz and 18GHz to 25GHz) is that proximity to ambient noise, which also are attenuated more than 20 dB below the permissible value. Therefore, the data is not presented in the report.

7.4. Radiated Restricted Band Edge Measurement

7.4.1. Test Limit

For 15.205 requirement:

Radiated emissions which fall in the restricted bands, as defined in Section 15.205(a) of FCC part 15, must also comply with the radiated emission limits specified in Section 15.209(a).

Frequency (MHz)	Frequency (MHz)	Frequency (MHz)	Frequency (GHz)
0.090 - 0.110	16.42 - 16.423	399.9 - 410	4.5 - 5.15
¹ 0.495 - 0.505	16.69475 - 16.69525	608 - 614	5.35 - 5.46
2.1735 - 2.1905	16.80425 - 16.80475	960 - 1240	7.25 - 7.75
4.125 - 4.128	25.5 - 25.67	1300 - 1427	8.025 - 8.5
4.17725 - 4.17775	37.5 - 38.25	1435 - 1626.5	9.0 - 9.2
4.20725 - 4.20775	73 - 74.6	1645.5 - 1646.5	9.3 - 9.5
6.215 - 6.218	74.8 - 75.2	1660 - 1710	10.6 - 12.7
6.26775 - 6.26825	108 - 121.94	1718.8 - 1722.2	13.25 - 13.4
6.31175 - 6.31225	123 - 138	2200 - 2300	14.47 - 14.5
8.291 - 8.294	149.9 - 150.05	2310 - 2390	15.35 - 16.2
8.362 - 8.366	156.52475 - 156.52525	2483.5 - 2500	17.7 - 21.4
8.37625 - 8.38675	156.7 - 156.9	2690 - 2900	22.01 - 23.12
8.41425 - 8.41475	162.0125 - 167.17	3260 - 3267	23.6 - 24.0
12.29 - 12.293	167.72 - 173.2	3332 - 3339	31.2 - 31.8
12.51975 - 12.52025	240 - 285	3345.8 - 3358	36.43 - 36.5
12.57675 - 12.57725	322 - 335.4	3600 - 4400	(²)
13.36 - 13.41	--	--	--

All out of band emissions appearing in a restricted band as specified in Section 15.205 of the Title 47 CFR must not exceed the limits shown in Table per Section 15.209.

FCC Part 15 Subpart C Paragraph 15.209		
Frequency [MHz]	Field Strength [$\mu\text{V}/\text{m}$]	Measured Distance [Meter]
0.009 ~ 0.490	2400/F (kHz)	300
0.490 ~ 1.705	24000/F (kHz)	30
1.705 ~ 30	30	30
30 ~ 88	100	3
88 ~ 216	150	3
216 ~ 960	200	3
Above 960	500	3

For RSS-Gen Section 8.10 Requirement:

Radiated emissions which fall in the restricted bands, as defined in Section 8.10 of RSS-Gen, must also comply with the radiated emission limits specified in Section 8.9.

Frequency (MHz)	Frequency (MHz)	Frequency (GHz)
0.090 - 0.110	149.9 - 150.05	9.0 - 9.2
0.495 - 0.505	156.52475 - 156.52525	9.3 - 9.5
2.1735 - 2.1905	156.7 - 156.9	10.6 - 12.7
3.020 - 3.026	162.0125 - 167.17	13.25 - 13.4
4.125 - 4.128	167.72 - 173.2	14.47 - 14.5
4.17725 - 4.17775	240 - 285	15.35 - 16.2
4.20725 - 4.20775	322 - 335.4	17.7 - 21.4
5.677 - 5.683	399.9 - 410	22.01 - 23.12
6.215 - 6.218	608 - 614	23.6 - 24.0
6.26775 - 6.26825	960 - 1427	31.2 - 31.8
6.31175 - 6.31225	1435 - 1626.5	36.43 - 36.5
8.291 - 8.294	1645.5 - 1646.5	Above 38.6
8.362 - 8.366	1660 - 1710	--
8.37625 - 8.38675	1718.8 - 1722.2	
8.41425 - 8.41475	2200 - 2300	
12.29 - 12.293	2310 - 2390	
12.51975 - 12.52025	2483.5 - 2500	
12.57675 - 12.57725	2655 - 2900	
13.36 - 13.41	3260 - 3267	
16.42 - 16.423	3332 - 3339	
16.69475 - 16.69525	3345.8 - 3358	
16.80425 - 16.80475	3500 - 4400	
25.5 - 25.67	4500 - 5150	
37.5 - 38.25	5350 - 5460	
73 - 74.6	7250 - 7750	
74.8 - 75.2	8025 - 8500	
108 - 138	--	

Note: Certain frequency bands listed in above table and in bands above 38.6 GHz are designated for license exempt applications. These frequency bands and the requirements that apply to related devices are set out in the 200 and 300 series of RSSs.

All out of band emissions appearing in a restricted band as specified in Section 8.10 of the RSS-Gen must not exceed the limits shown in Table per Section 8.9.

Frequency [MHz]	Field Strength [uV/m]	Magnetic Field Strength (H-Field) [uA/m]	Measured Distance [Meters]
0.009 - 0.490 ¹	--	6.37/F (F in kHz)	300
0.490 - 1.705	--	6.37/F (F in kHz)	30
1.705 - 30	--	0.08	30
30 - 88	100	--	3
88 - 216	150	--	3
216 - 960	200	--	3
Above 960	500	--	3

Note: The emission limits for the bands 9 - 90kHz and 110 - 490kHz are based on measurements employing a linear average detector.

7.4.2. Test Procedure Used

ANSI C63.10-2013 Section 6.3

ANSI C63.10-2013 Section 6.6

ANSI C63.10-2013 Section 6.10.5

ANSI C63.10-2013 Section 7.5

7.4.3. Test Setting

Peak Field Strength Measurements

1. Analyzer center frequency was set to the frequency of the radiated spurious emission of interest
2. RBW = 1MHz
3. VBW = 3MHz
4. Detector = peak
5. Sweep time = auto couple
6. Trace mode = max hold
7. Trace was allowed to stabilize

Average Measurement of pulsed emissions

1. Make EUT is transmitting to obtain the “worst-case” pulse ON time.
2. Couple the final radio frequency output signal to the input of a spectrum analyzer.
3. Adjust the center frequency of the spectrum analyzer to the center of the RF signal.
4. Set the spectrum analyzer for ZERO SPAN.
5. Sweep time = 100ms
6. Set the TRIGGER on the spectrum analyzer to capture at least one period of the pulse train, including any blanking intervals.
7. Determine the total maximum pulse “ON time” (t_{ON}) over one period of the pulse train.
8. The duty cycle is then determined by dividing the total maximum “ON time” by the period of the pulse train ($t_{ON}/100ms$).
9. Determine the duty cycle correction factor. Duty Cycle Factor = $20 \cdot \text{Log}(\text{Duty Cycle})$
10. This correction factor may then be subtracted from the peak pulse amplitude (in dB) to find the average emission.

7.4.4. Test Setup

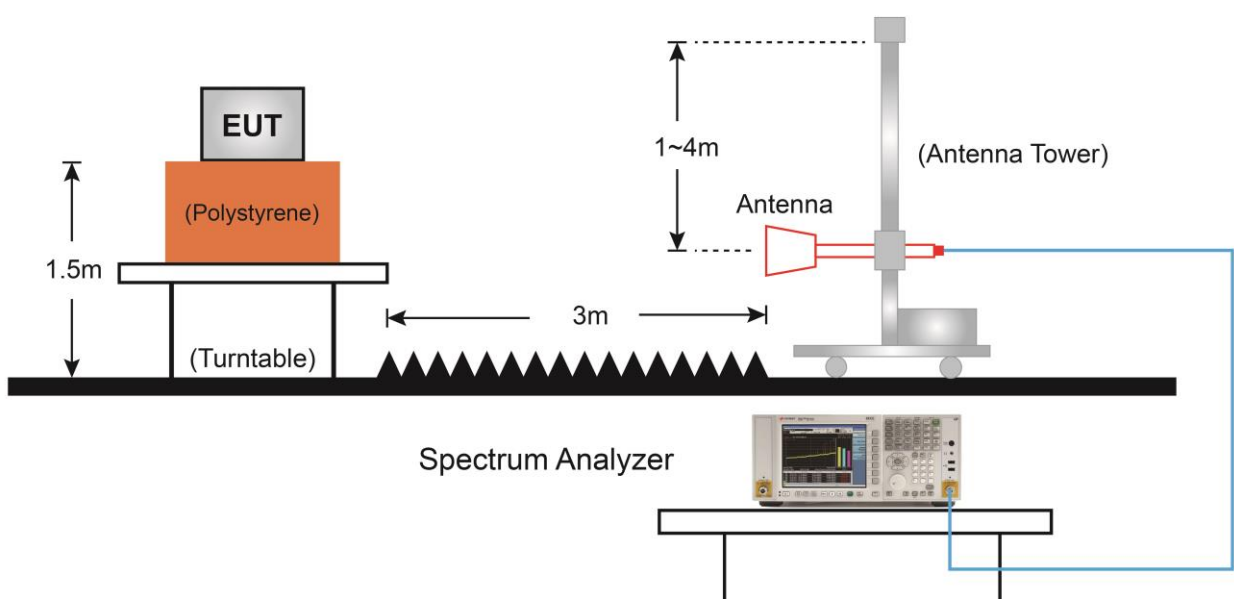

7.4.5. Test Result

Site: AC1	Time: 2020/07/07 - 19:55
Limit: FCC_Part15.209_RE(3m)	Engineer: David Lv
Probe: AC1_BBHA9120D_1-18GHz	Polarity: Horizontal
EUT: 6CH AVC surface receiver	Power: By Battery
Note: Transmit at frequency 2404MHz	

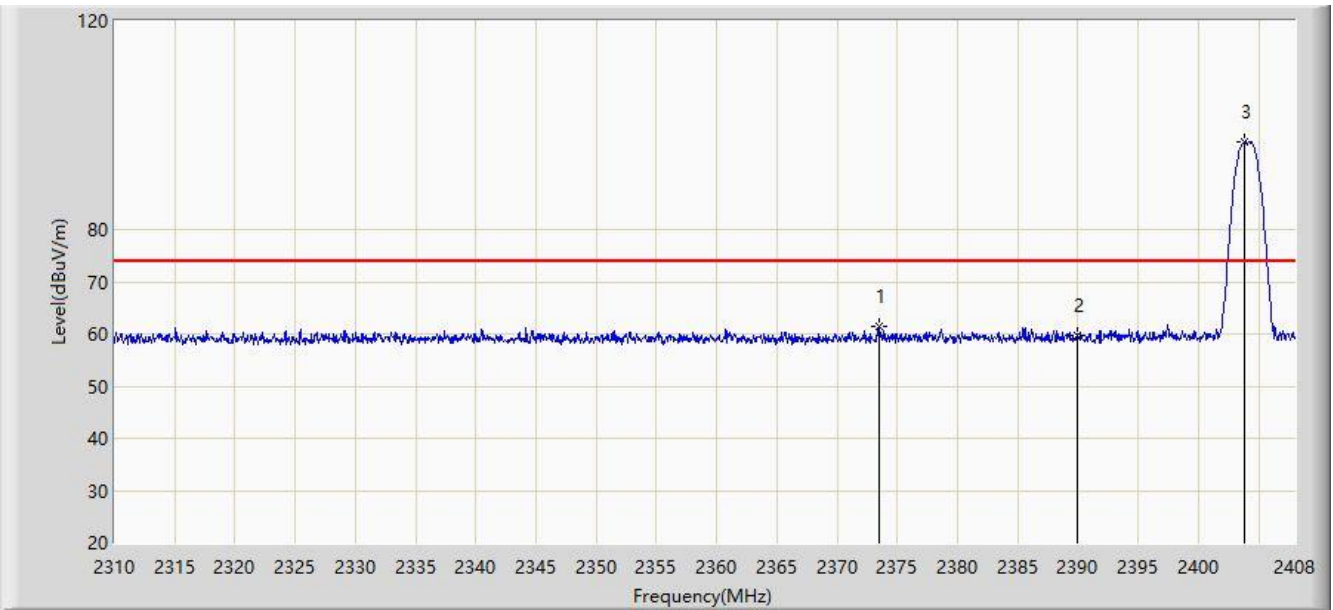

No	Flag	Mark	Frequency (MHz)	Reading Level (dBuV)	Factor (dB)	Duty Cycle Factor (dB)	Measure Level (dBuV/m)	Limit (dBuV/m)	Margin (dB)	Type
1			2373.470	28.822	32.696	N/A	61.519	74.000	-12.481	PK
			2373.470	28.822	32.696	-18.0	43.519	54.000	-10.481	AV
2			2390.000	26.939	32.712	N/A	59.651	74.000	-14.349	PK
			2390.000	26.939	32.712	-18.0	41.651	54.000	-12.349	AV
3		*	2403.830	63.937	32.741	N/A	96.678	N/A	N/A	PK

Note: Peak Measure Level (dB μ V/m) = Reading Level (dB μ V) + Factor (dB)

Average Measure Level = Peak Measure Level + Duty Cycle Factor

Factor (dB) = Cable Loss (dB) + Antenna Factor (dB/m)

Site: AC1	Time: 2020/07/07 - 20:03
Limit: FCC_Part15.209_RE(3m)	Engineer: David Lv
Probe: AC1_BBHA9120D_1-18GHz	Polarity: Vertical
EUT: 6CH AVC surface receiver	Power: By Battery
Note: Transmit at frequency 2404MHz	

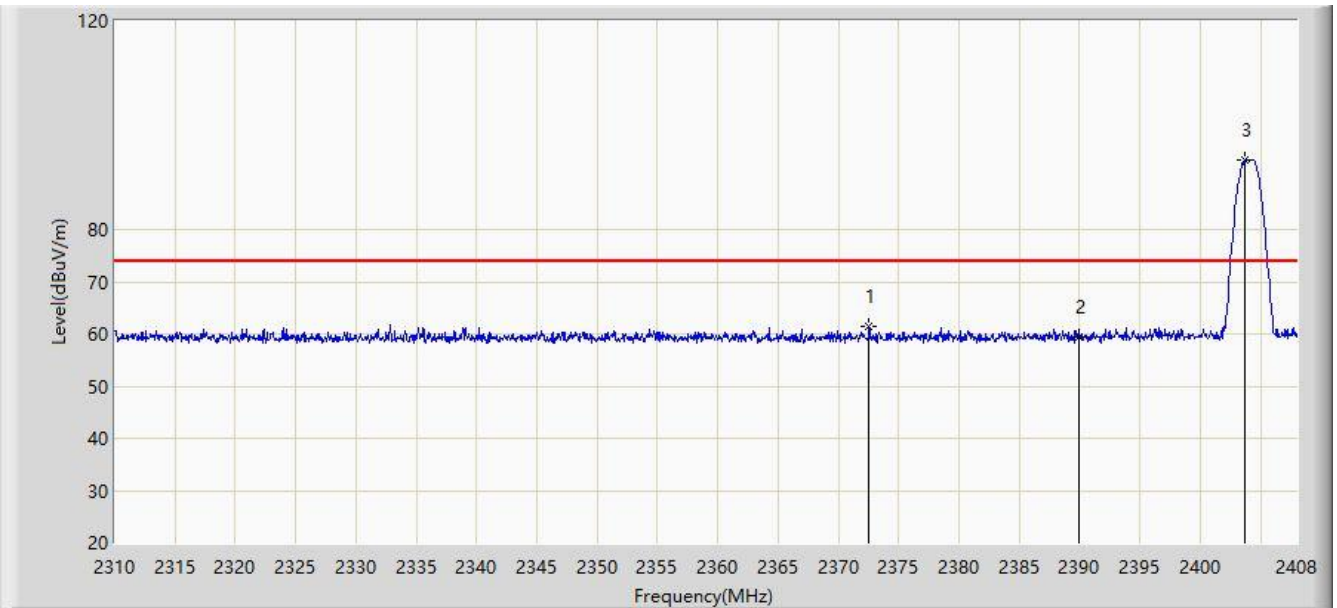

No	Flag	Mark	Frequency (MHz)	Reading Level (dBuV)	Factor (dB)	Duty Cycle Factor (dB)	Measure Level (dBuV/m)	Limit (dBuV/m)	Margin (dB)	Type
1			2372.535	28.774	32.701	N/A	61.475	74.000	-12.525	PK
			2372.535	28.774	32.701	-18.0	43.475	54.000	-10.525	AV
2			2390.000	26.659	32.712	N/A	59.371	74.000	-14.629	PK
			2390.000	26.659	32.712	-18.0	41.371	54.000	-12.629	AV
3		*	2403.720	60.483	32.741	N/A	93.224	N/A	N/A	PK

Note: Peak Measure Level (dB μ V/m) = Reading Level (dB μ V) + Factor (dB)

Average Measure Level = Peak Measure Level + Duty Cycle Factor

Factor (dB) = Cable Loss (dB) + Antenna Factor (dB/m)

Site: AC1	Time: 2020/07/07 - 19:32
Limit: FCC_Part15.209_RE(3m)	Engineer: David Lv
Probe: AC1_BBHA9120D_1-18GHz	Polarity: Horizontal
EUT: 6CH AVC surface receiver	Power: By Battery
Note: Transmit at frequency 2476MHz	

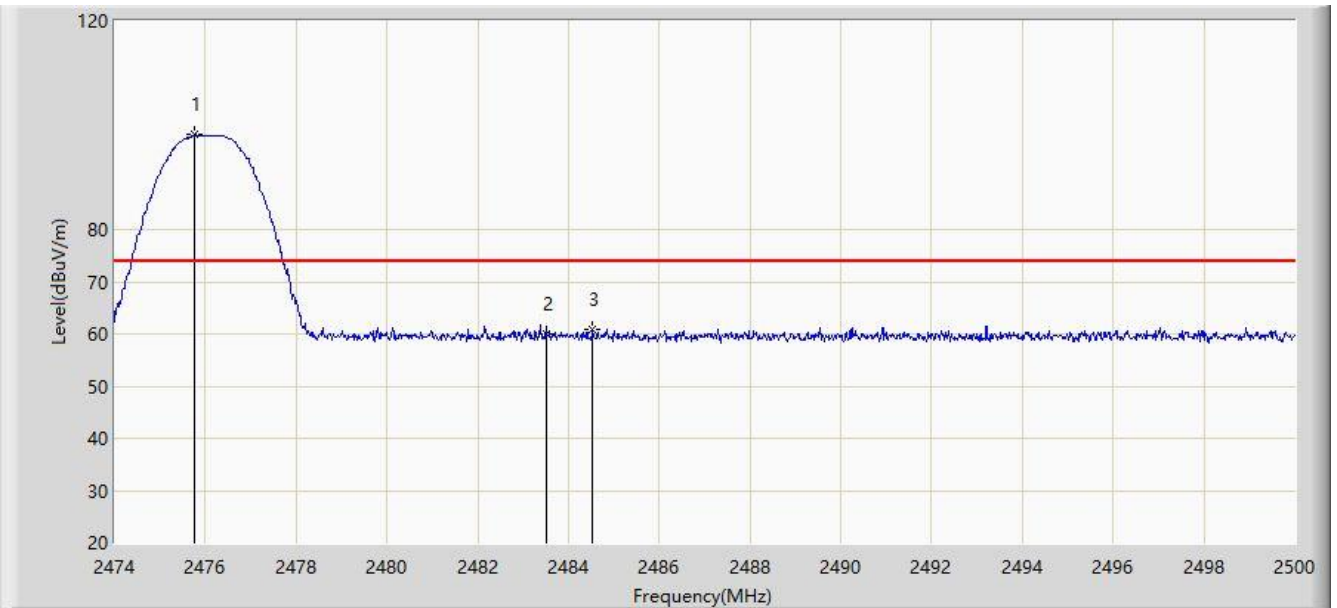

No	Flag	Mark	Frequency (MHz)	Reading Level (dBuV)	Factor (dB)	Duty Cycle Factor (dB)	Measure Level (dBuV/m)	Limit (dBuV/m)	Margin (dB)	Type
1		*	2475.775	65.419	32.721	N/A	98.140	N/A	N/A	PK
2			2483.500	27.487	32.651	N/A	60.137	74.000	-13.863	PK
			2483.500	27.487	32.651	-18.0	42.137	54.000	-11.863	AV
3			2484.534	28.134	32.641	N/A	60.775	74.000	-13.225	PK
			2484.534	28.134	32.641	-18.0	42.775	54.000	-11.225	AV

Note: Peak Measure Level (dB μ V/m) = Reading Level (dB μ V) + Factor (dB)

Average Measure Level = Peak Measure Level + Duty Cycle Factor

Factor (dB) = Cable Loss (dB) + Antenna Factor (dB/m)

Site: AC1	Time: 2020/07/07 - 19:54
Limit: FCC_Part15.209_RE(3m)	Engineer: David Lv
Probe: AC1_BBHA9120D_1-18GHz	Polarity: Vertical
EUT: 6CH AVC surface receiver	Power: By Battery
Note: Transmit at frequency 2476MHz	

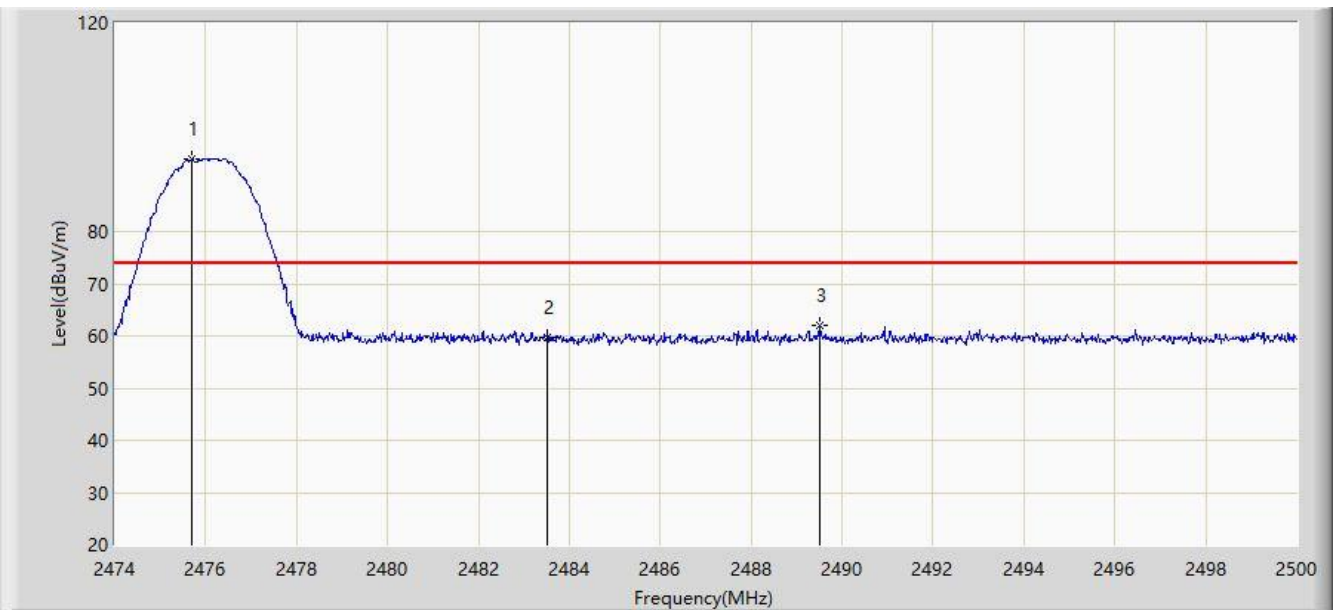

No	Flag	Mark	Frequency (MHz)	Reading Level (dBuV)	Factor (dB)	Duty Cycle Factor (dB)	Measure Level (dBuV/m)	Limit (dBuV/m)	Margin (dB)	Type
1		*	2475.699	61.176	32.722	N/A	93.898	N/A	N/A	PK
2			2483.500	26.954	32.651	N/A	59.604	74.000	-14.396	PK
			2483.500	26.954	32.651	-18.0	41.604	54.000	-12.396	AV
3			2489.512	29.473	32.616	N/A	62.089	74.000	-11.911	PK
			2489.512	29.473	32.616	-18.0	44.089	54.000	-9.911	AV

Note: Peak Measure Level (dB μ V/m) = Reading Level (dB μ V) + Factor (dB)

Average Measure Level = Peak Measure Level + Duty Cycle Factor

Factor (dB) = Cable Loss (dB) + Antenna Factor (dB/m)

7.5. 20dB Spectrum Bandwidth Measurement

7.5.1. Test Limit

Intentional radiators must be designed to ensure that the 20 dB bandwidth of the emission in the specific band.

7.5.2. Test Procedure used

ANSI C63.10-2013 Clause 6.9.2

7.5.3. Test Setting

1. Set the spectrum span range to overlap the nominal center frequency
2. Set RBW = 1% ~ 5% of the OBW
3. VBW $\geq 3 \times$ RBW
4. Detector = Peak
5. Trace mode = max hold
6. Sweep = auto couple
7. Allow the trace was allowed to stabilize and marker the highest level
8. Determine the display level (the highest level - 20dB) and place two markers, one at the lowest frequency and the other at the highest frequency

7.5.4. Test Setup

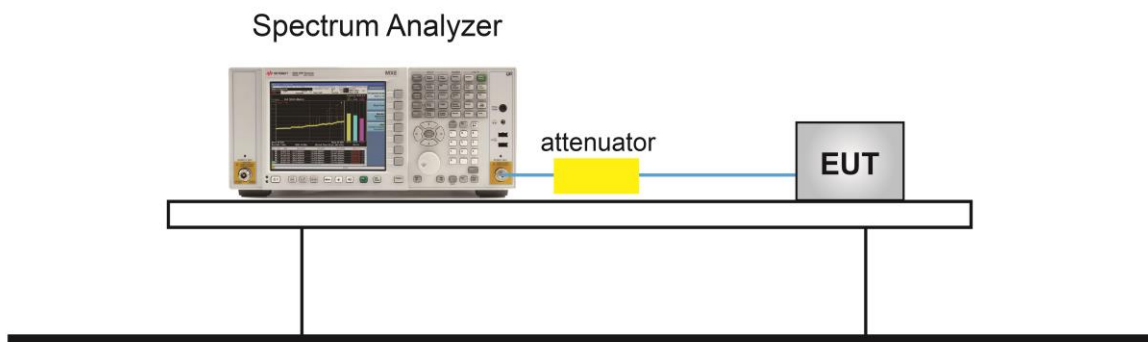

7.5.5. Test Result

Product	6CH AVC surface receiver	Temperature	24°C
Test Engineer	David Lv	Relative Humidity	59%
Test Site	TR3	Test Date	2020/07/29

Frequency (MHz)	Frequency Range (MHz)	Frequency Range (MHz)	Limit (MHz)	Result
2404	2403.463	--	> 2400.0	Pass
2476	--	2476.615	< 2483.5	Pass

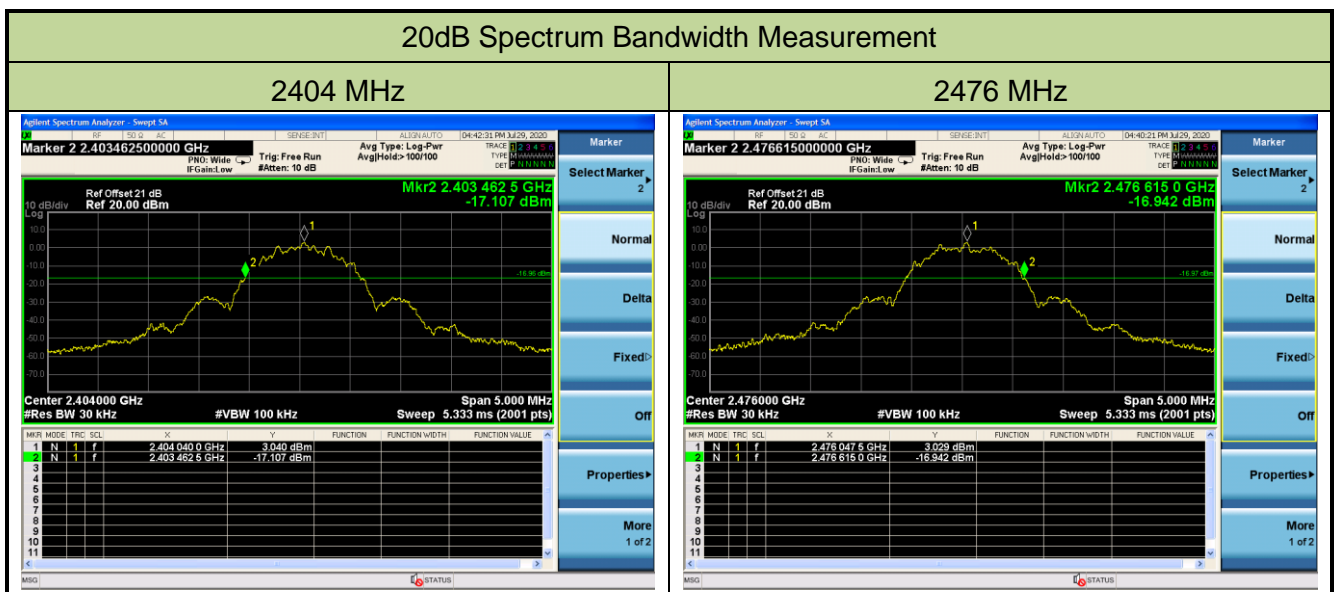

7.6. 99% Bandwidth Measurement

7.6.1. Test Limit

N/A

7.6.2. Test Procedure used

ANSI C63.10-2013 Section 6.9.3

7.6.3. Test Setting

1. The analyzers' automatic bandwidth measurement capability was used to perform the 99% bandwidth measurement. The bandwidth measurement was not influenced by any intermediated power nulls in the fundamental emission.
2. RBW = approximately 1% to 5% of the OBW.
3. VBW $\geq 3 \times$ RBW.
4. Detector = Peak.
5. Trace mode = max hold.

7.6.4. Test Setup

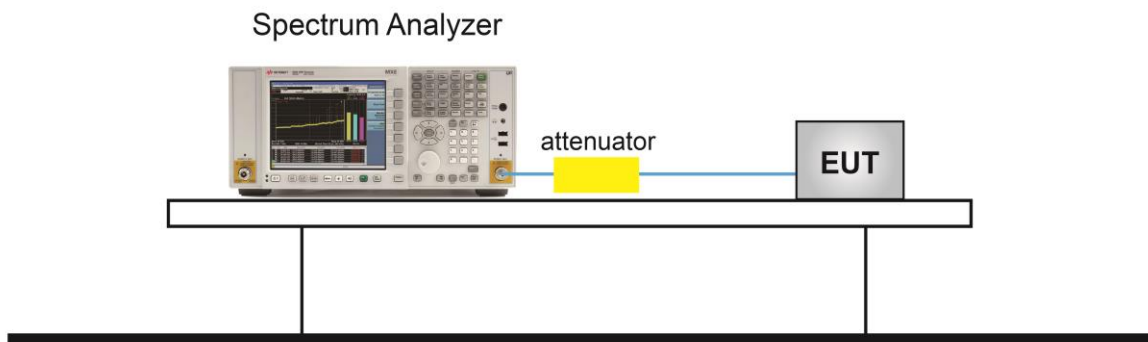

7.6.5. Test Result

Product	6CH AVC surface receiver	Temperature	24°C
Test Engineer	David Lv	Relative Humidity	59%
Test Site	TR3	Test Date	2020/06/30

Frequency (MHz)	99% Bandwidth (MHz)
2404	1.0582
2440	1.0559
2476	1.0581

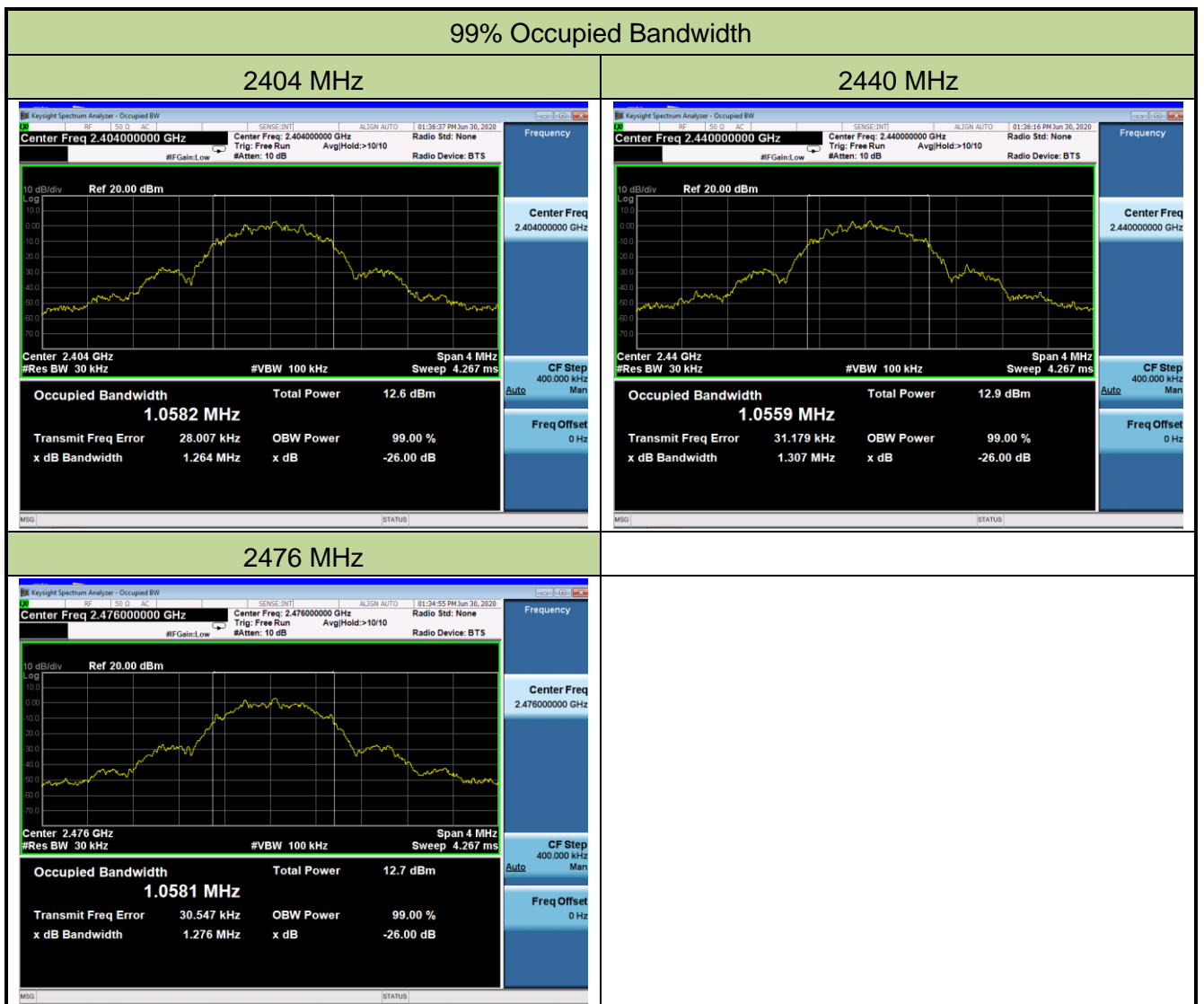

8. CONCLUSION

The data collected relate only the item(s) tested and show that this device is compliance with Part 15C of the FCC Rules and RSS-210 of ISED Rules.

Appendix A - Test Setup Photograph

Refer to "2006RSU063-UT" file.

Appendix B - EUT Photograph

Refer to "2006RSU063-UE" file.