



MEASUREMENT REPORT

FCC PART 15.247/ ISED RSS-247

FCC ID: BRWSPMSLT300
IC: 6157A-SPMSLT300
Applicant: Horizon Hobby, LLC
Application Type: Certification
Product: SLT3 3CH TX
Model No.: SPMSLT300
Brand Name: Spektrum
FCC Classification: Digital Transmission System (DTS)
FCC Rule Part(s): Part 15 Subpart C (Section 15.247)
ISED Rule(s): RSS-247 Issue 2, RSS-Gen Issue 5
Test Procedure(s): ANSI C63.10-2013
Test Date: March 17 ~ April 02, 2020

Reviewed By: 
(Sunny Sun)

Approved By: 
(Robin Wu)



The test results relate only to the samples tested.

This equipment has been shown to be capable of compliance with the applicable technical standards as indicated in the measurement report and was tested in accordance with the measurement procedures specified in ANSI C63.10-2013. Test results reported herein relate only to the item(s) tested.

The test report shall not be reproduced except in full without the written approval of MRT Technology (Suzhou) Co., Ltd.

Revision History

Report No.	Version	Description	Issue Date	Note
2003RSU018-U1	Rev. 01	Initial Report	04-08-2020	Valid

CONTENTS

Description	Page
1. INTRODUCTION.....	6
1.1. Scope.....	6
1.2. MRT Test Location.....	6
2. PRODUCT INFORMATION.....	7
2.1. Feature of Equipment under Test	7
2.2. Channel List	8
2.3. Test Mode	8
2.4. Description of Test Software	9
2.5. Duty Cycle.....	9
2.6. Test Configuration.....	10
2.7. EMI Suppression Device(s)/Modifications.....	10
2.8. Labeling Requirements	10
3. DESCRIPTION of TEST	11
3.1. Evaluation Procedure.....	11
3.2. AC Line Conducted Emissions	11
3.3. Radiated Emissions	12
4. ANTENNA REQUIREMENTS	13
5. TEST EQUIPMENT CALIBRATION DATE.....	14
6. MEASUREMENT UNCERTAINTY.....	16
7. TEST RESULT	17
7.1. Summary.....	17
7.2. 6dB & 99% Bandwidth Measurement	18
7.2.1. Test Limit.....	18
7.2.2. Test Procedure used	18
7.2.3. Test Setting	18
7.2.4. Test Setup	19
7.2.5. Test Result	20
7.3. Output Power Measurement	22
7.3.1. Test Limit.....	22
7.3.2. Test Procedure Used.....	22
7.3.3. Test Setting	22
7.3.4. Test Setup	23
7.3.5. Test Result	24

7.4.	Power Spectral Density Measurement	25
7.4.1.	Test Limit	25
7.4.2.	Test Procedure Used.....	25
7.4.3.	Test Setting	25
7.4.4.	Test Setup	26
7.4.5.	Test Result	27
7.5.	Conducted Band Edge and Out-of-Band Emissions	29
7.5.1.	Test Limit	29
7.5.2.	Test Procedure Used.....	29
7.5.3.	Test Settintg	29
7.5.4.	Test Setup	30
7.5.5.	Test Result	31
7.6.	Radiated Spurious Emission Measurement	34
7.6.1.	Test Limit	34
7.6.2.	Test Procedure Used.....	34
7.6.3.	Test Setting	34
7.6.4.	Test Setup	36
7.6.5.	Test Result	37
7.7.	Radiated Restricted Band Edge Measurement.....	43
7.7.1.	Test Limit	43
7.7.2.	Test Procedure Used.....	45
7.7.3.	Test Setting	45
7.7.4.	Test Setup	46
7.7.5.	Test Result	47
7.8.	AC Conducted Emissions Measurement	55
7.8.1.	Test Limit	55
7.8.2.	Test Setup	55
7.8.3.	Test Result	55
8.	CONCLUSION	56
	Appendix A - Test Setup Photograph	57
	Appendix B - EUT Photograph	58

General Information

Applicant:	Horizon Hobby, LLC
Applicant Address:	4105 Fieldstone Rd., Champaign, IL 61822 USA
Manufacturer:	Zhejiang Feishen Vehicle Industry Co., Ltd
Manufacturer Address:	No.98, North Lake Rd, Science & Hardware Technology Industrial Zone Yongkang City, Zhejiang, China
Test Site:	MRT Technology (Suzhou) Co., Ltd
Test Site Address:	D8 Building, No.2 Tian'edang Rd., Wuzhong Economic Development Zone, Suzhou, China

Test Facility / Accreditations

Measurements were performed at MRT Laboratory located in Tian'edang Rd., Suzhou, China.

- MRT facility is a FCC registered (MRT Designation No. CN1166) test facility with the site description report on file and has met all the requirements specified in ANSI C63.4-2014.
- MRT facility is an IC registered (MRT Reg. No. 11384A-1) test laboratory with the site description on file at Industry Canada.
- MRT facility is a VCCI registered (R-20025, G-20034, C-20020, T-20020) test laboratory with the site description on file at VCCI Council.
- MRT Lab is accredited to ISO 17025 by the American Association for Laboratory Accreditation (A2LA) under the American Association for Laboratory Accreditation Program (A2LA Cert. No. 3628.01) in EMC, Telecommunications, Radio and SAR testing.



1. INTRODUCTION

1.1. Scope

Measurement and determination of electromagnetic emissions (EMC) of radio frequency devices including intentional and/or unintentional radiators for compliance with the technical rules and regulations of the Federal Communications Commission and the Innovation, Science and Economic Development Canada and Certification and Engineering Bureau.

1.2. MRT Test Location

The map below shows the location of the MRT LABORATORY, its proximity to the Taihu Lake. These measurement tests were conducted at the MRT Technology (Suzhou) Co., Ltd. Facility located at D8 Building, No.2 Tian'edang Rd., Wuzhong Economic Development Zone, Suzhou, China. The measurement facility compliant with the test site requirements specified in ANSI C63.4-2014.



2. PRODUCT INFORMATION

2.1. Feature of Equipment under Test

Product Name:	SLT3 3CH TX
Model No.:	SPMSLT300
Brand Name:	Spektrum
Frequency Range:	2403 ~ 2480 MHz
Type of Modulation:	GFSK
Channel Number:	75
Antenna Type:	Monopole Antenna,
Antenna Gain:	2dBi

2.2. Channel List

Channel	Frequency	Channel	Frequency	Channel	Frequency
01	2403 MHz	02	2404 MHz	03	2405 MHz
04	2406 MHz	05	2407 MHz	06	2408 MHz
07	2409 MHz	08	2410 MHz	09	2411 MHz
10	2412 MHz	11	2413 MHz	12	2414 MHz
13	2415 MHz	14	2416 MHz	15	2417 MHz
16	2418 MHz	17	2419 MHz	18	2420 MHz
19	2421 MHz	20	2422 MHz	21	2423 MHz
22	2424 MHz	23	2425 MHz	24	2426 MHz
25	2427 MHz	26	2428 MHz	27	2429 MHz
28	2430 MHz	29	2431 MHz	30	2432 MHz
31	2433 MHz	32	2434 MHz	33	2435 MHz
34	2436 MHz	35	2437 MHz	36	2438 MHz
37	2439 MHz	38	2440 MHz	39	2441 MHz
40	2442 MHz	41	2443 MHz	42	2444 MHz
43	2445 MHz	44	2446 MHz	45	2447 MHz
46	2448 MHz	47	2449 MHz	48	2450 MHz
49	2451 MHz	50	2452 MHz	51	2453 MHz
52	2454 MHz	53	2455 MHz	54	2456 MHz
55	2457 MHz	56	2458 MHz	57	2459 MHz
58	2460 MHz	59	2461 MHz	60	2462 MHz
61	2463 MHz	62	2464 MHz	63	2465 MHz
64	2466 MHz	65	2467 MHz	66	2468 MHz
67	2469 MHz	68	2470 MHz	69	2471 MHz
70	2472 MHz	71	2473 MHz	72	2474 MHz
73	2475 MHz	74	2476 MHz	75	2480 MHz

Note: For the different power level, we choose Channel 01 (2403MHz), Channel 38(2440MHz), Channel 74 (2476MHz) and Channel 75 (2480MHz) for all of test. The detailed power level refers to Clause 2.4 of this report.

2.3. Test Mode

Test Mode	Mode 1: Transmit by GFSK Modulation
-----------	-------------------------------------

2.4. Description of Test Software

The test utility software used during testing was provided by the manufacturer.

Power parameter values are as below.

Channel	Frequency	Power Parameter Value
01 ~ 04	2403 MHz ~ 2406 MHz	10
05 ~ 66	2407 MHz ~ 2468 MHz	15
67 ~ 74	2469 MHz ~ 2476 MHz	10
75	2480 MHz	0

Note: For the different power level, we choose Channel 01 (2403MHz), Channel 38(2440MHz), Channel 74 (2476MHz) and Channel 75 (2480MHz) for all of test.

2.5. Duty Cycle

The maximum achievable duty cycles for all modes were determined based on measurements performed on a spectrum analyzer in zero-span mode with RBW = 8MHz, VBW = 50MHz, and detector = peak. The RBW and VBW were both greater than 50/T, where T is the minimum transmission duration, and the number of sweep points across T was greater than 100. The duty cycles are as follows:

Test Mode	Duty Cycle	Duty Cycle Factor
GFSK	2.0%	-33.98

Note: Duty Cycle Factor = 20*log (Duty Cycle)

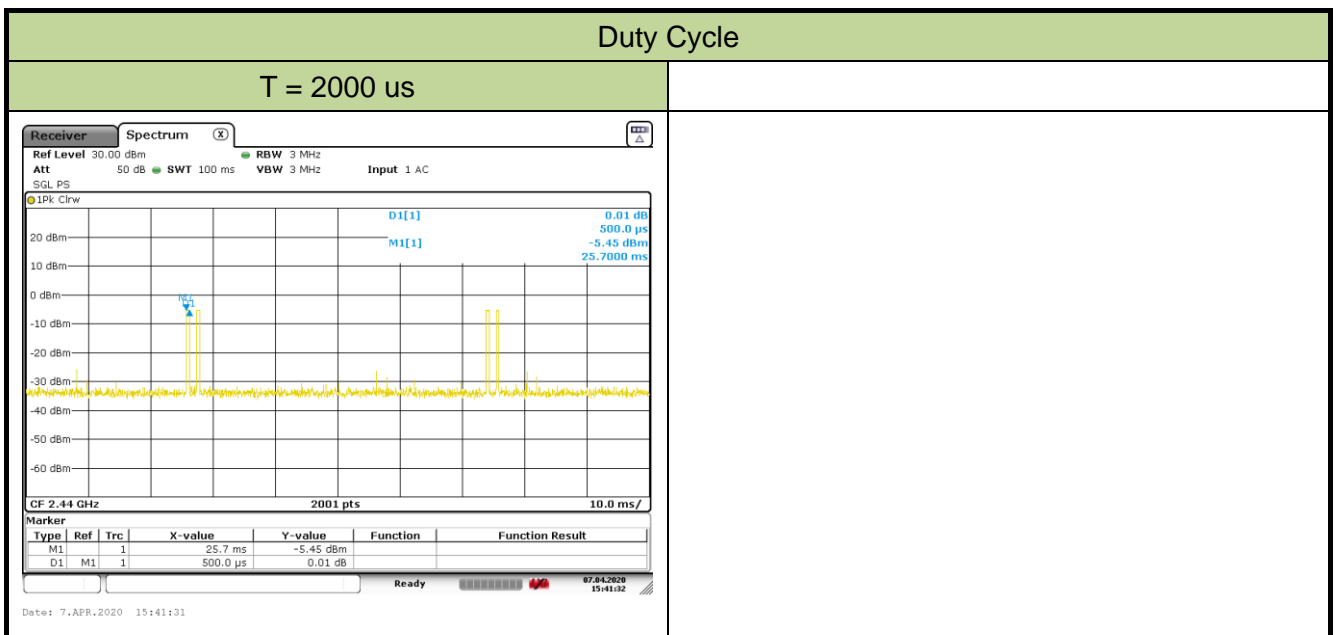

2.6. Test Configuration

The device was tested per the guidance of ANSI C63.10-2013. ANSI C63.10-2013 was used to reference the appropriate EUT setup for radiated spurious emissions testing and AC line conducted testing.

2.7. EMI Suppression Device(s)/Modifications

No EMI suppression device(s) were added and/or no modifications were made during testing.

2.8. Labeling Requirements

Per 2.1074 & 15.19; Docket 95-19

The label shall be permanently affixed at a conspicuous location on the device; instruction manual or pamphlet supplied to the user and be readily visible to the purchaser at the time of purchase. However, when the device is so small wherein placement of the label with specified statement is not practical, only the FCC ID must be displayed on the device per Section 15.19(a)(5). Please see attachment for FCC ID label and label location.

RSS-Gen Issue 5 Section 4

In addition to complying with the applicable RSSs and RSP-100, each unit of a product model (i.e. of a radio apparatus) shall meet the labelling requirements set out in this section prior to being marketed in Canada or imported into Canada.

For information regarding the labelling option, see Section 4.1, 4.2, 4.3 4.4. The label for the certified product represents the manufacturer's or importer's compliance with Innovation, Science and Economic Development Canada's (ISED) regulatory requirements.

Please see attachment for IC label and label location.

3. DESCRIPTION of TEST

3.1. Evaluation Procedure

The measurement procedures described in the American National Standard for Testing Unlicensed Wireless Devices (ANSI C63.10-2013), and the guidance was used in the measurement of the device.

3.2. AC Line Conducted Emissions

The line-conducted facility is located inside an 8'x4'x4' shielded enclosure. A 1m x 2m wooden table 80cm high is placed 40cm away from the vertical wall and 80cm away from the sidewall of the shielded room. Two 10kHz-30MHz, 50Ω/50uH Line-Impedance Stabilization Networks (LISNs) are bonded to the shielded room floor. Power to the LISNs is filtered by external high-current high-insertion loss power line filters. These filters attenuate ambient signal noise from entering the measurement lines. These filters are also bonded to the shielded enclosure.

The EUT is powered from one LISN and the support equipment is powered from the second LISN. All interconnecting cables more than 1 meter were shortened to a 1 meter length by non-inductive bundling (serpentine fashion) and draped over the back edge of the test table. All cables were at least 40cm above the horizontal reference ground-plane. Power cables for support equipment were routed down to the second LISN while ensuring that that cables were not draped over the second LISN.

Sufficient time for the EUT, support equipment, and test equipment was allowed in order for them to warm up to their normal operating condition. The RF output of the LISN was connected to the receiver and exploratory measurements were made to determine the frequencies producing the maximum emission from the EUT. The receiver was scanned from 150kHz to 30MHz. The detector function was set to peak mode for exploratory measurements while the bandwidth of the analyzer was set to 9kHz. The EUT, support equipment, and interconnecting cables were arranged and manipulated to maximize each emission. Each emission was also maximized by varying: power lines, the mode of operation or data exchange speed, or support equipment whichever determined the worst-case emission. Once the worst case emissions have been identified, the one EUT cable configuration/arrangement and mode of operation that produced these emissions are used for final measurements on the same test site. The analyzer is set to CISPR quasi-peak and average detectors with a 9kHz resolution bandwidth for final measurements.

An extension cord was used to connect to a single LISN which powered by EUT. The extension cord was calibrated with LISN, the impedance and insertion loss are compliance with the requirements as stated in ANSI C63.10-2013.

3.3. Radiated Emissions

The radiated test facilities consisted of an indoor 3 meter semi-anechoic chamber used for final measurements and exploratory measurements, when necessary. The measurement area is contained within the semi-anechoic chamber which is shielded from any ambient interference. For measurements above 1GHz absorbers are arranged on the floor between the turn table and the antenna mast in such a way so as to maximize the reduction of reflections. For measurements below 1GHz, the absorbers are removed. A MF Model 210SS turntable is used for radiated measurement. It is a continuously rotatable, remote controlled, metallic turntable and 2 meters (6.56 ft.) in diameter. The turn table is flush with the raised floor of the chamber in order to maintain its function as a ground plane. An 80cm high PVC support structure is placed on top of the turntable.

For all measurements, the spectrum was scanned through all EUT azimuths and from 1 to 4 meter receive antenna height using a broadband antenna from 30MHz up to the upper frequency shown in 15.33(b)(1) depending on the highest frequency generated or used in the device or on which the device operates or tunes. For frequencies above 1GHz, linearly polarized double ridge horn antennas were used. For frequencies below 30MHz, a calibrated loop antenna was used. When exploratory measurements were necessary, they were performed at 1 meter test distance inside the semi-anechoic chamber using broadband antennas, broadband amplifiers, and spectrum analyzers to determine the frequencies and modes producing the maximum emissions. Sufficient time for the EUT, support equipment, and test equipment was allowed in order for them to warm up to their normal operating condition. The test set-up for frequencies below 1GHz was placed on top of the 0.8 meter high, 1 x 1.5 meter table; and test set-up for frequencies 1-40GHz was placed on top of the 1.5 meter high, 1 x 1.5 meter table. The EUT, support equipment, and interconnecting cables were arranged and manipulated to maximize each emission. Appropriate precaution was taken to ensure that all emissions from the EUT were maximized and investigated. The system configuration, clock speed, mode of operation or video resolution, if applicable, turntable azimuth, and receive antenna height was noted for each frequency found.

Final measurements were made in the semi-anechoic chamber using calibrated, linearly polarized broadband and horn antennas. The test setup was configured to the setup that produced the worst case emissions. The spectrum analyzer was set to investigate all frequencies required for testing to compare the highest radiated disturbances with respect to the specified limits. The turntable containing the EUT was rotated through 360 degrees and the height of the receive antenna was varied 1 to 4 meters and stopped at the azimuth and height producing the maximum emission. Each emission was maximized by changing the orientation of the EUT through three orthogonal planes and changing the polarity of the receive antenna, whichever produced the worst-case emissions. According to 3dB Beam-Width of horn antenna, the horn antenna should be always directed to the EUT when rising height.

4. ANTENNA REQUIREMENTS

Excerpt from §15.203 of the FCC Rules/Regulations:

“An intentional radiator antenna shall be designed to ensure that no antenna other than that furnished by the responsible party can be used with the device. The use of a permanently attached antenna or of an antenna that uses a unique coupling to the intentional radiator shall be considered sufficient to comply with the provisions of this section.”

- The antenna of the device is permanently attached.
- There are no provisions for connection to an external antenna.

Conclusion:

The unit complies with the requirement of §15.203.

5. TEST EQUIPMENT CALIBRATION DATE

Conducted Emissions - SR2

Instrument	Manufacturer	Type No.	Asset No.	Cali. Interval	Cali. Due Date
EMI Test Receiver	R&S	ESR3	MRTSUE06185	1 year	2020/04/15
Two-Line V-Network	R&S	ENV 216	MRTSUE06002	1 year	2020/06/13
Two-Line V-Network	R&S	ENV 216	MRTSUE06003	1 year	2020/06/13
Thermohygrometer	Testo	608-H1	MRTSUE06404	1 year	2020/08/08
Shielding Room	MIX-BEP	Chamber-SR2	MRTSUE06215	N/A	N/A

Radiated Emissions - AC1

Instrument	Manufacturer	Type No.	Asset No.	Cali. Interval	Cali. Due Date
EMI Test Receiver	R&S	ESR7	MRTSUE06001	1 year	2020/08/01
PXA Signal Analyzer	Keysight	9030B	MRTSUE06395	1 year	2020/09/03
Loop Antenna	Schwarzbeck	FMZB 1519	MRTSUE06025	1 year	2020/11/10
Bilog Period Antenna	Schwarzbeck	VULB 9168	MRTSUE06172	1 year	2021/03/30
Broad Band Horn Antenna	Schwarzbeck	BBHA 9120D	MRTSUE06023	1 year	2020/10/13
Broad Band Horn Antenna	Schwarzbeck	BBHA 9170	MRTSUE06597	1 year	2020/12/17
Microwave System Amplifier	Agilent	83017A	MRTSUE06076	1 year	2020/11/15
Preamplifier	Schwarzbeck	BBV 9721	MRTSUE06121	1 year	2020/06/11
Thermohygrometer	Testo	608-H1	MRTSUE06403	1 year	2020/08/08
Anechoic Chamber	TDK	Chamber-AC1	MRTSUE06212	1 year	2020/04/30

Radiated Emission - AC2

Instrument	Manufacturer	Type No.	Asset No.	Cali. Interval	Cali. Due Date
Spectrum Analyzer	Keysight	N9038A	MRTSUE06125	1 year	2020/08/01
Loop Antenna	Schwarzbeck	FMZB 1519	MRTSUE06025	1 year	2020/11/10
Bilog Period Antenna	Schwarzbeck	VULB 9162	MRTSUE06022	1 year	2020/10/13
Horn Antenna	Schwarzbeck	BBHA9120D	MRTSUE06171	1 year	2020/10/27
Broad Band Horn Antenna	Schwarzbeck	BBHA 9170	MRTSUE06597	1 year	2020/12/17
Broadband Coaxial Preamplifier	Schwarzbeck	BBV 9718	MRTSUE06176	1 year	2020/11/15
Preamplifier	Schwarzbeck	BBV 9721	MRTSUE06121	1 year	2020/06/11
Temperature/Humidity Meter	Minggao	ETH529	MRTSUE06170	1 year	2020/12/15
Anechoic Chamber	RIKEN	Chamber-AC2	MRTSUE06213	1 year	2020/04/30

Conducted Test Equipment - TR3

Instrument	Manufacturer	Type No.	Asset No.	Cali. Interval	Cali. Due Date
EXA Signal Analyzer	Agilent	N9020A	MRTSUE06106	1 year	2020/04/15
EXA Signal Analyzer	Keysight	N9010B	MRTSUE06452	1 year	2020/07/11
Signal Analyzer	R&S	FSV40	MRTSUE06218	1 year	2020/04/15
Power Meter	Agilent	U2021XA	MRTSUE06030	1 year	2020/11/18
USB wideband power sensor	Keysight	U2021XA	MRTSUE06446	1 year	2020/06/30
USB wideband power sensor	Keysight	U2021XA	MRTSUE06447	1 year	2020/06/30
Bluetooth Test Set	Anritsu	MT8852B-042	MRTSUE06389	1 year	2020/06/13
Audio Analyzer	Agilent	U8903B	MRTSUE06143	1 year	2020/06/13
Modulation Analyzer	HP	8901A	MRTSUE06098	1 year	2020/10/10
Wideband Radio Communication Tester	R&S	CMW 500	MRTSUE06243	1 year	2020/11/07
DC Power Supply	GWINSTEK	DPS-3303C	MRTSUE06064	N/A	N/A
Temperature & Humidity Chamber	BAOYT	BYH-150CL	MRTSUE06051	1 year	2020/11/07
Thermohygrometer	testo	608-H1	MRTSUE06401	1 year	2020/08/08

Software	Version	Function
EMI Software	V3	EMI Test Software

6. MEASUREMENT UNCERTAINTY

Where relevant, the following test uncertainty levels have been estimated for tests performed on the EUT as specified in CISPR 16-4-2. This uncertainty represents an expanded uncertainty expressed at approximately the 95% confidence level using a coverage factor of $k = 2$.

Conducted Emission Measurement - SR2
<p>The maximum measurement uncertainty is evaluated as:</p> <p>9kHz~150kHz: 3.84dB</p> <p>150kHz~30MHz: 3.46dB</p>
Radiated Emission Measurement - AC1
<p>The maximum measurement uncertainty is evaluated as:</p> <p>Horizontal: 30MHz~300MHz: 4.07dB</p> <p style="padding-left: 40px;">300MHz~1GHz: 3.63dB</p> <p style="padding-left: 40px;">1GHz~18GHz: 4.16dB</p> <p>Vertical: 30MHz~300MHz: 4.18dB</p> <p style="padding-left: 40px;">300MHz~1GHz: 3.60dB</p> <p style="padding-left: 40px;">1GHz~18GHz: 4.76dB</p>
Radiated Emission Measurement - AC2
<p>The maximum measurement uncertainty is evaluated as:</p> <p>Horizontal: 30MHz~300MHz: 3.75dB</p> <p style="padding-left: 40px;">300MHz~1GHz: 3.53dB</p> <p style="padding-left: 40px;">1GHz~18GHz: 4.28dB</p> <p>Vertical: 30MHz~300MHz: 3.86dB</p> <p style="padding-left: 40px;">300MHz~1GHz: 3.53dB</p> <p style="padding-left: 40px;">1GHz~18GHz: 4.33dB</p>

7. TEST RESULT

7.1. Summary

FCC Section(s)	ISED Section(s)	Test Description	Test Limit	Test Condition	Test Result	Reference
15.247(a)(2)	RSS-247 [5.2]	6dB Bandwidth	$\geq 500\text{kHz}$	Conducted	Pass	Section 7.2
N/A	RSS-Gen [6.7]	99% Bandwidth	N/A		Pass	
15.247(b)(3)	RSS-247 [5.4(d)]	Output Power	$\leq 1\text{Watt}$ & $\text{EIRP} \leq 4\text{Watt}$		Pass	Section 7.3
15.247(e)	RSS-247 [5.2]	Power Spectral Density	$\leq 8\text{dBm}/3\text{kHz}$ (Average)		Pass	Section 7.4
15.247(d)	RSS-247 [5.5]	Band Edge / Out-of-Band Emissions	30dBc		Pass	Section 7.5
15.205 15.209	RSS-247 [5.5]	General Field Strength Limits (Restricted Bands and Radiated Emission Limits)	Emissions in restricted bands must meet the radiated limits detailed in 15.209	Radiated	Pass	Section 7.6 & 7.7
15.207	RSS-Gen [8.8]	AC Conducted Emissions 150kHz - 30MHz	$< \text{FCC } 15.207$ limits	Line Conducted	N/A	Section 7.8

Notes:

- 1) All modes of operation and data rates were investigated. For radiated emission test, every axis (X, Y, Z) was also verified. The test results shown in the following sections represent the worst case emissions.
- 2) The analyzer plots shown in this section were all taken with a correction table loaded into the analyzer. The correction table was used to account for the losses of the cables and attenuators used as part of the system to connect the EUT to the analyzer at all frequencies of interest.
- 3) "N/A" means that the test item is not applicable, and the details information refer to relevant section.

7.2. 6dB & 99% Bandwidth Measurement

7.2.1. Test Limit

The minimum 6dB bandwidth shall be at least 500 kHz.

7.2.2. Test Procedure used

ANSI C63.10-2013 - Section 11.8 (6dB bandwidth)

ANSI C63.10-2013 - Section 6.9.3 (99% bandwidth)

7.2.3. Test Setting

For 6dB bandwidth

1. The Spectrum's automatic bandwidth measurement capability was used to perform the 6dB bandwidth measurement. The "X" dB bandwidth parameter was set to $X = 6$. The bandwidth measurement was not influenced by any intermediate power nulls in the fundamental emission.
2. Set RBW = 100 kHz
3. $VBW \geq 3 \times RBW$
4. Detector = Peak
5. Trace mode = Max hold
6. Sweep = Auto couple
7. Allow the trace was allowed to stabilize

For 99% bandwidth

1. Span = 1.5 times to 5 times the OBW
2. Set RBW = 1% to 5% the OBW
3. $VBW \geq 3 \times RBW$
4. Detector = Peak
5. Trace mode = Max hold
6. Sweep = Auto couple
7. Allow the trace was allowed to stabilize

7.2.4. Test Setup

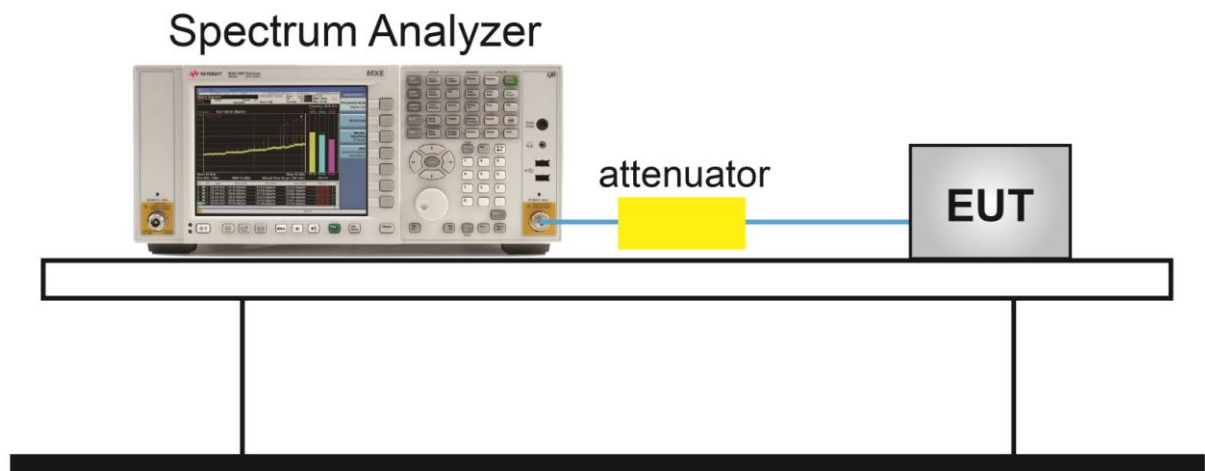

7.2.5. Test Result

Product	SLT3 3CH TX	Temperature	25°C
Test Engineer	Dandy Li	Relative Humidity	52%
Test Site	TR3	Test Date	2020/04/02

Test Mode	Channel No.	Frequency (MHz)	6dB Bandwidth (kHz)	Limit (kHz)	99% Bandwidth (kHz)	Result
GFSK	01	2403	505.4	≥ 500	510.7	Pass
GFSK	38	2440	741.3	≥ 500	2749.8	Pass
GFSK	74	2476	505.8	≥ 500	624.4	Pass
GFSK	75	2480	505.1	≥ 500	484.2	Pass

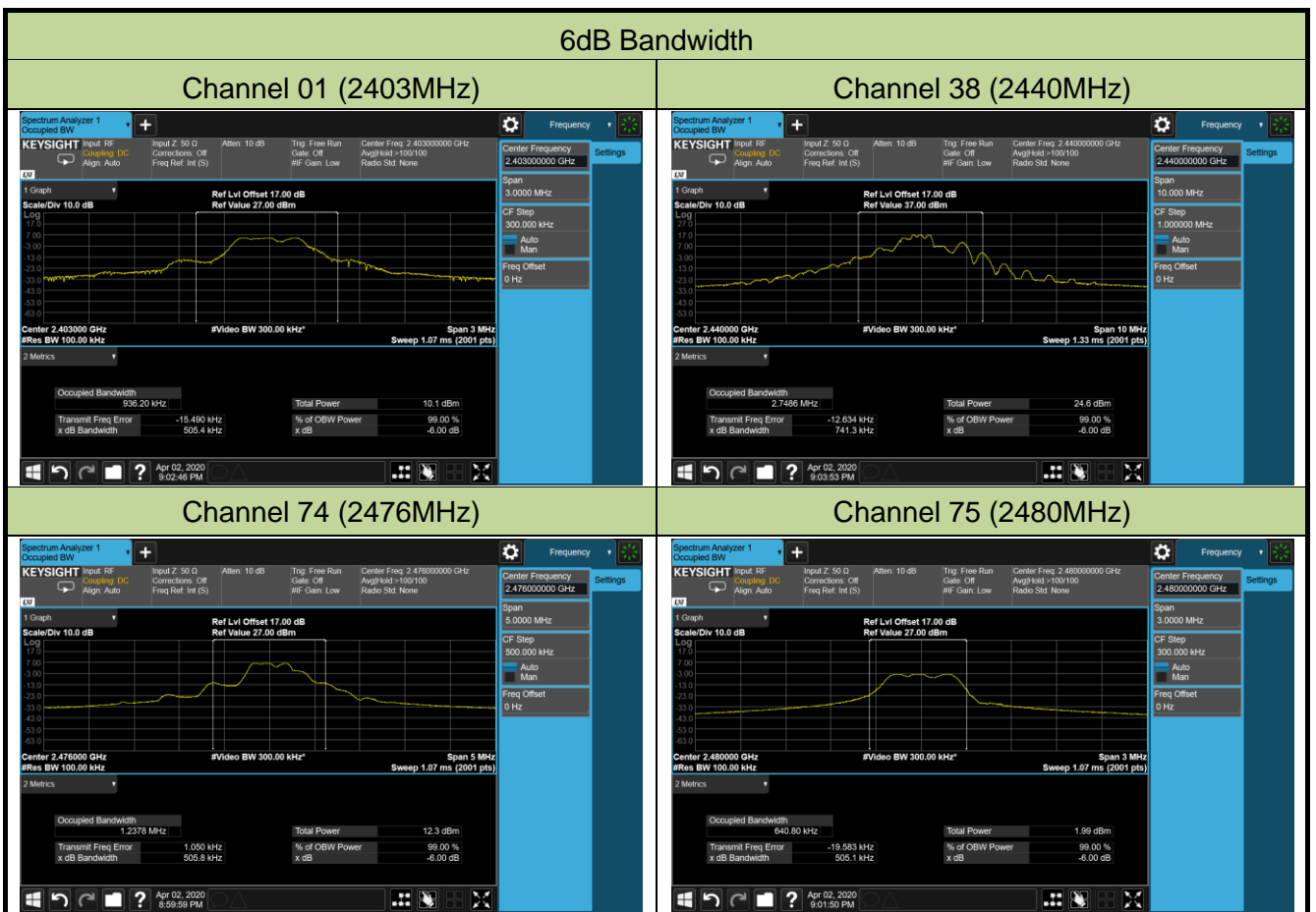

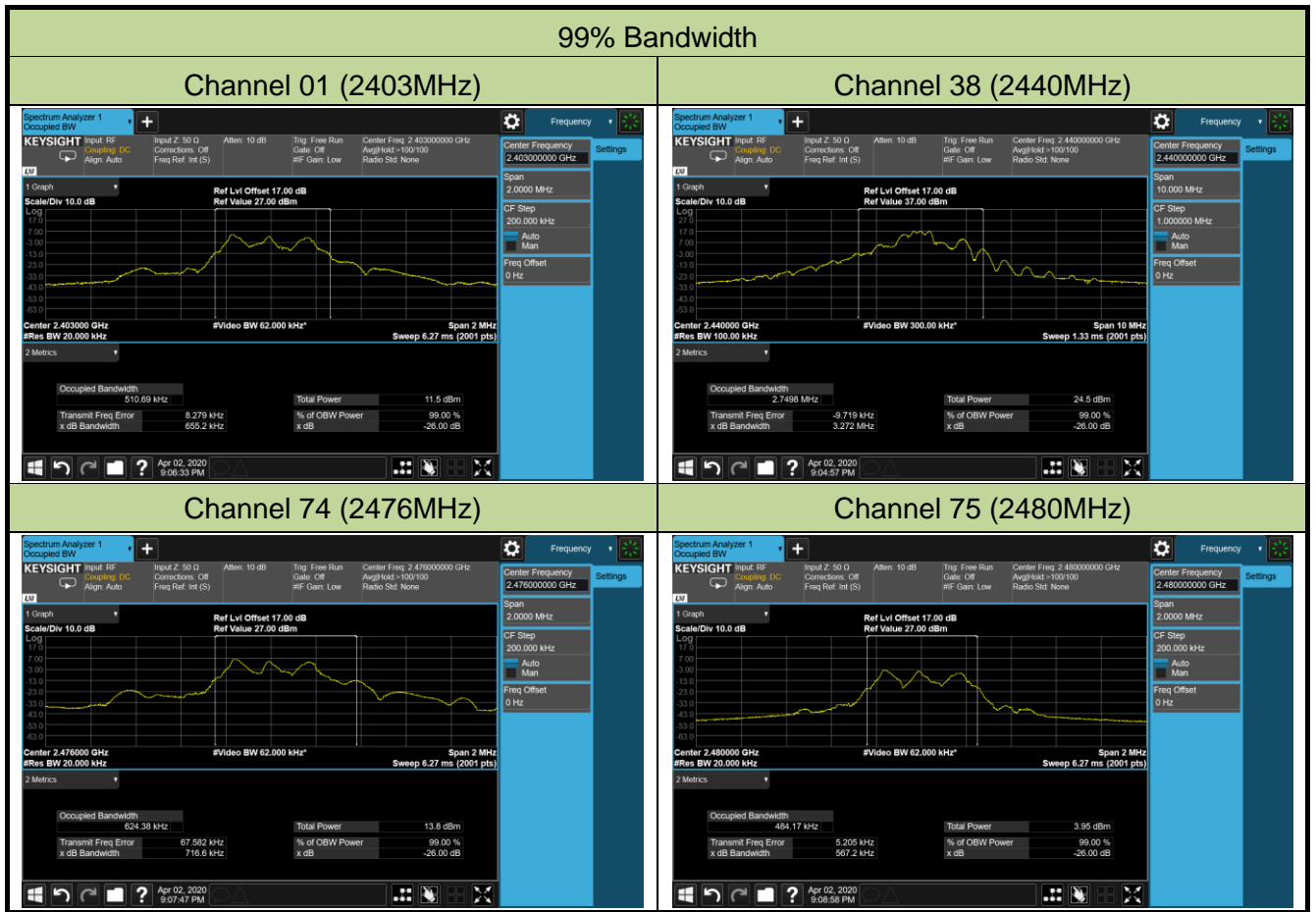

7.3. Output Power Measurement

7.3.1. Test Limit

The maximum out power shall be less 1 Watt (30dBm) and the E.I.R.P shall not exceed 4 Watt (36.02dBm).

The conducted output power limit specified in paragraph FCC Part 15.247(b) of this section is based on the use of antennas with directional gains that do not exceed 6 dBi. If transmitting antennas of directional gain greater than 6 dBi are used, the conducted output power from the intentional radiator shall be reduced below the stated values in paragraphs FCC Part 15.247(b)(3) of this section, as appropriate, by the amount in dB that the directional gain of the antenna exceeds 6 dBi.

7.3.2. Test Procedure Used

ANSI C63.10 Section 11.9.2.3

7.3.3. Test Setting

Method AVGPM-G (Measurement using a gated RF average-reading power meter)

Measurements may be performed using a wideband gated RF power meter provided that the gate parameters are adjusted such that the power is measured only when the EUT is transmitting at its maximum power control level. Since this measurement is made only during the ON time of the transmitter, no duty cycle correction is required.

7.3.4. Test Setup

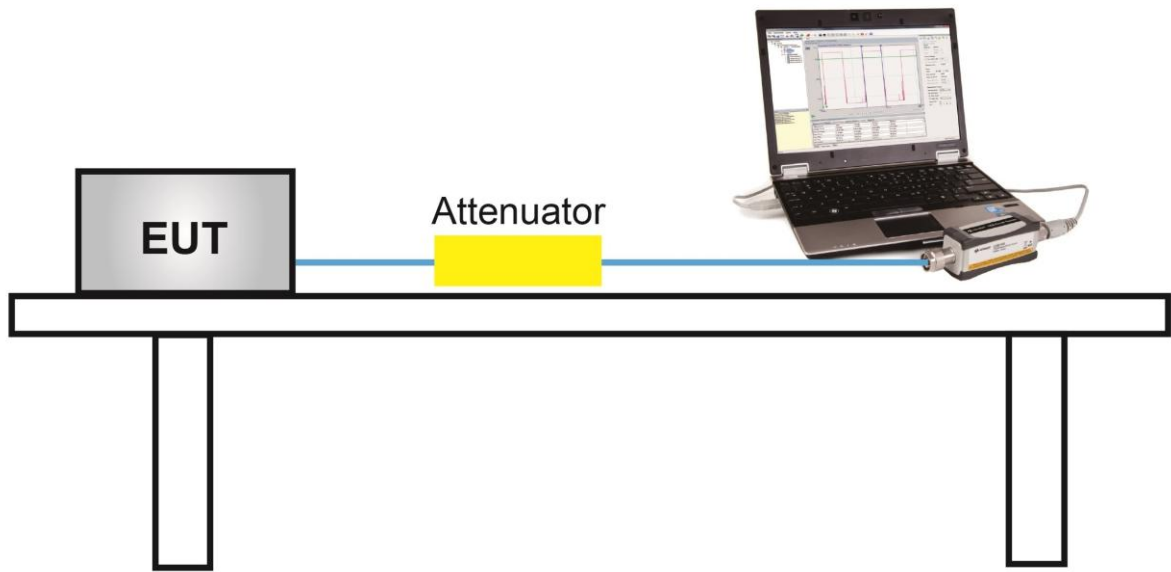

7.3.5. Test Result

Product	SLT3 3CH TX	Temperature	23°C
Test Engineer	Dandy Li	Relative Humidity	51%
Test Site	TR3	Test Date	2020/03/28

Test Mode	Channel No.	Freq. (MHz)	Average Power (dBm)	Limit (dBm)	Max EIRP (dBm)	EIRP Limit (dBm)	Result
GFSK	01	2403	6.34	≤ 30.00	8.34	≤ 36.02	Pass
GFSK	38	2440	14.25	≤ 30.00	16.25	≤ 36.02	Pass
GFSK	74	2476	7.80	≤ 30.00	9.80	≤ 36.02	Pass
GFSK	75	2480	-1.99	≤ 30.00	0.01	≤ 36.02	Pass

Note: Max EIRP (dBm) = Average Power (dBm) + Antenna Gain (dBi), Antenna Gain = 2dBi.

7.4. Power Spectral Density Measurement

7.4.1. Test Limit

The maximum permissible power spectral density is 8dBm in any 3 kHz band.

The same method of determining the conducted output power shall be used to determine the power spectral density.

7.4.2. Test Procedure Used

ANSI C63.10 Section 11.10.5

7.4.3. Test Setting

1. Measure the duty cycle (x) of the transmitter output signal.
2. Set instrument center frequency to DTS channel center frequency.
3. Set span to at least 1.5 times the OBW.
4. RBW = 10 kHz.
5. VBW = 30 kHz.
6. Detector = RMS.
7. Ensure that the number of measurement points in the sweep $\geq 2 \times \text{span}/\text{RBW}$.
8. Sweep time = auto couple.
9. Don't use sweep triggering. Allow sweep to "free run".
10. Employ trace averaging (RMS) mode over a minimum of 100 traces.
11. Use the peak marker function to determine the maximum amplitude level.
12. Add $10 \log (1/x)$, where x is the duty cycle measured in step (a), to the measured PSD to compute the average PSD during the actual transmission time.

7.4.4. Test Setup

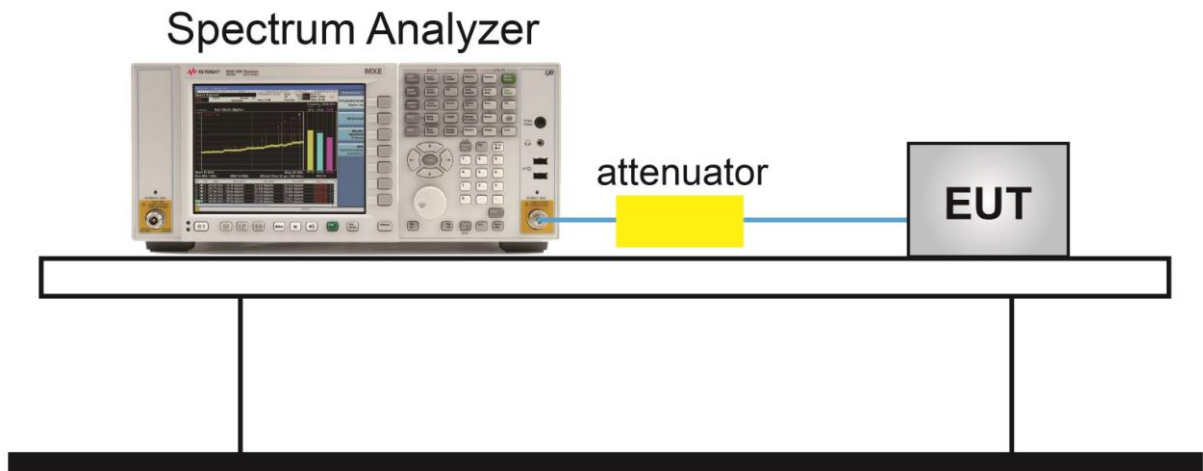

7.4.5. Test Result

Product	SLT3 3CH TX	Temperature	23°C
Test Engineer	Dandy Li	Relative Humidity	52%
Test Site	TR3	Test Date	2020/03/28

Test Mode	Channel No.	Freq. (MHz)	AVGPSD (dBm/10kHz)	Duty Cycle (%)	Final AVGPSD (dBm / 3kHz)	Limit (dBm/3kHz)	Result
GFSK	01	2403	-8.79	2.0	2.97	≤ 8.00	Pass
GFSK	38	2440	-4.30	2.0	7.46	≤ 8.00	Pass
GFSK	74	2476	-6.73	2.0	5.03	≤ 8.00	Pass
GFSK	75	2480	-18.20	2.0	-6.44	≤ 8.00	Pass

Note: Final AVGPSD (dBm / 3kHz) = AVGPSD (dBm / 10kHz) + 10*Log(3/10)+ 10*log (1/Duty Cycle).

Power Spectral Density

Channel 01 (2403MHz)



Channel 38 (2440MHz)



Channel 74 (2476MHz)



Channel 75 (2480MHz)



7.5. Conducted Band Edge and Out-of-Band Emissions

7.5.1. Test Limit

The limit for out-of-band spurious emissions at the band edge is 30dB below the fundamental emission level, as determined from the in-band power measurement of the DTS channel performed in a 100 kHz bandwidth per the PSD procedure.

7.5.2. Test Procedure Used

ANSI C63.10 Section 11.11

7.5.3. Test Setting

Reference level measurement

1. Set instrument center frequency to DTS channel center frequency
2. Set the span to ≥ 1.5 times the DTS bandwidth
3. Set the RBW = 100 kHz
4. Set the VBW $\geq 3 \times$ RBW
5. Detector = peak
6. Sweep time = auto couple
7. Trace mode = max hold
8. Allow trace to fully stabilize

Emission level measurement

1. Set the center frequency and span to encompass frequency range to be measured
2. RBW = 100kHz
3. VBW = 300kHz
4. Detector = Peak
5. Trace mode = max hold
6. Sweep time = auto couple
7. The trace was allowed to stabilize

Test Notes

1. RBW was set to 1.3MHz rather than 100 kHz in order to increase the measurement speed.
2. The display line shown in the following plots denotes the limit at 30dB below the fundamental emission level measured in a 100 kHz bandwidth. However, since the traces in the following plots are measured with a 1.3MHz RBW, the display line may not necessarily appear to be 30dB below the level of the fundamental in a 1.3MHz bandwidth.
3. For plots showing conducted spurious emissions near the limit, the frequencies were investigated with a reduced RBW to ensure that no emissions were present

7.5.4. Test Setup

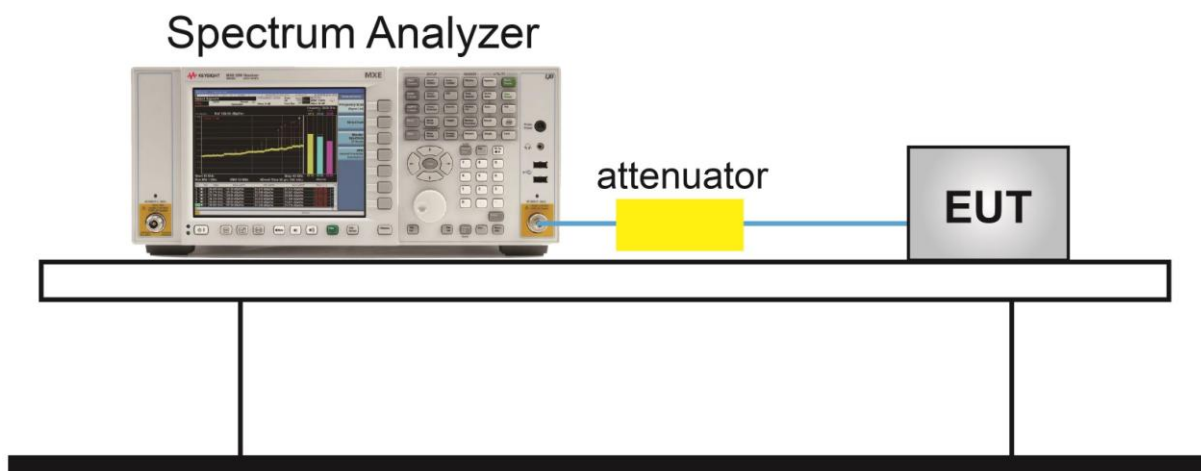

7.5.5. Test Result

Product	SLT3 3CH TX	Temperature	23°C
Test Engineer	Dandy Li	Relative Humidity	52%
Test Site	TR3	Test Date	2020/03/28

Test Mode	Channel No.	Frequency (MHz)	Limit	Result
GFSK	01	2403	30dBc	Pass
GFSK	38	2440	30dBc	Pass
GFSK	74	2476	30dBc	Pass
GFSK	75	2480	30dBc	Pass

Out-of-Band Emissions Channel 01 (2403MHz)

100kHz PSD reference Level

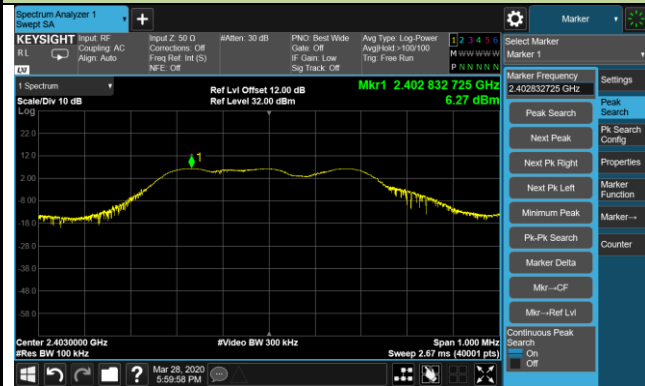

Low Band Edge

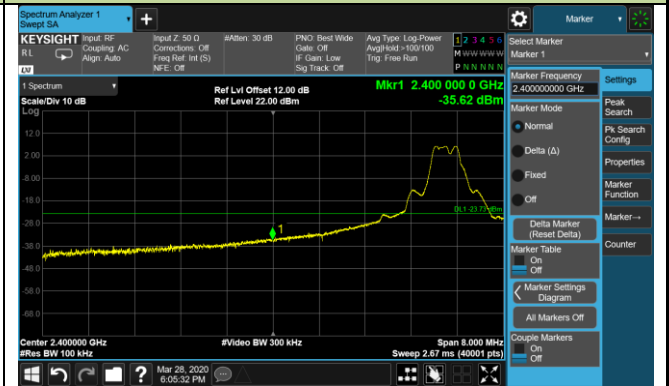

Spurious Emission



--

--

Out-of-Band Emissions Channel 38 (2440MHz)

100kHz PSD reference Level

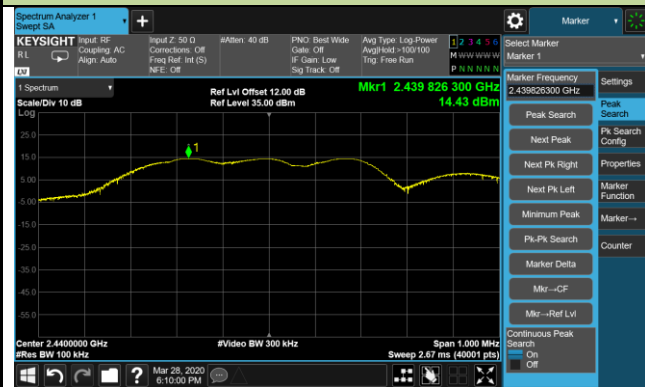

Spurious Emission

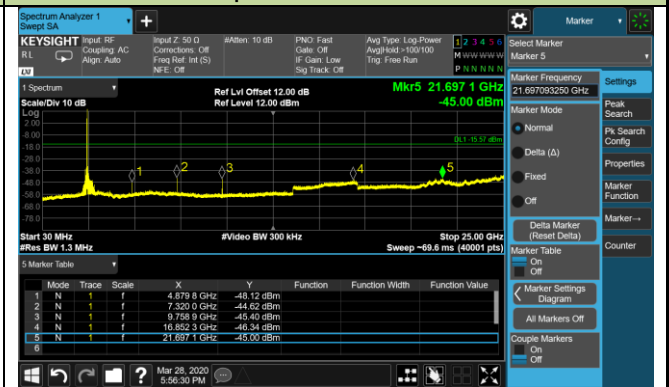

Channel 74 (2476MHz)

100kHz PSD reference Level

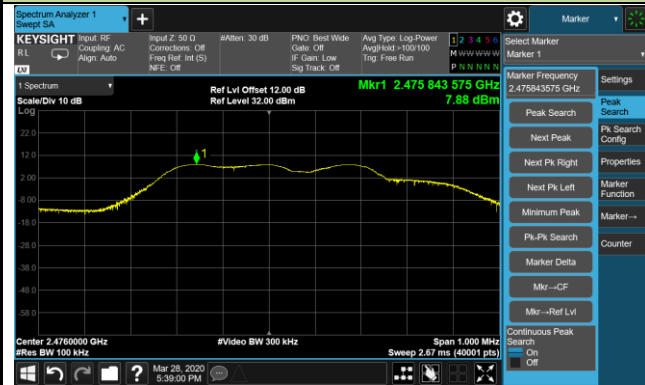

High Band Edge

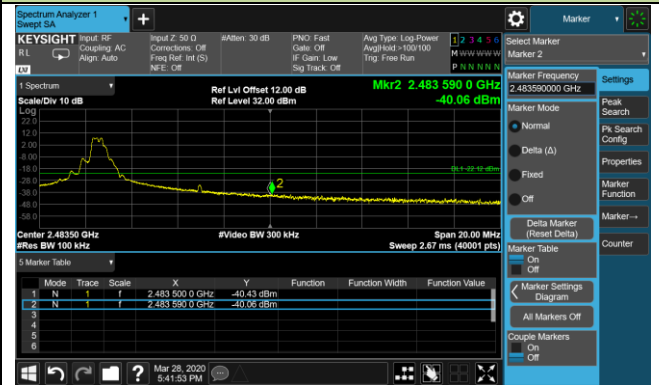

Spurious Emission



--

--

Channel 75 (2480MHz)

100kHz PSD reference Level

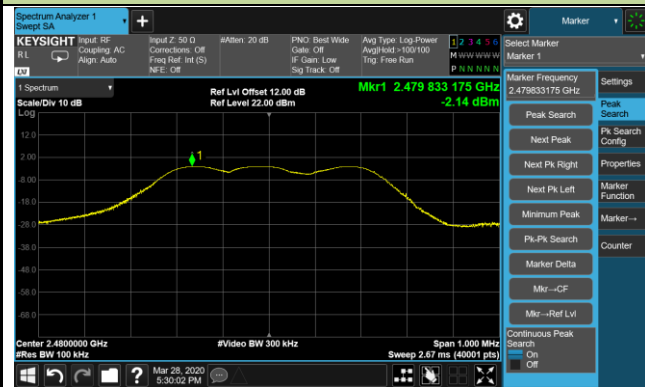

High Band Edge

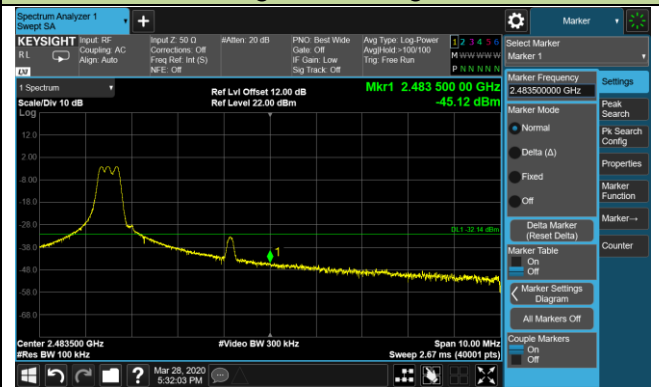

Spurious Emission

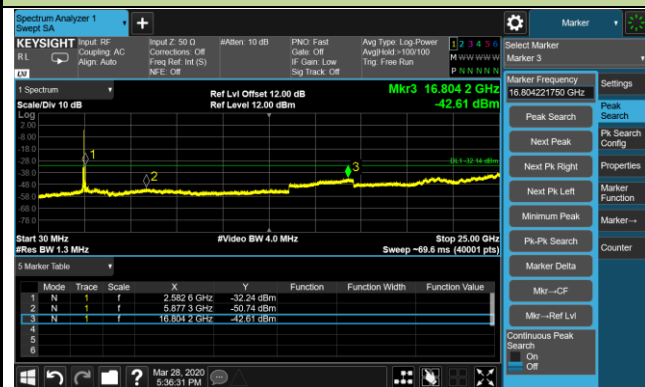

--

--

7.6. Radiated Spurious Emission Measurement

7.6.1. Test Limit

All out of band emissions appearing in a restricted band as specified in Section 15.205 of the Title 47 CFR and in Section 8.10 of the RSS-Gen Issue 5 must not exceed the limits shown in Table.

FCC Part 15 Subpart C Paragraph 15.209 & RSS-Gen Section 8.9		
Frequency [MHz]	Field Strength [uV/m]	Measured Distance [Meters]
0.009 - 0.490	2400/F (kHz)	300
0.490 - 1.705	24000/F (kHz)	30
1.705 - 30	30	30
30 - 88	100	3
88 - 216	150	3
216 - 960	200	3
Above 960	500	3

7.6.2. Test Procedure Used

ANSI C63.10 Section 6.3 (General Requirements)

ANSI C63.10 Section 6.4 (Standard test method below 30MHz)

ANSI C63.10 Section 6.5 (Standard test method above 30MHz to 1GHz)

ANSI C63.10 Section 6.6 (Standard test method above 1GHz)

7.6.3. Test Setting

Table 1 - RBW as a function of frequency

Frequency	RBW
9 ~ 150 kHz	200 ~ 300 Hz
0.15 ~ 30 MHz	9 ~ 10 kHz
30 ~ 1000 MHz	100 ~ 120 kHz
> 1000MHz	1MHz

Quasi-Peak Measurements below 1GHz

1. Analyzer center frequency was set to the frequency of the radiated spurious emission of interest
2. Span was set greater than 1MHz
3. RBW = as specified in Table 1
4. Detector = CISPR quasi-peak or average
5. Sweep time = auto couple
6. Trace was allowed to stabilize

Peak Measurements above 1GHz

1. Analyzer center frequency was set to the frequency of the radiated spurious emission of interest
2. RBW = 1MHz
3. VBW = 3MHz
4. Detector = peak
5. Sweep time = auto couple
6. Trace mode = max hold
7. Trace was allowed to stabilize

Average Measurements above 1GHz (Method VB)

1. Analyzer center frequency was set to the frequency of the radiated spurious emission of interest
2. RBW = 1MHz
3. VBW; If the EUT is configured to transmit with duty cycle $\geq 98\%$, set VBW = 10 Hz.
If the EUT duty cycle is $< 98\%$, set VBW $\geq 1/T$. T is the minimum transmission duration.
4. Detector = Peak
5. Sweep time = auto
6. Trace mode = max hold
7. Trace was allowed to stabilize

7.6.4. Test Setup

Below 1GHz Test Setup:

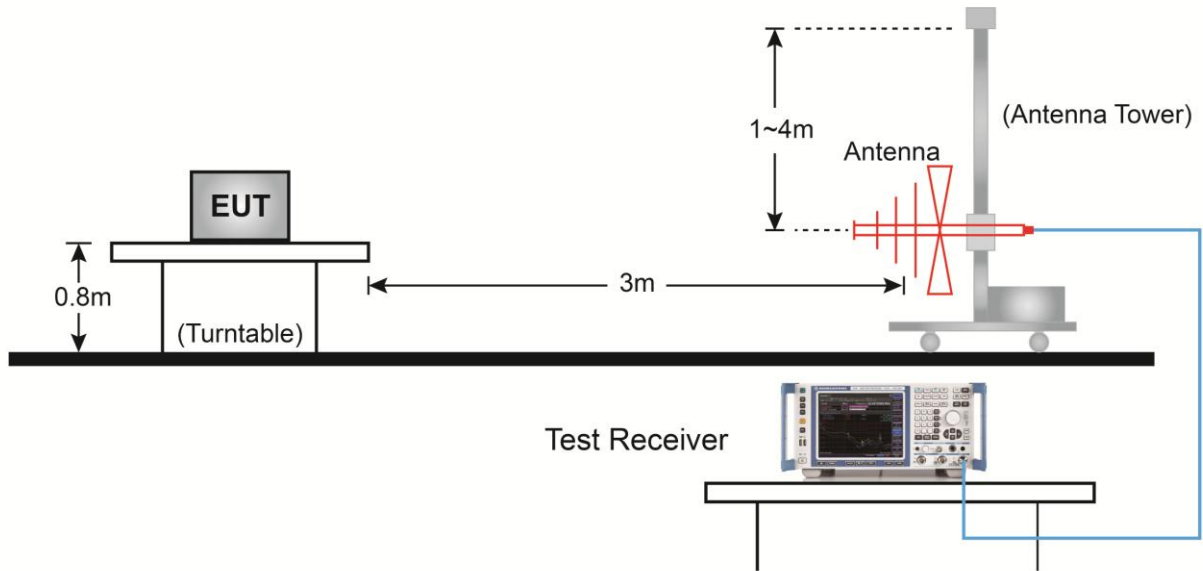

Above 1GHz Test Setup:

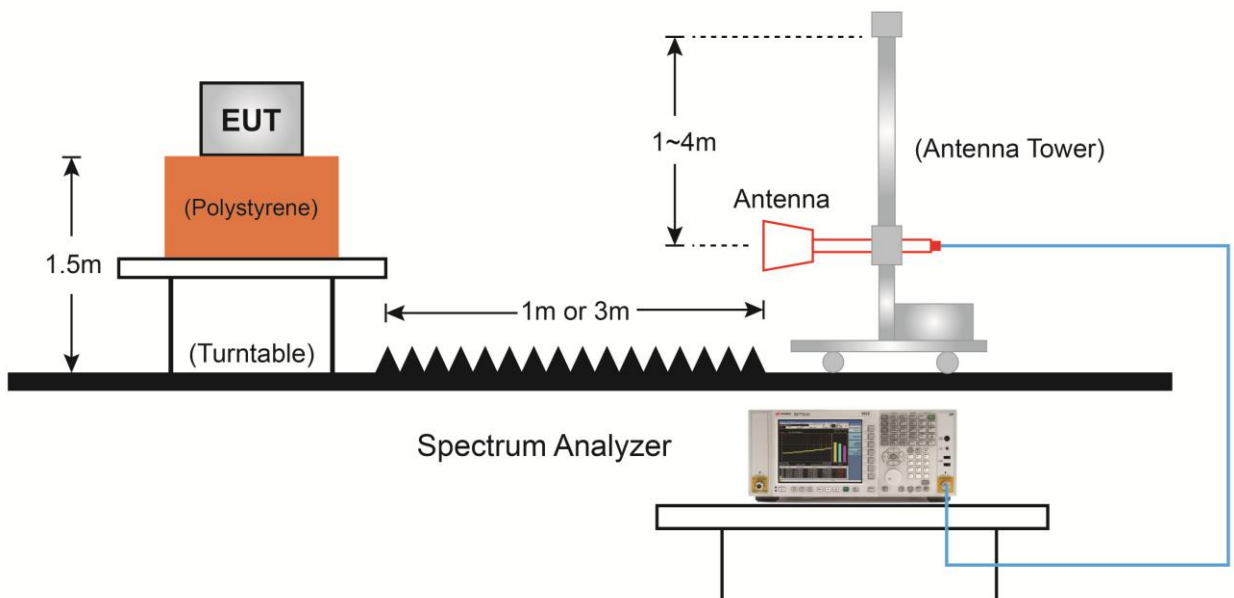

7.6.5. Test Result

Product	SLT3 3CH TX	Temperature	26°C
Test Engineer	Messiah Li	Relative Humidity	56%
Test Site	AC1	Test Date	2020/03/21
Test Mode:	GFSK	Test Channel:	01
Remark:	1. Average measurement was not performed if peak level lower than average limit (54dB μ V/m). 2. Other frequency was 20dB below limit line within 1-18GHz, there is not show in the report.		

Mark	Frequency (MHz)	Reading Level (dB μ V)	Factor (dB)	Measure Level (dB μ V/m)	Limit (dB μ V/m)	Margin (dB)	Detector	Polarization
	4085.5	37.4	3.3	40.7	74.0	-33.3	Peak	Horizontal
	4833.5	35.9	6.0	41.9	74.0	-32.1	Peak	Horizontal
*	6236.0	35.6	8.3	43.9	74.0	-30.1	Peak	Horizontal
*	7111.5	34.7	11.3	46.0	74.0	-28.0	Peak	Horizontal
	4094.0	35.8	3.4	39.2	74.0	-34.8	Peak	Vertical
	4808.0	41.9	5.8	47.7	74.0	-26.3	Peak	Vertical
*	6584.5	34.4	9.8	44.2	74.0	-29.8	Peak	Vertical
*	8667.0	36.8	13.8	50.6	74.0	-23.4	Peak	Vertical

Note 1: "*" is not in restricted band, its limit is 30dBc of the fundamental emission level (102.8dB μ V/m) or 15.209 which is higher.

Note 2: Peak Measure Level (dB μ V/m) = Reading Level (dB μ V) + Factor (dB)

Factor (dB) = Cable Loss (dB) + Antenna Factor (dB/m) - Pre Amplifier Gain (dB)

Note 3: Average measurement was not performed when the peak level lower than average limit.

Product	SLT3 3CH TX	Temperature	26°C
Test Engineer	Messiah Li	Relative Humidity	56%
Test Site	AC1	Test Date	2020/03/21
Test Mode:	GFSK	Test Channel:	38
Remark:	1. Average measurement was not performed if peak level lower than average limit (54dB μ V/m). 2. Other frequency was 20dB below limit line within 1-18GHz, there is not show in the report.		

Mark	Frequency (MHz)	Reading Level (dB μ V)	Factor (dB)	Measure Level (dB μ V/m)	Limit (dB μ V/m)	Margin (dB)	Detector	Polarization
	4876.0	47.2	5.9	53.1	74.0	-20.9	Peak	Horizontal
	7315.5	37.1	11.6	48.7	74.0	-25.3	Peak	Horizontal
*	8862.5	36.1	14.4	50.5	78.7	-28.2	Peak	Horizontal
*	9763.5	37.9	16.7	54.6	78.7	-24.1	Peak	Horizontal
	4876.0	48.7	5.9	54.6	74.0	-19.4	Peak	Vertical
	7494.0	36.0	11.8	47.8	74.0	-26.2	Peak	Vertical
*	8675.5	35.5	13.8	49.3	78.7	-29.4	Peak	Vertical
*	9755.0	41.8	16.7	58.5	78.7	-20.2	Peak	Vertical

Note 1: "*" is not in restricted band, its limit is 30dBc of the fundamental emission level (108.7dB μ V/m) or 15.209 which is higher.

Note 2: Peak Measure Level (dB μ V/m) = Reading Level (dB μ V) + Factor (dB)

Factor (dB) = Cable Loss (dB) + Antenna Factor (dB/m) - Pre Amplifier Gain (dB)

Note 3: Average measurement was not performed when the peak level lower than average limit.

Product	SLT3 3CH TX	Temperature	26°C
Test Engineer	Messiah Li	Relative Humidity	56%
Test Site	AC1	Test Date	2020/03/21
Test Mode:	GFSK	Test Channel:	74
Remark:	1. Average measurement was not performed if peak level lower than average limit (54dB μ V/m). 2. Other frequency was 20dB below limit line within 1-18GHz, there is not show in the report.		

Mark	Frequency (MHz)	Reading Level (dB μ V)	Factor (dB)	Measure Level (dB μ V/m)	Limit (dB μ V/m)	Margin (dB)	Detector	Polarization
	4009.0	37.8	3.3	41.1	74.0	-32.9	Peak	Horizontal
	4952.5	37.2	6.2	43.4	74.0	-30.6	Peak	Horizontal
*	6678.0	35.6	9.7	45.3	74.0	-28.7	Peak	Horizontal
*	10137.5	32.6	16.8	49.4	74.0	-24.6	Peak	Horizontal
	3864.5	37.3	2.9	40.2	74.0	-33.8	Peak	Vertical
	4952.5	38.5	6.2	44.7	74.0	-29.3	Peak	Vertical
*	7953.0	36.2	12.5	48.7	74.0	-25.3	Peak	Vertical
*	10384.0	35.2	17.6	52.8	74.0	-21.2	Peak	Vertical

Note 1: "*" is not in restricted band, its limit is 30dBc of the fundamental emission level (102.2dB μ V/m) or 15.209 which is higher.

Note 2: Peak Measure Level (dB μ V/m) = Reading Level (dB μ V) + Factor (dB)

Factor (dB) = Cable Loss (dB) + Antenna Factor (dB/m) - Pre Amplifier Gain (dB)

Note 3: Average measurement was not performed when the peak level lower than average limit.

Product	SLT3 3CH TX	Temperature	26°C
Test Engineer	Messiah Li	Relative Humidity	56%
Test Site	AC1	Test Date	2020/03/21
Test Mode:	GFSK	Test Channel:	75
Remark:	1. Average measurement was not performed if peak level lower than average limit (54dB μ V/m). 2. Other frequency was 20dB below limit line within 1-18GHz, there is not show in the report.		

Mark	Frequency (MHz)	Reading Level (dB μ V)	Factor (dB)	Measure Level (dB μ V/m)	Limit (dB μ V/m)	Margin (dB)	Detector	Polarization
	4068.5	38.1	3.4	41.5	74.0	-32.5	Peak	Horizontal
	4825.0	36.9	6.1	43.0	74.0	-31.0	Peak	Horizontal
*	5879.0	35.9	7.6	43.5	74.0	-30.5	Peak	Horizontal
*	6967.0	36.6	10.5	47.1	74.0	-26.9	Peak	Horizontal
	4094.0	37.6	3.4	41.0	74.0	-33.0	Peak	Vertical
	4825.0	36.7	6.1	42.8	74.0	-31.2	Peak	Vertical
*	5913.0	35.5	7.9	43.4	74.0	-30.6	Peak	Vertical
*	6661.0	36.8	9.7	46.5	74.0	-27.5	Peak	Vertical

Note 1: "*" is not in restricted band, its limit is 30dBc of the fundamental emission level (92.5dB μ V/m) or 15.209 which is higher.

Note 2: Peak Measure Level (dB μ V/m) = Reading Level (dB μ V) + Factor (dB)

Factor (dB) = Cable Loss (dB) + Antenna Factor (dB/m) - Pre Amplifier Gain (dB)

Note 3: Average measurement was not performed when the peak level lower than average limit.

The worst case of Radiated Emission below 1GHz:

Site: AC1	Time: 2020/03/31 - 14:50
Limit: FCC_Part15.209_RE(3m)	Engineer: David Lv
Probe: VULB 9168_20-2000MHz	Polarity: Horizontal
EUT: SLT3 3CH TX	Power: By Battery
Test Mode: Transmit at channel 38 (2440MHz).	

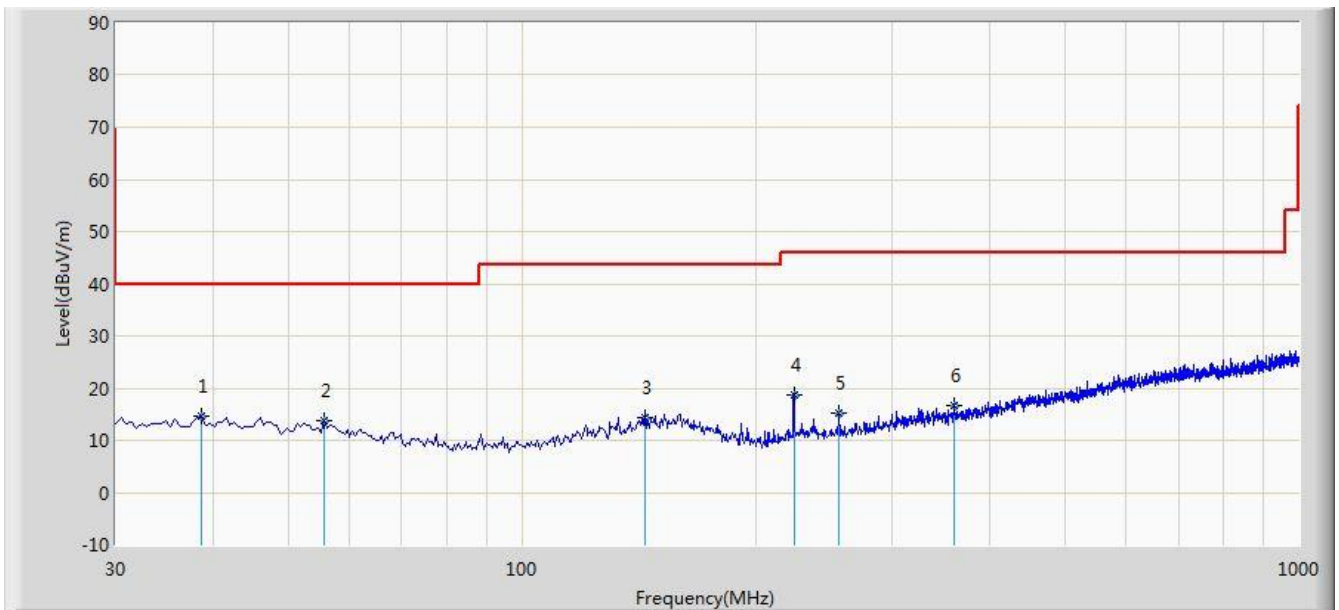

No	Flag	Mark	Frequency (MHz)	Measure Level (dBuV/m)	Reading Level (dBuV)	Margin (dB)	Limit (dBuV/m)	Factor (dB)	Type
1		*	38.729	14.556	-1.982	-25.444	40.000	14.422	QP
2			55.681	13.689	-1.984	-26.311	40.000	13.724	QP
3			143.845	14.402	-1.584	-29.098	43.500	14.816	QP
4			224.015	18.711	4.351	-27.289	46.000	12.197	QP
5			256.008	15.229	0.120	-30.771	46.000	13.105	QP
6			359.751	16.658	-0.851	-29.342	46.000	15.702	QP

Note 1: Measure Level (dB μ V/m) = Reading Level (dB μ V) + Factor (dB)

Factor (dB) = Cable Loss (dB) + Antenna Factor (dB/m)

Note 2: The amplitude of radiated emissions (frequency range from 9kHz ~ 30MHz, 18GHz to 40GHz) is that proximity to ambient noise, which also are attenuated more than 20 dB below the permissible value. Therefore, the data is not presented in the report.

Site: AC1	Time: 2020/03/31 - 14:55
Limit: FCC_Part15.209_RE(3m)	Engineer: David Lv
Probe: VULB 9168_20-2000MHz	Polarity: Vertical
EUT: SLT3 3CH TX	Power: By Battery
Test Mode: Transmit at channel 38 (2440MHz).	

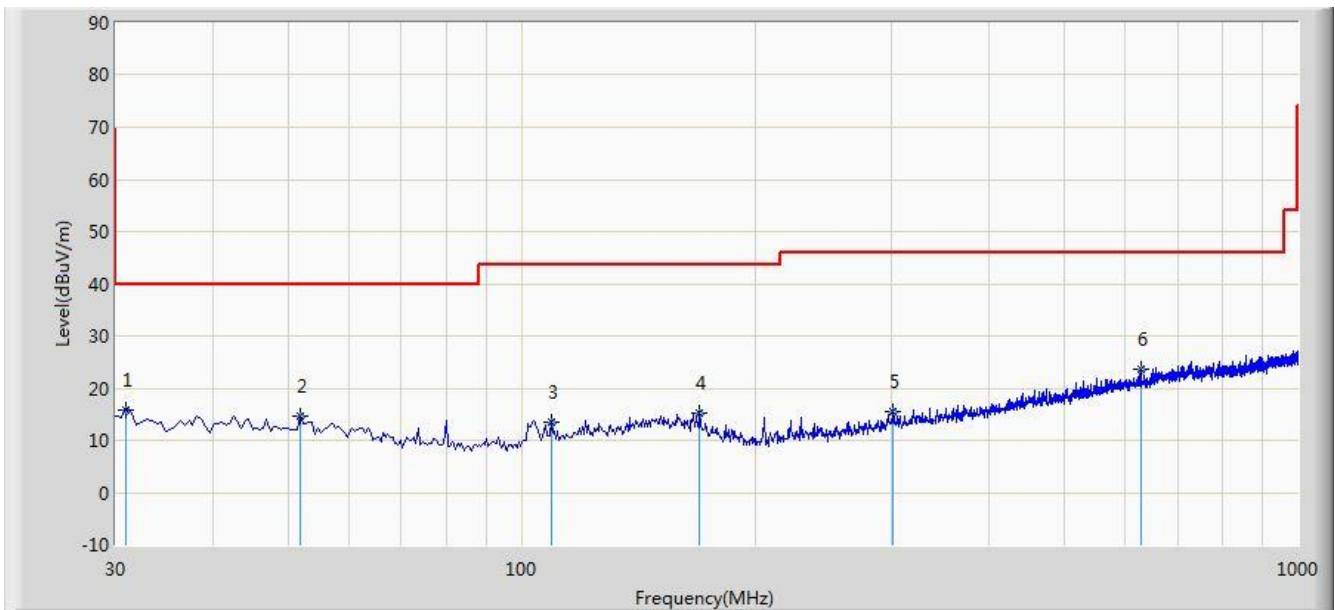

No	Flag	Mark	Frequency (MHz)	Measure Level (dBuV/m)	Reading Level (dBuV)	Margin (dB)	Limit (dBuV/m)	Factor (dB)	Type
1			30.918	15.884	0.181	-24.116	40.000	13.706	QP
2			51.813	14.609	-1.591	-25.391	40.000	14.012	QP
3			109.517	13.548	-0.942	-29.952	43.500	12.002	QP
4			169.618	15.143	-0.842	-28.357	43.500	14.357	QP
5			301.105	15.627	-0.561	-30.373	46.000	14.366	QP
6		*	628.004	23.664	0.518	-22.336	46.000	21.130	QP

Note 1: Measure Level (dB μ V/m) = Reading Level (dB μ V) + Factor (dB)

Factor (dB) = Cable Loss (dB) + Antenna Factor (dB/m)

Note 2: The amplitude of radiated emissions (frequency range from 9kHz ~ 30MHz, 18GHz to 40GHz) is that proximity to ambient noise, which also are attenuated more than 20 dB below the permissible value. Therefore, the data is not presented in the report.

7.7. Radiated Restricted Band Edge Measurement

7.7.1. Test Limit

For 15.205 requirement:

Radiated emissions which fall in the restricted bands, as defined in Section 15.205(a) of FCC part 15, must also comply with the radiated emission limits specified in Section 15.209(a).

Frequency (MHz)	Frequency (MHz)	Frequency (MHz)	Frequency (GHz)
0.090 - 0.110	16.42 - 16.423	399.9 - 410	4.5 - 5.15
¹ 0.495 - 0.505	16.69475 - 16.69525	608 - 614	5.35 - 5.46
2.1735 - 2.1905	16.80425 - 16.80475	960 - 1240	7.25 - 7.75
4.125 - 4.128	25.5 - 25.67	1300 - 1427	8.025 - 8.5
4.17725 - 4.17775	37.5 - 38.25	1435 - 1626.5	9.0 - 9.2
4.20725 - 4.20775	73 - 74.6	1645.5 - 1646.5	9.3 - 9.5
6.215 - 6.218	74.8 - 75.2	1660 - 1710	10.6 - 12.7
6.26775 - 6.26825	108 - 121.94	1718.8 - 1722.2	13.25 - 13.4
6.31175 - 6.31225	123 - 138	2200 - 2300	14.47 - 14.5
8.291 - 8.294	149.9 - 150.05	2310 - 2390	15.35 - 16.2
8.362 - 8.366	156.52475 - 156.52525	2483.5 - 2500	17.7 - 21.4
8.37625 - 8.38675	156.7 - 156.9	2690 - 2900	22.01 - 23.12
8.41425 - 8.41475	162.0125 - 167.17	3260 - 3267	23.6 - 24.0
12.29 - 12.293	167.72 - 173.2	3332 - 3339	31.2 - 31.8
12.51975 - 12.52025	240 - 285	3345.8 - 3358	36.43 - 36.5
12.57675 - 12.57725	322 - 335.4	3600 - 4400	(²)
13.36 - 13.41	--	--	--

For RSS-Gen Section 8.10 Requirement

Radiated emissions which fall in the restricted bands, as defined in Section 8.10 of RSS-Gen, must also comply with the radiated emission limits specified in Section 8.9.

Frequency (MHz)	Frequency (MHz)	Frequency (GHz)
0.090 - 0.110	149.9 - 150.05	9.0 - 9.2
0.495 - 0.505	156.52475 - 156.52525	9.3 - 9.5
2.1735 - 2.1905	156.7 - 156.9	10.6 - 12.7
3.020 - 3.026	162.0125 - 167.17	13.25 - 13.4
4.125 - 4.128	167.72 - 173.2	14.47 - 14.5
4.17725 - 4.17775	240 - 285	15.35 - 16.2
4.20725 - 4.20775	322 - 335.4	17.7 - 21.4
5.677 - 5.683	399.9 - 410	22.01 - 23.12
6.215 - 6.218	608 - 614	23.6 - 24.0
6.26775 - 6.26825	960 - 1427	31.2 - 31.8
6.31175 - 6.31225	1435 - 1626.5	36.43 - 36.5
8.291 - 8.294	1645.5 - 1646.5	Above 38.6
8.362 - 8.366	1660 - 1710	--
8.37625 - 8.38675	1718.8 - 1722.2	--
8.41425 - 8.41475	2200 - 2300	--
12.29 - 12.293	2310 - 2390	--
12.51975 - 12.52025	2483.5 - 2500	--
12.57675 - 12.57725	2655 - 2900	--
13.36 - 13.41	3260 - 3267	--
16.42 - 16.423	3332 - 3339	--
16.69475 - 16.69525	3345.8 - 3358	--
16.80425 - 16.80475	3500 - 4400	--
25.5 - 25.67	4500 - 5150	--
37.5 - 38.25	5350 - 5460	--
73 - 74.6	7250 - 7750	--
74.8 - 75.2	8025 - 8500	--
108 - 138	--	--

All out of band emissions appearing in a restricted band as specified in Section 15.205 of the Title 47CFR and in in Section 8.10 of the RSS-Gen must not exceed the limits shown in below table.

FCC Part 15 Subpart C Paragraph 15.209 & RSS-Gen Section 8.9		
Frequency [MHz]	Field Strength [uV/m]	Measured Distance [Meters]
0.009 - 0.490	2400/F (kHz)	300
0.490 - 1.705	24000/F (kHz)	30
1.705 - 30	30	30
30 - 88	100	3
88 - 216	150	3
216 - 960	200	3
Above 960	500	3

7.7.2. Test Procedure Used

ANSI C63.10 Section 6.3 (General Requirements)

ANSI C63.10 Section 6.6 (Standard test method above 1GHz)

7.7.3. Test Setting

Peak Field Strength Measurements

1. Analyzer center frequency was set to the frequency of the radiated spurious emission of interest
2. RBW = 1MHz
3. VBW = 3MHz
4. Detector = peak
5. Sweep time = auto couple
6. Trace mode = max hold
7. Trace was allowed to stabilize

7.7.4. Test Setup

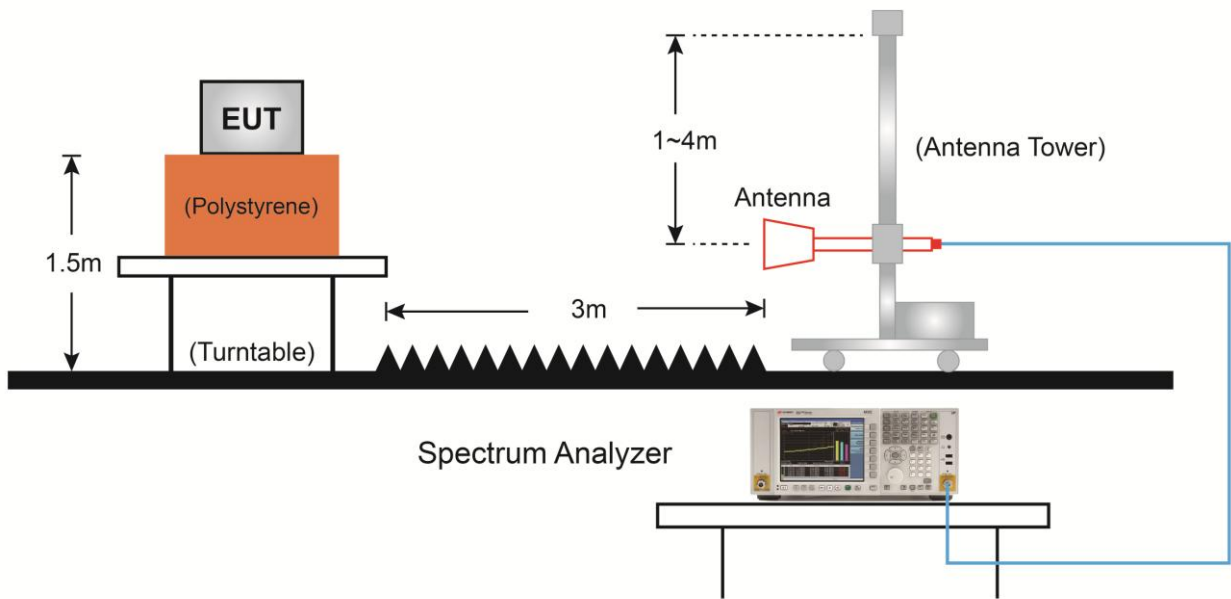

7.7.5. Test Result

Site: AC1	Time: 2020/03/21 - 15:16
Limit: FCC_Part15.209_RE(3m)	Engineer: Messiah Li
Probe: BBHA9120D_1-18GHz	Polarity: Horizontal
EUT: SLT3 3CH TX	Power: By Battery
Test Mode: Transmit at Channel 01 (2403MHz)	

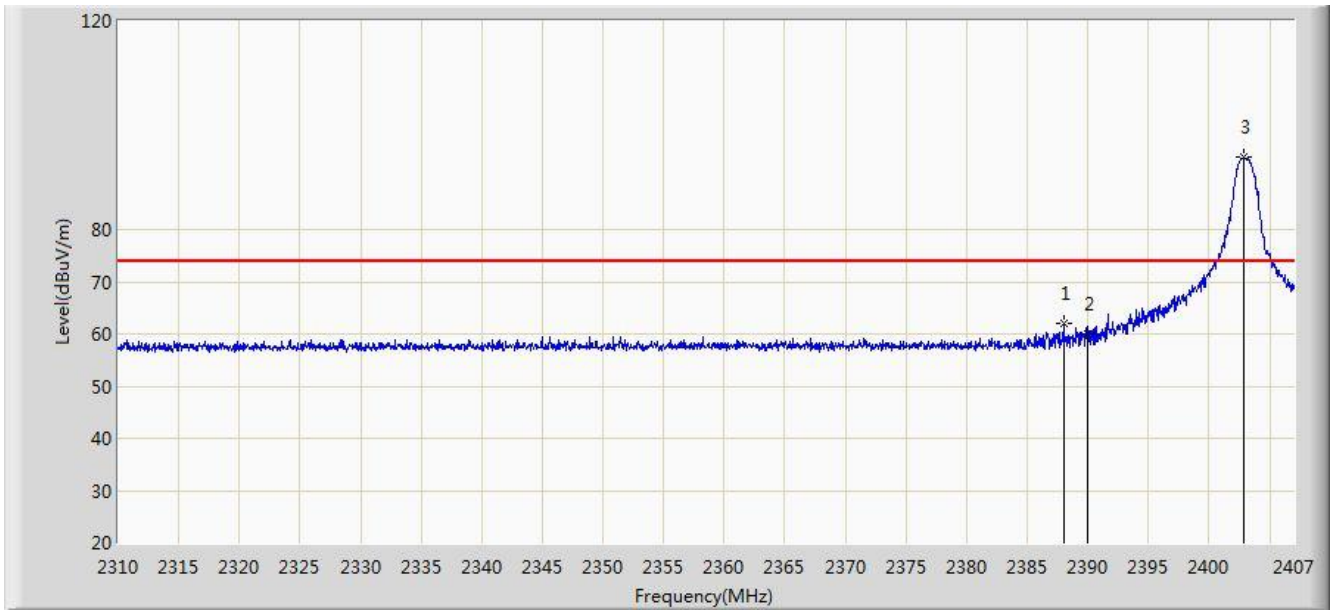

No	Flag	Mark	Frequency (MHz)	Reading Level (dBuV)	Factor (dB)	Duty Cycle Factor (dB)	Measure Level (dBuV/m)	Limit (dBuV/m)	Margin (dB)	Type
1			2389.782	36.823	32.072	N/A	68.895	74.000	-5.105	PK
			2389.782	36.823	32.072	-33.98	34.915	54.000	-19.085	AV
2			2390.000	36.706	32.072	N/A	68.778	74.000	-5.222	PK
			2390.000	36.706	32.072	-33.98	34.798	54.000	-19.202	AV
3		*	2402.684	70.735	32.076	N/A	102.811	74.000	28.811	PK

Note: Peak Measure Level (dB μ V/m) = Reading Level (dB μ V) + Factor (dB)

Average Measure Level = Peak Measure Level + Duty Cycle Factor

Factor (dB) = Cable Loss (dB) + Antenna Factor (dB/m)

Site: AC1	Time: 2020/03/21 - 15:18
Limit: FCC_Part15.209_RE(3m)	Engineer: Messiah Li
Probe: BBHA9120D_1-18GHz	Polarity: Vertical
EUT: SLT3 3CH TX	Power: By Battery
Test Mode: Transmit at Channel 01 (2403MHz)	

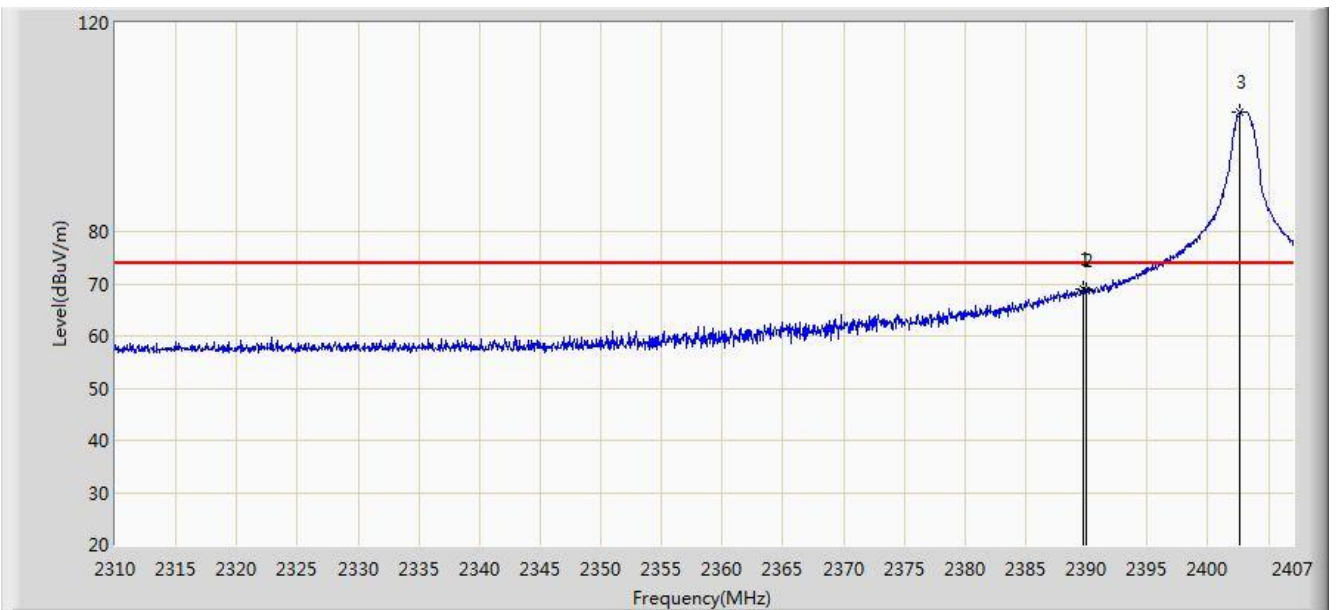

No	Flag	Mark	Frequency (MHz)	Reading Level (dBuV)	Factor (dB)	Duty Cycle Factor (dB)	Measure Level (dBuV/m)	Limit (dBuV/m)	Margin (dB)	Type
1			2387.988	29.875	32.072	N/A	61.948	74.000	-12.052	PK
			2387.988	29.875	32.072	-33.98	27.968	54.000	-26.032	AV
2			2390.000	28.014	32.072	N/A	60.086	74.000	-13.914	PK
			2390.000	28.014	32.072	-33.98	26.106	54.000	-27.894	AV
3		*	2402.829	61.712	32.075	N/A	93.788	74.000	19.788	PK

Note: Peak Measure Level (dB μ V/m) = Reading Level (dB μ V) + Factor (dB)

Average Measure Level = Peak Measure Level + Duty Cycle Factor

Factor (dB) = Cable Loss (dB) + Antenna Factor (dB/m)

Site: AC1	Time: 2020/03/17 - 18:23
Limit: FCC_Part15.209_RE(3m)	Engineer: Messiah Li
Probe: BBHA9120D_1-18GHz	Polarity: Horizontal
EUT: SLT3 3CH TX	Power: By Battery
Test Mode: Transmit at Channel 38 (2440MHz)	

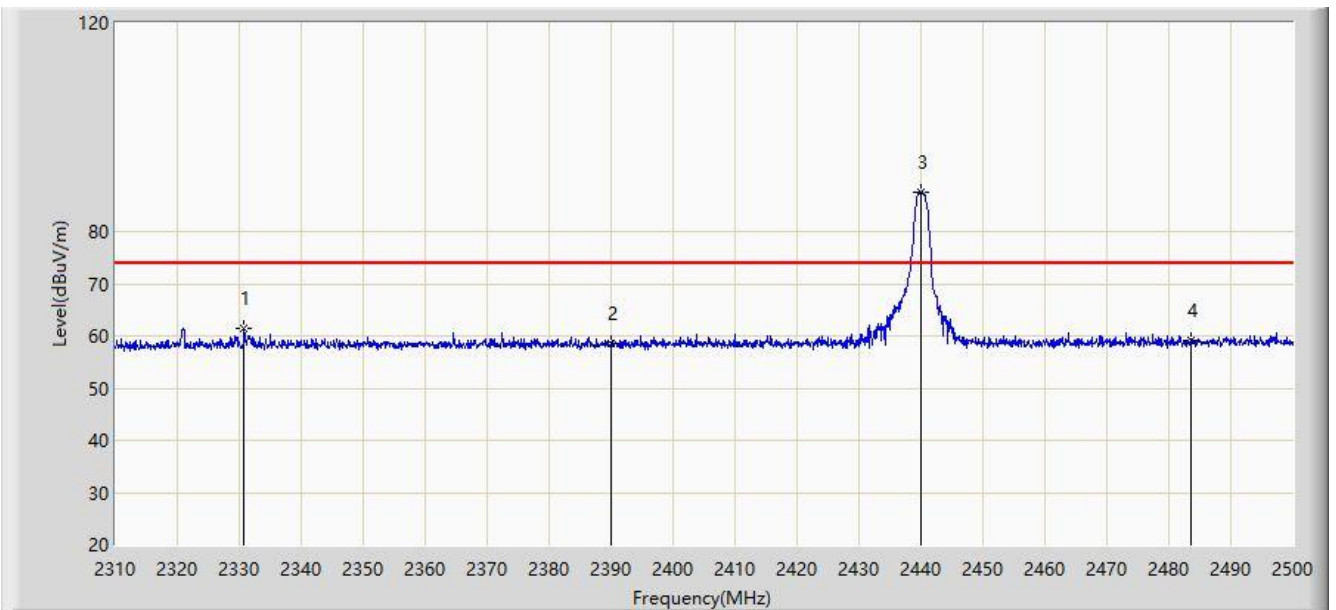

No	Flag	Mark	Frequency (MHz)	Reading Level (dBuV)	Factor (dB)	Duty Cycle Factor (dB)	Measure Level (dBuV/m)	Limit (dBuV/m)	Margin (dB)	Type
1			2340.590	32.798	32.142	N/A	64.940	74.000	-9.060	PK
			2340.590	32.798	32.142	-33.98	30.960	54.000	-23.04	AV
2			2390.000	30.303	32.072	N/A	62.375	74.000	-11.625	PK
			2390.000	30.303	32.072	-33.98	28.395	54.000	-25.605	AV
3		*	2439.865	75.597	33.068	N/A	108.665	74.000	34.665	PK
4			2483.500	31.961	32.037	N/A	63.998	74.000	-10.002	PK
			2483.500	31.961	32.037	-33.98	30.018	54.000	-23.982	AV

Note: Peak Measure Level (dBuV/m) = Reading Level (dBuV) + Factor (dB)

Average Measure Level = Peak Measure Level + Duty Cycle Factor

Factor (dB) = Cable Loss (dB) + Antenna Factor (dB/m)

Site: AC1	Time: 2020/03/17 - 18:24
Limit: FCC_Part15.209_RE(3m)	Engineer: Messiah Li
Probe: BBHA9120D_1-18GHz	Polarity: Vertical
EUT: SLT3 3CH TX	Power: By Battery
Test Mode: Transmit at Channel 38 (2440MHz)	

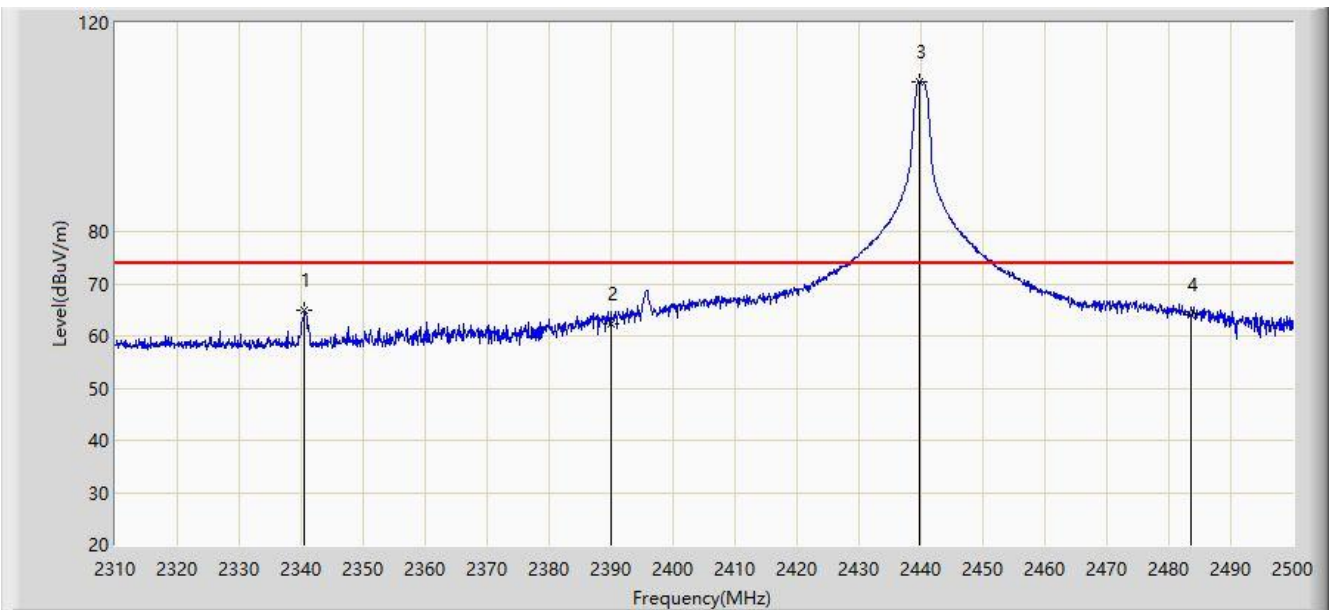

No	Flag	Mark	Frequency (MHz)	Reading Level (dBuV)	Factor (dB)	Duty Cycle Factor (dB)	Measure Level (dBuV/m)	Limit (dBuV/m)	Margin (dB)	Type
1			2330.805	29.244	32.167	N/A	61.412	74.000	-12.588	PK
			2330.805	29.244	32.167	-33.98	27.432	54.000	-26.568	AV
2			2390.000	26.386	32.072	N/A	58.458	74.000	-15.542	PK
			2390.000	26.386	32.072	-33.98	24.478	54.000	-29.522	AV
3		*	2439.960	54.509	33.068	N/A	87.577	74.000	13.577	PK
4			2483.500	26.969	32.037	N/A	59.006	74.000	-14.994	PK
			2483.500	26.969	32.037	-33.98	25.026	54.000	-28.974	AV

Note: Peak Measure Level (dB μ V/m) = Reading Level (dB μ V) + Factor (dB)

Average Measure Level = Peak Measure Level + Duty Cycle Factor

Factor (dB) = Cable Loss (dB) + Antenna Factor (dB/m)

Site: AC1	Time: 2020/03/21 - 14:57
Limit: FCC_Part15.209_RE(3m)	Engineer: Messiah Li
Probe: BBHA9120D_1-18GHz	Polarity: Horizontal
EUT: SLT3 3CH TX	Power: By Battery
Test Mode: Transmit at Channel 74 (2476MHz)	

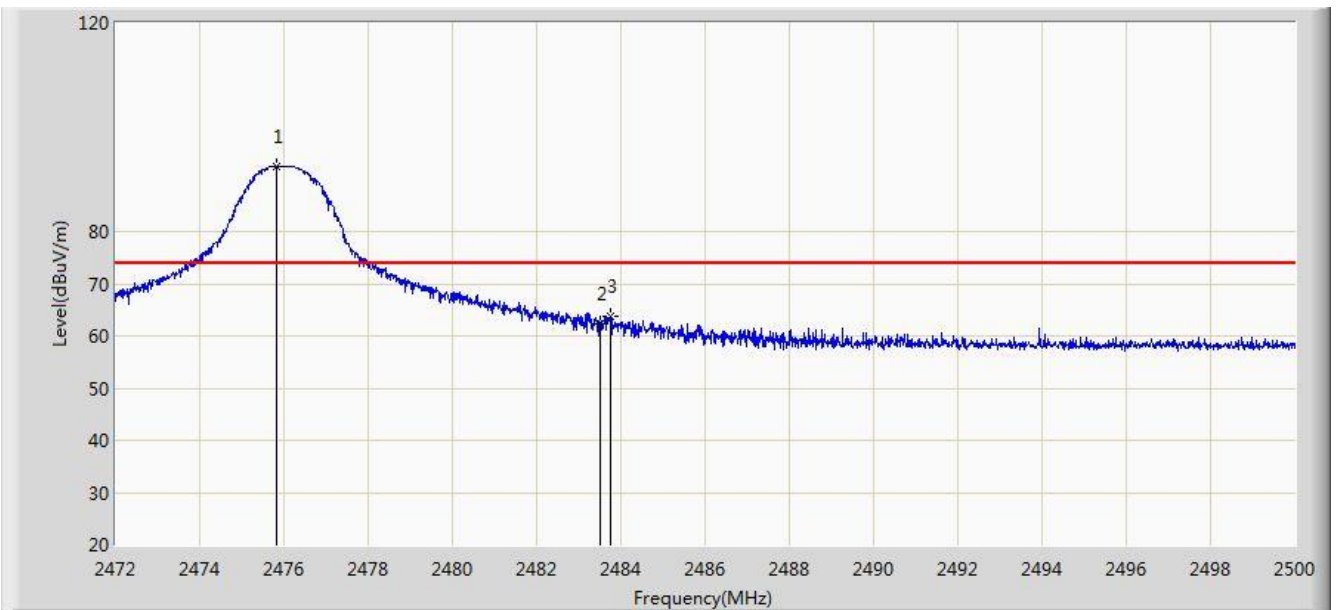

No	Flag	Mark	Frequency (MHz)	Reading Level (dBuV)	Factor (dB)	Duty Cycle Factor (dB)	Measure Level (dBuV/m)	Limit (dBuV/m)	Margin (dB)	Type
1		*	2475.836	60.477	32.052	N/A	92.529	74.000	18.529	PK
2			2483.500	30.320	32.037	N/A	62.357	74.000	-11.643	PK
			2483.500	30.320	32.037	-33.98	28.377	54.000	-25.623	AV
3			2483.760	31.632	32.036	N/A	63.668	74.000	-10.332	PK
			2483.760	31.632	32.036	-33.98	29.688	54.000	-24.312	AV

Note: Peak Measure Level (dB μ V/m) = Reading Level (dB μ V) + Factor (dB)

Average Measure Level = Peak Measure Level + Duty Cycle Factor

Factor (dB) = Cable Loss (dB) + Antenna Factor (dB/m)

Site: AC1	Time: 2020/03/21 - 14:59
Limit: FCC_Part15.209_RE(3m)	Engineer: Messiah Li
Probe: BBHA9120D_1-18GHz	Polarity: Vertical
EUT: SLT3 3CH TX	Power: By Battery
Test Mode: Transmit at Channel 74 (2476MHz)	

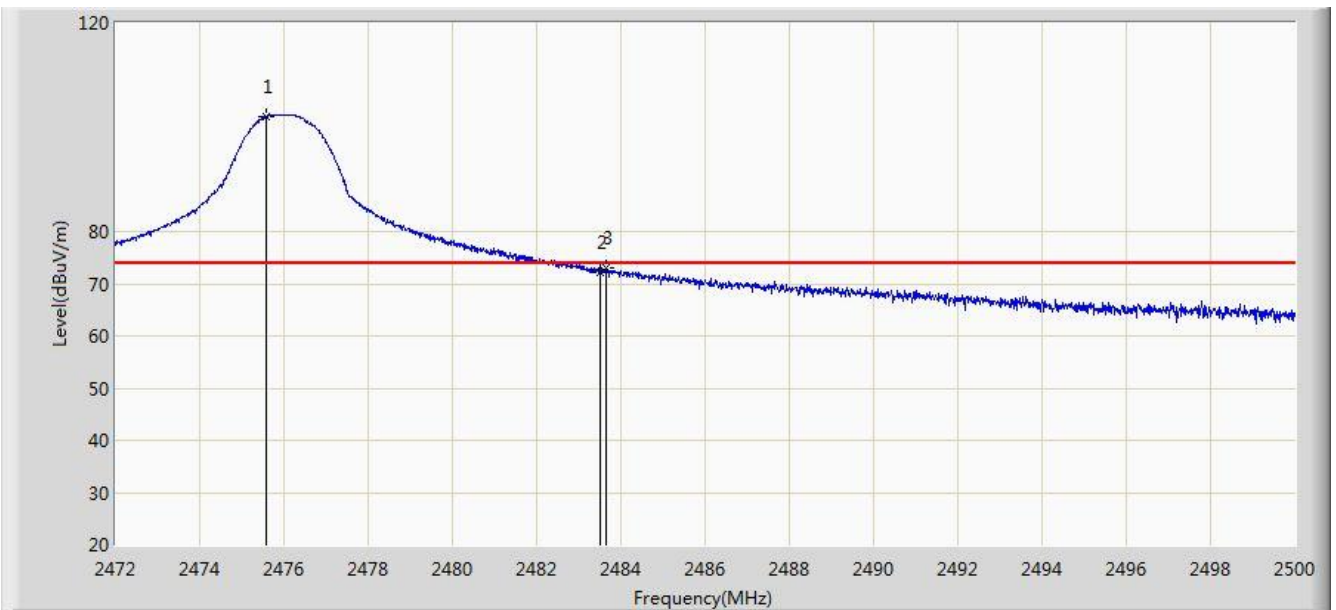

No	Flag	Mark	Frequency (MHz)	Reading Level (dBuV)	Factor (dB)	Duty Cycle Factor (dB)	Measure Level (dBuV/m)	Limit (dBuV/m)	Margin (dB)	Type
1		*	2475.570	70.101	32.052	N/A	102.154	74.000	28.154	PK
2			2483.500	40.029	32.037	N/A	72.066	74.000	-1.934	PK
			2483.500	40.029	32.037	-33.98	38.086	54.000	-15.914	AV
3			2483.648	41.056	32.036	N/A	73.093	74.000	-0.907	PK
			2483.648	41.056	32.036	-33.98	39.113	54.000	-14.887	AV

Note: Peak Measure Level (dB μ V/m) = Reading Level (dB μ V) + Factor (dB)

Average Measure Level = Peak Measure Level + Duty Cycle Factor

Factor (dB) = Cable Loss (dB) + Antenna Factor (dB/m)

Site: AC1	Time: 2020/03/21 - 15:02
Limit: FCC_Part15.209_RE(3m)	Engineer: Messiah Li
Probe: BBHA9120D_1-18GHz	Polarity: Horizontal
EUT: SLT3 3CH TX	Power: By Battery
Test Mode: Transmit at Channel 75 (2480MHz)	

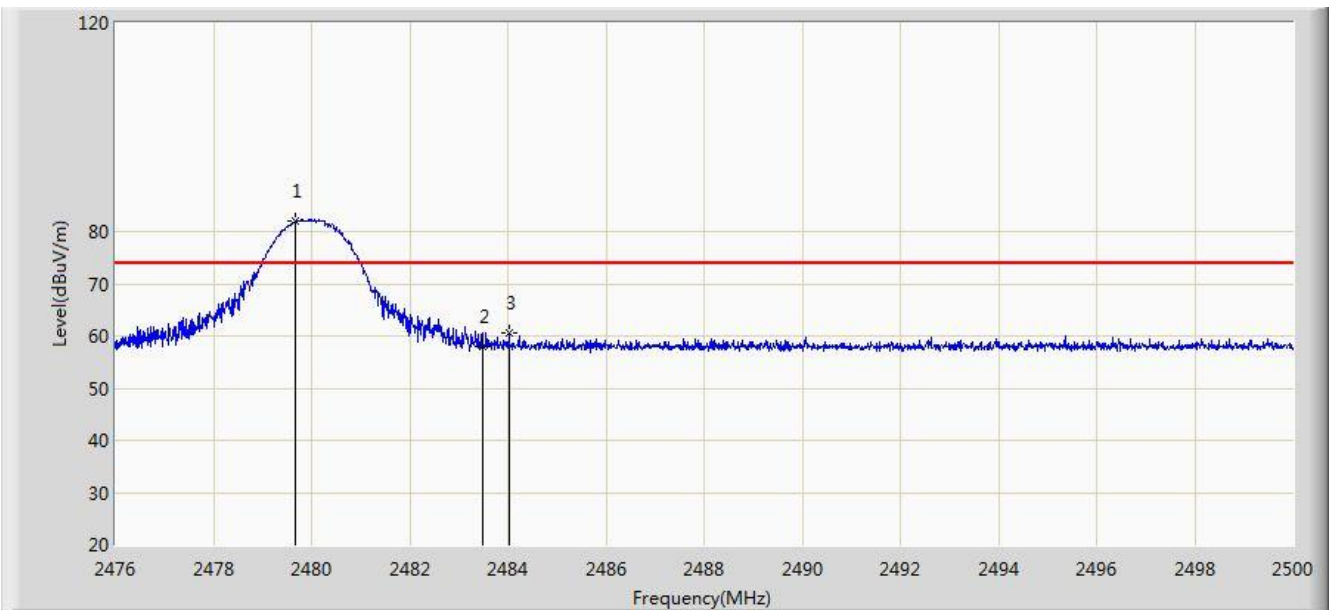

No	Flag	Mark	Frequency (MHz)	Reading Level (dBuV)	Factor (dB)	Duty Cycle Factor (dB)	Measure Level (dBuV/m)	Limit (dBuV/m)	Margin (dB)	Type
1		*	2479.672	50.038	32.044	N/A	82.082	74.000	8.082	PK
2			2483.500	25.893	32.037	N/A	57.930	74.000	-16.070	PK
			2483.500	25.893	32.037	-33.98	23.950	54.000	-30.050	AV
3			2484.028	28.460	32.036	N/A	60.496	74.000	-13.504	PK
			2484.028	28.460	32.036	-33.98	26.516	54.000	-27.484	AV

Note: Peak Measure Level (dB μ V/m) = Reading Level (dB μ V) + Factor (dB)

Average Measure Level = Peak Measure Level + Duty Cycle Factor

Factor (dB) = Cable Loss (dB) + Antenna Factor (dB/m)

Site: AC1	Time: 2020/03/21 - 15:04
Limit: FCC_Part15.209_RE(3m)	Engineer: Messiah Li
Probe: BBHA9120D_1-18GHz	Polarity: Vertical
EUT: SLT3 3CH TX	Power: By Battery
Test Mode: Transmit at Channel 75 (2480MHz)	

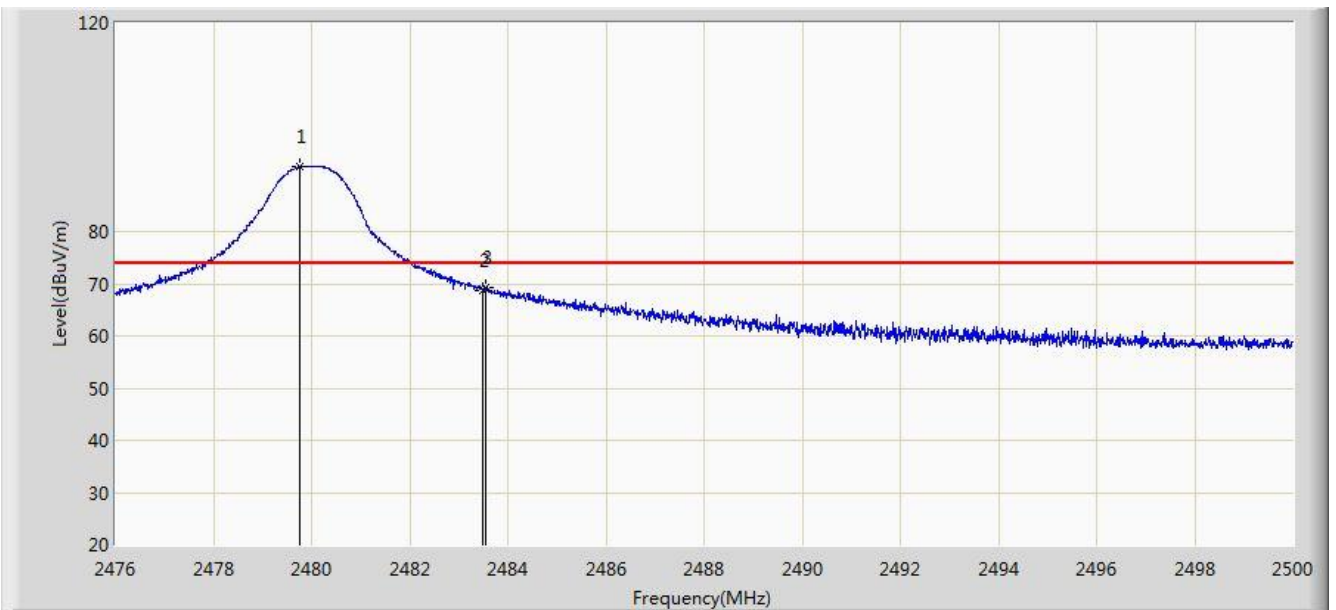

No	Flag	Mark	Frequency (MHz)	Reading Level (dBuV)	Factor (dB)	Duty Cycle Factor (dB)	Measure Level (dBuV/m)	Limit (dBuV/m)	Margin (dB)	Type
1		*	2479.768	60.476	32.044	N/A	92.520	74.000	18.520	PK
2			2483.500	36.681	32.037	N/A	68.718	74.000	-5.282	PK
			2483.500	36.681	32.037	-33.98	34.738	54.000	-19.262	AV
3			2483.560	37.229	32.037	N/A	69.266	74.000	-4.734	PK
			2483.560	37.229	32.037	-33.98	35.286	54.000	-18.714	AV

Note: Peak Measure Level (dB μ V/m) = Reading Level (dB μ V) + Factor (dB)

Average Measure Level = Peak Measure Level + Duty Cycle Factor

Factor (dB) = Cable Loss (dB) + Antenna Factor (dB/m)

7.8. AC Conducted Emissions Measurement

7.8.1. Test Limit

FCC Part 15 Subpart C Paragraph 15.207 / RSS-Gen Issue 5 Section 8.8 Limits		
Frequency (MHz)	QP (dBuV)	AV (dBuV)
0.15 ~ 0.50	66 ~ 56	56 ~ 46
0.50 ~ 5.0	56	46
5.0 ~ 30	60	50

Note 1: The lower limit shall apply at the transition frequencies.

Note 2: The limit decreases linearly with the logarithm of the frequency in the range 0.15MHz to 0.5MHz.

7.8.2. Test Setup

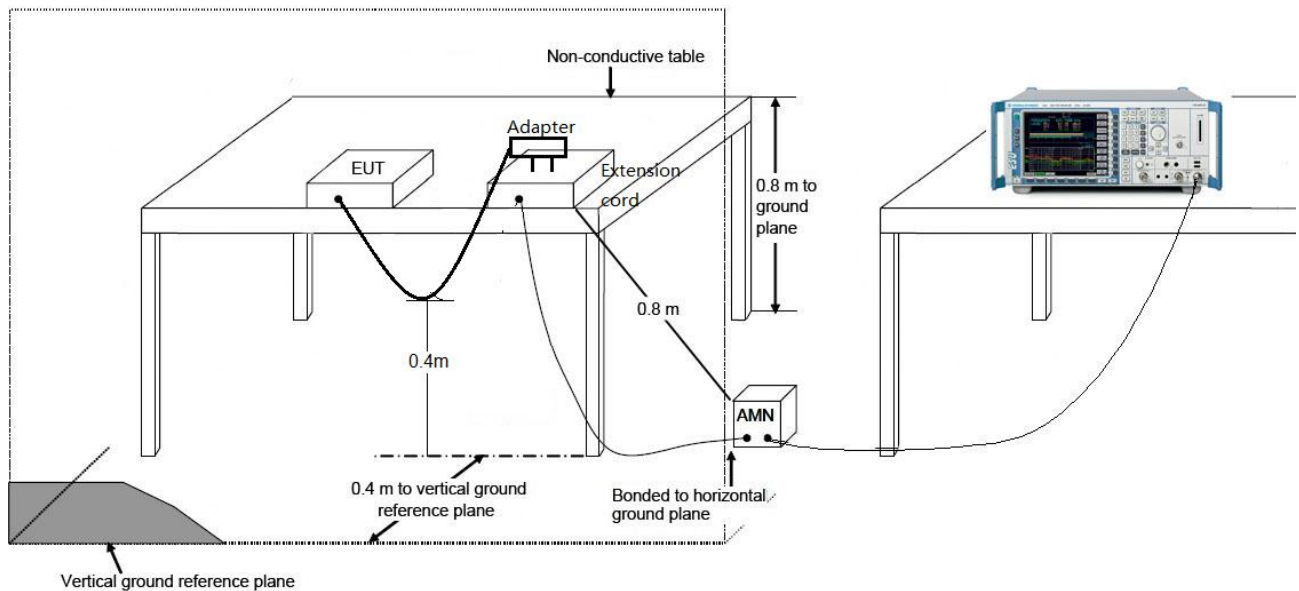

7.8.3. Test Result

The EUT is powered by battery, so this requirement does not apply.

8. CONCLUSION

The data collected relate only the item(s) tested and show that unit is compliance with Part 15C of the FCC Rules and ISED Rules.

The End

Appendix A - Test Setup Photograph

Refer to " 2003RSU018-UT" file.

Appendix B - EUT Photograph

Refer to “ 2003RSU018-UE” file.