



# MEASUREMENT REPORT

## FCC PART 15.249 / RSS-210

---

**FCC ID:** BRWEFLH2401  
**IC:** 6157A-EFLH2401  
**APPLICANT:** Horizon Hobby, LLC

**Application Type:** Certification  
**Product:** Receiver  
**Model No.:** EFLH2401  
**FCC Classification:** Part 15 low power transceiver, RX verified (DXT)  
**FCC Rule Part(s):** Part 15.249  
**IC Rule(s):** RSS-210 Issue 9, RSS-GEN Issue 5  
**Test Procedure(s):** ANSI C63.10 - 2013  
**Test Date:** August 24 ~ 29, 2018

Reviewed By:   
( Sunny Sun )

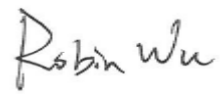
Approved By:   
( Robin Wu )



The test results relate only to the samples tested.  
This equipment has been shown to be capable of compliance with the applicable technical standards as indicated in the measurement report and was tested in accordance with the measurement procedures specified in ANSI C63.10-2013. Test results reported herein relate only to the item(s) tested.  
The test report shall not be reproduced except in full without the written approval of MRT Technology (Suzhou) Co., Ltd.

### Revision History

Report No.	Version	Description	Issue Date	Note
1808RSU054-U1	Rev. 01	Initial Report	09-12-2018	Valid

---

# CONTENTS

Description	Page
<b>1. INTRODUCTION .....</b>	<b>6</b>
1.1. Scope .....	6
1.2. MRT Test Location .....	6
<b>2. PRODUCT INFORMATION .....</b>	<b>7</b>
2.1. Equipment Description .....	7
2.2. Operation Frequency and Channel List.....	7
2.3. Test Configuration .....	7
2.4. Test Software .....	7
2.5. EMI Suppression Device(s)/Modifications .....	8
2.6. Labeling Requirements .....	8
<b>3. DESCRIPTION OF TEST .....</b>	<b>9</b>
3.1. Evaluation Procedure .....	9
3.2. AC Line Conducted Emissions.....	9
3.3. Radiated Emissions.....	10
<b>4. ANTENNA REQUIREMENTS .....</b>	<b>11</b>
<b>5. TEST EQUIPMENT CALIBRATION DATE .....</b>	<b>12</b>
<b>6. MEASUREMENT UNCERTAINTY .....</b>	<b>13</b>
<b>7. TEST RESULT .....</b>	<b>14</b>
7.1. Summary .....	14
7.2. Conducted Emission .....	15
7.2.1. Test Limit .....	15
7.2.2. Test Setup .....	15
7.2.3. Test Result.....	16
7.3. Radiated Emission .....	17
7.3.1. Test Limit .....	17
7.3.2. Test Setup .....	18
7.3.3. Test Result.....	19
7.4. Radiated Restricted Band Edge Measurement .....	24
7.4.1. Test Limit .....	24
7.4.2. Test Setup .....	27
7.4.3. Test Result.....	28
7.5. 20dB Spectrum Bandwidth Measurement .....	32
7.5.1. Test Limit .....	32

---

7.5.2.	Test Procedure used .....	32
7.5.3.	Test Setting.....	32
7.5.4.	Test Setup .....	32
7.5.5.	Test Result.....	33
7.6.	99% Bandwidth Measurement .....	34
7.6.1.	Test Limit .....	34
7.6.2.	Test Procedure used .....	34
7.6.3.	Test Setting.....	34
7.6.4.	Test Setup .....	34
7.6.5.	Test Result.....	35
<b>8.</b>	<b>CONCLUSION.....</b>	<b>36</b>
	<b>Appendix A – Test Setup Photograph .....</b>	<b>37</b>
	<b>Appendix B – EUT Photograph.....</b>	<b>38</b>

## §2.1033 General Information

<b>Applicant:</b>	Horizon Hobby, LLC			
<b>Applicant Address:</b>	4105 Fieldstone Rd., Champaign, IL 61822 USA			
<b>Manufacturer:</b>	KUNSHAN HELANG ELECTRONICS CO., LTD.			
<b>Manufacturer Address:</b>	No.388 East Zhengwei Road, Jinxi Town, Kunshan, Jiangsu 215324, China			
<b>Test Site:</b>	MRT Technology (Suzhou) Co., Ltd			
<b>Test Site Address:</b>	D8 Building, Youxin Industrial Park, No.2 Tian'edang Rd., Wuzhong Economic Development Zone, Suzhou, China			
<b>FCC Registration No.:</b>	893164			
<b>IC Registration No.:</b>	11384A-1			
<b>Test Device Serial No.:</b>	N/A	<input type="checkbox"/> Production	<input checked="" type="checkbox"/> Pre-Production	<input type="checkbox"/> Engineering

### Test Facility / Accreditations

Measurements were performed at MRT Laboratory located in Tian'edang Rd., Suzhou, China.

- MRT facility is a FCC registered (MRT Reg. No. 893164) test facility with the site description report on file and has met all the requirements specified in ANSI C63.4-2014.
- MRT facility is an IC registered (MRT Reg. No. 11384A-1) test laboratory with the site description on file at Industry Canada.
- MRT facility is a VCCI registered (R-20025, G-20034, C-20020, T-20020) test laboratory with the site description on file at VCCI Council.
- MRT Lab is accredited to ISO 17025 by the American Association for Laboratory Accreditation (A2LA) under the American Association for Laboratory Accreditation Program (A2LA Cert. No. 3628.01) in EMC, Telecommunications, Radio and SAR testing.



# 1. INTRODUCTION

## 1.1. Scope

Measurement and determination of electromagnetic emissions (EMC) of radio frequency devices including intentional and/or unintentional radiators for compliance with the technical rules and regulations of the Federal Communications Commission and the Industry Canada Certification and Engineering Bureau.

## 1.2. MRT Test Location

The map below shows the location of the MRT LABORATORY, its proximity to the Taihu Lake. These measurement tests were conducted at the MRT Technology (Suzhou) Co., Ltd. Facility located at D8 Building, No.2 Tian'edang Rd., Wuzhong Economic Development Zone, Suzhou, China. The measurement facility compliant with the test site requirements specified in ANSI C63.4-2014.



## 2. PRODUCT INFORMATION

### 2.1. Equipment Description

Product Name	Receiver
Model No.	EFLH2401
Frequency Range	2404 ~ 2476 MHz
Channel Number	23
Type of Modulation	GFSK

### 2.2. Operation Frequency and Channel List

Channel	Frequency	Channel	Frequency
01	2404 MHz	02	2412 MHz
03	2416 MHz	04	2418 MHz
05	2422 MHz	06	2424 MHz
07	2426 MHz	08	2428 MHz
09	2430 MHz	10	2432 MHz
11	2434 MHz	12	2438 MHz
13	2440 MHz	14	2444 MHz
15	2452 MHz	16	2460 MHz
17	2462 MHz	18	2464 MHz
19	2466 MHz	20	2468 MHz
21	2470 MHz	22	2472 MHz
23	2476 MHz	---	---

### 2.3. Test Configuration

The EUT was tested as described in this report is in compliance with the requirements limits of FCC Rules Part 15.207, 15.209, 15.215 and 15.249. ANSI C63.10-2013 was used to reference the appropriate EUT setup for radiated spurious emissions testing and AC line conducted testing.

### 2.4. Test Software

N/A

## 2.5. EMI Suppression Device(s)/Modifications

No EMI suppression device(s) were added and/or no modifications were made during testing.

## 2.6. Labeling Requirements

Per 2.1074 & 15.19; Docket 95-19

The label shall be permanently affixed at a conspicuous location on the device; instruction manual or pamphlet supplied to the user and be readily visible to the purchaser at the time of purchase.

However, when the device is so small wherein placement of the label with specified statement is not practical, only the FCC ID must be displayed on the device per Section 15.19(a)(5). Please see attachment for FCC ID label and label location.

RSP-100 Issue 11 Section 3

The manufacturer, importer or distributor shall meet the labelling requirements set out in this section for every unit:

- (i) prior to marketing in Canada, for products manufactured in Canada
- (ii) prior to importation into Canada, for imported products

For information regarding the e-labelling option, see Notice 2014–DRS1003. The label for the certified product represents the manufacturer's or importer's compliance with Innovation, Science and Economic Development Canada's (ISED) regulatory requirements.

Please see attachment for IC label and label location.



### 3. DESCRIPTION OF TEST

#### 3.1. Evaluation Procedure

The measurement procedures described in the American National Standard for Testing Unlicensed Wireless Devices (ANSI C63.10-2013), and the requirements provided in FCC 15.207, 15.209, 15.215 and 15.249 were performed in the report of the EUT.

**Deviation from measurement procedure.....None**

#### 3.2. AC Line Conducted Emissions

The line-conducted facility is located inside an 8'x4'x4' shielded enclosure. A 1m x 2m wooden table 80cm high is placed 40cm away from the vertical wall and 80cm away from the sidewall of the shielded room. Two 10kHz-30MHz, 50Ω/50uH Line-Impedance Stabilization Networks (LISNs) are bonded to the shielded room floor. Power to the LISNs is filtered by external high-current high-insertion loss power line filters. These filters attenuate ambient signal noise from entering the measurement lines. These filters are also bonded to the shielded enclosure.

The EUT is powered from one LISN and the support equipment is powered from the second LISN. All interconnecting cables more than 1 meter were shortened to a 1 meter length by non-inductive bundling (serpentine fashion) and draped over the back edge of the test table. All cables were at least 40cm above the horizontal reference ground-plane. Power cables for support equipment were routed down to the second LISN while ensuring that that cables were not draped over the second LISN.

Sufficient time for the EUT, support equipment, and test equipment was allowed in order for them to warm up to their normal operating condition. The RF output of the LISN was connected to the Receiver and exploratory measurements were made to determine the frequencies producing the maximum emission from the EUT. The Receiver was scanned from 150kHz to 30MHz. The detector function was set to peak mode for exploratory measurements while the bandwidth of the analyzer was set to 9kHz. The EUT, support equipment, and interconnecting cables were arranged and manipulated to maximize each emission. Each emission was also maximized by varying: power lines, the mode of operation or data exchange speed, or support equipment whichever determined the worst-case emission. Once the worst case emissions have been identified, the one EUT cable configuration/arrangement and mode of operation that produced these emissions are used for final measurements on the same test site. The analyzer is set to CISPR quasi-peak and average detectors with a 9kHz resolution bandwidth for final measurements.

An extension cord was used to connect to a single LISN which powered by EUT. The extension cord was calibrated with LISN, the impedance and insertion loss are compliance with the requirements as stated in ANSI C63.10-2013.

### 3.3. Radiated Emissions

The radiated test facilities consisted of an indoor 3 meter semi-anechoic chamber used for final measurements and exploratory measurements, when necessary. The measurement area is contained within the semi-anechoic chamber which is shielded from any ambient interference. For measurements above 1GHz absorbers are arranged on the floor between the turn table and the antenna mast in such a way so as to maximize the reduction of reflections. For measurements below 1GHz, the absorbers are removed. A MF Model 210SS turntable is used for radiated measurement. It is a continuously rotatable, remote controlled, metallic turntable and 2 meters (6.56 ft.) in diameter. The turn table is flush with the raised floor of the chamber in order to maintain its function as a ground plane. An 80cm high PVC support structure is placed on top of the turntable.

For all measurements, the spectrum was scanned through all EUT azimuths and from 1 to 4 meter receive antenna height using a broadband antenna from 30MHz up to the upper frequency shown in 15.33(b)(1) depending on the highest frequency generated or used in the device or on which the device operates or tunes. For frequencies above 1GHz, linearly polarized double ridge horn antennas were used. For frequencies below 30MHz, a calibrated loop antenna was used. When exploratory measurements were necessary, they were performed at 1 meter test distance inside the semi-anechoic chamber using broadband antennas, broadband amplifiers, and spectrum analyzers to determine the frequencies and modes producing the maximum emissions. Sufficient time for the EUT, support equipment, and test equipment was allowed in order for them to warm up to their normal operating condition. The test set-up for frequencies below 1GHz was placed on top of the 0.8 meter high, 1 x 1.5 meter table; and test set-up for frequencies 1-25GHz was placed on top of the 1.5 meter high, 1 x 1.5 meter table. The EUT, support equipment, and interconnecting cables were arranged and manipulated to maximize each emission. Appropriate precaution was taken to ensure that all emissions from the EUT were maximized and investigated. The system configuration, clock speed, mode of operation or video resolution, if applicable, turntable azimuth, and receive antenna height was noted for each frequency found.

Final measurements were made in the semi-anechoic chamber using calibrated, linearly polarized broadband and horn antennas. The test setup was configured to the setup that produced the worst case emissions. The spectrum analyzer was set to investigate all frequencies required for testing to compare the highest radiated disturbances with respect to the specified limits. The turntable containing the EUT was rotated through 360 degrees and the height of the receive antenna was varied 1 to 4 meters and stopped at the azimuth and height producing the maximum emission. Each emission was maximized by changing the orientation of the EUT through three orthogonal planes and changing the polarity of the receive antenna, whichever produced the worst-case emissions. According to 3dB Beam-Width of horn antenna, the horn antenna should be always directed to the EUT when rising height.

## 4. ANTENNA REQUIREMENTS

### **Excerpt from §15.203 of the FCC Rules/Regulations:**

“An intentional radiator antenna shall be designed to ensure that no antenna other than that furnished by the responsible party can be used with the device. The use of a permanently attached antenna or of an antenna that uses a unique coupling to the intentional radiator shall be considered sufficient to comply with the provisions of this section.”

- The antenna of the EUT is **permanently attached**.
- There are no provisions for connection to an external antenna.

### **Conclusion:**

This unit complies with the requirement of §15.203.

## 5. TEST EQUIPMENT CALIBRATION DATE

### Conducted Emissions - SR2

Instrument	Manufacturer	Type No.	Asset No.	Cali. Interval	Cali. Due Date
EMI Test Receiver	R&S	ESR3	MRTSUE06185	1 year	2019/04/20
Two-Line V-Network	R&S	ENV 216	MRTSUE06002	1 year	2019/06/15
Two-Line V-Network	R&S	ENV 216	MRTSUE06003	1 year	2019/06/15
Thermohygrometer	Testo	608-H1	MRTSUE06404	1 year	2019/08/15
Shielding Anechoic Chamber	Mikebang	Chamber-SR2	MRTSUE06214	N/A	N/A

### Radiated Emission - AC1

Instrument	Manufacturer	Type No.	Asset No.	Cali. Interval	Cal. Due Date
PXA Signal Analyzer	Keysight	9030B	MRTSUE06395	1 year	2018/09/13
EMI Test Receiver	R&S	ESR7	MRTSUE06001	1 year	2019/08/14
Loop Antenna	Schwarzbeck	FMZB 1519	MRTSUE06025	1 year	2018/11/20
EXA Signal Analyzer	Agilent	N9020A	MRTSUE06106	1 year	2019/04/20
Microwave System Amplifier	Agilent	83017A	MRTSUE06076	1 year	2018/11/17
Bilog Period Antenna	Schwarzbeck	VULB 9168	MRTSUE06172	1 year	2019/04/12
Broad Band Horn Antenna	Schwarzbeck	BBHA9120D	MRTSUE06023	1 year	2018/10/21
Broad Band Horn Antenna	Schwarzbeck	BBHA 9170	MRTSUE06024	1 year	2018/12/14
Amplifier	Schwarzbeck	BBV 9721	MRTSUE06121	1 year	2019/06/13
Thermohygrometer	Testo	608-H1	MRTSUE06403	1 year	2019/08/15
Anechoic Chamber	TDK	Chamber-AC1	MRTSUE06212	1 year	2019/05/08

### Conducted Test Equipment - TR3

Instrument	Manufacturer	Type No.	Asset No.	Cali. Interval	Cali. Due Date
EXA Signal Analyzer	Agilent	N9020A	MRTSUE06106	1 year	2019/04/20
Thermohygrometer	Testo	608-H1	MRTSUE06401	1 year	2019/08/15

Software	Version	Function
e3	V8.3.5	EMI Test Software

## 6. MEASUREMENT UNCERTAINTY

Where relevant, the following test uncertainty levels have been estimated for tests performed on the EUT as specified in CISPR 16-4-2. This uncertainty represents an expanded uncertainty expressed at approximately the 95% confidence level using a coverage factor of  $k = 2$ .

<b>AC Conducted Emission Measurement - SR2</b>
Measuring Uncertainty for a Level of Confidence of 95% ( $U=2Uc(y)$ ): 150kHz~30MHz: 3.46dB
<b>Radiated Emission Measurement - AC1</b>
Measuring Uncertainty for a Level of Confidence of 95% ( $U=2Uc(y)$ ): 9kHz ~ 1GHz: 4.18dB 1GHz ~ 25GHz: 4.76dB
<b>20dB Spectrum Bandwidth - TR3</b>
Measuring Uncertainty for a Level of Confidence of 95% ( $U=2Uc(y)$ ): 0.28%

## 7. TEST RESULT

### 7.1. Summary

**Company Name:** Horizon Hobby, LLC

**Product:** Receiver

RSS Section(s)	FCC Part Section(s)	Test Description	Test Limit	Test Condition	Test Result	Reference
RSS-Gen Clause 8.8	15.207	AC Conducted Emissions 150kHz - 30MHz	< FCC 15.207 limits; < RSS-Gen Clause 8.8 limits	Line Conducted	N/A	Section 7.2
RSS-Gen Clause 8.9; RSS-210 Annex A B.10	15.209 15.249	General Field Strength Limits (Restricted Bands and Radiated Emission Limits)	Emissions in restricted bands must meet the radiated limits detailed in 15.209 & clause 8.10	Radiated	Pass	Section 7.3 & 7.4
N/A	15.215(c)	20dB Spectrum Bandwidth	20 dB bandwidth of the emission in the specific band	Conducted	Pass	Section 7.5
RSS-GEN Clause 6.6	15.215(c)	99% Occupied Bandwidth	N/A	Conducted	Pass	Section 7.6

**Notes:**

1. All modes of operation and data rates were investigated. For radiated emission test, every axis (X, Y, Z) was also verified. The test results shown in the following sections represent the worst case emissions.
2. The analyzer plots shown in this section were all taken with a correction table loaded into the analyzer. The correction table was used to account for the losses of the cables and attenuators used as part of the system to connect the EUT to the analyzer at all frequencies of interest.

## 7.2. Conducted Emission

### 7.2.1. Test Limit

FCC 15.207 & RSS-Gen Limits		
Frequency (MHz)	QP (dBuV)	AV (dBuV)
0.15 ~ 0.50	66 ~ 56	56 ~ 46
0.50 ~ 5.0	56	46
5.0 ~ 30	60	50

Note 1: The lower limit shall apply at the transition frequencies.

Note 2: The limit decreases linearly with the logarithm of the frequency in the range 0.15MHz to 0.5MHz.

### 7.2.2. Test Setup

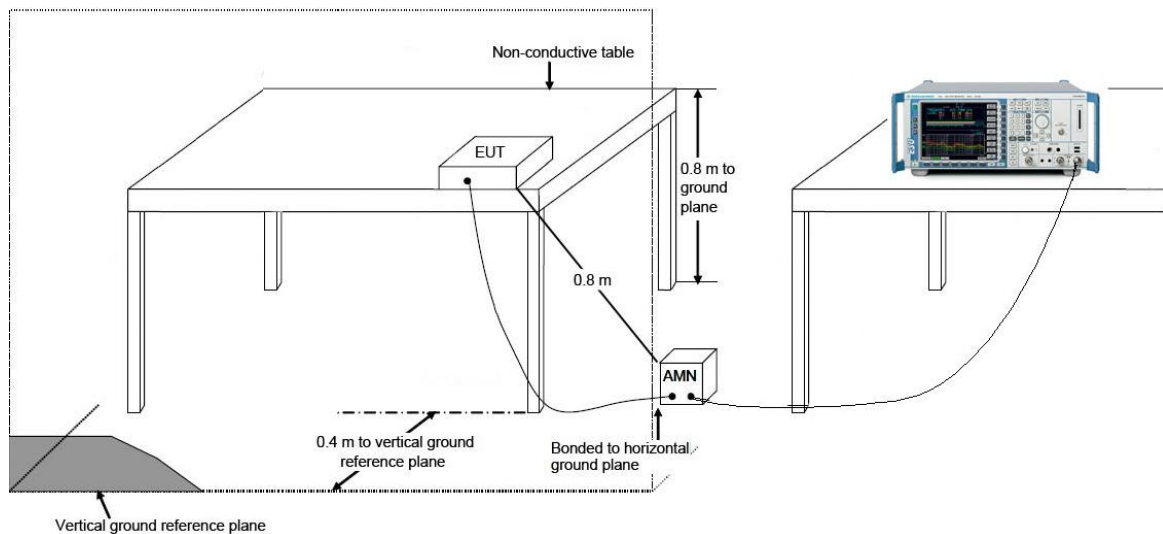

### **7.2.3. Test Result**

The EUT is powered by battery, so this requirement does not apply.



### 7.3. Radiated Emission

#### 7.3.1. Test Limit

FCC Part 15 Subpart C Paragraph 15.249 & RSS-210		
Fundamental Frequency (MHz)	Field Strength of Fundamental (mV/m)	Field Strength of Harmonics (uV/m)
902 ~ 908	50	500
2400 ~ 2483.5	50	500
5725 ~ 5875	50	500
24000 ~ 24250	250	2500

FCC Part 15.249 (d), Emissions radiated outside of the specified frequency bands, except for harmonics, shall be attenuated by at least 50 dB below the level of the fundamental or to the general radiated emission limits in §15.209, whichever is the lesser attenuation.

FCC Part 15 Subpart C Paragraph 15.209 & RSS-Gen		
Frequency (MHz)	Field Strength (uV/m)	Measurement Distance (m)
0.009 ~ 0.490	2400/F(kHz)	300
0.490 ~ 1.705	24000/F(kHz)	30
1.705 ~ 30.0	30	30
30 ~ 80	100**	3
80 ~ 216	150**	3
216 ~ 960	200**	3
Above 960	500	3

Note 1: The lower limit shall apply at the transition frequency.

Note 2: Distance refers to the distance in meters between the measuring instrument antenna and the closed point of any part of the device or system.

Note 3: E field strength (dBuV/m) = 20 log E field strength (uV/m).

### 7.3.2. Test Setup

#### 9kHz ~ 30MHz Test Setup:

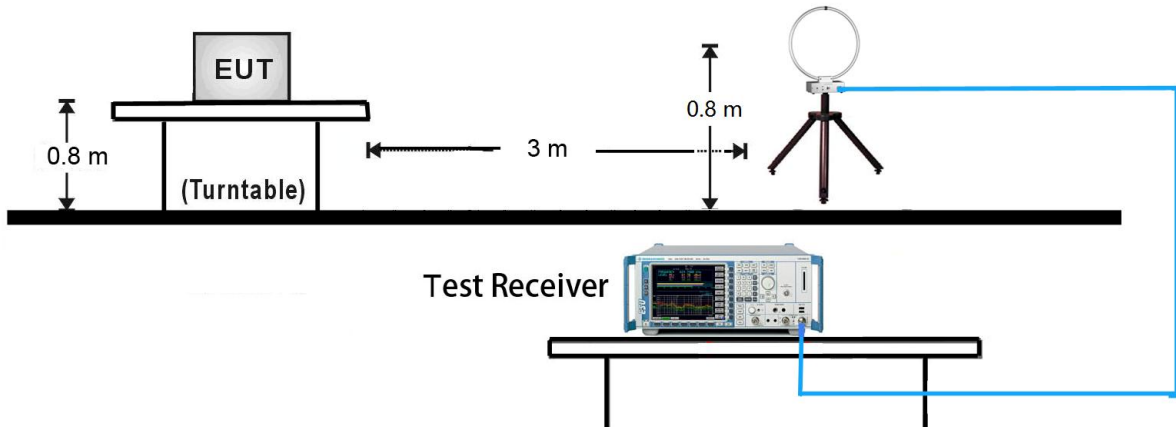

#### 30MHz ~ 1GHz Test Setup:

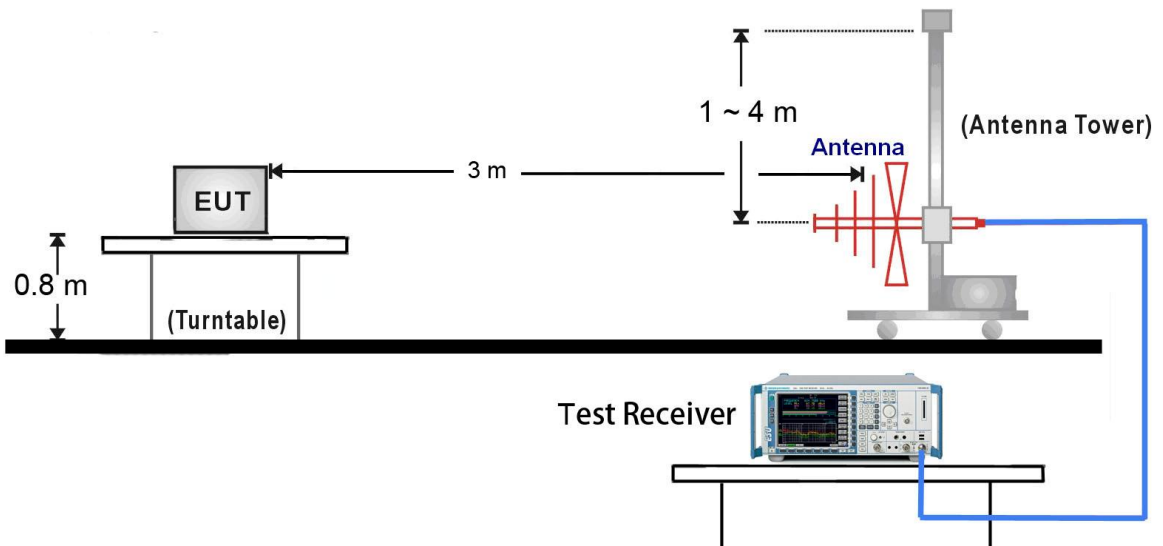

#### 1GHz ~ 25GHz Test Setup:

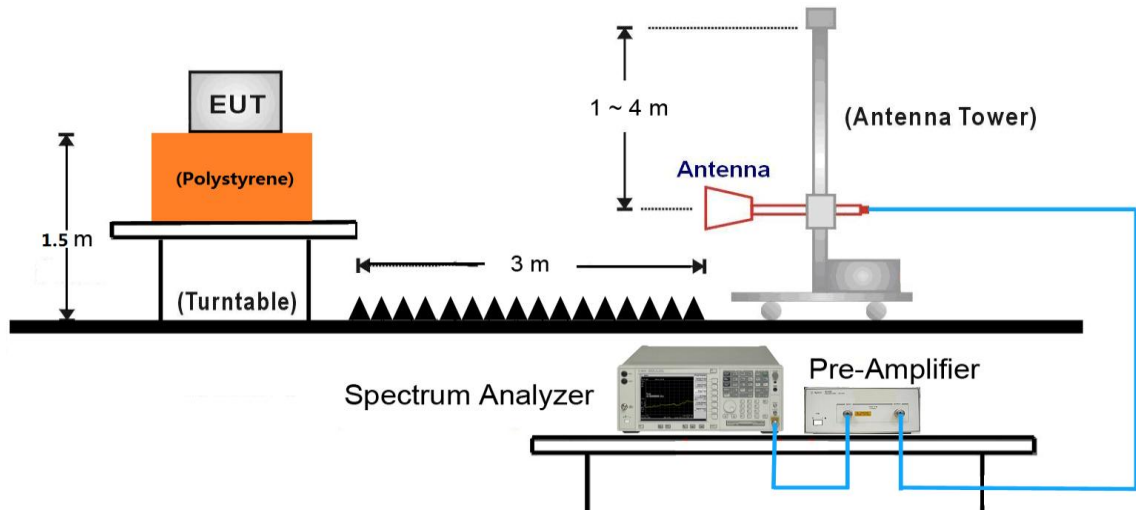

### 7.3.3. Test Result

Product	Receiver	Temperature	24°C
Test Engineer	Messiah Li	Relative Humidity	59%
Test Site	AC1	Test Date	2018/08/28

Time On (ms)	One Period (ms)	Duty Cycle (%)	Duty Cycle Factor (dB)
0.30	22.56	1.33	-37.52

Note: Duty Cycle Factor = 20\*Log (Duty Cycle)

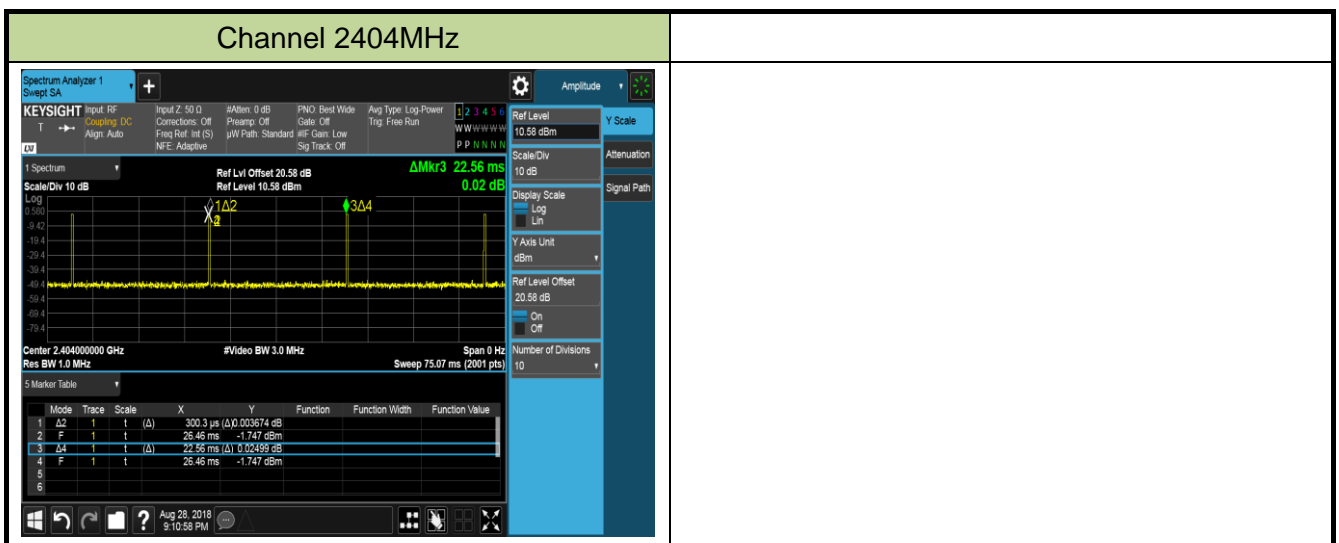

Product	Receiver	Temperature	25°C
Test Engineer	Messiah Li	Relative Humidity	52%
Test Site	AC1	Test Date	2018/08/28
Remark:	<b>Fundamental</b> Radiated Emission		

Frequency (MHz)	Reading Level (dBμV)	Factor (dB)	Duty Cycle Factor (dB)	Measure Level (dBμV/m)	Limit (dBμV/m)	Margin (dB)	Detector	Polarization
2404	62.9	32.3	N/A	95.2	114	-18.8	PK	Horizontal
	62.9	32.3	-37.5	57.7	94	-36.3	AV	Horizontal
	63.6	32.3	N/A	95.9	114	-18.1	PK	Vertical
	63.6	32.3	-37.5	58.4	94	-35.6	AV	Vertical
2440	62.4	32.3	N/A	94.7	114	-19.3	PK	Horizontal
	62.4	32.3	-37.5	57.2	94	-36.8	AV	Horizontal
	61.8	32.3	N/A	94.1	114	-19.9	PK	Vertical
	61.8	32.3	-37.5	56.5	94	-37.5	AV	Vertical
2476	61.3	32.3	N/A	93.6	114	-20.4	PK	Horizontal
	61.3	32.3	-37.5	56.1	94	-37.9	AV	Horizontal
	61.8	32.3	N/A	94.1	114	-19.9	PK	Vertical
	61.8	32.3	-37.5	56.6	94	-37.4	AV	Vertical

Note 1: Peak Measure Level (dBμV/m) = Reading Level (dBμV) + Factor (dB)

Average Measure Level = Peak Measure Level + Duty Cycle Factor

Factor (dB) = Cable Loss (dB) + Antenna Factor (dB/m)

Note 2: All readings below 1GHz are peak, above 1GHz are performed with peak and/or average measurements as necessary.

Product	Receiver	Temperature	25°C
Test Engineer	Messiah Li	Relative Humidity	52%
Test Site	AC1	Test Date	2018/08/28
Remark:	<b>Harmonics Radiated Emission - 2404MHz</b>		

Frequency (MHz)	Reading Level (dBμV)	Factor (dB)	Duty Cycle Factor (dB)	Measure Level (dBμV/m)	Limit (dBμV/m)	Margin (dB)	Detector	Polarization
48.4	3.9	15.0	N/A	18.9	40.0	-21.1	QP	Horizontal
177.4	5.9	10.8	N/A	16.7	43.5	-26.8	QP	Horizontal
47.9	5.2	15.0	N/A	20.2	40.0	-19.8	QP	Vertical
63.0	5.6	13.2	N/A	18.9	40.0	-21.1	QP	Vertical
4808.0	38.4	5.9	N/A	44.3	74.0 (Note 2)	-29.7	PK	Horizontal
7212.0	35.4	12.6	N/A	48.0	74.0 (Note 2)	-26.0	PK	Horizontal
9616.0	33.4	15.4	N/A	48.8	74.0 (Note 2)	-25.2	PK	Horizontal
12020.0	34.3	17.4	N/A	51.7	74.0 (Note 2)	-22.3	PK	Horizontal
4808.0	40.7	5.9	N/A	46.6	74.0 (Note 2)	-27.4	PK	Vertical
7212.0	35.0	12.6	N/A	47.6	74.0 (Note 2)	-26.4	PK	Vertical
9616.0	33.5	15.4	N/A	48.9	74.0 (Note 2)	-25.1	PK	Vertical
12020.0	34.1	17.4	N/A	51.5	74.0 (Note 2)	-22.5	PK	Vertical

Note 1: Peak Measure Level (dBμV/m) = Reading Level (dBμV) + Factor (dB)

Average Measure Level = Peak Measure Level + Duty Cycle Factor

Factor (dB) = Cable Loss (dB) + Antenna Factor (dB/m) – Pre Amplifier Gain (dB)

Note 2: Average measurement was not performed when the peak level lower than average limit.

Note 3: The test trace is same as the ambient noise (the test frequency range: 9 kHz ~ 30 MHz and 18 GHz ~ 25 GHz), therefore no data appear in the report.

Product	Receiver	Temperature	25°C
Test Engineer	Messiah Li	Relative Humidity	52%
Test Site	AC1	Test Date	2018/08/28
Remark:	<b>Harmonics</b> Radiated Emission - 2440MHz		

Frequency (MHz)	Reading Level (dBμV)	Factor (dB)	Duty Cycle Factor (dB)	Measure Level (dBμV/m)	Limit (dBμV/m)	Margin (dB)	Detector	Polarization
48.9	4.1	15.0	N/A	19.1	40.0	-20.9	QP	Horizontal
117.3	6.1	11.7	N/A	17.8	43.5	-25.7	QP	Horizontal
47.9	5.6	15.0	N/A	20.6	40.0	-19.4	QP	Vertical
101.8	5.6	13.3	N/A	18.8	43.5	-24.7	QP	Vertical
4876.0	35.7	6.0	N/A	41.7	74.0 (Note 2)	-32.3	PK	Horizontal
7320.0	34.6	12.6	N/A	47.2	74.0 (Note 2)	-26.8	PK	Horizontal
9760.0	33.2	16.2	N/A	49.4	74.0 (Note 2)	-24.6	PK	Horizontal
12200.0	34.1	17.4	N/A	51.6	74.0 (Note 2)	-22.4	PK	Horizontal
4876.0	37.8	6.0	N/A	43.8	74.0 (Note 2)	-30.2	PK	Vertical
7320.0	36.0	12.6	N/A	48.6	74.0 (Note 2)	-25.4	PK	Vertical
9760.0	34.3	16.2	N/A	50.4	74.0 (Note 2)	-23.6	PK	Vertical
12200.0	34.0	17.4	N/A	51.4	74.0 (Note 2)	-22.6	PK	Vertical

Note 1: Measure Level (dBμV/m) = Reading Level (dBμV) + Factor (dB)

Average Measure Level = Peak Measure Level + Duty Cycle Factor

Factor (dB) = Cable Loss (dB) + Antenna Factor (dB/m) – Pre Amplifier Gain (dB)

Note 2: Average measurement was not performed when the peak level lower than average limit.

Note 3: The test trace is same as the ambient noise (the test frequency range: 9 kHz ~ 30 MHz and 18 GHz ~ 25 GHz), therefore no data appear in the report.

Product	Receiver	Temperature	25°C
Test Engineer	Messiah Li	Relative Humidity	52%
Test Site	AC1	Test Date	2018/08/28
Remark:	<b>Harmonics Radiated Emission - 2476MHz</b>		

Frequency (MHz)	Reading Level (dBμV)	Factor (dB)	Duty Cycle Factor (dB)	Measure Level (dBμV/m)	Limit (dBμV/m)	Margin (dB)	Detector	Polarization
119.2	6.5	11.5	N/A	17.9	43.5	-25.6	QP	Horizontal
823.9	7.8	23.3	N/A	31.2	46.0	-14.8	QP	Horizontal
126.0	5.2	10.5	N/A	15.6	43.5	-27.9	QP	Vertical
824.9	4.5	23.4	N/A	27.8	46.0	-18.2	QP	Vertical
4952.5	36.7	6.1	N/A	42.8	74.0 (Note 2)	-31.2	PK	Horizontal
7428.0	35.6	12.8	N/A	48.4	74.0 (Note 2)	-25.6	PK	Horizontal
9904.0	34.6	16.6	N/A	51.2	74.0 (Note 2)	-22.8	PK	Horizontal
12380.0	34.6	17.2	N/A	51.8	74.0 (Note 2)	-22.2	PK	Horizontal
4952.5	40.0	6.1	N/A	46.1	74.0 (Note 2)	-27.9	PK	Vertical
7426.0	38.0	12.8	N/A	50.8	74.0 (Note 2)	-23.2	PK	Vertical
9904.0	33.2	16.6	N/A	49.8	74.0 (Note 2)	-24.2	PK	Vertical
12380.0	33.8	17.2	N/A	51.0	74.0 (Note 2)	-23.0	PK	Vertical

Note 1: Measure Level (dBμV/m) = Reading Level (dBμV) + Factor (dB)

Average Measure Level = Peak Measure Level + Duty Cycle Factor

Factor (dB) = Cable Loss (dB) + Antenna Factor (dB/m) – Pre Amplifier Gain (dB)

Note 2: Average measurement was not performed when the peak level lower than average limit.

Note 3: The test trace is same as the ambient noise (the test frequency range: 9 kHz ~ 30 MHz and 18 GHz ~ 25 GHz), therefore no data appear in the report.

## 7.4. Radiated Restricted Band Edge Measurement

### 7.4.1. Test Limit

#### For 15.205 requirement:

Radiated emissions which fall in the restricted bands, as defined in Section 15.205(a) of FCC part 15, must also comply with the radiated emission limits specified in Section 15.209(a).

Frequency (MHz)	Frequency (MHz)	Frequency (MHz)	Frequency (GHz)
0.090 - 0.110	16.42 - 16.423	399.9 - 410	4.5 - 5.15
<sup>1</sup> 0.495 - 0.505	16.69475 - 16.69525	608 - 614	5.35 - 5.46
2.1735 - 2.1905	16.80425 - 16.80475	960 - 1240	7.25 - 7.75
4.125 - 4.128	25.5 - 25.67	1300 - 1427	8.025 - 8.5
4.17725 - 4.17775	37.5 - 38.25	1435 - 1626.5	9.0 - 9.2
4.20725 - 4.20775	73 - 74.6	1645.5 - 1646.5	9.3 - 9.5
6.215 - 6.218	74.8 - 75.2	1660 - 1710	10.6 - 12.7
6.26775 - 6.26825	108 - 121.94	1718.8 - 1722.2	13.25 - 13.4
6.31175 - 6.31225	123 - 138	2200 - 2300	14.47 - 14.5
8.291 - 8.294	149.9 - 150.05	2310 - 2390	15.35 - 16.2
8.362 - 8.366	156.52475 - 156.525	2483.5 - 2500	17.7 - 21.4
8.37625 - 8.38675	156.7 - 156.9	2690 - 2900	22.01 - 23.12
8.41425 - 8.41475	162.0125 - 167.17	3260 - 3267	23.6 - 24.0
12.29 - 12.293	167.72 - 173.2	3332 - 3339	31.2 - 31.8
12.51975 - 12.52025	240 - 285	3345.8 - 3358	36.43 - 36.5
12.57675 - 12.57725	322 - 335.4	3600 - 4400	( <sup>2</sup> )
13.36 - 13.41	--	--	--



All out of band emissions appearing in a restricted band as specified in Section 15.205 of the Title 47 CFR must not exceed the limits shown in Table per Section 15.209.

FCC Part 15 Subpart C Paragraph 15.209		
Frequency [MHz]	Field Strength [ $\mu\text{V}/\text{m}$ ]	Measured Distance [Meters]
0.009 ~ 0.490	2400/F (kHz)	300
0.490 ~ 1.705	24000/F (kHz)	30
1.705 ~ 30	30	30
30 ~ 88	100	3
88 ~ 216	150	3
216 ~ 960	200	3
Above 960	500	3

**For RSS-Gen Section 8.10 Requirement:**

Radiated emissions which fall in the restricted bands, as defined in Section 8.10 of RSS-Gen, must also comply with the radiated emission limits specified in Section 8.9.

Frequency (MHz)	Frequency (MHz)	Frequency (MHz)
0.009 - 0.110	149.9 - 150.5	9.0 - 9.2
0.495 - 0.505	156.52475 - 156.525225	9.3 - 9.5
2.1735 - 2.1905	156.7 - 156.9	10.6 - 12.7
3.020 - 3.026	162.0125 - 167.17	13.25 - 13.4
4.125 - 4.128	167.72 - 173.2	14.47 - 14.5
4.17725 - 4.17775	240 - 285	15.35 - 16.2
4.20725 - 4.20775	322 - 335.4	17.7 - 21.4
5.677 - 5.683	399.9 - 410	22.01 - 23.12
6.215 - 6.218	608 - 614	23.6 - 24.0
6.26775 - 6.26825	960 - 1427	31.2 - 31.8
6.31175 - 6.31225	1435 - 1626.5	36.43 - 36.5
8.291 - 8.294	1645.5 - 1646.5	Above 38.6
8.362 - 8.366	1660 - 1710	--
8.37625 - 8.38675	1718.8 - 1722.2	
8.41425 - 8.41475	2200 - 2300	
12.29 - 12.293	2310 - 2390	
12.51975 - 12.52025	2483.5 - 2500	
12.57675 - 12.57725	2655 - 2900	
13.36 - 13.41	3260 - 3267	
16.42 - 16.423	3332 - 3339	
16.69475 - 16.69525	334.5 - 3358	
16.80425 - 16.80475	3500 - 4400	
25.5 - 25.67	4500 - 5150	
37.5 - 38.25	5350 - 5460	
73 - 74.6	7250 - 7750	
74.8 - 75.2	8025 - 8500	
108 - 138	--	

Note: \*Certain frequency bands listed in Table 6 and in bands above 38.6 GHz are designated for licence-exempt applications. These frequency bands and the requirements that apply to the devices are set out in the 200- and 300-series of RSSs, such as RSS-210 and RSS-310, which contain the

requirements that apply to licence-exempt radio apparatus.

### 7.4.2. Test Setup

#### 1GHz ~ 18GHz Test Setup:

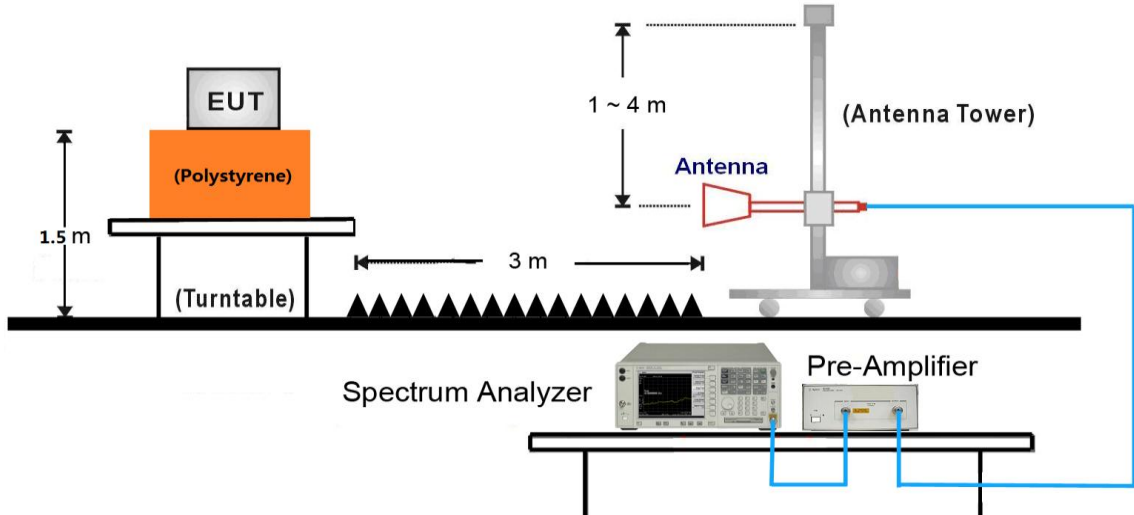

### 7.4.3. Test Result

Site: AC1	Time: 2018/08/28 - 20:47
Limit: FCC_Part15.209_RE(3m)	Engineer: Messiah Li
Probe: BBHA9120D_1-18GHz	Polarity: Horizontal
EUT: Receiver	Power: By Battery
Test Mode: Transmit at low channel 2404MHz	

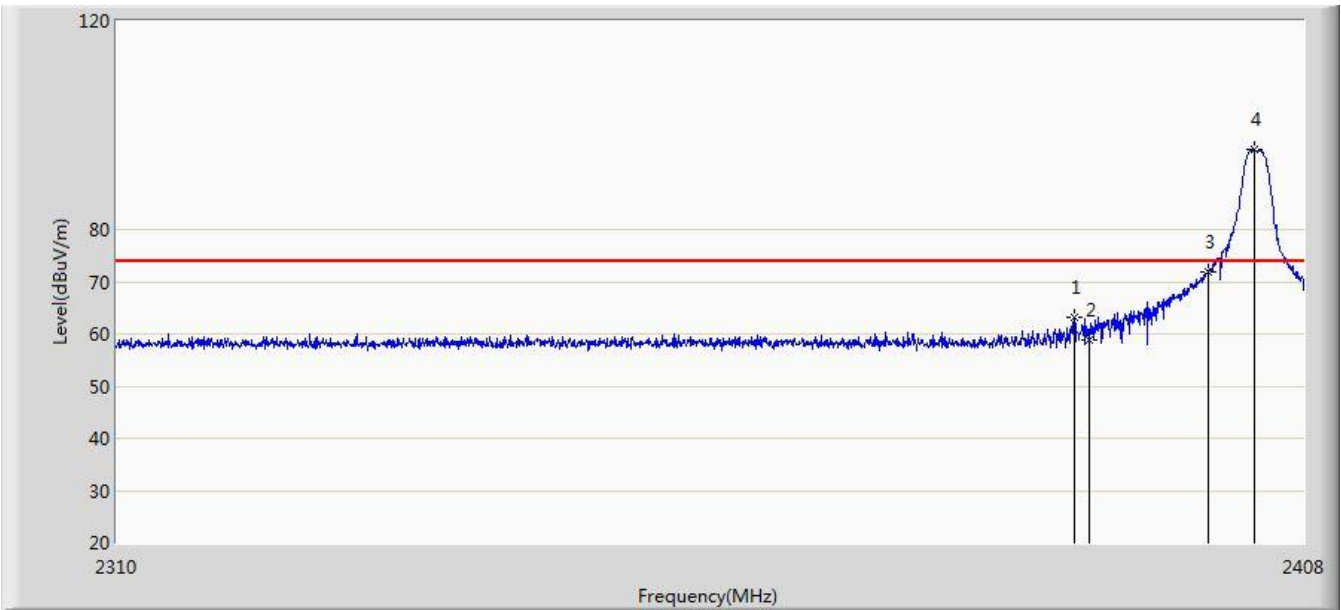

No	Flag	Mark	Frequency (MHz)	Reading Level (dBuV)	Factor (dB)	Duty Cycle Factor (dB)	Measure Level (dBuV/m)	Limit (dBuV/m)	Over Limit (dB)	Type
1			2388.792	30.957	32.329	N/A	63.286	74.000	-10.714	PK
			2388.792	30.957	32.329	-37.52	25.762	54.000	-28.238	AV
2			2390.000	26.377	32.327	N/A	58.704	74.000	-15.296	PK
			2390.000	26.377	32.327	-37.52	21.180	54.000	-32.820	AV
3			2400.000	39.527	32.309	N/A	71.836	74.000	-2.164	PK
			2400.000	39.527	32.309	-37.52	34.312	54.000	-19.688	AV
4			2403.884	62.923	32.3	N/A	95.223	114.000	-18.777	PK

Note: Peak Measure Level (dB $\mu$ V/m) = Reading Level (dB $\mu$ V) + Factor (dB)

Average Measure Level = Peak Measure Level + Duty Cycle Factor

Factor (dB) = Cable Loss (dB) + Antenna Factor (dB/m)

Site: AC1	Time: 2018/08/28 - 20:48
Limit: FCC_Part15.209_RE(3m)	Engineer: Messiah Li
Probe: BBHA9120D_1-18GHz	Polarity: Vertical
EUT: Receiver	Power: By Battery
Test Mode: Transmit at low channel 2404MHz	

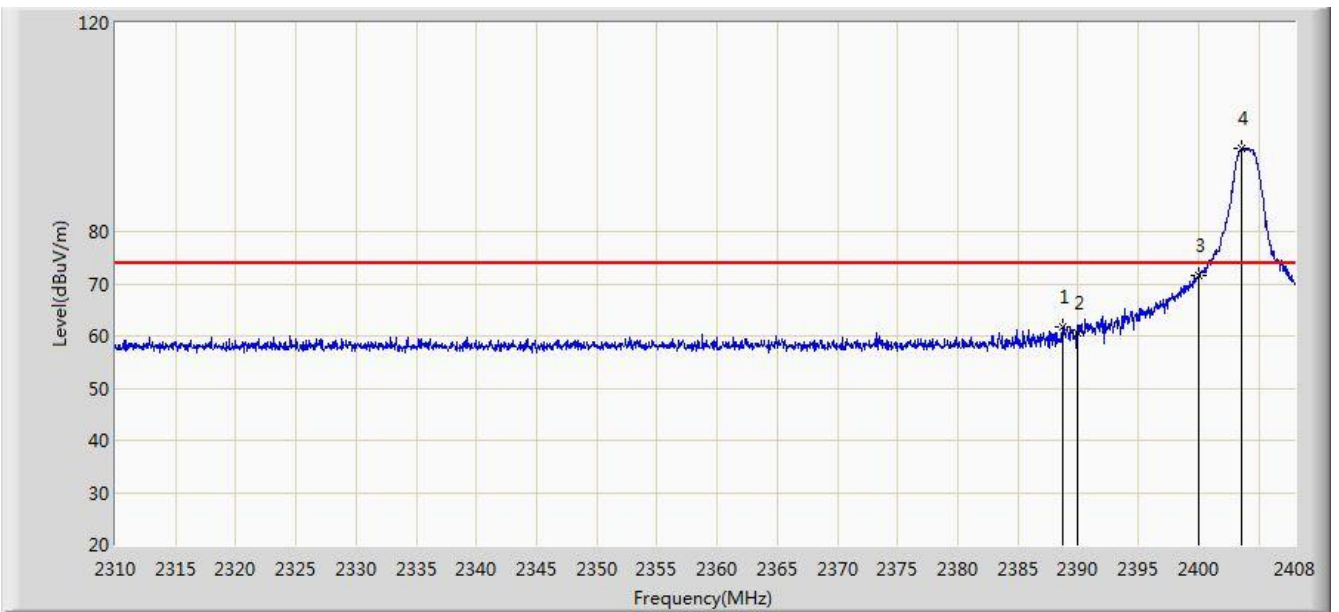

No	Flag	Mark	Frequency (MHz)	Reading Level (dBuV)	Factor (dB)	Duty Cycle Factor (dB)	Measure Level (dBuV/m)	Limit (dBuV/m)	Over Limit (dB)	Type
1			2388.743	29.554	32.329	N/A	61.883	74.000	-12.117	PK
			2388.743	29.554	32.329	-37.52	24.359	54.000	-29.641	AV
2			2390.000	28.356	32.327	N/A	60.683	74.000	-13.317	PK
			2390.000	28.356	32.327	-37.52	23.159	54.000	-30.841	AV
3			2400.000	39.277	32.309	N/A	71.586	74.000	-2.414	PK
			2400.000	39.277	32.309	-37.52	34.062	54.000	-19.938	AV
4		*	2403.59	63.639	32.301	N/A	95.94	114.000	-18.06	PK

Note: Peak Measure Level (dB $\mu$ V/m) = Reading Level (dB $\mu$ V) + Factor (dB)

Average Measure Level = Peak Measure Level + Duty Cycle Factor

Factor (dB) = Cable Loss (dB) + Antenna Factor (dB/m)

Site: AC1	Time: 2018/08/28 - 20:24
Limit: FCC_Part15.209_RE(3m)	Engineer: Messiah Li
Probe: BBHA9120D_1-18GHz	Polarity: Horizontal
EUT: Receiver	Power: By Battery
Test Mode: Transmit at high channel 2476MHz	

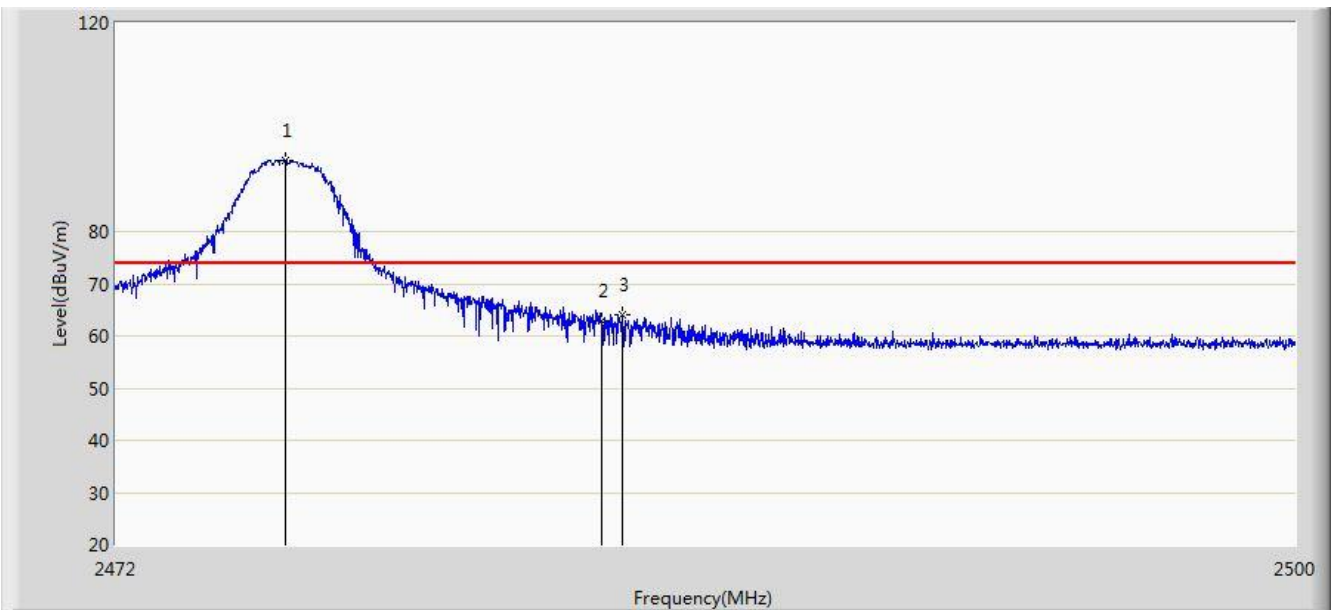

No	Flag	Mark	Frequency (MHz)	Reading Level (dBuV)	Factor (dB)	Duty Cycle Factor (dB)	Measure Level (dBuV/m)	Limit (dBuV/m)	Over Limit (dB)	Type
1		*	2476.018	61.297	32.314	N/A	93.611	114.000	-20.389	PK
2			2483.500	30.553	32.340	N/A	62.893	74.000	-11.107	PK
			2483.500	30.553	32.340	-37.52	25.369	54.000	-28.631	AV
3			2483.998	31.706	32.342	N/A	64.048	74.000	-9.952	PK
			2483.998	31.706	32.342	-37.52	26.524	54.000	-27.476	AV

Note: Peak Measure Level (dB $\mu$ V/m) = Reading Level (dB $\mu$ V) + Factor (dB)

Average Measure Level = Peak Measure Level + Duty Cycle Factor

Factor (dB) = Cable Loss (dB) + Antenna Factor (dB/m)

Site: AC1	Time: 2018/08/28 - 20:34
Limit: FCC_Part15.209_RE(3m)	Engineer: Messiah Li
Probe: BBHA9120D_1-18GHz	Polarity: Vertical
EUT: Receiver	Power: By Battery
Test Mode: Transmit at high channel 2476MHz	

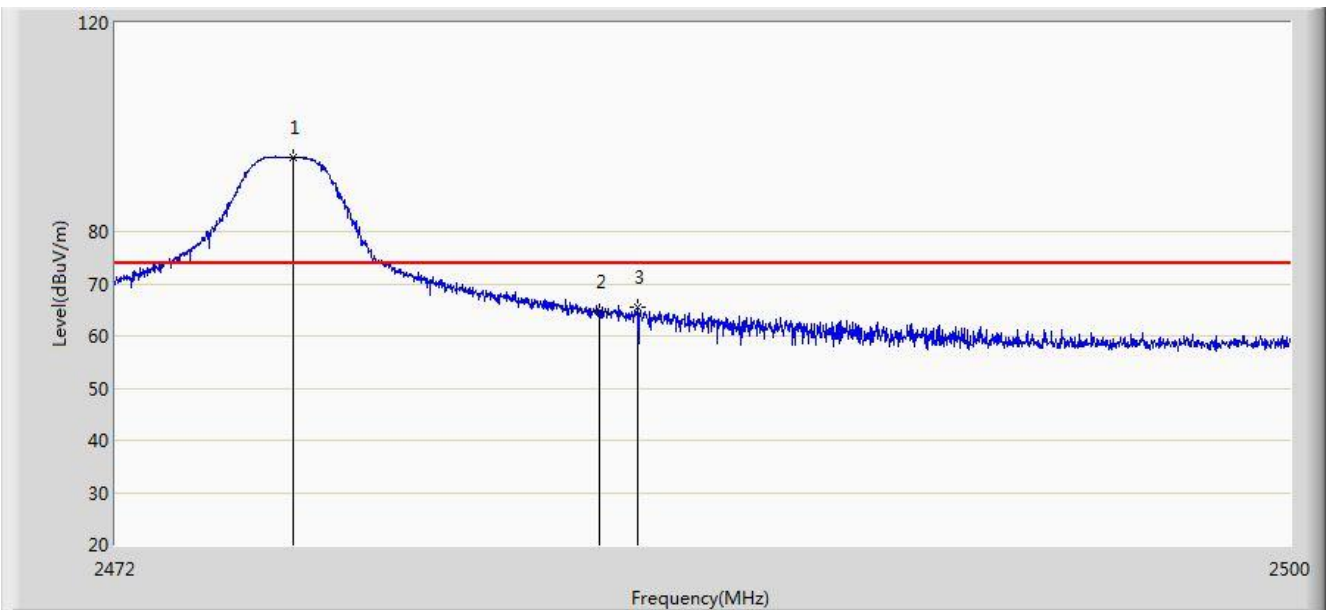

No	Flag	Mark	Frequency (MHz)	Reading Level (dBuV)	Factor (dB)	Duty Cycle Factor (dB)	Measure Level (dBuV/m)	Limit (dBuV/m)	Over Limit (dB)	Type
1		*	2476.228	61.784	32.314	N/A	94.098	114.000	-19.902	PK
2			2483.500	32.220	32.340	N/A	64.560	74.000	-9.440	PK
			2483.500	32.220	32.340	-37.52	27.036	54.000	-26.964	AV
3			2484.404	33.109	32.342	N/A	65.451	74.000	-8.549	PK
			2484.404	33.109	32.342	-37.52	27.927	54.000	-26.073	AV

Note: Peak Measure Level (dB $\mu$ V/m) = Reading Level (dB $\mu$ V) + Factor (dB)

Average Measure Level = Peak Measure Level + Duty Cycle Factor

Factor (dB) = Cable Loss (dB) + Antenna Factor (dB/m)

## 7.5. 20dB Spectrum Bandwidth Measurement

### 7.5.1. Test Limit

Intentional radiators must be designed to ensure that the 20 dB bandwidth of the emission in the specific band (2404 ~ 2476).

### 7.5.2. Test Procedure used

ANSI C63.10 Clause 6.9.2

### 7.5.3. Test Setting

1. Set the spectrum span range to overlap the nominal center frequency
2. Set RBW = 100 kHz
3. VBW  $\geq 3 \times$  RBW
4. Detector = Peak
5. Trace mode = max hold
6. Sweep = auto couple
7. Allow the trace was allowed to stabilize and marker the highest level.
8. Determine the display level (the highest level - 20dB) and place two markers, one at the lowest frequency and the other at the highest frequency.

### 7.5.4. Test Setup

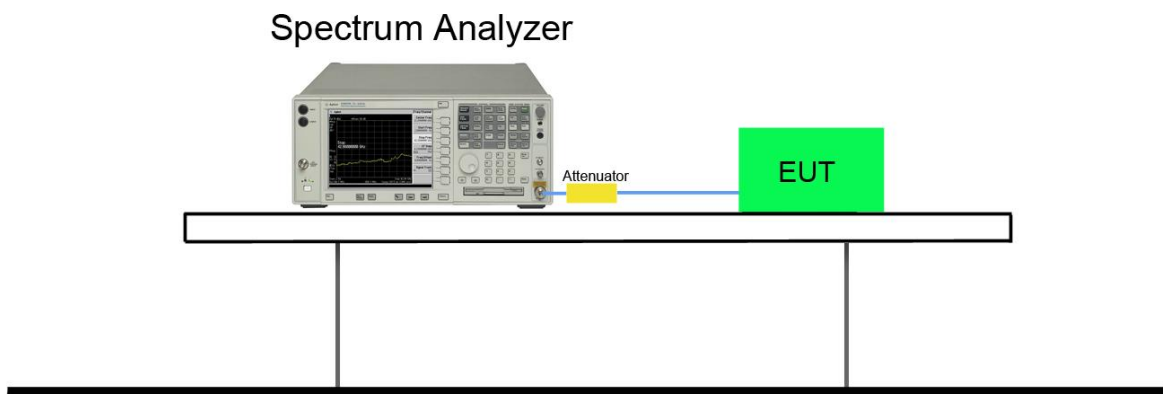



**7.5.5. Test Result**

Product	Receiver	Temperature	24°C
Test Engineer	Messiah Li	Relative Humidity	59%
Test Site	AC1	Test Date	2018/08/28

Frequency (MHz)	Frequency Range (MHz)	Frequency Range (MHz)	Result
2404	2403.23	---	Pass
2476	---	2476.79	Pass

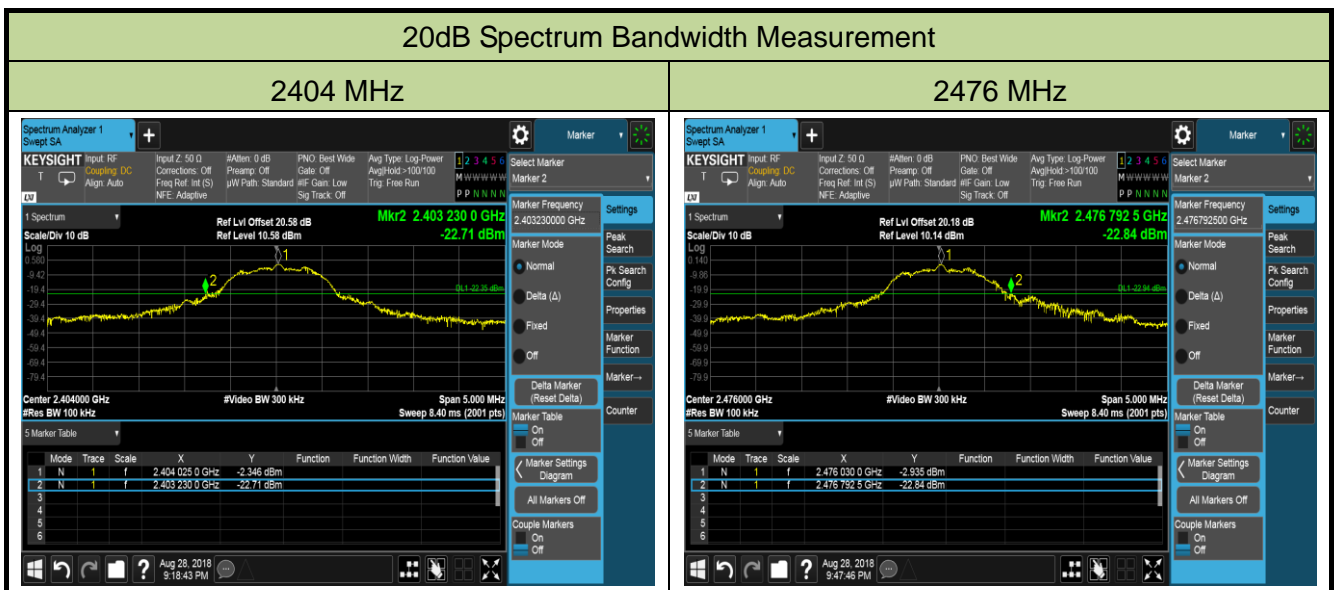

## 7.6. 99% Bandwidth Measurement

### 7.6.1. Test Limit

N/A

### 7.6.2. Test Procedure used

ANSI C63.10 Section 6.9

### 7.6.3. Test Setting

1. The analyzers' automatic bandwidth measurement capability was used to perform the 99% bandwidth measurement. The bandwidth measurement was not influenced by any intermediated power nulls in the fundamental emission.
2. RBW = approximately 1% to 5% of the OBW.
3. VBW  $\geq 3 \times$  RBW.
4. Detector = Peak.
5. Trace mode = max hold.

### 7.6.4. Test Setup

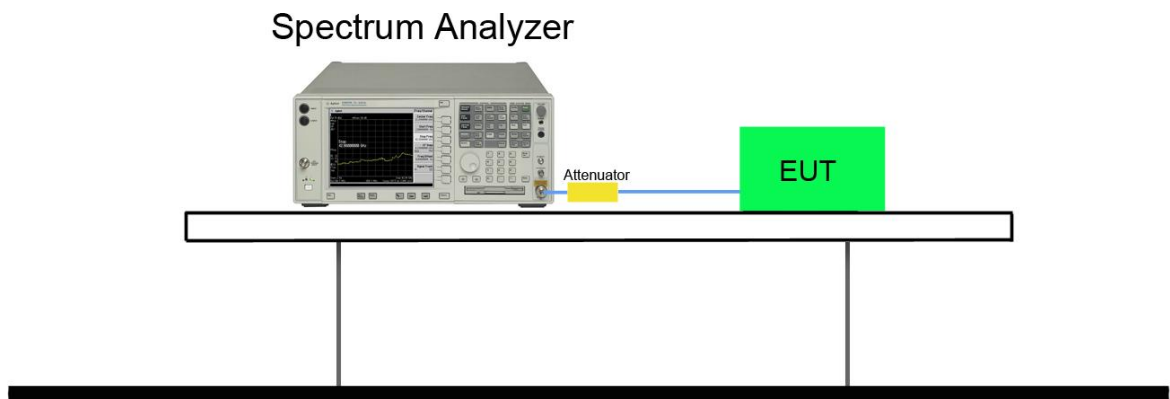

### 7.6.5. Test Result

Product	Receiver	Temperature	24°C
Test Engineer	Messiah Li	Relative Humidity	59%
Test Site	AC1	Test Date	2018/08/28

Frequency (MHz)	99% Bandwidth (MHz)
2404	1.14
2440	1.14
2476	1.17

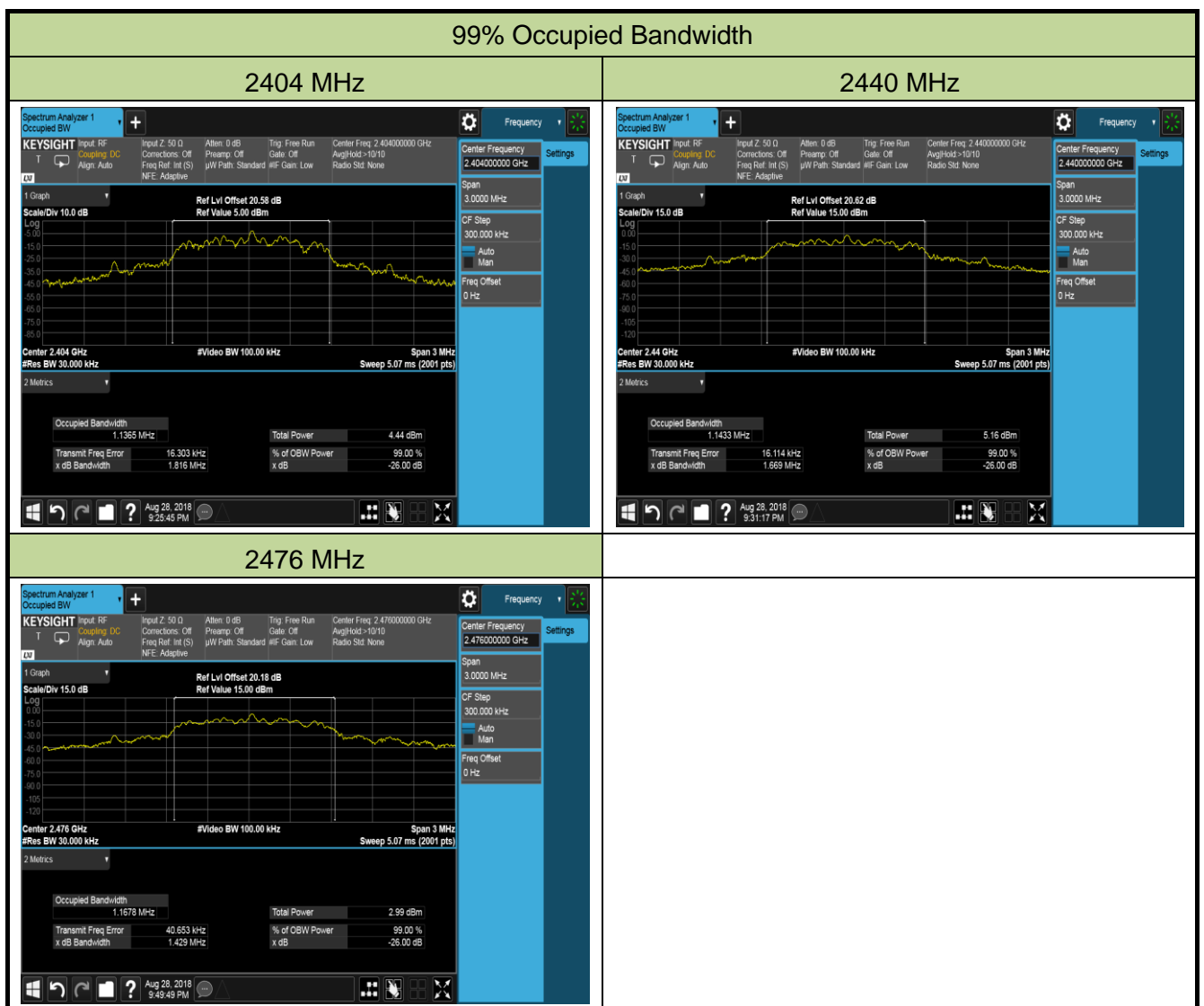

## 8. CONCLUSION

The data collected relate only the item(s) tested and show that the **Receiver** is in compliance with Part 15C of the FCC Rules and ISED Rules.

## Appendix A – Test Setup Photograph

Refer to “1808RSU054-UT” file.

\_\_\_\_\_ The End \_\_\_\_\_

## Appendix B – EUT Photograph

Refer to “1808RSU054-UE” file.