



# MEASUREMENT REPORT

## FCC PART 15.249 / RSS-210

---

**FCC ID:** BRWEFLA6420BL

**IC:** 6157A-EFLA6420BL

**APPLICANT:** Horizon Hobby, LLC

**Application Type:** Certification

**Product:** AS6240BL Rx DSMX 6-Ch AS3X (SAFE BL ESC)

**Model No.:** EFLA6420BL

**Brand Name:** E-flite

**FCC Classification:** Low Power Transceiver, Rx Verified (DXT)

**FCC Rule Part(s):** Part 15.249

**IC Rule(s):** RSS-210 Issue 9, RSS-GEN Issue 4

**Test Procedure(s):** ANSI C63.10 - 2013

**Test Date:** July 22 ~ September 30, 2017

Reviewed By : Jame Yuan  
( Jame Yuan )

Approved By : Marlin Chen  
( Marlin Chen )



The test results relate only to the samples tested.

This equipment has been shown to be capable of compliance with the applicable technical standards as indicated in the measurement report and was tested in accordance with the measurement procedures specified in ANSI C63.10-2013. Test results reported herein relate only to the item(s) tested.

The test report shall not be reproduced except in full without the written approval of MRT Technology (Suzhou) Co., Ltd.

### Revision History

Report No.	Version	Description	Issue Date	Note
1707RSU02901	Rev. 01	Initial report	07-30-2017	Invalid
1707RSU02901	Rev. 02	Revised some test data	10-07-2017	Invalid
1707RSU02901	Rev. 03	Revised some information	10-12-2017	Valid

---

## CONTENTS

Description	Page
<b>1. INTRODUCTION .....</b>	<b>6</b>
1.1. Scope .....	6
1.2. MRT Test Location .....	6
<b>2. PRODUCT INFORMATION .....</b>	<b>7</b>
2.1. Equipment Description.....	7
2.2. Operation Frequency and Channel List.....	7
2.3. Test Configuration .....	7
2.4. EMI Suppression Device(s)/Modifications.....	7
2.5. Labeling Requirements.....	8
<b>3. DESCRIPTION OF TEST .....</b>	<b>9</b>
3.1. Evaluation Procedure .....	9
3.2. AC Line Conducted Emissions .....	9
3.3. Radiated Emissions.....	10
<b>4. ANTENNA REQUIREMENTS .....</b>	<b>11</b>
<b>5. TEST EQUIPMENT CALIBRATION DATE .....</b>	<b>12</b>
<b>6. MEASUREMENT UNCERTAINTY.....</b>	<b>13</b>
<b>7. TEST RESULT .....</b>	<b>14</b>
7.1. Summary .....	14
7.2. Conducted Emission.....	16
7.2.1. Test Limit .....	16
7.2.2. Test Setup.....	16
7.2.3. Test Result.....	16
7.3. Radiated Emission.....	17
7.3.1. Test Limit .....	17
7.3.2. Test Setup.....	18
7.3.3. Test Result.....	20
7.4. Radiated Restricted Band Edge Measurement .....	25
7.4.1. Test Result.....	25
7.5. 20dB Spectrum Bandwidth Measurement .....	29
7.5.1. Test Limit .....	29
7.5.2. Test Procedure used.....	29
7.5.3. Test Setting.....	29
7.5.4. Test Setup.....	29

---

7.5.5.	Test Result.....	30
7.6.	99% Bandwidth Measurement.....	31
7.6.1.	Test Limit .....	31
7.6.2.	Test Procedure used.....	31
7.6.3.	Test Setting.....	31
7.6.4.	Test Setup.....	31
7.6.5.	Test Result.....	32
<b>8.</b>	<b>CONCLUSION.....</b>	<b>33</b>

## §2.1033 General Information

<b>Applicant:</b>	Horizon Hobby, LLC
<b>Applicant Address:</b>	4105 Fieldstone Rd., Champaign, IL 61822
<b>Manufacturer:</b>	Yunee International (China) Co., Ltd.
<b>Manufacturer Address:</b>	No.388 East Zhengwei Road, Jinxi Town, Kunshan, Jiangsu
<b>Test Site:</b>	MRT Technology (Suzhou) Co., Ltd
<b>Test Site Address:</b>	D8 Building, Youxin Industrial Park, No.2 Tian'edang Rd., Wuzhong Economic Development Zone, Suzhou, China
<b>FCC Registration No.:</b>	809388
<b>IC Registration No.:</b>	11384A
<b>FCC Rule Part(s):</b>	Part 15.249
<b>IC Rule:</b>	RSS-210 Issue 9, RSS-GEN Issue 4
<b>FCC ID:</b>	BRWEFLA6420BL
<b>IC:</b>	6157A-EFLA6420BL
<b>Test Device Serial No.:</b>	N/A <input type="checkbox"/> Production <input checked="" type="checkbox"/> Pre-Production <input type="checkbox"/> Engineering
<b>FCC Classification:</b>	Low Power Transceiver, Rx Verified (DXT)

### Test Facility / Accreditations

Measurements were performed at MRT Laboratory located in Tian'edang Rd., Suzhou, China.

- MRT facility is a FCC registered (MRT Reg. No. 809388) test facility with the site description report on file and has met all the requirements specified in Section 2.948 of the FCC Rules.
- MRT facility is an IC registered (MRT Reg. No. 11384A-1) test laboratory with the site description on file at Industry Canada.
- MRT facility is a VCCI registered (R-4179, G-814, C-4664, T-2206) test laboratory with the site description on file at VCCI Council.
- MRT Lab is accredited to ISO 17025 by the American Association for Laboratory Accreditation (A2LA) under the American Association for Laboratory Accreditation Program (A2LA Cert. No. 3628.01) in EMC, Telecommunications and Radio testing for FCC, Industry Canada, EU and TELEC Rules.



# 1. INTRODUCTION

## 1.1. Scope

Measurement and determination of electromagnetic emissions (EMC) of radio frequency devices including intentional and/or unintentional radiators for compliance with the technical rules and regulations of the Federal Communications Commission and the Industry Canada Certification and Engineering Bureau.

## 1.2. MRT Test Location

The map below shows the location of the MRT LABORATORY, its proximity to the Taihu Lake. These measurement tests were conducted at the MRT Technology (Suzhou) Co., Ltd. Facility located at D8 Building, Youxin Industrial Park, No.2 Tian'edang Rd., Wuzhong Economic Development Zone, Suzhou, China. The detailed description of the measurement facility was found to be in compliance with the requirements of § 2.948 according to ANSI C63.4-2009 on September 30, 2013.



## 2. PRODUCT INFORMATION

### 2.1. Equipment Description

Product Name	AS6240BL Rx DSMX 6-Ch AS3X (SAFE BL ESC)
Model No.	EFLA6420BL
Frequency Range	2404 ~ 2476 MHz
Channel Number	23
Type of Modulation	GFSK
Host Product Name	UMX Timber
Host Model No.	EFLU3950

### 2.2. Operation Frequency and Channel List

Channel	Frequency	Channel	Frequency
01	2404 MHz	02	2412 MHz
03	2416 MHz	04	2418 MHz
05	2422 MHz	06	2424 MHz
07	2426 MHz	08	2428 MHz
09	2430 MHz	10	2432 MHz
11	2434 MHz	12	2438 MHz
13	2440 MHz	14	2444 MHz
15	2452 MHz	16	2460 MHz
17	2462 MHz	18	2464 MHz
19	2466 MHz	20	2468 MHz
21	2470 MHz	22	2472 MHz
23	2476 MHz	---	---

### 2.3. Test Configuration

The EUT was tested as described in this report is in compliance with the requirements limits of FCC Rules Part 15.207, 15.209, 15.215 and 15.249. ANSI C63.10-2013 was used to reference the appropriate EUT setup for radiated spurious emissions testing and AC line conducted testing.

### 2.4. EMI Suppression Device(s)/Modifications

No EMI suppression device(s) were added and/or no modifications were made during testing.

## 2.5. Labeling Requirements

Per 2.1074 & 15.19; Docket 95-19

The label shall be permanently affixed at a conspicuous location on the device; instruction manual or pamphlet supplied to the user and be readily visible to the purchaser at the time of purchase.

However, when the device is so small wherein placement of the label with specified statement is not practical, only the FCC ID must be displayed on the device per Section 15.19(a)(5). Please see attachment for FCC ID label and label location.

RSP-100 Issue 11 Section 3

The manufacturer, importer or distributor shall meet the labelling requirements set out in this section for every unit:

- (i) prior to marketing in Canada, for products manufactured in Canada
- (ii) prior to importation into Canada, for imported products

For information regarding the e-labelling option, see Notice 2014–DRS1003. The label for the certified product represents the manufacturer's or importer's compliance with Innovation, Science and Economic Development Canada's (ISED) regulatory requirements.

Please see attachment for IC label and label location.



### 3. DESCRIPTION OF TEST

#### 3.1. Evaluation Procedure

The measurement procedures described in the American National Standard for Testing Unlicensed Wireless Devices (ANSI C63.10-2013), and the requirements provided in FCC 15.207, 15.209, 15.215 and 15.249 were performed in the report of the EUT.

**Deviation from measurement procedure.....None**

#### 3.2. AC Line Conducted Emissions

The line-conducted facility is located inside an 8'x4'x4' shielded enclosure. A 1m x 2m wooden table 80cm high is placed 40cm away from the vertical wall and 80cm away from the sidewall of the shielded room. Two 10kHz-30MHz, 50Ω/50uH Line-Impedance Stabilization Networks (LISNs) are bonded to the shielded room floor. Power to the LISNs is filtered by external high-current high-insertion loss power line filters. These filters attenuate ambient signal noise from entering the measurement lines. These filters are also bonded to the shielded enclosure.

The EUT is powered from one LISN and the support equipment is powered from the second LISN. All interconnecting cables more than 1 meter were shortened to a 1 meter length by non-inductive bundling (serpentine fashion) and draped over the back edge of the test table. All cables were at least 40cm above the horizontal reference ground-plane. Power cables for support equipment were routed down to the second LISN while ensuring that that cables were not draped over the second LISN.

Sufficient time for the EUT, support equipment, and test equipment was allowed in order for them to warm up to their normal operating condition. The RF output of the LISN was connected to the receiver and exploratory measurements were made to determine the frequencies producing the maximum emission from the EUT. The receiver was scanned from 150kHz to 30MHz. The detector function was set to peak mode for exploratory measurements while the bandwidth of the analyzer was set to 9kHz. The EUT, support equipment, and interconnecting cables were arranged and manipulated to maximize each emission. Each emission was also maximized by varying: power lines, the mode of operation or data exchange speed, or support equipment whichever determined the worst-case emission. Once the worst case emissions have been identified, the one EUT cable configuration/arrangement and mode of operation that produced these emissions are used for final measurements on the same test site. The analyzer is set to CISPR quasi-peak and average detectors with a 9kHz resolution bandwidth for final measurements.

An extension cord was used to connect to a single LISN which powered by EUT. The extension cord was calibrated with LISN, the impedance and insertion loss are compliance with the requirements as stated in ANSI C63.10-2013.

Line conducted emissions test results are shown in Section 7.2.

### 3.3. Radiated Emissions

The radiated test facilities consisted of an indoor 3 meter semi-anechoic chamber used for final measurements and exploratory measurements, when necessary. The measurement area is contained within the semi-anechoic chamber which is shielded from any ambient interference. For measurements above 1GHz absorbers are arranged on the floor between the turn table and the antenna mast in such a way so as to maximize the reduction of reflections. For measurements below 1GHz, the absorbers are removed. A MF Model 210SS turntable is used for radiated measurement. It is a continuously rotatable, remote controlled, metallic turntable and 2 meters (6.56 ft.) in diameter. The turn table is flush with the raised floor of the chamber in order to maintain its function as a ground plane. An 80cm high PVC support structure is placed on top of the turntable.

For all measurements, the spectrum was scanned through all EUT azimuths and from 1 to 4 meter receive antenna height using a broadband antenna from 30MHz up to the upper frequency shown in 15.33(b)(1) depending on the highest frequency generated or used in the device or on which the device operates or tunes. For frequencies above 1GHz, linearly polarized double ridge horn antennas were used. For frequencies below 30MHz, a calibrated loop antenna was used. When exploratory measurements were necessary, they were performed at 1 meter test distance inside the semi-anechoic chamber using broadband antennas, broadband amplifiers, and spectrum analyzers to determine the frequencies and modes producing the maximum emissions. Sufficient time for the EUT, support equipment, and test equipment was allowed in order for them to warm up to their normal operating condition. The test set-up for frequencies below 1GHz was placed on top of the 0.8 meter high, 1 x 1.5 meter table; and test set-up for frequencies 1-25GHz was placed on top of the 1.5 meter high, 1 x 1.5 meter table. The EUT, support equipment, and interconnecting cables were arranged and manipulated to maximize each emission. Appropriate precaution was taken to ensure that all emissions from the EUT were maximized and investigated. The system configuration, clock speed, mode of operation or video resolution, if applicable, turntable azimuth, and receive antenna height was noted for each frequency found.

Final measurements were made in the semi-anechoic chamber using calibrated, linearly polarized broadband and horn antennas. The test setup was configured to the setup that produced the worst case emissions. The spectrum analyzer was set to investigate all frequencies required for testing to compare the highest radiated disturbances with respect to the specified limits. The turntable containing the EUT was rotated through 360 degrees and the height of the receive antenna was varied 1 to 4 meters and stopped at the azimuth and height producing the maximum emission. Each emission was maximized by changing the orientation of the EUT through three orthogonal planes and changing the polarity of the receive antenna, whichever produced the worst-case emissions. According to 3dB Beam-Width of horn antenna, the horn antenna should be always directed to the EUT when rising height.

## 4. ANTENNA REQUIREMENTS

### Excerpt from §15.203 of the FCC Rules/Regulations:

“An intentional radiator antenna shall be designed to ensure that no antenna other than that furnished by the responsible party can be used with the device. The use of a permanently attached antenna or of an antenna that uses a unique coupling to the intentional radiator shall be considered sufficient to comply with the provisions of this section.”

- The antenna of the EUT **is permanently attached.**
- There are no provisions for connection to an external antenna.

### **Conclusion:**

This unit complies with the requirement of §15.203.

## 5. TEST EQUIPMENT CALIBRATION DATE

### Conducted Emissions - SR2

Instrument	Manufacturer	Type No.	Asset No.	Cali. Interval	Cali. Due Date
EMI Test Receiver	R&S	ESR7	MRTSUE06001	1 year	2018/06/20
Two-Line V-Network	R&S	ENV216	MRTSUE06002	1 year	2018/06/20
Two-Line V-Network	R&S	ENV216	MRTSUE06003	1 year	2018/06/20
Temperature/Humidity Meter	Yuhuaze	HTC-2	MRTSUE06181	1 year	2017/12/20
Shielding Anechoic Chamber	Mikebang	Chamber-SR2	MRTSUE06214	1 year	2018/05/10

### Radiated Emission - AC2

Instrument	Manufacturer	Type No.	Asset No.	Cali. Interval	Cal. Due Date
MXE EMI Receiver	Agilent	N9038A	MRTSUE06125	1 year	2017/08/03
Broadband Coaxial Pre-amplifier	Schwarzbeck	BBV 9718	MRTSUE06176	1 year	2017/12/10
Loop Antenna	Schwarzbeck	FMZB1519	MRTSUE06025	1 year	2017/11/21
TRILOG Antenna	Schwarzbeck	VULB9162	MRTSUE06022	1 year	2017/10/22
Broad-Band Horn Antenna	Schwarzbeck	BBHA9120D	MRTSUE06171	1 year	2017/11/19
Broadband Horn Antenna	Schwarzbeck	BBHA9170	MRTSUE06024	1 year	2018/01/04
Digital Thermometer & Hygrometer	Minggao	ETH529	MRTSUE06170	1 year	2017/11/30
Anechoic Chamber	RIKEN	Chamber-AC2	MRTSUE06213	1 year	2018/05/10

### Conducted Test Equipment - TR3

Instrument	Manufacturer	Type No.	Asset No.	Cali. Interval	Cali. Due Date
MXE EMI Receiver	Agilent	N9038A	MRTSUE06125	1 year	2017/08/03
Temperature/Humidity Meter	Yuhuaze	HTC-2	MRTSUE06180	1 year	2017/12/20

Software	Version	Function
e3	V8.3.5	EMI Test Software

## 6. MEASUREMENT UNCERTAINTY

Where relevant, the following test uncertainty levels have been estimated for tests performed on the EUT as specified in CISPR 16-4-2. This uncertainty represents an expanded uncertainty expressed at approximately the 95% confidence level using a coverage factor of  $k = 2$ .

<b>AC Conducted Emission Measurement - SR2</b>
Measuring Uncertainty for a Level of Confidence of 95% ( $U=2Uc(y)$ ): 150kHz~30MHz: 3.46dB
<b>Radiated Emission Measurement - AC2</b>
Measuring Uncertainty for a Level of Confidence of 95% ( $U=2Uc(y)$ ): 9kHz ~ 1GHz: 4.18dB 1GHz ~ 25GHz: 4.76dB
<b>20dB Spectrum Bandwidth - TR3</b>
Measuring Uncertainty for a Level of Confidence of 95% ( $U=2Uc(y)$ ): 0.28%

## 7. TEST RESULT

### 7.1. Summary

**Company Name:** Horizon Hobby, LLC  
**Product:** AS6240BL Rx DSMX 6-Ch AS3X (SAFE BL ESC)  
**FCC ID:** BRWEFLA6420BL  
**IC:** 6157A-EFLA6420BL

FCC Part Section(s)	Test Description	Test Limit	Test Condition	Test Result	Reference
15.207	AC Conducted Emissions 150kHz - 30MHz	< FCC 15.207 limits	Line Conducted	Pass	Section 7.2
15.209 15.249	General Field Strength Limits (Restricted Bands and Radiated Emission Limits)	Emissions in restricted bands must meet the radiated limits detailed in 15.209	Radiated	Pass	Section 7.3 & 7.4
15.215(c)	20dB Spectrum Bandwidth	20 dB bandwidth of the emission in the specific band	Conducted	Pass	Section 7.5

RSS Section(s)	Test Description	Test Limit	Test Condition	Test Result	Reference
RSS-Gen Clause 8.8	AC Conducted Emissions 150kHz - 30MHz	< RSS-Gen Clause 8.8 limits	Line Conducted	Pass	Section 7.2
RSS-210 Clause 8.9 Annex A2.9	General Field Strength Limits (Restricted Bands and Radiated Emission Limits)	Emissions in restricted bands must meet the radiated limits detailed in clause 8.10	Radiated	Pass	Section 7.3 & 7.4
RSS-GEN Clause 6.6	99% Occupied Bandwidth	N/A	Conducted	Pass	Section 7.6

**Notes:**

- 1) All modes of operation and data rates were investigated. For radiated emission test, every axis (X, Y, Z) was also verified. The test results shown in the following sections represent the worst case emissions.
- 2) The analyzer plots shown in this section were all taken with a correction table loaded into the analyzer. The correction table was used to account for the losses of the cables and attenuators used as part of the system to connect the EUT to the analyzer at all frequencies of interest.
- 3) All radiated test data shown on report was based on the module in stand-alone status. We have pre-test the radiated emission when the module install into the host, these data was better than the stand alone data. So we showed the worst case data on the report.

## 7.2. Conducted Emission

### 7.2.1. Test Limit

FCC Part 15 Subpart C Paragraph 15.207 Limits		
Frequency (MHz)	QP (dBuV)	AV (dBuV)
0.15 - 0.50	66 - 56	56 - 46
0.50 - 5.0	56	46
5.0 - 30	60	50

Note 1: The lower limit shall apply at the transition frequencies.

Note 2: The limit decreases linearly with the logarithm of the frequency in the range 0.15 MHz to 0.5 MHz.

### 7.2.2. Test Setup

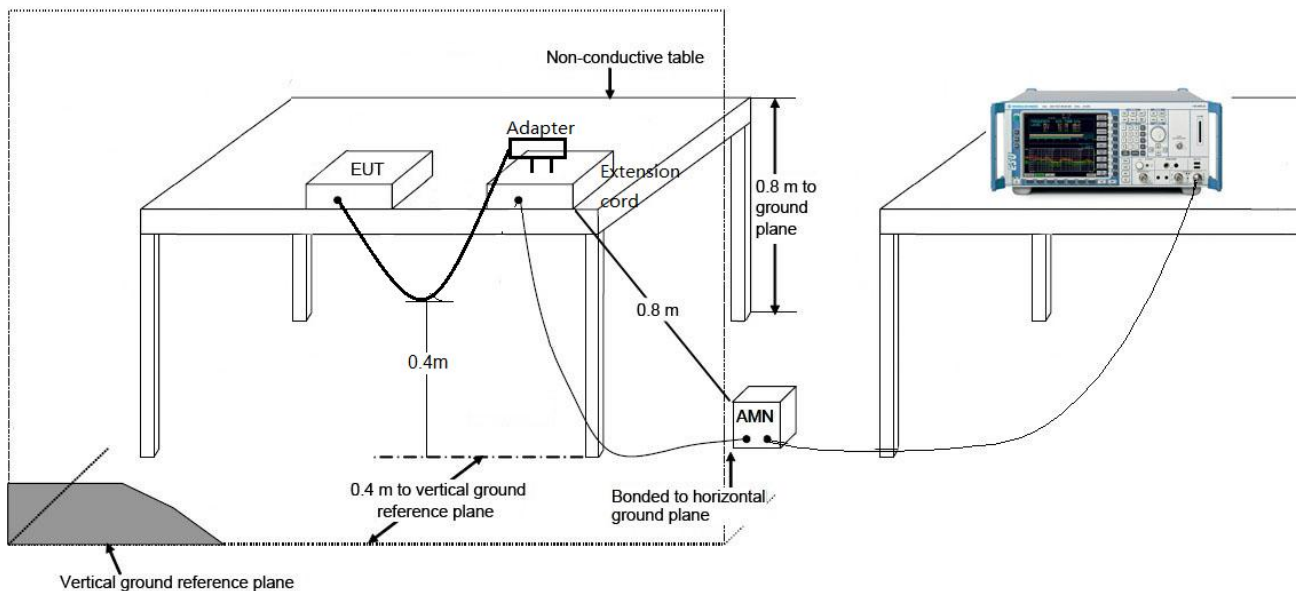

### 7.2.3. Test Result

The EUT is powered by battery, so this requirement does not apply.



### 7.3. Radiated Emission

#### 7.3.1. Test Limit

FCC Part 15 Subpart C Paragraph 15.209		
Frequency (MHz)	Field Strength (microvolts/meter)	Measurement Distance (uV/m)
0.009-0.490	2400/F(kHz)	300
0.490-1.705	24000/F(kHz)	30
1.705-30.0	30	30
30-80	100**	3
80-216	150**	3
216-960	200**	3
Above 960	500	3

Note 1: The lower limit shall apply at the transition frequency.

Note 2: Distance refers to the distance in meters between the measuring instrument antenna and the closed point of any part of the device or system.

Note 3: E field strength (dBuV/m) = 20 log E field strength (uV/m).

FCC Part 15 Subpart C Paragraph 15.249		
Fundamental Frequency	Field Strength of Fundamental (millivolts/meter)	Field Strength of Harmonics (microvolts/meter)
902-928(MHz)	50	500
2400-2483.5(MHz)	50	500
5725-5875(MHz)	50	500
24.0-24.25(GHz)	250	2500

FCC Part 15.249 (d), Emissions radiated outside of the specified frequency bands, except for harmonics, shall be attenuated by at least 50 dB below the level of the fundamental or to the general radiated emission limits in §15.209, whichever is the lesser attenuation.

### 7.3.2. Test Setup

#### 9kHz ~ 30MHz Test Setup:

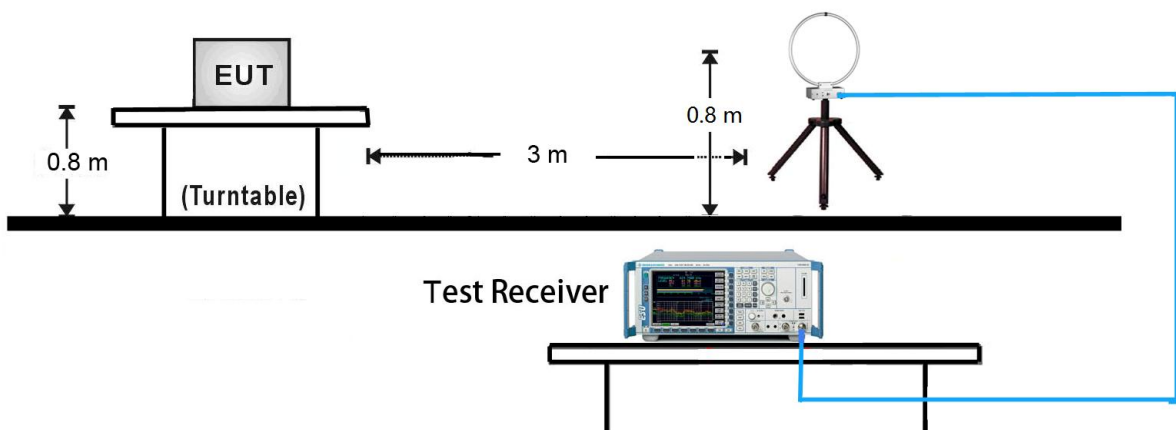

30MHz ~ 1GHz Test Setup:

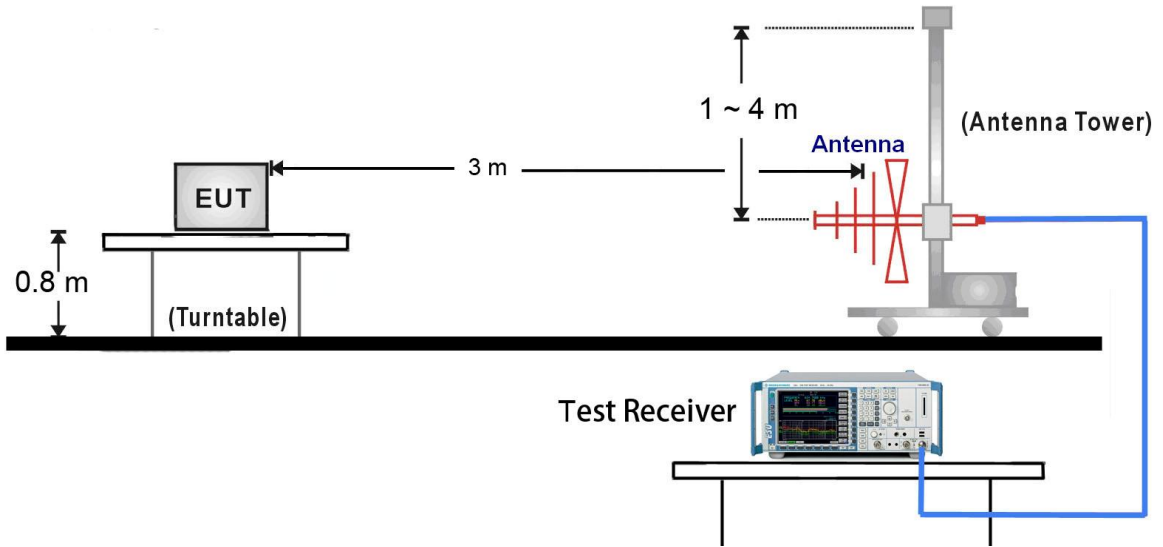

1GHz ~ 25GHz Test Setup:

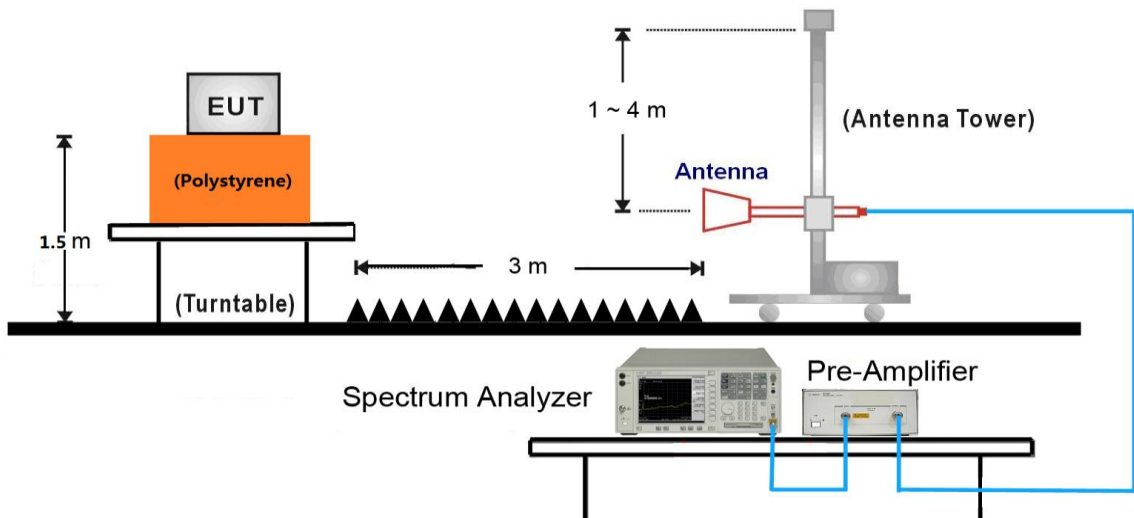

### 7.3.3. Test Result

Total Time ( $T_{on}$ ) (ms)	Duty Cycle (%)	Duty Cycle Factor (dB)
1.5	1.5	-36.5

Note: Duty Cycle Factor =  $20 * \text{Log}(\text{Duty Cycle})$

Total Time ( $T_{on}$ ) (ms) =  $0.3 * 5 \text{ (ms)} = 1.5 \text{ (ms)}$

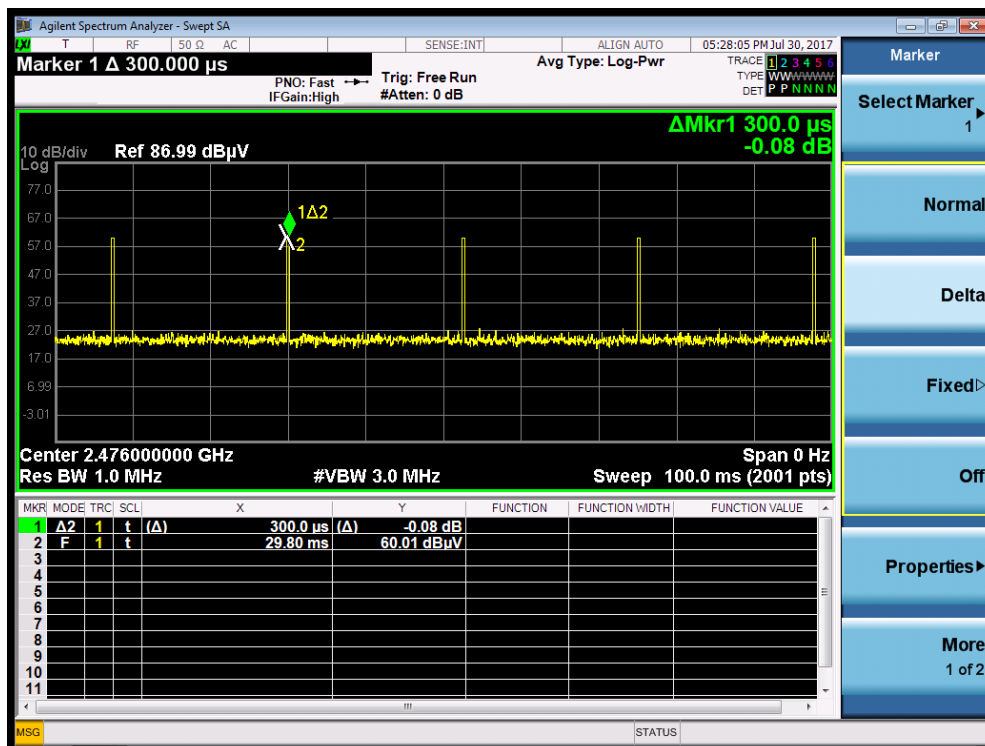

Test Mode:	Transmission	Test Site:	AC2
Remark:	<b>Fundamental</b> Radiated Emission	Test Engineer:	Flag Yang

Frequency (MHz)	Reading Level (dB $\mu$ V)	Factor (dB)	Duty Cycle Factor (dB)	Measure Level (dB $\mu$ V/m)	Limit (dB $\mu$ V/m)	Margin (dB)	Detector	Polarization
2404	66.6	32.3	N/A	98.9	114.0	-15.1	PK	Horizontal
	66.6	32.3	-36.5	62.4	94.0	-31.6	AV	Horizontal
	62.1	32.3	N/A	94.4	114.0	-19.6	PK	Vertical
	62.1	32.3	-36.5	57.9	94.0	-36.1	AV	Vertical
2440	65.9	32.3	N/A	98.2	114.0	-15.8	PK	Horizontal
	65.9	32.3	-36.5	61.7	94.0	-32.3	AV	Horizontal
	61.3	32.3	N/A	93.6	114.0	-20.4	PK	Vertical
	61.3	32.3	-36.5	57.1	94.0	-36.9	AV	Vertical
2476	65.9	32.3	N/A	98.2	114.0	-15.8	PK	Horizontal
	65.9	32.3	-36.5	61.7	94.0	-32.3	AV	Horizontal
	61.6	32.3	N/A	93.9	114.0	-20.1	PK	Vertical
	61.6	32.3	-36.5	57.4	94.0	-36.6	AV	Vertical

Note 1: Peak Measure Level (dB $\mu$ V/m) = Reading Level (dB $\mu$ V) + Factor (dB)

Average Measure Level = Peak Measure Level + Duty Cycle Factor

Factor (dB) = Cable Loss (dB) + Antenna Factor (dB/m)

Note 2: All readings above 1GHz are performed with peak and/or average measurements as necessary.

Test Mode:	Transmission	Test Site:	AC2
Frequency	2404MHz	Test Engineer:	Flag Yang
Remark:	<b>General Radiated Emission</b>		

Frequency (MHz)	Reading Level (dB $\mu$ V)	Factor (dB)	Measure Level (dB $\mu$ V/m)	Limit (dB $\mu$ V/m)	Margin (dB)	Detector	Polarization
616.9	1.9	20.3	22.2	48.9 (Note 4)	-26.7	QP	Horizontal
812.0	23.6	23.1	46.7	48.9 (Note 4)	-2.2	QP	Horizontal
675.5	1.8	21.2	23.0	48.9 (Note 4)	-25.9	QP	Vertical
812.0	22.8	23.1	45.9	48.9 (Note 4)	-3.0	QP	Vertical
4000.5	49.7	-0.4	49.3	74.0 (Note 2)	-24.7	PK	Horizontal
7213.5	38.3	10.6	48.9	74.0 (Note 2)	-25.1	PK	Horizontal
10299.0	31.9	14.8	46.7	74.0 (Note 2)	-27.3	PK	Horizontal
5097.0	35.0	3.1	38.1	74.0 (Note 2)	-35.9	PK	Vertical
7213.5	38.6	10.6	49.2	74.0 (Note 2)	-24.8	PK	Vertical
7604.5	34.1	10.8	44.9	74.0 (Note 2)	-29.1	PK	Vertical

Note 1: Measure Level (dB $\mu$ V/m) = Reading Level (dB $\mu$ V) + Factor (dB)

Factor (dB) = Cable Loss (dB) + Antenna Factor (dB/m) – Pre Amplifier Gain (dB)

Note 2: Average measurement was not performed when the peak level lower than average limit.

Note 3: The test trace is same as the ambient noise (the test frequency range: 9 kHz ~ 30 MHz and 18 GHz ~ 25 GHz), therefore no data appear in the report.

Note 4: Emissions radiated outside of the specified frequency bands, except for harmonics, shall be attenuated by at least 50 dB below the level of the fundamental (98.9dB $\mu$ V/m) or to the general radiated emission limits in §15.209, whichever is the lesser attenuation.

Test Mode:	Transmission	Test Site:	AC2
Frequency	2440MHz	Test Engineer:	Flag Yang
Remark:	<b>General Radiated Emission</b>		

Frequency (MHz)	Reading Level (dB $\mu$ V)	Factor (dB)	Measure Level (dB $\mu$ V/m)	Limit (dB $\mu$ V/m)	Margin (dB)	Detector	Polarization
663.9	1.2	21.0	22.2	48.2 (Note 4)	-26.0	QP	Horizontal
811.8	14.0	23.1	37.1	48.2 (Note 4)	-11.1	QP	Horizontal
373.4	5.3	16.2	21.5	48.2 (Note 4)	-26.7	QP	Vertical
800.0	16.5	22.9	39.4	48.2 (Note 4)	-8.8	QP	Vertical
4068.5	48.2	0.0	48.2	74.0 (Note 2)	-25.8	PK	Horizontal
7315.5	36.1	10.7	46.8	74.0 (Note 2)	-27.2	PK	Horizontal
7324.0	37.4	10.6	48.0	74.0 (Note 2)	-26.0	PK	Horizontal
4068.5	38.3	0.0	38.3	74.0 (Note 2)	-35.7	PK	Vertical
7324.0	36.8	10.6	47.4	74.0 (Note 2)	-26.6	PK	Vertical
6363.5	34.2	6.4	40.6	74.0 (Note 2)	-33.4	PK	Vertical

Note 1: Measure Level (dB $\mu$ V/m) = Reading Level (dB $\mu$ V) + Factor (dB)

Factor (dB) = Cable Loss (dB) + Antenna Factor (dB/m) – Pre Amplifier Gain (dB)

Note 2: Average measurement was not performed when the peak level lower than average limit.

Note 3: The test trace is same as the ambient noise (the test frequency range: 9 kHz ~ 30 MHz and 18 GHz ~ 25 GHz), therefore no data appear in the report.

Note 4: Emissions radiated outside of the specified frequency bands, except for harmonics, shall be attenuated by at least 50 dB below the level of the fundamental (98.2dB $\mu$ V/m) or to the general radiated emission limits in §15.209, whichever is the lesser attenuation.

Test Mode:	Transmission	Test Site:	AC2
Frequency	2476MHz	Test Engineer:	Flag Yang
Remark:	<b>General Radiated Emission</b>		

Frequency (MHz)	Reading Level (dB $\mu$ V)	Factor (dB)	Measure Level (dB $\mu$ V/m)	Limit (dB $\mu$ V/m)	Margin (dB)	Detector	Polarization
706.6	1.3	21.7	23.0	48.2 (Note 4)	-25.2	QP	Horizontal
824.0	23.5	23.3	46.8	48.2 (Note 4)	-1.4	QP	Horizontal
626.6	1.5	20.4	21.9	48.2 (Note 4)	-26.3	QP	Vertical
823.9	14.3	23.3	37.6	48.2 (Note 4)	-10.6	QP	Vertical
4128.0	48.3	0.2	48.5	74.0 (Note 2)	-25.5	PK	Horizontal
7426.0	33.8	10.7	44.5	74.0 (Note 2)	-29.5	PK	Horizontal
9661.5	32.4	12.5	44.9	74.0 (Note 2)	-29.1	PK	Horizontal
5139.5	35.5	3.1	38.6	74.0 (Note 2)	-35.4	PK	Vertical
7426.0	38.4	10.7	49.1	74.0 (Note 2)	-24.9	PK	Vertical
7562.0	33.4	10.9	44.3	74.0 (Note 2)	-29.7	PK	Vertical

Note 1: Measure Level (dB $\mu$ V/m) = Reading Level (dB $\mu$ V) + Factor (dB)

Factor (dB) = Cable Loss (dB) + Antenna Factor (dB/m) – Pre Amplifier Gain (dB)

Note 2: Average measurement was not performed when the peak level lower than average limit.

Note 3: The test trace is same as the ambient noise (the test frequency range: 9 kHz ~ 30 MHz and 18 GHz ~ 25 GHz), therefore no data appear in the report.

Note 4: Emissions radiated outside of the specified frequency bands, except for harmonics, shall be attenuated by at least 50 dB below the level of the fundamental (98.2dB $\mu$ V/m) or to the general radiated emission limits in §15.209, whichever is the lesser attenuation.



## 7.4. Radiated Restricted Band Edge Measurement

### 7.4.1. Test Result

Site: AC2	Time: 2017/09/28 - 18:49
Limit: FCC_Part15.209_RE(3m)	Engineer: Flag Yang
Probe: BBHA9120D_1-18GHz	Polarity: Horizontal
EUT: AS6240BL Rx DSMX 6-Ch AS3X (SAFE BL ESC)	Power: By Battery
Test Mode: Transmit at channel 2404MHz	

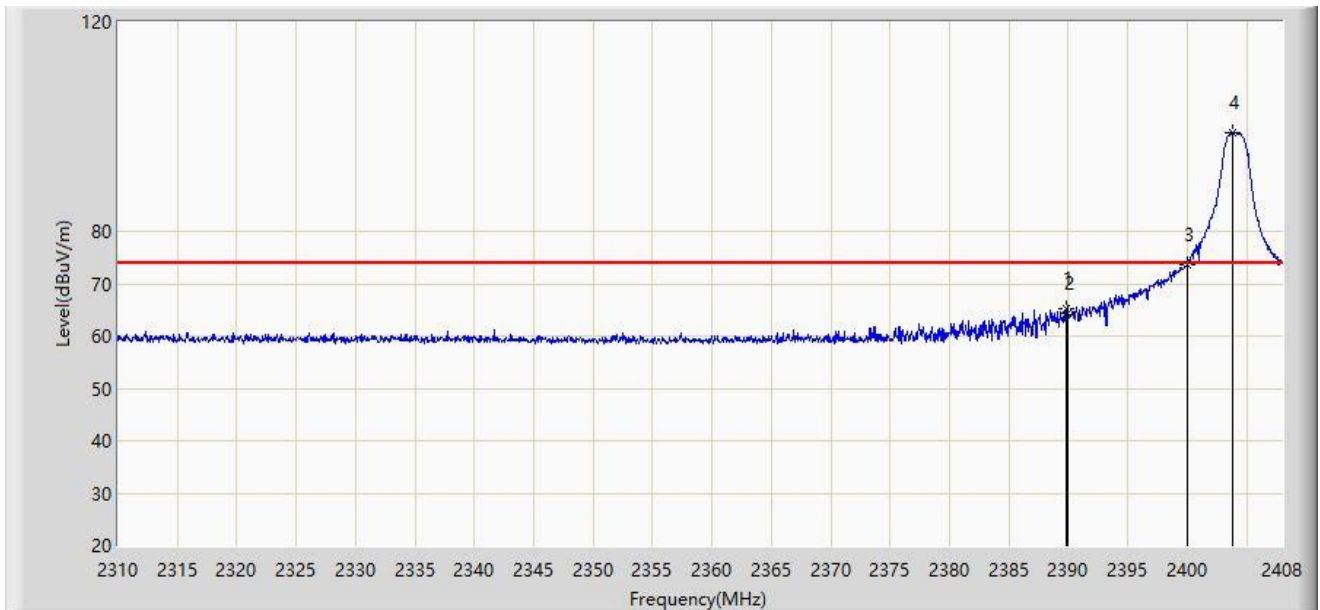

No	Flag	Mark	Frequency (MHz)	Measure Level (dBuV/m)	Reading Level (dBuV)	Over Limit (dB)	Limit (dBuV/m)	Factor (dB)	Duty Cycle Factor (dB)	Type
1			2389.772	65.303	33.027	-8.697	74.000	32.276	N/A	PK
			2389.772	28.803	33.027	-25.197	54.000	32.276	-36.500	AV
2			2390.000	64.298	32.020	-9.702	74.000	32.278	N/A	PK
			2390.000	27.798	32.020	-26.202	54.000	32.278	-36.500	AV
3			2400.000	73.676	46.095	-0.324	74.000	27.581	N/A	PK
			2400.000	37.176	46.095	-16.824	54.000	27.581	-36.500	AV
4		*	2403.884	98.930	66.662	-15.070	114.000	32.268	N/A	PK

Note: Peak Measure Level (dB $\mu$ V/m) = Reading Level (dB $\mu$ V) + Factor (dB)

Average Measure Level = Peak Measure Level + Duty Cycle Factor

Factor (dB) = Cable Loss (dB) + Antenna Factor (dB/m)

Site: AC2	Time: 2017/09/28 - 19:06
Limit: FCC_Part15.209_RE(3m)	Engineer: Flag Yang
Probe: BBHA9120D_1-18GHz	Polarity: Vertical
EUT: AS6240BL Rx DSMX 6-Ch AS3X(SAFE BL ESC)	Power: By Battery
Test Mode: Transmit at channel 2404MHz	

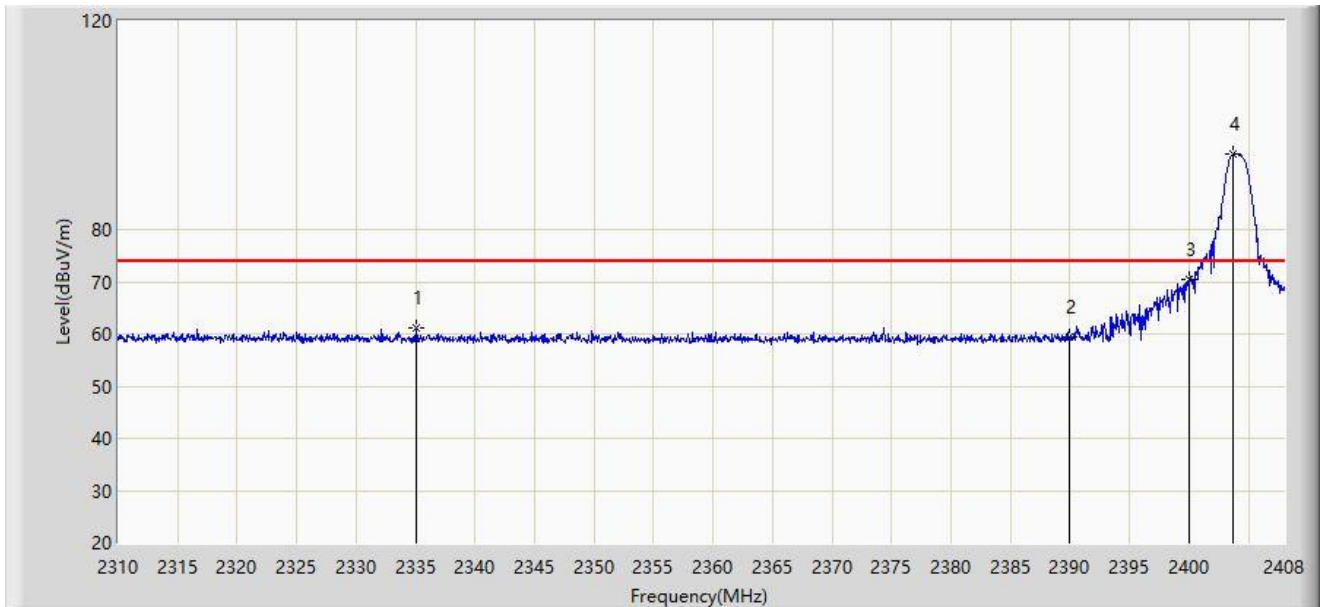

No	Flag	Mark	Frequency (MHz)	Measure Level (dBuV/m)	Reading Level (dBuV)	Over Limit (dB)	Limit (dBuV/m)	Factor (dB)	Duty Cycle Factor (dB)	Type
1			2335.088	61.155	28.818	-12.845	74.000	32.337	N/A	PK
			2335.088	24.655	28.818	-29.345	54.000	32.337	-36.500	AV
2			2390.000	59.301	27.023	-14.699	74.000	32.278	N/A	PK
			2390.000	22.801	27.023	-31.199	54.000	32.278	-36.500	AV
3			2400.000	70.516	38.235	-3.484	74.000	32.281	N/A	PK
			2400.000	34.016	38.235	-19.984	54.000	32.281	-36.500	AV
4		*	2403.737	94.403	62.135	-19.597	114.000	32.268	N/A	PK

Note: Peak Measure Level (dB $\mu$ V/m) = Reading Level (dB $\mu$ V) + Factor (dB)

Average Measure Level = Peak Measure Level + Duty Cycle Factor

Factor (dB) = Cable Loss (dB) + Antenna Factor (dB/m)

Site: AC2	Time: 2017/09/28 - 19:14
Limit: FCC_Part15.209_RE(3m)	Engineer: Flag Yang
Probe: BBHA9120D_1-18GHz	Polarity: Horizontal
EUT: AS6240BL Rx DSMX 6-Ch AS3X(SAFE BL ESC)	Power: By Battery
Test Mode: Transmit at channel 2476MHz	

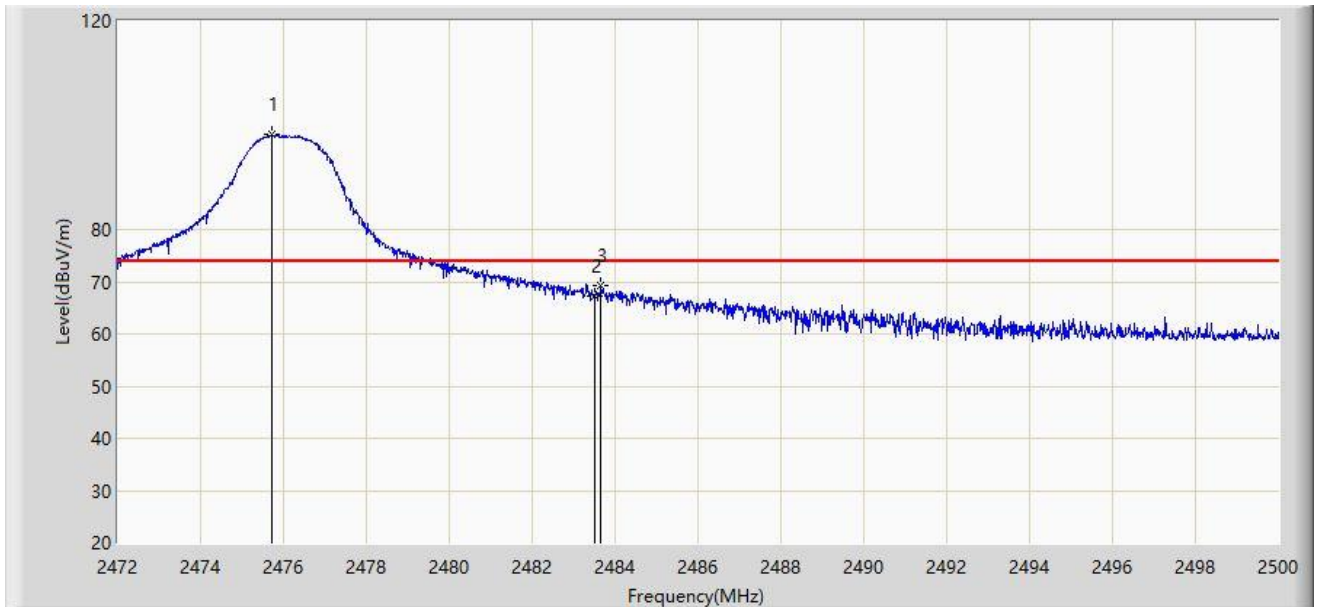

No	Flag	Mark	Frequency (MHz)	Measure Level (dBuV/m)	Reading Level (dBuV)	Over Limit (dB)	Limit (dBuV/m)	Factor (dB)	Duty Cycle Factor (dB)	Type
1		*	2475.710	98.179	65.918	-15.821	114.000	32.261	N/A	PK
2			2483.500	67.266	34.984	-6.734	74.000	32.282	N/A	PK
			2483.500	30.766	34.984	-23.234	54.000	32.282	-36.500	AV
3			2483.662	69.187	36.905	-4.813	74.000	32.282	N/A	PK
			2483.662	32.687	36.905	-21.313	54.000	32.282	-36.500	AV

Note: Peak Measure Level (dBuV/m) = Reading Level (dBuV) + Factor (dB)

Average Measure Level = Peak Measure Level + Duty Cycle Factor

Factor (dB) = Cable Loss (dB) + Antenna Factor (dB/m)

Site: AC2	Time: 2017/09/28 - 19:26
Limit: FCC_Part15.209_RE(3m)	Engineer: Flag Yang
Probe: BBHA9120D_1-18GHz	Polarity: Vertical
EUT: AS6240BL Rx DSMX 6-Ch AS3X(SAFE BL ESC)	Power: By Battery
Test Mode: Transmit at channel 2476MHz	

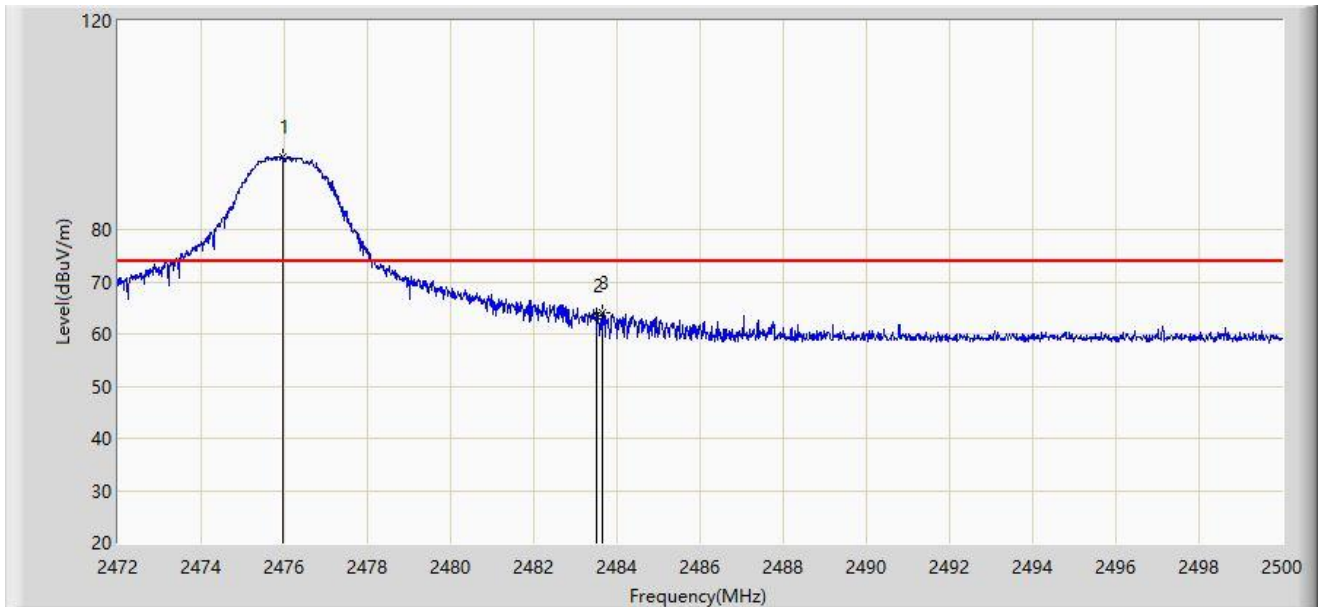

No	Flag	Mark	Frequency (MHz)	Measure Level (dBuV/m)	Reading Level (dBuV)	Over Limit (dB)	Limit (dBuV/m)	Factor (dB)	Duty Cycle Factor (dB)	Type
1		*	2475.948	93.892	61.632	-20.108	114.000	32.260	N/A	PK
2			2483.500	63.522	31.240	-10.478	74.000	32.282	N/A	PK
			2483.500	27.022	31.240	-26.978	54.000	32.282	-36.500	AV
3			2483.662	63.972	31.690	-10.028	74.000	32.282	N/A	PK
			2483.662	27.472	31.690	-26.528	54.000	32.282	-36.500	AV

Note: Peak Measure Level (dBuV/m) = Reading Level (dBuV) + Factor (dB)

Average Measure Level = Peak Measure Level + Duty Cycle Factor

Factor (dB) = Cable Loss (dB) + Antenna Factor (dB/m)

## 7.5. 20dB Spectrum Bandwidth Measurement

### 7.5.1. Test Limit

Intentional radiators must be designed to ensure that the 20 dB bandwidth of the emission in the specific band.

### 7.5.2. Test Procedure used

ANSI C63.10 Clause 6.9.2

### 7.5.3. Test Setting

1. Set the spectrum span range to overlap the nominal center frequency
2. Set RBW = 100 kHz
3. VBW  $\geq 3 \times$  RBW
4. Detector = Peak
5. Trace mode = max hold
6. Sweep = auto couple
7. Allow the trace was allowed to stabilize and marker the highest level.
8. Determine the display level (the highest level - 20dB) and place two markers, one at the lowest frequency and the other at the highest frequency.

### 7.5.4. Test Setup

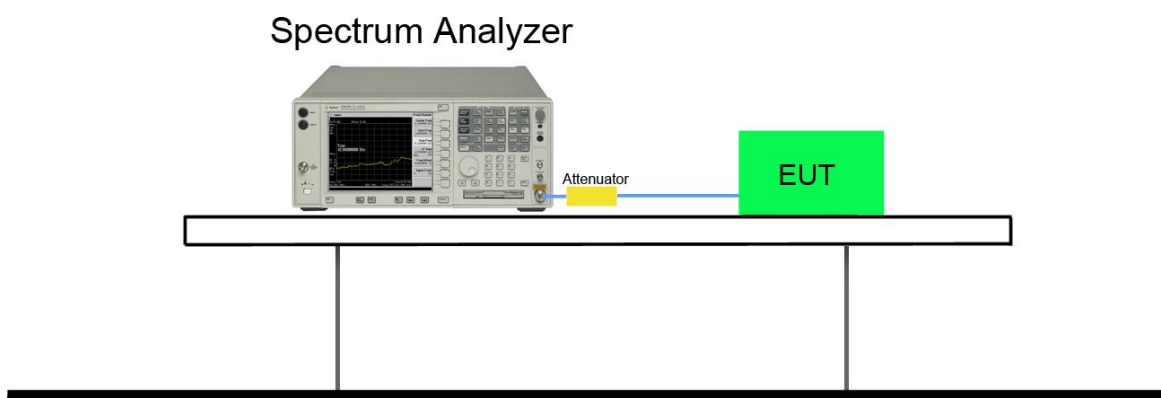

### 7.5.5. Test Result

Frequency (MHz)	Frequency Range (MHz)	Frequency Range (MHz)	Result
2404	2403.333	---	Pass
2476	---	2476.743	Pass

#### 20dB Spectrum Bandwidth

##### 2404 MHz



##### 2476 MHz



## 7.6. 99% Bandwidth Measurement

### 7.6.1. Test Limit

N/A

### 7.6.2. Test Procedure used

ANSI C63.10 Section 6.9

### 7.6.3. Test Setting

1. The analyzers' automatic bandwidth measurement capability was used to perform the 99% bandwidth measurement. The bandwidth measurement was not influenced by any intermediated power nulls in the fundamental emission.
2. RBW = approximately 1% to 5% of the OBW.
3. VBW  $\geq 3 \times$  RBW.
4. Detector = Peak.
5. Trace mode = max hold.

### 7.6.4. Test Setup

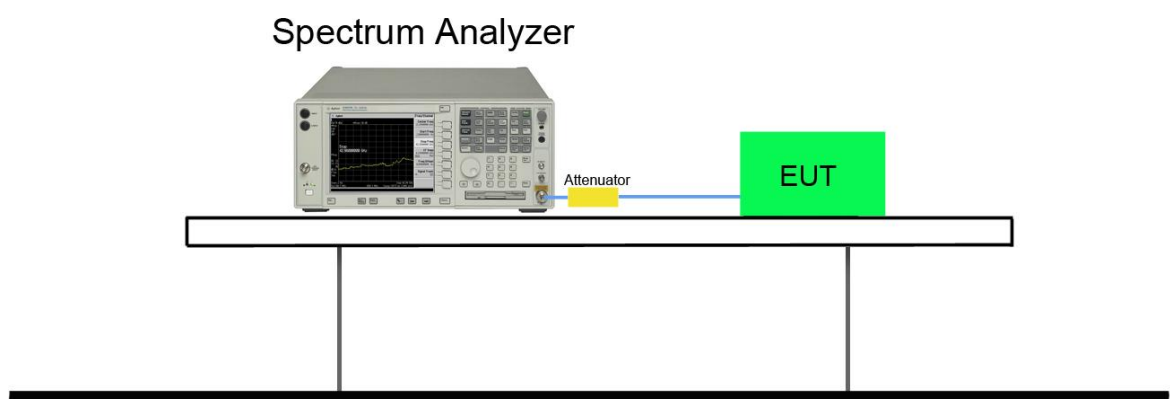

### 7.6.5. Test Result

Frequency (MHz)	99% Bandwidth (MHz)
2404	1.118
2440	1.141
2476	1.118

### 99% Occupied Bandwidth

#### 2404 MHz

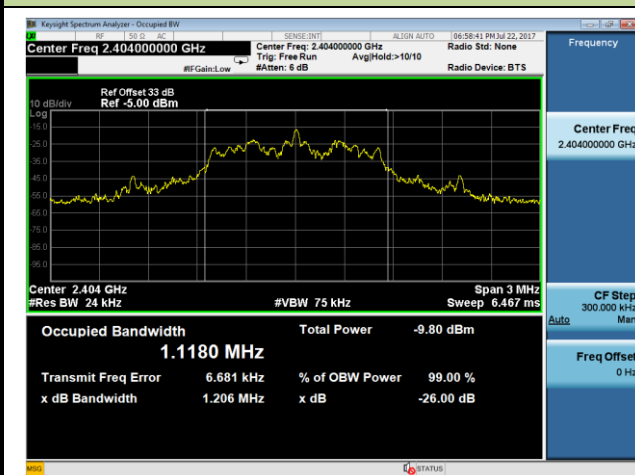

#### 2440 MHz

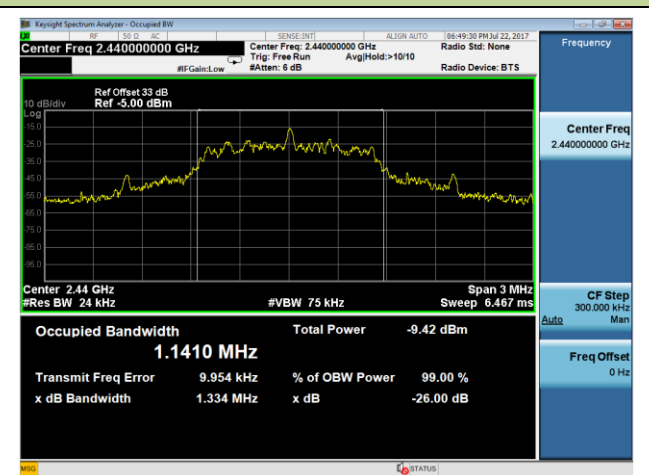

#### 2476 MHz

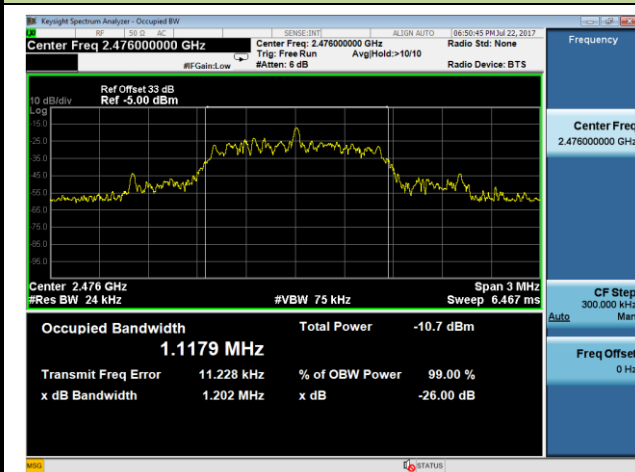



## 8. CONCLUSION

The data collected relate only the item(s) tested and show that the **AS6240BL Rx DSMX 6-Ch AS3X (SAFE BL ESC) FCC ID: BRWEFLA6420BL** is in compliance with Part 15C of the FCC Rules and RSS Rules.

————— The End —————