



**CENTRE OF TESTING SERVICE
INTERNATIONAL**

OPERATE ACCORDING TO ISO/IEC 17025

FCC ID/IC TEST REPORT

TEST REPORT NUMBER : CGZ3141010-01121-EFI



CENTRE OF TESTING SERVICE CO., LTD.

A101, No.65, Zhuji Highway, Tianhe District, Guangzhou, China



TEST REPORT For FCC ID/IC 47 CFR PART 15 OCT, 2013 RSS-210 Issue 8	
Report Reference No.	CGZ3141010-01121-EFI
Date of issue	23 October 2014
Testing Laboratory Name	CENTRE OF TESTING SERVICE CO., LTD.
Address	A101, No.65, Zhuji Highway, Tianhe District, Guangzhou, China
Testing location/ procedure	Full application of Harmonised standards <input checked="" type="checkbox"/> Partial application of Harmonised standards <input type="checkbox"/> Other standard testing method <input type="checkbox"/>
Applicant's name	Horizon Hobby, LLC
Address	4105 Fieldstone Road, Champaign, IL 61822, USA
Test specification	
Standard	47 CFR PART 15 OCT, 2013, RSS-210 Issue 8, RSS-Gen Issue 3
Test Report Form No.	CTSEMC-1.0
TRF Originator	CENTRE OF TESTING SERVICE CO., LTD.
Master TRF	Dated 2009-01
CENTRE OF TESTING SERVICE CO., LTD. All rights reserved. This publication may be reproduced in whole or in part for non-commercial purposes as long as the CENTRE OF TESTING SERVICE CO., LTD. is acknowledged as copyright owner and source of the material. CENTRE OF TESTING SERVICE CO., LTD takes no responsibility for and will not assume liability for damages resulting from the reader's interpretation of the reproduced material due to its placement and context.	
Test item description	: ECX/PRB 2.4GHz Transmitter, 2-Channel V3
Trade Mark	/
Manufacturer	Horizon Hobby, LLC
Model/Type reference	ECX13002
Ratings	Battery 1.5V*4
Operating Frequency	2402.0 MHz ~2475.6 MHz
Result	Positive

Compiled by:

Kate zhang / Fileadministrators

Supervised by:

Duke yang / Technique principal

Approved by:

Vincent yao / Manager

Copyright of this report is owned by Centre of Testing Service and may not be reproduced other than in full except with the written approval of the issuing Company.

CENTRE OF TESTING SERVICE CO., LTD.

A101, No.65, Zhuji Highway, Tianhe District, Guangzhou, China

Tel: +86-20-85543113 (32 lines)

Fax: +86-20-38780406

Complaint line: +86-20-85533471

E-mail: cts@cts-lab.com.cn

See Reverse For Terms And Conditions of Service



FCC ID/IC -- TEST REPORT

Test Report No. : CGZ3141010-01121-EFI	<u>23 October 2014</u> Date of issue
---	---

Type / Model.....	ECX13002
EUT.....	ECX/PRB 2.4GHz Transmitter, 2-Channel V3
Applicant	Horizon Hobby, LLC
Address.....	4105 Fieldstone Road, Champaign, IL 61822, USA
Telephone.....	+1-217 403 3542
Fax.....	/
Contact.....	Erin Hassan
Manufacturer	Horizon Hobby, LLC
Address.....	4105 Fieldstone Road, Champaign, IL 61822, USA
Telephone.....	+1-217 403 3542
Fax.....	/
Contact.....	Erin Hassan
Factory	Horizon Hobby, LLC
Address.....	4105 Fieldstone Road, Champaign, IL 61822, USA
Telephone.....	+1-217 403 3542
Fax.....	/
Contact.....	Erin Hassan

Test Result according to the standards on page 1: **PASSED**

The test report merely corresponds to the test sample.
It is not permitted to copy extracts of these test result without the written permission of the test laboratory.



TABLE OF CONTENTS

Description	Page
1.0 TEST STANDARDS	6
2.0 SUMMARY	6
2.1 GENERAL REMARKS	6
2.2 FINAL ASSESSMENT	6
3.0 EQUIPMENT UNDER TEST	6
3.1 POWER SUPPLY SYSTEM UNILISED	6
3.2 SHORT DESCRIPTION OF THE EQUIPMENT UNDER TEST (EUT)	6
3.3 EUT OPERATION MODE	6
3.4 EUT CONFIGURATION	7
4.0 TEST ENVIRONMENT	8
4.1 ADDRESS OF THE TEST LABORATORY	8
4.2 TEST FACILITY	8
4.3 ENVIRONMENTAL CONDITIONS	8
4.4 DEFINITIONS OF SYMBOLS USED IN THIS TEST REPORT	8
4.5 STATEMENT OF THE MEASUREMENT UNCERTAINTY	8
4.6 MEASUREMENT UNCERTAINTY	9
5.0 SUMMARY OF STANDARDS AND RESULTS	10
5.1.DESCRPTION OF STANDARDS AND RESULTS	10
6.0 POWER LINE CONDUCTED EMISSION TEST	11
6.1.TEST EQUIPMENTS	11
6.2. BLOCK DIAGRAM OF TEST SETUP	11
6.3. POWER LINE CONDUCTED EMISSION TEST LIMITS	11
6.4.TEST PROCEDURE	11
6.5. POWER LINE CONDUCTED EMISSION TEST RESULTS	11
7.0 20DB BANDWIDTH	12
7.1 MEASUREMENT EQUIPMENT USED	12
7.2 TEST CONFIGURATION	12
7.3 TEST PROCEDURE	12
7.4 TEST RESULTS	12
8.0 PEAK POWER	15
8.1 LIMIT	15
8.2 MEASUREMENT EQUIPMENT USED	15
8.3 TEST CONDIGURATION	15
8.4 TEST PROCEDURE	16

Copyright of this report is owned by Centre of Testing Service and may not be reproduced other than in full except with the written approval of the issuing Company.

CENTRE OF TESTING SERVICE CO., LTD.

A101, No.65, Zhuji Highway, Tianhe District, Guangzhou, China

Tel: +86-20-85543113 (32 lines)

Fax: +86-20-38780406

Complaint line: +86-20-85533471

E-mail: cts@cts-lab.com.cn

See Reverse For Terms And Conditions of Service



8.5 TEST RESULTS17

9.0 PEAK POWER SPECTRAL DENSITY 19

9.1 LIMIT.....19

9.2 MEASUREMENT EQUIPMENT USED.....19

9.2 TEST CONFIGURATION19

9.3 TEST PROCEDURE.....19

9.4 TEST RESULTS19

10.0 100KHZ BANDWIDTH OF BAND EDGES MEASUREMENT20

10.1 LIMIT.....20

10.2 MEASUREMENT EQUIPMENT USED20

10.3 TEST CONFIGURATION20

10.4 TEST PROCEDURE.....20

10.5 TEST RESULTS21

11.0 FREQUENCY SEPARATION.....24

11.1 LIMIT.....24

11.2 MEASUREMENT EQUIPMENT USED24

11.3 TEST CONFIGURATION24

11.4 TEST PROCEDURE.....24

11.5 TEST RESULTS24

12.0 NUMBER OF HOPPING FREQUENCY.....26

12.1 LIMIT.....26

12.2 MEASUREMENT EQUIPMENT USED26

12.3 TEST CONFIGURATION26

12.4 TEST PROCEDURE.....26

12.5 TEST RESULTS26

12.6 TEST DATA26

13.0 TIME OF OCCUPANCY (DWELL TIME)28

13.1 LIMIT.....28

13.2 MEASUREMENT EQUIPMENT USED28

13.3 TEST CONFIGURATION28

13.4 TEST PROCEDURE.....28

13.5 TEST RESULTS28

13.6 TEST DATA28

14.0 TRANSMITTER UNWANTED EMISSIONS30

14.1 LIMIT.....30

14.2 TEST EQUIPMENT30

14.3 TEST CONFIGURATION31

14.4 TEST PROCEDURE.....32

14.5 TEST RESULTS32

15.0 CONDUCTED SPURIOUS EMISSIONS.....40

15.1 LIMIT.....40

Copyright of this report is owned by Centre of Testing Service and may not be reproduced other than in full except with the written approval of the issuing Company.

CENTRE OF TESTING SERVICE CO., LTD.

A101, No.65, Zhuji Highway, Tianhe District, Guangzhou, China
Tel: +86-20-85543113 (32 lines) Fax: +86-20-38780406
Complaint line: +86-20-85533471 E-mail: cts@cts-lab.com.cn

See Reverse For Terms And Conditions of Service



15.2 TEST EQUIPMENT	40
15.3 TEST CONFIGURATION	40
15.4 TEST PROCEDURE.....	40
15.5 TEST RESULTS	41
16. 99% OCCUPIED BANDWIDTH	44
16.1 TEST PROCEDUR	44
16.2. TEST EQUIPMENT	44
16.3 TEST CONFIGURATION	44
16.4 TEST PROCEDURE.....	44
16.5 TEST RESULTS	44
17.0 RECEIVER SUPRIOUS EMISSION.....	47
17.1 LIMIT.....	47
17.2 TEST EQUIPMENT	47
17.3 TEST CONFIGURATION	48
17.4 TEST PROCEDURE.....	48
17.5 TEST RESULTS	48
18.0 DEVIATION TO TEST SPECIFICATIONS	49

Copyright of this report is owned by Centre of Testing Service and may not be reproduced other than in full except with the written approval of the issuing Company.

CENTRE OF TESTING SERVICE CO., LTD.

A101, No.65, Zhuji Highway, Tianhe District, Guangzhou, China

Tel: +86-20-85543113 (32 lines)

Fax: +86-20-38780406

Complaint line: +86-20-85533471

E-mail: cts@cts-lab.com.cn

See Reverse For Terms And Conditions of Service



1.0 TEST STANDARDS

The tests were performed according to following standards:

- RSS-210 Issue 8
- RSS-Gen Issue 3
- 47 CFR PART 15 OCT, 2013
- ANSI C63.4-2009

2.0 SUMMARY

2.1 GENERAL REMARKS

Date of receipt of test sample	10 October 2014
Testing commenced on	10~11 October 2014
Testing concluded on	23 October 2014

2.2 FINAL ASSESSMENT

The IC requirements pertaining to the technical standards and tested operation modes are

- - fulfilled.
- - **not** fulfilled.

The equipment under test

- - fulfils the FCC/IC requirements cited on page 1.
- - **does not** fulfil the FCC/IC requirements cited on page 1.

3.0 EQUIPMENT UNDER TEST

3.1 POWER SUPPLY SYSTEM UNILISED

Power supply voltage : ■ Battery 1.5V*4

3.2 SHORT DESCRIPTION OF THE EQUIPMENT UNDER TEST (EUT)

Number of tested samples: 1

Serial number: Prototype

3.3 EUT OPERATION MODE

The equipment under test was operated during the measurement under the following conditions:

- - Standby
- TX- Y position
- TX- Z position
- TX- X position

Operation mode 1:TX-X Position Low (2402.0 MHz) , TX-X Position Middle (2439.6 MHz) ,
TX-X Position High (2475.6 MHz)

Note:Operation mode 1 TX -X position of EUT is the radiated test worst case. so only these test results be recorded in the test report.



3.4 EUT CONFIGURATION

3.4.1. Description of configuration (EUT)

Description	:	ECX/PRB 2.4GHz Transmitter, 2-Channel V3
Model Number	:	ECX13002
Operation frequency	:	2402.0 MHz~ 2475.6 MHz ISM Band
Modulation Technology	:	FHSS
Antenna	:	External antenna, met requirement of FCC 15.203

3.4.2. Tested Supporting System Details

N/A

4.0 TEST ENVIRONMENT

4.1 ADDRESS OF THE TEST LABORATORY

A101, No.65, Zhuji Highway, Tianhe District, Guangzhou, China

Tel: +86-20-85543113 (32 lines)

Fax: +86-20-38780406

4.2 TEST FACILITY

The test facility is recognized, certified, or accredited by the following organizations:

CNAS-Lab Code: L3394

CENTRE OF TESTING SERVICE CO., LTD has been assessed and proved to be in compliance with CNAS-CL01: 2006 Accreditation Criteria for Testing and Calibration Laboratories (identical to ISO/IEC 17025: 2005 General Requirements) for the Competence of Testing and Calibration Laboratories.

IC-Registration No.: 8374A

The 3m Alternate Test Site of CENTRE OF TESTING SERVICE CO., LTD has been registered by Certification and Engineering Bureau of Industry Canada for the performance of radiated measurements with Registration No. 8374A on May 22, 2014.

FCC-Registration No.: 971995

CENTRE OF TESTING SERVICE CO., LTD, EMC Laboratory has been registered and fully described in a report filed with the FCC (Federal Communications Commission). The acceptance letter from the FCC is maintained in our files. Registration No.791995, July 13,2012.

4.3 ENVIRONMENTAL CONDITIONS

During the measurement the environmental conditions were within the listed ranges:

Temperature:	15~35 ° C
Humidity:	25~75 %
Atmospheric pressure:	86~106 kPa

4.4 DEFINITIONS OF SYMBOLS USED IN THIS TEST REPORT

- - The black square indicates that the listed condition, standard or equipment is applicable for this report.
- - The empty square indicates that the listed condition, standard or equipment is **not** applicable for this report.

4.5 STATEMENT OF THE MEASUREMENT UNCERTAINTY

The data and results referenced in this document are true and accurate. The reader is cautioned that there may be errors within the calibration limits of the equipment and facilities. The measurement uncertainty was calculated for all measurements listed in this test report acc. to CISPR 16 - 4 "Specification for radio disturbance and immunity measuring apparatus and methods – Part 4: Uncertainty in EMC Measurements" and is documented in the CTS quality system acc. to DIN EN ISO/IEC 17025. Furthermore, component and process variability of devices similar to that tested may result in additional deviation. The manufacturer has the sole responsibility of continued compliance of the device.



4.6 MEASUREMENT UNCERTAINTY

Test Item	Frequency Range	Uncertainty	Note
Conduction disturbance	150kHz~30MHz	$\pm 1.22\text{dB}$	(1)
Power disturbance	30MHz~300MHz	$\pm 1.38\text{dB}$	(1)
Radiation emission (3m)	30MHz~300MHz	$\pm 3.14\text{dB}$	(1)
	300MHz~1000MHz	$\pm 3.18\text{dB}$	(1)
	1GHz~26.5GHz	$\pm 3.54\text{dB}$	(1)

(1). This uncertainty represents an expanded uncertainty expressed at approximately the 95% confidence level using a coverage factor of $k=2$.

Copyright of this report is owned by Centre of Testing Service and may not be reproduced other than in full except with the written approval of the issuing Company.

CENTRE OF TESTING SERVICE CO., LTD.

A101, No.65, Zhuji Highway, Tianhe District, Guangzhou, China

Tel: +86-20-85543113 (32 lines)

Fax: +86-20-38780406

Complaint line: +86-20-85533471

E-mail: cts@cts-lab.com.cn

See Reverse For Terms And Conditions of Service

5.0 SUMMARY OF STANDARDS AND RESULTS

5.1.DESCRPTION OF STANDARDS AND RESULTS

The EUT have been tested according to the applicable standards as referenced below.

EMISSION		
Description of Test Item	Standard	Results
Conducted Emission Test	FCC Part 15 : 15.207 RSS-Gen Issue 3:7.2.4 ANSI C63.4-2009	N/A
20dB Bandwidth	FCC Part 15.247(a)(1) RSS-210 Issue 8:A8.1 RSS-Gen Issue 3:4.6.3 ANSI C63.4-2009	PASSED
Peak Power	FCC Part 15.247(b)(1) RSS-210 Issue 8:A8.4 RSS-Gen Issue 3:4.8 ANSI C63.4-2009	PASSED
Peak Power Spectral Density	15.247(e) Power Density RSS-210 Issue 8:A8.2 ANSI C63.4-2009	N/A
100KHz Bandwidth Band edges measurement	FCC Part 15.247(d) RSS-210 Issue 8:A8.5 ANSI C63.4-2009	PASSED
Conducted Spurious Emissions	FCC Part 15.247(d) RSS-210 Issue 8:A8.5 ANSI C63.4-2009	PASSED
Frequency Separation	FCC Part 15.247(a)(1) RSS-210 Issue 8:A8.1 ANSI C63.4-2009	PASSED
Number of Hopping Frequency	FCC Part 15.247(a)(1)(iii) RSS-210 Issue 8:A8.1 ANSI C63.4-2009	PASSED
Dwell Time	FCC Part 15.247(a)(1)(iii) RSS-210 Issue 8:A8.1 ANSI C63.4-2009	PASSED
Transmitter Unwanted Emissions	FCC Part 15: 15.209 RSS-Gen Issue 3:4.9 ANSI C63.4-2009	PASSED
Receiver Spurious Emissions	RSS-Gen Issue 3:4.10 ANSI C63.4-2009	N/A
99% Occupied Bandwidth	RSS-Gen Issue 3:4.6.1 ANSI C63.4-2009	PASSED
N/A is an abbreviation for Not Applicable.		

Copyright of this report is owned by Centre of Testing Service and may not be reproduced other than in full except with the written approval of the issuing Company.

CENTRE OF TESTING SERVICE CO., LTD.

A101, No.65, Zhuji Highway, Tianhe District, Guangzhou, China

Tel: +86-20-85543113 (32 lines)

Fax: +86-20-38780406

Complaint line: +86-20-85533471

E-mail: cts@cts-lab.com.cn

See Reverse For Terms And Conditions of Service

6.0 POWER LINE CONDUCTED EMISSION TEST

6.1.TEST EQUIPMENTS

Conducted Disturbance					
Item	Test Equipment	Manufacturer	Model No.	Serial No.	Last Cal.
1	EMI Test Receiver	ROHDE & SCHWARZ	ESHS10	842884/012	2013/11
2	Artificial Mains	ROHDE & SCHWARZ	ESH3-Z5	832479/025	2013/11
3	Artificial Mains	ROHDE & SCHWARZ	ESH3-Z5	832479/026	2013/11
4	Pulse Limiter	ROHDE & SCHWARZ	ESHSZ2	100301	2013/11
5	EMI Test Software	EZ-EMC	Farad	N/A	N/A

6.2. BLOCK DIAGRAM OF TEST SETUP

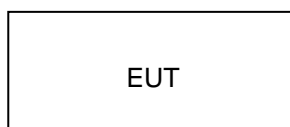

(EUT: ECX/PRB 2.4GHz Transmitter, 2-Channel V3)

6.3. POWER LINE CONDUCTED EMISSION TEST LIMITS

Standard: FCC Part 15 : 15.207, RSS-Gen Issue 3:7.2.4 ,ANSI C63.4-2009

Frequency	Maximum RF Line Voltage	
	Quasi-Peak Level dB(μ V)	Average Level dB(μ V)
150kHz ~ 500kHz	66 ~ 56*	56 ~ 46*
500kHz ~ 5MHz	56	46
5MHz ~ 30MHz	60	50

Notes: 1. * Decreasing linearly with logarithm of frequency.
 2. The lower limit shall apply at the transition frequencies.

6.4.TEST PROCEDURE

The XBOX Power connected to the power mains through a line impedance stabilization network (L.I.S.N.#2). This provides a 50 ohm coupling impedance for the EUT. Please refer the block diagram of the test setup and photographs. The other peripheral devices power cord connected to the power mains through a line impedance stabilization network (L.I.S.N.#1). Power on the PC and let it work normally, we use a keyboard test soft ware, let EUT working in test mode, then test it. Both sides of AC line are checked to find out the maximum conducted emission. In order to find the maximum emission levels, the relative positions of equipment and all of the interface cables shall be changed according to FCC Part 15C on Conducted Emission Test.

6.5. POWER LINE CONDUCTED EMISSION TEST RESULTS

The EUT power supply by Battery, Not applicable.

7.0 20dB BANDWIDTH

7.1 MEASUREMENT EQUIPMENT USED

20dB Bandwidth					
Item	Test Equipment	Manufacturer	Model No.	Serial No.	Last Cal.
1	Signal analyzer	ROHDE & SCHWARZ	FSIQ26	100311	2014/03

7.2 TEST CONFIGURATION

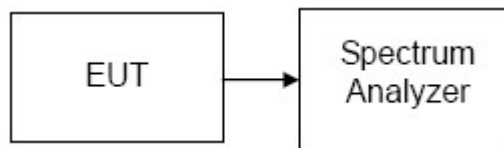

7.3 TEST PROCEDURE

1. Place the EUT on the table and set it in the transmitting mode.
2. Remove the antenna from the EUT, then connect a low loss RF cable from antenna port to the spectrum analyzer.
3. Set the spectrum analyzer as RBW=100kHz, VBW=300kHz, Span=3MHz, Sweep = auto.
4. Mark the peak frequency and 20dB (upper and lower) frequency.
5. Repeat until all the test channels are investigated.

7.4 TEST RESULTS

Channel	Frequency (MHz)	20dB Bandwidth (MHz)	Limit (dBm)	Result
Low	2402	0.550	-----	PASS
Middle	2439.6	0.502	-----	PASS
High	2475.6	0.550	-----	PASS



Test Plot

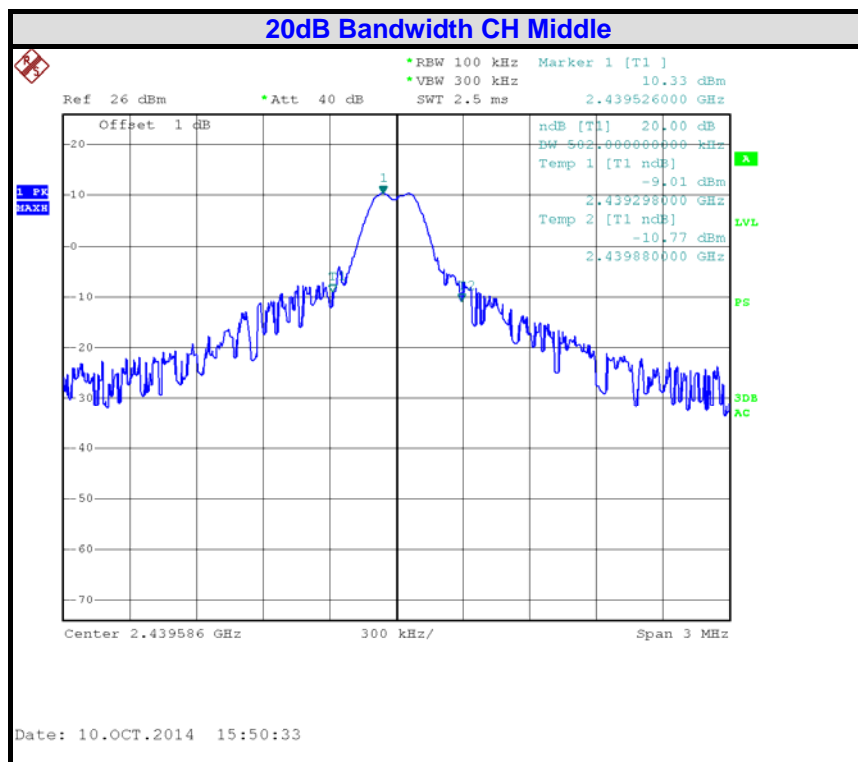
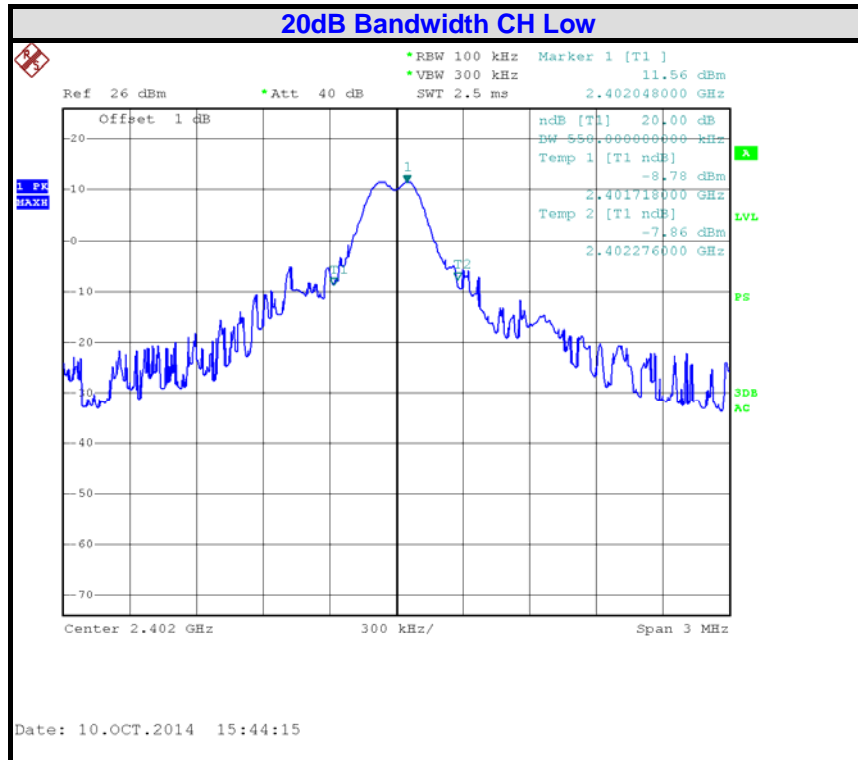

Copyright of this report is owned by Centre of Testing Service and may not be reproduced other than in full except with the written approval of the issuing Company.

CENTRE OF TESTING SERVICE CO., LTD.

A101, No.65, Zhuji Highway, Tianhe District, Guangzhou, China
 Tel: +86-20-85543113 (32 lines) Fax: +86-20-38780406
 Complaint line: +86-20-85533471 E-mail: cts@cts-lab.com.cn

See Reverse For Terms And Conditions of Service

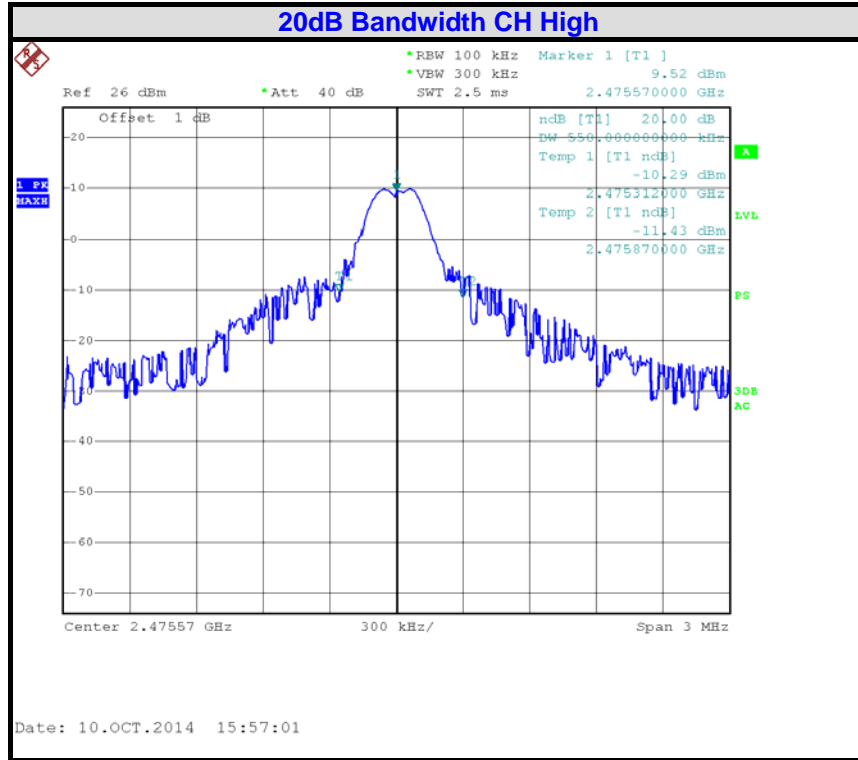

Copyright of this report is owned by Centre of Testing Service and may not be reproduced other than in full except with the written approval of the issuing Company.

CENTRE OF TESTING SERVICE CO., LTD.

A101, No.65, Zhuji Highway, Tianhe District, Guangzhou, China
 Tel: +86-20-85543113 (32 lines) Fax: +86-20-38780406
 Complaint line: +86-20-85533471 E-mail: cts@cts-lab.com.cn

See Reverse For Terms And Conditions of Service

8.0 PEAK POWER

8.1 LIMIT

The maximum peak output power of the intentional radiator shall not exceed the following:

1. For frequency hopping systems operating in the band 902-928 MHz, the maximum peak conducted output power shall not exceed 1.0 W, and the e.i.r.p. shall not exceed 4 W if the hopset uses 50 or more hopping channels; the maximum peak conducted output power shall not exceed 0.25 W, and the e.i.r.p. shall not exceed 1 W if the hopset uses less than 50 hopping channels.
2. For frequency hopping systems operating in the band 2400-2483.5 MHz and employing at least 75 hopping channels, the maximum peak conducted output power shall not exceed 1 W; for all other frequency hopping systems in the band, the maximum peak conducted output power shall not exceed 0.125 W. Except as provided in Section A8.4 (5), the e.i.r.p. shall not exceed 4 W.
3. For frequency hopping systems operating in the band 5725-5850 MHz, the maximum peak conducted output power shall not exceed 1 W. Except as provided in Section A8.4 (5), the e.i.r.p. shall not exceed 4 W.
4. For systems employing digital modulation techniques operating in the bands 902-928 MHz, 2400-2483.5 MHz and 5725-5850 MHz, the maximum peak conducted output power shall not exceed 1 W. Except as provided in Section A8.4 (5), the e.i.r.p. shall not exceed 4 W.
5. Point-to-point systems in the bands 2400-2483.5 MHz and 5725-5850 MHz are permitted to have an e.i.r.p. higher than 4 W provided that the higher e.i.r.p. is achieved by employing higher gain directional antennas and not higher transmitter output powers. Point-to-multipoint systems, omnidirectional applications and multiple co-located transmitters transmitting the same information are prohibited from exceeding 4 W e.i.r.p. However, remote stations of point-to-multipoint systems shall be allowed to operate at greater than 4 W e.i.r.p. under the same conditions as for point-to-point systems.

8.2 MEASUREMENT EQUIPMENT USED

Peak Power					
Item	Test Equipment	Manufacturer	Model No.	Serial No.	Last Cal.
1	Signal analyzer	ROHDE & SCHWARZ	FSIQ26	100311	2014/03
2	Power meter	ROHDE & SCHWARZ	NRVS	842856/049	2014/03

8.3 TEST CONFIGURATION

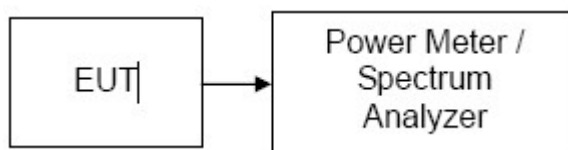

Copyright of this report is owned by Centre of Testing Service and may not be reproduced other than in full except with the written approval of the issuing Company.

CENTRE OF TESTING SERVICE CO., LTD.

A101, No.65, Zhuji Highway, Tianhe District, Guangzhou, China

Tel: +86-20-85543113 (32 lines)

Fax: +86-20-38780406

Complaint line: +86-20-85533471

E-mail: cts@cts-lab.com.cn

See Reverse For Terms And Conditions of Service



8.4 TEST PROCEDURE

1. Set span to encompass the entire emission bandwidth of the signal.
2. Set RBW = 1 MHz.
3. Set VBW = 3 MHz.
4. Use sample detector mode if bin width (i.e., span/number of points in spectrum display) < 0.5 RBW. Otherwise use peak detector mode.
5. Use a video trigger with the trigger level set to enable triggering only on full power pulses. Transmitter must operate at full control power for entire sweep of every sweep. If the device transmits continuously, with no off intervals or reduced power intervals, the trigger may be set to "free run".
6. Mark the peak frequency and channel power function on spectrum.
7. Repeat until all the test channels are investigated.

Copyright of this report is owned by Centre of Testing Service and may not be reproduced other than in full except with the written approval of the issuing Company.

CENTRE OF TESTING SERVICE CO., LTD.

A101, No.65, Zhuji Highway, Tianhe District, Guangzhou, China

Tel: +86-20-85543113 (32 lines)

Fax: +86-20-38780406

Complaint line: +86-20-85533471

E-mail: cts@cts-lab.com.cn

See Reverse For Terms And Conditions of Service



8.5 TEST RESULTS

**Passed
 Test Data**

Channel	Frequency (MHz)	Output Power (dBm)	Limit (dBm)	Result
Low	2402	9.98	21	PASS
Middle	2439.6	8.86	21	PASS
High	2475.6	8.37	21	PASS

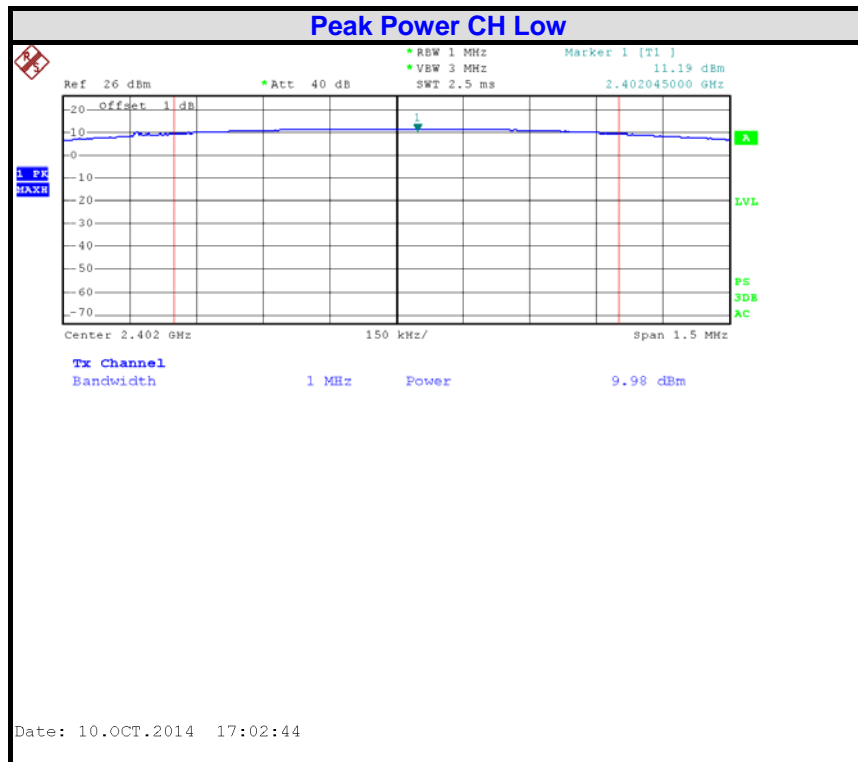

Copyright of this report is owned by Centre of Testing Service and may not be reproduced other than in full except with the written approval of the issuing Company.

CENTRE OF TESTING SERVICE CO., LTD.

A101, No.65, Zhuji Highway, Tianhe District, Guangzhou, China
 Tel: +86-20-85543113 (32 lines) Fax: +86-20-38780406
 Complaint line: +86-20-85533471 E-mail: cts@cts-lab.com.cn

See Reverse For Terms And Conditions of Service

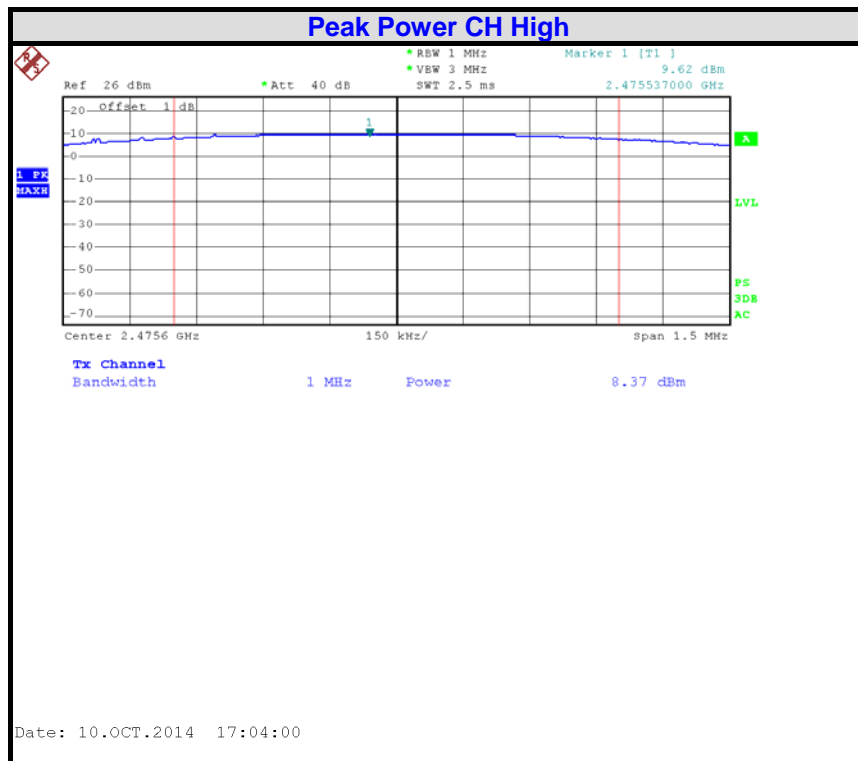
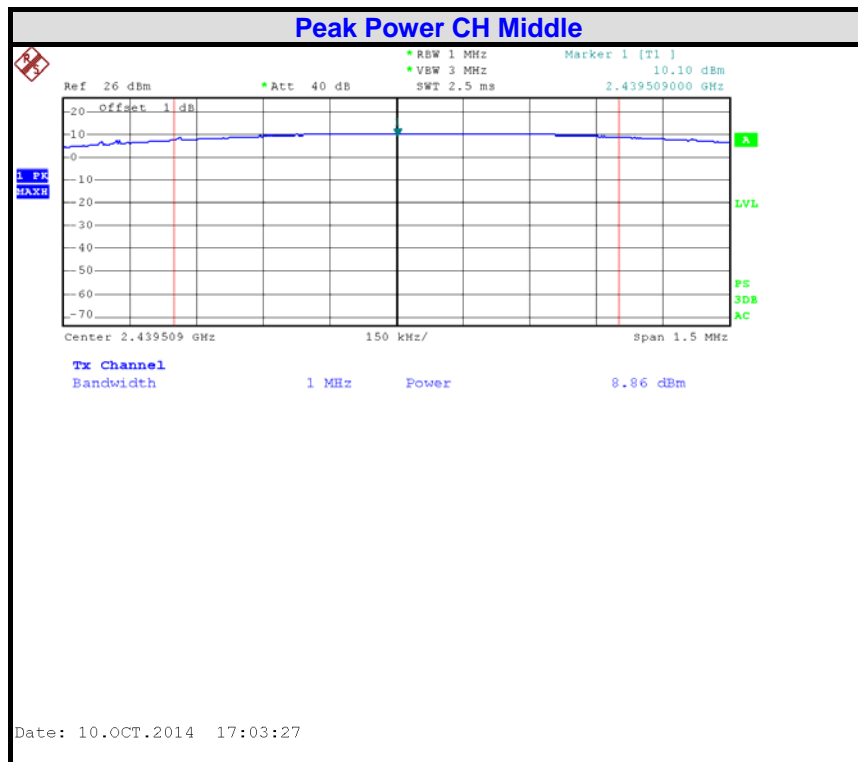

Copyright of this report is owned by Centre of Testing Service and may not be reproduced other than in full except with the written approval of the issuing Company.

CENTRE OF TESTING SERVICE CO., LTD.

A101, No.65, Zhuji Highway, Tianhe District, Guangzhou, China
 Tel: +86-20-85543113 (32 lines) Fax: +86-20-38780406
 Complaint line: +86-20-85533471 E-mail: cts@cts-lab.com.cn

See Reverse For Terms And Conditions of Service

9.0 PEAK POWER SPECTRAL DENSITY

9.1 LIMIT

1. For direct sequence systems, the peak power spectral density conducted from the intentional radiator to the antenna shall not be greater than 8dBm in any 3kHz band during any time interval of continuous transmission.
2. The direct sequence operating of the hybrid system, with the frequency hopping operation turned off, shall comply with the power density requirements of paragraph (d) of this section

9.2 MEASUREMENT EQUIPMENT USED

Peak Power Spectral Density					
Item	Test Equipment	Manufacturer	Model No.	Serial No.	Last Cal.
1	Signal analyzer	ROHDE & SCHWARZ	FSIQ26	100311	2014/03

9.2 TEST CONFIGURATION

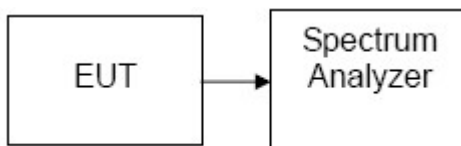

9.3 TEST PROCEDURE

1. Place the EUT on the table and set it in transmitting mode.
2. Remove the antenna from the EUT and then connect a low loss RF cable from the antenna port to the spectrum analyzer.
3. Set the spectrum analyzer as RBW = 3kHz, VBW = 10kHz, Span = 300kHz, Sweep=100s
4. Record the max. reading.
5. Repeat the above procedure until the measurements for all frequencies are completed.

9.4 TEST RESULTS

Not applicable for frequency hopping systems device.

10.0 100KHz BANDWIDTH OF BAND EDGES MEASUREMENT

10.1 LIMIT

In any 100 kHz bandwidth outside the frequency band in which the spread spectrum or digitally modulated device is operating, the RF power that is produced shall be at least 20 dB below that in the 100 kHz bandwidth within the band that contains the highest level of the desired power, based on either an RF conducted or a radiated measurement, provided that the transmitter demonstrates compliance with the peak conducted power limits. If the transmitter complies with the conducted power limits based on the use of root-mean-square averaging over a time interval, as permitted under Section A8.4 (4), the attenuation required shall be 30 dB instead of 20 dB. Attenuation below the general field strength limits specified in RSS-Gen is not required.

10.2 MEASUREMENT EQUIPMENT USED

Radiated disturbance (electric field)					
Item	Test Equipment	Manufacturer	Model No.	Serial No.	Last Cal.
1	Signal analyzer	ROHDE & SCHWARZ	FSIQ26	100311	2014/03

10.3 TEST CONFIGURATION

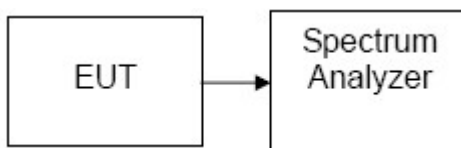

10.4 TEST PROCEDURE

1. Check the calibration of the measuring instrument using either an internal calibrator or a known signal from an external generator.
2. Position the EUT as shown in figure 4 without connection to measurement instrument. Turn on the EUT and connect its antenna terminal to measurement instrument via a low loss cable. Then set it to any one measured frequency within its operating range and make sure the instrument is operated in its linear range.
3. Use the following spectrum analyzer settings:
 Span = wide enough to capture the peak level of the emission operating on the channel closest to the bandedge, as well as any modulation products which fall outside of the authorized band of operation
 RBW = 100KHz(1% of the span)
 VBW = 3RBW
 Sweep = auto
 Detector function = peak

Copyright of this report is owned by Centre of Testing Service and may not be reproduced other than in full except with the written approval of the issuing Company.

CENTRE OF TESTING SERVICE CO., LTD.

A101, No.65, Zhuji Highway, Tianhe District, Guangzhou, China

Tel: +86-20-85543113 (32 lines)

Fax: +86-20-38780406

Complaint line: +86-20-85533471

E-mail: cts@cts-lab.com.cn

See Reverse For Terms And Conditions of Service



Trace = max hold

4. Allow the trace to stabilize. Set the marker on the emission at the band edge, or on the highest modulation product outside of the band, if this level is greater than that at the band edge. Enable the marker-delta function, then use the marker-to-peak function to move the marker to the peak of the in-band emission. Plot the result on the screen of spectrum analyzer.
5. Repeat above procedures until all measured frequencies were complete.

10.5 TEST RESULTS

Refer to attach spectrum analyzer data chart.

Copyright of this report is owned by Centre of Testing Service and may not be reproduced other than in full except with the written approval of the issuing Company.

CENTRE OF TESTING SERVICE CO., LTD.

A101, No.65, Zhuji Highway, Tianhe District, Guangzhou, China

Tel: +86-20-85543113 (32 lines)

Fax: +86-20-38780406

Complaint line: +86-20-85533471

E-mail: cts@cts-lab.com.cn

See Reverse For Terms And Conditions of Service

Band Edges (CH-Low)
 Detector mode: Peak

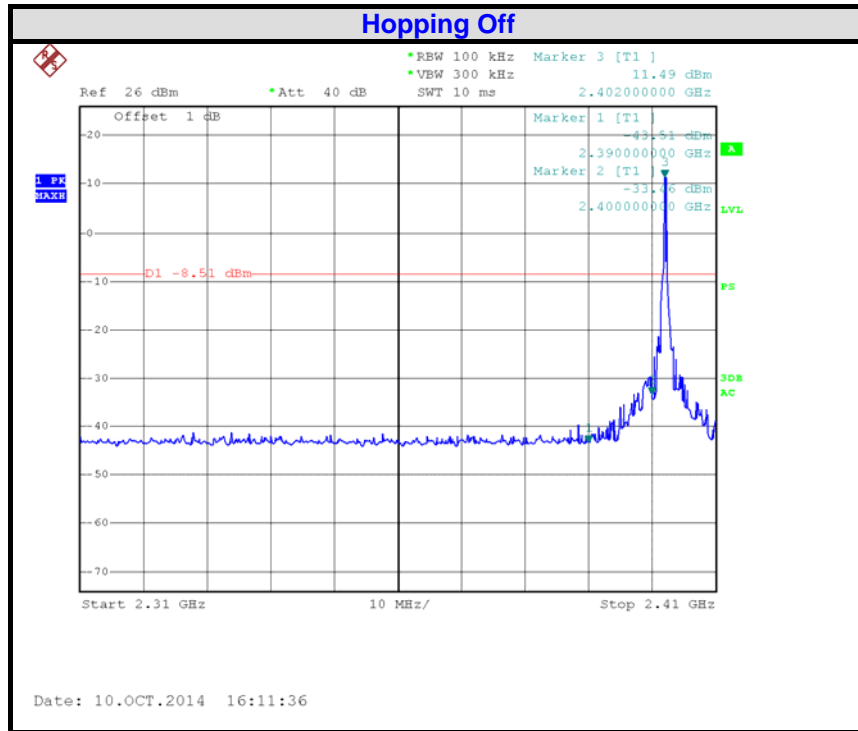

Band Edges-Hopping on (CH-Low)
 Detector mode: Peak

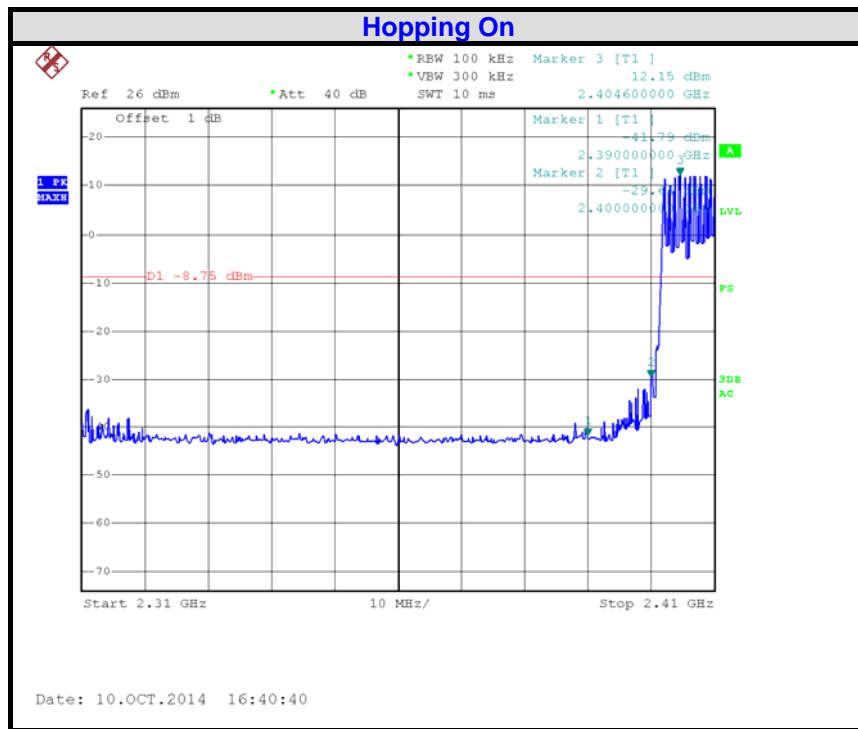

Copyright of this report is owned by Centre of Testing Service and may not be reproduced other than in full except with the written approval of the issuing Company.

CENTRE OF TESTING SERVICE CO., LTD.

A101, No.65, Zhuji Highway, Tianhe District, Guangzhou, China
 Tel: +86-20-85543113 (32 lines) Fax: +86-20-38780406
 Complaint line: +86-20-85533471 E-mail: cts@cts-lab.com.cn

See Reverse For Terms And Conditions of Service

Band Edges (CH-High)
 Detector mode: Peak

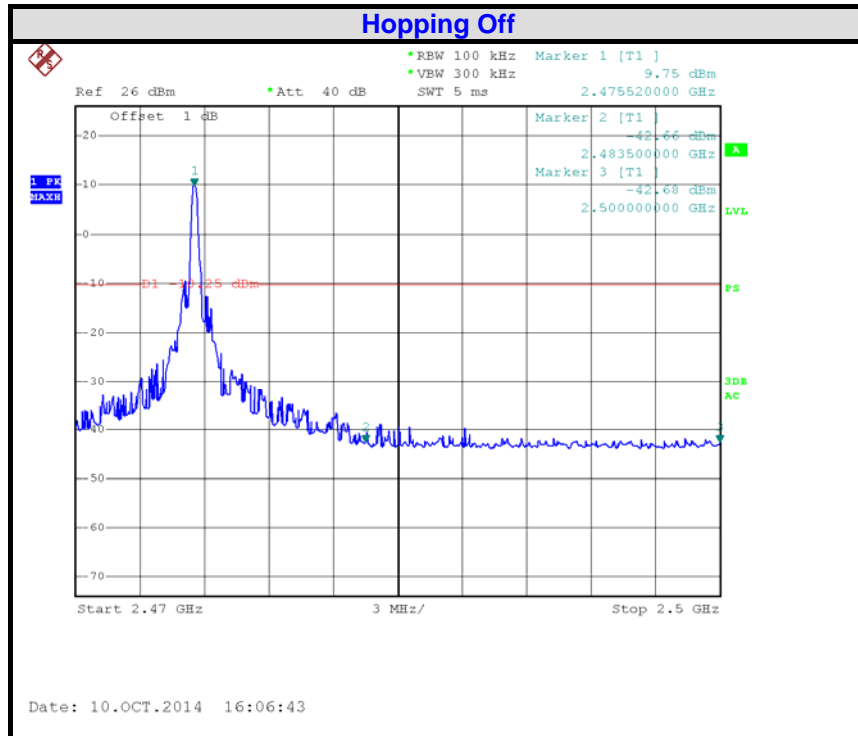

Band Edges (CH-High)
 Detector mode: Peak

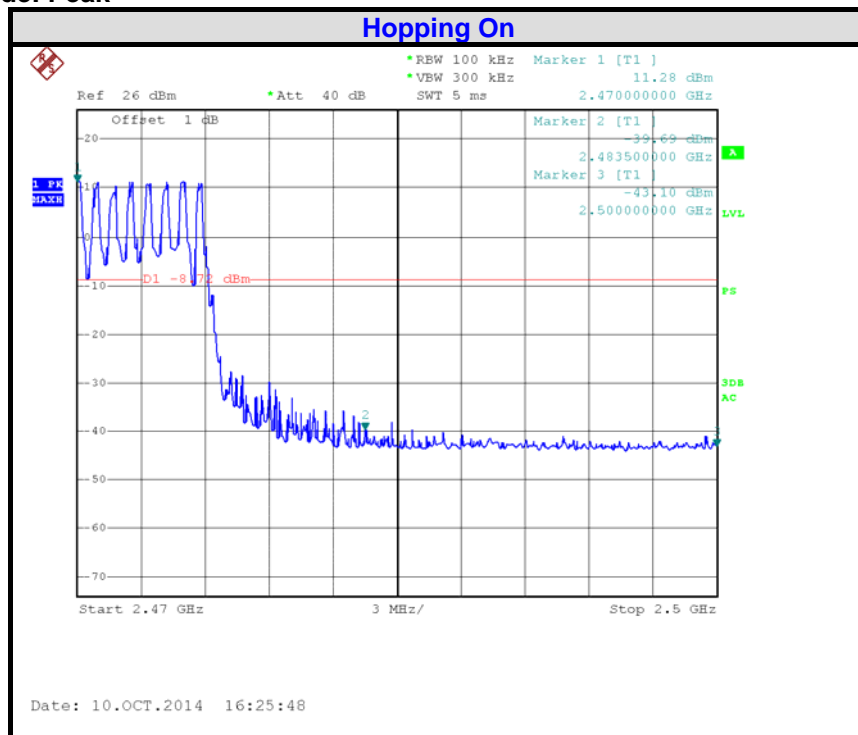

Copyright of this report is owned by Centre of Testing Service and may not be reproduced other than in full except with the written approval of the issuing Company.

CENTRE OF TESTING SERVICE CO., LTD.

A101, No.65, Zhuji Highway, Tianhe District, Guangzhou, China
 Tel: +86-20-85543113 (32 lines) Fax: +86-20-38780406
 Complaint line: +86-20-85533471 E-mail: cts@cts-lab.com.cn

See Reverse For Terms And Conditions of Service

11.0 FREQUENCY SEPARATION

11.1 LIMIT

According to RSS-210 Issue 8:A8.1, Frequency hopping systems shall have hopping channel carrier frequencies separated by a minimum of 25 kHz or the 20 dB bandwidth of the hopping channel, whichever is greater. Alternatively, frequency hopping systems operating in the 2400-2483.5 MHz band may have hopping channel carrier frequencies that are separated by 25 kHz or two-thirds of the 20 dB bandwidth of the hopping channel, whichever is greater, provided the systems operate with an output power no greater than 125 mW.

11.2 MEASUREMENT EQUIPMENT USED

Frequency Separation					
Item	Test Equipment	Manufacturer	Model No.	Serial No.	Last Cal.
1	Signal analyzer	ROHDE & SCHWARZ	FSIQ26	100311	2014/03

11.3 TEST CONFIGURATION

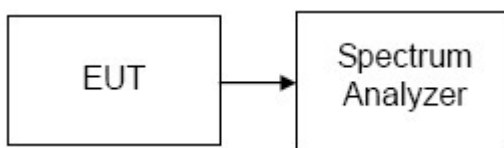

11.4 TEST PROCEDURE

1. Place the EUT on the table and set it in transmitting mode.
2. Remove the antenna from the EUT and then connect a low loss RF cable from the antenna port to the spectrum analyzer.
3. Set center frequency of spectrum analyzer = middle of hopping channel.
4. Set the spectrum analyzer as RBW=100KHz, VBW=300KHz, Adjust Span to 3 MHz, Sweep = auto.
5. Max hold. Mark 3 Peaks of hopping channel and record the 3 peaks frequency.

11.5 TEST RESULTS

PASSED



Test Data

Channel Separation (MHz)	Two-thirds of the 20dB Bandwidth (MHz)	Channel Separation Limit	Result
0.816MHz	0.367	> Two-thirds of the 20 dB Bandwidth	PASSED

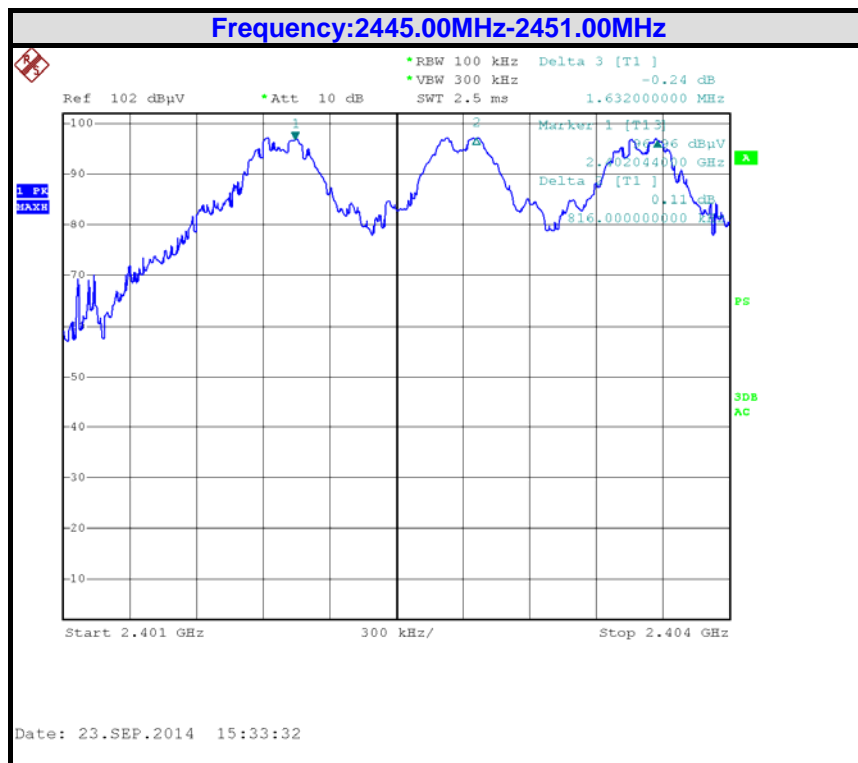

Copyright of this report is owned by Centre of Testing Service and may not be reproduced other than in full except with the written approval of the issuing Company.

CENTRE OF TESTING SERVICE CO., LTD.

A101, No.65, Zhuji Highway, Tianhe District, Guangzhou, China
 Tel: +86-20-85543113 (32 lines) Fax: +86-20-38780406
 Complaint line: +86-20-85533471 E-mail: cts@cts-lab.com.cn

See Reverse For Terms And Conditions of Service

12.0 NUMBER OF HOPPING FREQUENCY

12.1 LIMIT

According to RSS-210 Issue 8:A8.1, Frequency hopping systems operating in the 2400MHz-2483.5 MHz bands shall use at least 15 hopping frequencies.

12.2 MEASUREMENT EQUIPMENT USED

Peak Power Spectral Density					
Item	Test Equipment	Manufacturer	Model No.	Serial No.	Last Cal.
1	Signal analyzer	ROHDE & SCHWARZ	FSIQ26	100311	2014/03

12.3 TEST CONFIGURATION

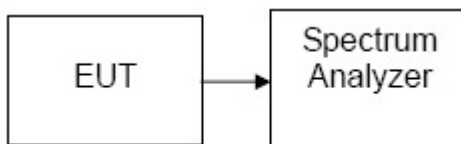

12.4 TEST PROCEDURE

1. Place the EUT on the table and set it in transmitting mode.
2. Remove the antenna from the EUT and then connect a low loss RF cable from the antenna port to the spectrum analyzer.
3. Set spectrum analyzer Start=2400MHz, Stop = 2439.6 MHz, Sweep = 1ms and Start=2443MHz, Stop = 2483.5MHz, Sweep = 1ms.
4. Set the spectrum analyzer as RBW, VBW=100KHz,
5. Max hold, view and count how many channel in the band.

12.5 TEST RESULTS

PASSED

12.6 TEST DATA

Result(No. of CH)	Limit	Result
92	>15	Pass

Test Plot

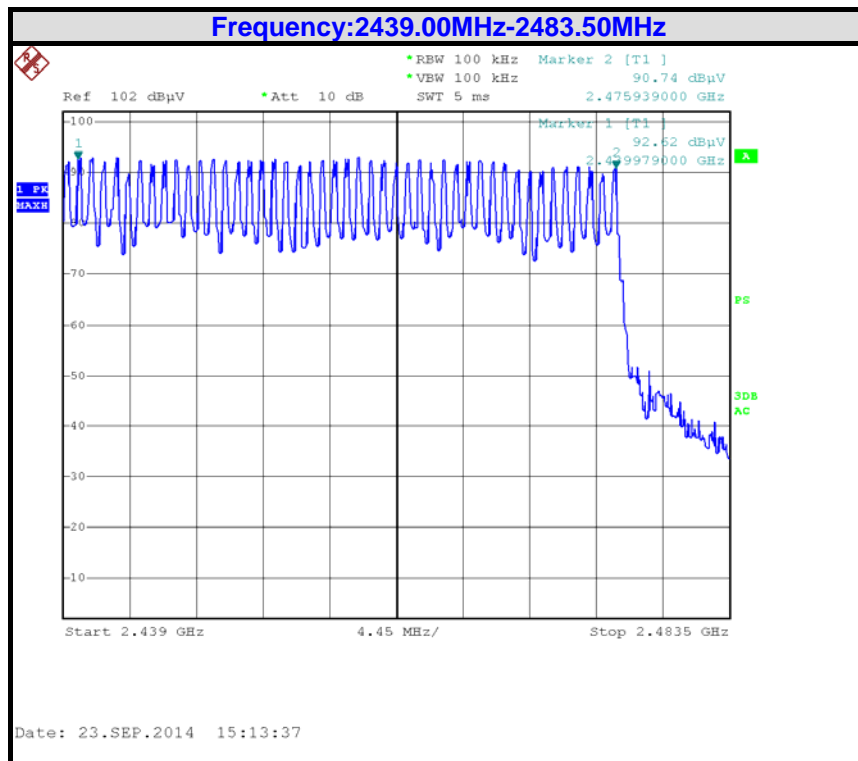
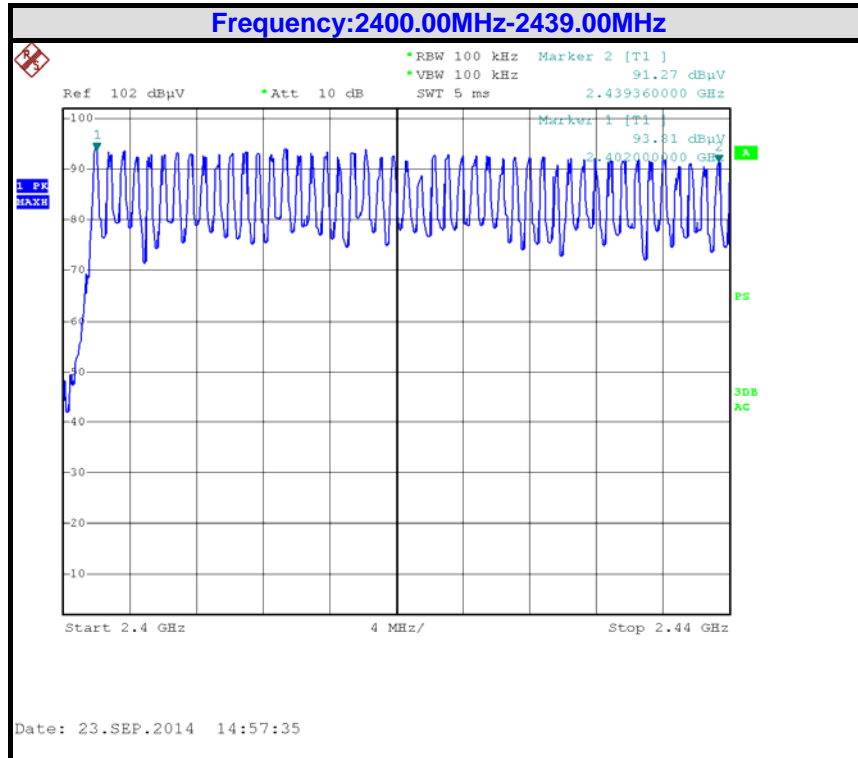

Copyright of this report is owned by Centre of Testing Service and may not be reproduced other than in full except with the written approval of the issuing Company.

CENTRE OF TESTING SERVICE CO., LTD.

A101, No.65, Zhuji Highway, Tianhe District, Guangzhou, China

Tel: +86-20-85543113 (32 lines)

Fax: +86-20-38780406

Complaint line: +86-20-85533471

E-mail: cts@cts-lab.com.cn

See Reverse For Terms And Conditions of Service

13.0 TIME OF OCCUPANCY (DWELL TIME)

13.1 LIMIT

According to RSS-210 Issue 8:A8.1, Frequency hopping systems operating in the 2400MHz-2483.5 MHz bands. The average time of occupancy on any channels shall not greater than 0.4 s within a period 0.4 s multiplied by the number of hopping channels employed.

13.2 MEASUREMENT EQUIPMENT USED

Frequency Separation					
Item	Test Equipment	Manufacturer	Model No.	Serial No.	Last Cal.
1	Signal analyzer	ROHDE & SCHWARZ	FSIQ26	100311	2014/03

13.3 TEST CONFIGURATION

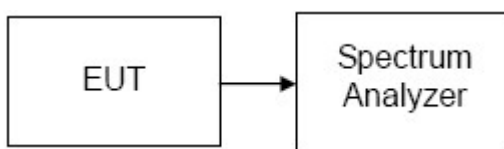

13.4 TEST PROCEDURE

1. Place the EUT on the table and set it in transmitting mode.
2. Remove the antenna from the EUT and then connect a low loss RF cable from the antenna port to the spectrum analyzer.
3. Set center frequency of spectrum analyzer = operating frequency.
4. Set the spectrum analyzer as RBW, VBW=1MHz, Span = 0Hz, Sweep = auto.
5. Repeat above procedures until all frequency measured were complete.

13.5 TEST RESULTS

PASSED

13.6 TEST DATA

Dwell time: $0.5 \times 17 \times 10 = 85.00(\text{ms})$

Pulse Time (ms)	Total of Dwell (ms)	Period Time (s)	Limit (ms)	Result
0.5	85.00	36.8(92*0.4)	400.00	PASS

Test Plot

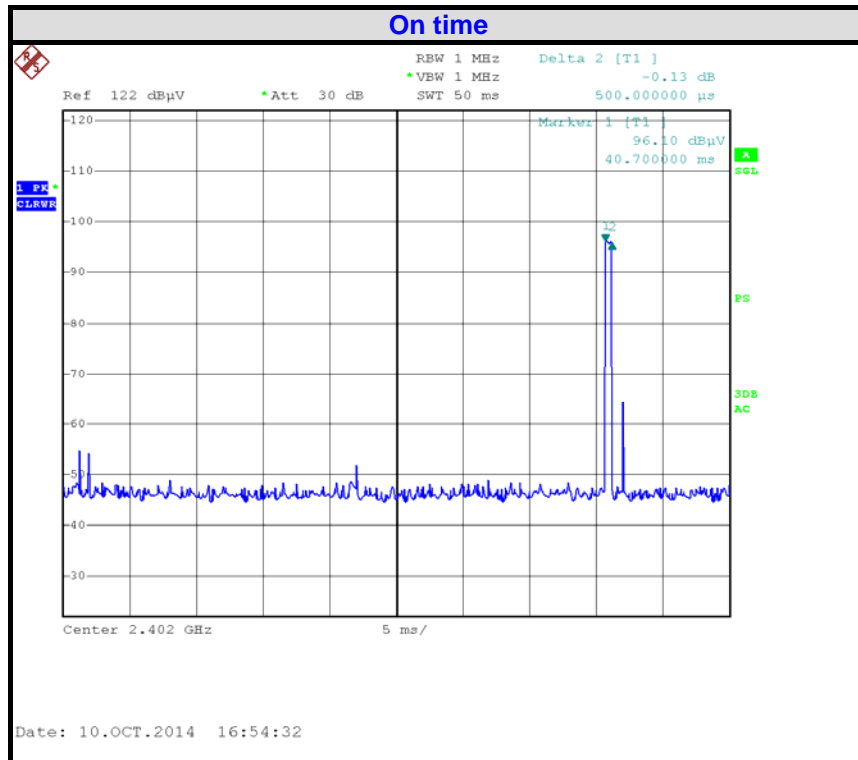
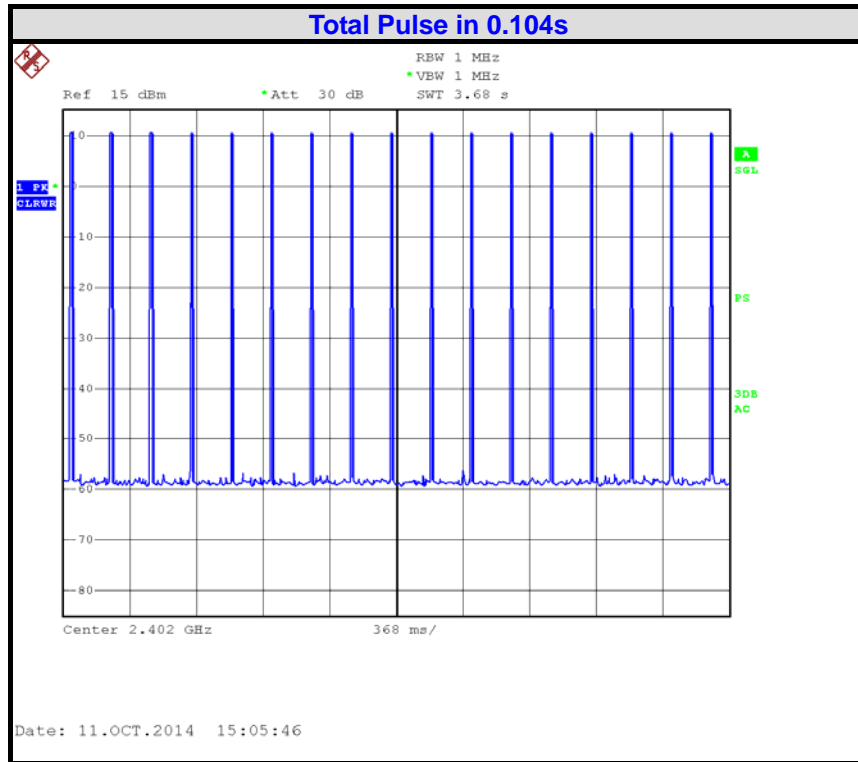

Copyright of this report is owned by Centre of Testing Service and may not be reproduced other than in full except with the written approval of the issuing Company.

CENTRE OF TESTING SERVICE CO., LTD.

A101, No.65, Zhuji Highway, Tianhe District, Guangzhou, China
 Tel: +86-20-85543113 (32 lines) Fax: +86-20-38780406
 Complaint line: +86-20-85533471 E-mail: cts@cts-lab.com.cn

See Reverse For Terms And Conditions of Service

14.0 TRANSMITTER UNWANTED EMISSIONS

14.1 LIMIT

According to RSS-Gen Issue 3:4.9. Except as provided elsewhere in this Subpart, the emissions from an intentional radiator shall not exceed the field strength levels specified in the following table:

FREQUENCY MHz	DISTANCE Meters	FIELD STRENGTHS LIMIT	
		$\mu\text{V}/\text{m}$	$\text{dB}(\mu\text{V})/\text{m}$
0.009 ~ 0.490	300	2400/F(kHz)	---
0.490 ~ 1.705	30	24000/F(kHz)	---
1.705 ~ 30	30	30	---
30 ~ 88	3	100	40.0
88 ~ 216	3	150	43.5
216 ~ 960	3	200	46.0
960 ~ 1000	3	500	54.0
Above 1000	3	Other: 74.0 $\text{dB}(\mu\text{V})/\text{m}$ (Peak) 54.0 $\text{dB}(\mu\text{V})/\text{m}$ (Average)	

Note: Except as provided in paragraph (g), fundamental emissions from intentional radiators operating under this Section shall not be located in the frequency bands 54-72 MHz, 76-88 MHz, 174-216 MHz or 470-806 MHz. However, operation within these frequency bands is permitted under other sections of this Part, e.g., Sections 15.231 and 15.241.

14.2 TEST EQUIPMENT

Radiated disturbance (electric field)					
Item	Test Equipment	Manufacturer	Model No.	Serial No.	Last Cal.
1	EMI Test Receiver	ROHDE & SCHWARZ	ESCI	100868	2013/11
2	Biconical Antenna	ROHDE & SCHWARZ	HK116	100221	2014/03
3	Log per Antenna	ROHDE & SCHWARZ	HL223	100226	2014/03
4	Log per Antenna	ROHDE & SCHWARZ	HL050	100186	2014/03
5	Signal analyzer	ROHDE & SCHWARZ	FSIQ26	100311	2014/03
6	Loop Antenna	A.R.A	PLA-1030/B	1030	2013/11
7	EMI Test Software	EZ-EMC	Farad	N/A	N/A

Copyright of this report is owned by Centre of Testing Service and may not be reproduced other than in full except with the written approval of the issuing Company.

CENTRE OF TESTING SERVICE CO., LTD.

A101, No.65, Zhuji Highway, Tianhe District, Guangzhou, China

Tel: +86-20-85543113 (32 lines)

Fax: +86-20-38780406

Complaint line: +86-20-85533471

E-mail: cts@cts-lab.com.cn

See Reverse For Terms And Conditions of Service

14.3 TEST CONFIGURATION

Below 30MHz

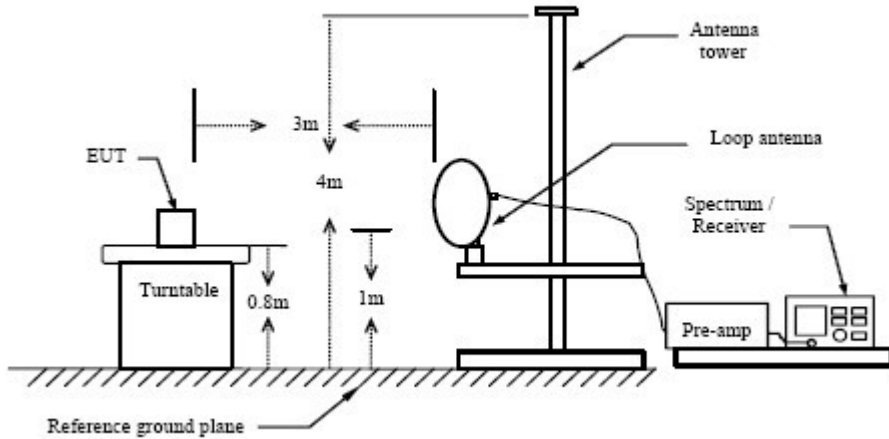

Below 1 GHz

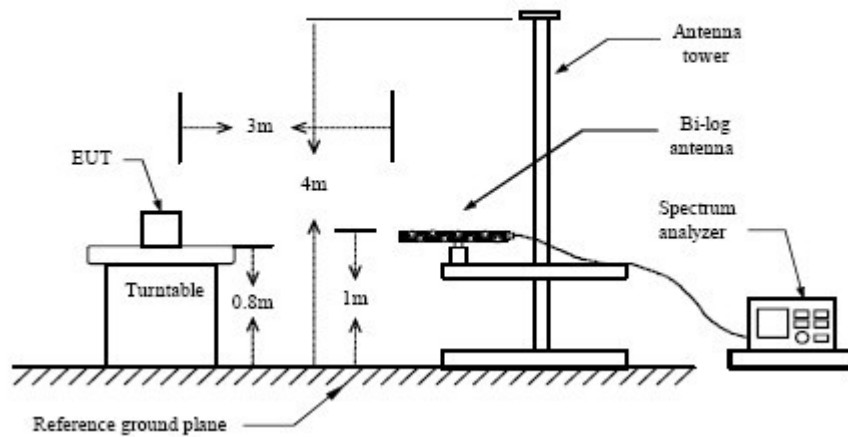

Copyright of this report is owned by Centre of Testing Service and may not be reproduced other than in full except with the written approval of the issuing Company.

CENTRE OF TESTING SERVICE CO., LTD.

A101, No.65, Zhuji Highway, Tianhe District, Guangzhou, China
Tel: +86-20-85543113 (32 lines) Fax: +86-20-38780406
Complaint line: +86-20-85533471 E-mail: cts@cts-lab.com.cn

See Reverse For Terms And Conditions of Service

Above 1 GHz

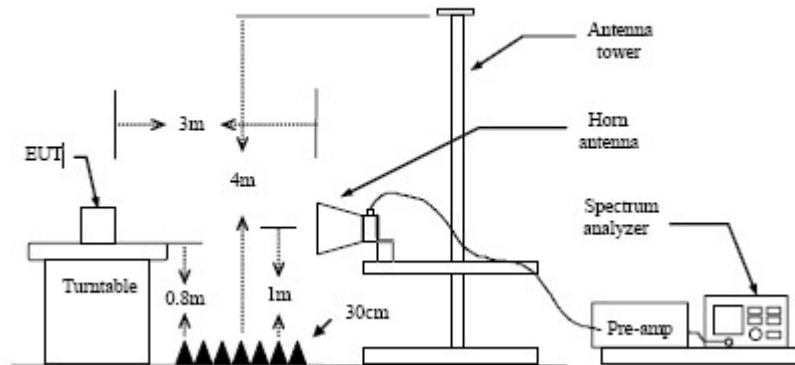

14.4 TEST PROCEDURE

1. The EUT is placed on a turntable, which is 0.8m above ground plane.
2. The turntable shall be rotated for 360 degrees to determine the position of maximum emission level.
3. EUT is set 3m away from the receiving antenna, which is varied from 1m to 4m to find out the highest emissions.
4. Maximum procedure was performed on the six highest emissions to ensure EUT compliance.
5. And also, each emission was to be maximized by changing the polarization of receiving antenna both horizontal and vertical.
6. Repeat above procedures until the measurements for all frequencies are complete.

14.5 TEST RESULTS

The frequency range from 9KHz~30MHz, 30MHz to 230MHz, 230MHz to 1000MHz and above 1GHz. is investigated. Please see the following pages.

Copyright of this report is owned by Centre of Testing Service and may not be reproduced other than in full except with the written approval of the issuing Company.

CENTRE OF TESTING SERVICE CO., LTD.

A101, No.65, Zhuji Highway, Tianhe District, Guangzhou, China

Tel: +86-20-85543113 (32 lines)

Fax: +86-20-38780406

Complaint line: +86-20-85533471

E-mail: cts@cts-lab.com.cn

See Reverse For Terms And Conditions of Service



Test Mode:	TX -X Position Mode	Result:	<input checked="" type="checkbox"/> - passed
Frequency range:	9KHz~30MHz		<input type="checkbox"/> - not passed

No.	Frequency (MHz)	Factor (dB)	Reading (dBuV)	Level (dBuV/m)	Limit (dBuV/m)	Margin (dB)	Det.
Remark: The test result reading value is to low, margin all > 10dB of the limit.							

Copyright of this report is owned by Centre of Testing Service and may not be reproduced other than in full except with the written approval of the issuing Company.

CENTRE OF TESTING SERVICE CO., LTD.

A101, No.65, Zhuji Highway, Tianhe District, Guangzhou, China

Tel: +86-20-85543113 (32 lines)

Fax: +86-20-38780406

Complaint line: +86-20-85533471

E-mail: cts@cts-lab.com.cn

See Reverse For Terms And Conditions of Service



EUT	ECX/PRB 2.4GHz Transmitter, 2-Channel V3
Operating Condition	Battery 1.5V*4
Test Condition	Ambient Temperature: 25°C Humidity: 56%
Test distance	3 Meter
Operator	Duke
MODEL NO	ECX13002

Channel:	TX -X Position	Result:	<input checked="" type="checkbox"/> - passed
Test point:	Horizontal		<input type="checkbox"/> - not passed
Frequency range:	30MHz-1GHz		

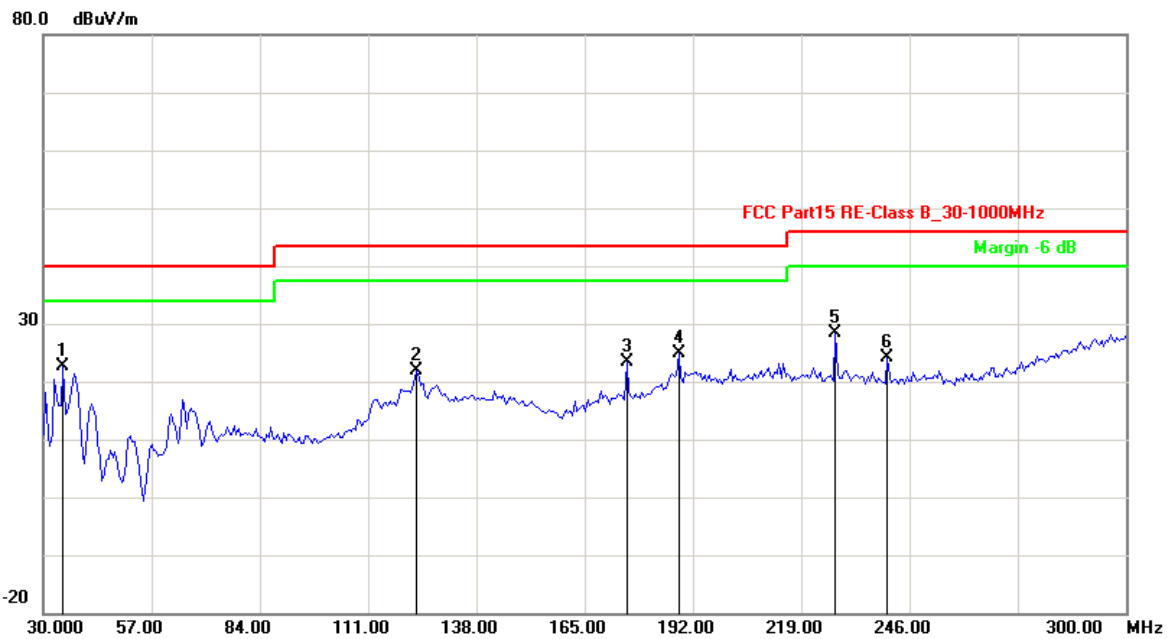

No.	Frequency (MHz)	Factor (dB)	Reading (dBuV)	Level (dBuV/m)	Limit (dBuV/m)	Margin (dB)	Det.
1	34.8697	-22.87	45.43	22.56	40.00	-17.44	QP
2	123.0661	-17.80	39.76	21.96	43.50	-21.54	QP
3	175.5511	-16.03	39.43	23.40	43.50	-20.10	QP
4	188.5371	-12.53	37.32	24.79	43.50	-18.71	QP
5	227.4950	-12.36	40.68	28.32	46.00	-17.68	QP
6	240.4810	-13.11	37.12	24.01	46.00	-21.99	QP

Remark: Other frequency mini margin all >6 dB of Limit

Copyright of this report is owned by Centre of Testing Service and may not be reproduced other than in full except with the written approval of the issuing Company.

CENTRE OF TESTING SERVICE CO., LTD.

A101, No.65, Zhuji Highway, Tianhe District, Guangzhou, China

Tel: +86-20-85543113 (32 lines)

Fax: +86-20-38780406

Complaint line: +86-20-85533471

E-mail: cts@cts-lab.com.cn

See Reverse For Terms And Conditions of Service

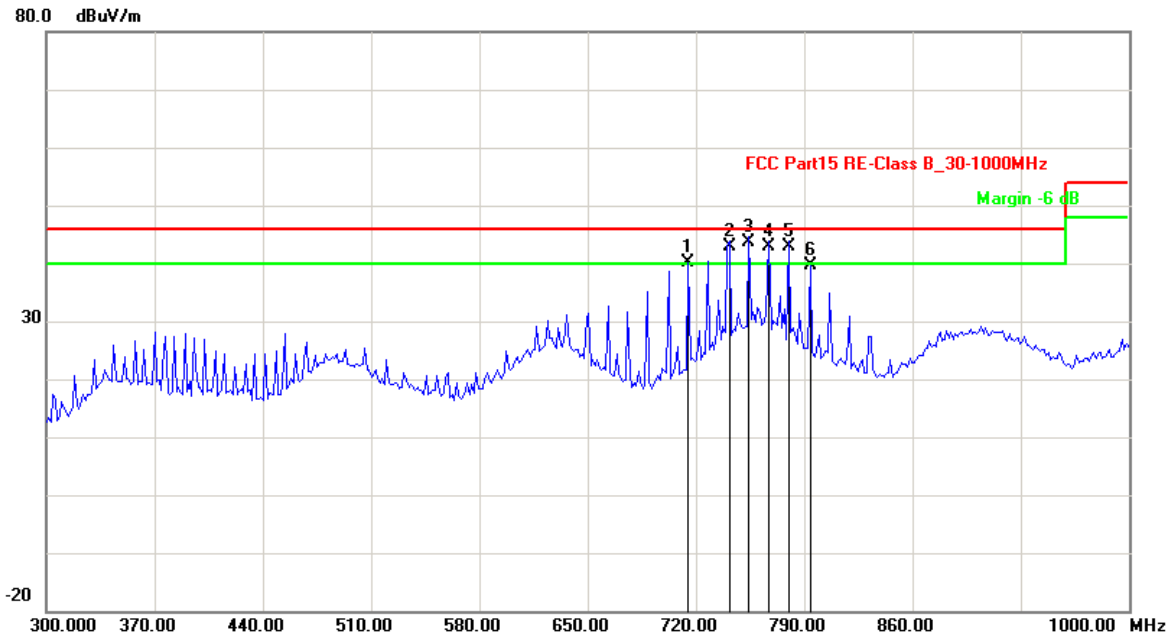

No.	Frequency (MHz)	Factor (dB)	Reading (dBuV)	Level (dBuV/m)	Limit (dBuV/m)	Margin (dB)	Det.
1	715.2305	-11.73	51.89	40.16	46.00	-5.84	QP
2	741.8838	-7.01	50.00	42.99	46.00	-3.01	QP
3	754.5090	-5.95	49.65	43.70	46.00	-2.30	QP
4	767.1343	-5.65	48.50	42.85	46.00	-3.15	QP
5	779.7595	-5.94	48.79	42.85	46.00	-3.15	QP
6	793.7876	-7.71	47.45	39.74	46.00	-6.26	QP

Remark: Other frequency mini margin all >6 dB of Limit

Channel:	Low Channel	Result:	<input checked="" type="checkbox"/> - passed
Test point:	Horizontal		<input type="checkbox"/> - not passed
Frequency range:	1GHz-26.5GHz		

No.	Frequency (MHz)	Factor (dB)	Reading (dBuV)	Level (dBuV/m)	Limit (dBuV/m)	Margin (dB)	Det.
1	3446.894	8.03	42.99	51.02	74.00	-22.98	peak
2	3446.894	8.03	28.21	36.24	54.00	-17.76	AVG
3	4108.216	10.06	41.37	51.43	74.00	-22.57	peak
4	4108.216	10.06	25.23	35.29	54.00	-18.71	AVG
5	5364.730	13.33	39.79	53.12	74.00	-20.88	peak
6	5364.730	13.33	25.41	38.74	54.00	-15.26	AVG

Remark: Other frequency mini margin all >6 dB of Limit

Copyright of this report is owned by Centre of Testing Service and may not be reproduced other than in full except with the written approval of the issuing Company.

CENTRE OF TESTING SERVICE CO., LTD.

A101, No.65, Zhuji Highway, Tianhe District, Guangzhou, China
 Tel: +86-20-85543113 (32 lines) Fax: +86-20-38780406
 Complaint line: +86-20-85533471 E-mail: cts@cts-lab.com.cn

See Reverse For Terms And Conditions of Service



Channel:	Middle Channel	Result: <input checked="" type="checkbox"/> - passed <input type="checkbox"/> - not passed
Test point:	Horizontal	
Frequency range:	1GHz-26.5GHz	

No.	Frequency (MHz)	Factor (dB)	Reading (dBuV)	Level (dBuV/m)	Limit (dBuV/m)	Margin (dB)	Det.
1	4086.172	10.01	39.20	49.21	74.00	-24.79	peak
2	4086.172	10.01	24.28	34.29	54.00	-19.71	AVG
3	4505.010	11.00	38.57	49.57	74.00	-24.43	peak
4	4505.010	11.00	24.82	35.82	54.00	-18.18	AVG
5	6048.096	15.50	40.44	55.94	74.00	-18.06	peak
6	6048.096	15.50	24.68	40.18	54.00	-13.82	AVG

Remark: Other frequency mini margin all >6 dB of Limit

Channel:	High Channel	Result: <input checked="" type="checkbox"/> - passed <input type="checkbox"/> - not passed
Test point:	Horizontal	
Frequency range:	1GHz-26.5GHz	

No.	Frequency (MHz)	Factor (dB)	Reading (dBuV)	Level (dBuV/m)	Limit (dBuV/m)	Margin (dB)	Det.
1	4174.349	10.22	40.58	50.80	74.00	-23.20	peak
2	4174.349	10.22	25.06	35.28	54.00	-18.72	AVG
3	4967.936	12.08	37.78	49.86	74.00	-24.14	peak
4	4967.936	12.08	22.11	34.19	54.00	-19.81	AVG
5	7569.138	18.59	37.60	56.19	74.00	-17.81	peak
6	7569.138	18.59	22.63	41.22	54.00	-12.78	AVG

Remark: Other frequency mini margin all >6 dB of Limit

Copyright of this report is owned by Centre of Testing Service and may not be reproduced other than in full except with the written approval of the issuing Company.

CENTRE OF TESTING SERVICE CO., LTD.

A101, No.65, Zhuji Highway, Tianhe District, Guangzhou, China

Tel: +86-20-85543113 (32 lines)

Fax: +86-20-38780406

Complaint line: +86-20-85533471

E-mail: cts@cts-lab.com.cn

See Reverse For Terms And Conditions of Service



Channel:	TX -X Position	Result:	<input checked="" type="checkbox"/> - passed
Test point:	Vertical		<input type="checkbox"/> - not passed
Frequency range:	30MHz-1GHz		

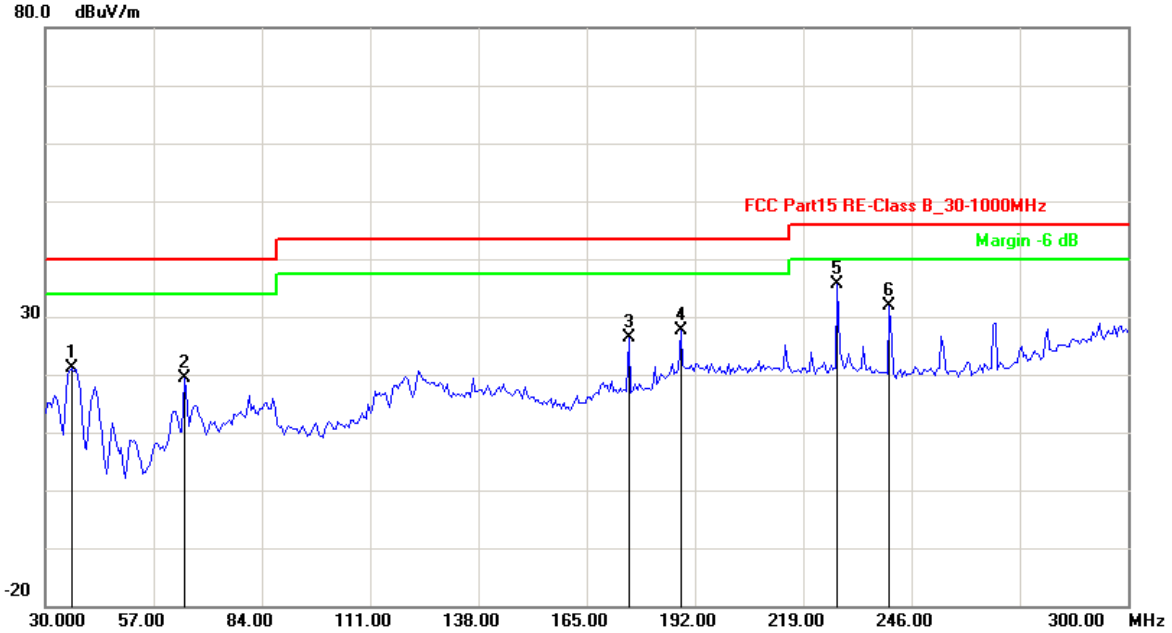

No.	Frequency (MHz)	Factor (dB)	Reading (dBuV)	Level (dBuV/m)	Limit (dBuV/m)	Margin (dB)	Det.
1	36.4930	-23.89	44.98	21.09	40.00	-18.91	QP
2	64.6293	-23.85	43.13	19.28	40.00	-20.72	QP
3	175.5511	-16.03	42.40	26.37	43.50	-17.13	QP
4	188.5371	-12.53	40.18	27.65	43.50	-15.85	QP
5	227.4950	-12.36	48.09	35.73	46.00	-10.27	QP
6	240.4810	-13.11	44.91	31.80	46.00	-14.20	QP

Remark: Other frequency mini margin all >6 dB of Limit

Copyright of this report is owned by Centre of Testing Service and may not be reproduced other than in full except with the written approval of the issuing Company.

CENTRE OF TESTING SERVICE CO., LTD.

A101, No.65, Zhuji Highway, Tianhe District, Guangzhou, China
 Tel: +86-20-85543113 (32 lines) Fax: +86-20-38780406
 Complaint line: +86-20-85533471 E-mail: cts@cts-lab.com.cn

See Reverse For Terms And Conditions of Service

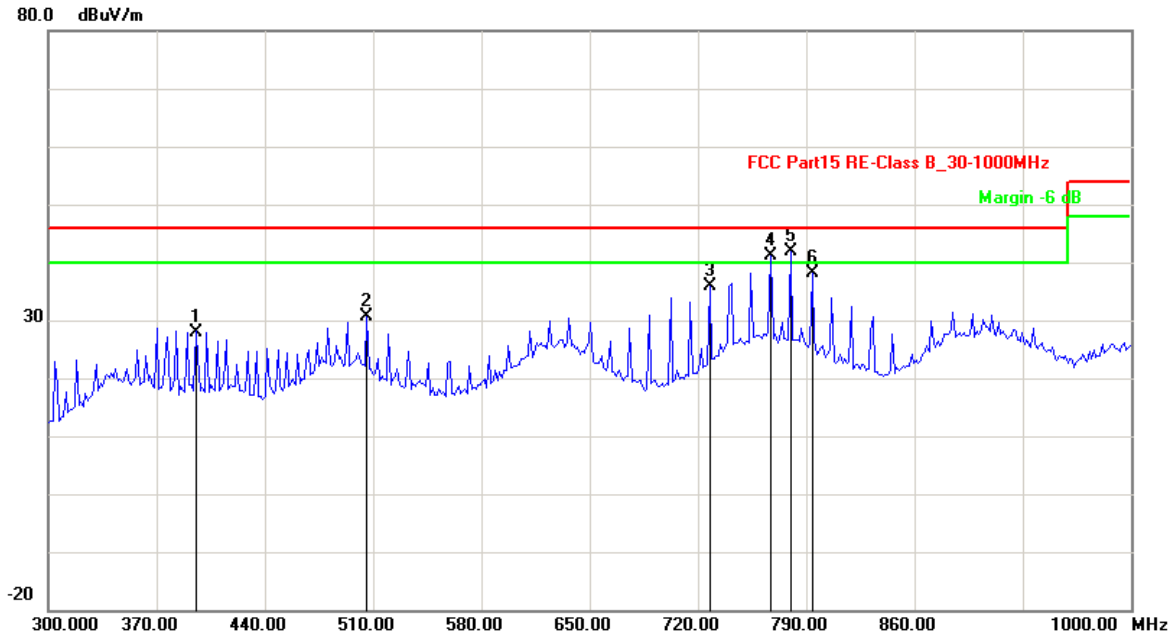

No.	Frequency (MHz)	Factor (dB)	Reading (dBuV)	Level (dBuV/m)	Limit (dBuV/m)	Margin (dB)	Det.
1	395.3908	-14.99	42.99	28.00	46.00	-18.00	QP
2	506.2124	-11.10	41.73	30.63	46.00	-15.37	QP
3	727.8557	-9.56	45.41	35.85	46.00	-10.15	QP
4	767.1343	-5.65	46.84	41.19	46.00	-4.81	QP
5	779.7595	-5.94	47.91	41.97	46.00	-4.03	QP
6	793.7876	-7.71	45.75	38.04	46.00	-7.96	QP

Remark: Other frequency mini margin all >6 dB of Limit

Channel:	Low Channel	Result:	<input checked="" type="checkbox"/> - passed
Test point:	Vertical		<input type="checkbox"/> - not passed
Frequency range:	1GHz-26.5GHz		

No.	Frequency (MHz)	Factor (dB)	Reading (dBuV)	Level (dBuV/m)	Limit (dBuV/m)	Margin (dB)	Det.
1	3402.806	7.89	43.01	50.90	74.00	-23.10	peak
2	3402.806	7.89	27.27	35.16	54.00	-18.84	AVG
3	4262.525	10.43	40.81	51.24	74.00	-22.76	peak
4	4262.525	10.43	25.78	36.21	54.00	-17.79	AVG
5	5585.170	14.04	40.65	54.69	74.00	-19.31	peak
6	5585.170	14.04	25.63	39.67	54.00	-14.33	AVG

Remark: Other frequency mini margin all >6 dB of Limit

Copyright of this report is owned by Centre of Testing Service and may not be reproduced other than in full except with the written approval of the issuing Company.

CENTRE OF TESTING SERVICE CO., LTD.

A101, No.65, Zhuji Highway, Tianhe District, Guangzhou, China
 Tel: +86-20-85543113 (32 lines) Fax: +86-20-38780406
 Complaint line: +86-20-85533471 E-mail: cts@cts-lab.com.cn

See Reverse For Terms And Conditions of Service



Channel:	Middle Channel	Result: <input checked="" type="checkbox"/> - passed <input type="checkbox"/> - not passed
Test point:	Vertical	
Frequency range:	1GHz-26.5GHz	

No.	Frequency (MHz)	Factor (dB)	Reading (dBuV)	Level (dBuV/m)	Limit (dBuV/m)	Margin (dB)	Det.
1	3865.731	9.38	40.66	50.04	74.00	-23.96	peak
2	3865.731	9.38	26.83	36.21	54.00	-17.79	AVG
3	4923.848	11.98	37.97	49.95	74.00	-24.05	peak
4	4923.848	11.98	23.31	35.29	54.00	-18.71	AVG
5	5915.832	15.11	41.69	56.80	74.00	-17.20	peak
6	5915.832	15.11	26.91	42.02	54.00	-11.98	AVG

Remark: Other frequency mini margin all >6 dB of Limit

Channel:	High Channel	Result: <input checked="" type="checkbox"/> - passed <input type="checkbox"/> - not passed
Test point:	Vertical	
Frequency range:	1GHz-26.5GHz	

No.	Frequency (MHz)	Factor (dB)	Reading (dBuV)	Level (dBuV/m)	Limit (dBuV/m)	Margin (dB)	Det.
1	3623.247	8.60	40.64	49.24	74.00	-24.76	peak
2	3623.247	8.60	25.55	34.15	54.00	-19.85	AVG
3	4549.098	11.10	38.41	49.51	74.00	-24.49	peak
4	4549.098	11.10	24.19	35.29	54.00	-18.71	AVG
5	5254.509	12.98	37.62	50.60	74.00	-23.40	peak
6	5254.509	12.98	22.23	35.21	54.00	-18.79	AVG

Remark: Other frequency mini margin all >6 dB of Limit

Copyright of this report is owned by Centre of Testing Service and may not be reproduced other than in full except with the written approval of the issuing Company.

CENTRE OF TESTING SERVICE CO., LTD.

A101, No.65, Zhuji Highway, Tianhe District, Guangzhou, China

Tel: +86-20-85543113 (32 lines)

Fax: +86-20-38780406

Complaint line: +86-20-85533471

E-mail: cts@cts-lab.com.cn

See Reverse For Terms And Conditions of Service

15.0 CONDUCTED SPURIOUS EMISSIONS

15.1 LIMIT

According to RSS-210 Issue 8:A8.5, In any 100 kHz bandwidth outside the frequency band in which the spread spectrum or digitally modulated device is operating, the RF power that is produced shall be at least 20 dB below that in the 100 kHz bandwidth within the band that contains the highest level of the desired power, based on either an RF conducted or a radiated measurement, provided that the transmitter demonstrates compliance with the peak conducted power limits. If the transmitter complies with the conducted power limits based on the use of root-mean-square averaging over a time interval, as permitted under Section A8.4 (4), the attenuation required shall be 30 dB instead of 20 dB. Attenuation below the general field strength limits specified in RSS-Gen is not required.

15.2 TEST EQUIPMENT

Radiated disturbance (electric field)					
Item	Test Equipment	Manufacturer	Model No.	Serial No.	Last Cal.
1	Signal analyzer	ROHDE & SCHWARZ	FSIQ26	100311	2014/03

15.3 TEST CONFIGURATION

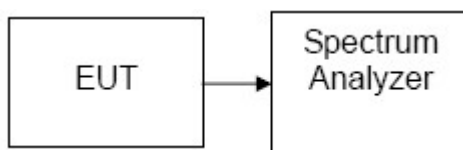

15.4 TEST PROCEDURE

1. Check the calibration of the measuring instrument using either an internal calibrator or a known signal from an external generator.
2. Position the EUT as shown in figure 4 without connection to measurement instrument. Turn on the EUT and connect its antenna terminal to measurement instrument via a low loss cable. Then set it to any one measured frequency within its operating range and make sure the instrument is operated in its linear range.
3. Use the following spectrum analyzer settings:
 Span = wide enough to capture the peak level of the in-band emission and all spurious emissions (e.g., harmonics) from the lowest frequency generated in the EUT up through the 10th harmonic. Typically, several plots are required to cover this entire span.
 RBW = 100 kHz
 VBW = RBW
 Sweep = auto
 Detector function = peak

Copyright of this report is owned by Centre of Testing Service and may not be reproduced other than in full except with the written approval of the issuing Company.

CENTRE OF TESTING SERVICE CO., LTD.

A101, No.65, Zhuji Highway, Tianhe District, Guangzhou, China

Tel: +86-20-85543113 (32 lines)

Fax: +86-20-38780406

Complaint line: +86-20-85533471

E-mail: cts@cts-lab.com.cn

See Reverse For Terms And Conditions of Service



Trace = max hold.

4. Allow the trace to stabilize. Set the marker on the peak of any spurious emission recorded. Plot the result on the screen of spectrum analyzer.
5. Repeat above procedures until all measured frequencies were complete.

15.5 TEST RESULTS

Low Channel:

30MHz to 26.6 GHz frequency band: All emissions are attenuated more than 20dB from the carrier.

Middle Channel:

30MHz to 26.6 GHz frequency band: All emissions are attenuated more than 20dB from the carrier.

High Channel:

30MHz to 26.6 GHz frequency band: All emissions are attenuated more than 20dB from the carrier.

Copyright of this report is owned by Centre of Testing Service and may not be reproduced other than in full except with the written approval of the issuing Company.

CENTRE OF TESTING SERVICE CO., LTD.

A101, No.65, Zhuji Highway, Tianhe District, Guangzhou, China

Tel: +86-20-85543113 (32 lines)

Fax: +86-20-38780406

Complaint line: +86-20-85533471

E-mail: cts@cts-lab.com.cn

See Reverse For Terms And Conditions of Service

Test Plot:

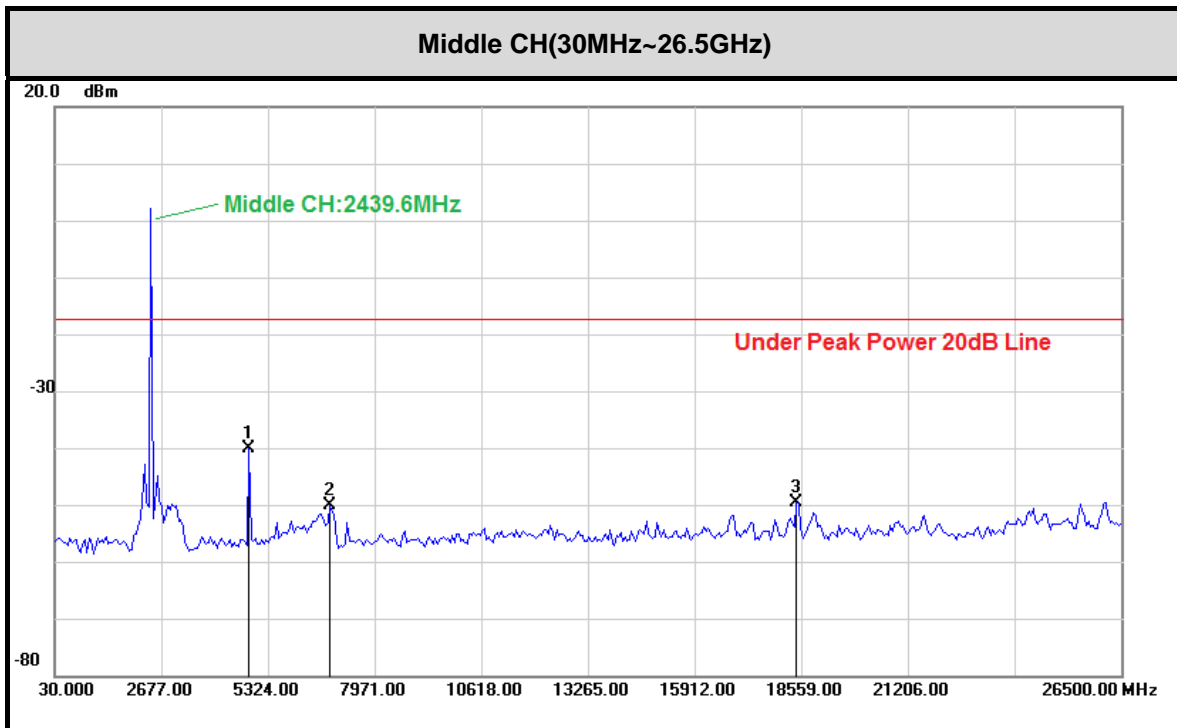
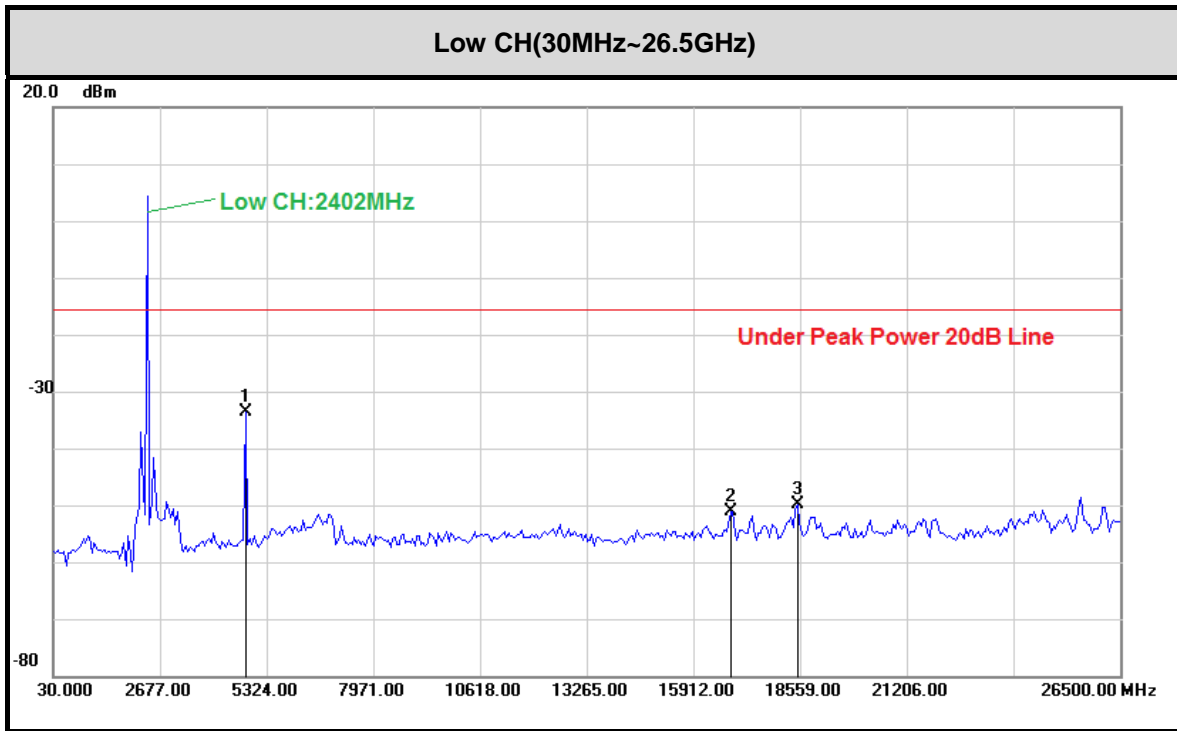

Copyright of this report is owned by Centre of Testing Service and may not be reproduced other than in full except with the written approval of the issuing Company.

CENTRE OF TESTING SERVICE CO., LTD.

A101, No.65, Zhuji Highway, Tianhe District, Guangzhou, China

Tel: +86-20-85543113 (32 lines)

Fax: +86-20-38780406

Complaint line: +86-20-85533471

E-mail: cts@cts-lab.com.cn

See Reverse For Terms And Conditions of Service

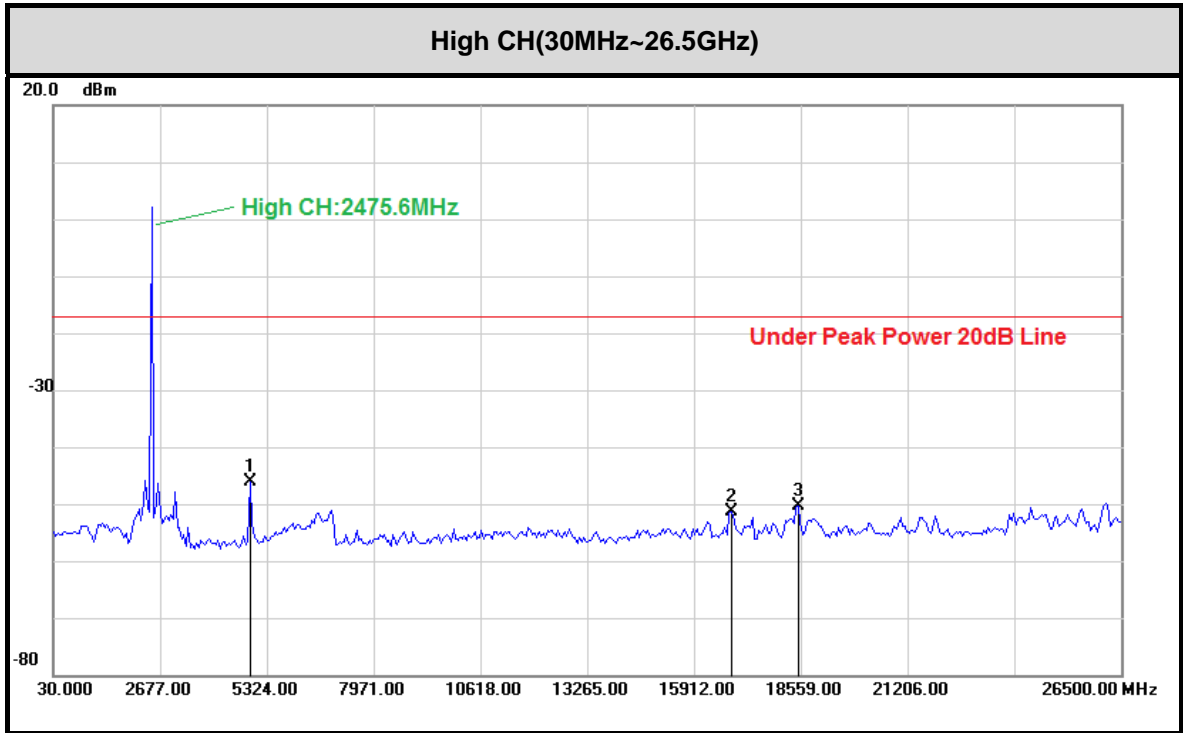

Copyright of this report is owned by Centre of Testing Service and may not be reproduced other than in full except with the written approval of the issuing Company.

CENTRE OF TESTING SERVICE CO., LTD.

A101, No.65, Zhuji Highway, Tianhe District, Guangzhou, China

Tel: +86-20-85543113 (32 lines)

Fax: +86-20-38780406

Complaint line: +86-20-85533471

E-mail: cts@cts-lab.com.cn

See Reverse For Terms And Conditions of Service

16. 99% OCCUPIED BANDWIDTH

16.1 TEST PROCEDUR

According to RSS-210 Annex 8 and RSS-Gen 4.6.1 The Bluetooth Dual HRM Strap output is connected to the spectrum analyzer. The resolution bandwidth shall be set to as close to 1% of the selected span as is possible without being below 1%. The video bandwidth shall be set to 3 times the resolution bandwidth. Video averaging is not permitted. Where practical, a sampling detector shall be used given that a peak or peak hold may produce a wider bandwidth than actual. The sweep time is coupled.

16.2. TEST EQUIPMENT

Band Edge Compliance test					
Item	Test Equipment	Manufacturer	Model No.	Serial No.	Last Cal.
1	Log per Antenna	ROHDE & SCHWARZ	HL050	100186	2014/03/30
2	Signal analyzer	ROHDE & SCHWARZ	FSIQ26	100311	2014/03/25

16.3 TEST CONFIGURATION

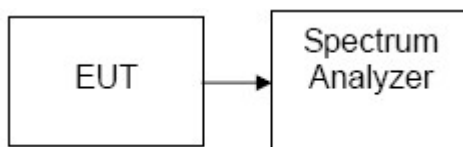

16.4 TEST PROCEDURE

1. Place the EUT on the table and set it in the transmitting mode.
2. Remove the antenna from the EUT, then connect a low loss RF cable from antenna port to the spectrum analyzer.
3. Set the spectrum analyzer as RBW=10kHz, VBW=100kHz, Span=10MHz, Sweep = auto.
4. Mark the peak frequency and set 99% occupied bandwidth function on spectrum.
5. Repeat until all the test channels are investigated.

16.5 TEST RESULTS

Channel	Frequency (MHz)	99% Bandwidth (MHz)	Limit (dBm)	Result
Low	2402	0.579	-----	PASS
Middle	2439.6	0.513	-----	PASS
High	2475.6	0.567	-----	PASS

Test Plot

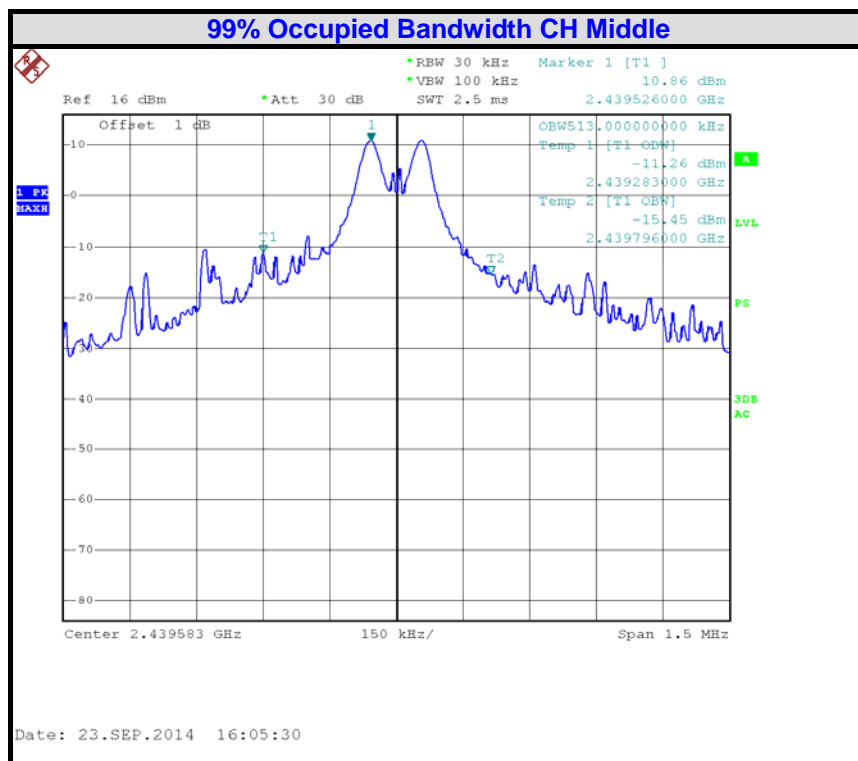
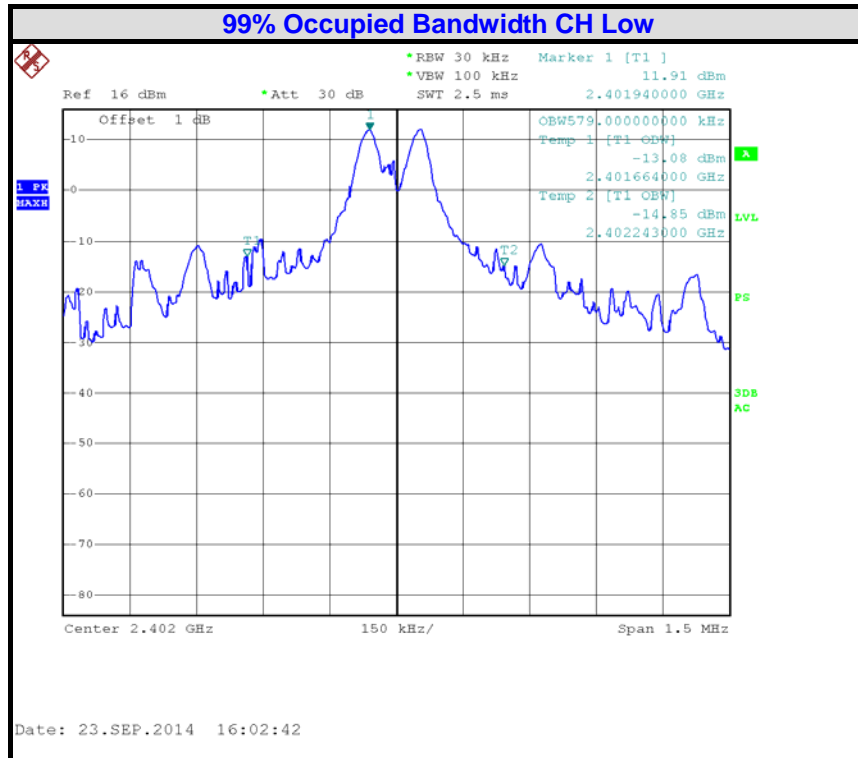

Copyright of this report is owned by Centre of Testing Service and may not be reproduced other than in full except with the written approval of the issuing Company.

CENTRE OF TESTING SERVICE CO., LTD.

A101, No.65, Zhuji Highway, Tianhe District, Guangzhou, China
 Tel: +86-20-85543113 (32 lines) Fax: +86-20-38780406
 Complaint line: +86-20-85533471 E-mail: cts@cts-lab.com.cn

See Reverse For Terms And Conditions of Service

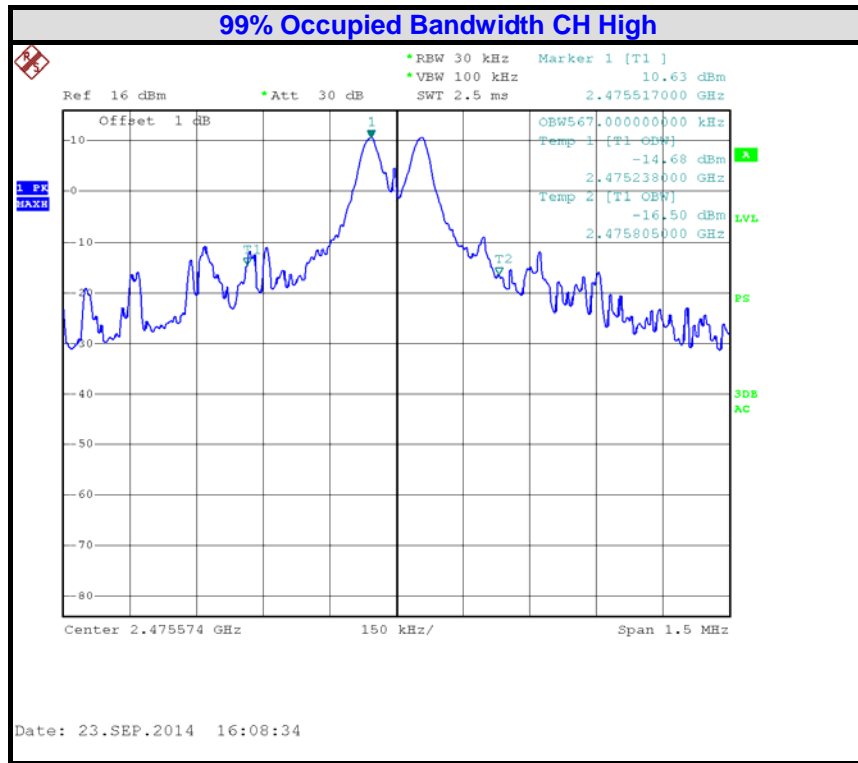

Copyright of this report is owned by Centre of Testing Service and may not be reproduced other than in full except with the written approval of the issuing Company.

CENTRE OF TESTING SERVICE CO., LTD.

A101, No.65, Zhuji Highway, Tianhe District, Guangzhou, China

Tel: +86-20-85543113 (32 lines)

Fax: +86-20-38780406

Complaint line: +86-20-85533471

E-mail: cts@cts-lab.com.cn

See Reverse For Terms And Conditions of Service

17.0 RECEIVER SUPRIIOUS EMISSION

17.1 LIMIT

According to RSS-Gen Issue 3:4.10.Except as provided elsewhere in this Subpart, the emissions from an intentional radiator shall not exceed the field strength levels specified in the following table:

FREQUENCY MHz	DISTANCE Meters	FIELD STRENGTHS LIMIT	
		$\mu\text{V}/\text{m}$	$\text{dB}(\mu\text{V})/\text{m}$
30 ~ 88	3	100	40.0
88 ~ 216	3	150	43.5
216 ~ 960	3	200	46.0
960 ~ 1000	3	500	54.0
Above 1000	3	Other:74.0 $\text{dB}(\mu\text{V})/\text{m}$ (Peak) 54.0 $\text{dB}(\mu\text{V})/\text{m}$ (Average)	

17.2 TEST EQUIPMENT

Radiated disturbance (electric field)					
Item	Test Equipment	Manufacturer	Model No.	Serial No.	Last Cal.
1	EMI Test Receiver	ROHDE & SCHWARZ	ESCI	100868	2013/11
2	Biconical Antenna	ROHDE & SCHWARZ	HK116	100221	2014/03
3	Log per Antenna	ROHDE & SCHWARZ	HL223	100226	2014/03
4	Log per Antenna	ROHDE & SCHWARZ	HL050	100186	2014/03
5	Signal analyzer	ROHDE & SCHWARZ	FSIQ26	100311	2014/03
6	Loop Antenna	A.R.A	PLA-1030/B	1030	2013/11
7	EMI Test Software	EZ-EMC	Farad	N/A	N/A

Copyright of this report is owned by Centre of Testing Service and may not be reproduced other than in full except with the written approval of the issuing Company.

CENTRE OF TESTING SERVICE CO., LTD.

A101, No.65, Zhuji Highway, Tianhe District, Guangzhou, China

Tel: +86-20-85543113 (32 lines)

Fax: +86-20-38780406

Complaint line: +86-20-85533471

E-mail: cts@cts-lab.com.cn

See Reverse For Terms And Conditions of Service

17.3 TEST CONFIGURATION

Below 1 GHz

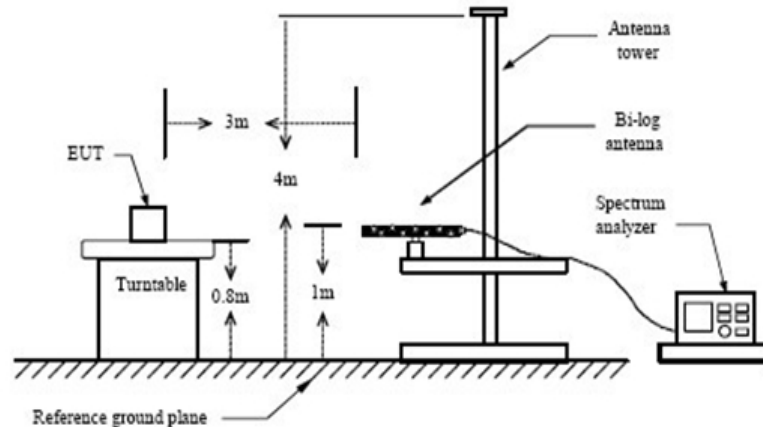

Above 1 GHz

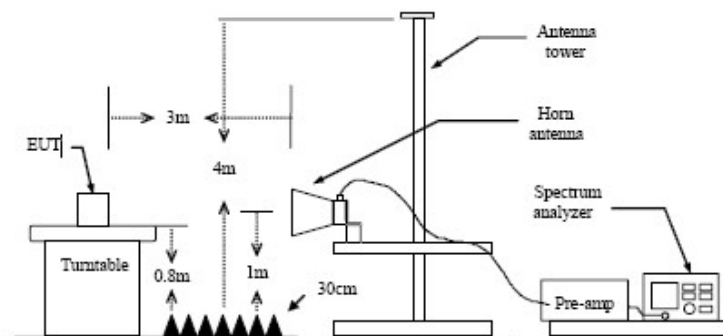

17.4 TEST PROCEDURE

1. The EUT is placed on a turntable, which is 0.8m above ground plane.
2. The turntable shall be rotated for 360 degrees to determine the position of maximum emission level.
3. EUT is set 3m away from the receiving antenna, which is varied from 1m to 4m to find out the highest emissions.
4. Maximum procedure was performed on the six highest emissions to ensure EUT compliance.
5. And also, each emission was to be maximized by changing the polarization of receiving antenna both horizontal and vertical.
6. Repeat above procedures until the measurements for all frequencies are complete.

17.5 TEST RESULTS

The EUT Only Transmitter, Not applicable.

Copyright of this report is owned by Centre of Testing Service and may not be reproduced other than in full except with the written approval of the issuing Company.

CENTRE OF TESTING SERVICE CO., LTD.

A101, No.65, Zhuji Highway, Tianhe District, Guangzhou, China

Tel: +86-20-85543113 (32 lines)

Fax: +86-20-38780406

Complaint line: +86-20-85533471

E-mail: cts@cts-lab.com.cn

See Reverse For Terms And Conditions of Service



18.0 DEVIATION TO TEST SPECIFICATIONS

The following identical model(s):

PRB13002

Belong to the tested device:

Product description: **ECX/PRB 2.4GHz Transmitter, 2-Channel V3**
Model name: **ECX13002**

Copyright of this report is owned by Centre of Testing Service and may not be reproduced other than in full except with the written approval of the issuing Company.

CENTRE OF TESTING SERVICE CO., LTD.

A101, No.65, Zhuji Highway, Tianhe District, Guangzhou, China

Tel: +86-20-85543113 (32 lines)

Fax: +86-20-38780406

Complaint line: +86-20-85533471

E-mail: cts@cts-lab.com.cn

See Reverse For Terms And Conditions of Service