

**Electromagnetic Emissions Test Report
and
Application for Grant of Equipment Authorization
pursuant to
Industry Canada RSS-Gen Issue 1 / RSS 210 Issue 6
FCC Part 15 Subpart C
on the
Horizon Hobby, Inc.
Transmitter
Model: X10EMTX**

UPN: 6157A-BRWDXMT
FCC ID: BRWDXMTX10

GRANTEE: Horizon Hobby, Inc.
4105 Fieldstone Road
Champaign, IL 61822

TEST SITE: Elliott Laboratories, Inc.
684 W. Maude Ave
Sunnyvale, CA 94086

REPORT DATE: September 11, 2006

FINAL TEST DATE: September 8, 2006

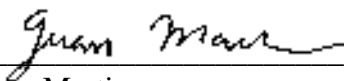
AUTHORIZED SIGNATORY: 
Juan Martinez
Senior EMC Engineer



2016-01

Elliott Laboratories, Inc. is accredited by the A2LA, certificate number 2016-01, to perform the test(s) listed in this report. This report shall not be reproduced, except in its entirety, without the written approval of Elliott Laboratories, Inc.

REVISION HISTORY

Revision #	Date	Comments	Modified By
1	September 19, 2006	Initial Release	David Guidotti

TABLE OF CONTENTS

COVER PAGE.....1

REVISION HISTORY2

TABLE OF CONTENTS3

SCOPE.....5

OBJECTIVE6

STATEMENT OF COMPLIANCE7

TEST RESULTS SUMMARY.....8

 DIGITAL TRANSMISSION SYSTEMS (2400 – 2483.5MHZ).....8

 GENERAL REQUIREMENTS APPLICABLE TO ALL BANDS9

MEASUREMENT UNCERTAINTIES9

EQUIPMENT UNDER TEST (EUT) DETAILS10

 GENERAL.....10

 ANTENNA SYSTEM10

 ENCLOSURE.....10

 MODIFICATIONS10

 SUPPORT EQUIPMENT.....10

 EUT INTERFACE PORTS10

 EUT OPERATION10

TEST SITE.....11

 GENERAL INFORMATION11

 CONDUCTED EMISSIONS CONSIDERATIONS.....11

 RADIATED EMISSIONS CONSIDERATIONS.....11

MEASUREMENT INSTRUMENTATION12

 RECEIVER SYSTEM12

 INSTRUMENT CONTROL COMPUTER12

 LINE IMPEDANCE STABILIZATION NETWORK (LISN).....12

 FILTERS/ATTENUATORS.....13

 ANTENNAS.....13

 ANTENNA MAST AND EQUIPMENT TURNTABLE.....13

 INSTRUMENT CALIBRATION.....13

TABLE OF CONTENTS (Continued)

TEST PROCEDURES.....14

EUT AND CABLE PLACEMENT 14

CONDUCTED EMISSIONS 14

RADIATED EMISSIONS 14

RADIATED EMISSIONS 15

BANDWIDTH MEASUREMENTS 16

SPECIFICATION LIMITS AND SAMPLE CALCULATIONS 17

GENERAL TRANSMITTER RADIATED EMISSIONS SPECIFICATION LIMITS 18

RECEIVER RADIATED SPURIOUS EMISSIONS SPECIFICATION LIMITS 18

OUTPUT POWER LIMITS – DIGITAL TRANSMISSION SYSTEMS 19

TRANSMIT MODE SPURIOUS RADIATED EMISSIONS LIMITS – FHSS AND DTS SYSTEMS 19

SAMPLE CALCULATIONS - CONDUCTED EMISSIONS 20

SAMPLE CALCULATIONS - RADIATED EMISSIONS 20

SAMPLE CALCULATIONS - FIELD STRENGTH TO EIRP CONVERSION 21

EXHIBIT 1: Test Equipment Calibration Data..... 1

EXHIBIT 2: Test Measurement Data..... 2

EXHIBIT 3: Photographs of Test Configurations..... 3

EXHIBIT 4: Proposed FCC ID Label & Label Location..... 4

EXHIBIT 5: Detailed Photographs..... 5

EXHIBIT 6: Operator's Manual..... 6

EXHIBIT 7: Block Diagram..... 7

EXHIBIT 8: Schematic Diagrams..... 8

EXHIBIT 9: Theory of Operation 9

EXHIBIT 10: Modular Approval Requirements..... 10

EXHIBIT 11: RF Exposure Information 11

SCOPE

An electromagnetic emissions test has been performed on the Horizon Hobby, Inc model X1OEMTX pursuant to the following rules:

Industry Canada RSS-Gen Issue 1
RSS 210 Issue 6 "Low-power Licence-exempt Radiocommunication Devices (All Frequency Bands): Category I Equipment"
FCC Part 15 Subpart C

Conducted and radiated emissions data has been collected, reduced, and analyzed within this report in accordance with measurement guidelines set forth in the following reference standards and as outlined in Elliott Laboratories test procedures:

ANSI C63.4:2003
RSS-212 Issue 1 Test Facilities and Test Methods for Radio Equipment

The intentional radiator above has been tested in a simulated typical installation to demonstrate compliance with the relevant Industry Canada performance and procedural standards.

Final system data was gathered in a mode that tended to maximize emissions by varying orientation of EUT, orientation of power and I/O cabling, antenna search height, and antenna polarization.

Every practical effort was made to perform an impartial test using appropriate test equipment of known calibration. All pertinent factors have been applied to reach the determination of compliance.

The test results recorded herein are based on a single type test of the Horizon Hobby, Inc model X1OEMTX and therefore apply only to the tested sample. The sample was selected and prepared by Paul Beard of Horizon Hobby, Inc.

OBJECTIVE

The primary objective of the manufacturer is compliance with the regulations outlined in the previous section.

Prior to marketing in the USA, all unlicensed transmitters and transceivers require certification. Receive-only devices operating between 30 MHz and 960 MHz are subject to either certification or a manufacturer's declaration of conformity, with all other receive-only devices exempt from the technical requirements.

Prior to marketing in Canada, Class I transmitters, receivers and transceivers require certification. Class II devices are required to meet the appropriate technical requirements but are exempt from certification requirements.

Certification is a procedure where the manufacturer submits test data and technical information to a certification body and receives a certificate or grant of equipment authorization upon successful completion of the certification body's review of the submitted documents. Once the equipment authorization has been obtained, the label indicating compliance must be attached to all identical units, which are subsequently manufactured.

Maintenance of compliance is the responsibility of the manufacturer. Any modification of the product which may result in increased emissions should be checked to ensure compliance has been maintained (i.e., printed circuit board layout changes, different line filter, different power supply, harnessing or I/O cable changes, etc.).

STATEMENT OF COMPLIANCE

The tested sample of Horizon Hobby, Inc model X1OEMTX complied with the requirements of the following regulations:

Industry Canada RSS-Gen Issue 1
RSS 210 Issue 6 "Low-power Licence-exempt Radiocommunication Devices (All Frequency Bands): Category I Equipment"
FCC Part 15 Subpart C

Maintenance of compliance is the responsibility of the manufacturer. Any modification of the product which may result in increased emissions should be checked to ensure compliance has been maintained (i.e., printed circuit board layout changes, different line filter, different power supply, harnessing or I/O cable changes, etc.).

TEST RESULTS SUMMARY**DIGITAL TRANSMISSION SYSTEMS (2400 – 2483.5MHz)**

FCC Rule Part	RSS Rule Part	Description	Measured Value / Comments	Limit / Requirement	Result
15.247(a)	RSS 210 A8.2	Digital Modulation	Systems uses DSSS techniques	-	Complies
15.247 (a) (2)	RSS 210 A8.2 (1)	6dB Bandwidth	833kHz	>500kHz	Complies
	RSP100	99% Bandwidth	1.131MHz	Information only	Complies
15.247 (b) (3)	RSS 210 A8.2 (4)	Output Power (multipoint systems)	2.5 dBm (.003 Watts) EIRP = 0.0 W ^{Note 1}	1Watt, EIRP limited to 4 Watts.	Complies
15.247(d)	RSS 210 A8.2 (2)	Power Spectral Density	1.13 dBm/3kHz	8dBm/3kHz	Complies
15.247(c)	RSS 210 A8.5	Antenna Port Spurious Emissions 30MHz – 25 GHz	Refer to plots included in data sheets	< -20dBc	Complies
15.247(c) / 15.209	RSS 210 A8.5	Radiated Spurious Emissions 30MHz – 25 GHz	52.6dB μ V/m @ 7427.3MHz (-1.4dB)	15.207 in restricted bands, all others < -20dBc	Complies

Note 1: EIRP calculated using antenna gain of 2dBi for the highest EIRP multi-point system.

GENERAL REQUIREMENTS APPLICABLE TO ALL BANDS

FCC Rule Part	RSS Rule part	Description	Measured Value / Comments	Limit / Requirement	Result (margin)
15.203	-	RF Connector	The module connects to its antenna via a micro-coax connector). This connector must be internally connected to the antenna without the possibility of user access.		Complies
15.109	RSS GEN 7.2.3 Table 1	Receiver spurious emissions	61.0 μ V/m @ 2433.6MHz		Complies (-18.3 dB)
15.207	RSS GEN Table 2	AC Conducted Emissions	52.7dB μ V @ 0.206MHz (-10.7dB)	Refer to standard	Complies (-10.7 dB)
15.247 (b) (5) 15.407 (f)	RSS 102	RF Exposure Requirements	Refer to SAR Exclusion RSS 102 declaration and User Manual statements.	Refer to OET 65, FCC Part 1 and RSS 102	Complies
	RSP 100 RSS GEN 7.1.5	User Manual		Statement required regarding non-interference	
	RSP 100 RSS GEN 7.1.5	User Manual		Statement required regarding detachable antenna	

MEASUREMENT UNCERTAINTIES

ISO Guide 17025 requires that an estimate of the measurement uncertainties associated with the emissions test results be included in the report. The measurement uncertainties given below are based on a 95% confidence level and were calculated in accordance with UKAS document LAB 34.

Measurement Type	Frequency Range (MHz)	Calculated Uncertainty (dB)
Conducted Emissions	0.15 to 30	± 2.4
Radiated Emissions	0.015 to 30	± 3.0
Radiated Emissions	30 to 1000	± 3.6
Radiated Emissions	1000 to 40000	± 6.0

EQUIPMENT UNDER TEST (EUT) DETAILS**GENERAL**

The Horizon Hobby, Inc model X1OEMTX is a 2.4GHz DSSS transceiver module, which is designed for model control and telemetry. The EUT was mounted into a test fixture and the fixture was treated as tabletop equipment during testing. The electrical rating of the module is 2.7 - 3.6V DC 20mA.

The sample was received on September 8, 2006 and tested on September 8, 2006. The EUT consisted of the following component(s):

Manufacturer	Model	Description	Serial Number	FCC ID
Horizon Hobby	X1OEMTX	2.4GHz DSSS Transceiver Module	PFB101005	BRWDAMTX10

ANTENNA SYSTEM

The EUT antenna is a 2dBi Folded dipole.

The antenna connects to the EUT via a non-standard micro-coax, thereby meeting the requirements of FCC 15.203.

ENCLOSURE

The EUT does not have an enclosure as it is designed to be installed within the enclosure of a host device.

MODIFICATIONS

The EUT did not require modifications during testing in order to comply with emissions specifications.

SUPPORT EQUIPMENT

No support equipment was used during emissions testing.

EUT INTERFACE PORTS

The I/O cabling configuration during emissions testing was as follows:

Port	Connected To	Cable(s)		
		Description	Shielded or Unshielded	Length(m)
None	-	-	-	-

EUT OPERATION

The X1TXM module was configured to continuously transmit on a single channel (top, center or bottom) for transmit-mode tests. For receive mode tests the device was configured to continuously receive on the center channel.

TEST SITE

GENERAL INFORMATION

Final test measurements were taken on September 8, 2006 at the Elliott Laboratories Open Area Test Site #2 located at 684 West Maude Avenue, Sunnyvale, California. Pursuant to section 2.948 of the FCC's Rules and section 3.3 of RSP-100, construction, calibration, and equipment data has been filed with the Commission.

ANSI C63.4:2003 recommends that ambient noise at the test site be at least 6 dB below the allowable limits. Ambient levels are below this requirement with the exception of predictable local TV, radio, and mobile communications traffic. The test site contains separate areas for radiated and conducted emissions testing. Considerable engineering effort has been expended to ensure that the facilities conform to all pertinent requirements of ANSI C63.4:2003 and RSS 212.

CONDUCTED EMISSIONS CONSIDERATIONS

Conducted emissions testing is performed in conformance with ANSI C63.4:2003 and RSS 212. Measurements are made with the EUT connected to the public power network through a nominal, standardized RF impedance, which is provided by a line impedance stabilization network, known as a LISN. A LISN is inserted in series with each current-carrying conductor in the EUT power cord.

RADIATED EMISSIONS CONSIDERATIONS

The FCC has determined that radiation measurements made in a shielded enclosure are not suitable for determining levels of radiated emissions. Radiated measurements are performed in an open field environment or in a semi-anechoic chamber. The test sites are maintained free of conductive objects within the CISPR defined elliptical area incorporated in ANSI C63.4:2003 guidelines and meet the Normalized Site Attenuation (NSA) requirements of ANSI C63.4:2003 / RSS 212.

MEASUREMENT INSTRUMENTATION**RECEIVER SYSTEM**

An EMI receiver as specified in CISPR 16-1 is used for emissions measurements. The receivers used can measure over the frequency range of 9 kHz up to 2000 MHz. These receivers allow both ease of measurement and high accuracy to be achieved. The receivers have Peak, Average, and CISPR (Quasi-peak) detectors built into their design so no external adapters are necessary. The receiver automatically sets the required bandwidth for the CISPR detector used during measurements. If the repetition frequency of the signal being measured is below 20Hz, peak measurements are made in lieu of Quasi-Peak measurements.

For measurements above the frequency range of the receivers, a spectrum analyzer is utilized because it provides visibility of the entire spectrum along with the precision and versatility required to support engineering analysis. Average measurements above 1000MHz are performed on the spectrum analyzer using the linear-average method with a resolution bandwidth of 1 MHz and a video bandwidth of 10 Hz, unless the signal is pulsed in which case the average (or video) bandwidth of the measuring instrument is reduced to onset of pulse desensitization and then increased.

INSTRUMENT CONTROL COMPUTER

The receivers utilize either a Rohde & Schwarz EZM Spectrum Monitor/Controller or contain an internal Spectrum Monitor/Controller to view and convert the receiver measurements to the field strength at an antenna or voltage developed at the LISN measurement port, which is then compared directly with the appropriate specification limit. This provides faster, more accurate readings by performing the conversions described under Sample Calculations within the Test Procedures section of this report. Results are printed in a graphic and/or tabular format, as appropriate. A personal computer is used to record all measurements made with the receivers.

The Spectrum Monitor provides a visual display of the signal being measured. In addition, the controller or a personal computer run automated data collection programs which control the receivers. This provides added accuracy since all site correction factors, such as cable loss and antenna factors are added automatically.

LINE IMPEDANCE STABILIZATION NETWORK (LISN)

Line conducted measurements utilize a fifty microhenry Line Impedance Stabilization Network as the monitoring point. The LISN used also contains a 250 uH CISPR adapter. This network provides for calibrated radio frequency noise measurements by the design of the internal low pass and high pass filters on the EUT and measurement ports, respectively.

FILTERS/ATTENUATORS

External filters and precision attenuators are often connected between the receiving antenna or LISN and the receiver. This eliminates saturation effects and non-linear operation due to high amplitude transient events.

ANTENNAS

A loop antenna is used below 30 MHz. For the measurement range 30 MHz to 1000 MHz either a combination of a biconical antenna and a log periodic or a bi-log antenna is used. Above 1000 MHz, horn antennas are used. The antenna calibration factors to convert the received voltage to an electric field strength are included with appropriate cable loss and amplifier gain factors to determine an overall site factor, which is then programmed into the test receivers or incorporated into the test software.

ANTENNA MAST AND EQUIPMENT TURNTABLE

The antennas used to measure the radiated electric field strength are mounted on a non-conductive antenna mast equipped with a motor-drive to vary the antenna height. Measurements below 30 MHz are made with the loop antenna at a fixed height of 1m above the ground plane.

ANSI C63.4:2003 and RSS 212 specify that the test height above ground for table mounted devices shall be 80 centimeters. Floor mounted equipment shall be placed on the ground plane if the device is normally used on a conductive floor or separated from the ground plane by insulating material from 3 to 12 mm if the device is normally used on a non-conductive floor. During radiated measurements, the EUT is positioned on a motorized turntable in conformance with this requirement.

INSTRUMENT CALIBRATION

All test equipment is regularly checked to ensure that performance is maintained in accordance with the manufacturer's specifications. All antennas are calibrated at regular intervals with respect to tuned half-wave dipoles. An exhibit of this report contains the list of test equipment used and calibration information.

TEST PROCEDURES

EUT AND CABLE PLACEMENT

The regulations require that interconnecting cables be connected to the available ports of the unit and that the placement of the unit and the attached cables simulate the worst case orientation that can be expected from a typical installation, so far as practicable. To this end, the position of the unit and associated cabling is varied within the guidelines of ANSI C63.4:2003, and the worst-case orientation is used for final measurements.

CONDUCTED EMISSIONS

Conducted emissions are measured at the plug end of the power cord supplied with the EUT. Excess power cord length is wrapped in a bundle between 30 and 40 centimeters in length near the center of the cord. Preliminary measurements are made to determine the highest amplitude emission relative to the specification limit for all the modes of operation. Placement of system components and varying of cable positions are performed in each mode. A final peak mode scan is then performed in the position and mode for which the highest emission was noted on all current carrying conductors of the power cord.

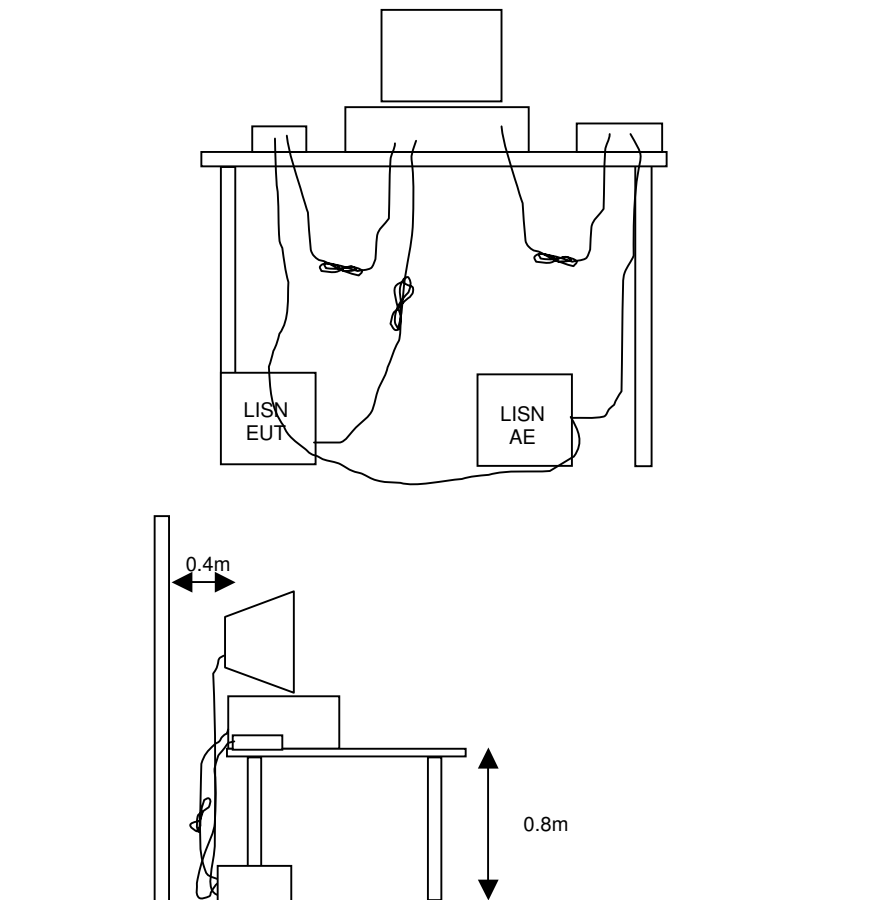

RADIATED EMISSIONS

A preliminary scan of the radiated emissions is performed in which all significant EUT frequencies are identified with the system in a nominal configuration. At least two scans are performed, one scan for each antenna polarization (horizontal and vertical; loop parallel and perpendicular to the EUT). During the preliminary scans, the EUT is rotated through 360°, the antenna height is varied (for measurements above 30 MHz) and cable positions are varied to determine the highest emission relative to the limit. Preliminary scans may be performed in a fully anechoic chamber for the purposes of identifying the frequencies of the highest emissions from the EUT.

A speaker is provided in the receiver to aid in discriminating between EUT and ambient emissions. Other methods used during the preliminary scan for EUT emissions involve scanning with near field magnetic loops, monitoring I/O cables with RF current clamps, and cycling power to the EUT.

Final maximization is a phase in which the highest amplitude emissions identified in the spectral search are viewed while the EUT azimuth angle is varied from 0 to 360 degrees relative to the receiving antenna. The azimuth, which results in the highest emission is then maintained while varying the antenna height from one to four meters (for measurements above 30 MHz, measurements below 30 MHz are made with the loop antenna at a fixed height of 1m). The result is the identification of the highest amplitude for each of the highest peaks. Each recorded level is corrected in the receiver using appropriate factors for cables, connectors, antennas, and preamplifier gain.

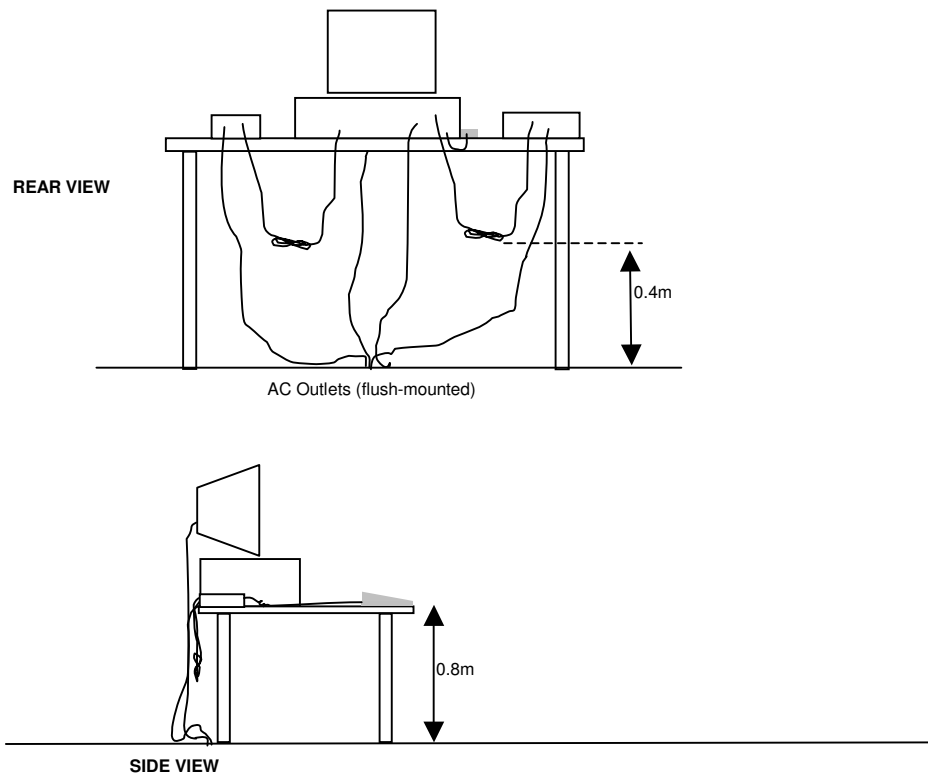

Typical Test Configuration for Radiated Field Strength Measurements

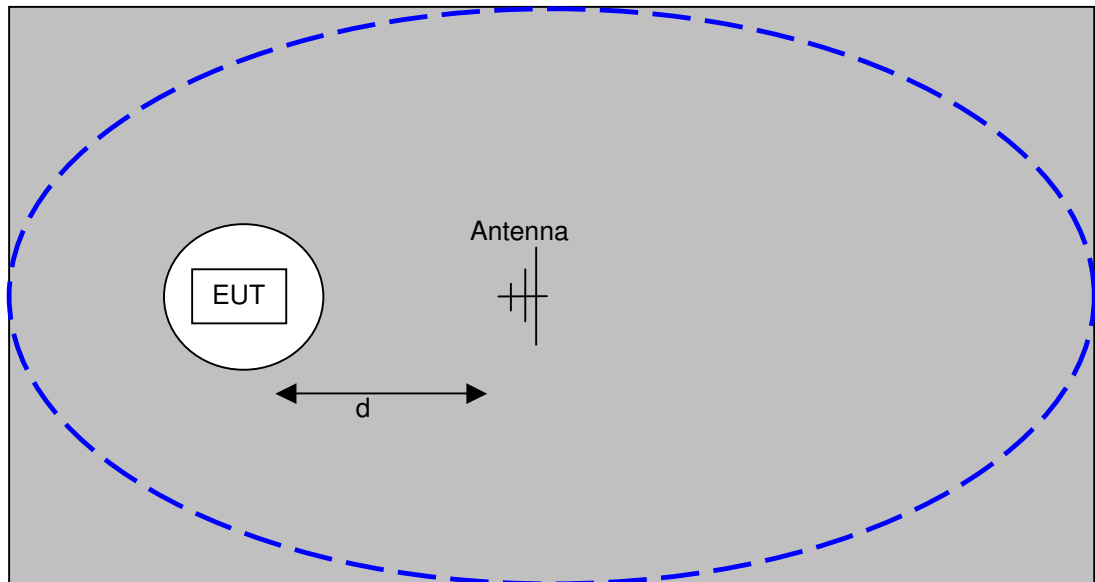

The ground plane extends beyond the ellipse defined in CISPR 16 / CISPR 22 / ANSI C63.4 and is large enough to accommodate test distances (d) of 3m and 10m. Refer to the test data tables for the actual measurement distance.

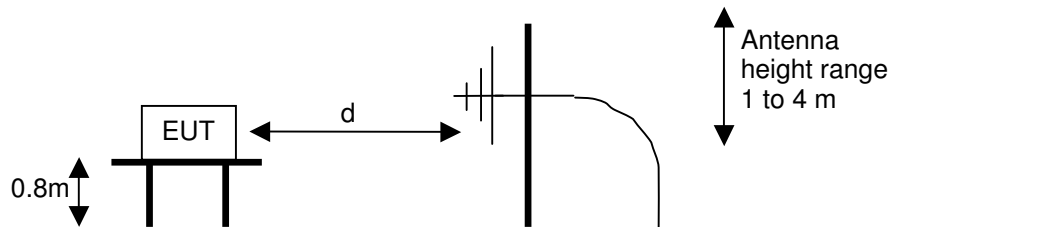

Test Configuration for Radiated Field Strength Measurements
OATS- Plan and Side Views

BANDWIDTH MEASUREMENTS

The 6dB, 20dB and/or 26dB signal bandwidth is measured in using the bandwidths recommended by ANSI C63.4. When required, the 99% bandwidth is measured using the methods detailed in RSS GEN.

SPECIFICATION LIMITS AND SAMPLE CALCULATIONS

The limits for conducted emissions are given in units of microvolts, and the limits for radiated emissions are given in units of microvolts per meter at a specified test distance. Data is measured in the logarithmic form of decibels relative to one microvolt, or dB microvolts (dBuV). For radiated emissions, the measured data is converted to the field strength at the antenna in dB microvolts per meter (dBuV/m). The results are then converted to the linear forms of uV and uV/m for comparison to published specifications.

For reference, converting the specification limits from linear to decibel form is accomplished by taking the base ten logarithm, then multiplying by 20. These limits in both linear and logarithmic form are as follows:

GENERAL TRANSMITTER RADIATED EMISSIONS SPECIFICATION LIMITS

The table below shows the limits for the spurious emissions from transmitters that fall in restricted bands¹ (with the exception of transmitters operating under FCC Part 15 Subpart D and RSS 210 Annex 9), the limits for all emissions from a low power device operating under the general rules of RSS 310 (tables 3 and 4), RSS 210 (table 2) and FCC Part 15 Subpart C section 15.209.

Frequency Range (MHz)	Limit (uV/m)	Limit (dBuV/m @ 3m)
0.009-0.490	2400/F _{KHz} @ 300m	67.6-20*log ₁₀ (F _{KHz}) @ 300m
0.490-1.705	24000/F _{KHz} @ 30m	87.6-20*log ₁₀ (F _{KHz}) @ 30m
1.705 to 30	30 @ 30m	29.5 @ 30m
30 to 88	100 @ 3m	40 @ 3m
88 to 216	150 @ 3m	43.5 @ 3m
216 to 960	200 @ 3m	46.0 @ 3m
Above 960	500 @ 3m	54.0 @ 3m

RECEIVER RADIATED SPURIOUS EMISSIONS SPECIFICATION LIMITS

The table below shows the limits for the spurious emissions from receivers as detailed in FCC Part 15.109, RSS 210 Table 2, RSS GEN Table 1 and RSS 310 Table 3. Note that receivers operating outside of the frequency range 30 MHz – 960 MHz are exempt from the requirements of 15.109.

Frequency Range (MHz)	Limit (uV/m @ 3m)	Limit (dBuV/m @ 3m)
30 to 88	100	40
88 to 216	150	43.5
216 to 960	200	46.0
Above 960	500	54.0

¹ The restricted bands are detailed in FCC 15.203, RSS 210 Table 1 and RSS 310 Table 2

OUTPUT POWER LIMITS – DIGITAL TRANSMISSION SYSTEMS

The table below shows the limits for output power and output power density. Where the signal bandwidth is less than 20 MHz the maximum output power is reduced to the power spectral density limit plus 10 times the log of the bandwidth (in MHz).

Operating Frequency (MHz)	Output Power	Power Spectral Density
902 – 928	1 Watt (30 dBm)	8 dBm/3kHz
2400 – 2483.5	1 Watt (30 dBm)	8 dBm/3kHz
5725 – 5850	1 Watt (30 dBm)	8 dBm/3kHz

The maximum permitted output power is reduced by 1dB for every dB the antenna gain exceeds 6dBi. Fixed point-to-point applications using the 5725 – 5850 MHz band are not subject to this restriction.

TRANSMIT MODE SPURIOUS RADIATED EMISSIONS LIMITS – FHSS and DTS SYSTEMS

The limits for unwanted (spurious) emissions from the transmitter falling in the restricted bands are those specified in the general limits sections of FCC Part 15 and RSS 210. All other unwanted (spurious) emissions shall be at least 20dB below the level of the highest in-band signal level (30dB if the power is measured using the sample detector/power averaging method).

SAMPLE CALCULATIONS - CONDUCTED EMISSIONS

Receiver readings are compared directly to the conducted emissions specification limit (decibel form) as follows:

$$R_r - S = M$$

where:

R_r = Receiver Reading in dBuV

S = Specification Limit in dBuV

M = Margin to Specification in +/- dB

SAMPLE CALCULATIONS - RADIATED EMISSIONS

Receiver readings are compared directly to the specification limit (decibel form). The receiver internally corrects for cable loss, preamplifier gain, and antenna factor. The calculations are in the reverse direction of the actual signal flow, thus cable loss is added and the amplifier gain is subtracted. The Antenna Factor converts the voltage at the antenna coaxial connector to the field strength at the antenna elements.

A distance factor, when used for electric field measurements above 30MHz, is calculated by using the following formula:

$$F_d = 20 * \text{LOG}_{10} (D_m/D_s)$$

where:

F_d = Distance Factor in dB

D_m = Measurement Distance in meters

D_s = Specification Distance in meters

For electric field measurements below 30MHz the extrapolation factor is either determined by making measurements at multiple distances or a theoretical value is calculated using the formula:

$$F_d = 40 * \text{LOG}_{10} (D_m/D_s)$$

Measurement Distance is the distance at which the measurements were taken and Specification Distance is the distance at which the specification limits are based. The antenna factor converts the voltage at the antenna coaxial connector to the field strength at the antenna elements.

The margin of a given emission peak relative to the limit is calculated as follows:

$$R_c = R_r + F_d$$

and

$$M = R_c - L_s$$

where:

$$R_r = \text{Receiver Reading in dBuV/m}$$

$$F_d = \text{Distance Factor in dB}$$

$$R_c = \text{Corrected Reading in dBuV/m}$$

$$L_s = \text{Specification Limit in dBuV/m}$$

$$M = \text{Margin in dB Relative to Spec}$$

SAMPLE CALCULATIONS - FIELD STRENGTH TO EIRP CONVERSION

Where the radiated electric field strength is expressed in terms of the equivalent isotropic radiated power (eirp), or where a field strength measurement of output power is made in lieu of a direct measurement, the following formula is used to convert between eirp and field strength at a distance of 3m from the equipment under test:

$$E = \frac{1000000 \sqrt{30 P}}{3} \quad \text{microvolts per meter}$$

where P is the eirp (Watts)

EXHIBIT 1: Test Equipment Calibration Data

1 Page

Radiated Emissions, 30 - 26,000 MHz, 08-Sep-06**Engineer: Mehran Birgani**

<u>Manufacturer</u>	<u>Description</u>	<u>Model #</u>	<u>Asset #</u>	<u>Cal Due</u>
EMCO	Antenna, Horn, 1-18 GHz (SA40, 30 Hz)	3115	1142	07-Jun-07
Hewlett Packard	Test Sys (SA40, 30Hz - 40GHz), SV	84125C	1149	12-Sep-06
Hewlett Packard	High Pass filter, 1.5 GHz	P/N 84300-80037 (84125C)	1154	09-Jun-07
Hewlett Packard	High Pass filter, 3.5 GHz	P/N 84300-80038	1157	24-Apr-07
Hewlett Packard	Microwave Preamplifier 0.5-26.5 GHz	83017A	1257	28-Sep-06

Radiated Emissions, 30 - 26,000 MHz, 12-Sep-06**Engineer: Mehran Birgani**

<u>Manufacturer</u>	<u>Description</u>	<u>Model #</u>	<u>Asset #</u>	<u>Cal Due</u>
Hewlett Packard	Microwave Preamplifier, 1-26.5GHz	8449B	870	13-Jan-07
Hewlett Packard	High Pass filter, 3.5 GHz	P/N 84300-80038	1157	24-Apr-07
Hewlett Packard	SpecAn 9 kHz - 40 GHz, FMT (SA40) Blue	8564E (84125C)	1393	10-Nov-06
EMCO	Antenna, Horn, 1-18 GHz (SA40 9kHz)	3115	1779	07-Feb-07

Conducted Emissions - AC Power Ports, 12-Sep-06**Engineer: Mehran Birgani**

<u>Manufacturer</u>	<u>Description</u>	<u>Model #</u>	<u>Asset #</u>	<u>Cal Due</u>
Rohde & Schwarz	Test Receiver, 0.009-30 MHz	ESH3	274	28-Feb-07
Elliott Laboratories	LISN, FCC / CISPR	LISN-4, OATS	362	30-Jun-07
Rohde & Schwarz	Pulse Limiter	ESH3 Z2	372	28-Aug-07

EXHIBIT 2: Test Measurement Data

22 Pages



EMC Test Data

Client:	Horizon Hobby, Inc.	Job Number:	J65217
Model:	X1OEMTX	Test-Log Number:	T65287
		Project Manager:	Ezther Zhu
Contact:	Paul Beard		
Emissions Spec:	EN 300 440 V1.3.1/FCC 15.247	Class:	B
Immunity Spec:	-	Environment:	-

EMC Test Data

For The

Horizon Hobby, Inc.

Model

X1OEMTX

Date of Last Test: 9/12/2006



EMC Test Data

Client:	Horizon Hobby, Inc.	Job Number:	J65217
Model:	X1OEMTX	Test-Log Number:	T65287
		Project Manager:	Ezther Zhu
Contact:	Paul Beard		
Emissions Spec:	EN 300 440 V1.3.1/FCC 15.247	Class:	B
Immunity Spec:	-	Environment:	-

EUT INFORMATION

General Description

The EUT is a 2.4GHz DSSS transceiver module which is designed for model control and telemetry. The EUT was mounted into a test fixture and the fixture was treated as table-top equipment during testing. The electrical rating of the module is 2.7 - 3.6V DC 20mA.

Equipment Under Test

Manufacturer	Model	Description	Serial Number	FCC ID
Horizon Hobby	X1OEMTX	2.4GHz DSSS	PFB101005	BRWDAMTX10

EUT Antenna (Intentional Radiators Only)

The EUT antenna is a 2dBi Folded dipole.

The antenna connects to the EUT via a non-standard micro-coax, thereby meeting the requirements of FCC 15.203.

EUT Enclosure

The EUT does not have an enclosure as it is designed to be installed within the enclosure of a host device.



EMC Test Data

Client:	Horizon Hobby, Inc.	Job Number:	J65217
Model:	X1OEMTX	T-Log Number:	T65287
Contact:	Paul Beard	Project Manager:	Ezther Zhu
Emissions Spec:	EN 300 440 V1.3.1/FCC 15.247	Class:	B
Immunity Spec:	-	Environment:	-

Test Configuration #1

Local Support Equipment

Manufacturer	Model	Description	Serial Number	FCC ID
None				

Remote Support Equipment

Manufacturer	Model	Description	Serial Number	FCC ID
None				

Interface Cabling and Ports

Port	Connected To	Cable(s)		
		Description	Shielded or Unshielded	Length(m)
None				

EUT Operation During Emissions Tests

The X1TXM module was configured to continuously transmit on a single channel (top, center or bottom) for transmit-mode tests. For receive mode tests the device was configured to continuously receive on the center channel.



EMC Test Data

Client:	Horizon Hobby, Inc.	Job Number:	J65217
Model:	X1OEMTX	T-Log Number:	T65287
Contact:	Paul Beard	Account Manager:	Ezther Zhu
Standard:	EN 300 440 V1.3.1/FCC 15.247	Class:	B

Conducted Emissions - Power Ports

Test Specific Details

Objective: The objective of this test session is to perform final qualification testing of the EUT with respect to the specification listed above.

Date of Test: 9/12/2006 19:46
Test Engineer: Mehran Birgani
Test Location: SVOATS #2

Config. Used: 1
Config Change: Using DC Power Source
EUT Voltage: Battery

General Test Configuration

The EUT was located on a wooden table, 40 cm from a vertical coupling plane and 80cm from the LISN.

Ambient Conditions: Temperature: 21 °C
Rel. Humidity: 64 %

Summary of Results

Run #	Test Performed	Limit	Result	Margin
1	CE, AC Power, 120V/60Hz	FCC 15.207	Pass	52.7dB μ V @ 0.206MHz (-10.7dB)

Modifications Made During Testing:

No modifications were made to the EUT during testing

Deviations From The Standard

No deviations were made from the requirements of the standard.

Client: Horizon Hobby, Inc.	Job Number: J65217
Model: X10EMTX	T-Log Number: T65287
Contact: Paul Beard	Account Manager: Ezther Zhu
Standard: EN 300 440 V1.3.1/FCC 15.247	Class: B

Run #1: AC Power Port Conducted Emissions, 0.15 - 30MHz, 120V/60Hz

DC Power Port Conducted Emissions, 0.15 - 30MHz (Line)

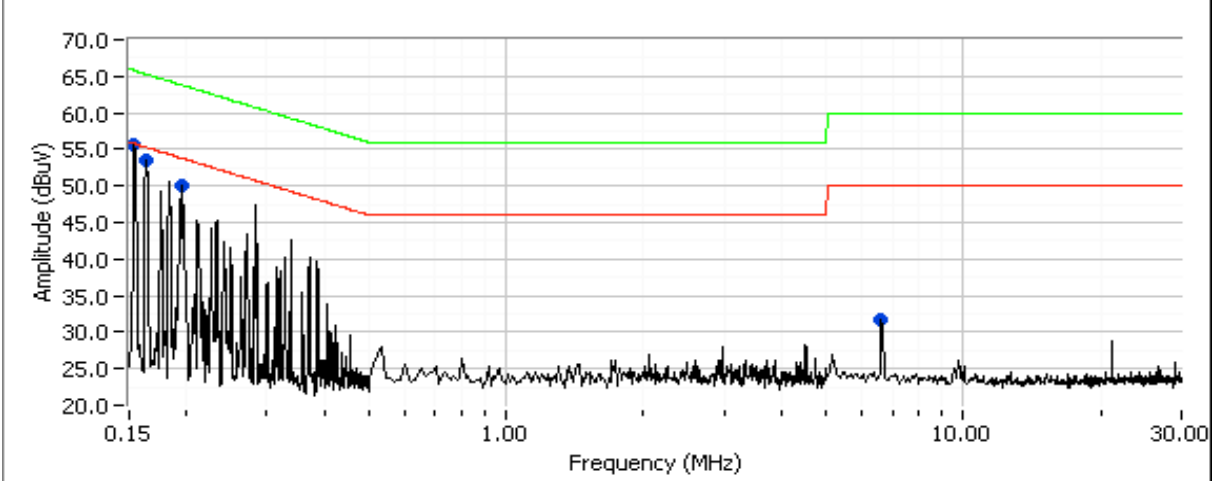

DC Power Port Conducted Emissions, 0.15 - 30MHz (Return)

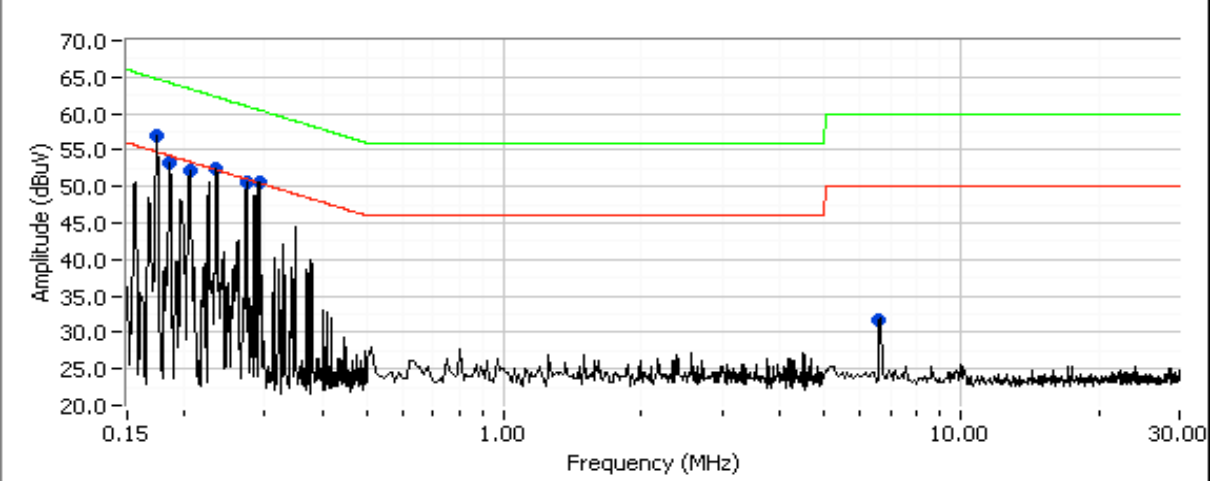



EMC Test Data

Client:	Horizon Hobby, Inc.	Job Number:	J65217
Model:	X10EMTX	T-Log Number:	T65287
Contact:	Paul Beard	Account Manager:	Ezther Zhu
Standard:	EN 300 440 V1.3.1/FCC 15.247	Class:	B

Run #1: AC Power Port Conducted Emissions, 0.15 - 30MHz, 120V/60Hz

Frequency MHz	Level dB μ V	AC Line	EN55022 B		Detector QP/Ave	Comments
			Limit	Margin		
0.206	52.7	Return	63.4	-10.7	QP	
0.183	53.1	Return	64.3	-11.2	QP	
0.176	51.5	Return	64.7	-13.2	QP	
0.165	48.7	Line	65.2	-16.5	QP	
0.196	47.0	Line	63.8	-16.8	QP	
0.154	48.8	Line	65.8	-17.0	QP	
0.234	44.4	Return	62.3	-17.9	QP	
0.273	42.3	Return	61.0	-18.7	QP	
0.291	41.3	Return	60.5	-19.2	QP	
0.234	24.6	Return	52.3	-27.7	AVG	
0.206	25.4	Return	53.4	-28.0	AVG	
0.273	23.0	Return	51.0	-28.0	AVG	
0.183	25.6	Return	54.3	-28.7	AVG	
0.176	24.5	Return	54.7	-30.2	AVG	
0.291	19.3	Return	50.5	-31.2	AVG	
0.196	21.9	Line	53.8	-31.9	AVG	
0.165	21.3	Line	55.2	-33.9	AVG	
0.154	20.7	Line	55.8	-35.1	AVG	



EMC Test Data

Client:	Horizon Hobby, Inc.	Job Number:	J65217
Model:	X1OEMTX	T-Log Number:	T65287
		Account Manager:	Ezther Zhu
Contact:	Paul Beard		
Spec:	EN 300 440 V1.3.1/FCC 15.247	Class:	B

Radiated Emissions - Receive Mode

Test Specifics

Objective: The objective of this test session is to perform final qualification testing of the EUT with respect to the specification listed above.

Date of Test: 9/8/2006	Config. Used: 1
Test Engineer: Mehran Birgani	Config Change: None
Test Location: SVOATS #2	EUT Voltage: Battery

General Test Configuration

The EUT was located on the turntable for radiated emissions testing.

The test distance and extrapolation factor (if used) are detailed under each run description.

Note, **preliminary** testing indicates that the emissions were maximized by orientation of the EUT and elevation of the measurement antenna. **Maximized** testing indicated that the emissions were maximized by orientation of the EUT, elevation of the measurement antenna, and manipulation of the EUT's interface cables.

Note, for testing above 1 GHz, the FCC specifies the limit as an average measurement. In addition, the FCC states that the peak reading of any emission above 1 GHz, can not exceed the average limit by more than 20 dB.

Ambient Conditions: Temperature: 16 °C
 Rel. Humidity: 67 %

Summary of Results

Run #	Test Performed	Limit	Result	Margin
1	Radiated Emission 30 -8000 MHz	15.209	Pass	35.7dBµV/m (61.0µV/m) @ 2433.6MHz (-18.3dB)

Modifications Made During Testing:

No modifications were made to the EUT during testing

Deviations From The Standard

No deviations were made from the requirements of the standard.



EMC Test Data

Client:	Horizon Hobby, Inc.	Job Number:	J65217
Model:	X10EMTX	T-Log Number:	T65287
Contact:	Paul Beard	Account Manager:	Ezther Zhu
Spec:	EN 300 440 V1.3.1/FCC 15.247	Class:	B

Run #1: Preliminary Radiated Emissions, 30-8000 MHz

Frequency MHz	Level dB μ V/m	Pol V/H	15.209 / RSS 210		Detector Pk/QP/Avg	Azimuth degrees	Height meters	Comments
			Limit	Margin				
2433.570	35.7	H	54.0	-18.3	AVG	0	1.0	LO
4884.960	31.0	H	54.0	-23.0	AVG	123	1.0	2nd LO
2442.850	28.6	V	54.0	-25.4	AVG	116	1.0	LO
2433.570	47.2	H	74.0	-26.8	PK	0	1.0	LO
4884.960	42.6	H	74.0	-31.4	PK	123	1.0	2nd LO
2442.850	40.6	V	74.0	-33.4	PK	116	1.0	LO

Note 1: All harmonics of LO were measured and signal levels were more than 20dB μ V/m under the limit.



EMC Test Data

Client:	Horizon Hobby, Inc.	Job Number:	J65217
Model:	X1OEMTX	T-Log Number:	T65287
Contact:	Paul Beard	Account Manager:	Ezther Zhu
Spec:	EN 300 440 V1.3.1/FCC 15.247	Class:	N/A

FCC 15.247 DTS - Power, Bandwidth and Spurious Emissions

Test Specifics

Objective: The objective of this test session is to perform final qualification testing of the EUT with respect to the specification listed above.

Date of Test: 9/8/2006
Test Engineer: Mehran Birgani
Test Location: SVOATS #2

Config. Used: 1
Config Change: None
EUT Voltage

General Test Configuration

The EUT was located on the turntable for radiated spurious emissions testing.

For radiated emissions testing the measurement antenna was located 3 meters from the EUT.

When measuring the conducted emissions from the EUT's antenna port, the antenna port of the EUT was connected to the spectrum analyzer or power meter via a suitable attenuator to prevent overloading the measurement system. All measurements are corrected to allow for the external attenuators used.

Ambient Conditions: Temperature: 16 °C
Rel. Humidity: 67 %

Summary of Results

Run #	Test Performed	Limit	Pass / Fail	Result / Margin
1a - c	Radiated Spurious Emissions, 30 - 26,000 MHz	FCC Part 15.209 / 15.247 (c)	Pass	52.6dB μ V/m (426.6 μ V/m) @ 7427.3MHz (-1.4dB)
1d	RF Port Spurious Emissions, 30 - 26,000 MHz	FCC Part 15.209 / 15.247 (c)	Pass	All emissions <-20dBc
2	6dB Bandwidth	15.247(a)	Pass	833 kHz
3	Output Power	15.247(b)	Pass	2.5 dBm
4	Power Spectral Density (PSD)	15.247(d)	Pass	1.13 dBm/3kHz

Modifications Made During Testing:

No modifications were made to the EUT during testing

Deviations From The Standard

No deviations were made from the requirements of the standard.



EMC Test Data

Client:	Horizon Hobby, Inc.	Job Number:	J65217
Model:	X1OEMTX	T-Log Number:	T65287
Contact:	Paul Beard	Account Manager:	Ezther Zhu
Spec:	EN 300 440 V1.3.1/FCC 15.247	Class:	N/A

Run #1a: Radiated Spurious Emissions, 30 - 25,000 MHz. Low Channel @ 2402 MHz

Fundamental Signal Field Strength: Peak and average values measured in 1 MHz.

Frequency	Level	Pol	15.209 / 15.247		Detector	Azimuth	Height	Comments
MHz	dB μ V/m	V/H	Limit	Margin	Pk/QP/Avg	degrees	meters	
2401.880	100.0	V	54.0	46.0	AVG	125	1.6	RB = 1MHz, VB = 10Hz
2401.880	101.8	V	74.0	27.8	PK	125	1.6	RB = VB = 1MHz
2401.700	101.9	V	74.0	27.9	PK	125	1.6	RB = VB = 100kHz
2401.770	88.8	H	54.0	33.1	AVG	196	2.1	RB = 1MHz, VB = 10Hz
2401.770	90.8	H	74.0	15.2	PK	196	2.1	RB = VB = 1MHz
2401.770	90.7	H	74.0	15.0	PK	196	2.1	RB = VB = 100kHz

Delta Marker - Peak	56.8 dB	Delta between highest in-band and highest
Delta Marker - Average	67.3 dB	

Band Edge Signal Field Strength

Frequency	Level	Pol	15.209 / 15.247		Detector	Azimuth	Height	Comments
MHz	dB μ V/m	V/H	Limit	Margin	Pk/QP/Avg	degrees	meters	
2389.960	33.5	V	54.0	-20.5	AVG	125	1.6	RB = 1MHz, VB = 10Hz
2388.760	45.1	V	74.0	-28.9	PK	125	1.6	RB = VB = 1MHz

Note 1: Calculated by subtracting the marker delta values from the fundamental field strength measurements.

Client: Horizon Hobby, Inc.	Job Number: J65217
Model: X10EMTX	T-Log Number: T65287
Contact: Paul Beard	Account Manager: Ezther Zhu
Spec: EN 300 440 V1.3.1/FCC 15.247	Class: N/A

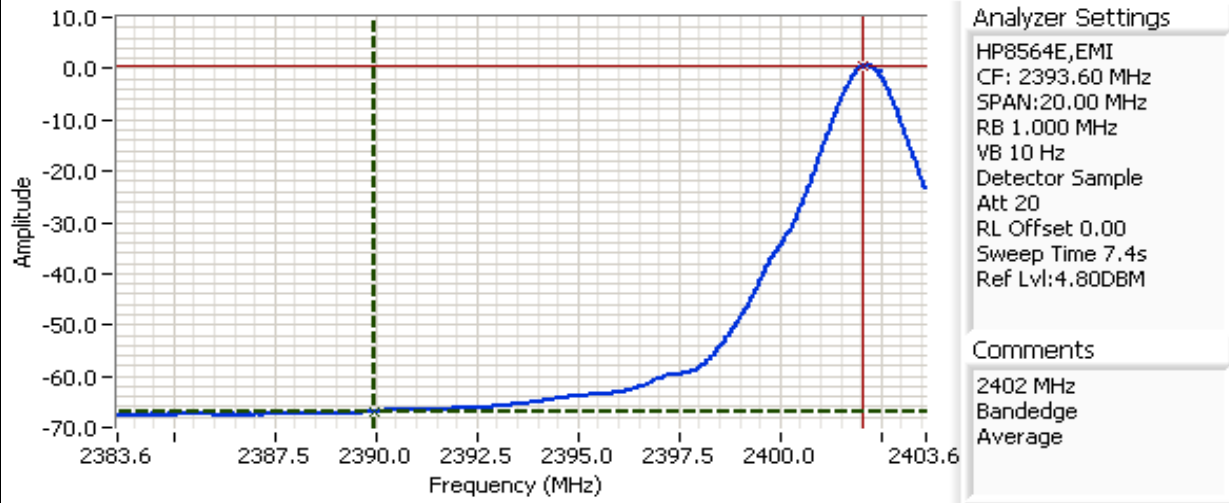

Cursor 1	2389.96	-66.87		Delta Freq.	12.07	
Cursor 2	2402.03	0.47		Delta Amplitude	67.33	

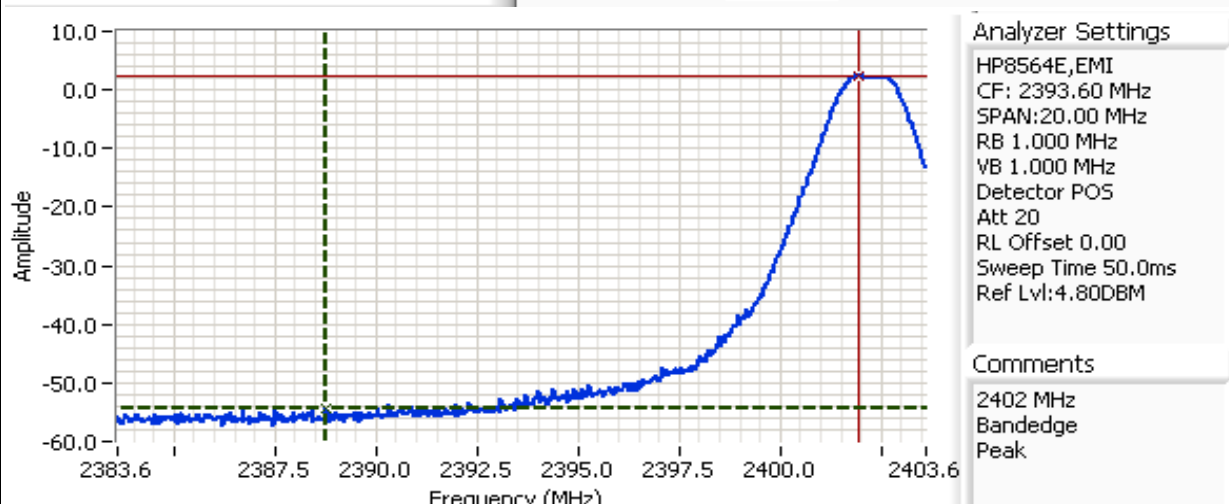

Cursor 1	2388.76	-54.37		Delta Freq.	13.17	
Cursor 2	2401.93	2.47		Delta Amplitude	56.83	



EMC Test Data

Client:	Horizon Hobby, Inc.	Job Number:	J65217
Model:	X10EMTX	T-Log Number:	T65287
Contact:	Paul Beard	Account Manager:	Ezther Zhu
Spec:	EN 300 440 V1.3.1/FCC 15.247	Class:	N/A

Run 1a: Continue (Other Spurious Emissions)

Frequency	Level	Pol	15.209 / 15.247		Detector	Azimuth	Height	Comments
MHz	dB μ V/m	V/H	Limit	Margin	Pk/QP/Avg	degrees	meters	
7205.290	46.1	V	54.0	-7.9	AVG	141	1.0	Note 2
4803.420	44.7	V	54.0	-9.3	AVG	164	1.1	
4803.330	37.8	H	54.0	-16.2	AVG	135	1.8	
7205.050	37.1	H	54.0	-16.9	AVG	323	1.0	Note 2
7205.290	53.5	V	74.0	-20.5	PK	141	1.0	Note 2
4803.420	50.9	V	74.0	-23.1	PK	164	1.1	
7205.050	46.6	H	74.0	-27.4	PK	323	1.0	Note 2
4803.330	45.9	H	74.0	-28.1	PK	135	1.8	

Note 1:	For emissions in restricted bands, the limit of 15.209 was used. For all other emissions, the limit was set 20dB below the level of the fundamental.
Note 2:	The signal does not fall in a restricted band, but the more stringent limits of 15.209 were applied.

Run #1b: Radiated Spurious Emissions, 30 - 25,000 MHz. Center Channel @ 2442 MHz

Other Spurious Emissions

Frequency	Level	Pol	15.209 / 15.247		Detector	Azimuth	Height	Comments
MHz	dB μ V/m	V/H	Limit	Margin	Pk/QP/Avg	degrees	meters	
7325.000	47.1	V	54.0	-6.9	AVG	64	1.1	
4883.230	45.0	V	54.0	-9.0	AVG	188	1.3	
7325.160	40.7	H	54.0	-13.3	AVG	190	1.0	
4883.210	36.4	H	54.0	-17.6	AVG	205	1.0	
7325.000	54.1	V	74.0	-19.9	PK	64	1.1	
4883.230	51.4	V	74.0	-22.6	PK	188	1.3	
7325.160	50.0	H	74.0	-24.0	PK	190	1.0	
4883.210	45.2	H	74.0	-28.8	PK	205	1.0	

Note 1:	For emissions in restricted bands, the limit of 15.209 was used. For all other emissions, the limit was set 20dB below the level of the fundamental.
Note 2:	The signal does not fall in a restricted band, but the more stringent limits of 15.209 were applied.



EMC Test Data

Client:	Horizon Hobby, Inc.	Job Number:	J65217
Model:	X10EMTX	T-Log Number:	T65287
Contact:	Paul Beard	Account Manager:	Ezther Zhu
Spec:	EN 300 440 V1.3.1/FCC 15.247	Class:	N/A

Run #1c: Radiated Spurious Emissions, 30 - 25,000 MHz. High Channel @ 2476 MHz

Fundamental Signal Field Strength: Peak and average values measured in 1 MHz.

Frequency	Level	Pol	15.209 / 15.247		Detector	Azimuth	Height	Comments
MHz	dB μ V/m	V/H	Limit	Margin	Pk/QP/Avg	degrees	meters	
2475.980	101.4	V	54.0	47.4	AVG	137	1.3	RB = 1MHz, VB = 10Hz
2475.980	103.3	V	74.0	29.3	PK	137	1.3	RB = VB = 1MHz
2475.720	102.8	V	74.0	28.8	PK	137	1.3	RB = VB = 100kHz
2475.850	87.1	H	54.0	33.1	AVG	254	1.0	RB = 1MHz, VB = 10Hz
2475.850	89.2	H	74.0	15.2	PK	254	1.0	RB = VB = 1MHz
2476.350	89.0	H	74.0	15.0	PK	254	1.0	RB = VB = 100kHz

Delta Marker - Average	64.0 dB	Delta between highest in-band and highest
Delta Marker - Peak	54.0 dB	

Band Edge Signal Field Strength

Frequency	Level	Pol	15.209 / 15.247		Detector	Azimuth	Height	Comments
MHz	dB μ V/m	V/H	Limit	Margin	Pk/QP/Avg	degrees	meters	
2483.500	37.4	V	54.0	-16.6	AVG	137	1.3	RB = 1MHz, VB = 10Hz
2483.760	49.3	V	74.0	-24.7	PK	137	1.3	RB = VB = 1MHz

Note 1: Calculated by subtracting the marker delta values from the fundamental field strength measurements.

Other Spurious Emissions

Frequency	Level	Pol	15.209 / 15.247		Detector	Azimuth	Height	Comments
MHz	dB μ V/m	V/H	Limit	Margin	Pk/QP/Avg	degrees	meters	
7427.290	52.6	V	54.0	-1.4	AVG	118	1.2	
4951.670	50.3	V	54.0	-3.7	AVG	202	1.0	
7427.080	43.5	H	54.0	-10.5	AVG	313	1.0	
4951.480	39.4	H	54.0	-14.6	AVG	208	1.0	
7427.290	59.1	V	74.0	-14.9	PK	118	1.2	
4951.670	56.1	V	74.0	-17.9	PK	202	1.0	
7427.080	52.4	H	74.0	-21.6	PK	313	1.0	
4951.480	47.0	H	74.0	-27.0	PK	208	1.0	

Note 1: For emissions in restricted bands, the limit of 15.209 was used. For all other emissions, the limit was set 20dB below the level of the fundamental.

Client: Horizon Hobby, Inc.	Job Number: J65217
Model: X10EMTX	T-Log Number: T65287
Contact: Paul Beard	Account Manager: Ezther Zhu
Spec: EN 300 440 V1.3.1/FCC 15.247	Class: N/A



Analyzer Settings
 HP8564E,EMI
 CF: 2484.00 MHz
 SPAN:20.00 MHz
 RB 1.000 MHz
 VB 10 Hz
 Detector Sample
 Att 20
 RL Offset 0.00
 Sweep Time 7.4s
 Ref Lvl:4.00DBM

Comments
 2476 MHz
 Band edge
 Average

Cursor 1	2476.03	-1.17		Delta Freq.	7.467
Cursor 2	2483.50	-65.17		Delta Amplitude	64.00

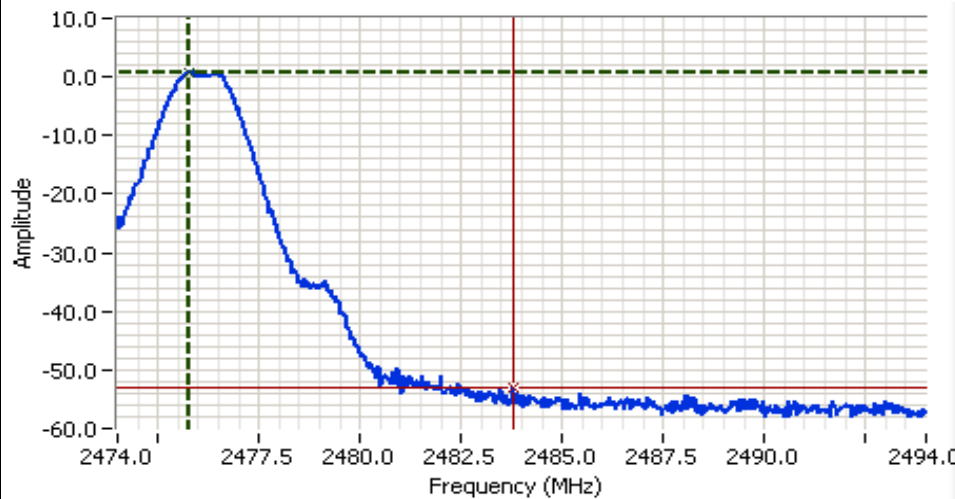

Analyzer Settings
 HP8564E,EMI
 CF: 2484.00 MHz
 SPAN:20.00 MHz
 RB 1.000 MHz
 VB 1.000 MHz
 Detector POS
 Att 20
 RL Offset 0.00
 Sweep Time 50.0ms
 Ref Lvl:4.00DBM

Comments
 2476 MHz
 Band edge
 Peak

Cursor 1	2475.76	0.83		Delta Freq.	8.000
Cursor 2	2483.76	-53.17		Delta Amplitude	54.00



Note: Band from 2483.5-2500 MHz was checked and the highest signal signal was found at 2483.5 MHz.

Client: Horizon Hobby, Inc.	Job Number: J65217
Model: X10EMTX	T-Log Number: T65287
Contact: Paul Beard	Account Manager: Ezther Zhu
Spec: EN 300 440 V1.3.1/FCC 15.247	Class: N/A

Run #1d: Antenna Conducted Spurious Emissions, 30 - 25,000 MHz.

Refer to plots below. Scans made using RBW=VB=100 KHz with the limit line set at 20dB below the highest in-band signal level.
[Spur at 30MHz in the first plot is actually artifact of 0Hz]

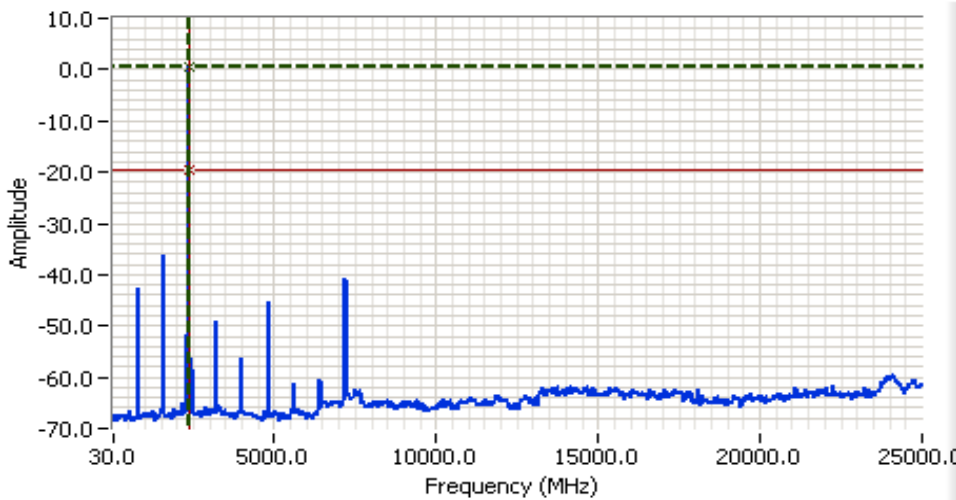

Analyzer Settings

HP8564E,EMI
 CF: 12515.00 MHz
 SPAN:24970.00 MHz
 RB 100 kHz
 VB 100 kHz
 Detector POS
 Att 20
 RL Offset 0.00
 Sweep Time 14.0s
 Ref Lvl:4.80DBM

Comments

2402 MHz

Cursor 1	2370.93	0.47		Delta Freq.	0.00 MHz	
Cursor 2	2370.93	-19.53		Delta Amplitude	20.00	

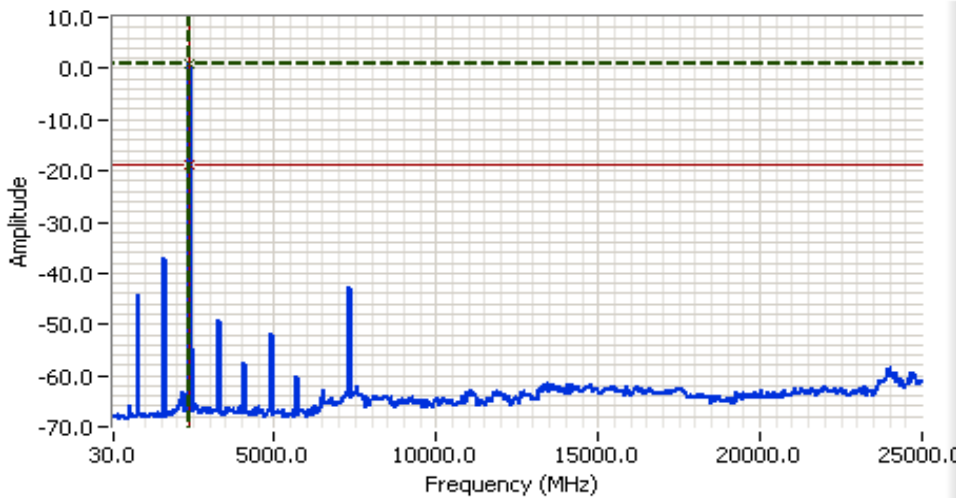

Analyzer Settings

HP8564E,EMI
 CF: 12515.00 MHz
 SPAN:24970.00 MHz
 RB 100 kHz
 VB 300 kHz
 Detector POS
 Att 20
 RL Offset 0.00
 Sweep Time 14.0s
 Ref Lvl:2.00DBM

Comments

2442 MHz

Cursor 1	2402.15	1.00		Delta Freq.	0.00 MHz	
Cursor 2	2402.15	-19.00		Delta Amplitude	20.00	

Client: Horizon Hobby, Inc.	Job Number: J65217
Model: X10EMTX	T-Log Number: T65287
Contact: Paul Beard	Account Manager: Ezther Zhu
Spec: EN 300 440 V1.3.1/FCC 15.247	Class: N/A

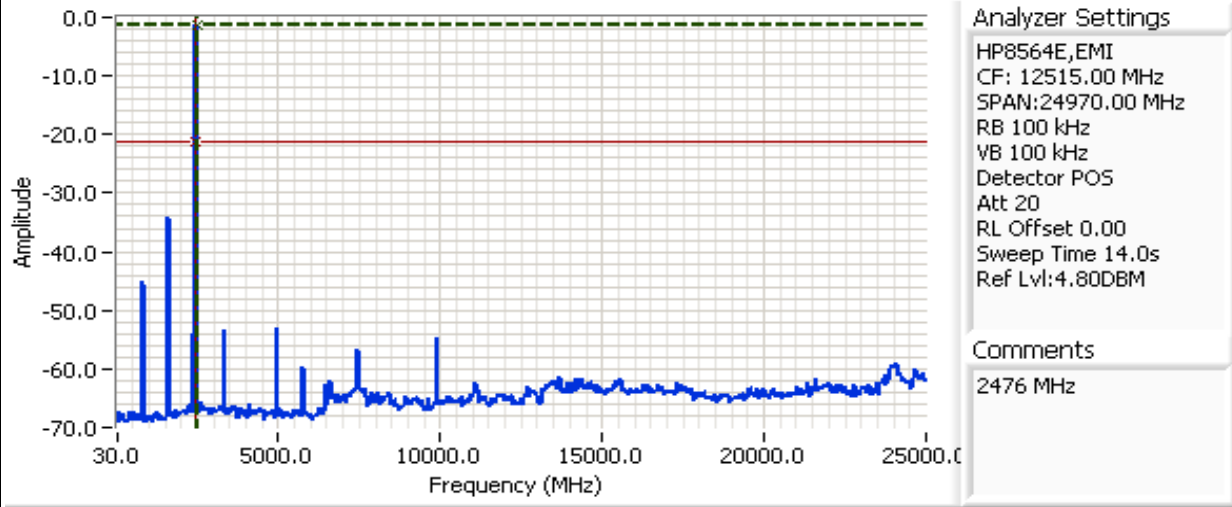

Analyzer Settings

HP8564E,EMI
 CF: 12515.00 MHz
 SPAN:24970.00 MHz
 RB 100 kHz
 VB 100 kHz
 Detector POS
 Att 20
 RL Offset 0.00
 Sweep Time 14.0s
 Ref Lvl:4.80DBM

Comments

2476 MHz

Cursor 1	2500.99	-1.20		Delta Freq.	65.03	
Cursor 2	2435.96	-21.20		Delta Amplitude	20.00	

Run #2: Signal Bandwidth

Rate	Frequency (MHz)	Resolution Bandwidth	6dB Signal Bandwidth	99% Signal Bandwidth
64	2402	100kHz	0.825	1.115
64	2442	100kHz	0.833	1.115
64	2476	100kHz	0.817	1.131

99% bandwidth measured on all three channels with RB=100kHz, VB=300kHz, peak detector (no averaging)
 6dB bandwidth measured using RB=100kHz, VB=100kHz, peak detector, no averaging

Client: Horizon Hobby, Inc.	Job Number: J65217
Model: X10EMTX	T-Log Number: T65287
Contact: Paul Beard	Account Manager: Ezther Zhu
Spec: EN 300 440 V1.3.1/FCC 15.247	Class: N/A

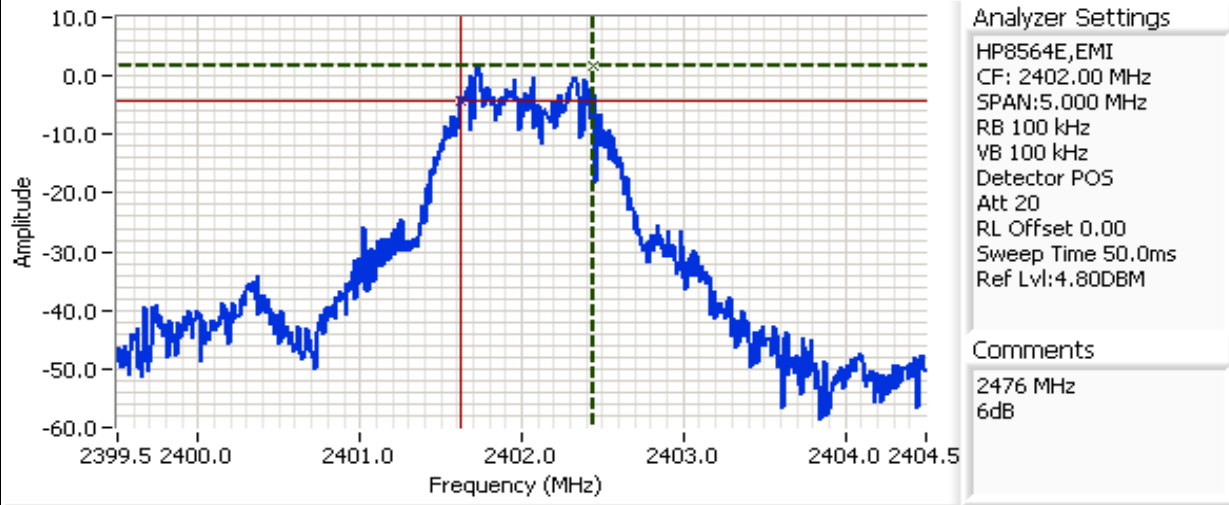

Cursor 1 2402.44 1.63

Cursor 2 2401.61 -4.37

Delta Freq. 825 kHz

Delta Amplitude 6.00

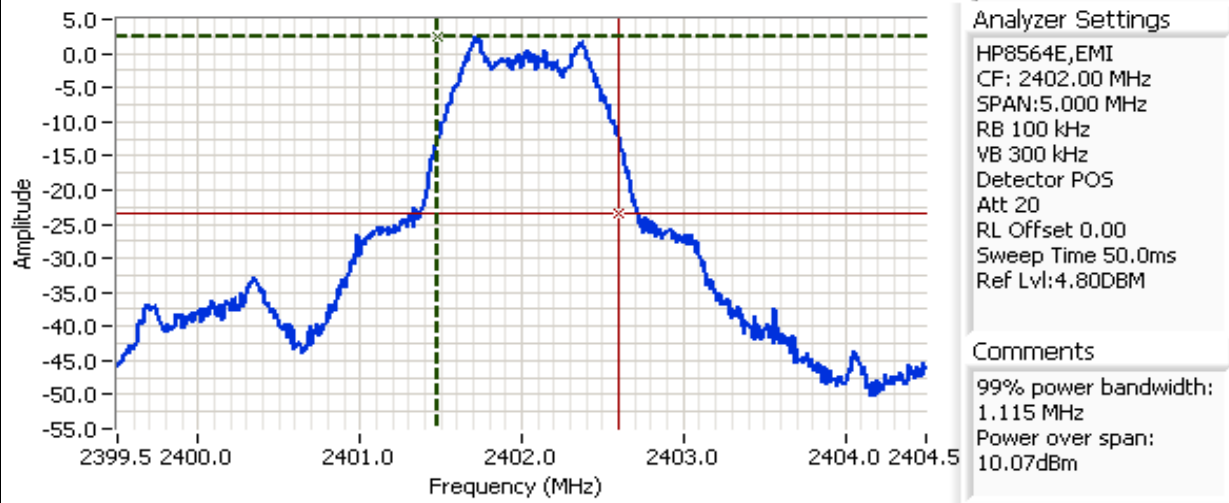

Cursor 1 2401.48 2.47

Cursor 2 2402.59 -23.53

Delta Freq. 1.115

Delta Amplitude 26.00

Client: Horizon Hobby, Inc.	Job Number: J65217
Model: X10EMTX	T-Log Number: T65287
Contact: Paul Beard	Account Manager: Ezther Zhu
Spec: EN 300 440 V1.3.1/FCC 15.247	Class: N/A

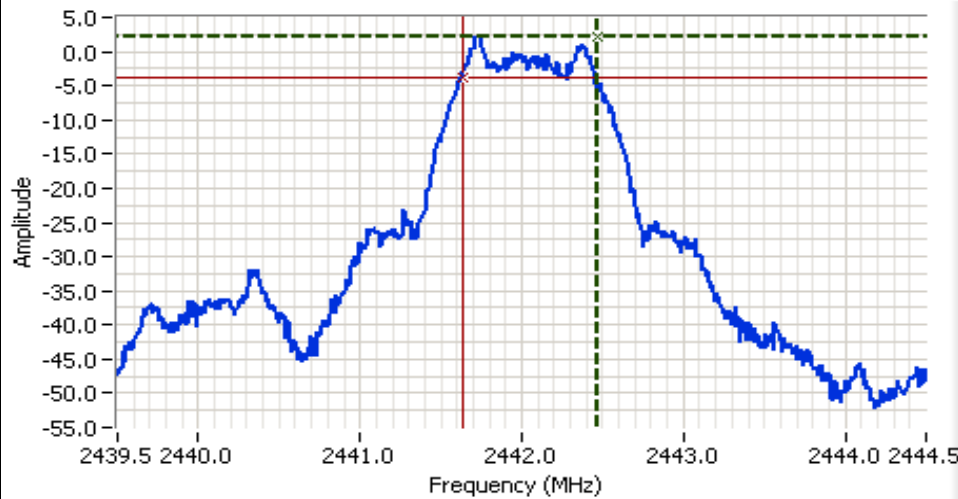

Analyzer Settings

HP8564E,EMI
 CF: 2442.00 MHz
 SPAN:5.000 MHz
 RB 100 kHz
 VB 100 kHz
 Detector POS
 Att 20
 RL Offset 0.00
 Sweep Time 50.0ms
 Ref Lvl:7.90DBM

Comments

2442 MHz
 6dB

Cursor 1 2442.46 2.23

Cursor 2 2441.63 -3.77

Delta Freq. 833 kHz

Delta Amplitude 6.00

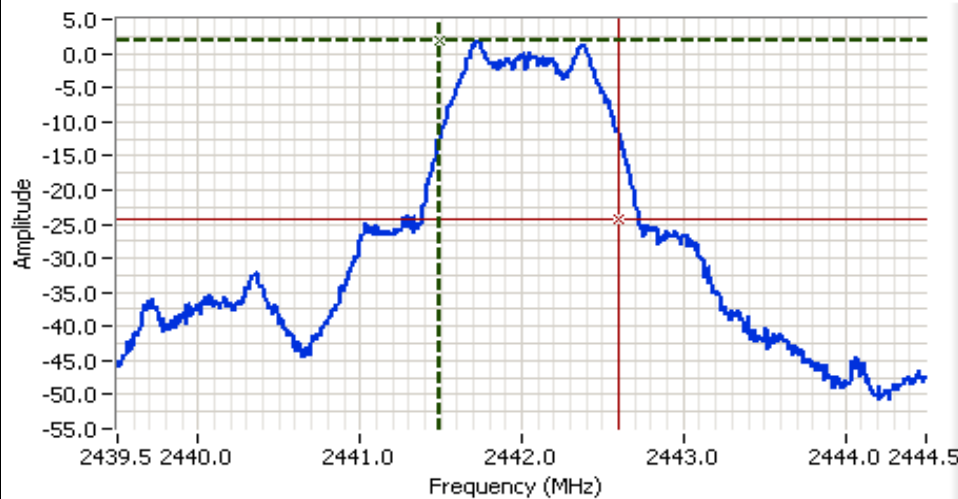

Analyzer Settings

HP8564E,EMI
 CF: 2442.00 MHz
 SPAN:5.000 MHz
 RB 100 kHz
 VB 300 kHz
 Detector POS
 Att 20
 RL Offset 0.00
 Sweep Time 50.0ms
 Ref Lvl:7.90DBM

Comments

99% power bandwidth:
 1.115 MHz
 Power over span:
 9.95dBm

Cursor 1 2441.48 1.73

Cursor 2 2442.60 -24.27

Delta Freq. 1.115

Delta Amplitude 26.00



Client:	Horizon Hobby, Inc.	Job Number:	J65217
Model:	X10EMTX	T-Log Number:	T65287
Contact:	Paul Beard	Account Manager:	Ezther Zhu
Spec:	EN 300 440 V1.3.1/FCC 15.247	Class:	N/A

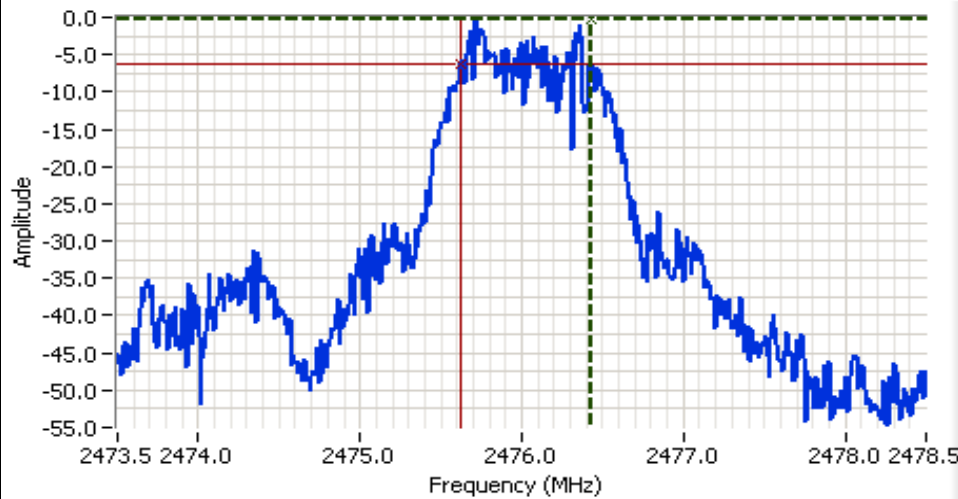

Analyzer Settings

HP8564E,EMI
 CF: 2476.00 MHz
 SPAN:5.000 MHz
 RB 100 kHz
 VB 100 kHz
 Detector POS
 Att 10
 RL Offset 0.00
 Sweep Time 50.0ms
 Ref Lvl:0.00DBM

Comments

2476 MHz
 6dB Bandwidth

Cursor 1	2476.43	-0.33	
Cursor 2	2475.61	-6.33	

Delta Freq. 817 kHz
 Delta Amplitude 6.00

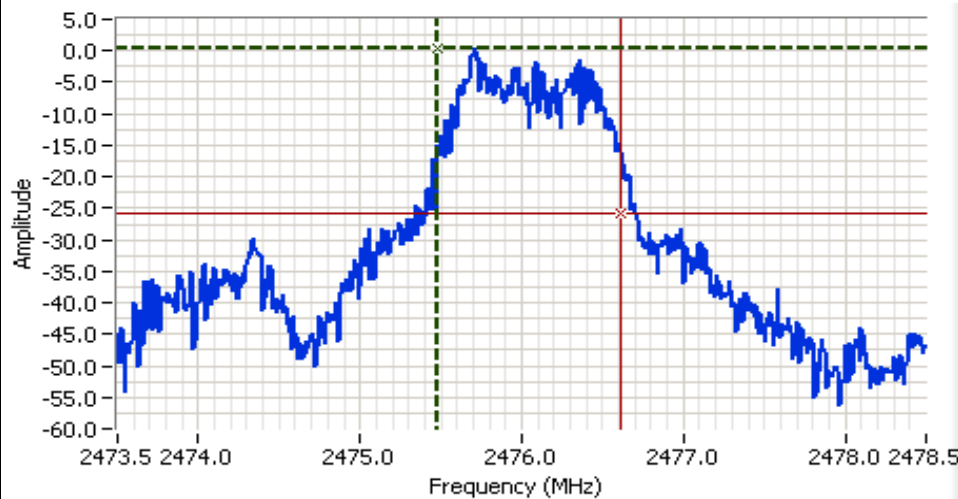

Analyzer Settings

HP8564E,EMI
 CF: 2476.00 MHz
 SPAN:5.000 MHz
 RB 100 kHz
 VB 300 kHz
 Detector POS
 Att 10
 RL Offset 0.00
 Sweep Time 50.0ms
 Ref Lvl:0.00DBM

Comments

99% power bandwidth:
 1.131 MHz
 Power over span:
 6.06dBm

Cursor 1	2475.48	0.33	
Cursor 2	2476.61	-25.67	

Delta Freq. 1.131
 Delta Amplitude 26.00





EMC Test Data

Client:	Horizon Hobby, Inc.	Job Number:	J65217
Model:	X10EMTX	T-Log Number:	T65287
Contact:	Paul Beard	Account Manager:	Ezther Zhu
Spec:	EN 300 440 V1.3.1/FCC 15.247	Class:	N/A

Run #3: Output Power

Maximum antenna gain: 2 dBi

Rate	Frequency (MHz)	Res BW MHz	Output Power ^{Note 1}		EIRP W	Average Power ^{Note 2}	
			dBm	W		dBm	W
64	2402	3	2.5	0.002	0.003		
64	2441	3	2.4	0.002	0.003		
64	2476	3	1.2	0.001	0.002		

Note 1: Output power measured using a spectrum analyzer, RB= 3MHz, VB=3MHz

Run #4: Power Spectral Density

Rate	Operating Frequency (MHz)	Freq. @ PPSD	Res BW	P.S.D. (dBm/3kHz)
64	2402	2401.683	3 kHz	1.13
64	2442	2441.686	3 kHz	0.73
64	2476	2475.686	3 kHz	-2.03

Note 1: Freq. @ PPSD: Frequency of the Peak Power Spectral Density (PPSD)

Note 2: Power spectral density measured using RB=3 kHz, VB=10kHz with a sweep time set to ensure a dwell time of at least 1 second per 3kHz. The measurement is made at the frequency of PPSD determined from preliminary scans using RB=3kHz using multiple sweeps at a faster rate over the 6dB bandwidth of the signal.



EMC Test Data

Client:	Horizon Hobby, Inc.	Job Number:	J65217
Model:	X10EMTX	T-Log Number:	T65287
Contact:	Paul Beard	Account Manager:	Ezther Zhu
Spec:	EN 300 440 V1.3.1/FCC 15.247	Class:	N/A

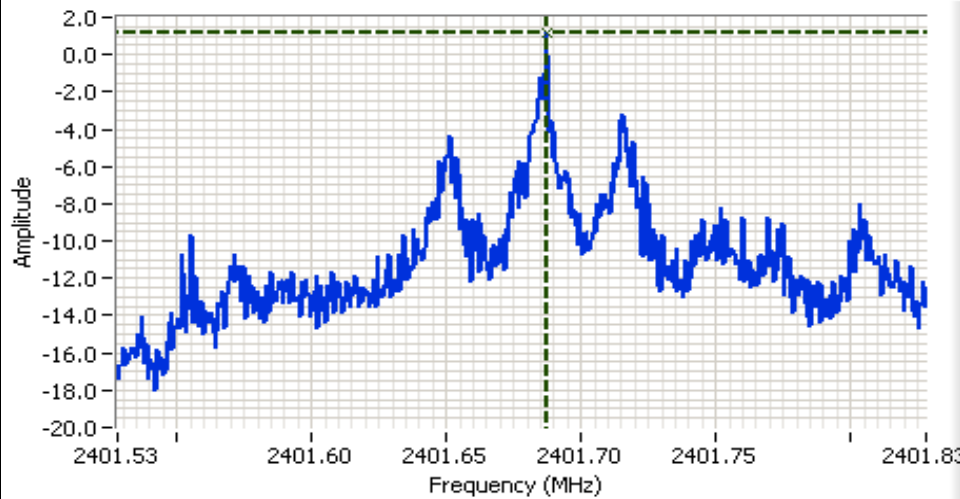

Analyzer Settings
HP8564E,EMI
CF: 2401.68 MHz
SPAN:300 kHz
RB 3 kHz
VB 10 kHz
Detector POS
Att 20
RL Offset 0.00
Sweep Time 100.0s
Ref Lvl:4.80DBM

Comments
2402 MHz
PSD

Cursor 1 2401.68 1.13
0.000 0.00

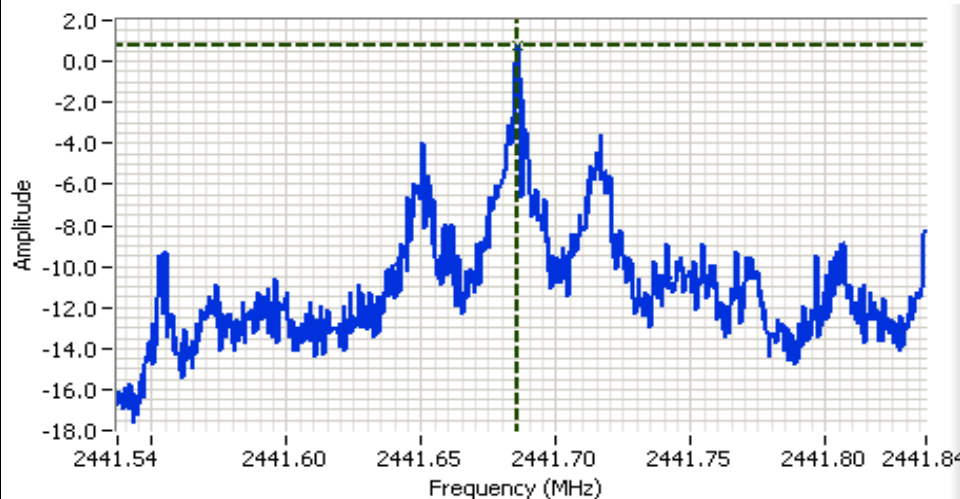

Analyzer Settings
HP8564E,EMI
CF: 2441.69 MHz
SPAN:300 kHz
RB 3 kHz
VB 10 kHz
Detector POS
Att 20
RL Offset 0.00
Sweep Time 100.0s
Ref Lvl:7.90DBM

Comments
2442 MHz
PSD

Cursor 1 2441.69 0.73
0.000 0.00





EMC Test Data

Client:	Horizon Hobby, Inc.	Job Number:	J65217
Model:	X10EMTX	T-Log Number:	T65287
Contact:	Paul Beard	Account Manager:	Ezther Zhu
Spec:	EN 300 440 V1.3.1/FCC 15.247	Class:	N/A

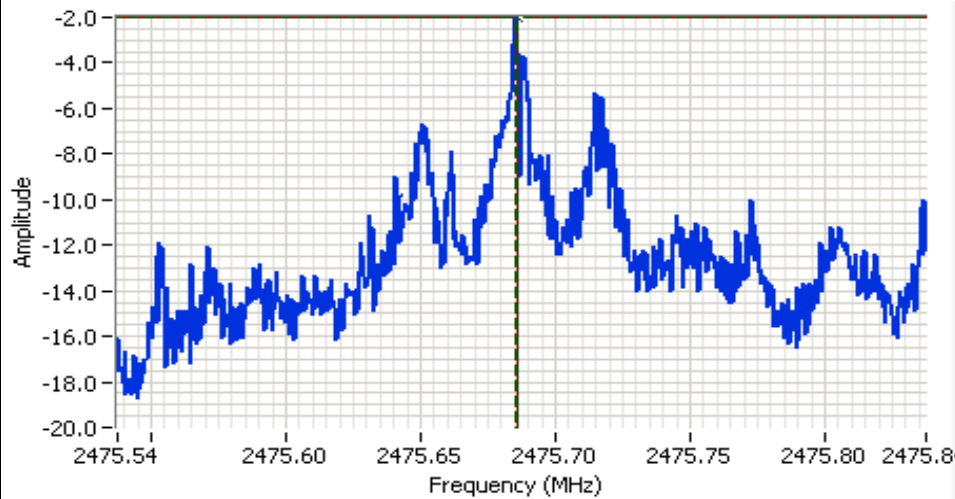

Analyzer Settings
HP8564E,EMI
CF: 2475.69 MHz
SPAN:300 kHz
RB 3 kHz
VB 10 kHz
Detector POS
Att 20
RL Offset 0.00
Sweep Time 100.0s
Ref Lvl:4.80DBM

Comments
2476 MHz
PSD

Cursor 1	2475.68	-2.03	
Cursor 2	2475.68	-2.03	

Delta Freq. 0.00 MHz
Delta Amplitude 0.00



EXHIBIT 3: Photographs of Test Configurations

3 Pages

EXHIBIT 4: Proposed FCC ID Label & Label Location

2 Pages

**EXHIBIT 5: Detailed Photographs
of Horizon Hobby, Inc. Model X1OEMTX Construction**

3 Pages

**EXHIBIT 6: Operator's Manual
for Horizon Hobby, Inc. Model X10EMTX**

3 Pages

**EXHIBIT 7: Block Diagram
of Horizon Hobby, Inc. Model X10EMTX**

1 Page

**EXHIBIT 8: Schematic Diagrams
for Horizon Hobby, Inc. Model X10EMTX**

1 Page

**EXHIBIT 9: Theory of Operation
for Horizon Hobby, Inc. Model X10EMTX**

2 Page

EXHIBIT 10: Modular Approval Requirements

1 Page

EXHIBIT 11: RF Exposure Information

DAMA0BM11500200(Ante 5 Pages
nna Spec)
RSS-102 DoC 2 Pages
SAR Exclusion 1 Page