

# FCC Test Report

Report No.: AGC01628180407FE02

**FCC ID** : BRWDX6R  
**APPLICATION PURPOSE** : Original Equipment  
**PRODUCT DESIGNATION** : DX6R  
**BRAND NAME** : Spektrum  
**MODEL NAME** : DX6R  
**CLIENT** : Horizon Hobby, LLC  
**DATE OF ISSUE** : May 28, 2018  
**STANDARD(S)** : FCC Part 15.247  
**REPORT VERSION** : V1.0

## Attestation of Global Compliance (Shenzhen) Co., Ltd

**CAUTION:**

This report shall not be reproduced except in full without the written permission of the test laboratory and shall not be quoted out of context.



The results shown in this test report refer only to the sample(s) tested unless otherwise stated and the sample(s) are retained for 30 days only. The document is issued by AGC, this document cannot be reproduced except in full with our prior written permission. The more details and the authenticity of the report will be confirmed at <http://www.agc-cert.com>.

**REPORT REVISE RECORD**

Report Version	Revise Time	Issued Date	Valid Version	Notes
V1.0	/	May 28, 2018	Valid	Initial Release

The results shown in this test report refer only to the sample(s) tested unless otherwise stated and the sample(s) are retained for 30 days only. The document is issued by AGC, this document cannot be reproduced except in full with our prior written permission. The more details and the authenticity of the report will be confirmed at <http://www.agc-cert.com>.

**TABLE OF CONTENTS**

**1. VERIFICATION OF COMPLIANCE..... 5**

**2.GENERAL INFORMATION..... 6**

2.1PRODUCT DESCRIPTION ..... 6

2.2. TABLE OF CARRIER FREQUENCIES ..... 6

2.3 RELATED SUBMITTAL(S)/GRANT(S)..... 7

2.4TEST METHODOLOGY ..... 7

2.5 SPECIAL ACCESSORIES..... 7

2.6 EQUIPMENT MODIFICATIONS..... 7

**3. MEASUREMENT UNCERTAINTY ..... 8**

**4. DESCRIPTION OF TEST MODES ..... 9**

**5. SYSTEM TEST CONFIGURATION ..... 10**

5.1 CONFIGURATION OF TESTED SYSTEM..... 10

5.2 EQUIPMENT USED IN TESTED SYSTEM..... 10

5.3. SUMMARY OF TEST RESULTS..... 10

**6. TEST FACILITY ..... 11**

**7. PEAK OUTPUT POWER..... 12**

7.1. MEASUREMENT PROCEDURE..... 12

7.2. TEST SET-UP (BLOCK DIAGRAM OF CONFIGURATION)..... 12

7.3. LIMITS AND MEASUREMENT RESULT..... 13

**8. 6 DB BANDWIDTH..... 15**

8.1. MEASUREMENT PROCEDURE..... 15

8.2. TEST SET-UP (BLOCK DIAGRAM OF CONFIGURATION)..... 15

8.3. LIMITS AND MEASUREMENT RESULTS..... 15

**9. CONDUCTED SPURIOUS EMISSION..... 17**

9.1. MEASUREMENT PROCEDURE..... 17

9.2. TEST SET-UP (BLOCK DIAGRAM OF CONFIGURATION)..... 17

9.3. MEASUREMENT EQUIPMENT USED ..... 17

9.4. LIMITS AND MEASUREMENT RESULT..... 17

**10. MAXIMUM CONDUCTED OUTPUT POWER SPECTRAL DENSITY ..... 22**

The results shown in this test report refer only to the sample(s) tested unless otherwise stated and the sample(s) are retained for 30 days only. The document is issued by AGC, this document cannot be reproduced except in full with our prior written permission. The more details and the authenticity of the report will be confirmed at <http://www.agc-cert.com>.



10.1 MEASUREMENT PROCEDURE.....	22
10.2 TEST SET-UP (BLOCK DIAGRAM OF CONFIGURATION).....	22
10.3 MEASUREMENT EQUIPMENT USED.....	22
10.4 LIMITS AND MEASUREMENT RESULT.....	22
<b>11. RADIATED EMISSION .....</b>	<b>24</b>
11.1. MEASUREMENT PROCEDURE.....	24
11.2. TEST SETUP.....	25
11.3. LIMITS AND MEASUREMENT RESULT.....	26
11.4. TEST RESULT.....	26
<b>12. FCC LINE CONDUCTED EMISSION TEST .....</b>	<b>36</b>
12.1. LIMITS OF LINE CONDUCTED EMISSION TEST.....	36
12.2. BLOCK DIAGRAM OF LINE CONDUCTED EMISSION TEST.....	36
12.3. PRELIMINARY PROCEDURE OF LINE CONDUCTED EMISSION TEST.....	37
12.4. FINAL PROCEDURE OF LINE CONDUCTED EMISSION TEST.....	37
12.5. TEST RESULT OF LINE CONDUCTED EMISSION TEST.....	38
<b>APPENDIX A: PHOTOGRAPHS OF TEST SETUP .....</b>	<b>40</b>

The results shown in this test report refer only to the sample(s) tested unless otherwise stated and the sample(s) are retained for 30 days only. The document is issued by AGC, this document cannot be reproduced except in full with our prior written permission. The more details and the authenticity of the report will be confirmed at <http://www.agc-cert.com>.

**1. VERIFICATION OF COMPLIANCE**

<b>Applicant</b>	Horizon Hobby, LLC
<b>Address</b>	4105 Fieldstone Road, Champaign, IL 61822, USA
<b>Manufacturer</b>	Horizon Hobby, LLC
<b>Address</b>	4105 Fieldstone Road, Champaign, IL 61822, USA
<b>Product Designation</b>	DX6R
<b>Brand Name</b>	Spektrum
<b>Test Model</b>	DX6R
<b>Date of test</b>	May 21, 2018 to May 28, 2018
<b>Deviation</b>	None
<b>Condition of Test Sample</b>	Normal
<b>Test Result</b>	Pass
<b>Report Template</b>	AGCRT-US-BLE/RF

We hereby certify that:

The above equipment was tested by Attestation of Global Compliance (Shenzhen) Co., Ltd. The test data, data evaluation, test procedures, and equipment configurations shown in this report were made in accordance with the procedures given in ANSI C63.10 (2013) and the energy emitted by the sample EUT tested as described in this report is in compliance with radiated emission limits of FCC part 15.247.

Tested By

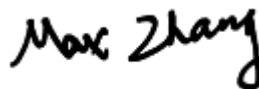

Max Zhang(Zhang Yi)

May 28, 2018

Reviewed By



Bart Xie(Xie Xiaobin)

May 28, 2018

Approved By



Forrest Lei(Lei Yonggang)

Authorized Officer

May 28, 2018

The results shown in this test report refer only to the sample(s) tested unless otherwise stated and the sample(s) are retained for 30 days only. The document is issued by AGC, this document cannot be reproduced except in full with our prior written permission. The more details and the authenticity of the report will be confirmed at <http://www.agc-cert.com>.

## 2.GENERAL INFORMATION

### 2.1PRODUCT DESCRIPTION

The EUT is designed as a “DX6R”. It is designed by way of utilizing the GFSK technology to achieve the system operation.

A major technical description of EUT is described as following

<b>Operation Frequency</b>	2.402 GHz to 2.480GHz
<b>RF Output Power</b>	7.414dBm(Max)
<b>Bluetooth Version</b>	V 4.0
<b>Modulation</b>	GFSK
<b>Number of channels</b>	40 Channel
<b>Antenna Designation</b>	Integrated Antenna
<b>Antenna Gain</b>	1.5dBi
<b>Hardware Version</b>	UH1-SOM-DX12-REV03
<b>Software Version</b>	2.02.06.
<b>Power Supply</b>	DC 6V by battery or DC 5V by Micro-USB

### 2.2. TABLE OF CARRIER FREQUENCIES

Frequency Band	Channel Number	Frequency
2400~2483.5MHZ	0	2402MHZ
	1	2404MHZ
	:	:
	38	2478 MHZ
	39	2480 MHZ

The results shown in this test report refer only to the sample(s) tested unless otherwise stated and the sample(s) are retained for 30 days only. The document is issued by AGC, this document cannot be reproduced except in full with our prior written permission. The more details and the authenticity of the report will be confirmed at <http://www.agc-cert.com>.



### 2.3 RELATED SUBMITTAL(S)/GRANT(S)

This submittal(s) (test report) is intended for **FCC ID: BRWDX6R** filing to comply with the FCC Part 15.247 requirements.

### 2.4 TEST METHODOLOGY

Both conducted and radiated testing was performed according to the procedures in ANSI C63.10 (2013). Radiated testing was performed at an antenna to EUT distance 3 meters.

### 2.5 SPECIAL ACCESSORIES

Refer to section 2.2.

### 2.6 EQUIPMENT MODIFICATIONS

Not available for this EUT intended for grant.

The results shown in this test report refer only to the sample(s) tested unless otherwise stated and the sample(s) are retained for 30 days only. The document is issued by AGC, this document cannot be reproduced except in full with our prior written permission. The more details and the authenticity of the report will be confirmed at <http://www.agc-cert.com>.

### 3. MEASUREMENT UNCERTAINTY

The uncertainty is calculated using the methods suggested in the “Guide to the Expression of Uncertainty in measurement” (GUM) published by CISPR and ANSI.

- Uncertainty of Conducted Emission,  $U_c = \pm 3.2$  dB
- Uncertainty of Radiated Emission below 1GHz,  $U_c = \pm 3.9$  dB
- Uncertainty of Radiated Emission above 1GHz,  $U_c = \pm 4.8$  dB

The results shown in this test report refer only to the sample(s) tested unless otherwise stated and the sample(s) are retained for 30 days only. The document is issued by AGC, this document cannot be reproduced except in full with our prior written permission. The more details and the authenticity of the report will be confirmed at <http://www.agc-cert.com>.



#### 4. DESCRIPTION OF TEST MODES

NO.	TEST MODE DESCRIPTION
1	Low channel TX
2	Middle channel TX
3	High channel TX
4	Normal Operating (BT)

Note:

1. Only the result of the worst case was recorded in the report, if no other cases.
2. For Radiated Emission, 3axis were chosen for testing for each applicable mode.

The results shown in this test report refer only to the sample(s) tested unless otherwise stated and the sample(s) are retained for 30 days only. The document is issued by AGC, this document cannot be reproduced except in full with our prior written permission. The more details and the authenticity of the report will be confirmed at <http://www.agc-cert.com>.

## 5. SYSTEM TEST CONFIGURATION

### 5.1 CONFIGURATION OF TESTED SYSTEM

Radiated Emission Configure :



Conducted Emission Configure :

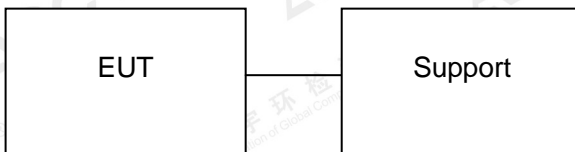

### 5.2 EQUIPMENT USED IN TESTED SYSTEM

Item	Equipment	Mfr/Brand	Model/Type No.	Remark
1	DX6R	DX6R	BRWDX6R	EUT
2	Adapter	SF12-050200UX	DC5V/2A	Marketed

### 5.3. SUMMARY OF TEST RESULTS

FCC RULES	DESCRIPTION OF TEST	RESULT
15.247	Peak Output Power	Compliant
15.247	6 dB Bandwidth	Compliant
15.247	Conducted Spurious Emission and Band Edges	Compliant
15.247	Maximum Conducted Output Power Density	Compliant
15.247&15.209	Radiated Emission	Compliant
15.207	Conducted Emission	Compliant

The results shown in this test report refer only to the sample(s) tested unless otherwise stated and the sample(s) are retained for 30 days only. The document is issued by AGC, this document cannot be reproduced except in full with our prior written permission. The more details and the authenticity of the report will be confirmed at <http://www.agc-cert.com>.

**6. TEST FACILITY**

<b>Test Site</b>	Attestation of Global Compliance (Shenzhen) Co., Ltd
<b>Location</b>	1-2F., Bldg.2, No.1-4, Chaxi Sanwei Technical Industrial Park, Gushu, Xixiang, Bao'an District B112-B113, Bldg.12, Baoan Bldg Materials Center, No.1 of Xixiang Inner Ring Road, Baoan District, Shenzhen 518012
<b>NVLAP LAB CODE</b>	600153-0
<b>Designation Number</b>	CN5028
<b>FCC Test Firm Registration Number</b>	682566
<b>Description</b>	Attestation of Global Compliance(Shenzhen) Co., Ltd is accredited by National Voluntary Laboratory Accreditation program, NVLAP Code 600153-0

**TEST EQUIPMENT OF CONDUCTED EMISSION TEST**

Equipment	Manufacturer	Model	S/N	Cal. Date	Cal. Due
TEST RECEIVER	R&S	ESPI	101206	Jun. 20, 2017	Jun. 19, 2018
LISN	R&S	ESH2-Z5	100086	Aug. 21, 2017	Aug. 20, 2018

**TEST EQUIPMENT OF RADIATED EMISSION TEST**

Equipment	Manufacturer	Model	S/N	Cal. Date	Cal. Due
TEST RECEIVER	R&S	ESCI	10096	Jun. 20, 2017	Jun. 19, 2018
EXA Signal Analyzer	Aglient	N9010A	MY53470504	Dec .08, 2017	Dec. 07, 2018
Horn antenna	SCHWARZBECK	BBHA 9170	#768	Sep. 20, 2017	Sep. 19, 2018
preamplifier	ChengYi	EMC184045SE	980508	Sep. 15, 2017	Sep. 14, 2018
Active loop antenna (9K-30MHz)	A.H.	SAS-562B	N/A	Mar. 01, 2018	Feb. 28, 2020
Double-Ridged Waveguide Horn	ETS LINDGREN	3117	00034609	May 18, 2017	May 17, 2019
Broadband Preamplifier	SCHWARZBECK	BBV 9718	9718-205	Jun. 20, 2017	Jun. 19, 2018
ANTENNA	SCHWARZBECK	VULB9168	D69250	Sep. 28, 2017	Sep. 27, 2018

The results shown in this test report refer only to the sample(s) tested unless otherwise stated and the sample(s) are retained for 30 days only. The document is issued by AGC, this document cannot be reproduced except in full with our prior written permission. The more details and the authenticity of the report will be confirmed at <http://www.agc-cert.com>.



## 7. PEAK OUTPUT POWER

### 7.1. MEASUREMENT PROCEDURE

For peak power test:

1. Connect EUT RF output port to the Spectrum Analyzer through an RF attenuator
2.  $RBW \geq DTS$  bandwidth
3.  $VBW \geq 3 * RBW$ .
4.  $SPAN \geq VBW$ .
5. Sweep: Auto.
6. Detector function: Peak.
7. Trace: Max hold.

Allow trace to stabilize. Use the marker-to-peak function to set the marker to the peak of the emission. The indicated level is the peak output power, after any corrections for external attenuators and cables.

### 7.2. TEST SET-UP (BLOCK DIAGRAM OF CONFIGURATION) PEAK POWER TEST SETUP

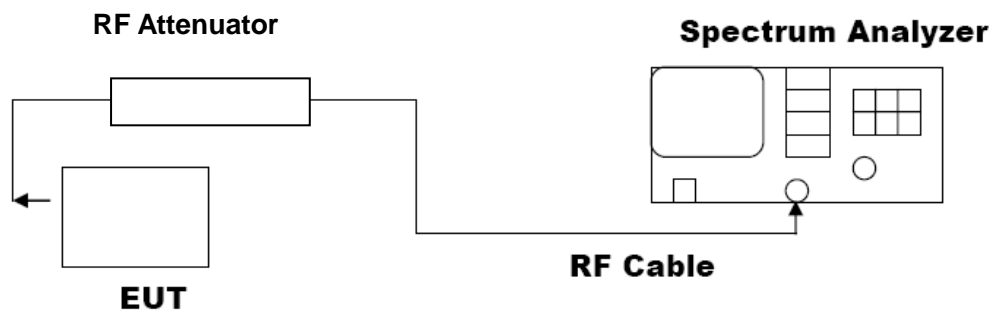

The results shown in this test report refer only to the sample(s) tested unless otherwise stated and the sample(s) are retained for 30 days only. The document is issued by AGC, this document cannot be reproduced except in full with our prior written permission. The more details and the authenticity of the report will be confirmed at <http://www.agc-cert.com>.

**7.3. LIMITS AND MEASUREMENT RESULT**

PEAK OUTPUT POWER MEASUREMENT RESULT FOR GFSK MODULATION			
Frequency (GHz)	Peak Power (dBm)	Applicable Limits (dBm)	Pass or Fail
2.402	6.131	30	Pass
2.440	7.414	30	Pass
2.480	6.643	30	Pass

CH0

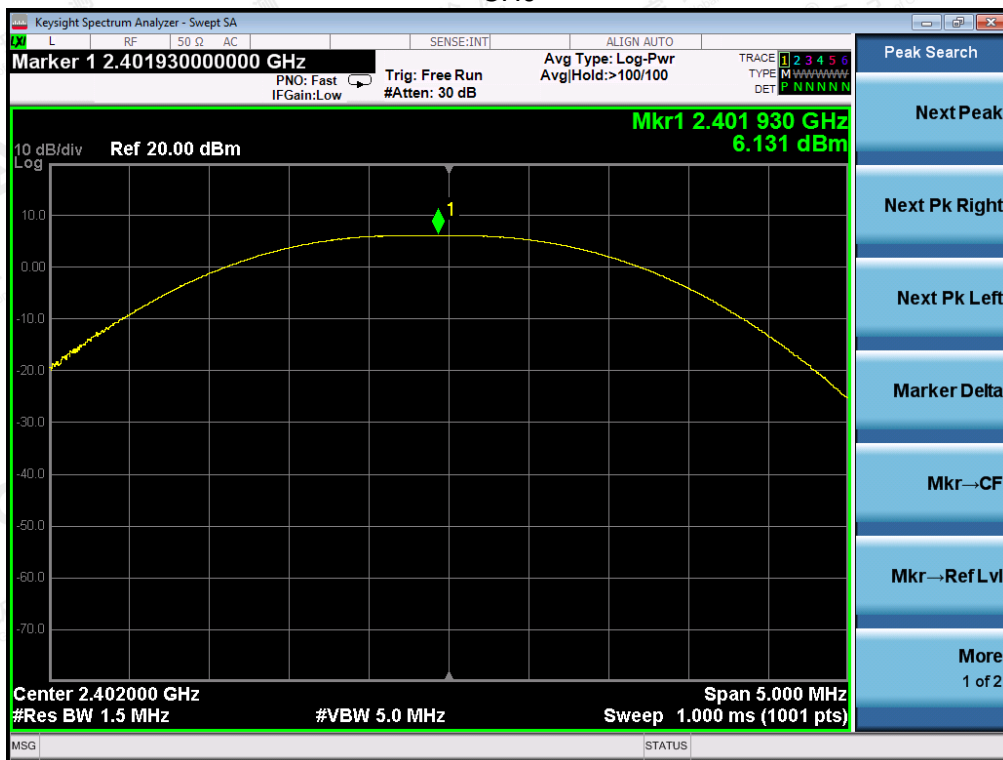

The results shown in this test report refer only to the sample(s) tested unless otherwise stated and the sample(s) are retained for 30 days only. The document is issued by AGC, this document cannot be reproduced except in full with our prior written permission. The more details and the authenticity of the report will be confirmed at <http://www.agc-cert.com>.

CH19



CH39

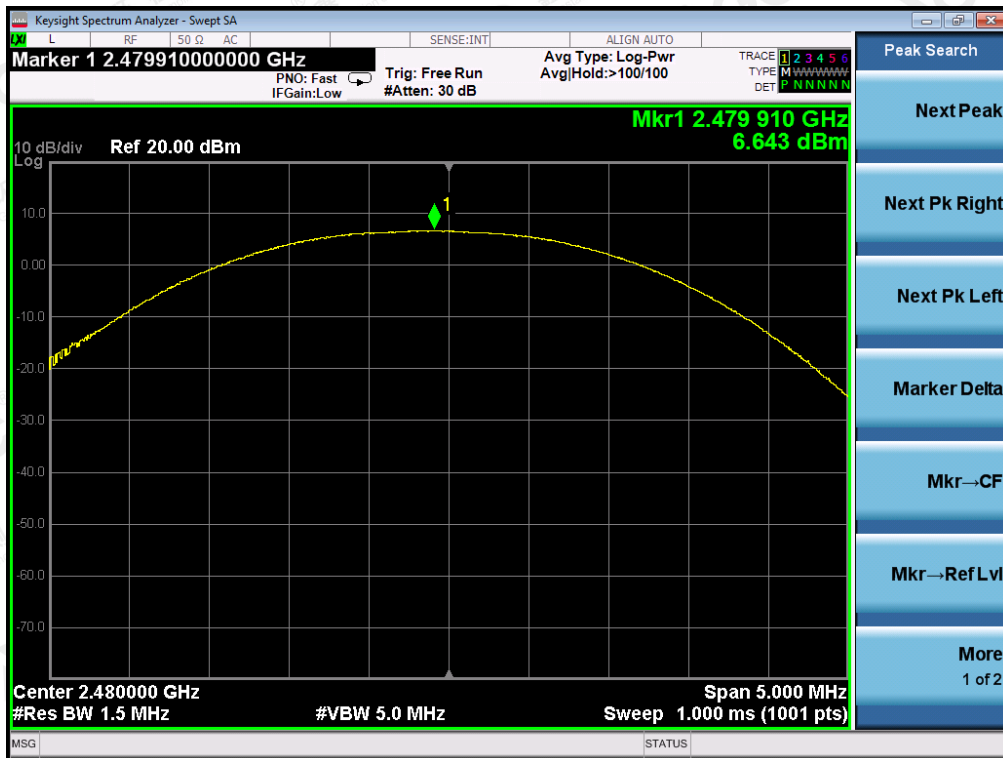

The results shown in this test report refer only to the sample(s) tested unless otherwise stated and the sample(s) are retained for 30 days only. The document is issued by AGC, this document cannot be reproduced except in full with our prior written permission. The more details and the authenticity of the report will be confirmed at <http://www.agc-cert.com>.



## 8. 6 DB BANDWIDTH

### 8.1. MEASUREMENT PROCEDURE

1. Connect EUT RF output port to the Spectrum Analyzer through an RF attenuator
2. Set the EUT Work on the top, the middle and the bottom operation frequency individually.
3. Set SPA Centre Frequency = Operation Frequency, RBW= 100 KHz, VBW $\geq$ 3 $\times$ RBW.
4. Set SPA Trace 1 Max hold, then View.

**Note:** The EUT was tested according to ANSI C63.10 for compliance to FCC PART 15.247 requirements.

### 8.2. TEST SET-UP (BLOCK DIAGRAM OF CONFIGURATION)

The same as described in section 7.2.

### 8.3. LIMITS AND MEASUREMENT RESULTS

LIMITS AND MEASUREMENT RESULT			
Applicable Limits	Applicable Limits		
	Test Data (kHz)		Criteria
>500KHZ	Low Channel	695.5	PASS
	Middle Channel	679.7	PASS
	High Channel	669.6	PASS

TEST PLOT OF BANDWIDTH FOR LOW CHANNEL



The results shown in this test report refer only to the sample(s) tested unless otherwise stated and the sample(s) are retained for 30 days only. The document is issued by AGC, this document cannot be reproduced except in full with our prior written permission. The more details and the authenticity of the report will be confirmed at <http://www.agc-cert.com>.

TEST PLOT OF BANDWIDTH FOR MIDDLE CHANNEL

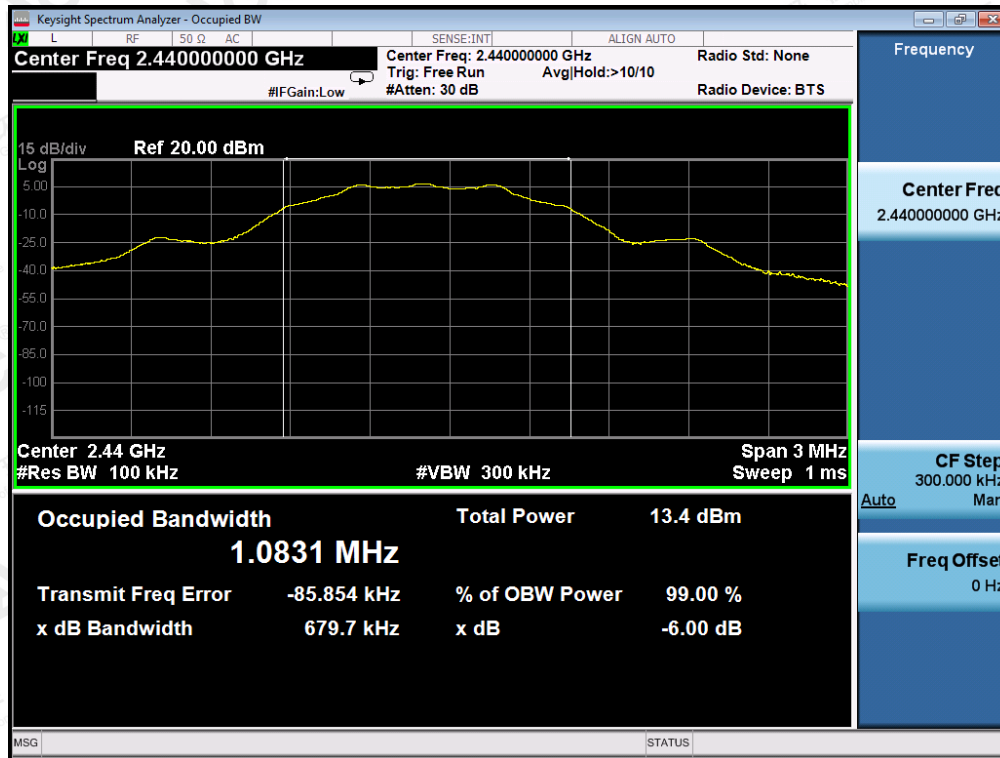

TEST PLOT OF BANDWIDTH FOR HIGH CHANNEL



The results shown in this test report refer only to the sample(s) tested unless otherwise stated and the sample(s) are retained for 30 days only. The document is issued by AGC, this document cannot be reproduced except in full with our prior written permission. The more details and the authenticity of the report will be confirmed at <http://www.agc-cert.com>.

## 9. CONDUCTED SPURIOUS EMISSION

### 9.1. MEASUREMENT PROCEDURE

1. Connect EUT RF output port to the Spectrum Analyzer through an RF attenuator
2. Set the EUT Work on the top, the middle and the bottom operation frequency individually.
3. Set SPA Trace 1 Max hold, then View.

**Note:** The EUT was tested according to ANSI C63.10 for compliance to FCC PART 15.247 requirements.

### 9.2. TEST SET-UP (BLOCK DIAGRAM OF CONFIGURATION)

The same as described in section 7.2.

### 9.3. MEASUREMENT EQUIPMENT USED

The same as described in section 6.

### 9.4. LIMITS AND MEASUREMENT RESULT

LIMITS AND MEASUREMENT RESULT		
Applicable Limits	Measurement Result	
	Test Data	Criteria
In any 100 KHz Bandwidth Outside the frequency band in which the spread spectrum intentional radiator is operating, the radio frequency power that is produce by the intentional radiator shall be at least 20 dB below that in 100KHz bandwidth within the band that contains the highest level of the desired power.	At least -20dBc than the reference level	PASS PASS

The results shown in this test report refer only to the sample(s) tested unless otherwise stated and the sample(s) are retained for 30 days only. The document is issued by AGC, this document cannot be reproduced except in full with our prior written permission. The more details and the authenticity of the report will be confirmed at <http://www.agc-cert.com>.



**TEST RESULT FOR ENTIRE FREQUENCY RANGE  
GFSK MODULATION IN LOW CHANNEL**

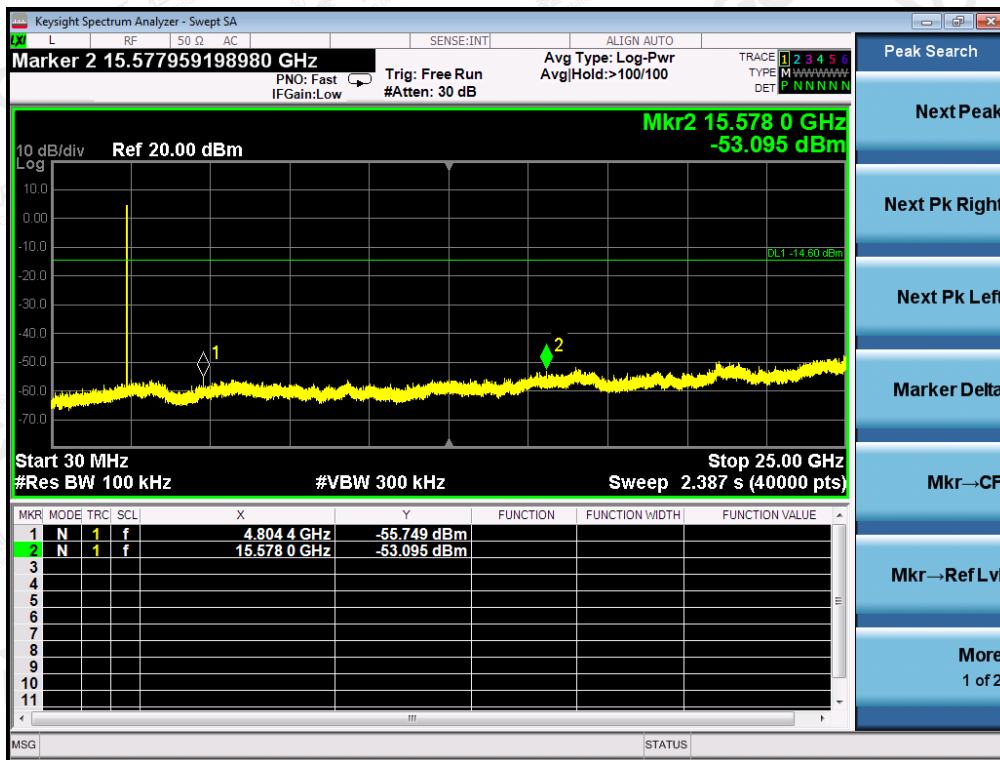

The results shown in this test report refer only to the sample(s) tested unless otherwise stated and the sample(s) are retained for 30 days only. The document is issued by AGC, this document cannot be reproduced except in full with our prior written permission. The more details and the authenticity of the report will be confirmed at <http://www.agc-cert.com>.

GFSK MODULATION IN MIDDLE CHANNEL

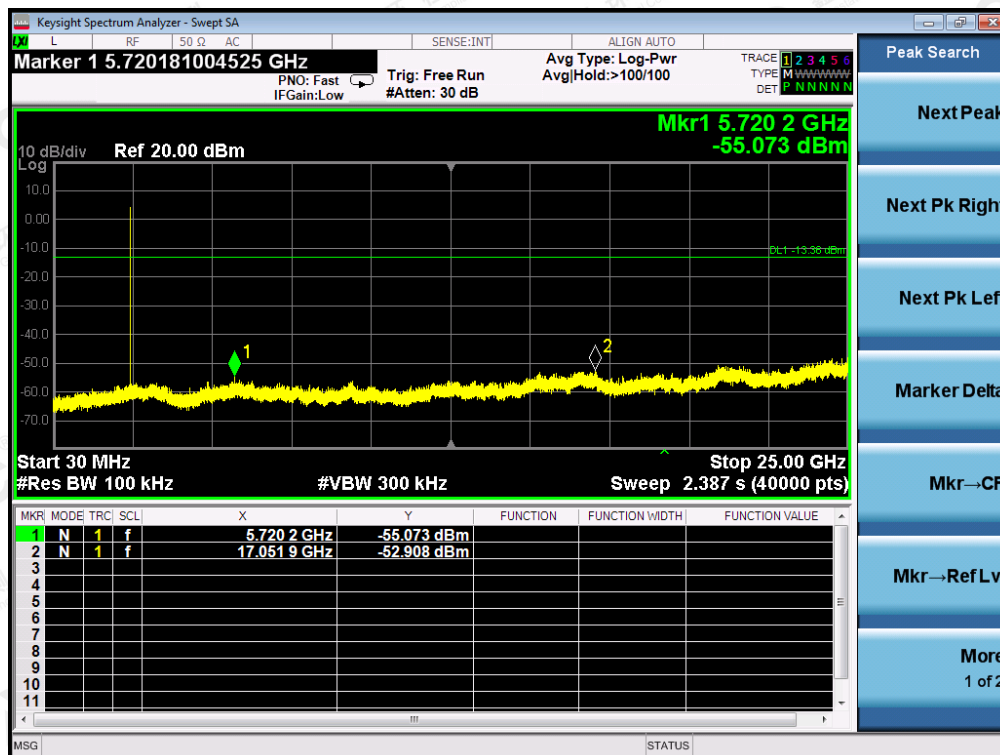

The results shown in this test report refer only to the sample(s) tested unless otherwise stated and the sample(s) are retained for 30 days only. The document is issued by AGC, this document cannot be reproduced except in full with our prior written permission. The more details and the authenticity of the report will be confirmed at <http://www.agc-cert.com>.

GFSK MODULATION IN HIGH CHANNEL

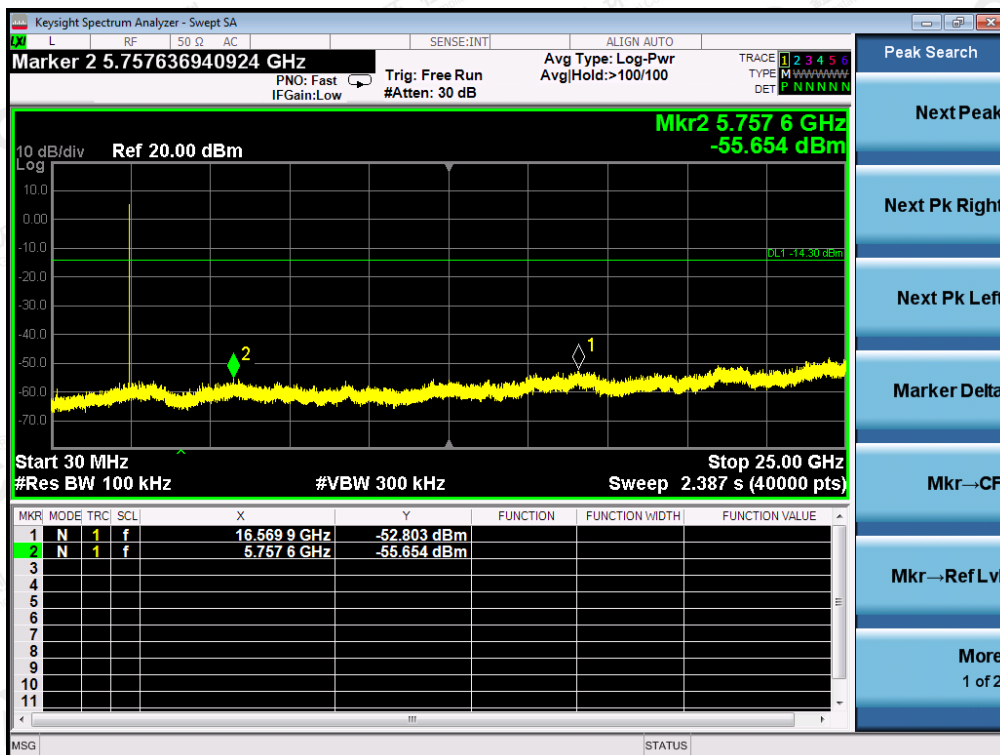

Note: The peak emissions without marker on the above plots are fundamental wave and need not to compare with the limit.

The results shown in this test report refer only to the sample(s) tested unless otherwise stated and the sample(s) are retained for 30 days only. The document is issued by AGC, this document cannot be reproduced except in full with our prior written permission. The more details and the authenticity of the report will be confirmed at <http://www.agc-cert.com>.



**TEST RESULT FOR BAND EDGE  
GFSK MODULATION IN LOW CHANNEL**

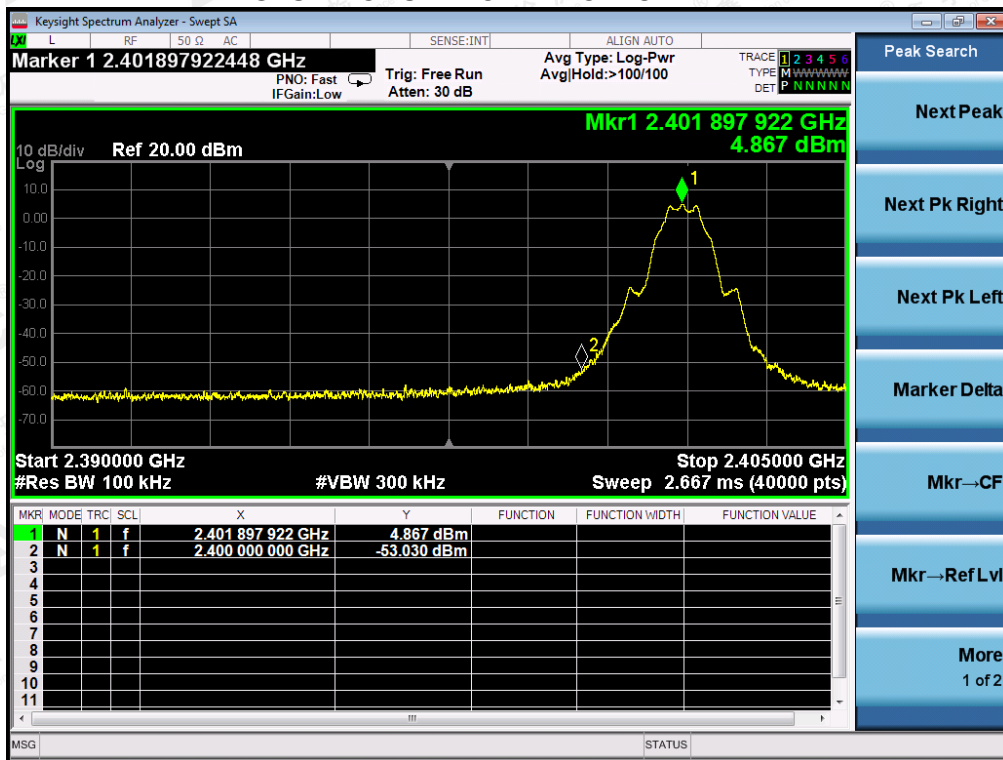

**GFSK MODULATION IN HIGH CHANNEL**

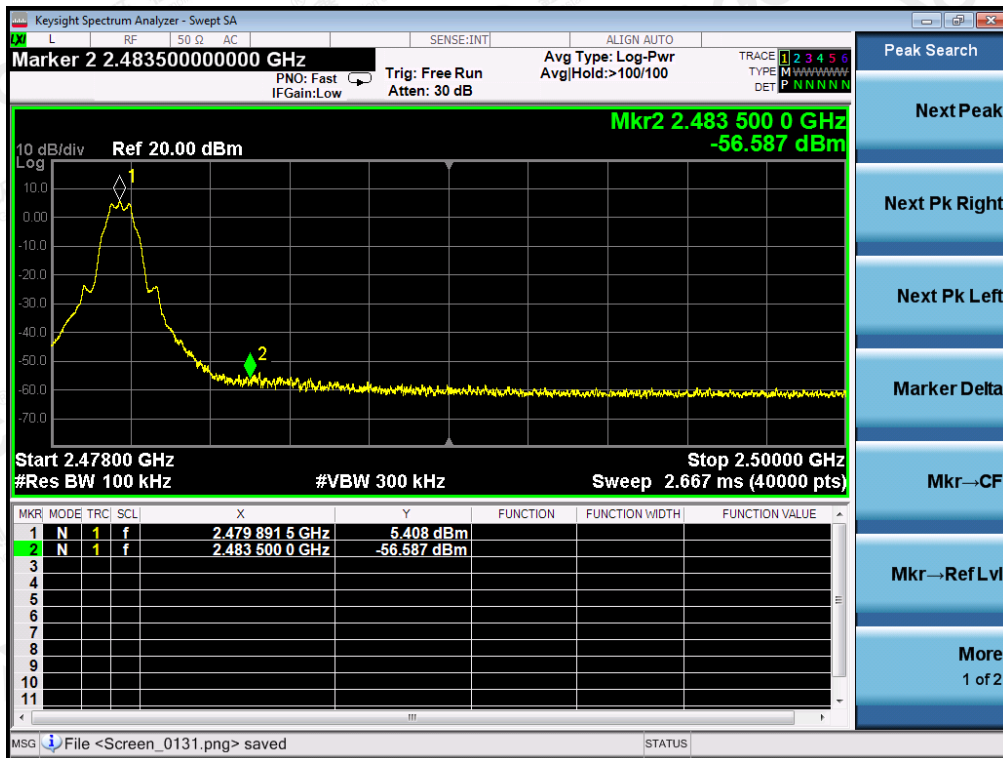

The results shown in this test report refer only to the sample(s) tested unless otherwise stated and the sample(s) are retained for 30 days only. The document is issued by AGC, this document cannot be reproduced except in full with our prior written permission. The more details and the authenticity of the report will be confirmed at <http://www.agc-cert.com>.

## 10. MAXIMUM CONDUCTED OUTPUT POWER SPECTRAL DENSITY

### 10.1 MEASUREMENT PROCEDURE

- (1). Connect EUT RF output port to the Spectrum Analyzer through an RF attenuator
- (2). Set the EUT Work on the top, the middle and the bottom operation frequency individually.
- (3). Set SPA Trace 1 Max hold, then View.

Note: The method of PKPSD in the KDB 558074 item 10.2 was used in this testing.

### 10.2 TEST SET-UP (BLOCK DIAGRAM OF CONFIGURATION)

Refer To Section 7.2.

### 10.3 MEASUREMENT EQUIPMENT USED

Refer To Section 6.

### 10.4 LIMITS AND MEASUREMENT RESULT

Channel No.	PSD (dBm/3kHz)	Limit (dBm/3kHz)	Result
Low Channel	-10.441	8	Pass
Middle Channel	-10.542	8	Pass
High Channel	-7.910	8	Pass

TEST PLOT OF SPECTRAL DENSITY FOR LOW CHANNEL



The results shown in this test report refer only to the sample(s) tested unless otherwise stated and the sample(s) are retained for 30 days only. The document is issued by AGC, this document cannot be reproduced except in full with our prior written permission. The more details and the authenticity of the report will be confirmed at <http://www.agc-cert.com>.

TEST PLOT OF SPECTRAL DENSITY FOR MIDDLE CHANNEL

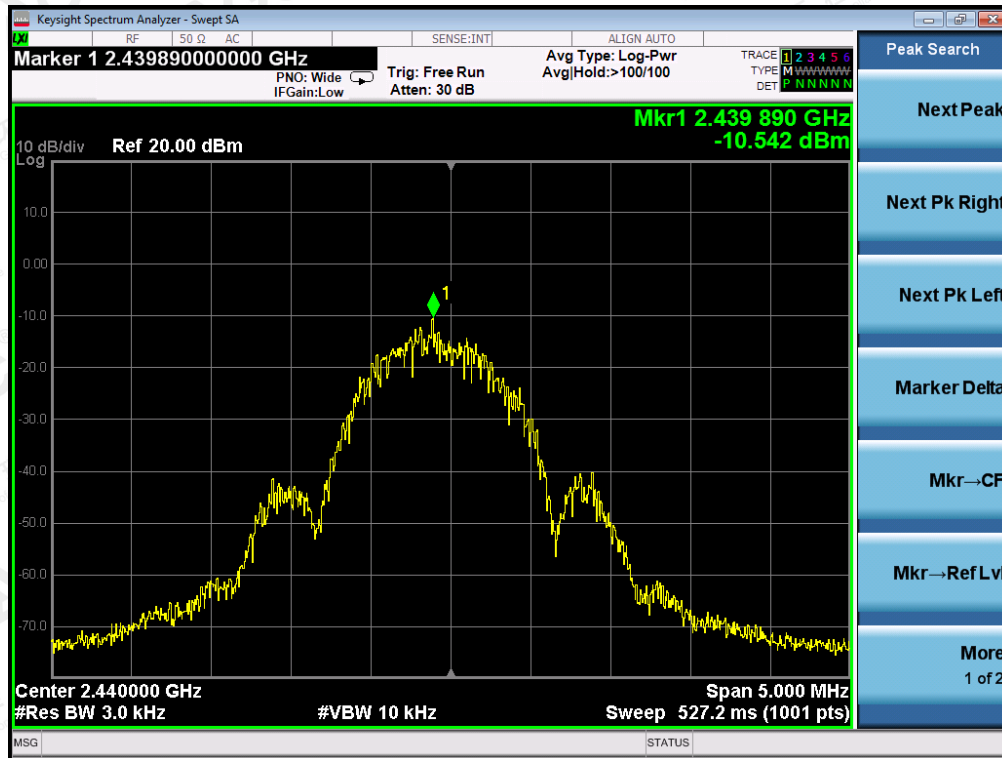

TEST PLOT OF SPECTRAL DENSITY FOR HIGH CHANNEL

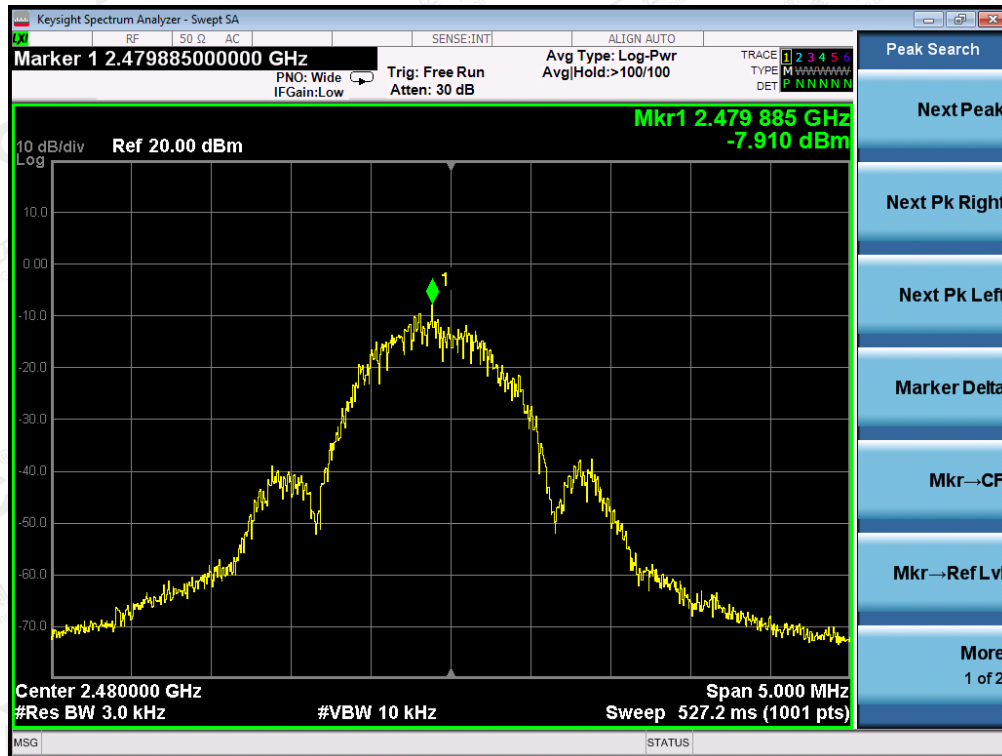

The results shown in this test report refer only to the sample(s) tested unless otherwise stated and the sample(s) are retained for 30 days only. The document is issued by AGC, this document cannot be reproduced except in full with our prior written permission. The more details and the authenticity of the report will be confirmed at <http://www.agc-cert.com>.



## 11. RADIATED EMISSION

### 11.1. MEASUREMENT PROCEDURE

1. The EUT was placed on the top of the turntable 0.8 or 1.5 meter above ground. The phase center of the receiving antenna mounted on the top of a height-variable antenna tower was placed 3 meters far away from the turntable.
2. Power on the EUT and all the supporting units. The turntable was rotated by 360 degrees to determine the position of the highest radiation.
3. The height of the broadband receiving antenna was varied between one meter and four meters above ground to find the maximum emissions field strength of both horizontal and vertical polarization.
4. For each suspected emissions, the antenna tower was scan (from 1 M to 4 M) and then the turntable was rotated (from 0 degree to 360 degrees) to find the maximum reading.
5. Set the test-receiver system to Peak or CISPR quasi-peak Detect Function with specified bandwidth under Maximum Hold Mode.
6. For emissions above 1GHz, use 1MHz RBW and 3MHz VBW for peak reading. Place the measurement antenna away from each area of the EUT determined to be a source of emissions at the specified measurement distance, while keeping the measurement antenna aimed at the source of emissions at each frequency of significant emissions, with polarization oriented for maximum response. The measurement antenna may have to be higher or lower than the EUT, depending on the radiation pattern of the emission and staying aimed at the emission source for receiving the maximum signal. The final measurement antenna elevation shall be that which maximizes the emissions. The measurement antenna elevation for maximum emissions shall be restricted to a range of heights of from 1 m to 4 m above the ground or reference ground plane.
7. When the radiated emissions limits are expressed in terms of the average value of the emissions, and pulsed operation is employed, the measurement field strength shall be determined by averaging over one complete pulse train, including blanking intervals, as long as the pulse train does not exceed 0.1 seconds. As an alternative (provided the transmitter operates for longer than 0.1 seconds) or in cases where the pulse train exceeds 0.1 seconds, the measured field strength shall be determined from the average absolute voltage during a 0.1 second interval during which the field strength is at its maximum values.
8. If the emissions level of the EUT in peak mode was 3 dB lower than the average limit specified, then testing will be stopped and peak values of EUT will be reported, otherwise, the emissions which do not have 3 dB margin will be repeated one by one using the quasi-peak method for below 1GHz.
9. For testing above 1GHz, the emissions level of the EUT in peak mode was lower than average limit (that means the emissions level in peak mode also complies with the limit in average mode), then testing will be stopped and peak values of EUT will be reported, otherwise, the emissions will be measured in average mode again and reported.
10. In case the emission is lower than 30MHz, loop antenna has to be used for measurement and the recorded data should be QP measured by receiver. High - Low scan is not required in this case.

The results shown in this test report refer only to the sample(s) tested unless otherwise stated and the sample(s) are retained for 30 days only. The document is issued by AGC, this document cannot be reproduced except in full with our prior written permission. The more details and the authenticity of the report will be confirmed at <http://www.agc-cert.com>.

**11.2. TEST SETUP**

Radiated Emission Test-Setup Frequency Below 30MHz

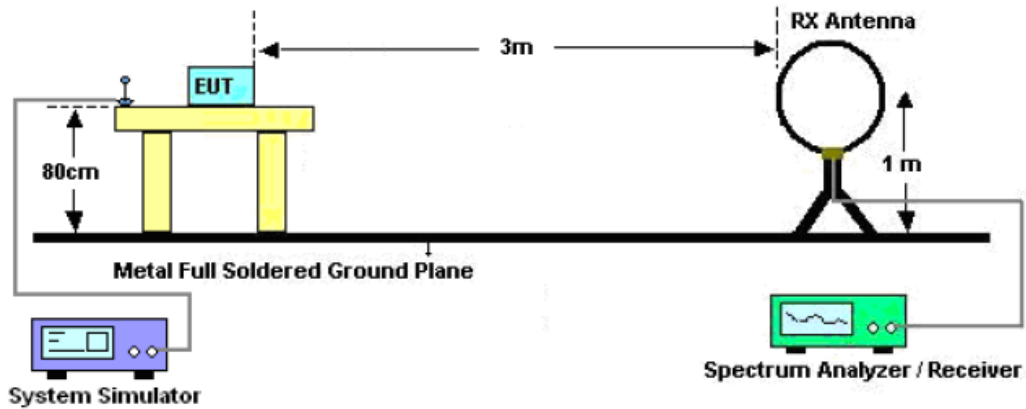

RADIATED EMISSION TEST SETUP 30MHz-1000MHz

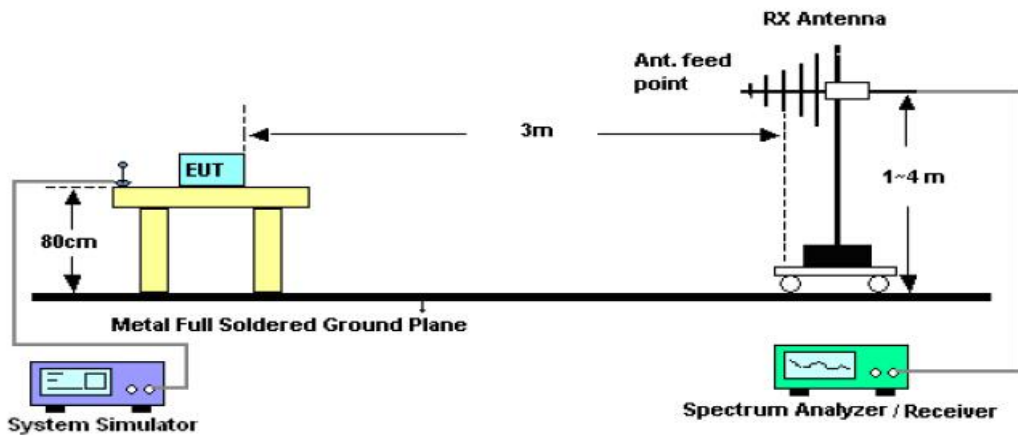

RADIATED EMISSION TEST SETUP ABOVE 1000MHz

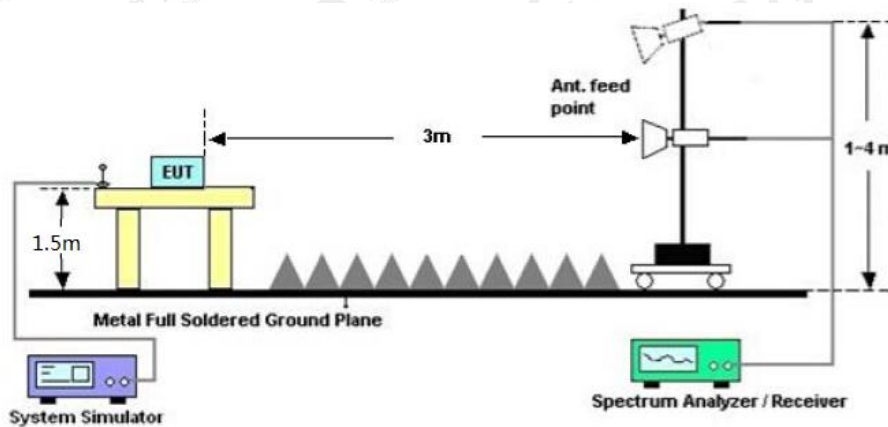

The results shown in this test report refer only to the sample(s) tested unless otherwise stated and the sample(s) are retained for 30 days only. The document is issued by AGC, this document cannot be reproduced except in full with our prior written permission. The more details and the authenticity of the report will be confirmed at <http://www.agc-cert.com>.



### 11.3. LIMITS AND MEASUREMENT RESULT

15.209 Limit in the below table has to be followed

Frequencies (MHz)	Field Strength (micorvolts/meter)	Measurement Distance (meters)
0.009~0.490	2400/F(KHz)	300
0.490~1.705	24000/F(KHz)	30
1.705~30.0	30	30
30~88	100	3
88~216	150	3
216~960	200	3
Above 960	500	3

Note: All modes were tested For restricted band radiated emission, the test records reported below are the worst result compared to other modes.

### 11.4. TEST RESULT

#### RADIATED EMISSION BELOW 30MHZ

No emission found between lowest internal used/generated frequencies to 30MHz.

The results shown in this test report refer only to the sample(s) tested unless otherwise stated and the sample(s) are retained for 30 days only. The document is issued by AGC, this document cannot be reproduced except in full with our prior written permission. The more details and the authenticity of the report will be confirmed at <http://www.agc-cert.com>.



**RADIATED EMISSION BELOW 1GHZ**

<b>EUT</b>	DX6R	<b>Model Name</b>	DX6R
<b>Temperature</b>	25° C	<b>Relative Humidity</b>	55.4%
<b>Pressure</b>	960hPa	<b>Test Voltage</b>	Normal Voltage
<b>Test Mode</b>	Mode 4	<b>Antenna</b>	Horizontal

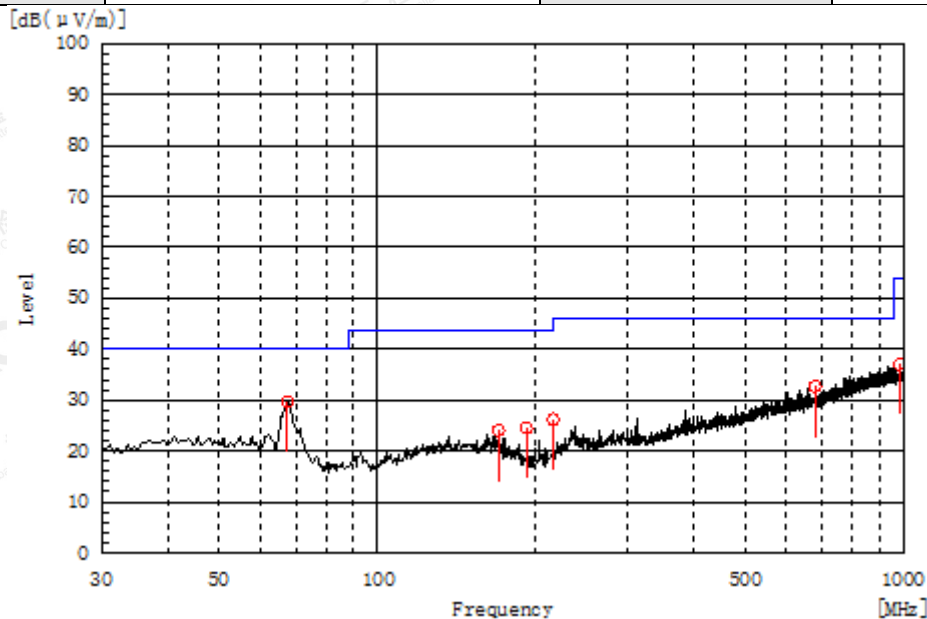

Frequency MHz	Polarization	Reading dB(uV)	Factor dB (1/m)	Level dB(uV/m) PK	Limit dB(uV/m) QP	Margin dB	Pass/Fail	Height cm	Angle deg
67.345	H	14.7	15.1	29.8	40.0	10.2	Pass	150.0	218.3
169.680	H	8.1	15.9	24.0	43.5	19.5	Pass	200.0	70.9
191.990	H	10.8	13.7	24.5	43.5	19.0	Pass	150.0	145.5
215.755	H	11.9	14.3	26.2	43.5	17.3	Pass	150.0	72.5
679.415	H	6.7	26.0	32.7	46.0	13.3	Pass	200.0	217.7
984.480	H	6.0	31.0	37.0	54.0	17.0	Pass	100.0	16.8

**RESULT: PASS**

The results shown in this test report refer only to the sample(s) tested unless otherwise stated and the sample(s) are retained for 30 days only. The document is issued by AGC, this document cannot be reproduced except in full with our prior written permission. The more details and the authenticity of the report will be confirmed at <http://www.agc-cert.com>.

EUT	DX6R	Model Name	DX6R
Temperature	25° C	Relative Humidity	55.4%
Pressure	960hPa	Test Voltage	Normal Voltage
Test Mode	Mode 4	Antenna	Vertical

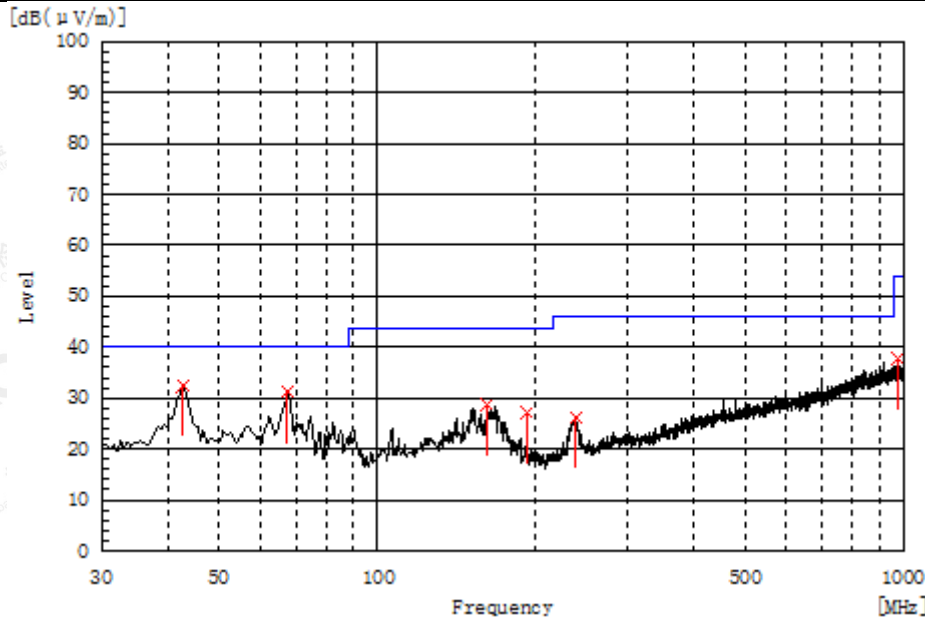

Frequency MHz	Polarization	Reading dB(uV)	Factor dB (1/m)	Level dB(uV/m) PK	Limit dB(uV/m) QP	Margin dB	Pass/Fail	Height cm	Angle deg
42.610	V	15.0	17.4	32.4	40.0	7.6	Pass	100.0	325.7
67.345	V	16.1	15.1	31.2	40.0	8.8	Pass	150.0	107.9
161.435	V	12.1	16.6	28.7	43.5	14.8	Pass	150.0	71.5
191.990	V	13.4	13.7	27.1	43.5	16.4	Pass	200.0	341.0
238.065	V	9.9	16.2	26.1	46.0	19.9	Pass	200.0	52.3
974.295	V	6.9	30.9	37.8	54.0	16.2	Pass	150.0	356.5

**RESULT: PASS**

**Note:**

1. Factor=Antenna Factor + Cable loss, Margin=Measurement-Limit.
2. All test modes had been tested. The mode 4 is the worst case and recorded in the report.

The results shown in this test report refer only to the sample(s) tested unless otherwise stated and the sample(s) are retained for 30 days only. The document is issued by AGC, this document cannot be reproduced except in full with our prior written permission. The more details and the authenticity of the report will be confirmed at <http://www.agc-cert.com>.

**RADIATED EMISSION ABOVE 1GHZ**

<b>EUT</b>	DX6R	<b>Model Name</b>	DX6R
<b>Temperature</b>	25° C	<b>Relative Humidity</b>	55.4%
<b>Pressure</b>	960hPa	<b>Test Voltage</b>	Normal Voltage
<b>Test Mode</b>	Mode 1	<b>Antenna</b>	Horizontal

Frequency (MHz)	Meter Reading (dB $\mu$ V)	Factor (dB)	Emission Level (dB $\mu$ V/m)	Limits (dB $\mu$ V/m)	Margin (dB)	Value Type
4804.011	46.43	7.12	53.55	74	-20.45	peak
4804.011	41.65	7.12	48.77	54	-5.23	AVG
7206.022	42.18	9.84	52.02	74	-21.98	peak
7206.022	36.21	9.84	46.05	54	-7.95	AVG

Remark:

Factor = Antenna Factor + Cable Loss – Pre-amplifier.

<b>EUT</b>	DX6R	<b>Model Name</b>	DX6R
<b>Temperature</b>	25° C	<b>Relative Humidity</b>	55.4%
<b>Pressure</b>	960hPa	<b>Test Voltage</b>	Normal Voltage
<b>Test Mode</b>	Mode 1	<b>Antenna</b>	Vertical

Frequency (MHz)	Meter Reading (dB $\mu$ V)	Factor (dB)	Emission Level (dB $\mu$ V/m)	Limits (dB $\mu$ V/m)	Margin (dB)	Value Type
4804.011	43.79	7.12	50.91	74	-23.09	peak
4804.011	40.83	7.12	47.95	54	-6.05	AVG
7206.022	41.37	9.84	51.21	74	-22.79	peak
7206.022	36.28	9.84	46.12	54	-7.88	AVG

Remark:

Factor = Antenna Factor + Cable Loss – Pre-amplifier.

The results shown in this test report refer only to the sample(s) tested unless otherwise stated and the sample(s) are retained for 30 days only. The document is issued by AGC, this document cannot be reproduced except in full with our prior written permission. The more details and the authenticity of the report will be confirmed at <http://www.agc-cert.com>.



<b>EUT</b>	DX6R	<b>Model Name</b>	DX6R
<b>Temperature</b>	25° C	<b>Relative Humidity</b>	55.4%
<b>Pressure</b>	960hPa	<b>Test Voltage</b>	Normal Voltage
<b>Test Mode</b>	Mode 2	<b>Antenna</b>	Horizontal

Frequency (MHz)	Meter Reading (dBμV)	Factor (dB)	Emission Level (dBμV/m)	Limits (dBμV/m)	Margin (dB)	Value Type
4880.005	45.53	7.12	52.65	74	-21.35	peak
4880.005	41.88	7.12	49	54	-5	AVG
7320.140	40.69	9.84	50.53	74	-23.47	peak
7320.140	34.84	9.84	44.68	54	-9.32	AVG

Remark:

Factor = Antenna Factor + Cable Loss – Pre-amplifier.

<b>EUT</b>	DX6R	<b>Model Name</b>	DX6R
<b>Temperature</b>	25° C	<b>Relative Humidity</b>	55.4%
<b>Pressure</b>	960hPa	<b>Test Voltage</b>	Normal Voltage
<b>Test Mode</b>	Mode 2	<b>Antenna</b>	Vertical

Frequency (MHz)	Meter Reading (dBμV)	Factor (dB)	Emission Level (dBμV/m)	Limits (dBμV/m)	Margin (dB)	Value Type
4880.050	43.23	7.12	50.35	74	-23.65	peak
4880.050	38.81	7.12	45.93	54	-8.07	AVG
7320.080	40.58	9.84	50.42	74	-23.58	peak
7320.080	35.47	9.84	45.31	54	-8.69	AVG

Remark:

Factor = Antenna Factor + Cable Loss – Pre-amplifier.

The results shown in this test report refer only to the sample(s) tested unless otherwise stated and the sample(s) are retained for 30 days only. The document is issued by AGC, this document cannot be reproduced except in full with our prior written permission. The more details and the authenticity of the report will be confirmed at <http://www.agc-cert.com>.

<b>EUT</b>	DX6R	<b>Model Name</b>	DX6R
<b>Temperature</b>	25° C	<b>Relative Humidity</b>	55.4%
<b>Pressure</b>	960hPa	<b>Test Voltage</b>	Normal Voltage
<b>Test Mode</b>	Mode 3	<b>Antenna</b>	Horizontal

Frequency (MHz)	Meter Reading (dBμV)	Factor (dB)	Emission Level (dBμV/m)	Limits (dBμV/m)	Margin (dB)	Value Type
4960.012	46.43	7.12	53.55	74	-20.45	peak
4960.012	42.88	7.12	50	54	-4	AVG
7440.027	43.34	9.84	53.18	74	-20.82	peak
7440.027	38.71	9.84	48.55	54	-5.45	AVG

Remark:  
 Factor = Antenna Factor + Cable Loss – Pre-amplifier.

<b>EUT</b>	DX6R	<b>Model Name</b>	DX6R
<b>Temperature</b>	25° C	<b>Relative Humidity</b>	55.4%
<b>Pressure</b>	960hPa	<b>Test Voltage</b>	Normal Voltage
<b>Test Mode</b>	Mode 3	<b>Antenna</b>	Vertical

Frequency (MHz)	Meter Reading (dBμV)	Factor (dB)	Emission Level (dBμV/m)	Limits (dBμV/m)	Margin (dB)	Value Type
4960.013	44.69	7.12	51.81	74	-22.19	peak
4960.013	40.82	7.12	47.94	54	-6.06	AVG
7440.027	41.37	9.84	51.21	74	-22.79	peak
7440.027	37.26	9.84	47.1	54	-6.9	AVG

Remark:  
 Factor = Antenna Factor + Cable Loss – Pre-amplifier.

**RESULT: PASS**

**Note:**

Other emissions from 1G to 25 GHz are considered as ambient noise. No recording in the test report.

Factor = Antenna Factor + Cable loss - Amplifier gain, Over=Measure-Limit.

The "Factor" value can be calculated automatically by software of measurement system.

The results shown in this test report refer only to the sample(s) tested unless otherwise stated and the sample(s) are retained for 30 days only. The document is issued by AGC, this document cannot be reproduced except in full with our prior written permission. The more details and the authenticity of the report will be confirmed at <http://www.agc-cert.com>.

**TEST RESULT FOR RESTRICTED BANDS REQUIREMENTS**

EUT	DX6R	Model Name	DX6R
Temperature	25° C	Relative Humidity	55.4%
Pressure	960hPa	Test Voltage	Normal Voltage
Test Mode	Mode 1	Antenna	Horizontal

PK

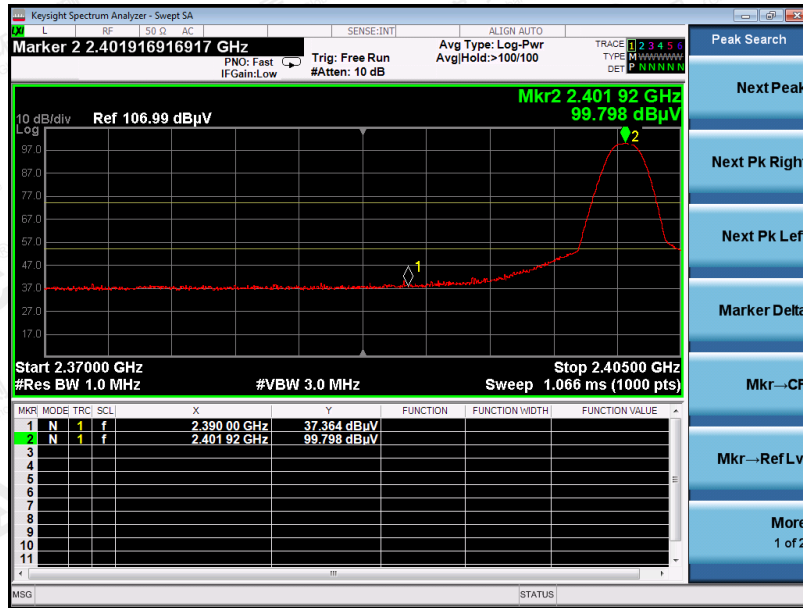

AV

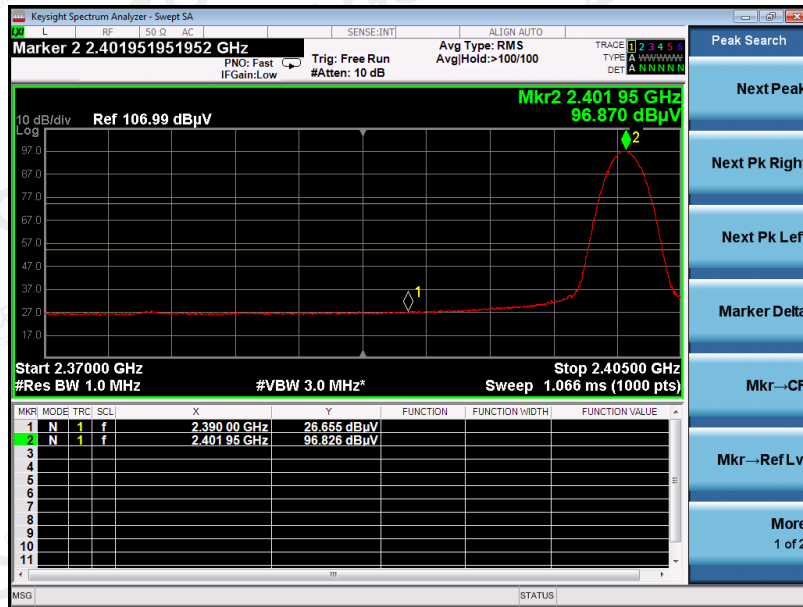

**RESULT: PASS**

The results shown in this test report refer only to the sample(s) tested unless otherwise stated and the sample(s) are retained for 30 days only. The document is issued by AGC, this document cannot be reproduced except in full with our prior written permission. The more details and the authenticity of the report will be confirmed at <http://www.agc-cert.com>.



EUT	DX6R	Model Name	DX6R
Temperature	25° C	Relative Humidity	55.4%
Pressure	960hPa	Test Voltage	Normal Voltage
Test Mode	Mode 1	Antenna	Vertical

PK

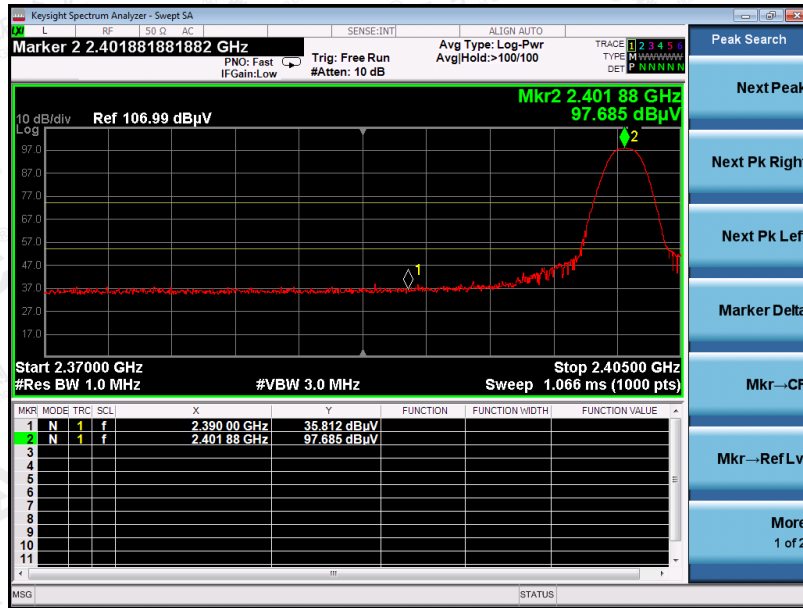

AV

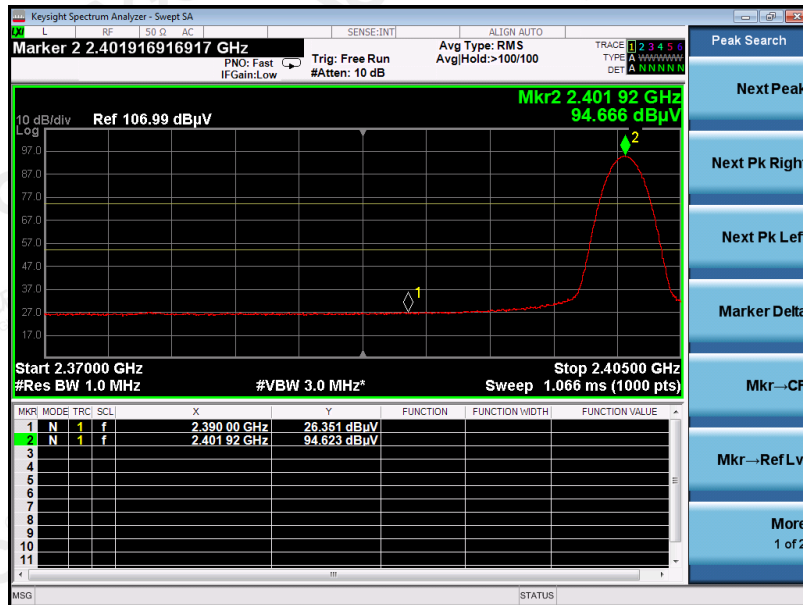

RESULT: PASS

The results shown in this test report refer only to the sample(s) tested unless otherwise stated and the sample(s) are retained for 30 days only. The document is issued by AGC, this document cannot be reproduced except in full with our prior written permission. The more details and the authenticity of the report will be confirmed at <http://www.agc-cert.com>.

EUT	DX6R	Model Name	DX6R
Temperature	25° C	Relative Humidity	55.4%
Pressure	960hPa	Test Voltage	Normal Voltage
Test Mode	Mode 3	Antenna	Horizontal

PK



AV



RESULT: PASS

The results shown in this test report refer only to the sample(s) tested unless otherwise stated and the sample(s) are retained for 30 days only. The document is issued by AGC, this document cannot be reproduced except in full with our prior written permission. The more details and the authenticity of the report will be confirmed at <http://www.agc-cert.com>.

EUT	DX6R	Model Name	DX6R
Temperature	25° C	Relative Humidity	55.4%
Pressure	960hPa	Test Voltage	Normal Voltage
Test Mode	Mode 3	Antenna	Vertical

PK



AV

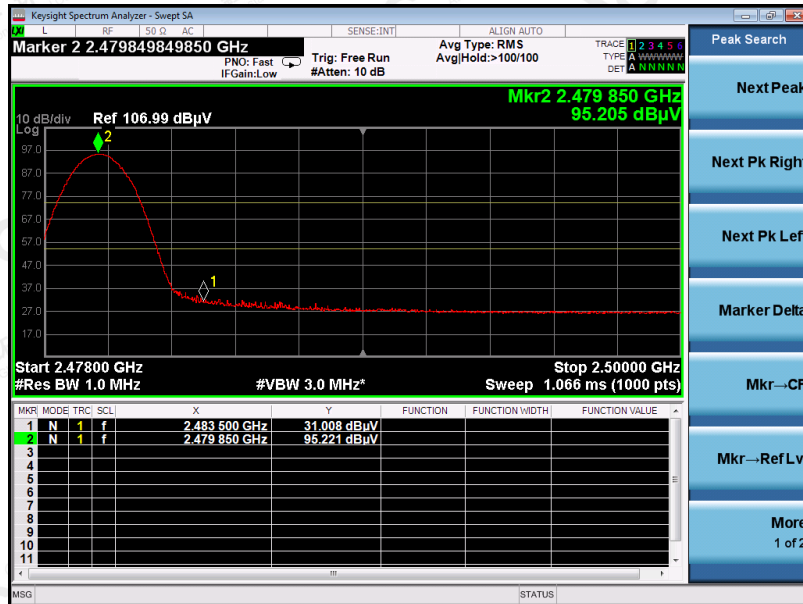

**RESULT: PASS**

**Note:** The factor had been edited in the "Input Correction" of the Spectrum Analyzer. So the Amplitude of test plots is equal to Reading level plus the Factor in dB. Use the A dB(μV) to represent the Amplitude. Use the F dB(μV/m) to represent the Field Strength. So A=F.

The results shown in this test report refer only to the sample(s) tested unless otherwise stated and the sample(s) are retained for 30 days only. The document is issued by AGC, this document cannot be reproduced except in full with our prior written permission. The more details and the authenticity of the report will be confirmed at <http://www.agc-cert.com>.



## 12. FCC LINE CONDUCTED EMISSION TEST

### 12.1. LIMITS OF LINE CONDUCTED EMISSION TEST

Frequency	Maximum RF Line Voltage	
	Q.P.( dBuV)	Average( dBuV)
150kHz~500kHz	66-56	56-46
500kHz~5MHz	56	46
5MHz~30MHz	60	50

Note:

1. The lower limit shall apply at the transition frequency.
2. The limit decreases linearly with the logarithm of the frequency in the range 0.15 MHz to 0.50 MHz.

### 12.2. BLOCK DIAGRAM OF LINE CONDUCTED EMISSION TEST

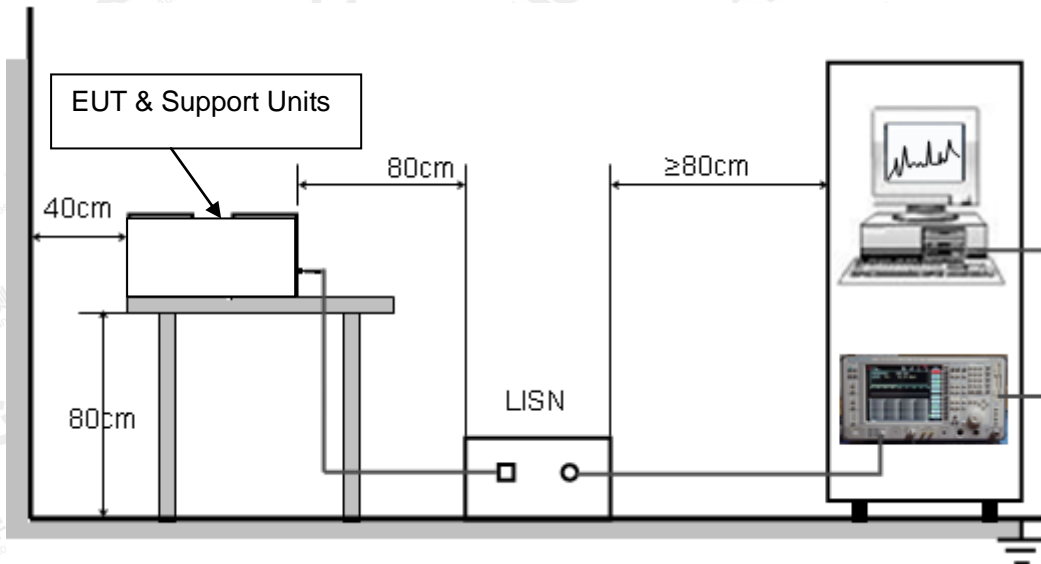

The results shown in this test report refer only to the sample(s) tested unless otherwise stated and the sample(s) are retained for 30 days only. The document is issued by AGC, this document cannot be reproduced except in full with our prior written permission. The more details and the authenticity of the report will be confirmed at <http://www.agc-cert.com>.

### 12.3. PRELIMINARY PROCEDURE OF LINE CONDUCTED EMISSION TEST

1. The equipment was set up as per the test configuration to simulate typical actual usage per the user's manual. When the EUT is a tabletop system, a wooden table with a height of 0.8 meters is used and is placed on the ground plane as per ANSI C63.10 (see Test Facility for the dimensions of the ground plane used). When the EUT is a floor-standing equipment, it is placed on the ground plane which has a 3-12 mm non-conductive covering to insulate the EUT from the ground plane.
2. Support equipment, if needed, was placed as per ANSI C63.10.
3. All I/O cables were positioned to simulate typical actual usage as per ANSI C63.10.
4. All support equipments received AC120V/60Hz power from a LISN, if any.
5. The EUT received DC5V charging voltage by adapter which received AC120V/60Hz power by a LISN..
6. The test program was started. Emissions were measured on each current carrying line of the EUT using a spectrum Analyzer / Receiver connected to the LISN powering the EUT. The LISN has two monitoring points: Line 1 (Hot Side) and Line 2 (Neutral Side). Two scans were taken: one with Line 1 connected to Analyzer / Receiver and Line 2 connected to a 50 ohm load; the second scan had Line 1 connected to a 50 ohm load and Line 2 connected to the Analyzer / Receiver.
7. Analyzer / Receiver scanned from 150 kHz to 30MHz for emissions in each of the test modes.
8. During the above scans, the emissions were maximized by cable manipulation.
9. The test mode(s) were scanned during the preliminary test.

Then, the EUT configuration and cable configuration of the above highest emission level were recorded for reference of final testing.

### 12.4. FINAL PROCEDURE OF LINE CONDUCTED EMISSION TEST

1. EUT and support equipment was set up on the test bench as per step 2 of the preliminary test.
2. A scan was taken on both power lines, Line 1 and Line 2, recording at least the six highest emissions. Emission frequency and amplitude were recorded into a computer in which correction factors were used to calculate the emission level and compare reading to the applicable limit. If EUT emission level was less -2dB to the A.V. limit in Peak mode, then the emission signal was re-checked using Q.P and Average detector.
3. The test data of the worst case condition(s) was reported on the Summary Data page.

The results shown in this test report refer only to the sample(s) tested unless otherwise stated and the sample(s) are retained for 30 days only. The document is issued by AGC, this document cannot be reproduced except in full with our prior written permission. The more details and the authenticity of the report will be confirmed at <http://www.agc-cert.com>.

**12.5. TEST RESULT OF LINE CONDUCTED EMISSION TEST**

Line Conducted Emission Test Line 1-L

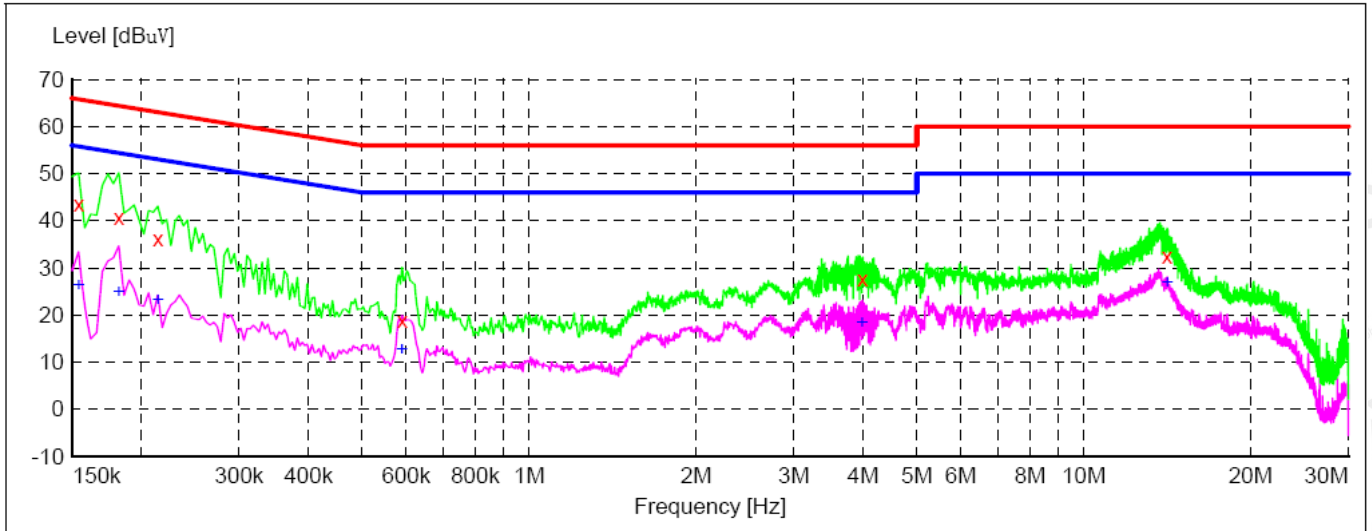

**MEASUREMENT RESULT: "TEST\_fin"**

Frequency MHz	Level dBuV	Transd dB	Limit dBuV	Margin dB	Detector	Line	PE
0.154000	43.60	10.0	66	22.2	QP	L1	FLO
0.182000	40.60	10.0	64	23.8	QP	L1	FLO
0.214000	36.10	10.1	63	26.9	QP	L1	FLO
0.590000	18.90	9.9	56	37.1	QP	L1	FLO
3.990000	27.80	10.1	56	28.2	QP	L1	FLO
14.130000	32.40	9.7	60	27.6	QP	L1	FLO

**MEASUREMENT RESULT: "TEST\_fin2"**

Frequency MHz	Level dBuV	Transd dB	Limit dBuV	Margin dB	Detector	Line	PE
0.154000	26.10	10.0	56	29.7	AV	L1	FLO
0.182000	24.80	10.0	54	29.6	AV	L1	FLO
0.214000	23.00	10.1	53	30.0	AV	L1	FLO
0.590000	12.60	9.9	46	33.4	AV	L1	FLO
3.986000	18.40	10.1	46	27.6	AV	L1	FLO
14.146000	26.70	9.6	50	23.3	AV	L1	FLO

The results shown in this test report refer only to the sample(s) tested unless otherwise stated and the sample(s) are retained for 30 days only. The document is issued by AGC, this document cannot be reproduced except in full with our prior written permission. The more details and the authenticity of the report will be confirmed at <http://www.agc-cert.com>.



Line Conducted Emission Test Line 2-N

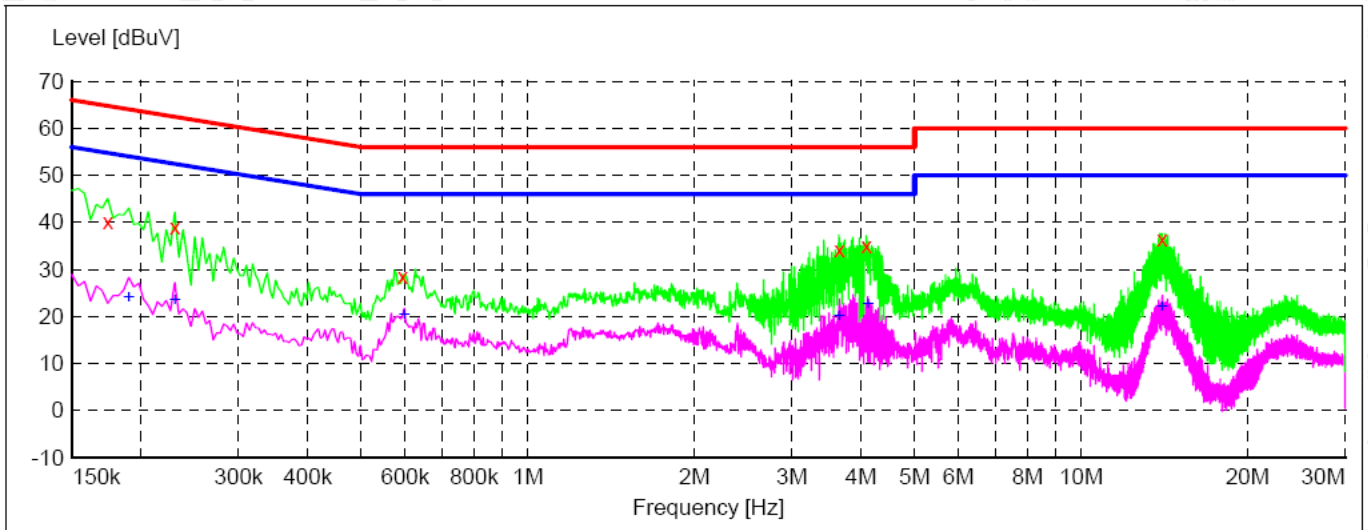

**MEASUREMENT RESULT: "TEST\_fin"**

Frequency MHz	Level dBuV	Transd dB	Limit dBuV	Margin dB	Detector	Line	PE
0.174000	40.10	20.3	65	24.7	QP	N	FLO
0.230000	39.00	20.2	62	23.4	QP	N	FLO
0.594000	28.50	20.0	56	27.5	QP	N	FLO
3.658000	34.30	19.8	56	21.7	QP	N	FLO
4.090000	34.90	19.9	56	21.1	QP	N	FLO
14.002000	36.50	19.9	60	23.5	QP	N	FLO

**MEASUREMENT RESULT: "TEST\_fin2"**

Frequency MHz	Level dBuV	Transd dB	Limit dBuV	Margin dB	Detector	Line	PE
0.190000	24.00	20.3	54	34.0	AV	N	FLO
0.230000	23.40	20.2	52	29.0	AV	N	FLO
0.598000	20.20	20.0	46	25.8	AV	N	FLO
3.658000	20.10	19.8	46	25.9	AV	N	FLO
4.118000	22.50	19.9	46	23.5	AV	N	FLO
14.002000	22.00	19.9	50	28.0	AV	N	FLO

**RESULT: PASS**

Note: All the test modes had been tested, the mode 1 was the worst case. Only the data of the worst case would be record in this test report.

The results shown in this test report refer only to the sample(s) tested unless otherwise stated and the sample(s) are retained for 30 days only. The document is issued by AGC, this document cannot be reproduced except in full with our prior written permission. The more details and the authenticity of the report will be confirmed at <http://www.agc-cert.com>.

**APPENDIX A: PHOTOGRAPHS OF TEST SETUP**  
**RADIATED EMISSION TEST SETUP BELOW 1GHZ**

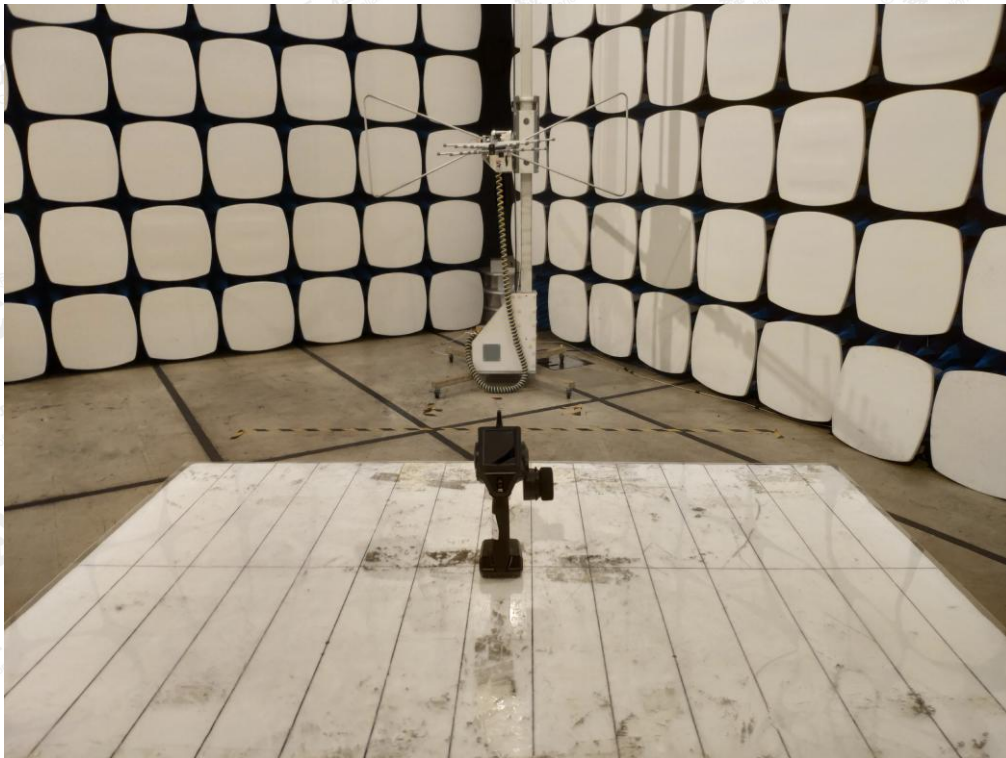

**RADIATED EMISSION TEST SETUP ABOVE 1GHZ**

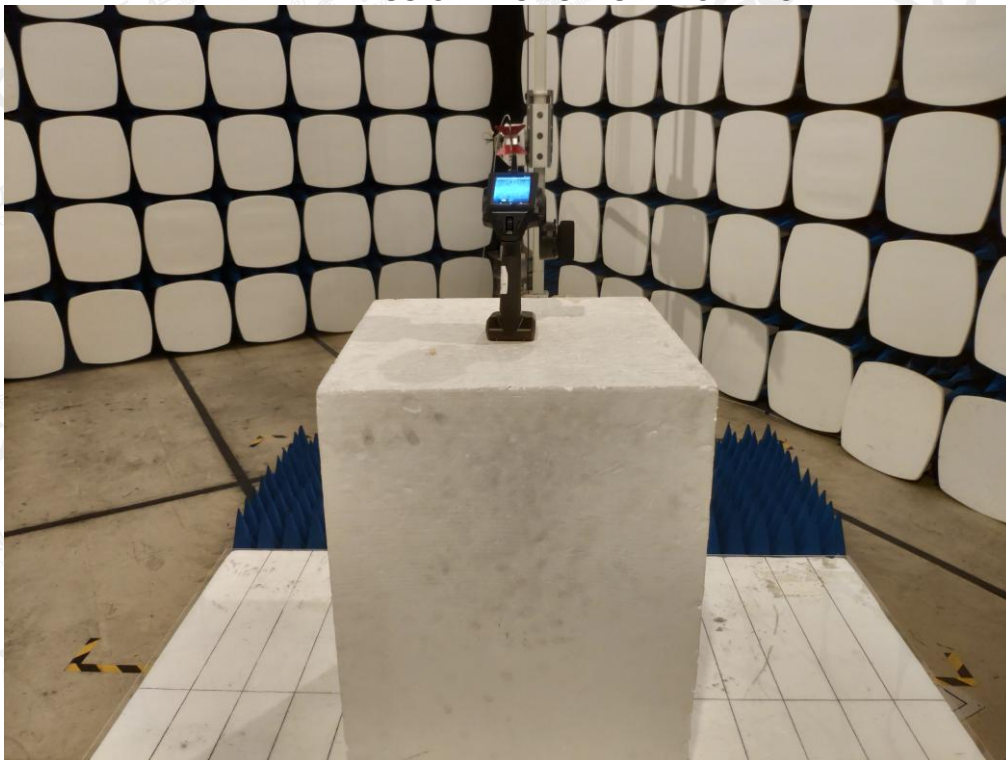

The results shown in this test report refer only to the sample(s) tested unless otherwise stated and the sample(s) are retained for 30 days only. The document is issued by AGC, this document cannot be reproduced except in full with our prior written permission. The more details and the authenticity of the report will be confirmed at <http://www.agc-cert.com>.



CONDUCTED EMISSION TEST SETUP



---END OF REPORT---

The results shown in this test report refer only to the sample(s) tested unless otherwise stated and the sample(s) are retained for 30 days only. The document is issued by AGC, this document cannot be reproduced except in full with our prior written permission. The more details and the authenticity of the report will be confirmed at <http://www.agc-cert.com>.