

Hobbyzone Duet RTF

# DUET™

Instruction Manual • Bedienungsanleitung • Manuel d'utilisation • Manuale di Istruzioni

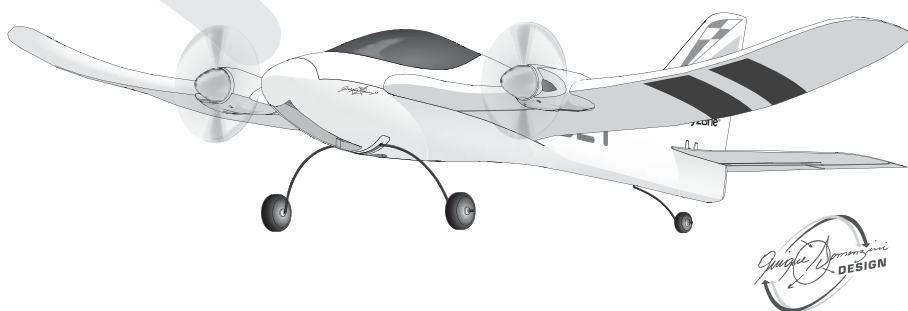

**RTF**  
READY-TO-FLY

hobbyzone®

**NOTICE**

All instructions, warranties and other collateral documents are subject to change at the sole discretion of Horizon Hobby, Inc. For up-to-date product literature, visit [www.horizonhobby.com](http://www.horizonhobby.com) and click on the support tab for this product.

**Meaning of Special Language:**

The following terms are used throughout the product literature to indicate various levels of potential harm when operating this product:

**NOTICE:** Procedures, which if not properly followed, create a possibility of physical property damage AND little or no possibility of injury.

**CAUTION:** Procedures, which if not properly followed, create the probability of physical property damage AND a possibility of serious injury.

**WARNING:** Procedures, which if not properly followed, create the probability of property damage, collateral damage, and serious injury OR create a high probability of superficial injury.

 **WARNING:** Read the ENTIRE instruction manual to become familiar with the features of the product before operating. Failure to operate the product correctly can result in damage to the product, personal property and cause serious injury.

This is a sophisticated hobby product. It must be operated with caution and common sense and requires some basic mechanical ability. Failure to operate this product in a safe and responsible manner could result in injury or damage to the product or other property. This product is not intended for use by children without direct adult supervision. Do not use with incompatible components or alter this product in any way outside of the instructions provided by Horizon Hobby, Inc. This manual contains instructions for safety, operation and maintenance. It is essential to read and follow all the instructions and warnings in the manual, prior to assembly, setup or use, in order to operate correctly and avoid damage or serious injury.

**Age Recommendation: Not for children under 14 years. This is not a toy.**

**Safety Precautions and Warnings**

- Always keep a safe distance in all directions around your model to avoid collisions or injury. This model is controlled by a radio signal subject to interference from many sources outside your control. Interference can cause momentary loss of control.
- Always operate your model in open spaces away from full-size vehicles, traffic and people.
- Always carefully follow the directions and warnings for this and any optional support equipment (chargers, rechargeable battery packs, etc.).
- Always keep all chemicals, small parts and anything electrical out of the reach of children.
- Always avoid water exposure to all equipment not specifically designed and protected for this purpose. Moisture causes damage to electronics.
- Never place any portion of the model in your mouth as it could cause serious injury or even death.
- Never operate your model with low transmitter batteries.
- Always keep aircraft in sight and under control.
- Always use fully charged batteries.
- Always keep the transmitter powered on while aircraft is powered.
- Always remove batteries before disassembly.
- Always keep moving parts clean.
- Always keep parts dry.
- Always let parts cool after use before touching.
- Always remove batteries after use.
- Always ensure failsafe is properly set before flying.
- Never operate aircraft with damaged wiring.
- Never touch moving parts.

## Included in the Box

To register your product online,  
go to [www.hobbyzonerc.com](http://www.hobbyzonerc.com)

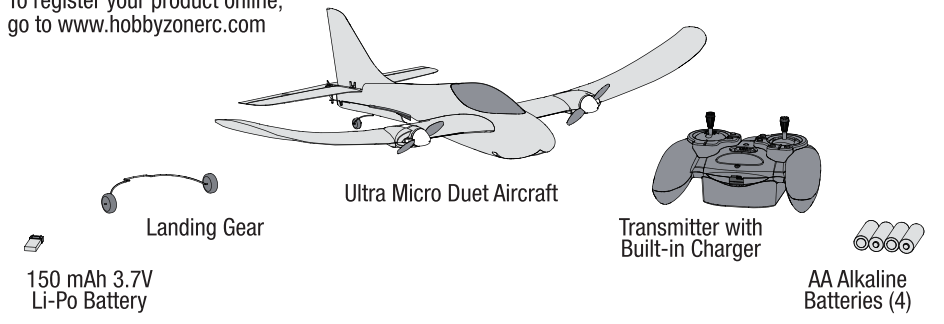

## Flying Tips

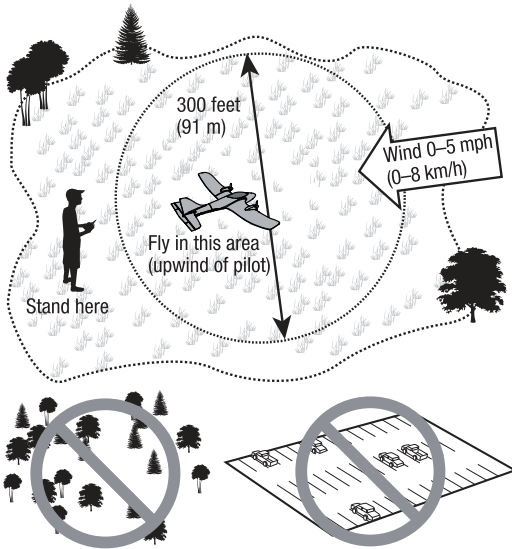

- Consult local laws and ordinances before choosing a location to fly your aircraft.
- Fly your aircraft outside in no greater than light winds.
- For indoor flight, fly the aircraft inside in a large gymnasium
- Keep your aircraft in plain sight and up wind. Do not exceed the 300 foot (91 m) radio range. If the connection is lost, the motors will power off and the aircraft will descend. Leave your transmitter powered on and move closer to your aircraft to regain control.
- Always avoid flying near houses, trees, wires and buildings.
- Always avoid flying in areas where there are many people, such as busy parks, schoolyards or soccer fields.

## Preflight Checklist

✓	
	1. Find a safe and open area.
	2. Charge flight battery.
	3. Install flight battery in aircraft.
	4. Perform Control Direction Test.

✓	
	5. Plan flight for flying field conditions.
	6. Set a flight timer for 5 minutes.
	7. Have fun!

## Transmitter

### Low Battery Alarm

When the battery voltage drops too low, an alarm sounds and the LED flashes. The batteries must be replaced immediately. If this happens while flying, land your aircraft as soon and as safely as possible.

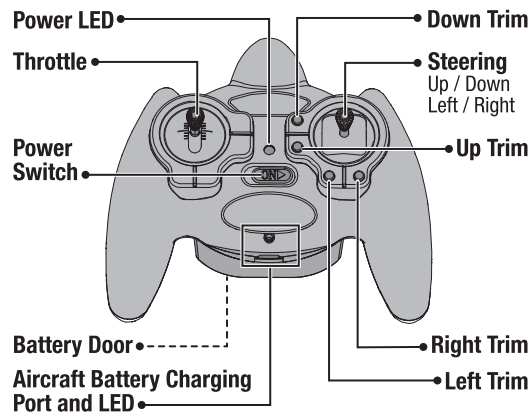

## Transmitter Batteries Installation

Remove the battery cover, install the four included batteries (noting proper polarity) and reinstall the battery cover.

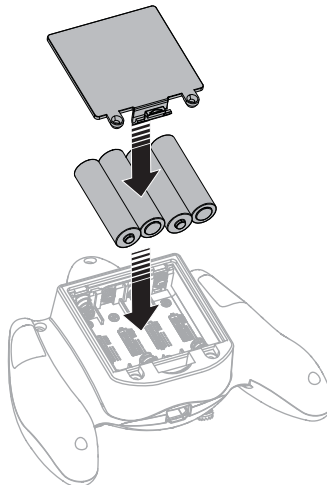
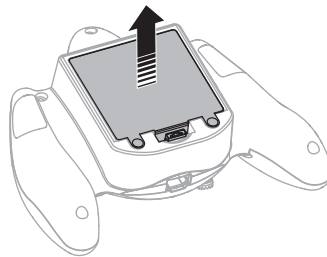

## Charging Warnings

The Duet transmitter has been designed to safely charge the included Li-Po battery.

**CAUTION:** All instructions and warnings must be followed exactly. Mishandling of Li-Po batteries can result in a fire, personal injury and/or property damage.

- By handling, charging or using the included Li-Po battery, you assume all risks associated with lithium batteries.
- If at any time the battery begins to balloon or swell, discontinue use immediately. If charging or discharging, discontinue and disconnect. Continuing to use, charge or discharge a battery that is ballooning or swelling can result in fire.
- Always store the battery at room temperature in a dry area for best results.
- Always transport or temporarily store the battery in a temperature range of 40–120° F. Do not store the battery or model in a car or direct sunlight. If stored in a hot car, the battery can be damaged or even catch fire.
- Always charge batteries away from flammable materials.
- Always inspect the battery before charging.
- Always disconnect the battery after charging, and let the charger cool between charges.
- Always constantly monitor the temperature of the battery pack while charging.
- **ONLY USE A CHARGER SPECIFICALLY DESIGNED TO CHARGE LI-PO BATTERIES.** Failure to charge the battery with a compatible charger may cause a fire resulting in personal injury and/or property damage.
- Never discharge Li-Po cells to below 3V under load.
- Never cover warning labels with hook and loop strips.
- Never leave charging batteries unattended.
- Never charge batteries outside recommended levels.
- Never charge damaged batteries.
- Never attempt to dismantle or alter the charger.
- Never allow minors to charge battery packs.
- Never charge batteries in extremely hot or cold places (recommended between 40–120° F or 5–49° C) or place in direct sunlight.

## Charging the Flight Battery

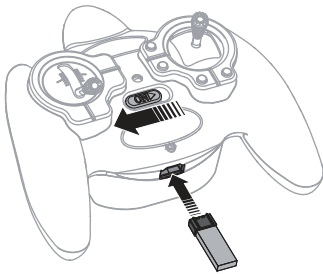

Always charge the aircraft battery before flying.

**CAUTION:** Do not store the Li-Po battery in the charger. Doing so could over-discharge the Li-Po battery.

If the flight battery charging takes longer than 45 minutes AND the charge LED remains solid, replace the transmitter batteries.

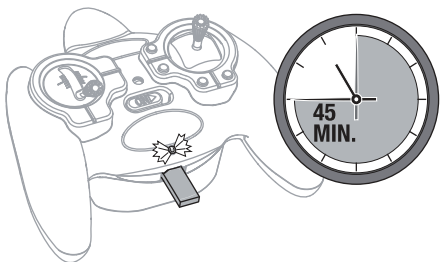

<b>CHARGING</b> (Solid Red).....	
<b>READY</b> (Blinking 20 sec. intervals) .....	
<b>MAX CHARGE</b> (off) .....	

## Installing the Flight Battery

Keep the aircraft and transmitter away from large metal objects, wireless sources or other transmitters while installing the battery.

**CAUTION:** Always disconnect the Li-Po flight battery from the aircraft receiver when not flying to avoid over-discharging the battery. Batteries discharged to a voltage lower than the lowest approved voltage may become damaged, resulting in loss of performance and potential fire when batteries are charged.

**CAUTION:** Always keep hands away from the propellers. Virtual Instructor™ stabilization will turn propellers in response to any aircraft movement.

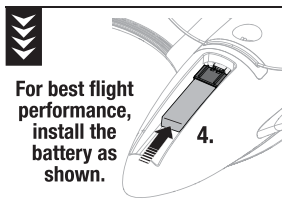
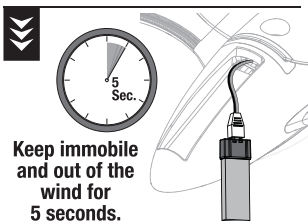
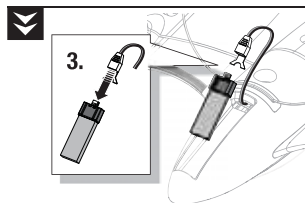
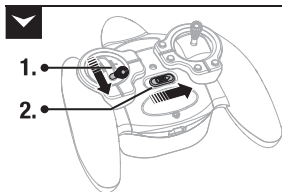

## Control Direction Test

1. Face the aircraft away from you.
2. Restrain the aircraft so it does not escape your control while you are testing your transmitter controls.
3. Move the sticks on the transmitter to ensure the aircraft responds as shown.

Refer to the Binding instructions and Troubleshooting Guide in this manual for more information.

If you need more assistance, contact the appropriate Horizon Hobby Product Support department.

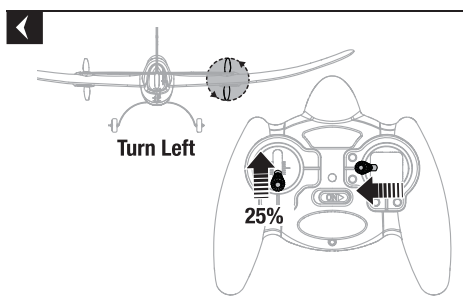
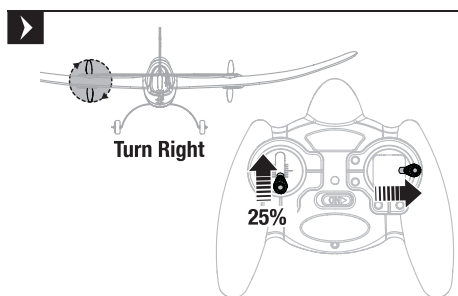
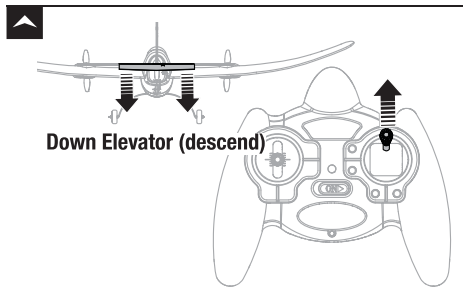
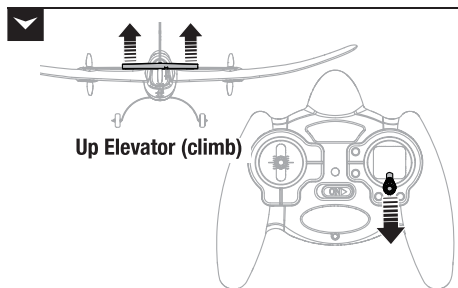

## Takeoff

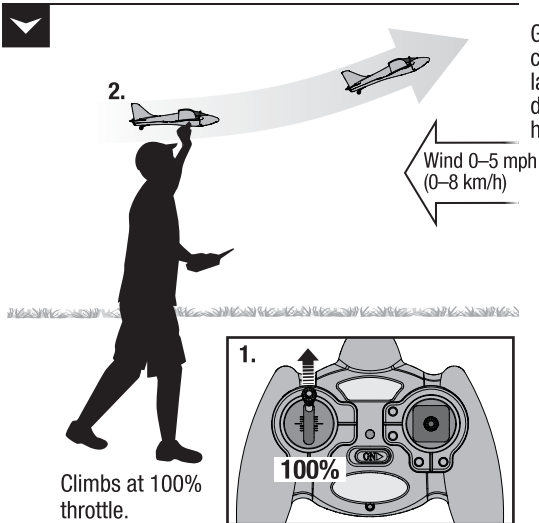

Climbs at 100% throttle.

### Hand Launch

Get help to hand launch your aircraft so you can concentrate on flying. If you must hand launch the aircraft alone, hold the model in your dominant hand and the transmitter in your other hand.

### Ground Launch

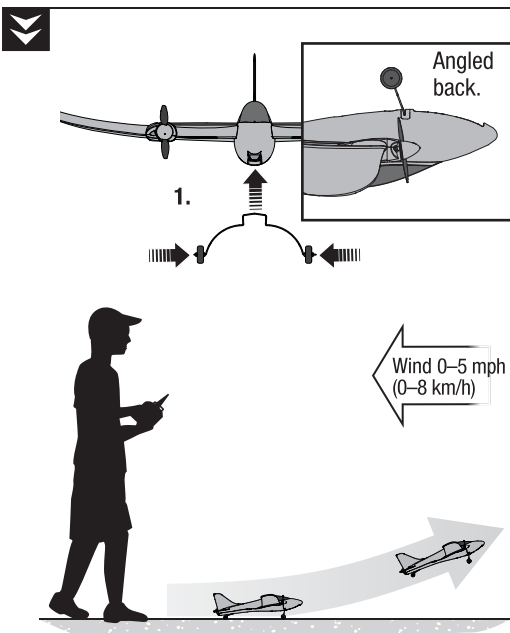

Install the landing gear as shown.

- Takeoff from a hard and level runway.
- Turn the aircraft only after it is high off the ground.

Gently pull back on the elevator stick to lift off of the ground.

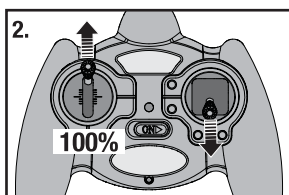

## Flying

- Set a flight timer for 5 minutes
- Always make deliberate and steady control stick movements for smooth control of your aircraft.

**Qo))** If you feel you are losing control, release the right (steering) stick to allow the aircraft to slowly return to level flight.

- When you notice that the aircraft no longer climbs while under full power or the motors begin to pulse, immediately land the aircraft and recharge the battery.

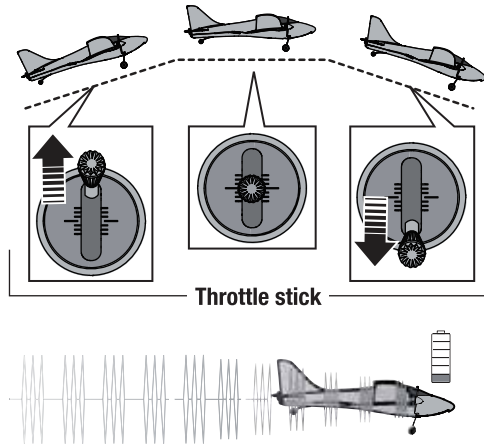

## Adjusting Trim in Flight

Familiarize yourself with your transmitter's controls and the aircraft's response before flying by performing the recommended Control Direction Test. Press the trim buttons on your transmitter to adjust how the aircraft flies.

If the aircraft's nose drifts while the steering stick is at neutral (centered) and the throttle is at 50%, press the trim buttons:

- Upper button to stop up drift
- Lower button to stop down drift
- Left button to stop right drift
- Right button to stop left drift

If you press a trim button until no beep sounds and the aircraft does not fly straight and level, land and manually adjust the trim as described below.

Direction of Drift	Button to Correct

## Manually Adjusting Trim

Press the trim buttons to return to center (3 beeps will sound), then use a pair of pliers to carefully bend the metal connector (A):

- Narrow if the aircraft's nose drifts up.
- Widen if the aircraft's nose drifts down.

Short test flights and small bends may be needed.

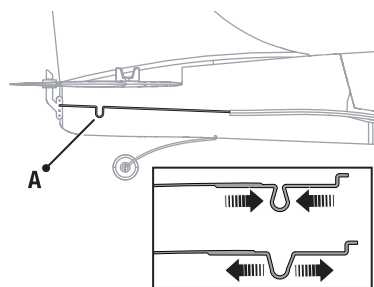



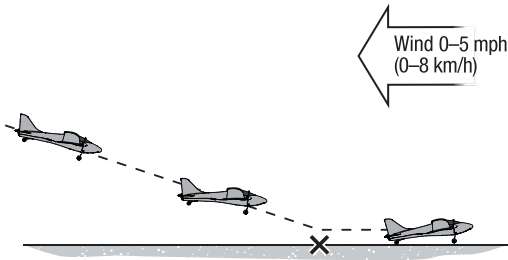

## Landing

Fly to your runway, keeping the aircraft pointed into the wind and the wings level. Bring the aircraft down by lowering the throttle to 25%. Near the ground, fully lower the throttle and pull back on the steering stick.

**CAUTION:** Never catch a flying aircraft in your hands. Doing so could cause personal injury and damage to the aircraft.

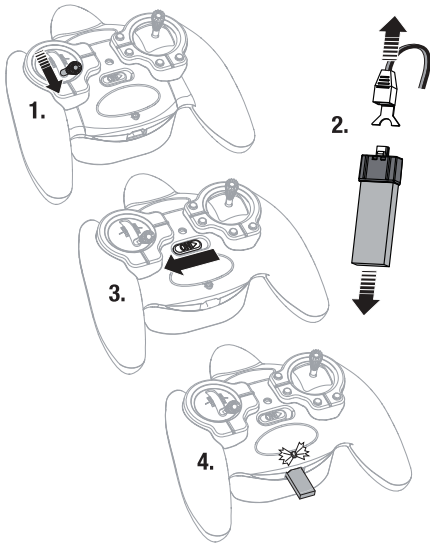

## After Flying

1. Lower the throttle stick completely and do not move the steering stick. Wait at least 5 seconds.
2. Disconnect and remove the battery from the aircraft. Keep hands away from the propellers.
3. Power off the transmitter.
4. Fully charge the aircraft battery.
5. Remove the battery after charging is complete.

**NOTICE:** When you are finished flying, never leave the aircraft in direct sunlight or in a hot, enclosed area such as a car. Doing so can damage the foam.

**NOTICE:** Always disconnect the battery from the aircraft before powering off the transmitter or injury and damage may result.

## Troubleshooting Guide

Problem	Possible Cause	Solution
Aircraft does not respond to the transmitter	No connection	Follow Binding Instructions. Follow “Installing the Flight Battery” instructions. Replace or recharge batteries
	Transmitter too near the aircraft or both are too near large metal objects, wireless sources or another transmitter during battery connection or Binding	Move to another location, with the transmitter more than 24 inches (60 cm) from the aircraft and attempt battery connection or Binding again
	Low or no power	Replace or recharge batteries and correctly connect the aircraft battery
Poor aircraft response to the transmitter	Poor radio connection	Replace or recharge batteries
	Poor control adjustment or damage to the aircraft	Adjust steering by using left or right trim buttons or land immediately and adjust, repair or replace parts
	Aircraft was moved during battery connection	Keep aircraft immobile during battery connection
Aircraft turns in one direction	Poor control adjustment or damage to the aircraft	Adjust steering by using the left or right trim buttons or land immediately and adjust, repair or replace parts
	Wind is too gusty or strong	Fly on a calmer day
Aircraft rises steeply at half throttle	Poor control adjustment or damage to the aircraft	Adjust by pressing the down trim button or land. Manually adjust trim.
	Aircraft battery is incorrectly installed	Install aircraft battery fully back
	Wind is too gusty or strong	Fly on a calmer day
Aircraft will not climb	Poor control adjustment or damage to the aircraft	Adjust by pressing the up trim button or land. Manually adjust trim.
	Propellers or spinners are loose or damaged	Land immediately and adjust, repair or replace parts
	Low or no power	Replace or recharge batteries
Aircraft is difficult to launch in the wind	Gusty or cross winds	Launch directly into the wind
Flight time is too short	Battery is not fully charged or is damaged	Recharge or replace the battery
	Propellers or spinners are loose or damaged	Land immediately and adjust, repair or replace parts
	Flying at full throttle during entire flight	Fly at just above half throttle to increase flying time
	Wind speed is too fast for safe flight	Fly on a calmer day
Aircraft vibrates	Propellers or spinners are loose or damaged	Land immediately and adjust, repair or replace parts

## Propeller Service

**⚠ CAUTION:** DO NOT handle propeller parts while the flight battery is connected. Personal injury could result.

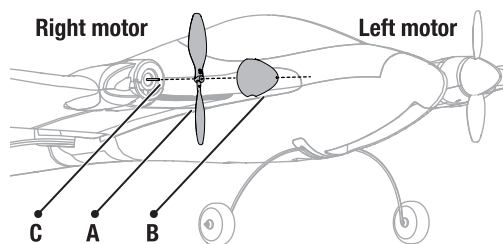

1. Remove the spinner (A) by carefully pulling it away from the propeller (B). Remove residue from the spinner and propeller if applicable.
2. Remove the propeller from the motor shaft, noting the "L" or "R" indicator. Use a pair of needle nose pliers or hemostats to hold the motor shaft (C) in place, then carefully pull the propeller from the motor shaft.
3. Install a new propeller with the size numbers facing out from the motor.
  - 4.75 x 2.5 R (Right)
  - 4.75 x 2.5 L (Left)
4. Reinstall the spinner using foam safe CA (Cyanoacrylate adhesive).

A list of available replacement parts is in the back of the manual. Visit the web site [www.hobbyzonerc.com](http://www.hobbyzonerc.com) for more information about maintaining your aircraft.

## Binding

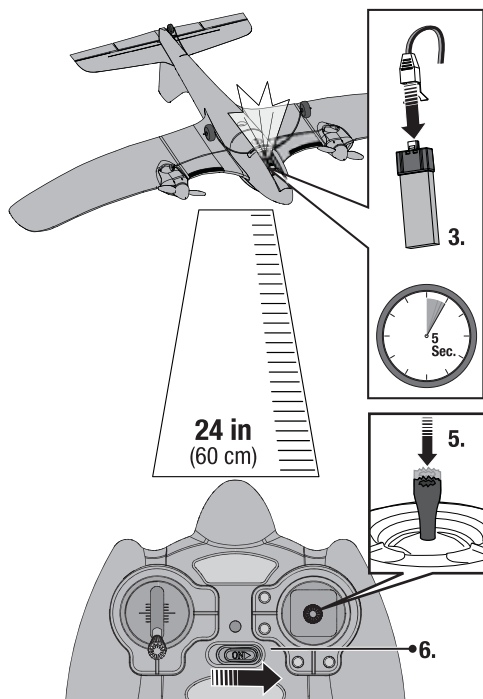

If your aircraft does not respond to the transmitter when the batteries in the aircraft and transmitter are fully charged, bind your aircraft and transmitter by using the instructions below.

1. Disconnect the flight battery from the aircraft.
2. Power off the transmitter.
3. Connect the flight battery to the aircraft. The receiver LED will begin to flash (typically after 5 seconds)
4. Hold the transmitter more than 24 inches (60 cm) away from the aircraft. Keep away from large metal objects, wireless sources and other transmitters. Make sure your transmitter's controls are neutral, the throttle is in the low position, and the aircraft is immobile.
5. Push the right control stick into the case until it clicks, as you power on the transmitter.
6. The transmitter will beep twice and the LED will flash. Release the stick after 2 seconds.
7. After 5 to 10 seconds, the receiver status LED will begin flashing slowly and the transmitter will stop beeping, indicating the receiver is bound to the transmitter.

## Limited Warranty

### What this Warranty Covers

Horizon Hobby, Inc., (Horizon) warrants to the original purchaser that the product purchased (the "Product") will be free from defects in materials and workmanship at the date of purchase.

### What is Not Covered

This warranty is not transferable and does not cover (i) cosmetic damage, (ii) damage due to acts of God, accident, misuse, abuse, negligence, commercial use, or due to improper use, installation, operation or maintenance, (iii) modification of or to any part of the Product, (iv) attempted service by anyone other than a Horizon Hobby authorized service center, (v) Product not purchased from an authorized Horizon dealer, or (vi) Product not compliant with applicable technical regulations.

OTHER THAN THE EXPRESS WARRANTY ABOVE, HORIZON MAKES NO OTHER WARRANTY OR REPRESENTATION, AND HEREBY DISCLAIMS ANY AND ALL IMPLIED WARRANTIES, INCLUDING, WITHOUT LIMITATION, THE IMPLIED WARRANTIES OF NON-INFRINGEMENT, MERCHANTABILITY AND FITNESS FOR A PARTICULAR PURPOSE. THE PURCHASER ACKNOWLEDGES THAT THEY ALONE HAVE DETERMINED THAT THE PRODUCT WILL SUITABLY MEET THE REQUIREMENTS OF THE PURCHASER'S INTENDED USE.

### Purchaser's Remedy

Horizon's sole obligation and purchaser's sole and exclusive remedy shall be that Horizon will, at its option, either (i) service, or (ii) replace, any Product determined by Horizon to be defective. Horizon reserves the right to inspect any and all Product(s) involved in a warranty claim. Service or replacement decisions are at the sole discretion of Horizon. Proof of purchase is required for all warranty claims. SERVICE OR REPLACEMENT AS PROVIDED UNDER THIS WARRANTY IS THE PURCHASER'S SOLE AND EXCLUSIVE REMEDY.

### Limitation of Liability

HORIZON SHALL NOT BE LIABLE FOR SPECIAL, INDIRECT, INCIDENTAL OR CONSEQUENTIAL DAMAGES, LOSS OF PROFITS OR PRODUCTION OR COMMERCIAL LOSS IN ANY WAY, REGARDLESS OF WHETHER SUCH CLAIM IS BASED IN CONTRACT, WARRANTY, TORT, NEGLIGENCE, STRICT LIABILITY OR ANY OTHER THEORY OF LIABILITY, EVEN IF HORIZON HAS BEEN ADVISED OF THE POSSIBILITY OF SUCH DAMAGES. Further, in no event shall the liability of Horizon exceed the individual price of the Product on which liability is asserted. As Horizon has no control over use, setup, final assembly, modification or misuse, no liability shall be assumed nor accepted for any resulting damage or injury. By the act of use, setup or assembly, the user accepts

all resulting liability. If you as the purchaser or user are not prepared to accept the liability associated with the use of the Product, purchaser is advised to return the Product immediately in new and unused condition to the place of purchase.

### Law

These terms are governed by Illinois law (without regard to conflict of law principals). This warranty gives you specific legal rights, and you may also have other rights which vary from state to state. Horizon reserves the right to change or modify this warranty at any time without notice.

### WARRANTY SERVICES

#### Questions, Assistance, and Services

Your local hobby store and/or place of purchase cannot provide warranty support or service. Once assembly, setup or use of the Product has been started, you must contact your local distributor or Horizon directly. This will enable Horizon to better answer your questions and service you in the event that you may need any assistance. For questions or assistance, please visit our website at [www.horizonhobby.com](http://www.horizonhobby.com), submit a Product Support Inquiry, or call the toll free telephone number referenced in the Warranty and Service Contact Information section to speak with a Product Support representative.

#### Inspection or Services

If this Product needs to be inspected or serviced and is compliant in the country you live and use the Product in, please use the Horizon Online Service Request submission process found on our website or call Horizon to obtain a Return Merchandise Authorization (RMA) number. Pack the Product securely using a shipping carton. Please note that original boxes may be included, but are not designed to withstand the rigors of shipping without additional protection. Ship via a carrier that provides tracking and insurance for lost or damaged parcels, as Horizon is not responsible for merchandise until it arrives and is accepted at our facility. An Online Service Request is available at [http://www.horizonhobby.com/content/\\_service-center\\_render-service-center](http://www.horizonhobby.com/content/_service-center_render-service-center). If you do not have internet access, please contact Horizon Product Support to obtain a RMA number along with instructions for submitting your product for service. When calling Horizon, you will be asked to provide your complete name, street address, email address and phone number where you can be reached during business hours. When sending product into Horizon, please include your RMA number, a list of the included items, and a brief summary of the problem. A copy of your original sales receipt must be included for warranty consideration. Be sure your name, address, and RMA number are clearly written on the outside of

the shipping carton.

**NOTICE: Do not ship LiPo batteries to Horizon. If you have any issue with a LiPo battery, please contact the appropriate Horizon Product Support office.**

#### Warranty Requirements

**For Warranty consideration, you must include your original sales receipt verifying the proof-of-purchase date.** Provided warranty conditions have been met, your Product will be serviced or replaced free of charge. Service or replacement decisions are at the sole discretion of Horizon

#### Non-Warranty Service

**Should your service not be covered by warranty, service will be completed and payment will be required without notification or estimate of the expense unless the expense exceeds 50% of the retail purchase cost.** By submitting the item for service you are agreeing to payment of the service without notification. Service estimates are available

upon request. You must include this request with your item submitted for service. Non-warranty service estimates will be billed a minimum of ½ hour of labor. In addition you will be billed for return freight. Horizon accepts money orders and cashier's checks, as well as Visa, MasterCard, American Express, and Discover cards. By submitting any item to Horizon for service, you are agreeing to Horizon's Terms and Conditions found on our website [http://www.horizonhobby.com/content/\\_service-center\\_render-service-center](http://www.horizonhobby.com/content/_service-center_render-service-center).

**ATTENTION: Horizon service is limited to Product compliant in the country of use and ownership. If received, a non-compliant Product will not be serviced. Further, the sender will be responsible for arranging return shipment of the un-serviced Product, through a carrier of the sender's choice and at the sender's expense. Horizon will hold non-compliant Product for a period of 60 days from notification, after which it will be discarded.**

## Warranty and Service Information

Country of Purchase	Horizon Hobby	Phone Number/Email Address	Address
United States of America	Horizon Service Center (Repairs and Repair Requests)	servicecenter.horizonhobby.com/RequestForm/	4105 Fieldstone Rd Champaign, Illinois 61822 USA
	Horizon Product Support (Product Technical Assistance)	www.quickbase.com/db/bghj7ey8c?a=GenNewRecord 888-959-2305	
	Sales	sales@horizonhobby.com 888-959-2305	
United Kingdom	Service/Parts/Sales: Horizon Hobby Limited	sales@horizonhobby.co.uk +44 (0) 1279 641 097	Units 1–4 , Ployters Rd, Staple Tye Harlow, Essex, CM18 7NS, United Kingdom
Germany	Horizon Technischer Service	service@horizonhobby.de	Christian-Junge-Straße 1 25337 Elmshorn, Germany
	Sales: Horizon Hobby GmbH	+49 (0) 4121 2655 100	
France	Service/Parts/Sales: Horizon Hobby SAS	infofrance@horizonhobby.com +33 (0) 1 60 18 34 90	11 Rue Georges Charpak 77127 Lieusaint, France
China	Service/Parts/Sales: Horizon Hobby – China	info@horizonhobby.com.cn +86 (021) 5180 9868	Room 506, No. 97 Changshou Rd. Shanghai, China 200060

## FCC Information

This device complies with part 15 of the FCC rules. Operation is subject to the following two conditions: (1) This device may not cause harmful interference, and (2) this device must accept any interference received, including interference that may cause undesired operation.



**CAUTION:** Changes or modifications not expressly approved by the party responsible for compliance could void the user's authority to operate the equipment.

This product contains a radio transmitter with wireless technology which has been tested and found to be compliant with the applicable regulations governing a radio transmitter in the 2.400GHz to 2.4835GHz frequency range.

## IC Information

This device complies with Industry Canada license-exempt RSS standard(s). Operation is subject to the following two conditions: (1) this device may not cause interference, and (2) this device must accept any interference, including interference that may cause undesired operation of the device.

## Compliance Information for the European Union

### Declaration of Conformity

(in accordance with ISO/IEC 17050-1)  
No. HH2013082602

Product(s): HBZ Duet UM RTF  
Item Number(s): HBZ5300  
Equipment class: 1

The object of declaration described above is in conformity with the requirements of the specifications listed below, following the provisions of the European R&TTE directive 1999/5/EC, EMC Directive 2004/108/EC and LVD Directive 2006/95/EC

**EN 300 440-1 V1.6.1: 2010**

**EN 301 489-1 V1.9.2: 2012**

**EN 301 489-17 V2.1.1: 2009**

**EN60950-1:2006+A11:2009+A1:2010+A12: 2011**

**EN55022:2010 + AC:2011**

**EN55024:2010**



Robert Peak

Chief Financial Officer  
Horizon Hobby, Inc

Signed for and on behalf of :  
Horizon Hobby, Inc.  
Champaign, IL USA  
Aug 26, 2013

## Instructions for disposal of WEEE by users in the European Union



This product must not be disposed of with other waste. Instead, it is the user's responsibility to dispose of their waste equipment by handing it over to a designated collection point for the recycling of waste electrical and electronic equipment. The separate collection and recycling of your waste equipment at the time of disposal will help to conserve natural resources and ensure that it is recycled in a manner that protects human health and the environment. For more information about where you can drop off your waste equipment for recycling, please contact your local city office, your household waste disposal service or where you purchased the product.

**HINWEIS**

Allen Anweisungen, Garantien und anderen zugehörigen Dokumenten sind Änderungen nach Ermessen von Horizon Hobby, Inc. vorbehalten. Aktuelle Produktliteratur finden Sie unter [www.horizonhobby.com](http://www.horizonhobby.com) im Support-Abschnitt für das Produkt.

**Begriffserklärung**

Die folgende Begriffe werden in der gesamte Produktliteratur verwendet, um die Gefährdungsstufen im Umgang mit dem Produkt zu definieren:

**HINWEIS:** Verfahren können bei nicht ordnungsgemäßer Durchführung womöglich Schäden an physischem Eigentum UND geringfügige oder keine Verletzungen verursachen.

**ACHTUNG:** Verfahren können bei nicht ordnungsgemäßer Durchführung womöglich Schäden an physischem Eigentum UND schwere Verletzungen verursachen.

**WARNUNG:** Verfahren können bei nicht ordnungsgemäßer Durchführung womöglich Schäden an Eigentum, Kollateralschäden UND schwere Verletzungen ODER höchstwahrscheinlich oberflächliche Verletzungen verursachen.



**WARNUNG:** Lesen Sie die GESAMTE Bedienungsanleitung, um sich vor Inbetriebnahme mit den Funktionen des Produkts vertraut zu machen. Eine nicht ordnungsgemäße Bedienung des Produkts kann das Produkts und persönliches Eigentum schädigen und schwere Verletzungen verursachen.

Dies ist ein hoch entwickeltes Produkt für den Hobbygebrauch. Es muss mit Vorsicht und Umsicht bedient werden und erfordert einige mechanische Grundfertigkeiten. Wird das Produkt nicht sicher und umsichtig verwendet, so könnten Verletzungen oder Schäden am Produkt oder anderem Eigentum entstehen. Dieses Produkt ist nicht für den Gebrauch durch Kinder ohne direkte Aufsicht eines Erwachsenen vorgesehen. Verwenden Sie das Produkt nicht mit inkompatiblen Komponenten oder verändern es in jedweder Art ausserhalb der von Horizon Hobby Inc vorgegebenen Anweisungen. Dieses Handbuch enthält Sicherheitshinweise sowie Anleitungen zu Betrieb und Wartung. Es ist unerlässlich, dass Sie alle Anleitungen und Warnungen in diesem Handbuch vor dem Zusammenbau, der Einrichtung oder der Inbetriebnahme lesen und diese befolgen, um eine korrekte Bedienung zu gewährleisten und Schäden bzw. schwere Verletzungen zu vermeiden.

**Altersempfehlung: Nicht für Kinder unter 14 Jahren. Dies ist kein Spielzeug.**

### Warnungen und Sicherheitshinweise

- Halten Sie immer einen Sicherheitsabstand zu allen Seiten um das Modell um Kollisionen oder Verletzungen zu vermeiden. Dieses Modell wird von einem Funksignal gesteuert, dass von vielen Quellen ausserhalb ihrer Kontrolle gestört werden kann. Diese Störungen können zu momentanen Kontrollverlust führen.
- Betreiben Sie Ihr Modell stets auf offenen Geländen, weit ab von Automobilen, Verkehr und Menschen.
- Folgen Sie stets vorsichtig den Anweisungen und Warnungen für dieses Modell und allem dazugehörigem Zubehör (Ladegeräte, Akkus etc..)
- Halten Sie immer alle Chemikalien, Kleinteile und alle elektrischen Bauteile aus der Reichweite von Kindern.
- Vermeiden Sie jeglichen Wasserkontakt mit allen Teilen die nicht speziell dafür entwickelt worden und geschützt sind. Feuchtigkeit beschädigt die Elektronik.
- Nehmen Sie niemals Teile ihres Modells in den Mund, da das zu schweren Verletzungen bis hin zum Tod führen könnte.
- Betreiben Sie niemals Ihr Modell mit leeren Senderbatterien.
- Halten Sie immer ihr Modell in Sicht und unter Kontrolle.
- Verwenden Sie immer vollständig geladene Akkus.
- Lassen Sie immer den Sender eingeschaltet wenn das Luftfahrzeug eingeschaltet ist.
- Entnehmen Sie immer die Akkus vor der Demontage.
- Halten Sie immer alle beweglichen Teile sauber.
- Halten Sie stets alle Teile sauber.
- Lassen Sie alle Teile abkühlen bevor Sie sie anfassen.
- Entfernen Sie immer die Akkus nach der Benutzung.
- Vergewissern Sie sich vor dem Fliegen das die Failsafeinstellungen korrekt eingestellt sind.
- Betreiben Sie niemals das Flugzeug mit beschädigter Verkabelung.
- Fassen Sie niemals bewegte Teile an.

## Im Lieferumfang enthalten

Registrieren Sie Ihr Produkt online unter [www.hobbyzonerc.com](http://www.hobbyzonerc.com)

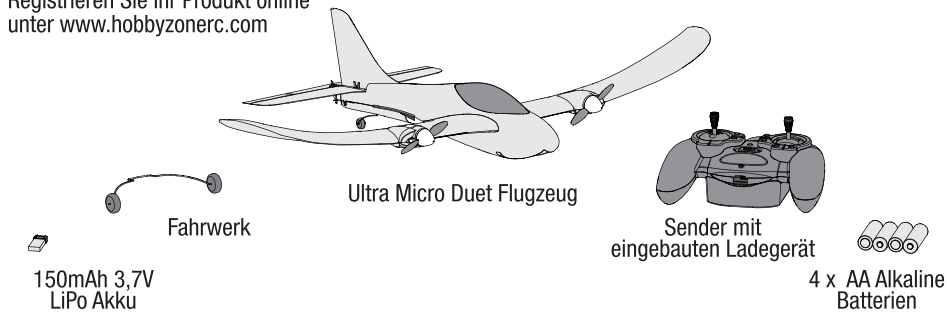

## Tipps zum Fliegen

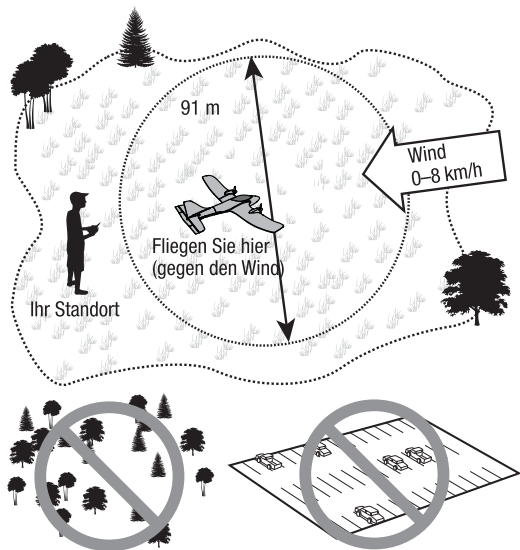

- Bitte beachten Sie örtliche Bestimmungen und Vorschriften bevor Sie sich ein Flugfeld suchen.
- Fliegen Sie Ihr Flugzeug draussen nur bei geringen Windstärken.
- Zum Indoor fliegen wählen Sie bitte eine große Halle.
- Halten Sie das Flugzeug stets im Blick und gegen den Wind. Überschreiten Sie nicht die 91 Meter RC Reichweite. Sollte die Funkverbindung unterbrochen werden, schalten die Motoren ab und das Flugzeug sinkt. Lassen Sie den Sender eingeschaltet und verkürzen die Distanz zum Flugzeug um wieder die Kontrolle zu haben.
- Vermeiden Sie es neben Häusern, Bäumen, Leitungen und Gebäuden zu fliegen.
- Fliegen Sie nicht auf Plätzen die von Menschen frequentiert werden wie in Parks, auf Schulhöfen oder Fußballfeldern.

## Checkliste vor dem Flug

✓	
	1. Finden Sie eine sichere und offene Gegend zum Fliegen.
	2. Laden Sie den Flugakku.
	3. Setzen Sie den geladenen Akku ein.
	4. Führen Sie einen Steuerrichtungstest durch.

✓	
	5. Planen Sie ihre Flug nach den Flugfeldbedingungen.
	6. Stellen Sie den Timer auf 5 Minuten ein.
	7. Haben Sie Spaß !



## Sender

### Warnung Batteriespannung zu niedrig

Fällt die Akkuspannung unter die kritische Grenze ertönt ein Alarm und die Spannungs-LED blinkt. Die Batterien müssen dann unverzüglich ersetzt werden. Sollte dieses während des Fluges passieren landen Sie das Flugzeug sofort und sicher wie möglich.

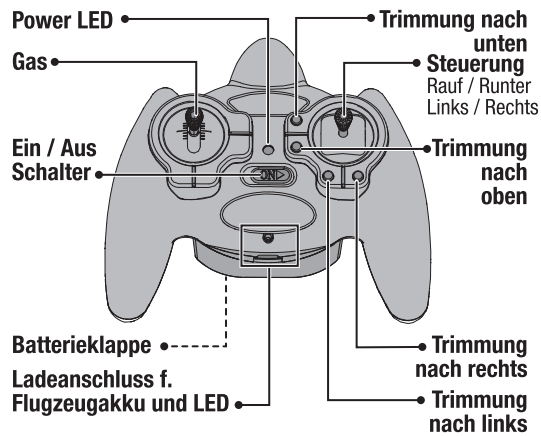

## Einsetzen der Senderbatterien

Nehmen Sie die Akkuklappe ab und setzen die vier im Lieferumfang enthaltenen Batterien polrichtig ein und setzen die Akkuklappe wieder auf.

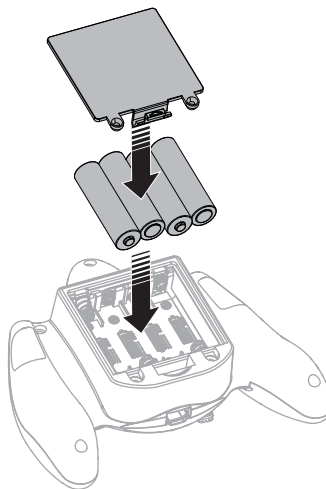
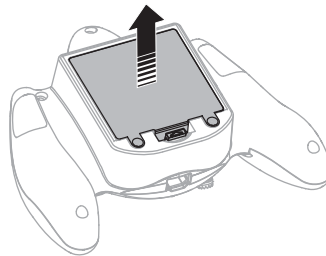

## Warnhinweise und Vorgaben zum Akku

Der im Lieferumfang des Duet enthaltene Sender wurde speziell dafür entwickelt den im Lieferumfang enthaltenen LiPo Akku sicher zu laden.

**⚠ ACHTUNG:** Alle Anweisungen und Warnhinweise müssen genau befolgt werden. Falsche Handhabung von Li-Po-Akkus kann zu Brand, Personen- und/oder Sachwertschäden führen.

- Durch Handhabung, Aufladen oder Verwenden des unbegriffenen Li-Po-Akkus übernehmen Sie alle mit Lithiumakkus verbundenen Risiken.
- Sollte beim Laden oder im Flug der Akku beginnen sich aufzublähen oder anzuschwellen, stoppen Sie den Ladevorgang oder den Flug unverzüglich und trennen den Akku vom Sender bzw. Hubschrauber. Ein fortgesetztes Laden oder Fliegen eines aufblähenden oder anschwellenden Akku kann ein Feuer zur Folge haben.
- Um beste Ergebnisse zu erzielen, lagern Sie den Akku bei Raumtemperatur an einem trockenen Ort.
- Beim Transport oder vorübergehenden Lagern des Akkus sollte der Temperaturbereich zwischen 5° C und 49° C liegen. Bewahren Sie den Akku bzw. das Modell nicht im Auto oder unter direkter Sonneneinstrahlung auf. Bei Aufbewahrung in einem heißen Auto, kann der Akku beschädigt werden oder sogar Feuer fangen.
- Laden Sie immer Li Po Akkus weit weg entfernt von brennbaren Materialien.
- Überprüfen Sie immer den Akku vor dem Laden und laden Sie niemals defekte oder beschädigte Akkus.
- Trennen Sie immer den Akku nach dem Laden und lassen das Ladegerät abkühlen.
- Überwachen Sie bei dem Ladevorgang konstant die Temperatur des Akkupacks.
- VERWENDEN SIE NUR EIN SPEZIELL GEEIGNETES LI-PO LADEGERÄT UM LI-PO AKKUS ZU LADEN. Laden Sie den Akku mit einem nicht geeigneten Ladegerät kann dieses zu Feuer, Personen- und Sachschäden führen.
- Entladen Sie niemals ein LiPo Akku unter 3V pro Zelle unter Last.
- Verdecken Sie niemals Warnhinweise mit Klebband.
- Lassen Sie niemals Akkus während des Ladens unbeaufsichtigt.
- Laden Sie niemals Akkus außerhalb ihren Spezifikationen.
- Laden Sie niemals beschädigte Akkus.
- Versuchen Sie nicht das Ladegerät zu demontieren oder zu verändern.
- Lassen Sie niemals Minderjährige Akkus laden.
- Laden Sie niemals Akkus an extrem kalten oder heißen Plätzen (empfohlener Temperaturbereich 5 - 49° C ) oder im direkten Sonnenlicht.

## Laden des Flugakkus

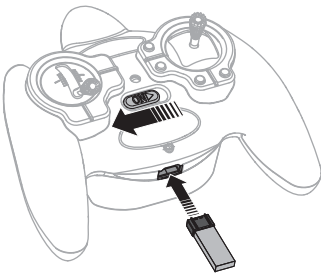

Laden Sie immer den Flugzeugakku vor dem Fliegen.

**⚠ ACHTUNG:** Lagern Sie bitte nicht den LiPo Akku im Ladegerät da er sonst Überladen werden könnte.

Ersetzen Sie die Senderbatterien wenn der Ladevorgang des Flugakkus länger als 45 Minuten dauert UND die Lade LED weiterhin leuchtet.

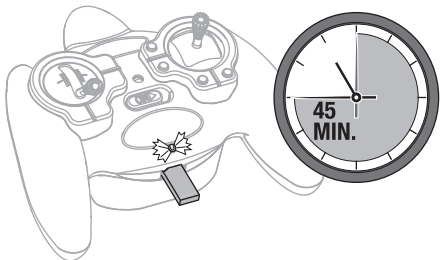

<b>LADEN</b> (Leuchtet Rot) .....	
<b>FERTIG</b> (Blinkt in 20 Sekunden Intervallen)	
<b>MAXIMAL GELADEN</b> (OFF) .....	

## Einsetzen des Flugakkus

Halten Sie mit dem Flugzeug und Sender Abstand von großen metallischen Objekten, Funkquellen oder andern Sendern während Sie den Akku einsetzen.

**⚠ ACHTUNG:** Trennen Sie immer den Akku vom Flugzeug wenn Sie nicht fliegen um eine Tiefentladung des Akkus zu vermeiden. Akkus die unter die zulässige Soannung entladen werden könnten beschädigt werden was zu Leistungsverlust und potentieller Brandgefahr bei dem Laden führen kann.

**⚠ ACHTUNG:** Halten Sie die Hände stets vom Propeller fern. Bei Aktivierung dreht der Moter den Propeller als Reaktion auf jede Gasbewegung.

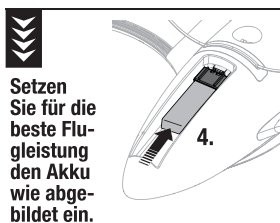
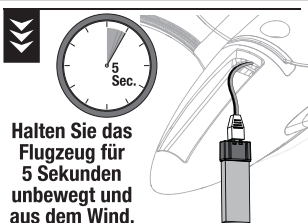
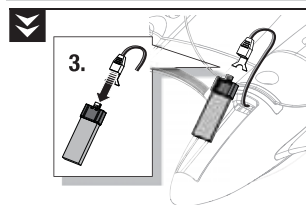
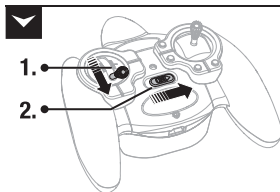

Setzen Sie für die beste Flugleistung den Akku wie abgebildet ein.

## Steuerrichtungstest

1. Stellen Sie das Flugzeug so hin, dass das Heck zu Ihnen zeigt.
2. Sichern Sie das Flugzeug, so dass es sich nicht selbständig machen kann während Sie die Senderkontrollen testen.
3. Bewegen Sie die Steuerknüppel um sicherzustellen, dass das Flugzeug wie abgebildet reagiert.

Sollten Sie mehr Informationen benötigen lesen Sie bitte in den Bindeanweisungen und in der Hilfestellung zur Problemlösung nach.

Sollten Sie weitere Unterstützung benötigen kontaktieren Sie bitte den technischen Service von Horizon Hobby.

