



# MEASUREMENT REPORT

## FCC PART 15.247 / RSS-247 ZigBee 802.15.4

**FCC ID:** BRWDUETARG1  
**IC:** 6157A-DUETARG1  
**APPLICANT:** Horizon Hobby, LLC  
**Application Type:** Certification  
**Product:** Hobbyzone Duet RTF  
**Model No.:** HBZ5300  
**Brand Name:** E-flite  
**FCC Classification:** Digital Transmission System (DTS)  
**FCC Rule Part(s):** Part 15 Subpart C (Section 15.247)  
**IC Rule(s):** RSS-247 Issue 2, RSS-GEN Issue 5  
**Test Procedure(s) :** ANSI C63.10-2013, KDB 558074 D01v05  
**Test Date:** September 14 ~ September 25, 2018

Reviewed By: Sunny Sun  
( Sunny Sun )

Approved By: Robin Wu  
( Robin Wu )



The test results relate only to the samples tested.

This equipment has been shown to be capable of compliance with the applicable technical standards as indicated in the measurement report and was tested in accordance with the measurement procedures specified in KDB 558074 D01v05. Test results reported herein relate only to the item(s) tested.

The test report shall not be reproduced except in full without the written approval of MRT Technology (Suzhou) Co., Ltd.

---

### Revision History

Report No.	Version	Description	Issue Date	Note
1809RSU015-U1	Rev. 01	Initial Report	10-11-2018	Valid

---

## CONTENTS

Description	Page
<b>§2.1033 General Information</b> .....	<b>5</b>
<b>1. INTRODUCTION</b> .....	<b>6</b>
1.1. Scope .....	6
1.2. MRT Test Location .....	6
<b>2. PRODUCT INFORMATION</b> .....	<b>7</b>
2.1. Equipment Description .....	7
2.2. Operation Frequency / Channel List.....	7
2.3. Test Mode .....	7
2.4. Test Software .....	7
2.5. Device Capabilities.....	8
2.6. Test Configuration .....	8
2.7. EMI Suppression Device(s)/Modifications.....	8
2.8. Labeling Requirements .....	9
<b>3. DESCRIPTION OF TEST</b> .....	<b>10</b>
3.1. Evaluation Procedure .....	10
3.2. AC Line Conducted Emissions.....	10
3.3. Radiated Emissions.....	11
<b>4. ANTENNA REQUIREMENTS</b> .....	<b>12</b>
<b>5. TEST EQUIPMENT CALIBRATION DATE</b> .....	<b>13</b>
<b>6. MEASUREMENT UNCERTAINTY</b> .....	<b>14</b>
<b>7. TEST RESULT</b> .....	<b>15</b>
7.1. Summary .....	15
7.2. 6dB Bandwidth & 99% Bandwidth Measurement.....	16
7.2.1. Test Limit .....	16
7.2.2. Test Procedure used .....	16
7.2.3. Test Setting.....	16
7.2.4. Test Setup .....	16
7.2.5. Test Result.....	17
7.3. Output Power Measurement .....	18
7.3.1. Test Limit .....	18
7.3.2. Test Procedure Used.....	18
7.3.3. Test Setting.....	18
7.3.4. Test Setup .....	18

7.3.5.	Test Result.....	19
7.4.	Power Spectral Density Measurement .....	20
7.4.1.	Test Limit .....	20
7.4.2.	Test Procedure Used.....	20
7.4.3.	Test Setting.....	20
7.4.4.	Test Setup .....	20
7.4.5.	Test Result.....	21
7.5.	Conducted Band Edge and Out-of-Band Emissions .....	22
7.5.1.	Test Limit .....	22
7.5.2.	Test Procedure Used.....	22
7.5.3.	Test Setting.....	22
7.5.4.	Test Setup .....	23
7.5.5.	Test Result.....	24
7.6.	Radiated Spurious Emission Measurement .....	26
7.6.1.	Test Limit .....	26
7.6.2.	Test Procedure Used.....	26
7.6.3.	Test Setting.....	26
7.6.4.	Test Setup .....	28
7.6.5.	Test Result.....	29
7.7.	Radiated Restricted Band Edge Measurement .....	34
7.7.1.	Test Limit .....	34
7.7.2.	Test Procedure Used.....	37
7.7.3.	Test Setting.....	37
7.7.4.	Test Setup .....	38
7.7.5.	Test Result.....	39
7.8.	AC Conducted Emissions Measurement.....	47
7.8.1.	Test Limit .....	47
7.8.2.	Test Setup .....	47
7.8.3.	Test Result.....	47
<b>8.</b>	<b>CONCLUSION.....</b>	<b>48</b>
	<b>Appendix A – Test Setup Photograph .....</b>	<b>49</b>
	<b>Appendix B – EUT Photograph.....</b>	<b>50</b>

## §2.1033 General Information

<b>Applicant:</b>	Horizon Hobby, LLC		
<b>Applicant Address:</b>	4105 Fieldstone Rd., Champaign IL 61822 USA		
<b>Manufacturer:</b>	KUNSHAN HELANG ELECTRONICS CO., LTD.		
<b>Manufacturer Address:</b>	No.388 East Zhengwei Road, Jinxi Town, Kunshan, Jiangsu 215324, China		
<b>Test Site:</b>	MRT Technology (Suzhou) Co., Ltd		
<b>Test Site Address:</b>	D8 Building, No.2 Tian'edang Rd., Wuzhong Economic Development Zone, Suzhou, China		
<b>FCC Registration No.:</b>	893164		
<b>IC Registration No.:</b>	11384A-1		
<b>Test Device Serial No.:</b>	N/A	<input type="checkbox"/> Production	<input checked="" type="checkbox"/> Pre-Production <input type="checkbox"/> Engineering

### Test Facility / Accreditations

Measurements were performed at MRT Laboratory located in Tian'edang Rd., Suzhou, China.

- MRT facility is a FCC registered (MRT Reg. No. 893164) test facility with the site description report on file and has met all the requirements specified in ANSI C63.4-2014.
- MRT facility is an IC registered (MRT Reg. No. 11384A-1) test laboratory with the site description on file at Industry Canada.
- MRT facility is a VCCI registered (R-20025, G-20034, C-20020, T-20020) test laboratory with the site description on file at VCCI Council.
- MRT Lab is accredited to ISO 17025 by the American Association for Laboratory Accreditation (A2LA) under the American Association for Laboratory Accreditation Program (A2LA Cert. No. 3628.01) in EMC, Telecommunications, Radio and SAR testing.



# 1. INTRODUCTION

## 1.1. Scope

Measurement and determination of electromagnetic emissions (EMC) of radio frequency devices including intentional and/or unintentional radiators for compliance with the technical rules and regulations of the Federal Communications Commission and the Industry Canada Certification and Engineering Bureau.

## 1.2. MRT Test Location

The map below shows the location of the MRT LABORATORY, its proximity to the Taihu Lake. These measurement tests were conducted at the MRT Technology (Suzhou) Co., Ltd. Facility located at D8 Building, No.2 Tian'edang Rd., Wuzhong Economic Development Zone, Suzhou, China. The measurement facility compliant with the test site requirements specified in ANSI C63.4-2014.



## 2. PRODUCT INFORMATION

### 2.1. Equipment Description

Product Name	Hobbyzone Duet RTF
Model No.	HBZ5300
Brand Name	E-flite
ZigBee Specification	802.15.4
Power Supply:	By Battery 3.7V, 150mAh
Frequency Range	802.15.4: 2405 ~ 2475 MHz
Type of Modulation	O-QPSK
Antenna Type	Dipole Antenna
Antenna Gain	1dBi

### 2.2. Operation Frequency / Channel List

Channel	Frequency	Channel	Frequency	Channel	Frequency
11	2405 MHz	12	2410 MHz	13	2415 MHz
14	2420 MHz	15	2425 MHz	16	2430 MHz
17	2435 MHz	18	2440 MHz	19	2445 MHz
20	2450 MHz	21	2455 MHz	22	2460 MHz
23	2465 MHz	24	2470 MHz	25	2475 MHz

### 2.3. Test Mode

Test Mode	Mode 1: Transmit by 802.15.4
-----------	------------------------------

### 2.4. Test Software

N/A



## 2.5. Device Capabilities

This device contains the following capabilities:

2.4GHz ZigBee (DTS) device

**Note:** The maximum achievable duty cycle was determined based on measurements performed on a spectrum analyzer in zero-span mode with RBW = 8MHz, VBW = 50MHz. The RBW and VBW were both greater than 50/T, where T is the minimum transmission duration, and the number of sweep points across T was greater than 100. The duty cycles are as follows:

Test Mode	Duty Cycle
802.15.4	69.81%

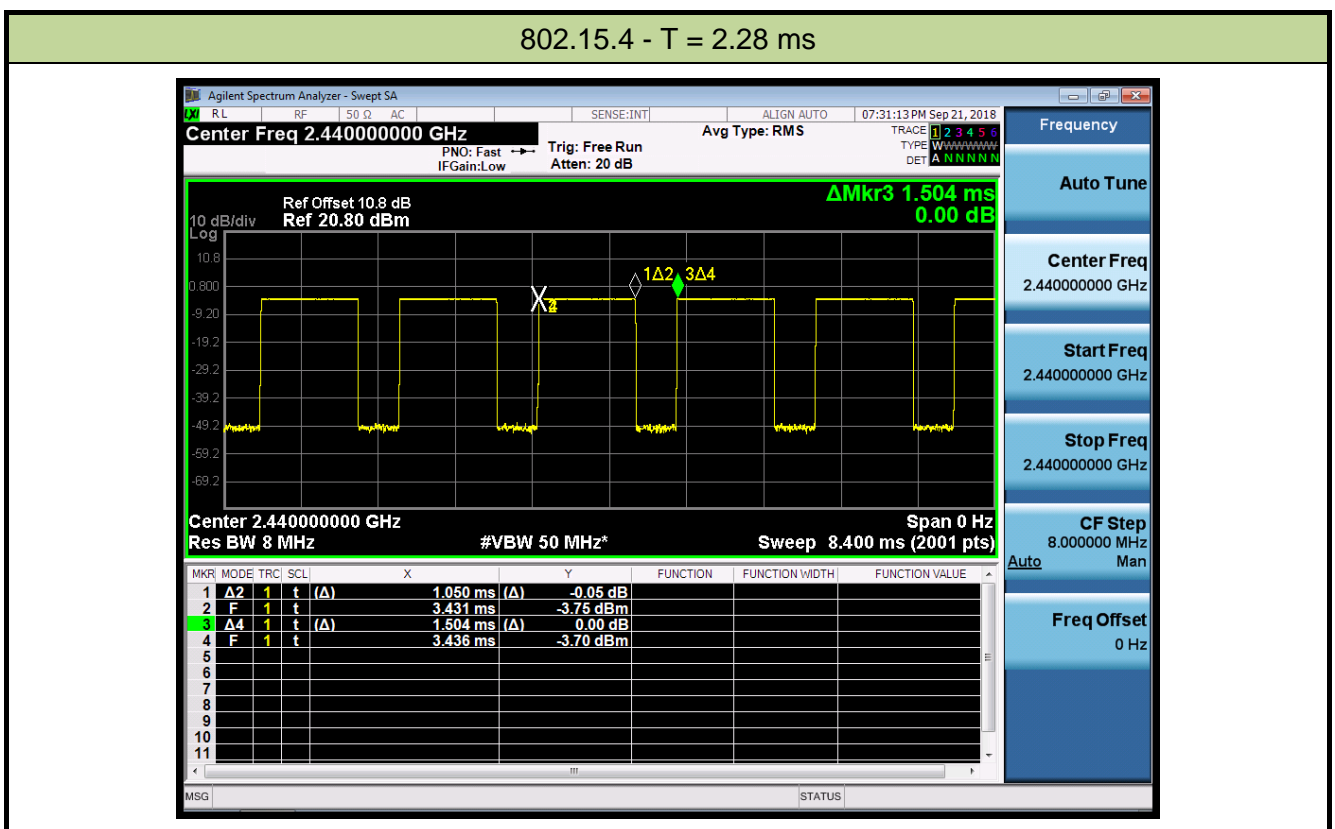

## 2.6. Test Configuration

The **Hobbyzone Duet RTF** was tested per the guidance of KDB 558074 D01v05. ANSI C63.10-2013 was used to reference the appropriate EUT setup for radiated spurious emissions testing and AC line conducted testing.

## 2.7. EMI Suppression Device(s)/Modifications

No EMI suppression device(s) were added and/or no modifications were made during testing.



## 2.8. Labeling Requirements

### Per 2.1074 & 15.19; Docket 95-19

The label shall be permanently affixed at a conspicuous location on the device; instruction manual or pamphlet supplied to the user and be readily visible to the purchaser at the time of purchase.

However, when the device is so small wherein placement of the label with specified statement is not practical, only the FCC ID must be displayed on the device per Section 15.19(a)(5). Please see attachment for FCC ID label and label location.

### RSP-100 Issue 11 Section 3

The manufacturer, importer or distributor shall meet the labelling requirements set out in this section for every unit:

- (i) prior to marketing in Canada, for products manufactured in Canada
- (ii) prior to importation into Canada, for imported products

For information regarding the e-labelling option, see Notice 2014–DRS1003. The label for the certified product represents the manufacturer's or importer's compliance with Innovation, Science and Economic Development Canada's (ISED) regulatory requirements.

Please see attachment for IC label and label location.

### 3. DESCRIPTION OF TEST

#### 3.1. Evaluation Procedure

The measurement procedures described in the American National Standard for Testing Unlicensed Wireless Devices (ANSI C63.10-2013), and the guidance provided in KDB 558074 D01v05 were used in the measurement.

**Deviation from measurement procedure.....None**

#### 3.2. AC Line Conducted Emissions

The line-conducted facility is located inside an 8'x4'x4' shielded enclosure. A 1m x 2m wooden table 80cm high is placed 40cm away from the vertical wall and 80cm away from the sidewall of the shielded room. Two 10kHz-30MHz, 50Ω/50uH Line-Impedance Stabilization Networks (LISNs) are bonded to the shielded room floor. Power to the LISNs is filtered by external high-current high-insertion loss power line filters. These filters attenuate ambient signal noise from entering the measurement lines. These filters are also bonded to the shielded enclosure.

The EUT is powered from one LISN and the support equipment is powered from the second LISN. All interconnecting cables more than 1 meter were shortened to a 1 meter length by non-inductive bundling (serpentine fashion) and draped over the back edge of the test table. All cables were at least 40cm above the horizontal reference ground-plane. Power cables for support equipment were routed down to the second LISN while ensuring that that cables were not draped over the second LISN.

Sufficient time for the EUT, support equipment, and test equipment was allowed in order for them to warm up to their normal operating condition. The RF output of the LISN was connected to the receiver and exploratory measurements were made to determine the frequencies producing the maximum emission from the EUT. The receiver was scanned from 150kHz to 30MHz. The detector function was set to peak mode for exploratory measurements while the bandwidth of the analyzer was set to 9kHz. The EUT, support equipment, and interconnecting cables were arranged and manipulated to maximize each emission. Each emission was also maximized by varying: power lines, the mode of operation or data exchange speed, or support equipment whichever determined the worst-case emission. Once the worst case emissions have been identified, the one EUT cable configuration/arrangement and mode of operation that produced these emissions are used for final measurements on the same test site. The analyzer is set to CISPR quasi-peak and average detectors with a 9kHz resolution bandwidth for final measurements.

An extension cord was used to connect to a single LISN which powered by EUT. The extension cord was calibrated with LISN, the impedance and insertion loss are compliance with the requirements as stated in ANSI C63.10-2013.

### 3.3. Radiated Emissions

The radiated test facilities consisted of an indoor 3 meter semi-anechoic chamber used for final measurements and exploratory measurements, when necessary. The measurement area is contained within the semi-anechoic chamber which is shielded from any ambient interference. For measurements above 1GHz absorbers are arranged on the floor between the turn table and the antenna mast in such a way so as to maximize the reduction of reflections. For measurements below 1GHz, the absorbers are removed. A MF Model 210SS turntable is used for radiated measurement. It is a continuously rotatable, remote controlled, metallic turntable and 2 meters (6.56 ft.) in diameter. The turn table is flush with the raised floor of the chamber in order to maintain its function as a ground plane. An 80cm high PVC support structure is placed on top of the turntable.

For all measurements, the spectrum was scanned through all EUT azimuths and from 1 to 4 meter receive antenna height using a broadband antenna from 30MHz up to the upper frequency shown in 15.33(b)(1) depending on the highest frequency generated or used in the device or on which the device operates or tunes. For frequencies above 1GHz, linearly polarized double ridge horn antennas were used. For frequencies below 30MHz, a calibrated loop antenna was used. When exploratory measurements were necessary, they were performed at 1 meter test distance inside the semi-anechoic chamber using broadband antennas, broadband amplifiers, and spectrum analyzers to determine the frequencies and modes producing the maximum emissions. Sufficient time for the EUT, support equipment, and test equipment was allowed in order for them to warm up to their normal operating condition. The test set-up for frequencies below 1GHz was placed on top of the 0.8 meter high, 1 x 1.5 meter table; and test set-up for frequencies 1-25GHz was placed on top of the 1.5 meter high, 1 x 1.5 meter table. The EUT, support equipment, and interconnecting cables were arranged and manipulated to maximize each emission. Appropriate precaution was taken to ensure that all emissions from the EUT were maximized and investigated. The system configuration, clock speed, mode of operation or video resolution, if applicable, turntable azimuth, and receive antenna height was noted for each frequency found.

Final measurements were made in the semi-anechoic chamber using calibrated, linearly polarized broadband and horn antennas. The test setup was configured to the setup that produced the worst case emissions. The spectrum analyzer was set to investigate all frequencies required for testing to compare the highest radiated disturbances with respect to the specified limits. The turntable containing the EUT was rotated through 360 degrees and the height of the receive antenna was varied 1 to 4 meters and stopped at the azimuth and height producing the maximum emission. Each emission was maximized by changing the orientation of the EUT through three orthogonal planes and changing the polarity of the receive antenna, whichever produced the worst-case emissions. According to 3dB Beam-Width of horn antenna, the horn antenna should be always directed to the EUT when rising height.

## 4. ANTENNA REQUIREMENTS

### Excerpt from §15.203 of the FCC Rules/Regulations:

“An intentional radiator antenna shall be designed to ensure that no antenna other than that furnished by the responsible party can be used with the device. The use of a permanently attached antenna or of an antenna that uses a unique coupling to the intentional radiator shall be considered sufficient to comply with the provisions of this section.”

- The antenna of the **Hobbyzone Duet RTF** is **permanently attached**.
- There are no provisions for connection to an external antenna.

### **Conclusion:**

The unit complies with the requirement of §15.203.

## 5. TEST EQUIPMENT CALIBRATION DATE

### Conducted Emissions - SR2

Instrument	Manufacturer	Type No.	Asset No.	Cali. Interval	Cali. Due Date
EMI Test Receiver	R&S	ESR3	MRTSUE06185	1 year	2019/04/20
Two-Line V-Network	R&S	ENV216	MRTSUE06002	1 year	2019/06/21
Two-Line V-Network	R&S	ENV216	MRTSUE06003	1 year	2019/06/21
Thermohygrometer	Testo	608-H1	MRTSUE06404	1 year	2019/08/14
Shielding Anechoic Chamber	Mikebang	Chamber-SR2	MRTSUE06215	1 year	2019/05/02

### Radiated Emissions - AC1

Instrument	Manufacturer	Type No.	Asset No.	Cali. Interval	Cali. Due Date
PXA Signal Analyzer	Keysight	9030B	MRTSUE06395	1 year	2019/09/13
EMI Test Receiver	R&S	ESR7	MRTSUE06001	1 year	2019/08/18
Loop Antenna	Schwarzbeck	FMZB1519	MRTSUE06025	1 year	2018/11/20
Bilog Period Antenna	Schwarzbeck	VULB 9168	MRTSUE06172	1 year	2018/11/18
Broad Band Horn Antenna	Schwarzbeck	BBHA9120D	MRTSUE06023	1 year	2018/10/21
Microwave System Amplifier	Agilent	83017A	MRTSUE06076	1 year	2018/11/17
Broad Band Horn Antenna	Schwarzbeck	BBHA 9170	MRTSUE06024	1 year	2018/12/14
Amplifier	Schwarzbeck	BBV 9721	MRTSUE06121	1 year	2019/06/14
Thermohygrometer	Testo	608-H1	MRTSUE06403	1 year	2019/08/14
Anechoic Chamber	TDK	Chamber-AC1	MRTSUE06212	1 year	2019/05/02

### Conducted Test Equipment - TR3

Instrument	Manufacturer	Type No.	Asset No.	Cali. Interval	Cali. Due Date
Spectrum Analyzer	Agilent	N9020A	MRTSUE06106	1 year	2019/04/20
Programmable Temperature & Humidity Chamber	BAOYT	BYH-1500L	MRTSUE06051	1 year	2018/12/06
Power Meter	Agilent	U2021XA	MRTSUE06030	1 year	2018/12/06
Thermohygrometer	Testo	608-H1	MRTSUE06401	1 year	2019/08/14

Software	Version	Function
e3	V 8.3.5	EMI Test Software

## 6. MEASUREMENT UNCERTAINTY

Where relevant, the following test uncertainty levels have been estimated for tests performed on the EUT as specified in CISPR 16-4-2. This uncertainty represents an expanded uncertainty expressed at approximately the 95% confidence level using a coverage factor of  $k = 2$ .

<b>AC Conducted Emission Measurement - SR2</b>
Measuring Uncertainty for a Level of Confidence of 95% ( $U=2Uc(y)$ ): 150kHz~30MHz: 3.46dB
<b>Radiated Emission Measurement – AC2</b>
Measuring Uncertainty for a Level of Confidence of 95% ( $U=2Uc(y)$ ): 9kHz ~ 1GHz: 3.84dB 1GHz ~ 25GHz: 4.33dB
<b>Spurious Emissions, Conducted - TR3</b>
Measuring Uncertainty for a Level of Confidence of 95% ( $U=2Uc(y)$ ): 0.78dB
<b>Output Power - TR3</b>
Measuring Uncertainty for a Level of Confidence of 95% ( $U=2Uc(y)$ ): 1.13dB
<b>Power Spectrum Density - TR3</b>
Measuring Uncertainty for a Level of Confidence of 95% ( $U=2Uc(y)$ ): 1.15dB
<b>Occupied Bandwidth - TR3</b>
Measuring Uncertainty for a Level of Confidence of 95% ( $U=2Uc(y)$ ): 0.28%

## 7. TEST RESULT

### 7.1. Summary

**Company Name:** Horizon Hobby, LLC  
**FCC ID:** BRWDUETARG1  
**IC:** 6157A-DUETARG1

FCC Part Section(s)	RSS Section(s)	Test Description	Test Limit	Test Condition	Test Result	Reference
15.247(a)(2)	RSS-247 [5.2]	6dB Bandwidth	$\geq 500\text{kHz}$	Conducted	Pass	Section 7.2
15.247(b)(3)	RSS-247 [5.4(d)]	Output Power	$\leq 1\text{Watt}$ & $\text{EIRP} \leq 4\text{Watt}$		Pass	Section 7.3
15.247(e)	RSS-247 [5.2]	Power Spectral Density	$\leq 8\text{dBm} / 3\text{kHz Band}$		Pass	Section 7.4
15.247(d)	RSS-247 [5.5]	Band Edge / Out-of-Band Emissions	$\geq 20\text{dBc(Peak)}$		Pass	Section 7.5
15.205 15.209	RSS-247 [5.5]	General Field Strength Limits (Restricted Bands and Radiated Emission Limits)	Emissions in restricted bands must meet the radiated limits detailed in 15.209	Radiated	Pass	Section 7.6 & 7.7
15.207	RSS-Gen [8.8]	AC Conducted Emissions 150kHz - 30MHz	$< \text{FCC 15.207 limits}$	Line Conducted	N/A	Section 7.8

#### Notes:

- 1) All modes of operation and data rates were investigated. For radiated emission test, every axis (X, Y, Z) was also verified. The test results shown in the following sections represent the worst case emissions.
- 2) The analyzer plots shown in this section were all taken with a correction table loaded into the analyzer. The correction table was used to account for the losses of the cables and attenuators used as part of the system to connect the EUT to the analyzer at all frequencies of interest.



## 7.2. 6dB Bandwidth & 99% Bandwidth Measurement

### 7.2.1. Test Limit

The minimum 6dB bandwidth shall be at least 500 kHz.

### 7.2.2. Test Procedure used

KDB 558074 D01v05 - Section 8.2

### 7.2.3. Test Setting

1. The Spectrum's automatic bandwidth measurement capability was used to perform the 6dB bandwidth measurement. The "X" dB bandwidth parameter was set to  $X = 6$ . The bandwidth measurement was not influenced by any intermediate power nulls in the fundamental emission.
2. Set RBW = 100 kHz
3. VBW  $\geq 3 \times$  RBW
4. Detector = Peak
5. Trace mode = max hold
6. Sweep = auto couple
7. Allow the trace was allowed to stabilize

### 7.2.4. Test Setup

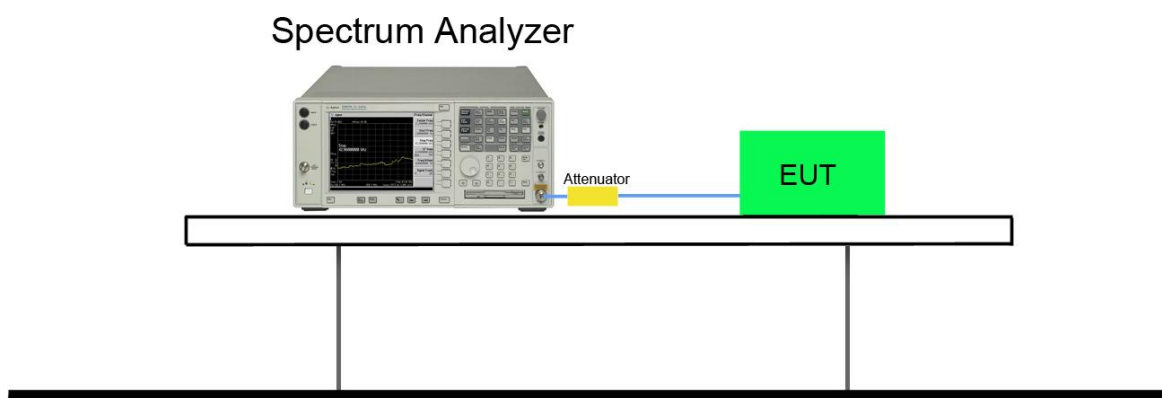

**7.2.5. Test Result**

Product	Hobbyzone Duet RTF	Temperature	25°C
Test Engineer	Ternence Wang	Relative Humidity	52%
Test Site	TR3	Test Date	2018/09/21

Test Mode	Modulation Mode	Channel No.	Frequency (MHz)	6dB Bandwidth (MHz)	99% Bandwidth (MHz)	Limit (MHz)	Result
802.15.4	O-QPSK	11	2405	1.62	2.60	≥ 0.5	Pass
802.15.4	O-QPSK	18	2440	1.62	2.59	≥ 0.5	Pass
802.15.4	O-QPSK	25	2475	1.61	2.59	≥ 0.5	Pass

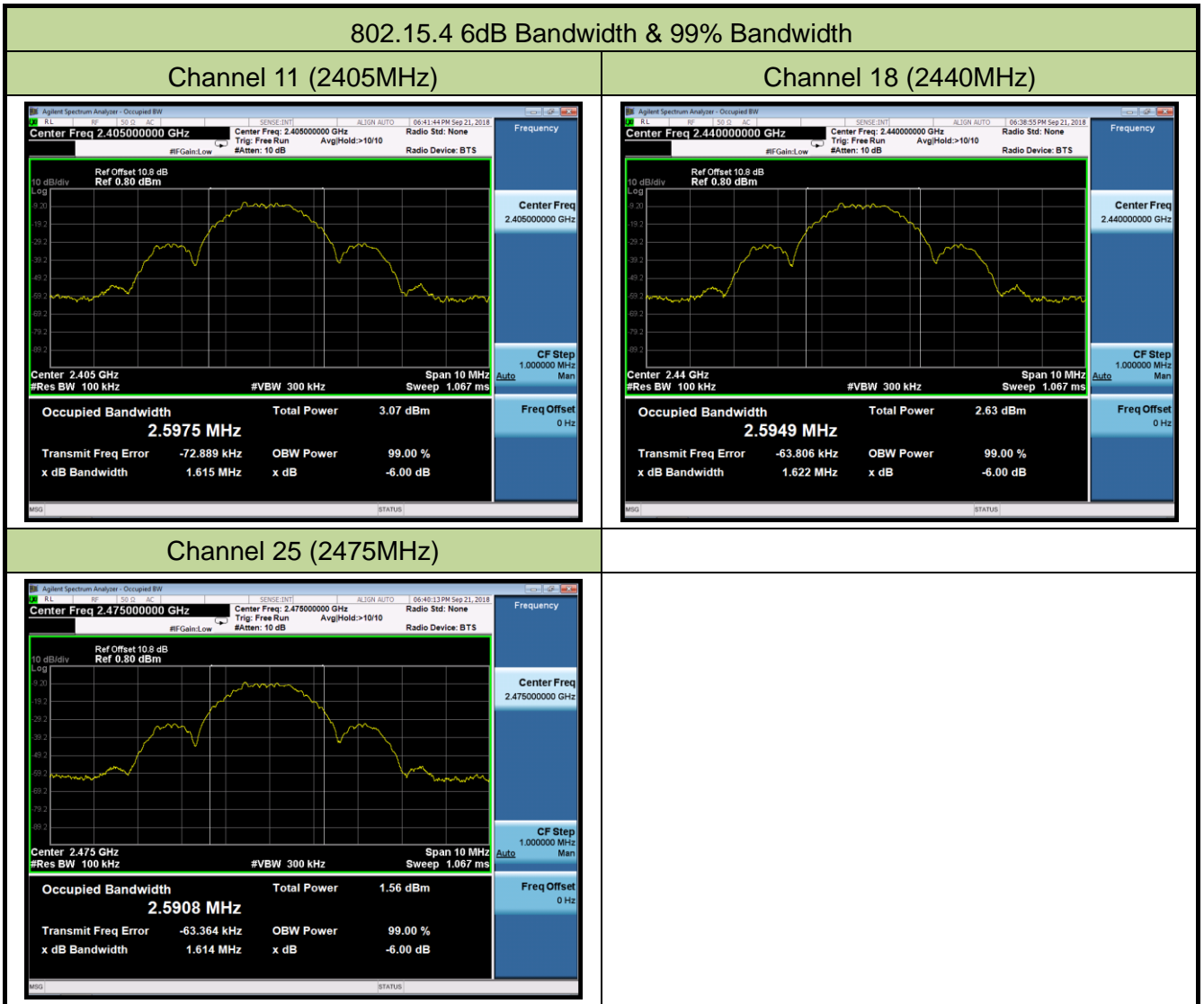

### 7.3. Output Power Measurement

#### 7.3.1. Test Limit

The maximum output power shall be less 1 Watt (30dBm) and the E.I.R.P shall not exceed 4 Watt (36dBm).

#### 7.3.2. Test Procedure Used

KDB 558074 D01v05 – Section 8.3.1.3 PKPM1 Peak-reading power meter method

KDB 558074 D01v05 - Section 8.3.2.3 Method AVGPM-G

#### 7.3.3. Test Setting

##### **Method PKPM1 (Peak Power Measurement)**

Peak power measurements were performed only when the EUT was transmitting at its maximum power control level using a broadband power meter with a pulse sensor. The pulse sensor employs a VBW = 50MHz so this method was only used for signals whose DTS bandwidth was less than or equal to 50MHz.

##### **Method AVGPM-G (Measurement using a gated RF average-reading power meter)**

Measurements may be performed using a wideband gated RF power meter provided that the gate parameters are adjusted such that the power is measured only when the EUT is transmitting at its maximum power control level. Since this measurement is made only during the ON time of the transmitter, no duty cycle correction is required.

#### 7.3.4. Test Setup

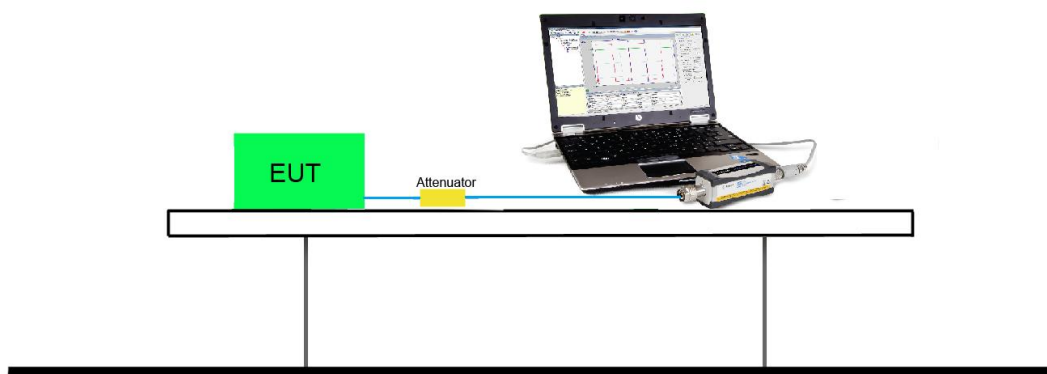

### 7.3.5. Test Result

Product	Hobbyzone Duet RTF	Temperature	25°C
Test Engineer	Ternence Wang	Relative Humidity	52%
Test Site	TR3	Test Date	2018/09/21
Test Item	Peak Output Power		

Test Mode	Modulation Mode	Channel No.	Frequency (MHz)	Peak Output Power (dBm)	Limit (dBm)	E.I.R.P (dBm)	Limit (dBm)	Result
802.15.4	O-QPSK	11	2405	-2.43	≤ 30.00	-1.43	≤ 36.00	Pass
802.15.4	O-QPSK	18	2440	-2.72	≤ 30.00	-1.72	≤ 36.00	Pass
802.15.4	O-QPSK	25	2475	-3.89	≤ 30.00	-2.89	≤ 36.00	Pass

Note: E.I.R.P (dBm) = Peak Output Power (dBm) + Antenna Gain (dBi).

Product	Hobbyzone Duet RTF	Temperature	25°C
Test Engineer	Ternence Wang	Relative Humidity	52%
Test Site	TR3	Test Date	2018/09/21
Test Item	Average Output Power (Report Only)		

Test Mode	Modulation Mode	Channel No.	Frequency (MHz)	Average Output Power (dBm)	Limit (dBm)	E.I.R.P (dBm)	Limit (dBm)	Result
802.15.4	O-QPSK	11	2405	-4.93	≤ 30.00	-3.93	≤ 36.00	Pass
802.15.4	O-QPSK	18	2440	-5.18	≤ 30.00	-4.18	≤ 36.00	Pass
802.15.4	O-QPSK	25	2475	-6.39	≤ 30.00	-5.39	≤ 36.00	Pass

Note: E.I.R.P (dBm) = Average Output Power (dBm) + Antenna Gain (dBi).

## 7.4. Power Spectral Density Measurement

### 7.4.1. Test Limit

The maximum permissible power spectral density is 8dBm in any 3 kHz band.

### 7.4.2. Test Procedure Used

KDB 558074 D01v05 - Section 8.4 Method PKPSD

### 7.4.3. Test Setting

1. Analyzer was set to the center frequency of the DTS channel under investigation
2. Span = 1.5 times the DTS channel bandwidth
3. RBW = 3kHz
4. VBW = 10kHz
5. Detector = peak
6. Sweep time = auto couple
7. Trace mode = max hold
8. Trace was allowed to stabilize

### 7.4.4. Test Setup

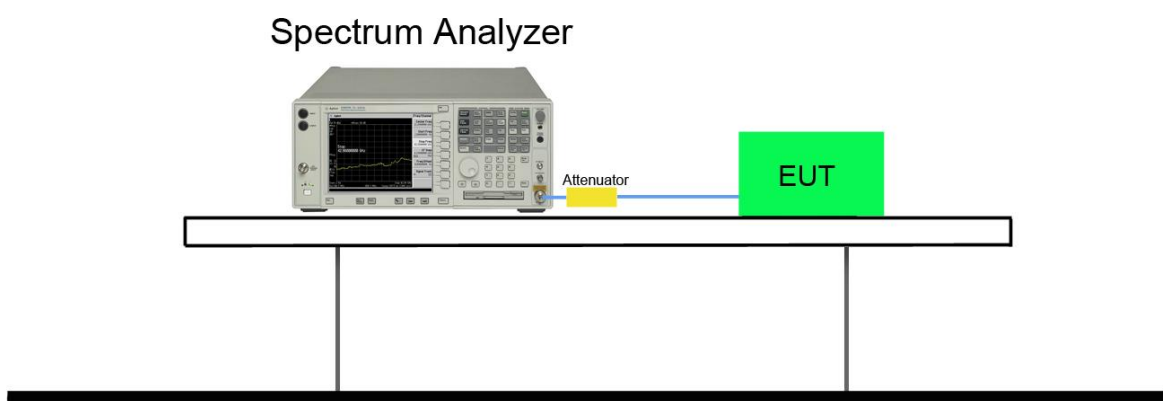

**7.4.5. Test Result**

Product	Hobbyzone Duet RTF	Temperature	25°C
Test Engineer	Ternence Wang	Relative Humidity	52%
Test Site	TR3	Test Date	2018/09/21

Test Mode	Modulation Mode	Channel No.	Frequency (MHz)	Measured PSD (dBm / 3kHz)	Limit (dBm / 3kHz)	Result
802.15.4	O-QPSK	11	2405	-14.99	≤ 8.00	Pass
802.15.4	O-QPSK	18	2440	-15.28	≤ 8.00	Pass
802.15.4	O-QPSK	25	2475	-16.43	≤ 8.00	Pass

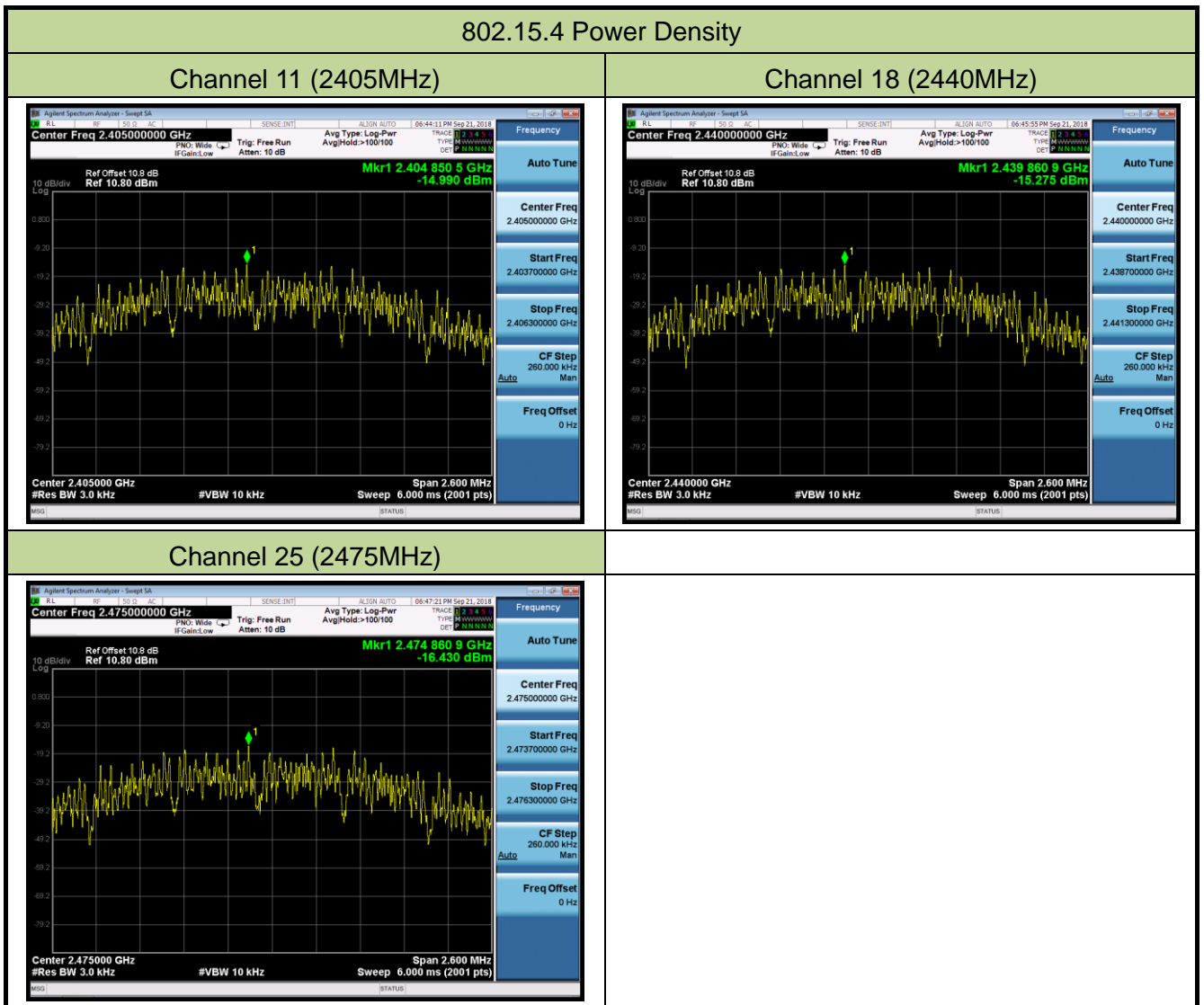

## **7.5. Conducted Band Edge and Out-of-Band Emissions**

### **7.5.1. Test Limit**

The limit for out-of-band spurious emissions at the band edge is 20dB below the fundamental emission level, as determined from the in-band power measurement of the DTS channel performed in a 100 kHz bandwidth per the PSD procedure.

### **7.5.2. Test Procedure Used**

KDB 558074 D01v05 - Section 8.7

### **7.5.3. Test Setting**

#### **1. Reference level measurement**

1. Set instrument center frequency to DTS channel center frequency
2. Set the span to  $\geq 1.5$  times the DTS bandwidth
3. Set the RBW = 100 kHz
4. Set the VBW  $\geq 3 \times$  RBW
5. Detector = peak
6. Sweep time = auto couple
7. Trace mode = max hold
8. Allow trace to fully stabilize

#### **2. Emission level measurement**

- (a) Set the center frequency and span to encompass frequency range to be measured
- (b) RBW = 100kHz
- (c) VBW = 300kHz
- (d) Detector = Peak
- (e) Trace mode = max hold
- (f) Sweep time = auto couple
- (g) The trace was allowed to stabilize



### 7.5.4. Test Setup

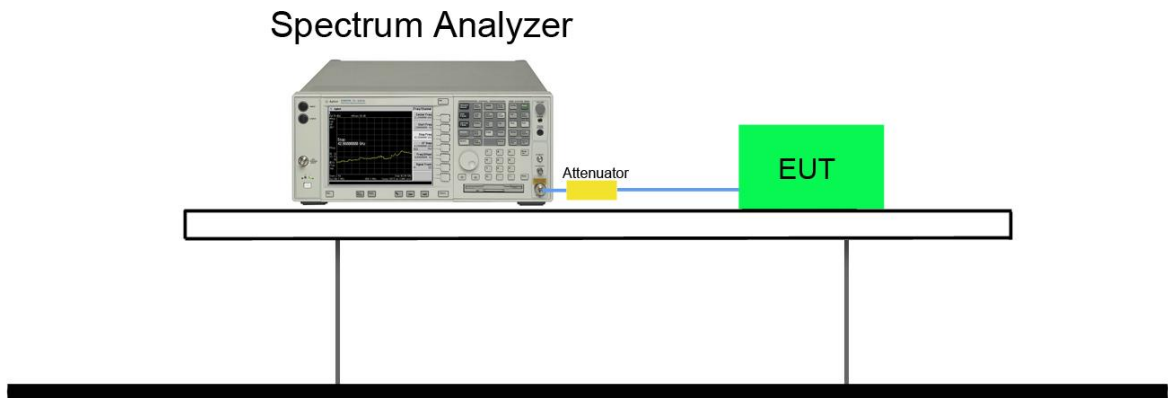

### 7.5.5. Test Result

Product	Hobbyzone Duet RTF	Temperature	25°C
Test Engineer	Ternence Wang	Relative Humidity	52%
Test Site	TR3	Test Date	2018/09/21

Test Mode	Modulation Mode	Channel No.	Frequency (MHz)	Limit	Result
802.15.4	O-QPSK	11	2405	20dBc	Pass
802.15.4	O-QPSK	18	2440	20dBc	Pass
802.15.4	O-QPSK	25	2475	20dBc	Pass

#### 802.15.4 Out-of-Band Emissions

##### Channel 11 (2405MHz)

###### 100kHz PSD reference Level



###### Low Band Edge

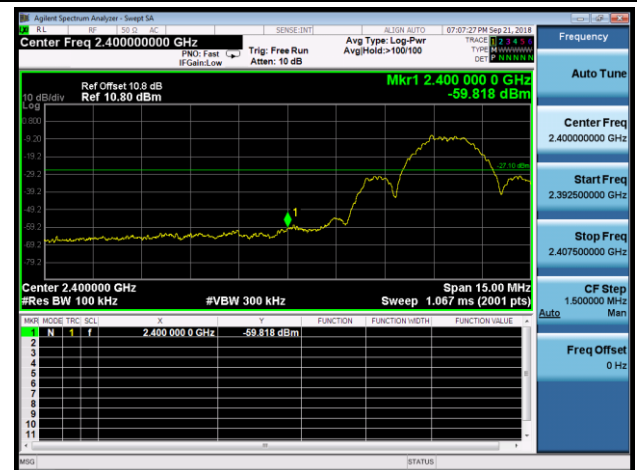

###### Spurious Emission

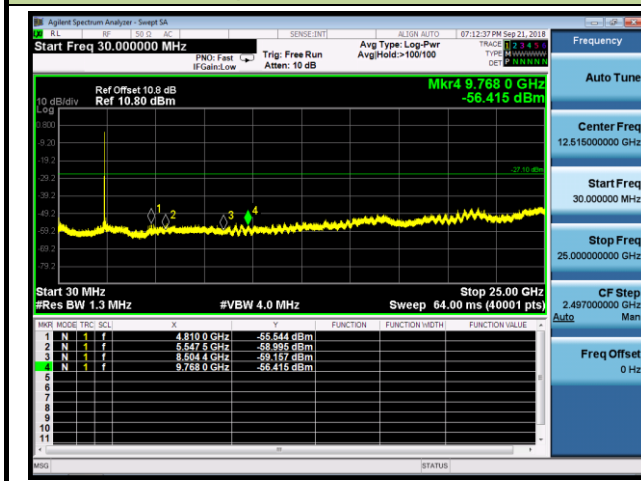

### Channel 18 (2440MHz)

#### 100kHz PSD reference Level



#### Spurious Emission

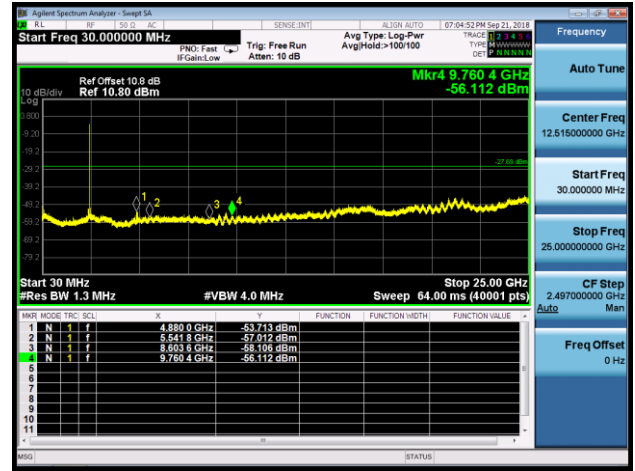

### Channel 25 (2475MHz)

#### 100kHz PSD reference Level



#### High Band Edge

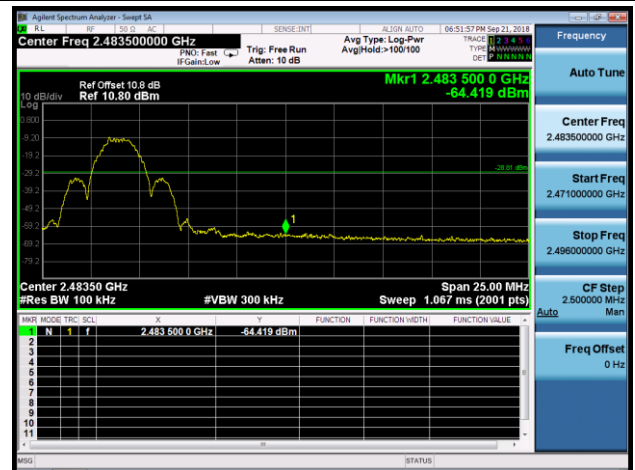

#### Spurious Emission

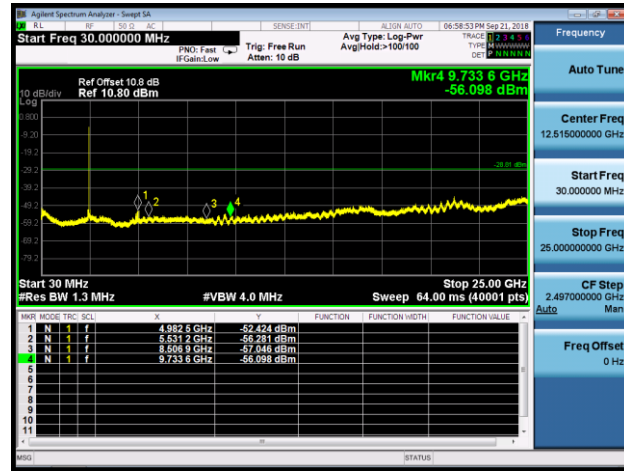

## 7.6. Radiated Spurious Emission Measurement

### 7.6.1. Test Limit

All out of band emissions appearing in a restricted band as specified in Section 15.205 of the Title 47 CFR must not exceed the limits shown in Table per Section 15.209.

FCC Part 15 Subpart C Paragraph 15.209 & RSS-Gen		
Frequency (MHz)	Field Strength (uV/m)	Measurement Distance (m)
0.009 ~ 0.490	2400/F(kHz)	300
0.490 ~ 1.705	24000/F(kHz)	30
1.705 ~ 30.0	30	30
30 ~ 80	100**	3
80 ~ 216	150**	3
216 ~ 960	200**	3
Above 960	500	3

### 7.6.2. Test Procedure Used

KDB 558074 D01v05 – Section 8.5 & 8.6

### 7.6.3. Test Setting

#### Quasi-Peak Measurements below 1GHz

1. Analyzer center frequency was set to the frequency of the radiated spurious emission of interest
2. Span was set greater than 1MHz
3. RBW = as specified in Table 1
4. Detector = CISPR quasi-peak or average
5. Sweep time = auto couple
6. Trace was allowed to stabilize

**Table 1 - RBW as a function of frequency**

Frequency	RBW
9 ~ 150 kHz	200 ~ 300 Hz
0.15 ~ 30 MHz	9 ~ 10 kHz
30 ~ 1000 MHz	100 ~ 120 kHz

**Peak Measurements above 1GHz**

1. Analyzer center frequency was set to the frequency of the radiated spurious emission of interest
2. RBW = 1MHz
3. VBW = 3MHz
4. Detector = peak
5. Sweep time = auto couple
6. Trace mode = max hold
7. Trace was allowed to stabilize

**Average Measurements above 1GHz (Method VB)**

1. Analyzer center frequency was set to the frequency of the radiated spurious emission of interest
2. RBW = 1MHz
3. VBW; If the EUT is configured to transmit with duty cycle  $\geq 98\%$ , set VBW = 10 Hz.  
If the EUT duty cycle is  $< 98\%$ , set VBW  $\geq 1/T$ . T is the minimum transmission duration.
4. Detector = Peak
5. Sweep time = auto
6. Trace mode = max hold
7. Trace was allowed to stabilize

### 7.6.4. Test Setup

#### 9kHz ~ 30MHz Test Setup:

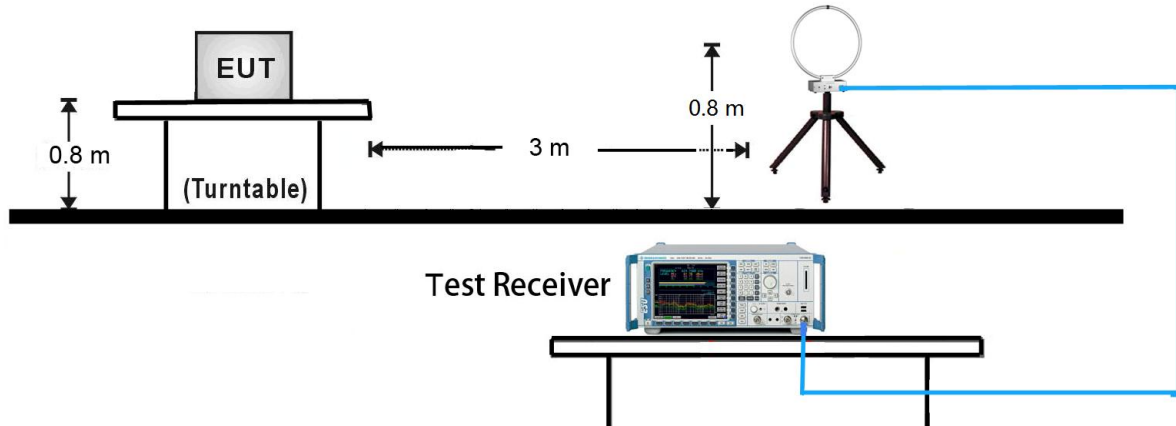

#### 30MHz ~ 1GHz Test Setup:

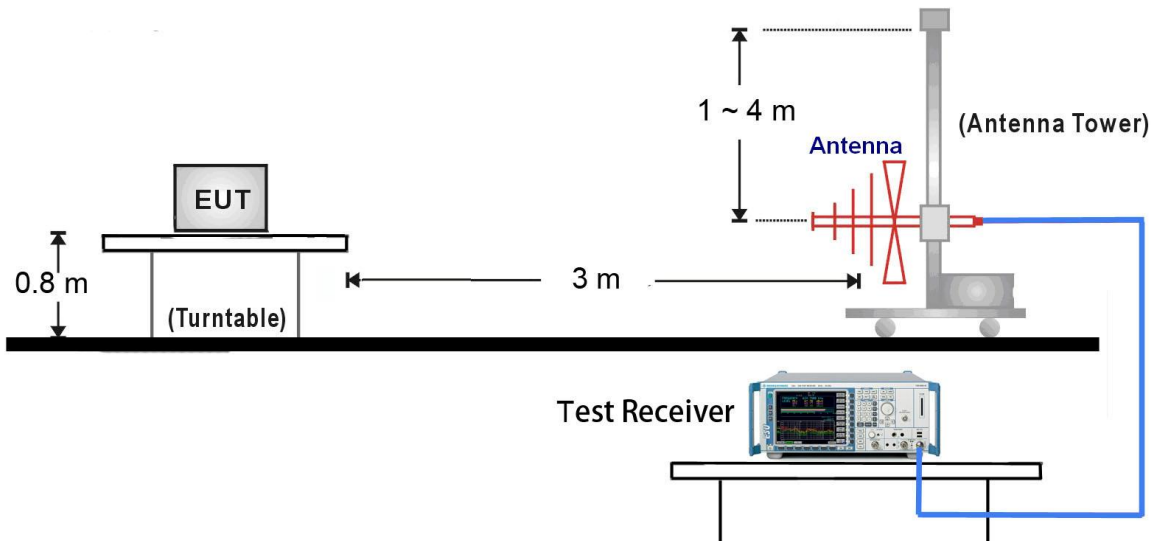

#### 1GHz ~ 25GHz Test Setup:

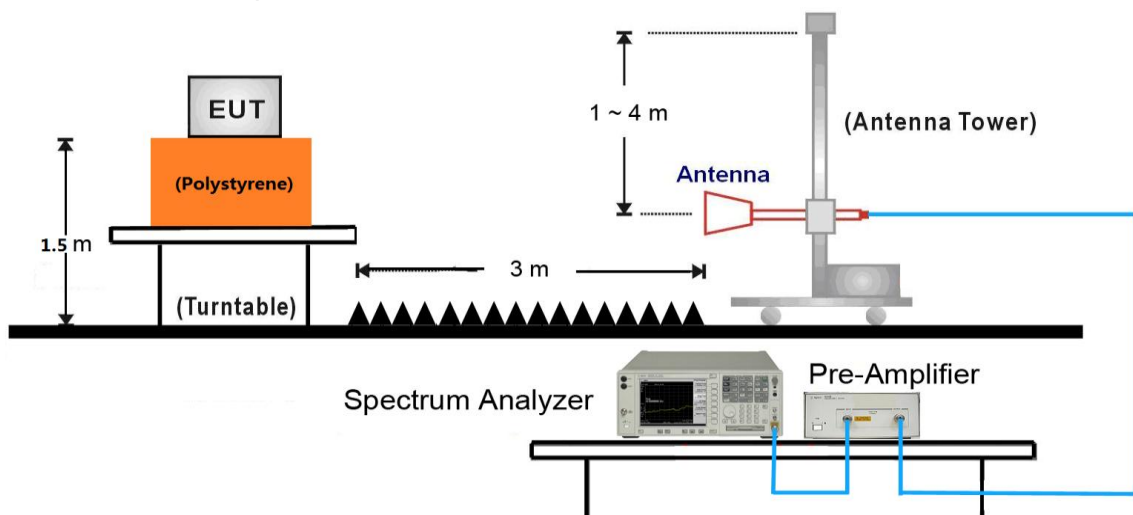

### 7.6.5. Test Result

Product	Hobbyzone Duet RTF	Temperature	26°C
Test Engineer	Cat Hu	Relative Humidity	56%
Test Site	AC2	Test Date	2018/09/19
Test Mode:	802.15.4	Test Channel:	11
Remark:	1. Average measurement was not performed if peak level lower than average limit. 2. Other frequency was 20dB below limit line within 1-18GHz, there is not show in the report.		

Mark	Frequency (MHz)	Reading Level (dBμV)	Factor (dB)	Measure Level (dBμV/m)	Limit (dBμV/m)	Margin (dB)	Detector	Polarization
	4952.5	39.6	5.7	45.3	74.0	-28.7	Peak	Horizontal
	7425.0	32.2	14.2	46.4	74.0	-27.6	Peak	Horizontal
*	9900.0	30.7	17.3	48.0	74.0	-26.0	Peak	Horizontal
*	12968.0	29.8	21.4	51.2	74.0	-22.8	Peak	Horizontal
	4950.0	34.9	5.7	40.6	74.0	-33.4	Peak	Vertical
	7425.0	31.8	14.2	46.0	74.0	-28.0	Peak	Vertical
*	9900.0	30.2	17.3	47.5	74.0	-26.5	Peak	Vertical
*	12891.5	28.5	21.1	49.6	74.0	-24.4	Peak	Vertical

Note 1: "\*" is not in restricted band, its limit is 20dBc of the fundamental emission level (88.9dBμV/m) or 15.209 which is higher.

Note 2: Measure Level (dBμV/m) = Reading Level (dBμV) + Factor (dB)

Factor (dB) = Cable Loss (dB) + Antenna Factor (dB/m) – Pre\_Amplifier Gain (dB)



Product	Hobbyzone Duet RTF	Temperature	26°C
Test Engineer	Cat Hu	Relative Humidity	56%
Test Site	AC2	Test Date	2018/09/19
Test Mode:	802.15.4	Test Channel:	18
Remark:	1. Average measurement was not performed if peak level lower than average limit. 2. Other frequency was 20dB below limit line within 1-18GHz, there is not show in the report.		

Mark	Frequency (MHz)	Reading Level (dBμV)	Factor (dB)	Measure Level (dBμV/m)	Limit (dBμV/m)	Margin (dB)	Detector	Polarization
	4880.0	36.9	5.6	42.5	74.0	-31.5	Peak	Horizontal
	7320.0	32.2	13.8	46.0	74.0	-28.0	Peak	Horizontal
*	9760.0	31.8	16.9	48.7	74.0	-25.3	Peak	Horizontal
*	13172.0	30.9	21.5	52.4	74.0	-21.6	Peak	Horizontal
	4880.0	34.0	5.6	39.6	74.0	-34.4	Peak	Vertical
	7320.0	31.8	13.8	45.6	74.0	-28.4	Peak	Vertical
*	9760.0	32.4	16.9	49.3	74.0	-24.7	Peak	Vertical
*	13112.5	30.9	21.5	52.4	74.0	-21.6	Peak	Vertical

Note 1: "\*" is not in restricted band, its limit is 20dBc of the fundamental emission level (89.8dBμV/m) or 15.209 which is higher.

Note 2: Measure Level (dBμV/m) = Reading Level (dBμV) + Factor (dB)

Factor (dB) = Cable Loss (dB) + Antenna Factor (dB/m) – Pre\_Amplifier Gain (dB)

Product	Hobbyzone Duet RTF	Temperature	26°C
Test Engineer	Cat Hu	Relative Humidity	56%
Test Site	AC2	Test Date	2018/09/19
Test Mode:	802.15.4	Test Channel:	25
Remark:	1. Average measurement was not performed if peak level lower than average limit. 2. Other frequency was 20dB below limit line within 1-18GHz, there is not show in the report.		

Mark	Frequency (MHz)	Reading Level (dBμV)	Factor (dB)	Measure Level (dBμV/m)	Limit (dBμV/m)	Margin (dB)	Detector	Polarization
	4808.0	40.4	5.5	45.9	74.0	-28.1	Peak	Horizontal
	8174.0	33.3	14.4	47.7	74.0	-26.3	Peak	Horizontal
*	8624.5	33.1	14.3	47.4	74.0	-26.6	Peak	Horizontal
*	9620.0	32.6	16.2	48.8	74.0	-25.2	Peak	Horizontal
	3949.5	37.6	2.4	40.0	74.0	-34.0	Peak	Vertical
	4810.0	34.1	5.5	39.6	74.0	-34.4	Peak	Vertical
*	7919.0	33.1	14.6	47.7	74.0	-26.3	Peak	Vertical
*	9620.0	31.6	16.2	47.8	74.0	-26.2	Peak	Vertical

Note 1: "\*" is not in restricted band, its limit is 20dBc of the fundamental emission level (92.1dBμV/m) or 15.209 which is higher.

Note 2: Measure Level (dBμV/m) = Reading Level (dBμV) + Factor (dB)

Factor (dB) = Cable Loss (dB) + Antenna Factor (dB/m) – Pre\_Amplifier Gain (dB)

**The worst case of Radiated Emission below 1GHz:**

Site: AC2	Time: 2018/09/19 - 17:42
Limit: FCC_Part15.209_RE(3m)	Engineer: Cat Hu
Probe: VULB9162_0.03-8GHz	Polarity: Horizontal
EUT: Hobbyzone Duet RTF	Power: By Battery
<b>Worse Case Mode:</b> Transmit by 802.15.4 at Channel 2405MHz	

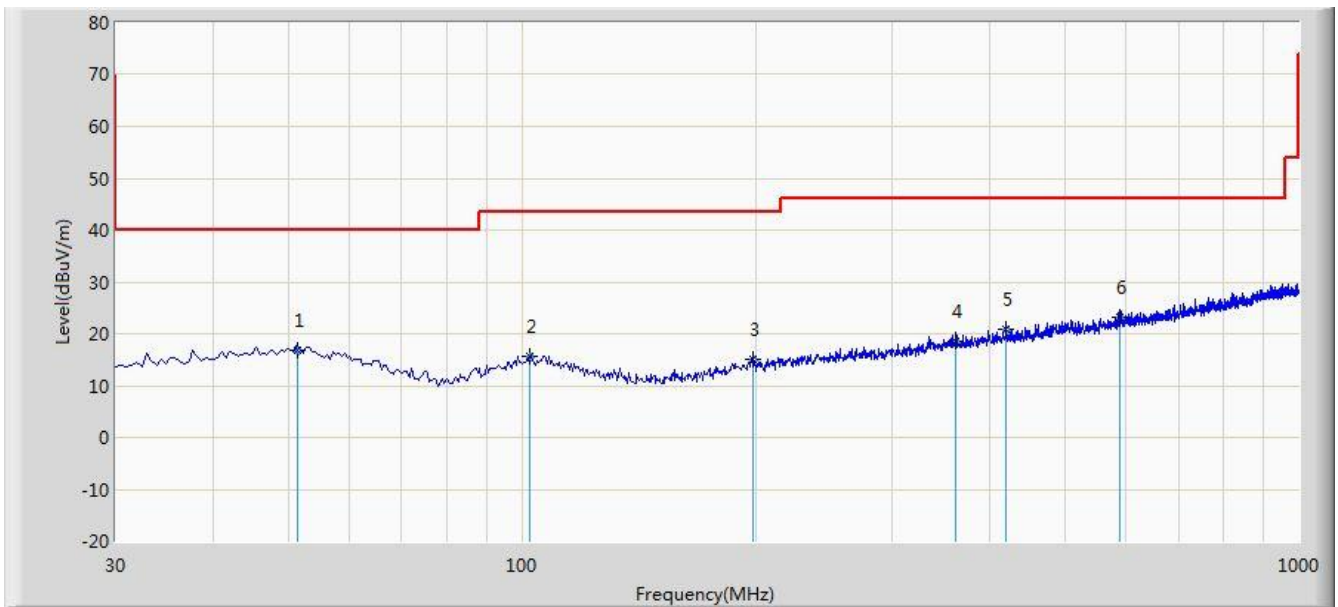

No	Flag	Mark	Frequency (MHz)	Measure Level (dBuV/m)	Reading Level (dBuV)	Over Limit (dB)	Limit (dBuV/m)	Factor (dB)	Type
1			51.326	16.687	1.658	-23.313	40.000	15.029	QP
2			102.265	15.679	2.321	-27.821	43.500	13.358	QP
3		*	198.515	14.996	2.515	-28.504	43.500	12.481	QP
4			362.150	18.609	2.266	-27.391	46.000	16.343	QP
5			419.250	20.989	3.650	-25.011	46.000	17.339	QP
6			589.360	23.139	2.850	-22.861	46.000	20.289	QP

Note 1: Measure Level (dB $\mu$ V/m) = Reading Level (dB $\mu$ V) + Factor (dB)

Factor (dB) = Cable Loss (dB) + Antenna Factor (dB/m)

Note 2: The test trace is same as the ambient noise and the amplitude of the emissions are attenuated more than 20dB below the permissible (the test frequency range: 9kHz ~ 30MHz, 18GHz ~ 25GHz), therefore no data appear in the report.

Site: AC2	Time: 2018/09/19 - 17:46
Limit: FCC_Part15.209_RE(3m)	Engineer: Cat Hu
Probe: VULB9162_0.03-8GHz	Polarity: Vertical
EUT: Hobbyzone Duet RTF	Power: By Battery
<b>Worse Case Mode:</b> Transmit by 802.15.4 at Channel 2405MHz	

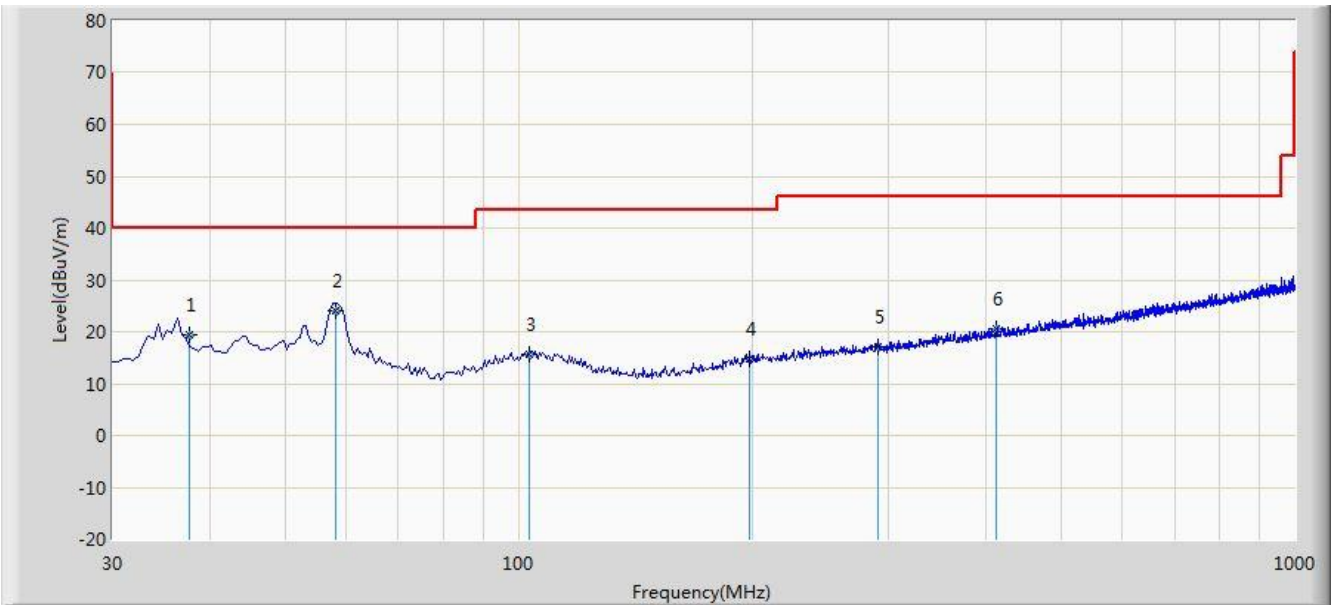

No	Flag	Mark	Frequency (MHz)	Measure Level (dBuV/m)	Reading Level (dBuV)	Over Limit (dB)	Limit (dBuV/m)	Factor (dB)	Type
1			37.658	19.379	5.856	-20.621	40.000	13.523	QP
2		*	58.030	24.007	9.680	-15.993	40.000	14.327	QP
3			103.363	15.590	2.265	-27.910	43.500	13.325	QP
4			198.125	14.733	2.260	-28.767	43.500	12.473	QP
5			290.066	17.159	2.515	-28.841	46.000	14.644	QP
6			413.360	20.470	3.215	-25.530	46.000	17.255	QP

Note 1: Measure Level (dBμV/m) = Reading Level (dBμV) + Factor (dB)

Factor (dB) = Cable Loss (dB) + Antenna Factor (dB/m)

Note 2: The test trace is same as the ambient noise and the amplitude of the emissions are attenuated more than 20dB below the permissible (the test frequency range: 9kHz ~ 30MHz, 18GHz ~ 25GHz), therefore no data appear in the report.

## 7.7. Radiated Restricted Band Edge Measurement

### 7.7.1. Test Limit

#### **For 15.205 requirement:**

Radiated emissions which fall in the restricted bands, as defined in Section 15.205(a) of FCC part 15, must also comply with the radiated emission limits specified in Section 15.209(a).

Frequency (MHz)	Frequency (MHz)	Frequency (MHz)	Frequency (GHz)
0.090 - 0.110	16.42 - 16.423	399.9 - 410	4.5 - 5.15
<sup>1</sup> 0.495 - 0.505	16.69475 - 16.69525	608 - 614	5.35 - 5.46
2.1735 - 2.1905	16.80425 - 16.80475	960 - 1240	7.25 - 7.75
4.125 - 4.128	25.5 - 25.67	1300 - 1427	8.025 - 8.5
4.17725 - 4.17775	37.5 - 38.25	1435 - 1626.5	9.0 - 9.2
4.20725 - 4.20775	73 - 74.6	1645.5 - 1646.5	9.3 - 9.5
6.215 - 6.218	74.8 - 75.2	1660 - 1710	10.6 - 12.7
6.26775 - 6.26825	108 - 121.94	1718.8 - 1722.2	13.25 - 13.4
6.31175 - 6.31225	123 - 138	2200 - 2300	14.47 - 14.5
8.291 - 8.294	149.9 - 150.05	2310 - 2390	15.35 - 16.2
8.362 - 8.366	156.52475 - 156.525	2483.5 - 2500	17.7 - 21.4
8.37625 - 8.38675	156.7 - 156.9	2690 - 2900	22.01 - 23.12
8.41425 - 8.41475	162.0125 - 167.17	3260 - 3267	23.6 - 24.0
12.29 - 12.293	167.72 - 173.2	3332 - 3339	31.2 - 31.8
12.51975 - 12.52025	240 - 285	3345.8 - 3358	36.43 - 36.5
12.57675 - 12.57725	322 - 335.4	3600 - 4400	( <sup>2</sup> )
13.36 - 13.41	--	--	--

All out of band emissions appearing in a restricted band as specified in Section 15.205 of the Title 47CFR must not exceed the limits shown in Table per Section 15.209.

FCC Part 15 Subpart C Paragraph 15.209		
Frequency (MHz)	Field Strength (uV/m)	Measurement Distance (m)
0.009 ~ 0.490	2400/F(kHz)	300
0.490 ~ 1.705	24000/F(kHz)	30
1.705 ~ 30.0	30	30
30 ~ 80	100**	3
80 ~ 216	150**	3
216 ~ 960	200**	3
Above 960	500	3

**For RSS-Gen Section 8.10 requirement:**

Radiated emissions which fall in the restricted bands, as defined in Section 8.10 of RSS-Gen, must also comply with the radiated emission limits specified in Section 8.9.

Frequency (MHz)	Frequency (MHz)	Frequency (MHz)
0.009 - 0.110	149.9 -150.5	9.0 - 9.2
0.495 -0.505	156.52475 - 156.525225	9.3 - 9.5
2.1735 - 2.1905	156.7 - 156.9	10.6 - 12.7
3.020 - 3.026	162.0125 - 167.17	13.25 - 13.4
4.125 - 4.128	167.72 - 173.2	14.47 - 14.5
4.17725 - 4.17775	240 - 285	15.35 - 16.2
4.20725 - 4.20775	322 - 335.4	17.7 - 21.4
5.677 - 5.683	399.9 - 410	22.01 - 23.12
6.215 - 6.218	608 - 614	23.6 - 24.0
6.26775 - 6.26825	960 - 1427	31.2 - 31.8
6.31175 - 6.31225	1435 - 1626.5	36.43 - 36.5
8.291 - 8.294	1645.5 - 1646.5	Above 38.6
8.362 - 8.366	1660 - 1710	--
8.37625 - 8.38675	1718.8 -1722.2	
8.41425 - 8.41475	2200 - 2300	
12.29 - 12.293	2310 -2390	
12.51975 - 12.52025	2483.5 - 2500	
12.57675 - 12.57725	2655 - 2900	
13.36 -13.41	3260 - 3267	
16.42 - 16.423	3332 -3339	
16.69475 - 16.69525	334.5 - 3358	
16.80425 - 16.80475	3500 - 4400	
25.5 - 25.67	4500 - 5150	
37.5 - 38.25	5350 - 5460	
73 - 74.6	7250 - 7750	
74.8 - 75.2	8025 - 8500	
108 - 138	--	

All out of band emissions appearing in a restricted band as specified in Section 8.10 of the RSS-Gen must not exceed the limits shown in Table per Section 8.9.



RSS-Gen Section 8.9		
Frequency (MHz)	Field Strength (uV/m)	Measurement Distance (m)
0.009 ~ 0.490	2400/F(kHz)	300
0.490 ~ 1.705	24000/F(kHz)	30
1.705 ~ 30.0	30	30
30 ~ 80	100**	3
80 ~ 216	150**	3
216 ~ 960	200**	3
Above 960	500	3

**7.7.2. Test Procedure Used**

ANSI C63.10 Section 6.3 (General Requirements)

ANSI C63.10 Section 6.6 (Standard test method above 1GHz)

**7.7.3. Test Setting**

**Peak Field Strength Measurements**

1. Analyzer center frequency was set to the frequency of the radiated spurious emission of interest
2. RBW = 1MHz
3. VBW = 3MHz
4. Detector = peak
5. Sweep time = auto couple
6. Trace mode = max hold
7. Trace was allowed to stabilize

### Average Field Strength Measurements

1. Analyzer center frequency was set to the frequency of the radiated spurious emission of interest
2. RBW = 1MHz
3. VBW  $\geq 1/T$
4. De As an alternative, the instrument may be set to linear detector mode. Ensure that video filtering is applied in linear voltage domain (rather than in a log or dB domain). Some instruments require linear display mode in order to accomplish this. Others have a setting for Average-VBW Type, which can be set to "Voltage" regardless of the display mode
5. Detector = Peak
6. Sweep time = auto
7. Trace mode = max hold
8. Allow max hold to run for at least 50 times (1/duty cycle) traces

#### 7.7.4. Test Setup

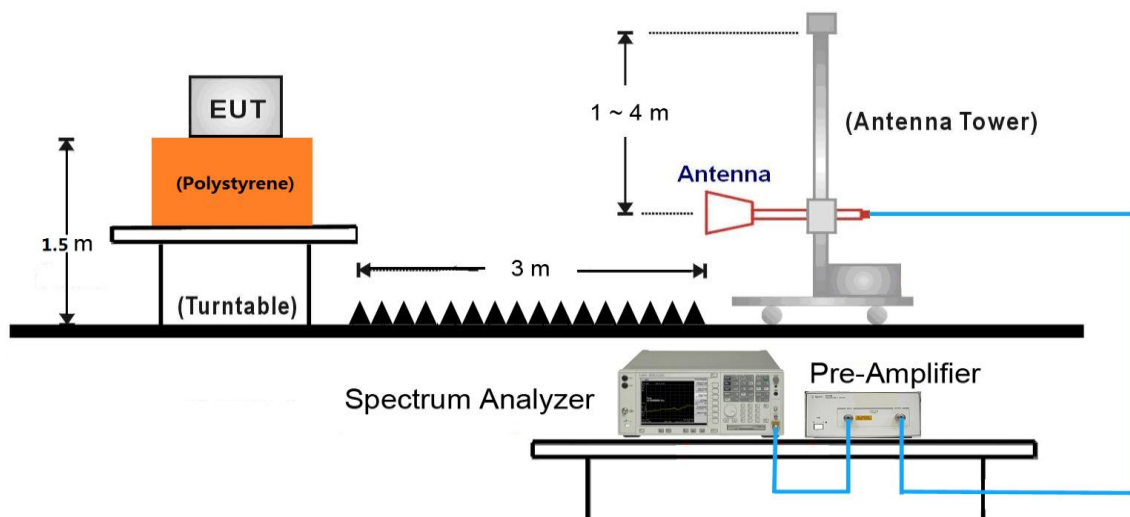

### 7.7.5. Test Result

Site: AC2	Time: 2018/09/19 - 18:49
Limit: FCC_Part15.209_RE(3m)	Engineer: Cat Hu
Probe: BBHA9120D_1-18GHz	Polarity: Horizontal
EUT: Hobbyzone Duet RTF	Power: By Battery
Test mode: Transmit by 802.15.4 at Channel 2405MHz	

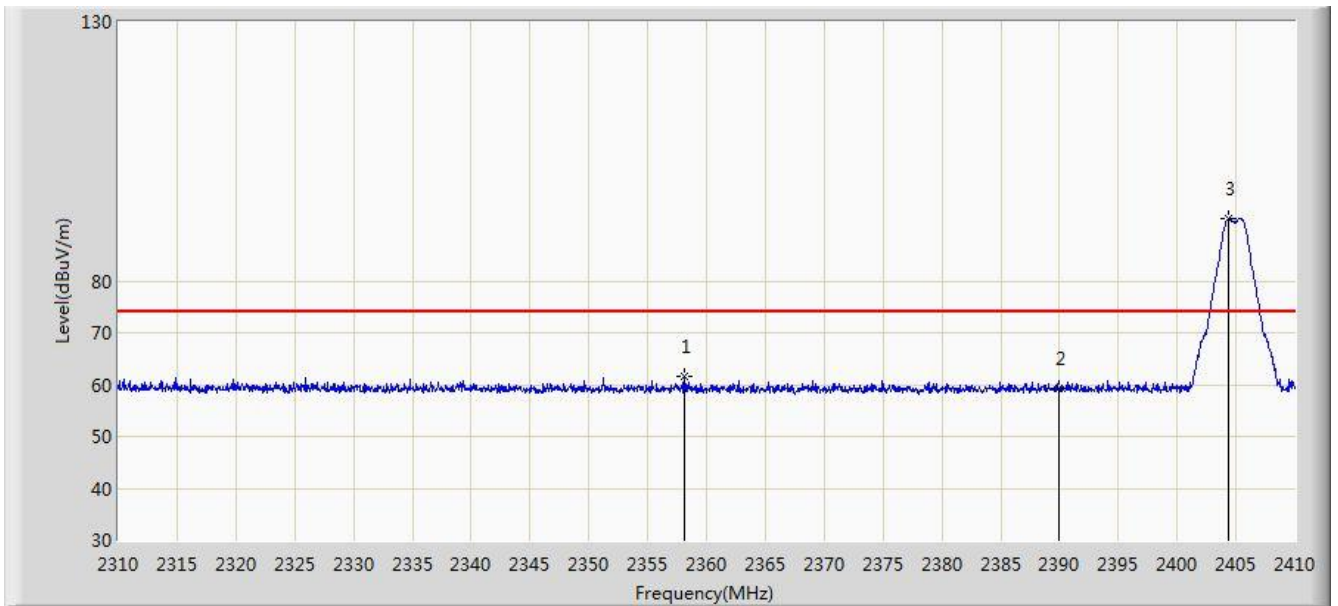

No	Flag	Mark	Frequency (MHz)	Measure Level (dBuV/m)	Reading Level (dBuV)	Over Limit (dB)	Limit (dBuV/m)	Factor (dB)	Type
1			2358.100	61.529	28.903	-12.471	74.000	32.626	PK
2			2390.000	59.414	26.839	-14.586	74.000	32.575	PK
3		*	2404.400	92.156	59.600	N/A	N/A	32.557	PK

Note: Measure Level (dB $\mu$ V/m) = Reading Level (dB $\mu$ V) + Factor (dB)

Factor (dB) = Cable Loss (dB) + Antenna Factor (dB/m).

Site: AC2	Time: 2018/09/19 - 18:51
Limit: FCC_Part15.209_RE(3m)	Engineer: Cat Hu
Probe: BBHA9120D_1-18GHz	Polarity: Horizontal
EUT: Hobbyzone Duet RTF	Power: By Battery
Test mode: Transmit by 802.15.4 at Channel 2405MHz	

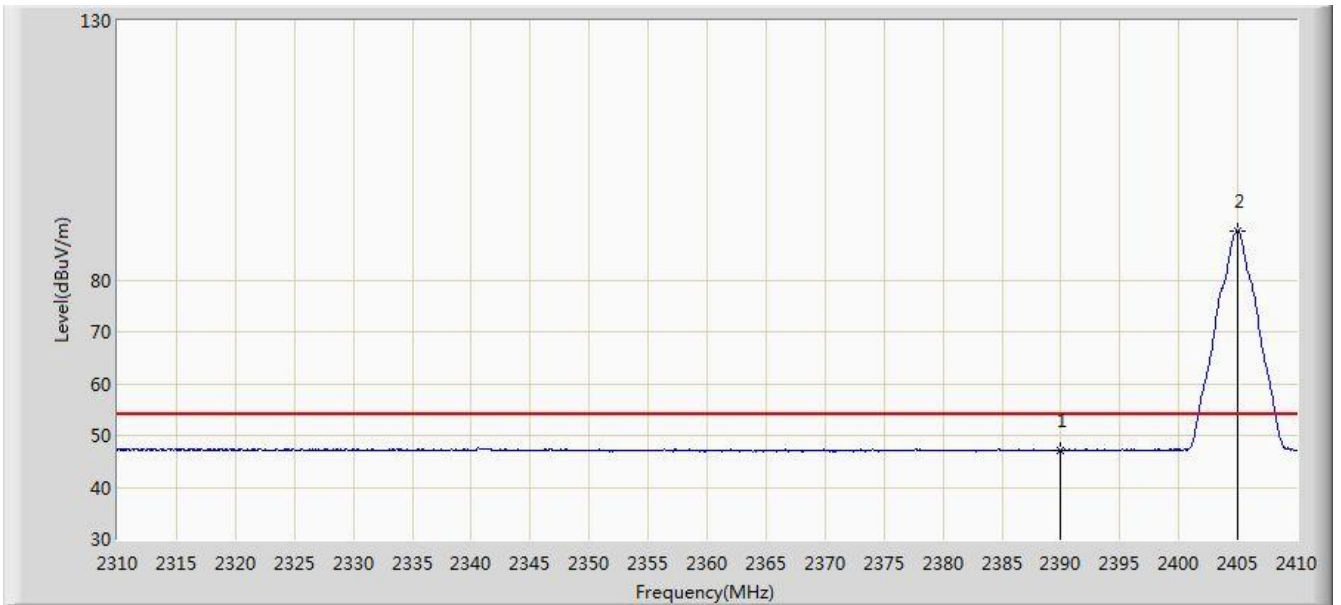

No	Flag	Mark	Frequency (MHz)	Measure Level (dBuV/m)	Reading Level (dBuV)	Over Limit (dB)	Limit (dBuV/m)	Factor (dB)	Type
1			2390.000	47.147	14.572	-6.853	54.000	32.575	AV
2		*	2404.950	89.486	56.930	N/A	N/A	32.555	AV

Note: Measure Level (dB $\mu$ V/m) = Reading Level (dB $\mu$ V) + Factor (dB)

Factor (dB) = Cable Loss (dB) + Antenna Factor (dB/m).

Site: AC2	Time: 2018/09/19 - 18:53
Limit: FCC_Part15.209_RE(3m)	Engineer: Cat Hu
Probe: BBHA9120D_1-18GHz	Polarity: Vertical
EUT: Hobbyzone Duet RTF	Power: By Battery
Test mode: Transmit by 802.15.4 at Channel 2405MHz	

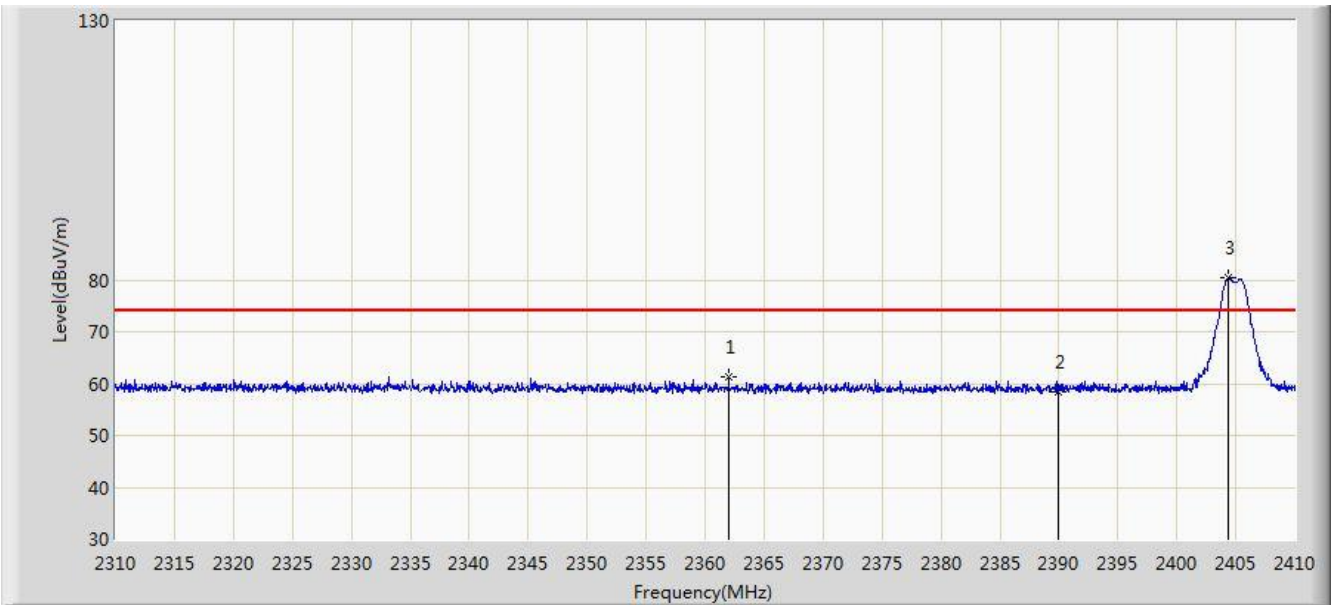

No	Flag	Mark	Frequency (MHz)	Measure Level (dBuV/m)	Reading Level (dBuV)	Over Limit (dB)	Limit (dBuV/m)	Factor (dB)	Type
1			2362.000	61.229	28.609	-12.771	74.000	32.620	PK
2			2390.000	58.506	25.931	-15.494	74.000	32.575	PK
3		*	2404.400	80.491	47.935	N/A	N/A	32.557	PK

Note: Measure Level (dB $\mu$ V/m) = Reading Level (dB $\mu$ V) + Factor (dB)

Factor (dB) = Cable Loss (dB) + Antenna Factor (dB/m).

Site: AC2	Time: 2018/09/19 - 18:54
Limit: FCC_Part15.209_RE(3m)	Engineer: Cat Hu
Probe: BBHA9120D_1-18GHz	Polarity: Vertical
EUT: Hobbyzone Duet RTF	Power: By Battery
Test mode: Transmit by 802.15.4 at Channel 2405MHz	

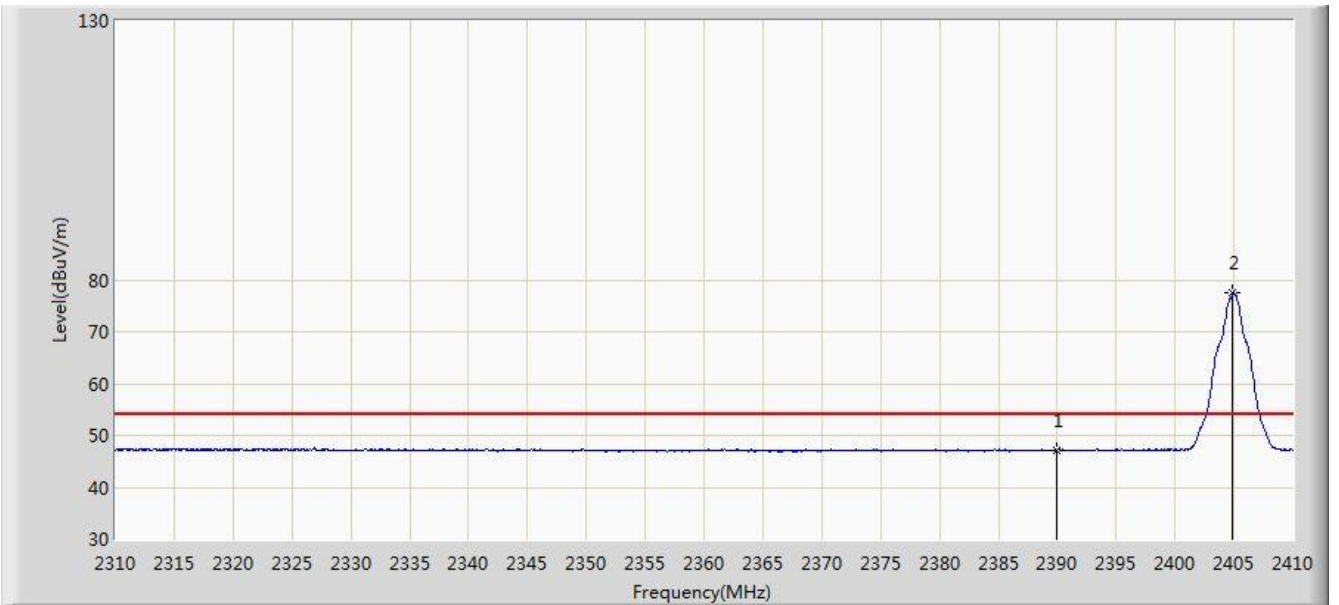

No	Flag	Mark	Frequency (MHz)	Measure Level (dBuV/m)	Reading Level (dBuV)	Over Limit (dB)	Limit (dBuV/m)	Factor (dB)	Type
1			2390.000	47.166	14.591	-6.834	54.000	32.575	AV
2		*	2404.900	77.442	44.886	N/A	N/A	32.555	AV

Note: Measure Level (dB $\mu$ V/m) = Reading Level (dB $\mu$ V) + Factor (dB)

Factor (dB) = Cable Loss (dB) + Antenna Factor (dB/m).

Site: AC2	Time: 2018/09/19 - 19:03
Limit: FCC_Part15.209_RE(3m)	Engineer: Cat Hu
Probe: BBHA9120D_1-18GHz	Polarity: Horizontal
EUT: Hobbyzone Duet RTF	Power: By Battery
Test mode: Transmit by 802.15.4 at Channel 2475MHz	

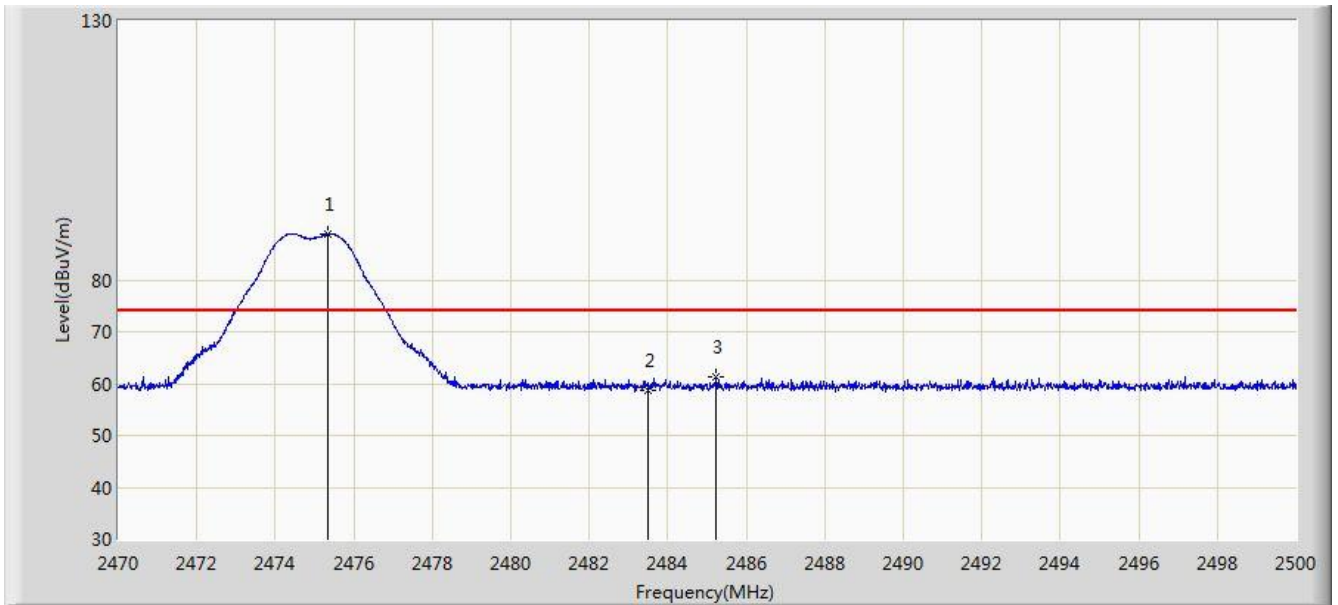

No	Flag	Mark	Frequency (MHz)	Measure Level (dBuV/m)	Reading Level (dBuV)	Over Limit (dB)	Limit (dBuV/m)	Factor (dB)	Type
1		*	2475.355	88.859	56.284	N/A	N/A	32.575	PK
2			2483.500	58.678	26.082	-15.322	74.000	32.596	PK
3			2485.240	61.163	28.563	-12.837	74.000	32.600	PK

Note: Measure Level (dB $\mu$ V/m) = Reading Level (dB $\mu$ V) + Factor (dB)

Factor (dB) = Cable Loss (dB) + Antenna Factor (dB/m).

Site: AC2	Time: 2018/09/19 - 19:06
Limit: FCC_Part15.209_RE(3m)	Engineer: Cat Hu
Probe: BBHA9120D_1-18GHz	Polarity: Horizontal
EUT: Hobbyzone Duet RTF	Power: By Battery
Test mode: Transmit by 802.15.4 at Channel 2475MHz	

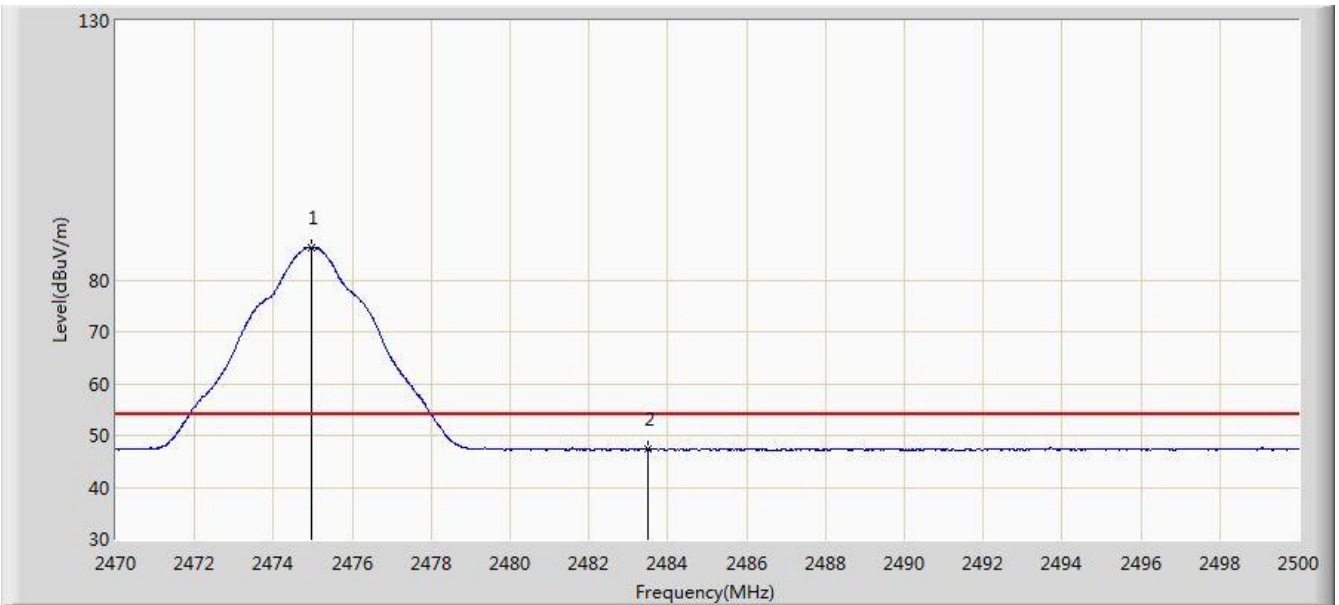

No	Flag	Mark	Frequency (MHz)	Measure Level (dBuV/m)	Reading Level (dBuV)	Over Limit (dB)	Limit (dBuV/m)	Factor (dB)	Type
1		*	2474.965	86.369	53.795	N/A	N/A	32.573	AV
2			2483.500	47.404	14.808	-6.596	54.000	32.596	AV

Note: Measure Level (dBuV/m) = Reading Level (dBuV) + Factor (dB)

Factor (dB) = Cable Loss (dB) + Antenna Factor (dB/m).



Site: AC2	Time: 2018/09/19 - 19:07
Limit: FCC_Part15.209_RE(3m)	Engineer: Cat Hu
Probe: BBHA9120D_1-18GHz	Polarity: Vertical
EUT: Hobbyzone Duet RTF	Power: By Battery
Test mode: Transmit by 802.15.4 at Channel 2475MHz	

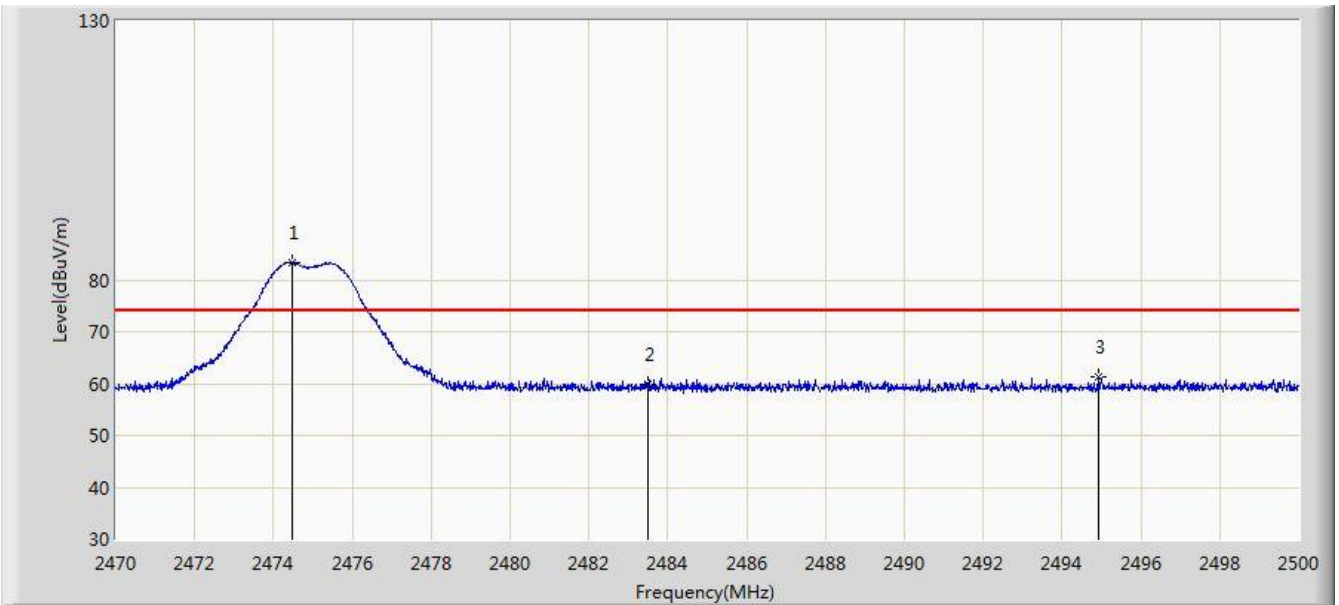

No	Flag	Mark	Frequency (MHz)	Measure Level (dBuV/m)	Reading Level (dBuV)	Over Limit (dB)	Limit (dBuV/m)	Factor (dB)	Type
1		*	2474.470	83.320	50.748	N/A	N/A	32.572	PK
2			2483.500	59.930	27.334	-14.070	74.000	32.596	PK
3			2494.915	61.378	28.754	-12.622	74.000	32.624	PK

Note: Measure Level (dB $\mu$ V/m) = Reading Level (dB $\mu$ V) + Factor (dB)

Factor (dB) = Cable Loss (dB) + Antenna Factor (dB/m).

Site: AC2	Time: 2018/09/19 - 19:08
Limit: FCC_Part15.209_RE(3m)	Engineer: Cat Hu
Probe: BBHA9120D_1-18GHz	Polarity: Vertical
EUT: Hobbyzone Duet RTF	Power: By Battery
Test mode: Transmit by 802.15.4 at Channel 2475MHz	

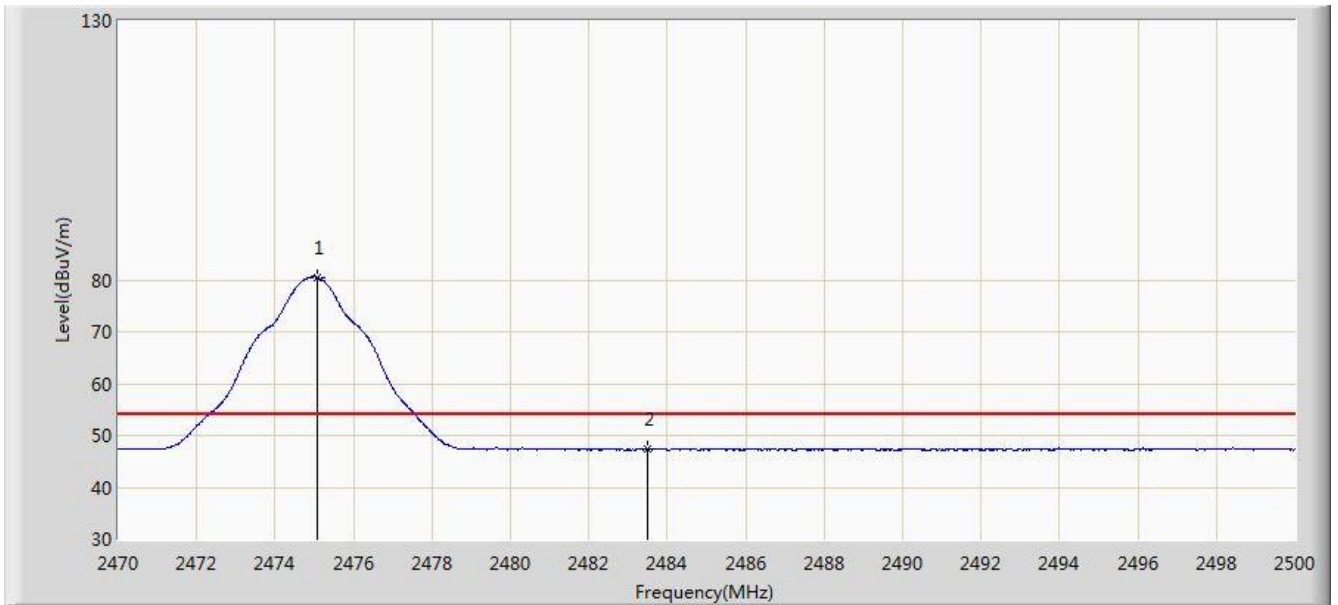

No	Flag	Mark	Frequency (MHz)	Measure Level (dBuV/m)	Reading Level (dBuV)	Over Limit (dB)	Limit (dBuV/m)	Factor (dB)	Type
1		*	2475.070	80.481	47.907	N/A	N/A	32.574	AV
2			2483.500	47.412	14.816	-6.588	54.000	32.596	AV

Note: Measure Level (dB $\mu$ V/m) = Reading Level (dB $\mu$ V) + Factor (dB)

Factor (dB) = Cable Loss (dB) + Antenna Factor (dB/m).

## 7.8. AC Conducted Emissions Measurement

### 7.8.1. Test Limit

FCC 15.107 & RSS-Gen Limits		
Frequency (MHz)	QP (dBuV)	AV (dBuV)
0.15 ~ 0.50	66 ~ 56	56 ~ 46
0.50 ~ 5.0	56	46
5.0 ~ 30	60	50

Note 1: The lower limit shall apply at the transition frequencies.

Note 2: The limit decreases linearly with the logarithm of the frequency in the range 0.15MHz to 0.5MHz.

### 7.8.2. Test Setup

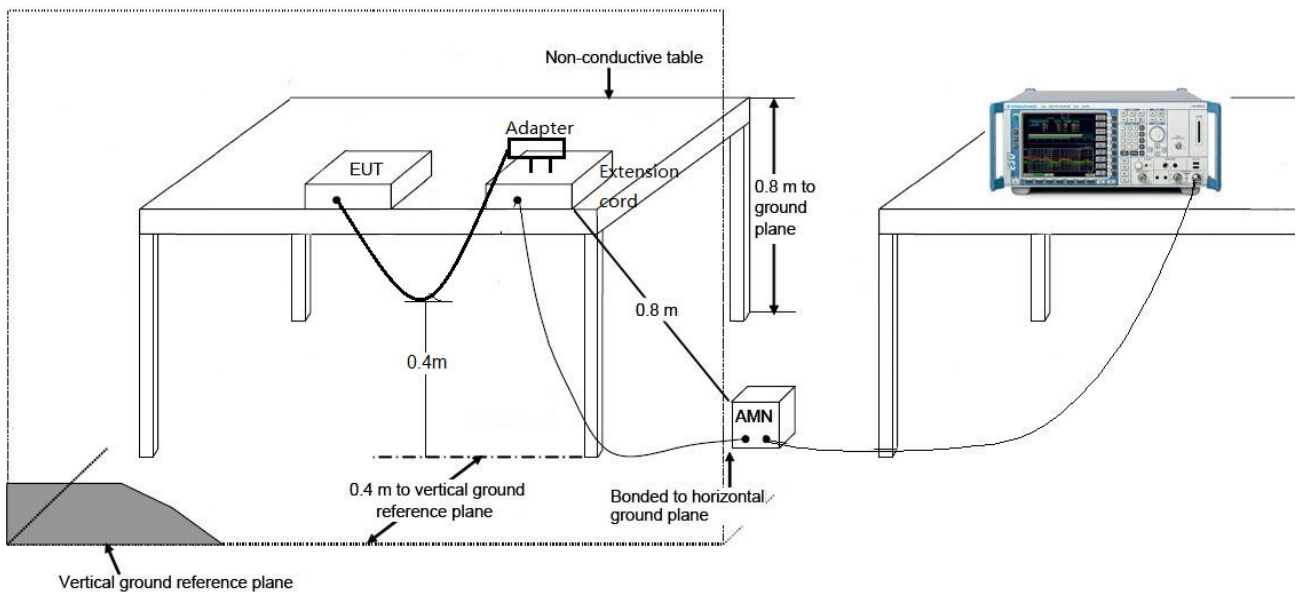

### 7.8.3. Test Result

The EUT is powered by battery, so this requirement does not apply.

## 8. CONCLUSION

The data collected relate only the item(s) tested and show that the **Hobbyzone Duet RTF** is in compliance with Part 15C of the FCC Rules and ISED Rules.

---

The End

## Appendix A – Test Setup Photograph

Refer to “1809RSU015-UT” file.

## Appendix B – EUT Photograph

Refer to “1809RSU015-UE” file.