



MEASUREMENT REPORT

FCC PART 15.249 / RSS-210

FCC ID: BRWDL SRXL2RR1
IC: 6157A-DLSSRXL2RR1
Application: Horizon Hobby, LLC

Application Type: Certification
Product: DSMX SRXL2 Remote Receiver
Model No.: SPM9747
Brand Name: Spektrum
FCC Classification: Part 15 low power transceiver, RX verified (DXT)
FCC Rule Part(s): Part 15.249
IC Rule(s): RSS-210 Issue 9, RSS-GEN Issue 5
Test Procedure(s): ANSI C63.10 - 2013
Test Date: June 10 ~ 13, 2019

Reviewed By: *Sunny Sun*

(Sunny Sun)

Approved By: *Robin Wu*

(Robin Wu)



The test results relate only to the samples tested.

This equipment has been shown to be capable of compliance with the applicable technical standards as indicated in the measurement report and was tested in accordance with the measurement procedures specified in ANSI C63.10-2013. Test results reported herein relate only to the item(s) tested.

The test report shall not be reproduced except in full without the written approval of MRT Technology (Suzhou) Co., Ltd.

Revision History

| Report No. | Version | Description | Issue Date | Note |
|---------------|---------|----------------|------------|-------|
| 1906RSU007-U1 | Rev. 01 | Initial Report | 06-21-2019 | Valid |
| | | | | |

CONTENTS

| Description | Page |
|--|-----------|
| 1. INTRODUCTION | 6 |
| 1.1. Scope | 6 |
| 1.2. MRT Test Location | 6 |
| 2. PRODUCT INFORMATION | 7 |
| 2.1. Equipment Description | 7 |
| 2.2. Operation Frequency and Channel List..... | 7 |
| 2.3. Test Configuration | 8 |
| 2.4. EMI Suppression Device(s)/Modifications | 8 |
| 2.5. Labeling Requirements | 8 |
| 3. DESCRIPTION OF TEST | 9 |
| 3.1. Evaluation Procedure | 9 |
| 3.2. AC Line Conducted Emissions..... | 9 |
| 3.3. Radiated Emissions..... | 10 |
| 4. ANTENNA REQUIREMENTS | 11 |
| 5. TEST EQUIPMENT CALIBRATION DATE | 12 |
| 6. MEASUREMENT UNCERTAINTY | 14 |
| 7. TEST RESULT | 15 |
| 7.1. Summary | 15 |
| 7.2. Conducted Emission | 16 |
| 7.2.1. Test Limit | 16 |
| 7.2.2. Test Setup | 16 |
| 7.2.3. Test Result..... | 16 |
| 7.3. Radiated Emission | 17 |
| 7.3.1. Test Limit | 17 |
| 7.3.2. Test Setup | 18 |
| 7.3.3. Test Result..... | 19 |
| 7.4. Radiated Restricted Band Edge Measurement | 24 |
| 7.4.1. Test Limit | 24 |
| 7.4.2. Test Setup | 27 |
| 7.4.3. Test Result..... | 28 |
| 7.5. 20dB Spectrum Bandwidth Measurement | 32 |
| 7.5.1. Test Limit | 32 |
| 7.5.2. Test Procedure used | 32 |

| | | |
|-----------|--|-----------|
| 7.5.3. | Test Setting..... | 32 |
| 7.5.4. | Test Setup | 32 |
| 7.5.5. | Test Result..... | 33 |
| 7.6. | 99% Bandwidth Measurement | 34 |
| 7.6.1. | Test Limit | 34 |
| 7.6.2. | Test Procedure used | 34 |
| 7.6.3. | Test Setting..... | 34 |
| 7.6.4. | Test Setup | 34 |
| 7.6.5. | Test Result..... | 35 |
| 8. | CONCLUSION..... | 36 |
| | Appendix A - Test Setup Photograph..... | 37 |
| | Appendix B - EUT Photograph | 38 |

§2.1033 General Information

| | |
|--------------------------------|---|
| Applicant: | Horizon Hobby, LLC |
| Applicant Address: | 2904 Research Rd. Champaign, IL 61822 |
| Manufacturer: | Horizon Hobby, LLC |
| Manufacturer Address: | 2904 Research Rd. Champaign, IL 61822 |
| Test Site: | MRT Technology (Suzhou) Co., Ltd |
| Test Site Address: | D8 Building, No.2 Tian'edang Rd., Wuzhong Economic Development Zone, Suzhou, China |
| Test Device Serial No.: | N/A <input type="checkbox"/> Production <input checked="" type="checkbox"/> Pre-Production <input type="checkbox"/> Engineering |

Test Facility / Accreditations

Measurements were performed at MRT Laboratory located in Tian'edang Rd., Suzhou, China.

- MRT facility is a FCC registered (MRT Reg. No. 893164) test facility with the site description report on file and has met all the requirements specified in ANSI C63.4-2014.
- MRT facility is an IC registered (MRT Reg. No. 11384A-1) test laboratory with the site description on file at Industry Canada.
- MRT facility is a VCCI registered (R-20025, G-20034, C-20020, T-20020) test laboratory with the site description on file at VCCI Council.
- MRT Lab is accredited to ISO 17025 by the American Association for Laboratory Accreditation (A2LA) under the American Association for Laboratory Accreditation Program (A2LA Cert. No. 3628.01) in EMC, Telecommunications, Radio and SAR testing.



1. INTRODUCTION

1.1. Scope

Measurement and determination of electromagnetic emissions (EMC) of radio frequency devices including intentional and/or unintentional radiators for compliance with the technical rules and regulations of the Federal Communications Commission and the Industry Canada Certification and Engineering Bureau.

1.2. MRT Test Location

The map below shows the location of the MRT LABORATORY, its proximity to the Taihu Lake. These measurement tests were conducted at the MRT Technology (Suzhou) Co., Ltd. Facility located at D8 Building, No.2 Tian'edang Rd., Wuzhong Economic Development Zone, Suzhou, China. The measurement facility compliant with the test site requirements specified in ANSI C63.4-2014.



2. PRODUCT INFORMATION

2.1. Equipment Description

| | |
|---------------------|----------------------------|
| Product Name: | DSMX SRXL2 Remote Receiver |
| Model No.: | SPM9747 |
| Brand Name: | Spektrum |
| Frequency Range: | 2404 ~ 2476 MHz |
| Channel Number: | 23 |
| Type of Modulation: | GFSK |
| Antenna Gain: | 2dBi |

2.2. Operation Frequency and Channel List

| Channel | Frequency | Channel | Frequency |
|---------|-----------|---------|-----------|
| 01 | 2404 MHz | 02 | 2412 MHz |
| 03 | 2416 MHz | 04 | 2418 MHz |
| 05 | 2422 MHz | 06 | 2424 MHz |
| 07 | 2426 MHz | 08 | 2428 MHz |
| 09 | 2430 MHz | 10 | 2432 MHz |
| 11 | 2434 MHz | 12 | 2438 MHz |
| 13 | 2440 MHz | 14 | 2444 MHz |
| 15 | 2452 MHz | 16 | 2460 MHz |
| 17 | 2462 MHz | 18 | 2464 MHz |
| 19 | 2466 MHz | 20 | 2468 MHz |
| 21 | 2470 MHz | 22 | 2472 MHz |
| 23 | 2476 MHz | --- | --- |

Note: The engineer test sample was provided by the manufacturer, it was configured into fixed frequency T_x status after power on.

2.3. Test Configuration

The EUT was tested as described in this report is in compliance with the requirements limits of FCC Rules Part 15.207, 15.209, 15.215 and 15.249. ANSI C63.10-2013 was used to reference the appropriate EUT setup for radiated spurious emissions testing and AC line conducted testing.

2.4. EMI Suppression Device(s)/Modifications

No EMI suppression device(s) were added and/or no modifications were made during testing.

2.5. Labeling Requirements

Per 2.1074 & 15.19; Docket 95-19

The label shall be permanently affixed at a conspicuous location on the device; instruction manual or pamphlet supplied to the user and be readily visible to the purchaser at the time of purchase. However, when the device is so small wherein placement of the label with specified statement is not practical, only the FCC ID must be displayed on the device per Section 15.19(a)(5). Please see attachment for FCC ID label and label location.

RSP-100 Issue 11 Section 3

The manufacturer, importer or distributor shall meet the labeling requirements set out in this section for every unit:

- (i) prior to marketing in Canada, for products manufactured in Canada
- (ii) prior to importation into Canada, for imported products

For information regarding the e-labeling option, see Notice 2014–DRS1003. The label for the certified product represents the manufacturer's or importer's compliance with Innovation, Science and Economic Development Canada's (ISED) regulatory requirements.

Please see attachment for IC label and label location.

3. DESCRIPTION OF TEST

3.1. Evaluation Procedure

The measurement procedures described in the American National Standard for Testing Unlicensed Wireless Devices (ANSI C63.10-2013), and the requirements provided in FCC 15.207, 15.209, 15.215 and 15.249 were performed in the report of the EUT.

Deviation from measurement procedure.....None

3.2. AC Line Conducted Emissions

The line-conducted facility is located inside an 8'x4'x4' shielded enclosure. A 1m x 2m wooden table 80cm high is placed 40cm away from the vertical wall and 80cm away from the sidewall of the shielded room. Two 10kHz-30MHz, 50Ω/50uH Line-Impedance Stabilization Networks (LISNs) are bonded to the shielded room floor. Power to the LISNs is filtered by external high-current high-insertion loss power line filters. These filters attenuate ambient signal noise from entering the measurement lines. These filters are also bonded to the shielded enclosure.

The EUT is powered from one LISN and the support equipment is powered from the second LISN. All interconnecting cables more than 1 meter were shortened to a 1 meter length by non-inductive bundling (serpentine fashion) and draped over the back edge of the test table. All cables were at least 40cm above the horizontal reference ground-plane. Power cables for support equipment were routed down to the second LISN while ensuring that that cables were not draped over the second LISN.

Sufficient time for the EUT, support equipment, and test equipment was allowed in order for them to warm up to their normal operating condition. The RF output of the LISN was connected to the receiver and exploratory measurements were made to determine the frequencies producing the maximum emission from the EUT. The receiver was scanned from 150 kHz to 30 MHz. The detector function was set to peak mode for exploratory measurements while the bandwidth of the analyzer was set to 9 kHz. The EUT, support equipment, and interconnecting cables were arranged and manipulated to maximize each emission. Each emission was also maximized by varying: power lines, the mode of operation or data exchange speed, or support equipment whichever determined the worst-case emission. Once the worst case emissions have been identified, the one EUT cable configuration/arrangement and mode of operation that produced these emissions are used for final measurements on the same test site. The analyzer is set to CISPR quasi-peak and average detectors with a 9 kHz resolution bandwidth for final measurements.

An extension cord was used to connect to a single LISN which powered by EUT. The extension cord was calibrated with LISN, the impedance and insertion loss are compliance with the requirements as stated in ANSI C63.10-2013.

3.3. Radiated Emissions

The radiated test facilities consisted of an indoor 3 meter semi-anechoic chamber used for final measurements and exploratory measurements, when necessary. The measurement area is contained within the semi-anechoic chamber which is shielded from any ambient interference. For measurements above 1GHz absorbers are arranged on the floor between the turn table and the antenna mast in such a way so as to maximize the reduction of reflections. For measurements below 1GHz, the absorbers are removed. A MF Model 210SS turntable is used for radiated measurement. It is a continuously rotatable, remote controlled, metallic turntable and 2 meters (6.56 ft.) in diameter. The turn table is flush with the raised floor of the chamber in order to maintain its function as a ground plane. An 80cm high PVC support structure is placed on top of the turntable.

For all measurements, the spectrum was scanned through all EUT azimuths and from 1 to 4 meter receive antenna height using a broadband antenna from 30MHz up to the upper frequency shown in 15.33(b)(1) depending on the highest frequency generated or used in the device or on which the device operates or tunes. For frequencies above 1GHz, linearly polarized double ridge horn antennas were used. For frequencies below 30MHz, a calibrated loop antenna was used. When exploratory measurements were necessary, they were performed at 1 meter test distance inside the semi-anechoic chamber using broadband antennas, broadband amplifiers, and spectrum analyzers to determine the frequencies and modes producing the maximum emissions. Sufficient time for the EUT, support equipment, and test equipment was allowed in order for them to warm up to their normal operating condition. The test set-up for frequencies below 1GHz was placed on top of the 0.8 meter high, 1 x 1.5 meter table; and test set-up for frequencies 1-25GHz was placed on top of the 1.5 meter high, 1 x 1.5 meter table. The EUT, support equipment, and interconnecting cables were arranged and manipulated to maximize each emission. Appropriate precaution was taken to ensure that all emissions from the EUT were maximized and investigated. The system configuration, clock speed, mode of operation or video resolution, if applicable, turntable azimuth, and receive antenna height was noted for each frequency found.

Final measurements were made in the semi-anechoic chamber using calibrated, linearly polarized broadband and horn antennas. The test setup was configured to the setup that produced the worst case emissions. The spectrum analyzer was set to investigate all frequencies required for testing to compare the highest radiated disturbances with respect to the specified limits. The turntable containing the EUT was rotated through 360 degrees and the height of the receive antenna was varied 1 to 4 meters and stopped at the azimuth and height producing the maximum emission. Each emission was maximized by changing the orientation of the EUT through three orthogonal planes and changing the polarity of the receive antenna, whichever produced the worst-case emissions. According to 3dB Beam-Width of horn antenna, the horn antenna should be always directed to the EUT when rising height.

4. ANTENNA REQUIREMENTS

Excerpt from §15.203 of the FCC Rules/Regulations:

“An intentional radiator antenna shall be designed to ensure that no antenna other than that furnished by the responsible party can be used with the device. The use of a permanently attached antenna or of an antenna that uses a unique coupling to the intentional radiator shall be considered sufficient to comply with the provisions of this section.”

Conclusion:

This unit complies with the requirement of §15.203.

5. TEST EQUIPMENT CALIBRATION DATE

Conducted Emissions - SR2

| Instrument | Manufacturer | Type No. | Asset No. | Cali. Interval | Cali. Due Date |
|--|--------------|-------------|-------------|----------------|----------------|
| EMI Test DSMX SRXL2 Remote Receiver | R&S | ESR3 | MRTSUE06185 | 1 year | 2020/04/15 |
| Two-Line V-Network | R&S | ENV 216 | MRTSUE06002 | 1 year | 2020/06/14 |
| Two-Line V-Network | R&S | ENV 216 | MRTSUE06003 | 1 year | 2020/06/14 |
| Thermohygrometer | Testo | 608-H1 | MRTSUE06404 | 1 year | 2019/08/14 |
| Shielding Chamber | MIX-BEP | Chamber-SR2 | MRTSUE06214 | N/A | N/A |

Radiated Emissions - AC1

| Instrument | Manufacturer | Type No. | Asset No. | Cali. Interval | Cali. Due Date |
|--|--------------|-------------|-------------|----------------|----------------|
| EMI Test DSMX SRXL2 Remote Receiver | R&S | ESR7 | MRTSUE06001 | 1 year | 2019/08/13 |
| PXA Signal Analyzer | Keysight | 9030B | MRTSUE06395 | 1 year | 2019/09/25 |
| Loop Antenna | Schwarzbeck | FMZB 1519 | MRTSUE06025 | 1 year | 2019/11/09 |
| Bilog Period Antenna | Schwarzbeck | VULB 9168 | MRTSUE06172 | 1 year | 2020/03/31 |
| Broad Band Horn Antenna | Schwarzbeck | BBHA 9120D | MRTSUE06023 | 1 year | 2019/10/19 |
| Broad Band Horn Antenna | Schwarzbeck | BBHA 9170 | MRTSUE06024 | 1 year | 2019/12/17 |
| Microwave System Amplifier | Agilent | 83017A | MRTSUE06076 | 1 year | 2019/11/16 |
| Preamplifier | Schwarzbeck | BBV 9721 | MRTSUE06121 | 1 year | 2020/06/12 |
| Thermohygrometer | Testo | 608-H1 | MRTSUE06403 | 1 year | 2019/08/14 |
| Anechoic Chamber | TDK | Chamber-AC1 | MRTSUE06213 | 1 year | 2020/04/30 |

Radiated Emission - AC2

| Instrument | Manufacturer | Type No. | Asset No. | Cali. Interval | Cali. Due Date |
|-----------------------------------|--------------|-------------|-------------|----------------|----------------|
| Spectrum Analyzer | Keysight | N9038A | MRTSUE06125 | 1 year | 2019/08/13 |
| Loop Antenna | Schwarzbeck | FMZB 1519 | MRTSUE06025 | 1 year | 2019/11/09 |
| Bilog Period Antenna | Schwarzbeck | VULB 9162 | MRTSUE06022 | 1 year | 2019/10/19 |
| Horn Antenna | Schwarzbeck | BBHA9120D | MRTSUE06171 | 1 year | 2019/11/09 |
| Broad Band Horn Antenna | Schwarzbeck | BBHA 9170 | MRTSUE06024 | 1 year | 2019/12/17 |
| Broadband Coaxial Preamplifier | Schwarzbeck | BBV 9718 | MRTSUE06176 | 1 year | 2019/11/16 |
| Preamplifier | Schwarzbeck | BBV 9721 | MRTSUE06121 | 1 year | 2020/06/12 |
| Temperature/Humidity Meter | Minggao | ETH529 | MRTSUE06170 | 1 year | 2019/12/13 |
| Anechoic Chamber | RIKEN | Chamber-AC2 | MRTSUE06213 | 1 year | 2020/04/30 |

Conducted Test Equipment - TR3

| Instrument | Manufacturer | Type No. | Asset No. | Cali. Interval | Cali. Due Date |
|--|--------------|-------------|-------------|----------------|----------------|
| EXA Signal Analyzer | Agilent | N9020A | MRTSUE06106 | 1 year | 2020/04/15 |
| EXA Signal Analyzer | Keysight | N9010B | MRTSUE06452 | 1 year | 2019/07/19 |
| Signal Analyzer | R&S | FSV40 | MRTSUE06218 | 1 year | 2020/04/15 |
| Power Meter | Agilent | U2021XA | MRTSUE06030 | 1 year | 2019/11/16 |
| USB wideband power sensor | Keysight | U2021XA | MRTSUE06446 | 1 year | 2019/07/19 |
| USB wideband power sensor | Keysight | U2021XA | MRTSUE06447 | 1 year | 2019/07/05 |
| Bluetooth Test Set | Anritsu | MT8852B-042 | MRTSUE06389 | 1 year | 2020/06/14 |
| Audio Analyzer | Agilent | U8903B | MRTSUE06143 | 1 year | 2019/08/14 |
| Modulation Analyzer | HP | 8901A | MRTSUE06098 | 1 year | 2019/10/18 |
| Wideband Radio Communication Tester | R&S | CMW 500 | MRTSUE06243 | 1 year | 2019/11/16 |
| DC Power Supply | GWINSTEK | DPS-3303C | MRTSUE06064 | N/A | N/A |
| Temperature & Humidity Chamber | BAOYT | BYH-150CL | MRTSUE06051 | 1 year | 2019/11/16 |
| Thermohygrometer | testo | 608-H1 | MRTSUE06401 | 1 year | 2019/08/14 |

| Software | Version | Function |
|----------|---------|-------------------|
| e3 | V8.3.5 | EMI Test Software |

6. MEASUREMENT UNCERTAINTY

Where relevant, the following test uncertainty levels have been estimated for tests performed on the EUT as specified in CISPR 16-4-2. This uncertainty represents an expanded uncertainty expressed at approximately the 95% confidence level using a coverage factor of $k = 2$.

| | |
|--|--|
| AC Conducted Emission Measurement - SR2 | |
| Measuring Uncertainty for a Level of Confidence of 95% ($U=2Uc(y)$): | |
| 150kHz~30MHz: 3.46dB | |
| Radiated Emission Measurement - AC1 | |
| Measuring Uncertainty for a Level of Confidence of 95% ($U=2Uc(y)$): | |
| Horizontal: 30MHz~300MHz: 4.07dB | |
| 300MHz~1GHz: 3.63dB | |
| 1GHz~18GHz: 4.16dB | |
| Vertical: 30MHz~300MHz: 4.18dB | |
| 300MHz~1GHz: 3.60dB | |
| 1GHz~18GHz: 4.76dB | |
| Radiated Emission Measurement – AC2 | |
| Measuring Uncertainty for a Level of Confidence of 95% ($U=2Uc(y)$): | |
| Horizontal: 30MHz~300MHz: 3.75dB | |
| 300MHz~1GHz: 3.53dB | |
| 1GHz~18GHz: 4.28dB | |
| Vertical: 30MHz~300MHz: 3.86dB | |
| 300MHz~1GHz: 3.53dB | |
| 1GHz~18GHz: 4.33dB | |

7. TEST RESULT

7.1. Summary

| RSS Section(s) | FCC Part Section(s) | Test Description | Test Limit | Test Condition | Test Result | Reference |
|---|---------------------|---|--|----------------|-------------|-------------------|
| RSS-Gen Clause 8.8 | 15.207 | AC Conducted Emissions 150kHz - 30MHz | < FCC 15.207 limits | Line Conducted | N/A | Section 7.2 |
| RSS-Gen Clause 8.9; RSS-210 Annex A B.10 | 15.209 15.249 | General Field Strength Limits (Restricted Bands and Radiated Emission Limits) | Emissions in restricted bands must meet the radiated limits detailed in 15.209 | Radiated | Pass | Section 7.3 & 7.4 |
| N/A | 15.215(c) | 20dB Spectrum Bandwidth | 20 dB bandwidth of the emission in the specific band | Conducted | Pass | Section 7.5 |
| RSS-GEN Clause 6.7 | N/A | 99% Occupied Bandwidth | N/A | | Pass | Section 7.6 |

Notes:

1. All modes of operation and data rates were investigated. For radiated emission test, every axis (X, Y, Z) was also verified. The test results shown in the following sections represent the worst case emissions.
2. The analyzer plots shown in this section were all taken with a correction table loaded into the analyzer. The correction table was used to account for the losses of the cables and attenuators used as part of the system to connect the EUT to the analyzer at all frequencies of interest.
3. "N/A" means that the test item is not applicable, and the details information refer to relevant section.

7.2. Conducted Emission

7.2.1. Test Limit

| FCC Part 15.207 & RSS-Gen Limits | | |
|----------------------------------|-----------|-----------|
| Frequency (MHz) | QP (dBuV) | AV (dBuV) |
| 0.15 ~ 0.50 | 66 ~ 56 | 56 ~ 46 |
| 0.50 ~ 5.0 | 56 | 46 |
| 5.0 ~ 30 | 60 | 50 |

Note 1: The lower limit shall apply at the transition frequencies.

Note 2: The limit decreases linearly with the logarithm of the frequency in the range 0.15MHz to 0.5MHz.

7.2.2. Test Setup

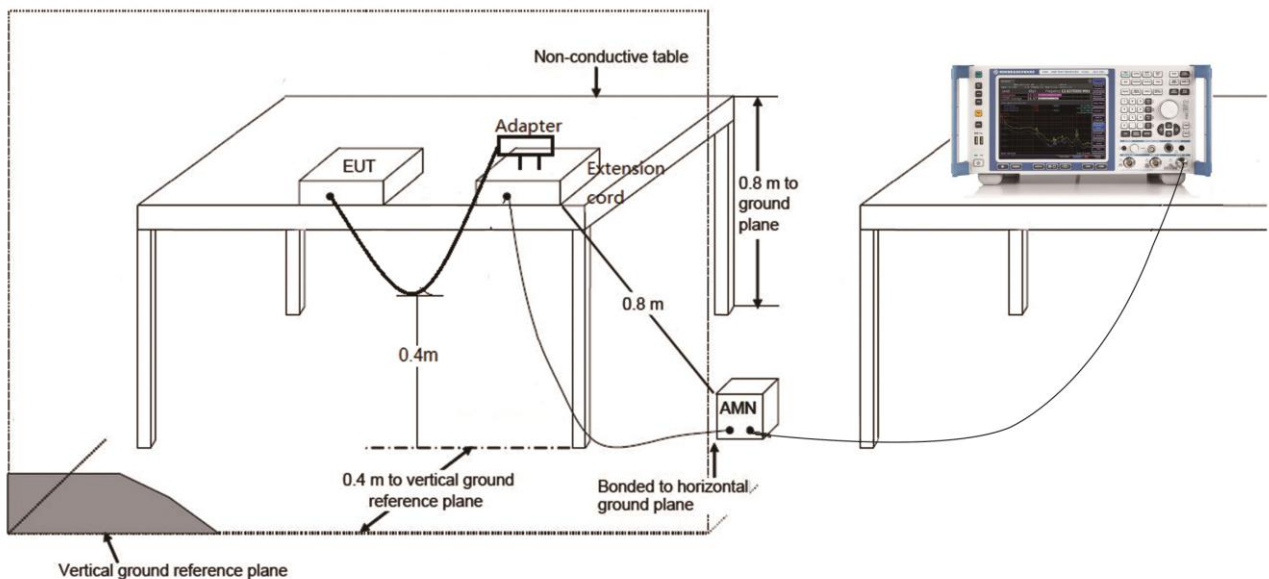

7.2.3. Test Result

The EUT is powered by internal power supply, so this requirement does not apply.

7.3. Radiated Emission

7.3.1. Test Limit

| FCC Part 15 Subpart C Paragraph 15.249 & RSS-210 | | |
|--|---|---------------------------------------|
| Fundamental Frequency (MHz) | Field Strength of Fundamental (mV/m) | Field Strength of Harmonics (uV/m) |
| 902 ~ 908 | 50 | 500 |
| 2400 ~ 2483.5 | 50 | 500 |
| 5725 ~ 5875 | 50 | 500 |
| 24000 ~ 24250 | 250 | 2500 |

Note: FCC Part 15.249 (d), Emissions radiated outside of the specified frequency bands, except for harmonics, shall be attenuated by at least 50 dB below the level of the fundamental or to the general radiated emission limits in §15.209, whichever is the lesser attenuation.

| FCC Part 15 Subpart C Paragraph 15.209 & RSS-Gen | | |
|--|-----------------------|--------------------------|
| Frequency (MHz) | Field Strength (uV/m) | Measurement Distance (m) |
| 0.009 ~ 0.490 | 2400/F(kHz) | 300 |
| 0.490 ~ 1.705 | 24000/F(kHz) | 30 |
| 1.705 ~ 30.0 | 30 | 30 |
| 30 ~ 88 | 100** | 3 |
| 88 ~ 216 | 150** | 3 |
| 216 ~ 960 | 200** | 3 |
| Above 960 | 500 | 3 |

Note 1: The lower limit shall apply at the transition frequency.
 Note 2: Distance refers to the distance in meters between the measuring instrument antenna and the closed point of any part of the device or system.
 Note 3: E field strength (dBuV/m) = 20 log E field strength (uV/m).

7.3.2. Test Setup

30MHz ~ 1GHz Test Setup:

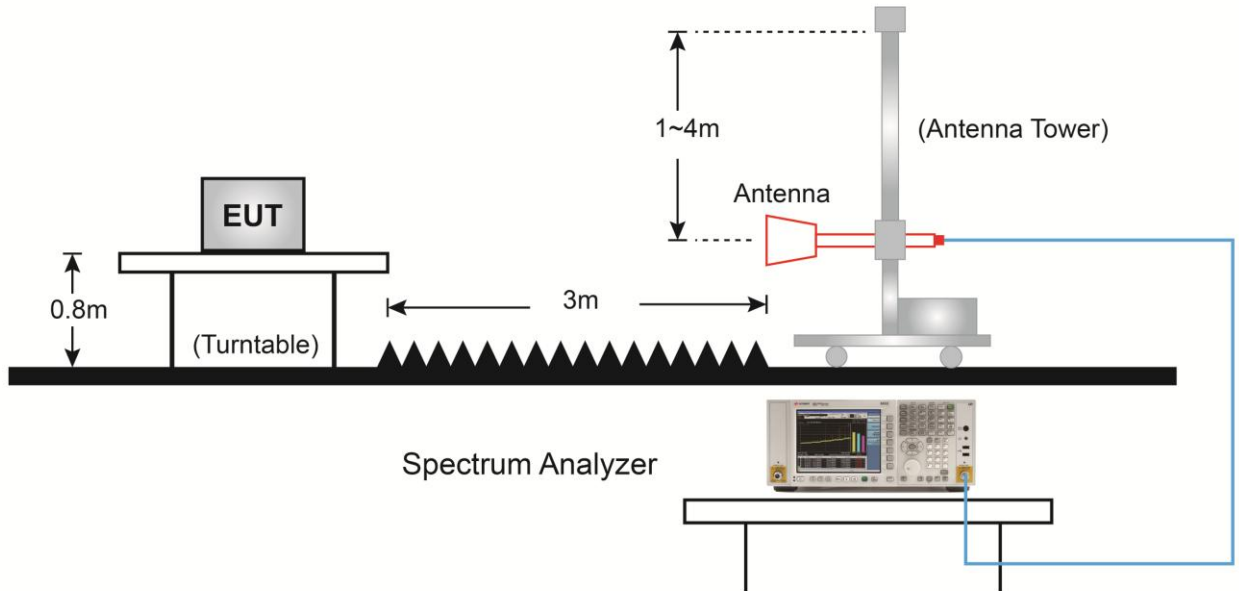

1GHz ~ 25GHz Test Setup:

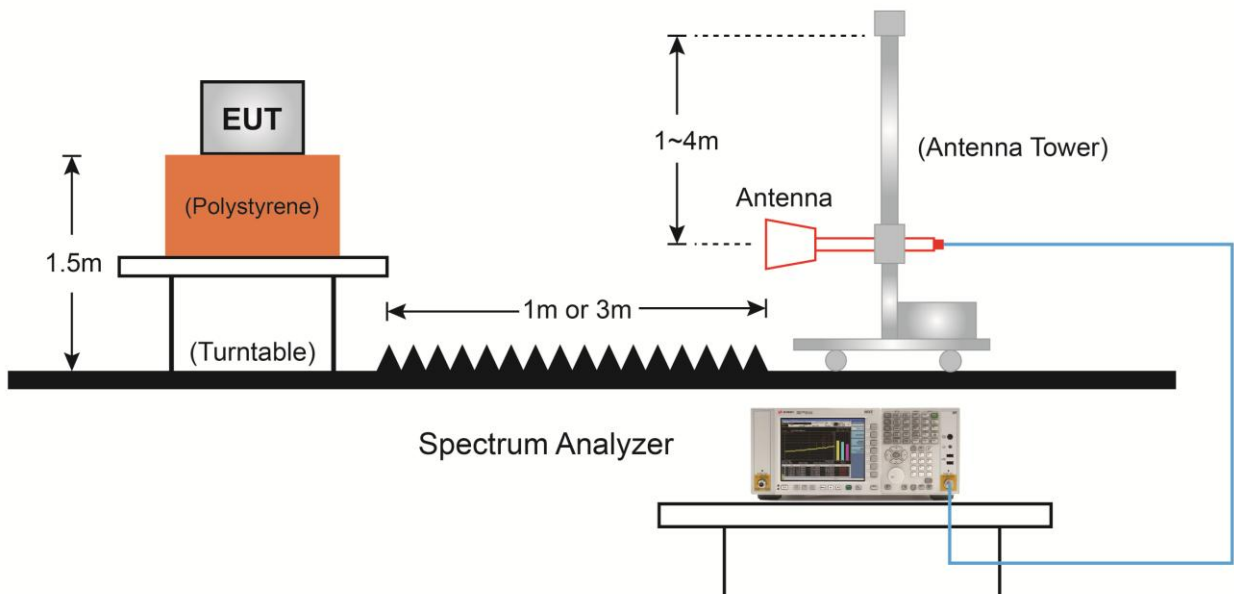

7.3.3. Test Result

| | | | |
|---------------|----------------------------|-------------------|------------|
| Product | DSMX SRXL2 Remote Receiver | Temperature | 24°C |
| Test Engineer | Snake Ni | Relative Humidity | 59% |
| Test Site | AC1 | Test Date | 2019/06/12 |

| | | | |
|-----------------|--------------------|-------------------|---------------------------|
| Time On (ms) | One Period (ms) | Duty Cycle (%) | Duty Cycle Factor (dB) |
| 12.60 | 100 | 12.60 | -17.99 |

Note: Duty Cycle Factor = $20 \cdot \log(\text{Duty Cycle})$

Time On = $1.40\text{ms} \cdot 9 = 12.60\text{ms}$

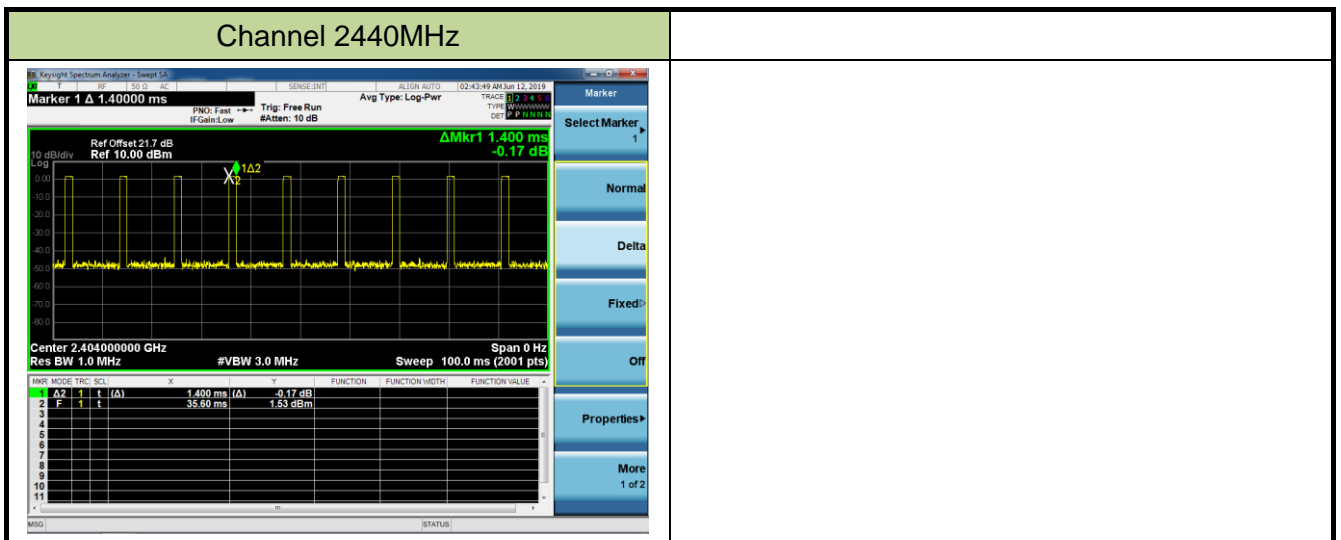

| | | | |
|---------------|--------------------------------------|-------------------|------------|
| Product | DSMX SRXL2 Remote Receiver | Temperature | 24°C |
| Test Engineer | Snake Ni | Relative Humidity | 59% |
| Test Site | AC1 | Test Date | 2019/06/11 |
| Remark | Fundamental Radiated Emission | | |

| Frequency (MHz) | Reading Level (dBμV) | Factor (dB) | Duty Cycle Factor (dB) | Measure Level (dBμV/m) | Limit (dBμV/m) | Margin (dB) | Detector | Polarization |
|-----------------|----------------------|-------------|------------------------|------------------------|----------------|-------------|----------|--------------|
| 2404 | 63.8 | 31.4 | N/A | 95.2 | 114 | -18.8 | PK | Horizontal |
| | 63.8 | 31.4 | -18.0 | 77.2 | 94 | -16.8 | AV | Horizontal |
| | 54.0 | 31.4 | N/A | 85.4 | 114 | -28.6 | PK | Vertical |
| | 54.0 | 31.4 | -18.0 | 67.4 | 94 | -26.6 | AV | Vertical |
| 2440 | 63.3 | 31.3 | N/A | 94.6 | 114 | -19.4 | PK | Horizontal |
| | 63.3 | 31.3 | -18.0 | 76.6 | 94 | -17.4 | AV | Horizontal |
| | 57.5 | 31.3 | N/A | 88.8 | 114 | -25.2 | PK | Vertical |
| | 57.5 | 31.3 | -18.0 | 70.8 | 94 | -23.2 | AV | Vertical |
| 2476 | 63.2 | 31.4 | N/A | 94.6 | 114 | -19.4 | PK | Horizontal |
| | 63.2 | 31.4 | -18.0 | 76.6 | 94 | -17.4 | AV | Horizontal |
| | 52.5 | 31.4 | N/A | 83.9 | 114 | -30.1 | PK | Vertical |
| | 52.5 | 31.4 | -18.0 | 65.9 | 94 | -28.1 | AV | Vertical |

Note 1: Peak Measure Level (dBμV/m) = Reading Level (dBμV) + Factor (dB)

Average Measure Level = Peak Measure Level + Duty Cycle Factor

Factor (dB) = Cable Loss (dB) + Antenna Factor (dB/m)

Note 2: All readings below 1GHz are peak, above 1GHz are performed with peak and/or average measurements as necessary.

| | | | |
|---------------|--|-------------------|------------|
| Product | DSMX SRXL2 Remote Receiver | Temperature | 24°C |
| Test Engineer | Snake Ni | Relative Humidity | 59% |
| Test Site | AC1 | Test Date | 2019/06/11 |
| Remark: | Harmonics Radiated Emission - 2404MHz | | |

| Frequency (MHz) | Reading Level (dBμV) | Factor (dB) | Duty Cycle Factor (dB) | Measure Level (dBμV/m) | Limit (dBμV/m) | Margin (dB) | Detector | Polarization |
|-----------------|----------------------|-------------|------------------------|------------------------|----------------|-------------|----------|--------------|
| 47.9 | 4.5 | 14.9 | N/A | 19.4 | 40.0 | -20.6 | QP | Horizontal |
| 96.0 | 7.4 | 12.3 | N/A | 19.7 | 43.5 | -23.8 | QP | Horizontal |
| 71.9 | 26.5 | 10.4 | N/A | 36.9 | 40.0 | -3.1 | QP | Vertical |
| 95.8 | 22.4 | 12.3 | N/A | 34.7 | 43.5 | -8.8 | QP | Vertical |
| 4808.0 | 43.3 | 3.5 | N/A | 46.8 | 74.0 (Note 2) | -27.2 | PK | Horizontal |
| 7213.5 | 50.0 | 11.6 | N/A | 61.6 | 74.0 (Note 2) | -12.4 | PK | Horizontal |
| 7213.5 | 50.0 | 11.6 | -18.0 | 43.6 | 54.0 | -10.4 | AV | Horizontal |
| 9616.0 | 33.3 | 13.5 | N/A | 46.8 | 74.0 (Note 2) | -27.2 | PK | Horizontal |
| 12020.0 | 31.3 | 19.6 | N/A | 50.9 | 74.0 (Note 2) | -23.1 | PK | Horizontal |
| 4808.0 | 39.9 | 3.5 | N/A | 43.4 | 74.0 (Note 2) | -30.6 | PK | Vertical |
| 7213.5 | 42.1 | 11.6 | N/A | 53.7 | 74.0 (Note 2) | -20.3 | PK | Vertical |
| 9616.0 | 33.5 | 13.5 | N/A | 47.0 | 74.0 (Note 2) | -27.0 | PK | Vertical |
| 12020.0 | 31.1 | 19.6 | N/A | 50.7 | 74.0 (Note 2) | -23.3 | PK | Vertical |

Note 1: Peak Measure Level (dBμV/m) = Reading Level (dBμV) + Factor (dB)

Average Measure Level = Peak Measure Level + Duty Cycle Factor

Factor (dB) = Cable Loss (dB) + Antenna Factor (dB/m) – Pre Amplifier Gain (dB)

Note 2: Average measurement was not performed when the peak level lower than average limit.

Note 3: The test trace is same as the ambient noise (the test frequency range: 9 kHz ~ 30 MHz and 18 GHz ~ 25 GHz), therefore no data appear in the report.

| | | | |
|---------------|--|-------------------|------------|
| Product | DSMX SRXL2 Remote Receiver | Temperature | 24°C |
| Test Engineer | Snake Ni | Relative Humidity | 59% |
| Test Site | AC1 | Test Date | 2019/06/11 |
| Remark: | Harmonics Radiated Emission - 2440MHz | | |

| Frequency (MHz) | Reading Level (dBμV) | Factor (dB) | Duty Cycle Factor (dB) | Measure Level (dBμV/m) | Limit (dBμV/m) | Margin (dB) | Detector | Polarization |
|-----------------|----------------------|-------------|------------------------|------------------------|----------------|-------------|----------|--------------|
| 47.9 | 4.6 | 14.9 | N/A | 19.5 | 40.0 | -20.5 | QP | Horizontal |
| 71.7 | 9.1 | 10.4 | N/A | 19.5 | 40.0 | -20.5 | QP | Horizontal |
| 67.5 | 23.7 | 11.6 | N/A | 35.3 | 40.0 | -4.7 | QP | Vertical |
| 95.7 | 24.1 | 12.3 | N/A | 36.4 | 43.5 | -7.1 | QP | Vertical |
| 4880.0 | 40.9 | 3.6 | N/A | 44.5 | 74.0 (Note 2) | -29.5 | PK | Horizontal |
| 7320.0 | 52.9 | 11.9 | N/A | 64.8 | 74.0 (Note 2) | -9.2 | PK | Horizontal |
| 7320.0 | 52.9 | 11.9 | -18.0 | 46.8 | 54.0 | -7.2 | AV | Horizontal |
| 9760.0 | 33.6 | 14.0 | N/A | 47.6 | 74.0 (Note 2) | -26.4 | PK | Horizontal |
| 12200.0 | 30.3 | 19.9 | N/A | 50.2 | 74.0 (Note 2) | -23.8 | PK | Horizontal |
| 4880.0 | 36.1 | 3.6 | N/A | 39.7 | 74.0 (Note 2) | -34.3 | PK | Vertical |
| 7320.0 | 42.7 | 11.9 | N/A | 54.6 | 74.0 (Note 2) | -19.4 | PK | Vertical |
| 7320.0 | 42.7 | 11.9 | -18.0 | 36.6 | 54.0 | -17.4 | AV | Vertical |
| 9760.0 | 33.4 | 14.0 | N/A | 47.4 | 74.0 (Note 2) | -26.6 | PK | Vertical |
| 12200.0 | 31.9 | 19.9 | N/A | 51.8 | 74.0 (Note 2) | -22.2 | PK | Vertical |

Note 1: Measure Level (dBμV/m) = Reading Level (dBμV) + Factor (dB)

Average Measure Level = Peak Measure Level + Duty Cycle Factor

Factor (dB) = Cable Loss (dB) + Antenna Factor (dB/m) – Pre Amplifier Gain (dB)

Note 2: Average measurement was not performed when the peak level lower than average limit.

Note 3: The test trace is same as the ambient noise (the test frequency range: 9 kHz ~ 30 MHz and 18 GHz ~ 25 GHz), therefore no data appear in the report.

| | | | |
|---------------|--|-------------------|------------|
| Product | DSMX SRXL2 Remote Receiver | Temperature | 24°C |
| Test Engineer | Snake Ni | Relative Humidity | 59% |
| Test Site | AC1 | Test Date | 2019/06/11 |
| Remark: | Harmonics Radiated Emission - 2476MHz | | |

| Frequency (MHz) | Reading Level (dBμV) | Factor (dB) | Duty Cycle Factor (dB) | Measure Level (dBμV/m) | Limit (dBμV/m) | Margin (dB) | Detector | Polarization |
|-----------------|----------------------|-------------|------------------------|------------------------|----------------|-------------|----------|--------------|
| 47.9 | 4.2 | 14.9 | N/A | 19.1 | 40.0 | -20.9 | QP | Horizontal |
| 72.2 | 9.8 | 10.3 | N/A | 20.1 | 40.0 | -19.9 | QP | Horizontal |
| 60.5 | 23.7 | 13.7 | N/A | 37.4 | 40.0 | -2.6 | QP | Vertical |
| 71.9 | 25.5 | 10.4 | N/A | 35.9 | 40.0 | -4.1 | QP | Vertical |
| 4952.0 | 40.9 | 3.5 | N/A | 44.4 | 74.0 (Note 2) | -29.6 | PK | Horizontal |
| 7426.0 | 56.7 | 11.9 | N/A | 68.6 | 74.0 (Note 2) | -5.4 | PK | Horizontal |
| 7426.0 | 56.7 | 11.9 | -18.0 | 50.6 | 54.0 | -3.4 | AV | Horizontal |
| 9904.0 | 32.8 | 14.1 | N/A | 46.9 | 74.0 (Note 2) | -27.1 | PK | Horizontal |
| 12380.0 | 30.9 | 19.2 | N/A | 50.1 | 74.0 (Note 2) | -23.9 | PK | Horizontal |
| 4952.0 | 36.4 | 3.5 | N/A | 39.9 | 74.0 (Note 2) | -34.1 | PK | Vertical |
| 7426.0 | 49.0 | 11.9 | N/A | 60.9 | 74.0 (Note 2) | -13.1 | PK | Vertical |
| 7426.0 | 49.0 | 11.9 | -18.0 | 42.9 | 54.0 | -11.1 | AV | Vertical |
| 9904.0 | 33.6 | 14.1 | N/A | 47.7 | 74.0 (Note 2) | -26.3 | PK | Vertical |
| 12380.0 | 30.4 | 19.2 | N/A | 49.6 | 74.0 (Note 2) | -24.4 | PK | Vertical |

Note 1: Measure Level (dBμV/m) = Reading Level (dBμV) + Factor (dB)

Average Measure Level = Peak Measure Level + Duty Cycle Factor

Factor (dB) = Cable Loss (dB) + Antenna Factor (dB/m) – Pre Amplifier Gain (dB)

Note 2: Average measurement was not performed when the peak level lower than average limit.

Note 3: The test trace is same as the ambient noise (the test frequency range: 9 kHz ~ 30 MHz and 18 GHz ~ 25 GHz), therefore no data appear in the report.

7.4. Radiated Restricted Band Edge Measurement

7.4.1. Test Limit

For 15.205 requirement:

Radiated emissions which fall in the restricted bands, as defined in Section 15.205(a) of FCC part 15, must also comply with the radiated emission limits specified in Section 15.209(a).

| Frequency (MHz) | Frequency (MHz) | Frequency (MHz) | Frequency (GHz) |
|----------------------------|-----------------------|--------------------|--------------------|
| 0.090 - 0.110 | 16.42 - 16.423 | 399.9 - 410 | 4.5 - 5.15 |
| ¹ 0.495 - 0.505 | 16.69475 - 16.69525 | 608 - 614 | 5.35 - 5.46 |
| 2.1735 - 2.1905 | 16.80425 - 16.80475 | 960 - 1240 | 7.25 - 7.75 |
| 4.125 - 4.128 | 25.5 - 25.67 | 1300 - 1427 | 8.025 - 8.5 |
| 4.17725 - 4.17775 | 37.5 - 38.25 | 1435 - 1626.5 | 9.0 - 9.2 |
| 4.20725 - 4.20775 | 73 - 74.6 | 1645.5 - 1646.5 | 9.3 - 9.5 |
| 6.215 - 6.218 | 74.8 - 75.2 | 1660 - 1710 | 10.6 - 12.7 |
| 6.26775 - 6.26825 | 108 - 121.94 | 1718.8 - 1722.2 | 13.25 - 13.4 |
| 6.31175 - 6.31225 | 123 - 138 | 2200 - 2300 | 14.47 - 14.5 |
| 8.291 - 8.294 | 149.9 - 150.05 | 2310 - 2390 | 15.35 - 16.2 |
| 8.362 - 8.366 | 156.52475 - 156.52525 | 2483.5 - 2500 | 17.7 - 21.4 |
| 8.37625 - 8.38675 | 156.7 - 156.9 | 2690 - 2900 | 22.01 - 23.12 |
| 8.41425 - 8.41475 | 162.0125 - 167.17 | 3260 - 3267 | 23.6 - 24.0 |
| 12.29 - 12.293 | 167.72 - 173.2 | 3332 - 3339 | 31.2 - 31.8 |
| 12.51975 - 12.52025 | 240 - 285 | 3345.8 - 3358 | 36.43 - 36.5 |
| 12.57675 - 12.57725 | 322 - 335.4 | 3600 - 4400 | (²) |
| 13.36 - 13.41 | -- | -- | -- |

All out of band emissions appearing in a restricted band as specified in Section 15.205 of the Title 47 CFR must not exceed the limits shown in Table per Section 15.209.

| FCC Part 15 Subpart C Paragraph 15.209 | | |
|--|---|---------------------------|
| Frequency [MHz] | Field Strength [$\mu\text{V}/\text{m}$] | Measured Distance [Meter] |
| 0.009 ~ 0.490 | 2400/F (kHz) | 300 |
| 0.490 ~ 1.705 | 24000/F (kHz) | 30 |
| 1.705 ~ 30 | 30 | 30 |
| 30 ~ 88 | 100 | 3 |
| 88 ~ 216 | 150 | 3 |
| 216 ~ 960 | 200 | 3 |
| Above 960 | 500 | 3 |

For RSS-Gen Section 8.10 Requirement:

Radiated emissions which fall in the restricted bands, as defined in Section 8.10 of RSS-Gen, must also comply with the radiated emission limits specified in Section 8.9.

| Frequency (MHz) | Frequency (MHz) | Frequency (GHz) |
|---------------------|-----------------------|---|
| 0.090 - 0.110 | 149.9 - 150.05 | 9.0 - 9.2 |
| 0.495 - 0.505 | 156.52475 - 156.52525 | 9.3 - 9.5 |
| 2.1735 - 2.1905 | 156.7 - 156.9 | 10.6 - 12.7 |
| 3.020 - 3.026 | 162.0125 - 167.17 | 13.25 - 13.4 |
| 4.125 - 4.128 | 167.72 - 173.2 | 14.47 - 14.5 |
| 4.17725 - 4.17775 | 240 - 285 | 15.35 - 16.2 |
| 4.20725 - 4.20775 | 322 - 335.4 | 17.7 - 21.4 |
| 5.677 - 5.683 | 399.9 - 410 | 22.01 - 23.12 |
| 6.215 - 6.218 | 608 - 614 | 23.6 - 24.0 |
| 6.26775 - 6.26825 | 960 - 1427 | 31.2 - 31.8 |
| 6.31175 - 6.31225 | 1435 - 1626.5 | 36.43 - 36.5 |
| 8.291 - 8.294 | 1645.5 - 1646.5 | Above 38.6 |
| 8.362 - 8.366 | 1660 - 1710 | * Certain frequency bands listed in table 7 and in bands above 38.6 GHz are designated for license exempt applications. These frequency bands and the requirements that apply to related devices are set out in the 200 and 300 series of RSSs. |
| 8.37625 - 8.38675 | 1718.8 - 1722.2 | |
| 8.41425 - 8.41475 | 2200 - 2300 | |
| 12.29 - 12.293 | 2310 - 2390 | |
| 12.51975 - 12.52025 | 2483.5 - 2500 | |
| 12.57675 - 12.57725 | 2655 - 2900 | |
| 13.36 - 13.41 | 3260 - 3267 | |
| 16.42 - 16.423 | 3332 - 3339 | |
| 16.69475 - 16.69525 | 3345.8 - 3358 | |
| 16.80425 - 16.80475 | 3500 - 4400 | |
| 25.5 - 25.67 | 4500 - 5150 | |
| 37.5 - 38.25 | 5350 - 5460 | |
| 73 - 74.6 | 7250 - 7750 | |
| 74.8 - 75.2 | 8025 - 8500 | |
| 108 - 138 | -- | |

All out of band emissions appearing in a restricted band as specified in Section 8.10 of the RSS-Gen must not exceed the limits shown in Table per Section 8.9.

| Frequency [MHz] | Field Strength [$\mu\text{V}/\text{m}$] | Magnetic Field Strength (H-Field) [$\mu\text{A}/\text{m}$] | Measured Distance [Meters] |
|----------------------------|---|--|----------------------------|
| 0.009 - 0.490 ¹ | -- | 6.37/F (F in kHz) | 300 |
| 0.490 - 1.705 | -- | 6.37/F (F in kHz) | 30 |
| 1.705 - 30 | -- | 0.08 | 30 |
| 30 - 88 | 100 | -- | 3 |
| 88 - 216 | 150 | -- | 3 |
| 216 - 960 | 200 | -- | 3 |
| Above 960 | 500 | -- | 3 |

Note: The emission limits for the bands 9 - 90 kHz and 110 - 490 kHz are based on measurements employing a linear average detector.

7.4.2. Test Setup

1GHz ~ 18GHz Test Setup:

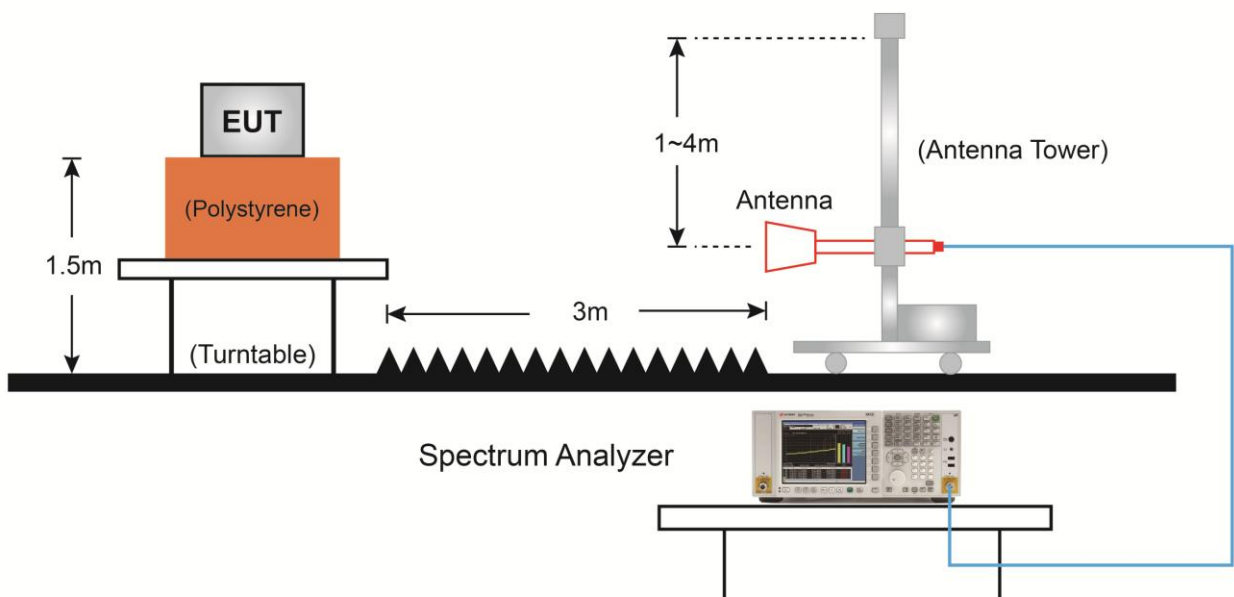

7.4.3. Test Result

| | |
|--|--------------------------|
| Site: AC2 | Time: 2019/06/11 - 02:59 |
| Limit: FCC_Part15_Band Edge(3m) | Engineer: Snake Ni |
| Probe: BBHA9120D_1-18GHz | Polarity: Horizontal |
| EUT: DSMX SRXL2 Remote Receiver | Power: By USB |
| Test Mode: Transmit at Channel 2404MHz | |

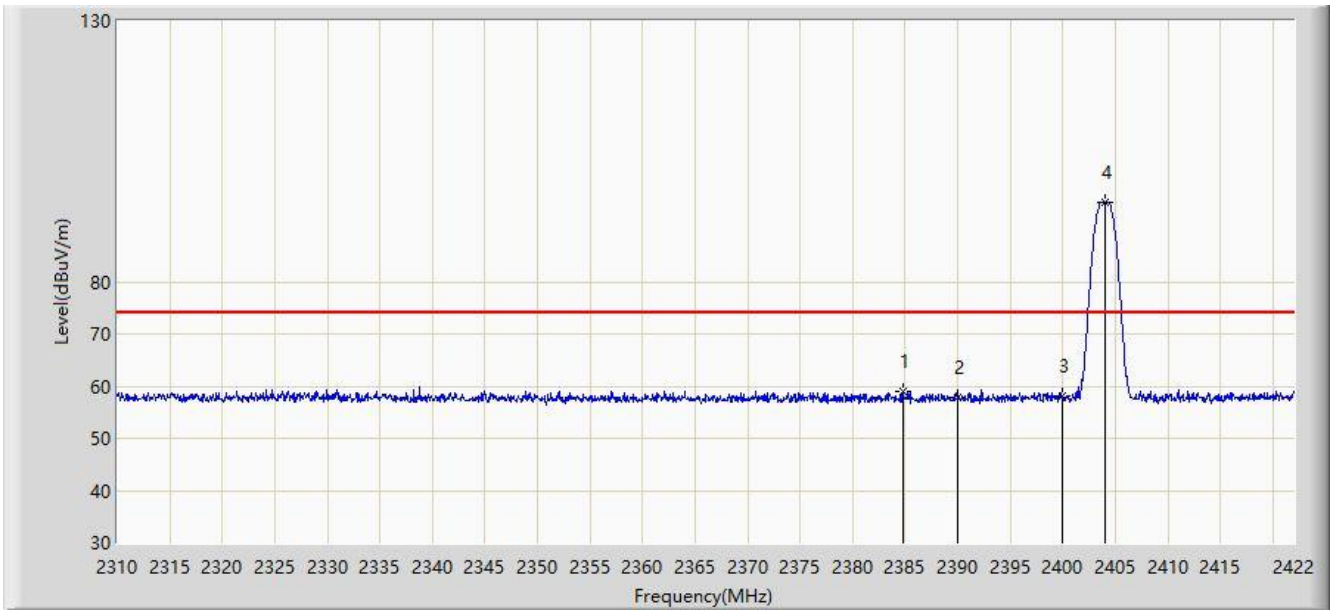

| No | Flag | Mark | Frequency (MHz) | Reading Level (dBuV) | Factor (dB) | Duty Cycle Factor (dB) | Measure Level (dBuV/m) | Limit (dBuV/m) | Margin (dB) | Type |
|----|------|------|-----------------|----------------------|-------------|------------------------|------------------------|----------------|-------------|------|
| 1 | | | 2384.760 | 27.642 | 31.447 | N/A | 59.089 | 74.000 | -14.911 | PK |
| | | | 2384.760 | 27.642 | 31.447 | -18.00 | 41.089 | 54.000 | -12.911 | AV |
| 2 | | | 2390.000 | 26.241 | 31.449 | N/A | 57.690 | 74.000 | -16.310 | PK |
| | | | 2390.000 | 26.241 | 31.449 | -18.00 | 39.690 | 54.000 | -14.310 | AV |
| 3 | | | 2400.000 | 26.573 | 31.429 | N/A | 58.002 | 74.000 | -15.998 | PK |
| | | | 2400.000 | 26.573 | 31.429 | -18.00 | 40.002 | 54.000 | -13.998 | AV |
| 4 | | * | 2404.024 | 63.797 | 31.415 | N/A | 95.212 | 114.000 | -18.788 | PK |

Note: Peak Measure Level (dB μ V/m) = Reading Level (dB μ V) + Factor (dB)

Average Measure Level = Peak Measure Level + Duty Cycle Factor

Factor (dB) = Cable Loss (dB) + Antenna Factor (dB/m)

| | |
|--|--------------------------|
| Site: AC2 | Time: 2019/06/11 - 03:03 |
| Limit: FCC_Part15_Band Edge(3m) | Engineer: Snake Ni |
| Probe: BBHA9120D_1-18GHz | Polarity: Vertical |
| EUT: DSMX SRXL2 Remote Receiver | Power: By USB |
| Test Mode: Transmit at Channel 2404MHz | |

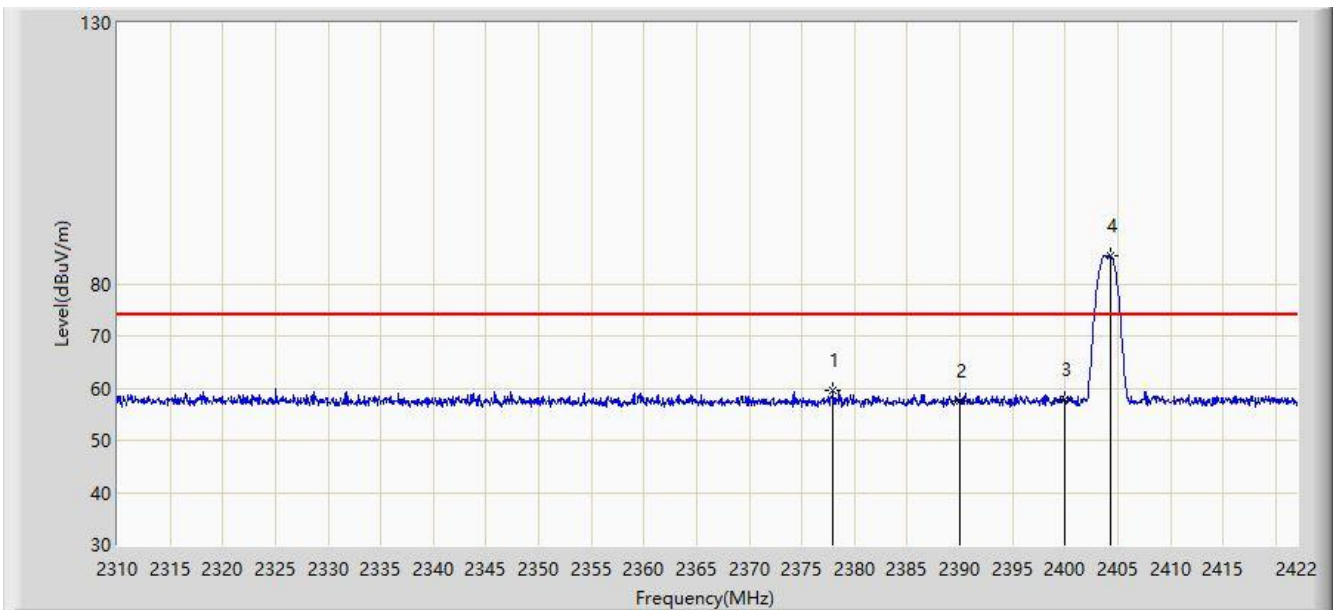

| No | Flag | Mark | Frequency (MHz) | Reading Level (dBuV) | Factor (dB) | Duty Cycle Factor (dB) | Measure Level (dBuV/m) | Limit (dBuV/m) | Margin (dB) | Type |
|----|------|------|-----------------|----------------------|-------------|------------------------|------------------------|----------------|-------------|------|
| 1 | | | 2377.984 | 28.090 | 31.447 | N/A | 59.537 | 74.000 | -14.463 | PK |
| | | | 2377.984 | 28.090 | 31.447 | -18.00 | 41.537 | 54.000 | -12.463 | AV |
| 2 | | | 2390.000 | 26.179 | 31.449 | N/A | 57.628 | 74.000 | -16.372 | PK |
| | | | 2390.000 | 26.179 | 31.449 | -18.00 | 39.628 | 54.000 | -14.372 | AV |
| 3 | | | 2400.000 | 26.254 | 31.429 | N/A | 57.683 | 74.000 | -16.317 | PK |
| | | | 2400.000 | 26.254 | 31.429 | -18.00 | 39.683 | 54.000 | -14.317 | AV |
| 4 | | * | 2404.248 | 54.036 | 31.414 | N/A | 85.45 | 114.000 | -28.550 | PK |

Note: Peak Measure Level (dB μ V/m) = Reading Level (dB μ V) + Factor (dB)

Average Measure Level = Peak Measure Level + Duty Cycle Factor

Factor (dB) = Cable Loss (dB) + Antenna Factor (dB/m)

| | |
|--|--------------------------|
| Site: AC2 | Time: 2019/06/11 - 03:07 |
| Limit: FCC_Part15_Band Edge(3m) | Engineer: Snake Ni |
| Probe: BBHA9120D_1-18GHz | Polarity: Horizontal |
| EUT: DSMX SRXL2 Remote Receiver | Power: By USB |
| Test Mode: Transmit at Channel 2476MHz | |

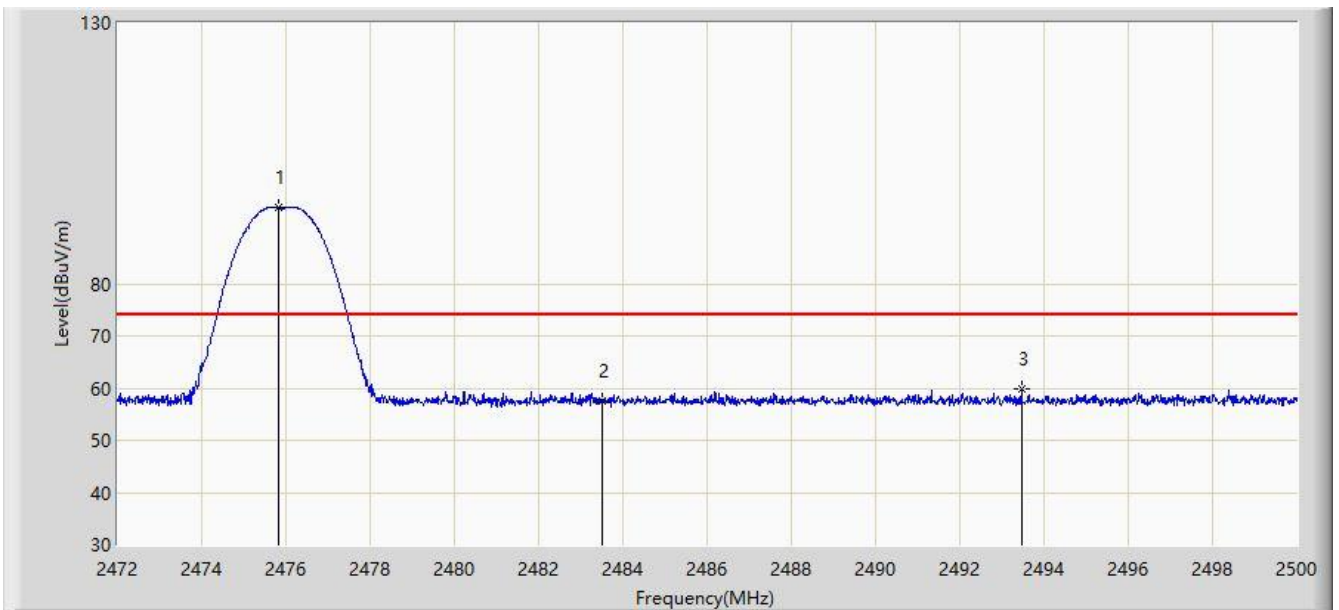

| No | Flag | Mark | Frequency (MHz) | Reading Level (dBuV) | Factor (dB) | Duty Cycle Factor (dB) | Measure Level (dBuV/m) | Limit (dBuV/m) | Margin (dB) | Type |
|----|------|------|-----------------|----------------------|-------------|------------------------|------------------------|----------------|-------------|------|
| 1 | | * | 2475.822 | 63.166 | 31.38 | N/A | 94.546 | 114.000 | -19.454 | PK |
| 2 | | | 2483.500 | 26.058 | 31.403 | N/A | 57.461 | 74.000 | -16.539 | PK |
| | | | 2483.500 | 26.058 | 31.403 | -18.00 | 39.461 | 54.000 | -14.539 | AV |
| 3 | | | 2493.462 | 28.300 | 31.437 | N/A | 59.737 | 74.000 | -14.263 | PK |
| | | | 2493.462 | 28.300 | 31.437 | -18.00 | 41.737 | 54.000 | -12.263 | AV |

Note: Peak Measure Level (dB μ V/m) = Reading Level (dB μ V) + Factor (dB)

Average Measure Level = Peak Measure Level + Duty Cycle Factor

Factor (dB) = Cable Loss (dB) + Antenna Factor (dB/m)

| | |
|--|--------------------------|
| Site: AC2 | Time: 2019/06/11 - 03:12 |
| Limit: FCC_Part15_Band Edge(3m) | Engineer: Snake Ni |
| Probe: BBHA9120D_1-18GHz | Polarity: Vertical |
| EUT: DSMX SRXL2 Remote Receiver | Power: By USB |
| Test Mode: Transmit at Channel 2476MHz | |

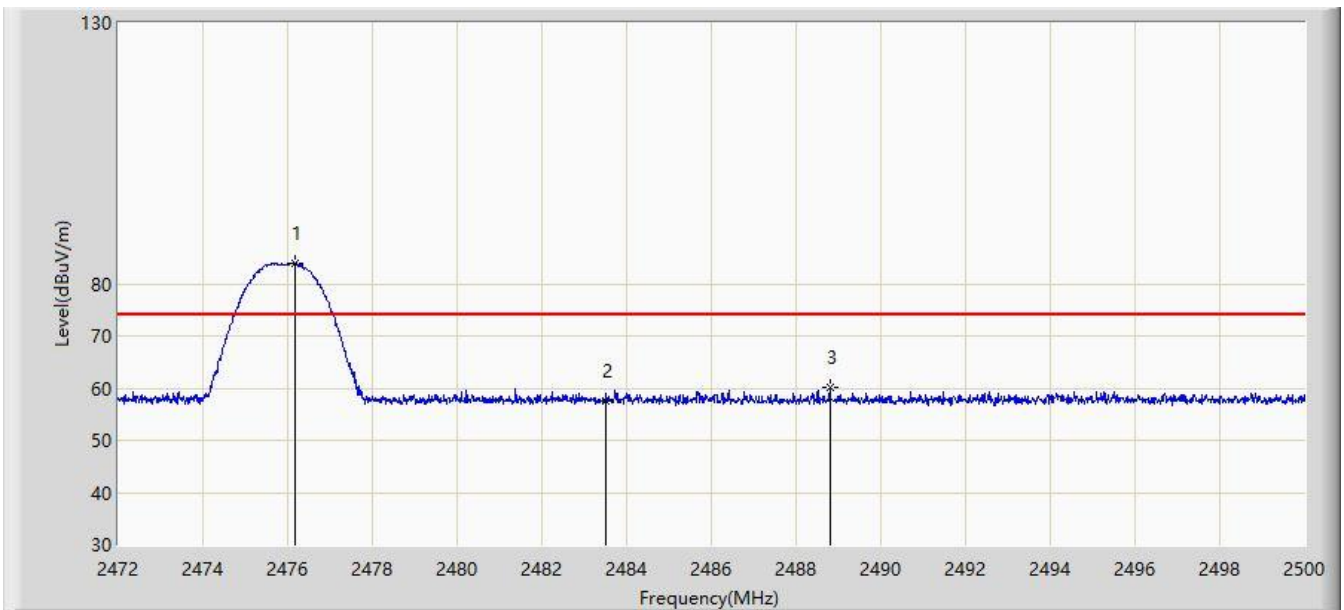

| No | Flag | Mark | Frequency (MHz) | Reading Level (dBuV) | Factor (dB) | Duty Cycle Factor (dB) | Measure Level (dBuV/m) | Limit (dBuV/m) | Margin (dB) | Type |
|----|------|------|-----------------|----------------------|-------------|------------------------|------------------------|----------------|-------------|------|
| 1 | | * | 2476.172 | 52.511 | 31.38 | N/A | 83.891 | 114.000 | -30.109 | PK |
| 2 | | | 2483.500 | 26.212 | 31.403 | N/A | 57.615 | 74.000 | -16.385 | PK |
| | | | 2483.500 | 26.212 | 31.403 | -18.00 | 39.615 | 54.000 | -14.385 | AV |
| 3 | | | 2488.800 | 28.853 | 31.421 | N/A | 60.274 | 74.000 | -13.726 | PK |
| | | | 2488.800 | 28.853 | 31.421 | -18.00 | 42.274 | 54.000 | -11.726 | AV |

Note: Peak Measure Level (dB μ V/m) = Reading Level (dB μ V) + Factor (dB)

Average Measure Level = Peak Measure Level + Duty Cycle Factor

Factor (dB) = Cable Loss (dB) + Antenna Factor (dB/m)

7.5. 20dB Spectrum Bandwidth Measurement

7.5.1. Test Limit

Intentional radiators must be designed to ensure that the 20 dB bandwidth of the emission in the specific band (2404 ~ 2476).

7.5.2. Test Procedure used

ANSI C63.10 Clause 6.9.2

7.5.3. Test Setting

1. Set the spectrum span range to overlap the nominal center frequency
2. Set RBW = 100 kHz
3. VBW $\geq 3 \times$ RBW
4. Detector = Peak
5. Trace mode = max hold
6. Sweep = auto couple
7. Allow the trace was allowed to stabilize and marker the highest level
8. Determine the display level (the highest level - 20dB) and place two markers, one at the lowest frequency and the other at the highest frequency

7.5.4. Test Setup

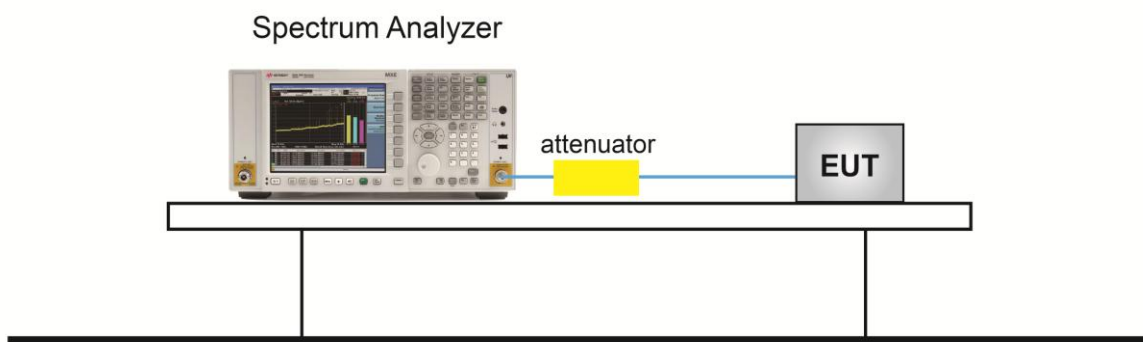

7.5.5. Test Result

| | | | |
|---------------|----------------------------|-------------------|------------|
| Product | DSMX SRXL2 Remote Receiver | Temperature | 24°C |
| Test Engineer | Snake Ni | Relative Humidity | 59% |
| Test Site | AC2 | Test Date | 2019/06/11 |

| Frequency (MHz) | Frequency Range (MHz) | Frequency Range (MHz) | Result |
|-----------------|-----------------------|-----------------------|--------|
| 2404 | 2403.28 | -- | Pass |
| 2476 | -- | 2476.49 | Pass |

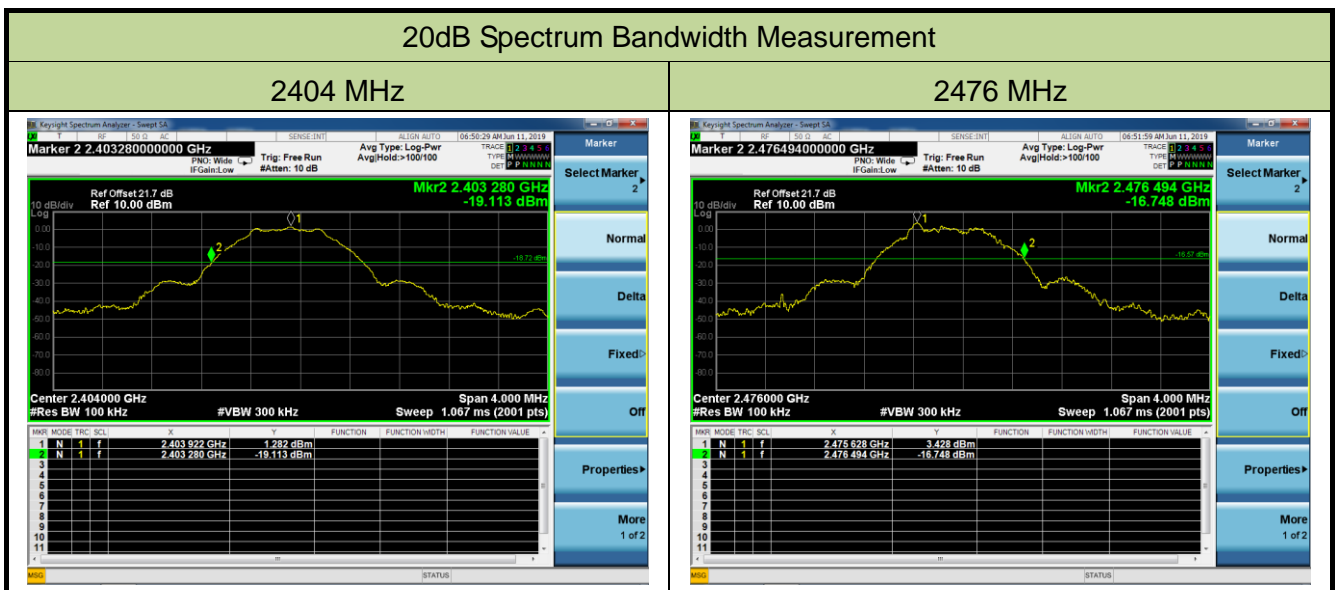

7.6. 99% Bandwidth Measurement

7.6.1. Test Limit

N/A

7.6.2. Test Procedure used

ANSI C63.10 Section 6.9

7.6.3. Test Setting

1. The analyzers' automatic bandwidth measurement capability was used to perform the 99% bandwidth measurement. The bandwidth measurement was not influenced by any intermediated power nulls in the fundamental emission.
2. RBW = approximately 1% to 5% of the OBW.
3. VBW $\geq 3 \times$ RBW.
4. Detector = Peak.
5. Trace mode = max hold.

7.6.4. Test Setup

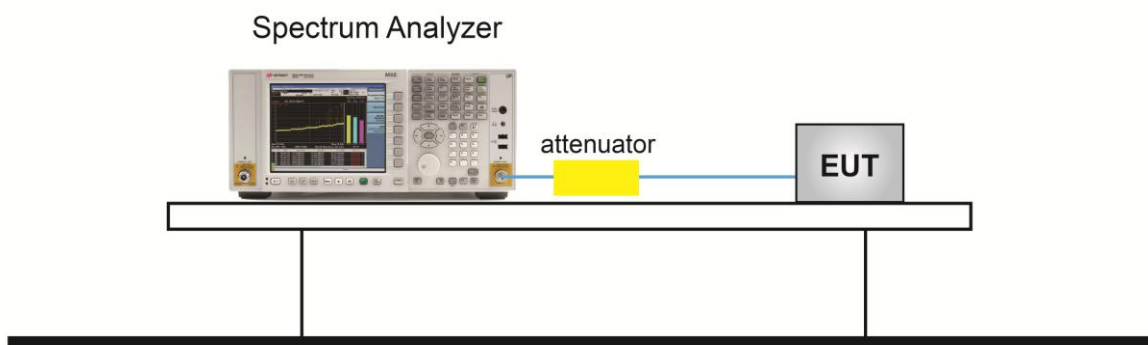

7.6.5. Test Result

| | | | |
|---------------|----------------------------|-------------------|------------|
| Product | DSMX SRXL2 Remote Receiver | Temperature | 24°C |
| Test Engineer | Snake Ni | Relative Humidity | 59% |
| Test Site | AC2 | Test Date | 2019/06/11 |

| Frequency (MHz) | 99% Bandwidth (MHz) |
|-----------------|---------------------|
| 2404 | 1.04 |
| 2440 | 1.05 |
| 2476 | 1.04 |

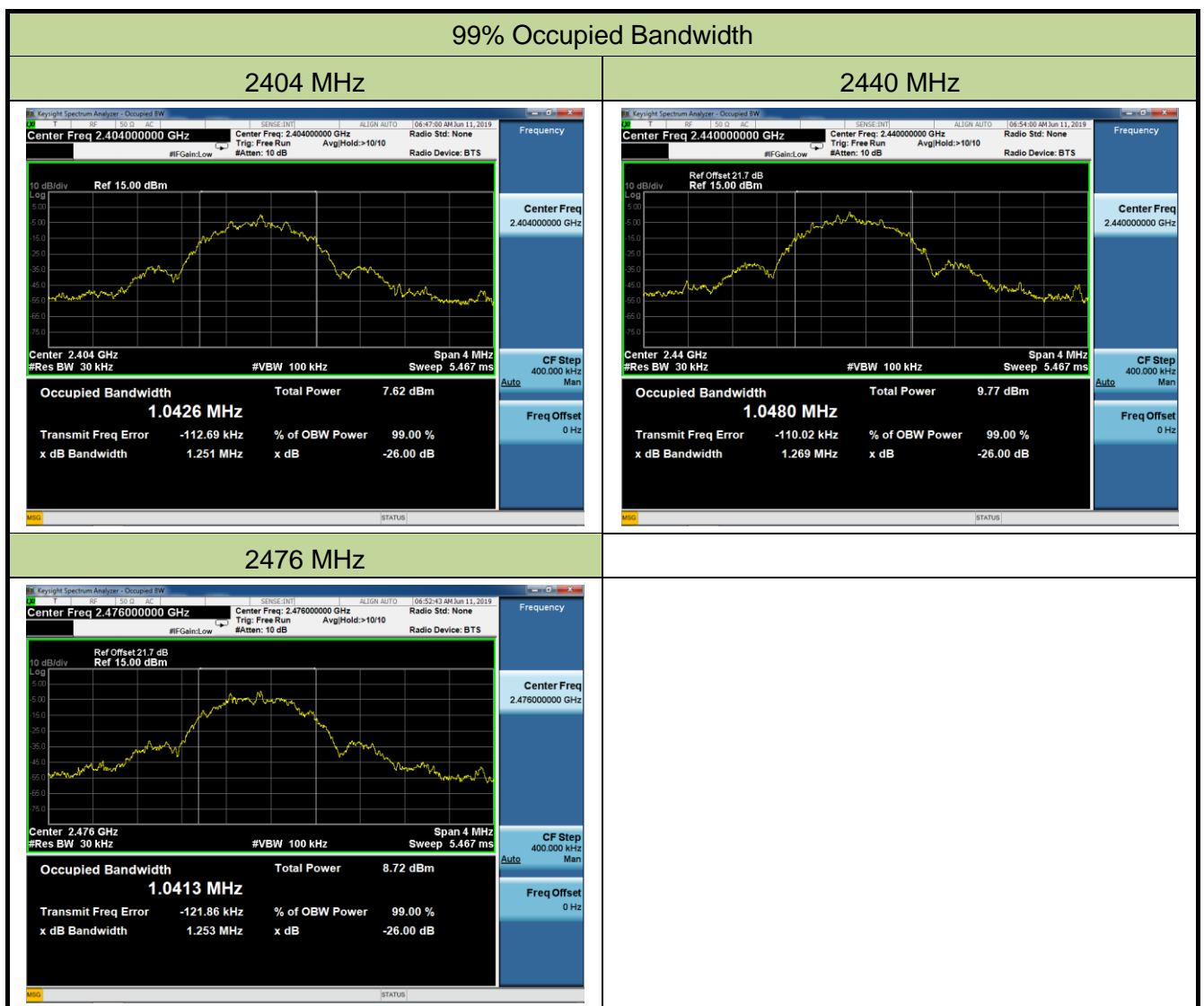

8. CONCLUSION

The data collected relate only the item(s) tested and show that the **DSMX SRXL2 Remote Receiver** is in compliance with Part 15C of the FCC Rules and ISED Rules.

The End

Appendix A - Test Setup Photograph

Refer to "1906RSU007-UT" file.

Appendix B - EUT Photograph

Refer to "1906RSU007-UE" file.