

**Electromagnetic Emissions Test Report
and
Application for Grant of Equipment Authorization
pursuant to**

FCC Part 15 Subpart C

**on the
Horizon Hobby, Inc.
Transmitter
Model: AR7000**

FCC ID: BRWDASRX10

GRANTEE: Horizon Hobby, Inc.
4105 Fieldstone Road
Champaign, IL 61822

TEST SITE: Elliott Laboratories, Inc.
684 W. Maude Ave
Sunnyvale, CA 94086

REPORT DATE: November 15, 2006

FINAL TEST DATE: November 9, 2006

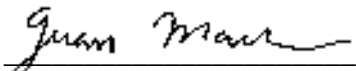
AUTHORIZED SIGNATORY: 
Juan Martinez
Senior EMC Engineer



2016-01

Elliott Laboratories, Inc. is accredited by the A2LA, certificate number 2016-01, to perform the test(s) listed in this report. This report shall not be reproduced, except in its entirety, without the written approval of Elliott Laboratories, Inc.

REVISION HISTORY

Revision #	Date	Comments	Modified By
1	November 16, 2006	Initial Release	David Guidotti

TABLE OF CONTENTS

COVER PAGE..... 1

REVISION HISTORY 2

TABLE OF CONTENTS 3

SCOPE..... 5

OBJECTIVE 6

STATEMENT OF COMPLIANCE 6

TEST RESULTS SUMMARY 7

 DIGITAL TRANSMISSION SYSTEMS (2400 – 2483.5MHZ)..... 7

 GENERAL REQUIREMENTS APPLICABLE TO ALL BANDS 7

MEASUREMENT UNCERTAINTIES 8

EQUIPMENT UNDER TEST (EUT) DETAILS 9

 GENERAL..... 9

 ANTENNA SYSTEM 9

 ENCLOSURE 9

 MODIFICATIONS 9

 SUPPORT EQUIPMENT 9

 EUT INTERFACE PORTS 9

 EUT OPERATION 9

TEST SITE..... 10

 GENERAL INFORMATION 10

 CONDUCTED EMISSIONS CONSIDERATIONS..... 10

 RADIATED EMISSIONS CONSIDERATIONS..... 10

MEASUREMENT INSTRUMENTATION 11

 RECEIVER SYSTEM 11

 INSTRUMENT CONTROL COMPUTER 11

 LINE IMPEDANCE STABILIZATION NETWORK (LISN)..... 11

 FILTERS/ATTENUATORS..... 12

 ANTENNAS..... 12

 ANTENNA MAST AND EQUIPMENT TURNTABLE..... 12

 INSTRUMENT CALIBRATION..... 12

TEST PROCEDURES..... 13

 EUT AND CABLE PLACEMENT 13

 CONDUCTED EMISSIONS 13

 RADIATED EMISSIONS 13

 RADIATED EMISSIONS 14

 BANDWIDTH MEASUREMENTS 16

 SPECIFICATION LIMITS AND SAMPLE CALCULATIONS 17

 GENERAL TRANSMITTER RADIATED EMISSIONS SPECIFICATION LIMITS 18

 OUTPUT POWER LIMITS – DIGITAL TRANSMISSION SYSTEMS 18

 TRANSMIT MODE SPURIOUS RADIATED EMISSIONS LIMITS – FHSS AND DTS SYSTEMS 18

 SAMPLE CALCULATIONS - CONDUCTED EMISSIONS..... 19

 SAMPLE CALCULATIONS - RADIATED EMISSIONS 19

 SAMPLE CALCULATIONS - FIELD STRENGTH TO EIRP CONVERSION..... 20

TABLE OF CONTENTS (Continued)

EXHIBIT 1: Test Equipment Calibration Data..... 1
EXHIBIT 2: Test Measurement Data..... 2
EXHIBIT 3: Photographs of Test Configurations..... 3
EXHIBIT 4: Proposed FCC ID Label & Label Location..... 4
EXHIBIT 5: Detailed Photographs..... 5
EXHIBIT 6: Operator's Manual..... 6
EXHIBIT 7: Block Diagram..... 7
EXHIBIT 8: Schematic Diagrams..... 8
EXHIBIT 9: Theory of Operation 9
EXHIBIT 10: RF Exposure Information 10

SCOPE

An electromagnetic emissions test has been performed on the Horizon Hobby, Inc model AR7000 pursuant to the following rules:

FCC Part 15 Subpart C

Conducted and radiated emissions data has been collected, reduced, and analyzed within this report in accordance with measurement guidelines set forth in the following reference standards and as outlined in Elliott Laboratories test procedures:

ANSI C63.4:2003

The intentional radiator above has been tested in a simulated typical installation to demonstrate compliance with the relevant Industry Canada performance and procedural standards.

Final system data was gathered in a mode that tended to maximize emissions by varying orientation of EUT, orientation of power and I/O cabling, antenna search height, and antenna polarization.

Every practical effort was made to perform an impartial test using appropriate test equipment of known calibration. All pertinent factors have been applied to reach the determination of compliance.

The test results recorded herein are based on a single type test of the Horizon Hobby, Inc model AR7000 and therefore apply only to the tested sample. The sample was selected and prepared by Paul Beard of Horizon Hobby, Inc.

OBJECTIVE

The primary objective of the manufacturer is compliance with the regulations outlined in the previous section.

Prior to marketing in the USA, all unlicensed transmitters and transceivers require certification. Receive-only devices operating between 30 MHz and 960 MHz are subject to either certification or a manufacturer's declaration of conformity, with all other receive-only devices exempt from the technical requirements.

Certification is a procedure where the manufacturer submits test data and technical information to a certification body and receives a certificate or grant of equipment authorization upon successful completion of the certification body's review of the submitted documents. Once the equipment authorization has been obtained, the label indicating compliance must be attached to all identical units, which are subsequently manufactured.

Maintenance of compliance is the responsibility of the manufacturer. Any modification of the product which may result in increased emissions should be checked to ensure compliance has been maintained (i.e., printed circuit board layout changes, different line filter, different power supply, harnessing or I/O cable changes, etc.).

STATEMENT OF COMPLIANCE

The tested sample of Horizon Hobby, Inc model AR7000 complied with the requirements of the following regulations:

FCC Part 15 Subpart C

Maintenance of compliance is the responsibility of the manufacturer. Any modification of the product which may result in increased emissions should be checked to ensure compliance has been maintained (i.e., printed circuit board layout changes, different line filter, different power supply, harnessing or I/O cable changes, etc.).

TEST RESULTS SUMMARY**DIGITAL TRANSMISSION SYSTEMS (2400 – 2483.5MHz)**

FCC Rule Part	RSS Rule Part	Description	Measured Value / Comments	Limit / Requirement	Result
15.247(a)	RSS 210 A8.2	Digital Modulation	Systems uses DSSS techniques	-	Complies
15.247 (a) (2)	RSS 210 A8.2 (1)	6dB Bandwidth	932 kHz	>500kHz	Complies
	RSP100	99% Bandwidth	1.4 MHz	Information only	Complies
15.247 (b) (3)	RSS 210 A8.2 (4)	Output Power (multipoint systems)	0.13 dBm (0.001 W) EIRP = 0.002 W ^{Note 1}	1Watt, EIRP limited to 4 Watts.	Complies
15.247(d)	RSS 210 A8.2 (2)	Power Spectral Density	-10.03 dBm / MHz	8dBm/3kHz	Complies
15.247(c)	RSS 210 A8.5	Antenna Port Spurious Emissions 30MHz – 25 GHz	Refer to plots in T-log data sheets	< -20dBc	Complies
15.247(c) / 15.209	RSS 210 A8.5	Radiated Spurious Emissions 30MHz – 25 GHz	52.4dBμV/m @ 7427.1MHz (-1.6dB)	15.207 in restricted bands, all others < -20dBc	Complies

Note 1: EIRP calculated using antenna gain of 2 dBi for the highest EIRP multi-point system.

GENERAL REQUIREMENTS APPLICABLE TO ALL BANDS

FCC Rule Part	RSS Rule part	Description	Measured Value / Comments	Limit / Requirement	Result (margin)
15.203	-	RF Connector	Per Theory of operation page 2 of 2 The antenna is a monopole wire. The user cannot detach it.		Complies
15.109	RSS GEN 7.2.3 Table 1	Receiver spurious emissions	N/A – IC is not being requested		N/A
15.207	RSS GEN Table 2	AC Conducted Emissions	Battery operated	Refer to standard	N/A
15.247 (b) (5) 15.407 (f)	RSS 102	RF Exposure Requirements	Refer to MPE calculations in Exhibit 11	Refer to OET 65, FCC Part 1 and RSS 102	Complies
	RSP 100 RSS GEN 7.1.5	User Manual	N/A – IC is not being requested	Statement required regarding non-interference	
	RSP 100 RSS GEN 7.1.5	User Manual	N/A – IC is not being requested	Statement required regarding detachable antenna	

MEASUREMENT UNCERTAINTIES

ISO Guide 17025 requires that an estimate of the measurement uncertainties associated with the emissions test results be included in the report. The measurement uncertainties given below are based on a 95% confidence level and were calculated in accordance with UKAS document LAB 34.

Measurement Type	Frequency Range (MHz)	Calculated Uncertainty (dB)
Conducted Emissions	0.15 to 30	± 2.4
Radiated Emissions	0.015 to 30	± 3.0
Radiated Emissions	30 to 1000	± 3.6
Radiated Emissions	1000 to 40000	± 6.0

EQUIPMENT UNDER TEST (EUT) DETAILS**GENERAL**

The Horizon Hobby, Inc model AR7000 is a 2.4GHz DSSS transceiver module which is designed for model control and telemetry. The EUT was mounted into a test fixture and the fixture was treated as tabletop equipment during testing. The electrical rating of the module is 2.7 - 3.6V DC 20mA.

The sample was received on November 9, 2006 and tested on November 9, 2006. The EUT consisted of the following component(s):

Manufacturer	Model	Description	Serial Number	FCC ID
Horizon Hobby	AR7000	2.4GHz DSSS Transceiver Module	PFB101005	BRWDASRX10

ANTENNA SYSTEM

The EUT antenna is a 2dBi Folded dipole.

The antenna connects to the EUT via a non-standard micro-coax, thereby meeting the requirements of FCC 15.203.

ENCLOSURE

The EUT does not have an enclosure as it is designed to be installed within the enclosure of a host device.

MODIFICATIONS

The EUT did not require modifications during testing in order to comply with emissions specifications.

SUPPORT EQUIPMENT

No support equipment was used during emissions testing.

EUT INTERFACE PORTS

The I/O cabling configuration during emissions testing was as follows:

Port	Connected To	Cable(s)		
		Description	Shielded or Unshielded	Length(m)
None	-	-	-	-

EUT OPERATION

The X1TXM module was configured to continuously transmit on a single channel (top, center or bottom) for transmit-mode tests. For receive mode tests the device was configured to continuously receive on the center channel.

TEST SITE

GENERAL INFORMATION

Final test measurements were taken on November 9, 2006 at the Elliott Laboratories Open Area Test Site #2 located at 684 West Maude Avenue, Sunnyvale, California. Pursuant to section 2.948 of the FCC's Rules and section 3.3 of RSP-100, construction, calibration, and equipment data has been filed with the Commission.

ANSI C63.4:2003 recommends that ambient noise at the test site be at least 6 dB below the allowable limits. Ambient levels are below this requirement with the exception of predictable local TV, radio, and mobile communications traffic. The test site contains separate areas for radiated and conducted emissions testing. Considerable engineering effort has been expended to ensure that the facilities conform to all pertinent requirements of ANSI C63.4:2003 and RSS 212.

CONDUCTED EMISSIONS CONSIDERATIONS

Conducted emissions testing is performed in conformance with ANSI C63.4:2003 and RSS 212. Measurements are made with the EUT connected to the public power network through a nominal, standardized RF impedance, which is provided by a line impedance stabilization network, known as a LISN. A LISN is inserted in series with each current-carrying conductor in the EUT power cord.

RADIATED EMISSIONS CONSIDERATIONS

The FCC has determined that radiation measurements made in a shielded enclosure are not suitable for determining levels of radiated emissions. Radiated measurements are performed in an open field environment or in a semi-anechoic chamber. The test sites are maintained free of conductive objects within the CISPR defined elliptical area incorporated in ANSI C63.4:2003 guidelines and meet the Normalized Site Attenuation (NSA) requirements of ANSI C63.4:2003 / RSS 212.

MEASUREMENT INSTRUMENTATION**RECEIVER SYSTEM**

An EMI receiver as specified in CISPR 16-1 is used for emissions measurements. The receivers used can measure over the frequency range of 9 kHz up to 2000 MHz. These receivers allow both ease of measurement and high accuracy to be achieved. The receivers have Peak, Average, and CISPR (Quasi-peak) detectors built into their design so no external adapters are necessary. The receiver automatically sets the required bandwidth for the CISPR detector used during measurements. If the repetition frequency of the signal being measured is below 20Hz, peak measurements are made in lieu of Quasi-Peak measurements.

For measurements above the frequency range of the receivers, a spectrum analyzer is utilized because it provides visibility of the entire spectrum along with the precision and versatility required to support engineering analysis. Average measurements above 1000MHz are performed on the spectrum analyzer using the linear-average method with a resolution bandwidth of 1 MHz and a video bandwidth of 10 Hz, unless the signal is pulsed in which case the average (or video) bandwidth of the measuring instrument is reduced to onset of pulse desensitization and then increased.

INSTRUMENT CONTROL COMPUTER

The receivers utilize either a Rohde & Schwarz EZM Spectrum Monitor/Controller or contain an internal Spectrum Monitor/Controller to view and convert the receiver measurements to the field strength at an antenna or voltage developed at the LISN measurement port, which is then compared directly with the appropriate specification limit. This provides faster, more accurate readings by performing the conversions described under Sample Calculations within the Test Procedures section of this report. Results are printed in a graphic and/or tabular format, as appropriate. A personal computer is used to record all measurements made with the receivers.

The Spectrum Monitor provides a visual display of the signal being measured. In addition, the controller or a personal computer run automated data collection programs which control the receivers. This provides added accuracy since all site correction factors, such as cable loss and antenna factors are added automatically.

LINE IMPEDANCE STABILIZATION NETWORK (LISN)

Line conducted measurements utilize a fifty microhenry Line Impedance Stabilization Network as the monitoring point. The LISN used also contains a 250 uH CISPR adapter. This network provides for calibrated radio frequency noise measurements by the design of the internal low pass and high pass filters on the EUT and measurement ports, respectively.

FILTERS/ATTENUATORS

External filters and precision attenuators are often connected between the receiving antenna or LISN and the receiver. This eliminates saturation effects and non-linear operation due to high amplitude transient events.

ANTENNAS

A loop antenna is used below 30 MHz. For the measurement range 30 MHz to 1000 MHz either a combination of a biconical antenna and a log periodic or a bi-log antenna is used. Above 1000 MHz, horn antennas are used. The antenna calibration factors to convert the received voltage to an electric field strength are included with appropriate cable loss and amplifier gain factors to determine an overall site factor, which is then programmed into the test receivers or incorporated into the test software.

ANTENNA MAST AND EQUIPMENT TURNTABLE

The antennas used to measure the radiated electric field strength are mounted on a non-conductive antenna mast equipped with a motor-drive to vary the antenna height. Measurements below 30 MHz are made with the loop antenna at a fixed height of 1m above the ground plane.

ANSI C63.4:2003 and RSS 212 specify that the test height above ground for table mounted devices shall be 80 centimeters. Floor mounted equipment shall be placed on the ground plane if the device is normally used on a conductive floor or separated from the ground plane by insulating material from 3 to 12 mm if the device is normally used on a non-conductive floor. During radiated measurements, the EUT is positioned on a motorized turntable in conformance with this requirement.

INSTRUMENT CALIBRATION

All test equipment is regularly checked to ensure that performance is maintained in accordance with the manufacturer's specifications. All antennas are calibrated at regular intervals with respect to tuned half-wave dipoles. An exhibit of this report contains the list of test equipment used and calibration information.

TEST PROCEDURES

EUT AND CABLE PLACEMENT

The regulations require that interconnecting cables be connected to the available ports of the unit and that the placement of the unit and the attached cables simulate the worst case orientation that can be expected from a typical installation, so far as practicable. To this end, the position of the unit and associated cabling is varied within the guidelines of ANSI C63.4:2003, and the worst-case orientation is used for final measurements.

CONDUCTED EMISSIONS

Conducted emissions are measured at the plug end of the power cord supplied with the EUT. Excess power cord length is wrapped in a bundle between 30 and 40 centimeters in length near the center of the cord. Preliminary measurements are made to determine the highest amplitude emission relative to the specification limit for all the modes of operation. Placement of system components and varying of cable positions are performed in each mode. A final peak mode scan is then performed in the position and mode for which the highest emission was noted on all current carrying conductors of the power cord.

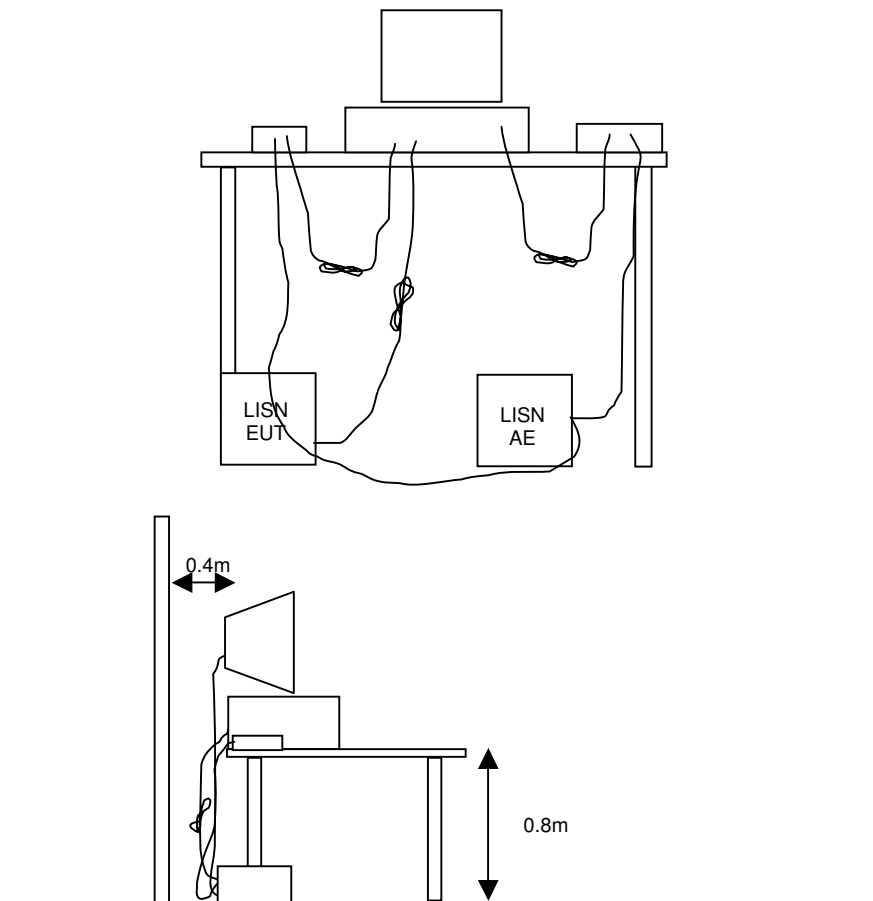

RADIATED EMISSIONS

A preliminary scan of the radiated emissions is performed in which all significant EUT frequencies are identified with the system in a nominal configuration. At least two scans are performed, one scan for each antenna polarization (horizontal and vertical; loop parallel and perpendicular to the EUT). During the preliminary scans, the EUT is rotated through 360°, the antenna height is varied (for measurements above 30 MHz) and cable positions are varied to determine the highest emission relative to the limit. Preliminary scans may be performed in a fully anechoic chamber for the purposes of identifying the frequencies of the highest emissions from the EUT.

A speaker is provided in the receiver to aid in discriminating between EUT and ambient emissions. Other methods used during the preliminary scan for EUT emissions involve scanning with near field magnetic loops, monitoring I/O cables with RF current clamps, and cycling power to the EUT.

Final maximization is a phase in which the highest amplitude emissions identified in the spectral search are viewed while the EUT azimuth angle is varied from 0 to 360 degrees relative to the receiving antenna. The azimuth, which results in the highest emission is then maintained while varying the antenna height from one to four meters (for measurements above 30 MHz, measurements below 30 MHz are made with the loop antenna at a fixed height of 1m). The result is the identification of the highest amplitude for each of the highest peaks. Each recorded level is corrected in the receiver using appropriate factors for cables, connectors, antennas, and preamplifier gain.

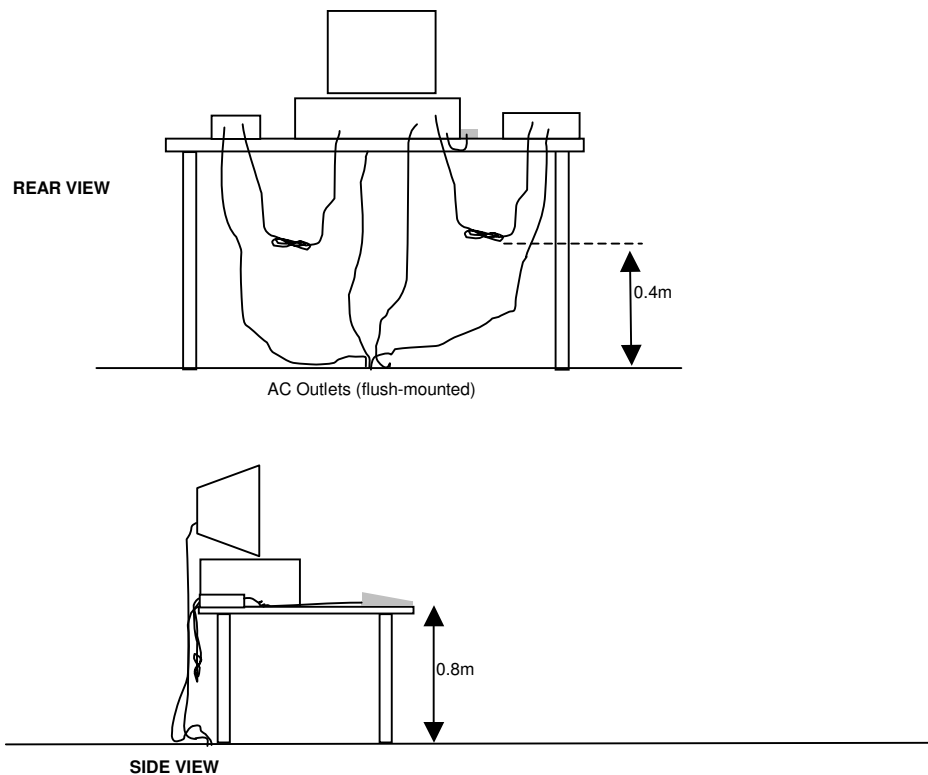

Typical Test Configuration for Radiated Field Strength Measurements

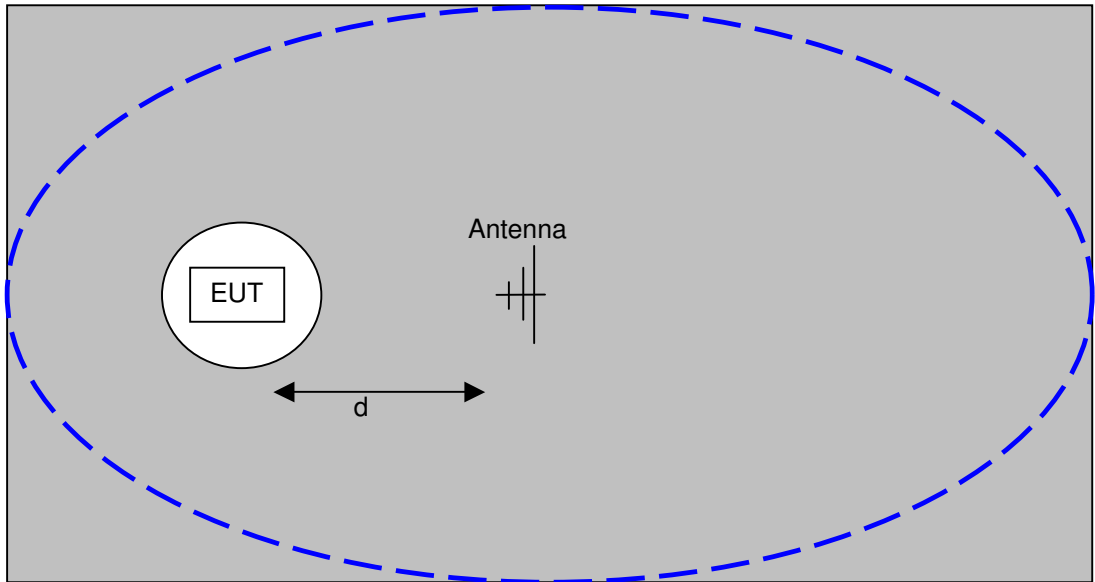

The ground plane extends beyond the ellipse defined in CISPR 16 / CISPR 22 / ANSI C63.4 and is large enough to accommodate test distances (d) of 3m and 10m. Refer to the test data tables for the actual measurement distance.

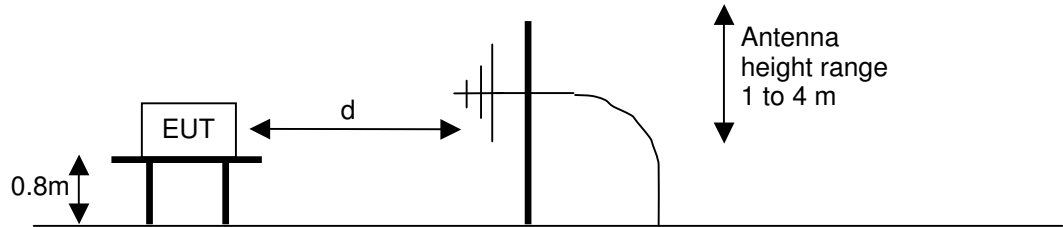

Test Configuration for Radiated Field Strength Measurements
OATS- Plan and Side Views

BANDWIDTH MEASUREMENTS

The 6dB, 20dB and/or 26dB signal bandwidth is measured in using the bandwidths recommended by ANSI C63.4. When required, the 99% bandwidth is measured using the methods detailed in RSS GEN.

SPECIFICATION LIMITS AND SAMPLE CALCULATIONS

The limits for conducted emissions are given in units of microvolts, and the limits for radiated emissions are given in units of microvolts per meter at a specified test distance. Data is measured in the logarithmic form of decibels relative to one microvolt, or dB microvolts (dBuV). For radiated emissions, the measured data is converted to the field strength at the antenna in dB microvolts per meter (dBuV/m). The results are then converted to the linear forms of uV and uV/m for comparison to published specifications.

For reference, converting the specification limits from linear to decibel form is accomplished by taking the base ten logarithm, then multiplying by 20. These limits in both linear and logarithmic form are as follows:

GENERAL TRANSMITTER RADIATED EMISSIONS SPECIFICATION LIMITS

The table below shows the limits for the spurious emissions from transmitters that fall in restricted bands¹ (with the exception of transmitters operating under FCC Part 15 Subpart D and RSS 210 Annex 9), the limits for all emissions from a low power device operating under the general rules of RSS 310 (tables 3 and 4), RSS 210 (table 2) and FCC Part 15 Subpart C section 15.209.

Frequency Range (MHz)	Limit (uV/m)	Limit (dBuV/m @ 3m)
0.009-0.490	$2400/F_{\text{KHz}} @ 300\text{m}$	$67.6-20*\log_{10}(F_{\text{KHz}}) @ 300\text{m}$
0.490-1.705	$24000/F_{\text{KHz}} @ 30\text{m}$	$87.6-20*\log_{10}(F_{\text{KHz}}) @ 30\text{m}$
1.705 to 30	30 @ 30m	29.5 @ 30m
30 to 88	100 @ 3m	40 @ 3m
88 to 216	150 @ 3m	43.5 @ 3m
216 to 960	200 @ 3m	46.0 @ 3m
Above 960	500 @ 3m	54.0 @ 3m

OUTPUT POWER LIMITS – DIGITAL TRANSMISSION SYSTEMS

The table below shows the limits for output power and output power density. Where the signal bandwidth is less than 20 MHz the maximum output power is reduced to the power spectral density limit plus 10 times the log of the bandwidth (in MHz).

Operating Frequency (MHz)	Output Power	Power Spectral Density
902 – 928	1 Watt (30 dBm)	8 dBm/3kHz
2400 – 2483.5	1 Watt (30 dBm)	8 dBm/3kHz
5725 – 5850	1 Watt (30 dBm)	8 dBm/3kHz

The maximum permitted output power is reduced by 1dB for every dB the antenna gain exceeds 6dBi. Fixed point-to-point applications using the 5725 – 5850 MHz band are not subject to this restriction.

TRANSMIT MODE SPURIOUS RADIATED EMISSIONS LIMITS – FHSS and DTS SYSTEMS

The limits for unwanted (spurious) emissions from the transmitter falling in the restricted bands are those specified in the general limits sections of FCC Part 15 and RSS 210. All other unwanted (spurious) emissions shall be at least 20dB below the level of the highest in-band signal level (30dB if the power is measured using the sample detector/power averaging method).

¹ The restricted bands are detailed in FCC 15.203, RSS 210 Table 1 and RSS 310 Table 2

SAMPLE CALCULATIONS - CONDUCTED EMISSIONS

Receiver readings are compared directly to the conducted emissions specification limit (decibel form) as follows:

$$R_r - S = M$$

where:

R_r = Receiver Reading in dBuV

S = Specification Limit in dBuV

M = Margin to Specification in +/- dB

SAMPLE CALCULATIONS - RADIATED EMISSIONS

Receiver readings are compared directly to the specification limit (decibel form). The receiver internally corrects for cable loss, preamplifier gain, and antenna factor. The calculations are in the reverse direction of the actual signal flow, thus cable loss is added and the amplifier gain is subtracted. The Antenna Factor converts the voltage at the antenna coaxial connector to the field strength at the antenna elements.

A distance factor, when used for electric field measurements above 30MHz, is calculated by using the following formula:

$$F_d = 20 * \text{LOG}_{10} (D_m/D_s)$$

where:

F_d = Distance Factor in dB

D_m = Measurement Distance in meters

D_s = Specification Distance in meters

For electric field measurements below 30MHz the extrapolation factor is either determined by making measurements at multiple distances or a theoretical value is calculated using the formula:

$$F_d = 40 * \text{LOG}_{10} (D_m/D_s)$$

Measurement Distance is the distance at which the measurements were taken and Specification Distance is the distance at which the specification limits are based. The antenna factor converts the voltage at the antenna coaxial connector to the field strength at the antenna elements.

The margin of a given emission peak relative to the limit is calculated as follows:

$$R_c = R_r + F_d$$

and

$$M = R_c - L_s$$

where:

$$R_r = \text{Receiver Reading in dBuV/m}$$

$$F_d = \text{Distance Factor in dB}$$

$$R_c = \text{Corrected Reading in dBuV/m}$$

$$L_s = \text{Specification Limit in dBuV/m}$$

$$M = \text{Margin in dB Relative to Spec}$$

SAMPLE CALCULATIONS - FIELD STRENGTH TO EIRP CONVERSION

Where the radiated electric field strength is expressed in terms of the equivalent isotropic radiated power (eirp), or where a field strength measurement of output power is made in lieu of a direct measurement, the following formula is used to convert between eirp and field strength at a distance of 3m from the equipment under test:

$$E = \frac{1000000 \sqrt{30 P}}{3} \quad \text{microvolts per meter}$$

where P is the eirp (Watts)

EXHIBIT 1: Test Equipment Calibration Data

1 Page

Radiated Emissions, 30 - 18,000 MHz, 09-Nov-06**Engineer: Mehran Birgani**

<u>Manufacturer</u>	<u>Description</u>	<u>Model #</u>	<u>Asset #</u>	<u>Cal Due</u>
Hewlett Packard	Microwave Preamplifier, 1-26.5GHz	8449B	870	13-Jan-07
Hewlett Packard	SpecAn 30 Hz -40 GHz, SV (SA40) Red	8564E (84125C)	1148	19-May-07
Hewlett Packard	High Pass filter, 3.5 GHz	P/N 84300-80038 (84125C)	1403	09-Jun-07
EMCO	Antenna, Horn, 1-18 GHz	3115	1561	10-May-08

Radiated Emissions, 30 - 26,500 MHz, 31-Oct-06**Engineer: Mehran Birgani**

<u>Manufacturer</u>	<u>Description</u>	<u>Model #</u>	<u>Asset #</u>	<u>Cal Due</u>
Hewlett Packard	Microwave Preamplifier, 1-26.5GHz	8449B	785	24-Apr-07
EMCO	Antenna, Horn, 1-18 GHz (SA40)	3115	1386	11-Jul-08
Hewlett Packard	High Pass filter, 3.5 GHz	P/N 84300-80038 (84125C)	1768	04-Nov-06
Hewlett Packard	Test Sys (SA40, 9kHz - 40GHz) Purple	84125C	1770	04-Nov-06

EXHIBIT 2: Test Measurement Data

17 Pages



EMC Test Data

Client:	Horizon Hobby, Inc.	Job Number:	J65909
Model:	AR7000	Test-Log Number:	T66072
		Project Manager:	Sheareen Washington
Contact:	Paul Beard		
Emissions Spec:	EN 300 440 V1.3.1/FCC 15.247	Class:	B
Immunity Spec:	-	Environment:	-

EMC Test Data

For The

Horizon Hobby, Inc.

Model

AR7000

Date of Last Test: 11/9/2006



EMC Test Data

Client:	Horizon Hobby, Inc.	Job Number:	J65909
Model:	AR7000	Test-Log Number:	T66072
		Project Manager:	Sheareen Washington
Contact:	Paul Beard		
Emissions Spec:	EN 300 440 V1.3.1/FCC 15.247	Class:	B
Immunity Spec:	-	Environment:	-

EUT INFORMATION

General Description

The EUT is a 2.4GHz DSSS transceiver module which is designed for model control and telemetry. The EUT was mounted into a test fixture and the fixture was treated as table-top equipment during testing. The electrical rating of the module is 2.7 - 3.6V DC 20mA.

Equipment Under Test

Manufacturer	Model	Description	Serial Number	FCC ID
Horizon Hobby	AR7000	2.4GHz DSSS	PFB101005	BRWDASRX10

EUT Antenna (Intentional Radiators Only)

The EUT antenna is a 2dBi Folded dipole.

The antenna connects to the EUT via a non-standard micro-coax, thereby meeting the requirements of FCC 15.203.

EUT Enclosure

The EUT does not have an enclosure as it is designed to be installed within the enclosure of a host device.



EMC Test Data

Client:	Horizon Hobby, Inc.	Job Number:	J65909
Model:	AR7000	T-Log Number:	T66072
Contact:	Paul Beard	Project Manager:	Sheareen Washington
Emissions Spec:	EN 300 440 V1.3.1/FCC 15.247	Class:	B
Immunity Spec:	-	Environment:	-

Test Configuration #1

Local Support Equipment

Manufacturer	Model	Description	Serial Number	FCC ID
None				

Remote Support Equipment

Manufacturer	Model	Description	Serial Number	FCC ID
None				

Interface Cabling and Ports

Port	Connected To	Cable(s)		
		Description	Shielded or Unshielded	Length(m)
None				

EUT Operation During Emissions Tests

The X1TXM module was configured to continuously transmit on a single channel (top, center or bottom) for transmit-mode tests. For receive mode tests the device was configured to continuously receive on the center channel.



EMC Test Data

Client:	Horizon Hobby, Inc.	Job Number:	J65909
Model:	AR7000	T-Log Number:	T66072
Contact:	Paul Beard	Account Manager:	Sheareen Washington
Spec:	EN 300 440 V1.3.1/FCC 15.247	Class:	N/A

Run #1a: Radiated Spurious Emissions, 30 - 25,000 MHz. Low Channel @ 2402 MHz

Fundamental Signal Field Strength: Peak and average values measured in 1 MHz.

Frequency	Level	Pol	15.209 / 15.247		Detector	Azimuth	Height	Comments
MHz	dB μ V/m	V/H	Limit	Margin	Pk/QP/Avg	degrees	meters	
2401.740	94.7	V	-	-	AVG	210	1.0	RB = 1MHz, VB = 10Hz
2401.740	94.9	V	-	-	PK	210	1.0	RB = VB = 1MHz
2401.700	94.8	V	-	-	PK	210	1.0	RB = VB = 100kHz
2401.780	93.8	H	-	-	AVG	340	2.0	RB = 1MHz, VB = 10Hz
2401.780	93.9	H	-	-	PK	340	2.0	RB = VB = 1MHz

Delta Marker - Average	70.0 dB	Delta between highest in-band and highest
Delta Marker - Peak	57.7 dB	

Band Edge Signal Field Strength

Frequency	Level	Pol	15.209 / 15.247		Detector	Azimuth	Height	Comments
MHz	dB μ V/m	V/H	Limit	Margin	Pk/QP/Avg	degrees	meters	
2389.750	24.7	V	54.0	-29.3	AVG	210	1.0	RB = 1MHz, VB = 10Hz
2389.650	37.2	V	74.0	-36.8	PK	210	1.0	RB = VB = 1MHz

Note 1: Calculated by subtracting the marker delta values from the fundamental field strength measurements.

Client: Horizon Hobby, Inc.	Job Number: J65909
Model: AR7000	T-Log Number: T66072
Contact: Paul Beard	Account Manager: Sheareen Washington
Spec: EN 300 440 V1.3.1/FCC 15.247	Class: N/A

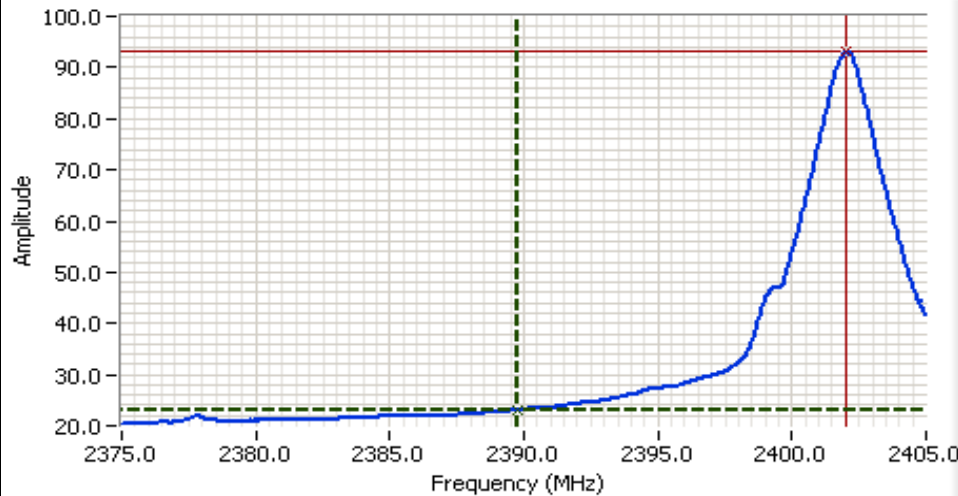

Analyzer Settings
 HP8564E,006,EMI,UK6
 CF: 2390.00 MHz
 SPAN:30.00 MHz
 RB 1.000 MHz
 VB 10 Hz
 Detector Sample
 Att 0
 RL Offset 0.00
 Sweep Time 12.0s
 Ref Lvl:94.40DBUV

Comments
 2402 MHz
 Band Edge
 Average

Cursor 1	2389.75	23.07	
Cursor 2	2402.05	93.07	

Delta Freq. 12.30
 Delta Amplitude 70.00

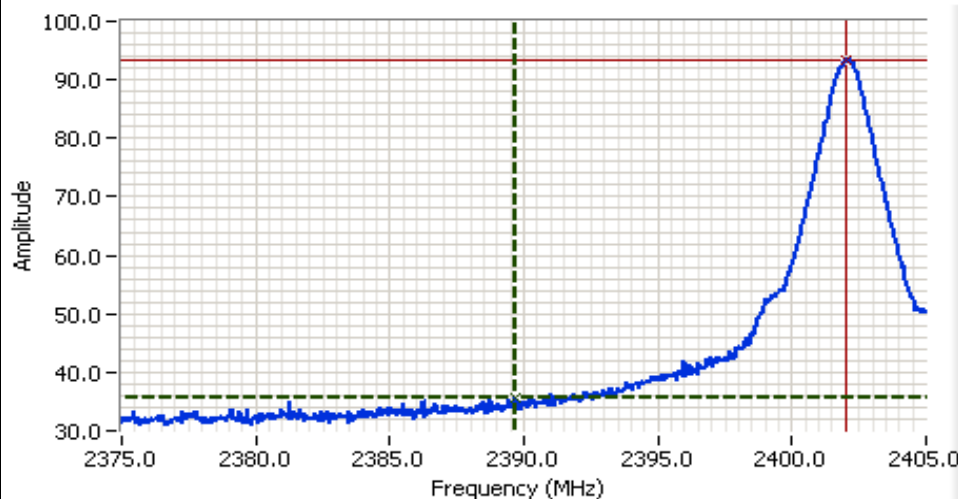

Analyzer Settings
 HP8564E,006,EMI,UK6
 CF: 2390.00 MHz
 SPAN:30.00 MHz
 RB 1.000 MHz
 VB 1.000 MHz
 Detector POS
 Att 0
 RL Offset 0.00
 Sweep Time 50.0ms
 Ref Lvl:94.40DBUV

Comments
 2402 MHz
 Band Edge
 Peak

Cursor 1	2389.65	35.57	
Cursor 2	2402.00	93.23	

Delta Freq. 12.35
 Delta Amplitude 57.67





EMC Test Data

Client:	Horizon Hobby, Inc.	Job Number:	J65909
Model:	AR7000	T-Log Number:	T66072
Contact:	Paul Beard	Account Manager:	Sheareen Washington
Spec:	EN 300 440 V1.3.1/FCC 15.247	Class:	N/A

Run 1a: Continue (Other Spurious Emissions)

Frequency MHz	Level dB μ V/m	Pol V/H	15.209 / 15.247		Detector Pk/QP/Avg	Azimuth degrees	Height meters	Comments
			Limit	Margin				
4803.480	50.7	V	54.0	-3.3	AVG	120	2.2	
7205.140	48.3	V	54.0	-5.7	AVG	42	1.0	Note 2
7205.150	46.9	H	54.0	-7.1	AVG	58	2.2	Note 2
4803.470	44.3	H	54.0	-9.7	AVG	122	1.2	
4803.480	53.5	V	74.0	-20.5	PK	120	2.2	
7205.140	52.2	V	74.0	-21.8	PK	42	1.0	Note 2
7205.150	51.8	H	74.0	-22.2	PK	58	2.2	Note 2
4803.470	49.2	H	74.0	-24.8	PK	122	1.2	

Note 1: For emissions in restricted bands, the limit of 15.209 was used. For all other emissions, the limit was set 20dB below the level of the fundamental.

Note 2: The signal does not fall in a restricted band, but the more stringent limits of 15.209 were applied.

Run #1b: Radiated Spurious Emissions, 30 - 25,000 MHz. Center Channel @ 2442 MHz

Other Spurious Emissions

Frequency MHz	Level dB μ V/m	Pol V/H	15.209 / 15.247		Detector Pk/QP/Avg	Azimuth degrees	Height meters	Comments
			Limit	Margin				
4883.480	51.1	V	54.0	-2.9	AVG	103	1.2	
7325.150	48.6	V	54.0	-5.4	AVG	355	1.0	
7325.150	44.4	H	54.0	-9.6	AVG	346	1.1	
4883.450	44.1	H	54.0	-9.9	AVG	267	1.0	
4883.480	53.6	V	74.0	-20.4	PK	103	1.2	
7325.150	52.7	V	74.0	-21.3	PK	355	1.0	
7325.150	51.0	H	74.0	-23.0	PK	346	1.1	
4883.450	49.6	H	74.0	-24.4	PK	267	1.0	

Note 1: For emissions in restricted bands, the limit of 15.209 was used. For all other emissions, the limit was set 20dB below the level of the fundamental.



EMC Test Data

Client:	Horizon Hobby, Inc.	Job Number:	J65909
Model:	AR7000	T-Log Number:	T66072
Contact:	Paul Beard	Account Manager:	Sheareen Washington
Spec:	EN 300 440 V1.3.1/FCC 15.247	Class:	N/A

Run #1c: Radiated Spurious Emissions, 30 - 25,000 MHz. High Channel @ 2476 MHz

Fundamental Signal Field Strength: Peak and average values measured in 1 MHz.

Frequency	Level	Pol	15.209 / 15.247		Detector	Azimuth	Height	Comments
MHz	dB μ V/m	V/H	Limit	Margin	Pk/QP/Avg	degrees	meters	
2475.770	95.7	V	-	-	AVG	273	1.1	RB = 1MHz, VB = 10Hz
2475.770	95.8	V	-	-	PK	273	1.1	RB = VB = 1MHz
2475.700	95.7	V	-	-	PK	273	1.1	RB = VB = 100kHz
2475.760	88.8	H	-	-	AVG	161	2.3	RB = 1MHz, VB = 10Hz
2475.760	89.0	H	-	-	PK	161	2.3	RB = VB = 1MHz

Delta Marker - Average	66.2 dB	Delta between highest in-band and highest
Delta Marker - Peak	54.2 dB	

Band Edge Signal Field Strength

Frequency	Level	Pol	15.209 / 15.247		Detector	Azimuth	Height	Comments
MHz	dB μ V/m	V/H	Limit	Margin	Pk/QP/Avg	degrees	meters	
2483.550	29.5	V	54.0	-24.5	AVG	273	1.1	RB = 1MHz, VB = 10Hz
2483.550	41.6	V	74.0	-32.4	PK	273	1.1	RB = VB = 1MHz

Note 1: Calculated by subtracting the marker delta values from the fundamental field strength measurements.

Other Spurious Emissions

Frequency	Level	Pol	15.209 / 15.247		Detector	Azimuth	Height	Comments
MHz	dB μ V/m	V/H	Limit	Margin	Pk/QP/Avg	degrees	meters	
7427.120	52.4	V	54.0	-1.6	AVG	350	2.2	
4951.470	49.9	V	54.0	-4.1	AVG	83	1.1	
7427.140	46.1	H	54.0	-7.9	AVG	106	2.3	
4951.470	41.5	H	54.0	-12.5	AVG	264	1.0	
7427.120	55.3	V	74.0	-18.7	PK	350	2.2	
4951.470	52.9	V	74.0	-21.1	PK	83	1.1	
7427.140	51.3	H	74.0	-22.7	PK	106	2.3	
4951.470	47.9	H	74.0	-26.1	PK	264	1.0	

Note 1: For emissions in restricted bands, the limit of 15.209 was used. For all other emissions, the limit was set 20dB below the level of the fundamental.

Client: Horizon Hobby, Inc.	Job Number: J65909
Model: AR7000	T-Log Number: T66072
Contact: Paul Beard	Account Manager: Sheareen Washington
Spec: EN 300 440 V1.3.1/FCC 15.247	Class: N/A

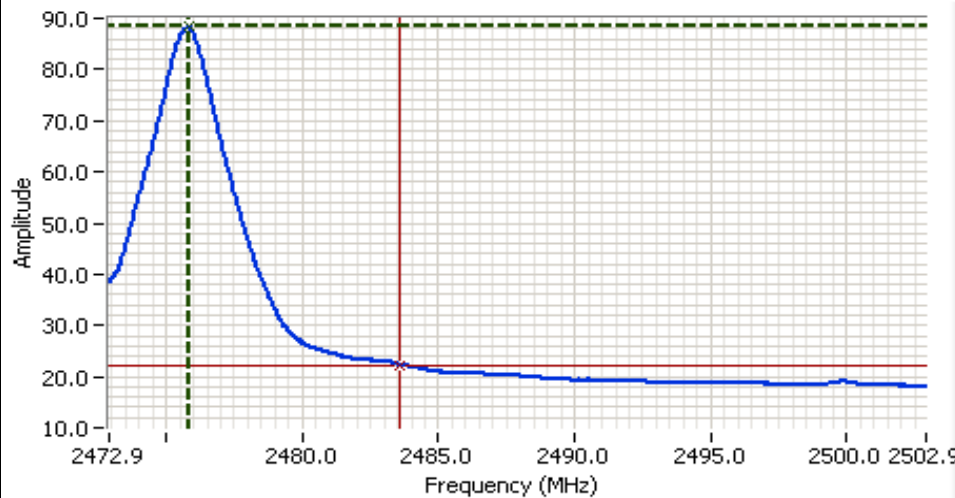

Analyzer Settings
 HP8564E,006,EMI,UK6
 CF: 2487.90 MHz
 SPAN:30.00 MHz
 RB 1.000 MHz
 VB 10 Hz
 Detector Sample
 Att 0
 RL Offset 0.00
 Sweep Time 12.0s
 Ref Lvl:89.90DBUV

Comments
 2476 MHz
 Band Edge
 Average

Cursor 1	2475.80	88.40	
Cursor 2	2483.55	22.23	

Delta Freq. 7.750
 Delta Amplitude 66.17

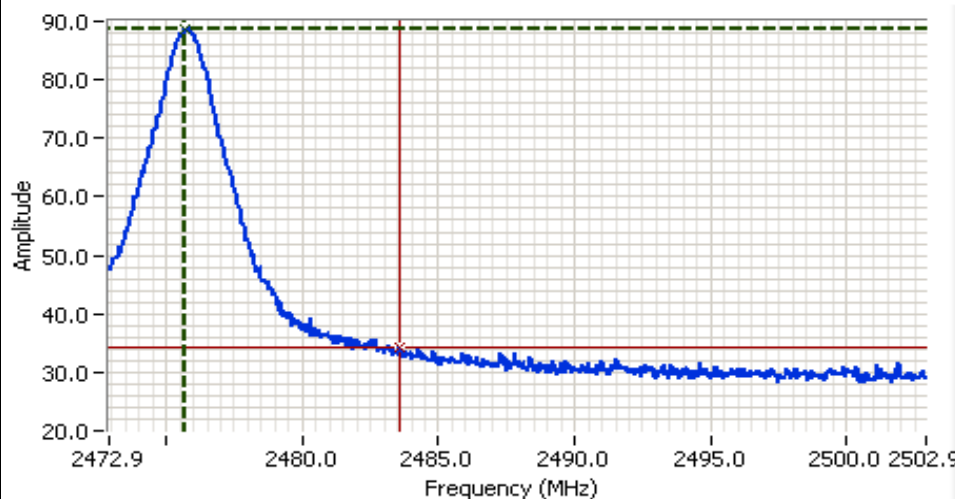

Analyzer Settings
 HP8564E,006,EMI,UK6
 CF: 2487.90 MHz
 SPAN:30.00 MHz
 RB 1.000 MHz
 VB 1.000 MHz
 Detector POS
 Att 0
 RL Offset 0.00
 Sweep Time 50.0ms
 Ref Lvl:89.90DBUV

Comments
 2476 MHz
 Band Edge
 Peak

Cursor 1	2475.70	88.57	
Cursor 2	2483.55	34.40	

Delta Freq. 7.850
 Delta Amplitude 54.17





EMC Test Data

Client:	Horizon Hobby, Inc.	Job Number:	J65909
Model:	AR7000	T-Log Number:	T66072
Contact:	Paul Beard	Account Manager:	Sheareen Washington
Standard:	EN 300 440 V1.3.1/FCC 15.247	Class:	N/A

RSS 210 and FCC 15.247 (DTS) Antenna Port Measurements Power, Bandwidth and Spurious Emissions

Test Specifics

Objective: The objective of this test session is to perform final qualification testing of the EUT with respect to the specification listed above.

Date of Test: 10/31/2006
Test Engineer: Mehran Birgani
Test Location: SVOATS #1
Config. Used: 1
Config Change: None
EUT Voltage Battery

General Test Configuration

The EUT was located on the turntable for radiated spurious emissions testing.

For radiated emissions testing the measurement antenna was located 3 meters from the EUT.

When measuring the conducted emissions from the EUT's antenna port, the antenna port of the EUT was connected to the spectrum analyzer or power meter via a suitable attenuator to prevent overloading the measurement system. All measurements are corrected to allow for the external attenuators used.

Ambient Conditions: Temperature: 16 °C
Rel. Humidity: 55 %

Summary of Results

Run #	Test Performed	Limit	Pass / Fail	Result / Margin
1d	RF Port Spurious Emissions, 30 - 26,500 MHz	FCC Part 15.209 / 15.247(c)	Pass	> 20dB Margin
2	6dB Bandwidth	15.247(a)	Pass	932 kHz
3	Output Power	15.247(b)	Pass	0.2 dBm
4	Power Spectral Density (PSD)	15.247(d)	Pass	-10.03 dBm/3kHz

Modifications Made During Testing:

No modifications were made to the EUT during testing

Deviations From The Standard

No deviations were made from the requirements of the standard.

Client: Horizon Hobby, Inc.	Job Number: J65909
Model: AR7000	T-Log Number: T66072
Contact: Paul Beard	Account Manager: Sheareen Washington
Standard: EN 300 440 V1.3.1/FCC 15.247	Class: N/A

Run #1d: Antenna Conducted Spurious Emissions, 30 - 26,500 MHz.

Refer to plots below. Scans made using RBW=VB=100 KHz with the limit line set at 20dB below the highest in-band signal level.
 [Spur at 30MHz in the first plot is actually artifact of 0Hz]

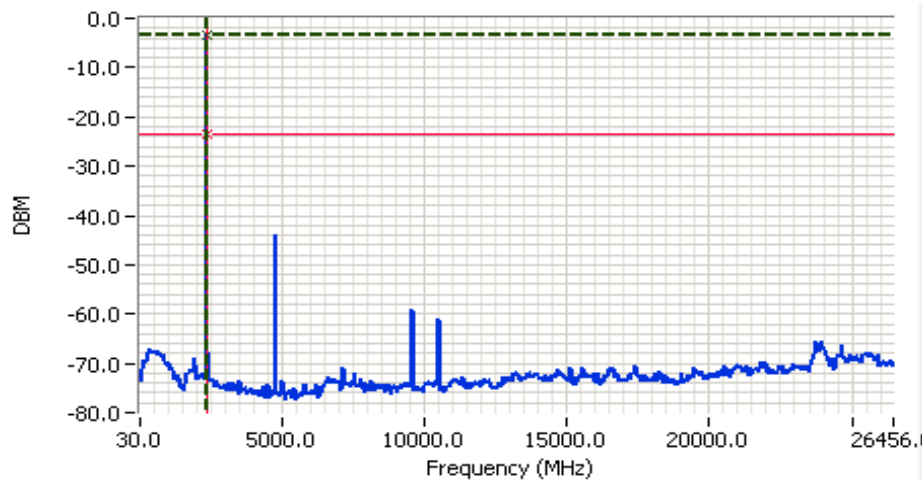

Analyzer Settings
 HP8564E,EMI
 CF: 13265.00 MHz
 SPAN:26470.00 MHz
 RB 100 kHz
 VB 100 kHz
 Detector POS
 Att 10
 RL Offset 1.00
 Sweep Time 15.0s
 Ref Lvl:0.80DBM

Comments
 Antenna Port
 2402 MHz

Cursor 1 2364.29 -3.37
 Cursor 2 2364.29 -23.37

Delta Freq. 155 Hz
 Delta Amplitude 20.00

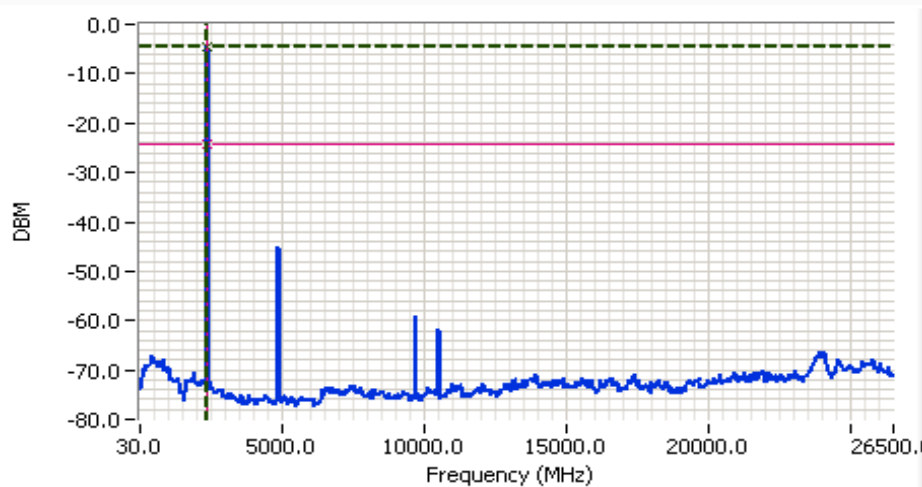

Analyzer Settings
 HP8564E,EMI
 CF: 13265.00 MHz
 SPAN:26470.00 MHz
 RB 100 kHz
 VB 100 kHz
 Detector POS
 Att 10
 RL Offset 1.00
 Sweep Time 15.0s
 Ref Lvl:0.80DBM

Comments
 Antenna Port
 2440 MHz

Cursor 1 2408.33 -4.37
 Cursor 2 2408.33 -24.37

Delta Freq. 106 Hz
 Delta Amplitude 20.00



Client: Horizon Hobby, Inc.	Job Number: J65909
Model: AR7000	T-Log Number: T66072
Contact: Paul Beard	Account Manager: Sheareen Washington
Standard: EN 300 440 V1.3.1/FCC 15.247	Class: N/A

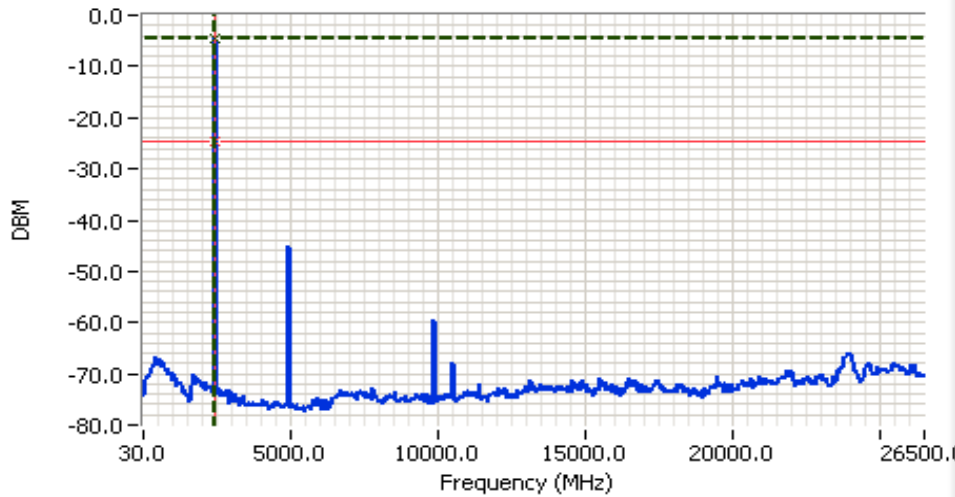

Analyzer Settings

HP8564E,EMI
 CF: 13265.00 MHz
 SPAN:26470.00 MHz
 RB 100 kHz
 VB 100 kHz
 Detector POS
 Att 10
 RL Offset 1.00
 Sweep Time 15.0s
 Ref Lvl:0.80DBM

Comments

Antenna Port
 2479 MHz

Cursor 1 2479.000 -4.53 ⊕ ⊖ ⊞ ⊚

Cursor 2 2479.000 -24.53 ⊕ ⊖ ⊞ ⊚

Delta Freq. 0.00 MHz

Delta Amplitude 20.00



Run #2: Signal Bandwidth

Rate	Frequency (MHz)	Resolution Bandwidth	6dB Signal Bandwidth	99% Signal Bandwidth
64	2402	100kHz	0.905	1.4
64	2440	100kHz	0.932	1.2
64	2479	100kHz	0.899	1.2

99% bandwidth measured on all three channels with RB=100kHz, VB=300kHz, peak detector (no averaging)
 6dB bandwidth measured using RB=100kHz, VB=100kHz, peak detector, no averaging



EMC Test Data

Client:	Horizon Hobby, Inc.	Job Number:	J65909
Model:	AR7000	T-Log Number:	T66072
Contact:	Paul Beard	Account Manager:	Sheareen Washington
Standard:	EN 300 440 V1.3.1/FCC 15.247	Class:	N/A

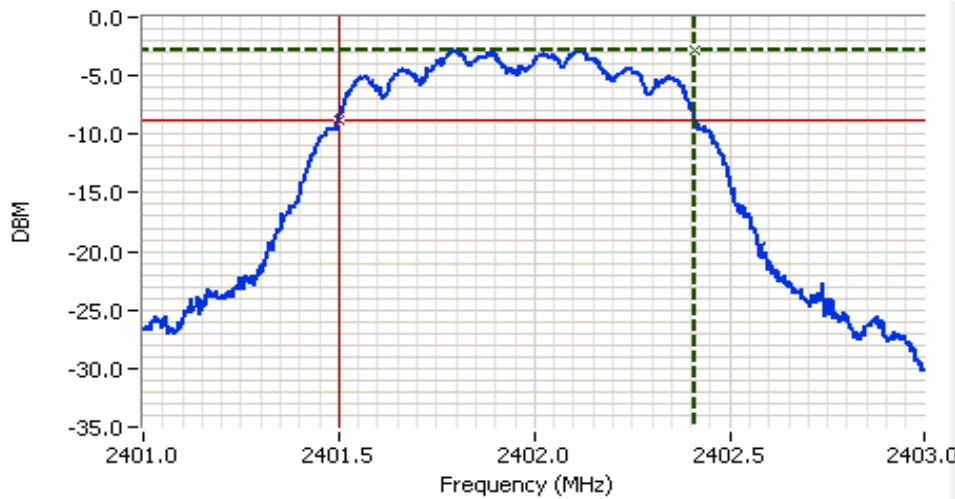

Analyzer Settings
HP8564E,EMI
CF: 2402.00 MHz
SPAN:2.000 MHz
RB 100 kHz
VB 100 kHz
Detector POS
Att 20
RL Offset 1.00
Sweep Time 50.0ms
Ref Lvl:5.20DBM

Comments
2402 MHz
6dB

Cursor 1	2402.40	-2.80	
Cursor 2	2401.50	-8.80	

Delta Freq. 0.905
Delta Amplitude 6.00

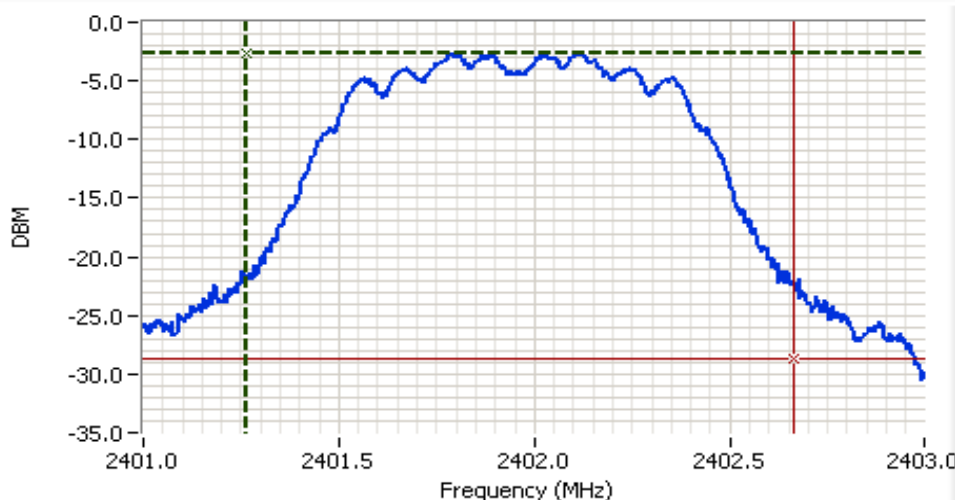

Analyzer Settings
HP8564E,EMI
CF: 2402.00 MHz
SPAN:2.000 MHz
RB 100 kHz
VB 300 kHz
Detector POS
Att 20
RL Offset 1.00
Sweep Time 50.0ms
Ref Lvl:5.20DBM

Comments
99% power bandwidth:
1.400 MHz
Power over span:
6.58dBm

Cursor 1	2401.26	-2.63	
Cursor 2	2402.66	-28.63	

Delta Freq. 1.400
Delta Amplitude 26.00





EMC Test Data

Client: Horizon Hobby, Inc.	Job Number: J65909
Model: AR7000	T-Log Number: T66072
Contact: Paul Beard	Account Manager: Sheareen Washington
Standard: EN 300 440 V1.3.1/FCC 15.247	Class: N/A

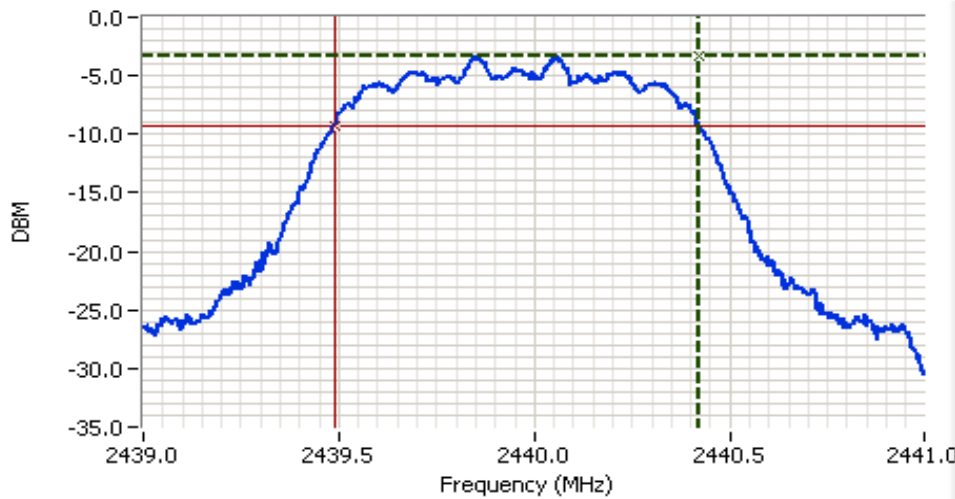

Analyzer Settings
HP8564E,EMI
CF: 2440.00 MHz
SPAN:2.000 MHz
RB 100 kHz
VB 100 kHz
Detector POS
Att 20
RL Offset 1.00
Sweep Time 50.0ms
Ref Lvl:5.20DBM

Comments
2440 MHz
6dB

Cursor 1	2440.42	-3.30	
Cursor 2	2439.48	-9.30	

Delta Freq. 0.932
Delta Amplitude 6.00

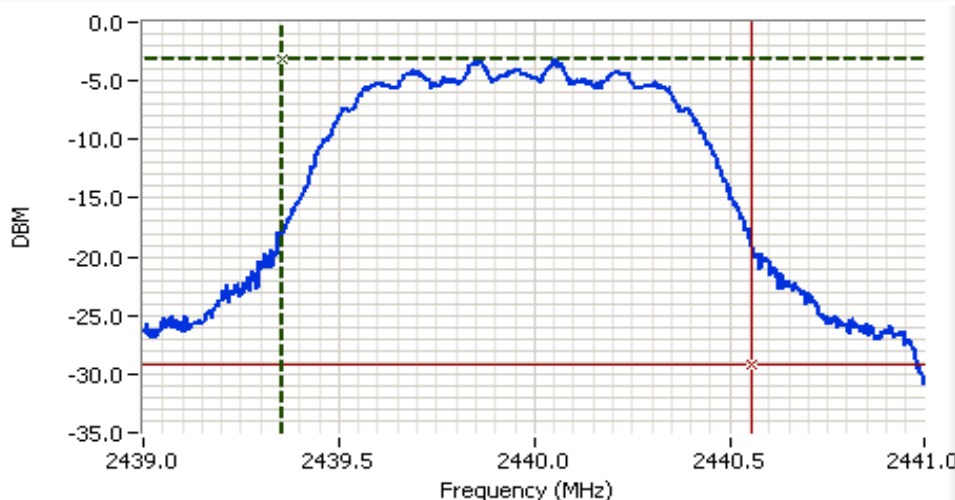

Analyzer Settings
HP8564E,EMI
CF: 2440.00 MHz
SPAN:2.000 MHz
RB 100 kHz
VB 300 kHz
Detector POS
Att 20
RL Offset 1.00
Sweep Time 50.0ms
Ref Lvl:5.20DBM

Comments
99% power bandwidth:
1.200 MHz
Power over span:
5.89dBm

Cursor 1	2439.35	-3.13	
Cursor 2	2440.55	-29.13	

Delta Freq. 1.200
Delta Amplitude 26.00





EMC Test Data

Client: Horizon Hobby, Inc.	Job Number: J65909
Model: AR7000	T-Log Number: T66072
Contact: Paul Beard	Account Manager: Sheareen Washington
Standard: EN 300 440 V1.3.1/FCC 15.247	Class: N/A

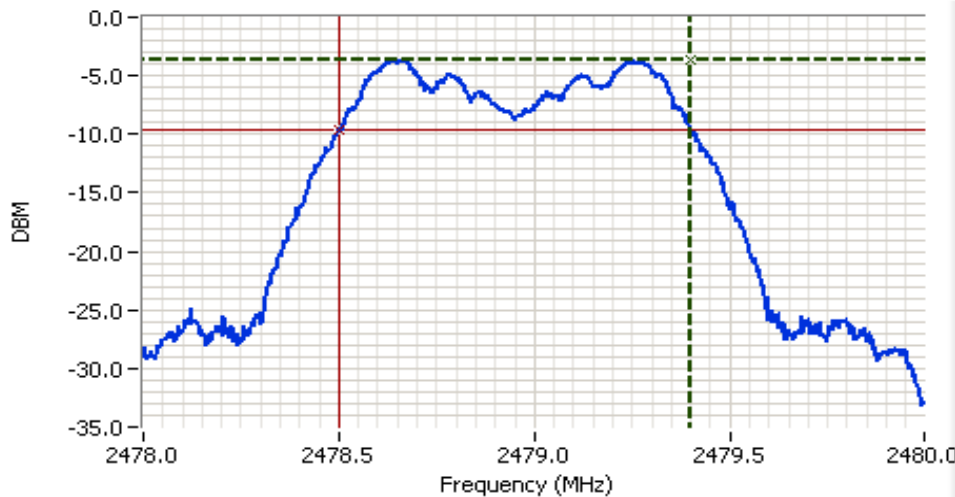

Analyzer Settings
HP8564E,EMI
CF: 2479.00 MHz
SPAN:2.000 MHz
RB 100 kHz
VB 100 kHz
Detector POS
Att 20
RL Offset 1.00
Sweep Time 50.0ms
Ref Lvl:5.20DBM

Comments
2479 MHz
6dB

Cursor 1	2479.40:	-3.63	
Cursor 2	2478.50:	-9.63	

Delta Freq. 0.899
Delta Amplitude 6.00

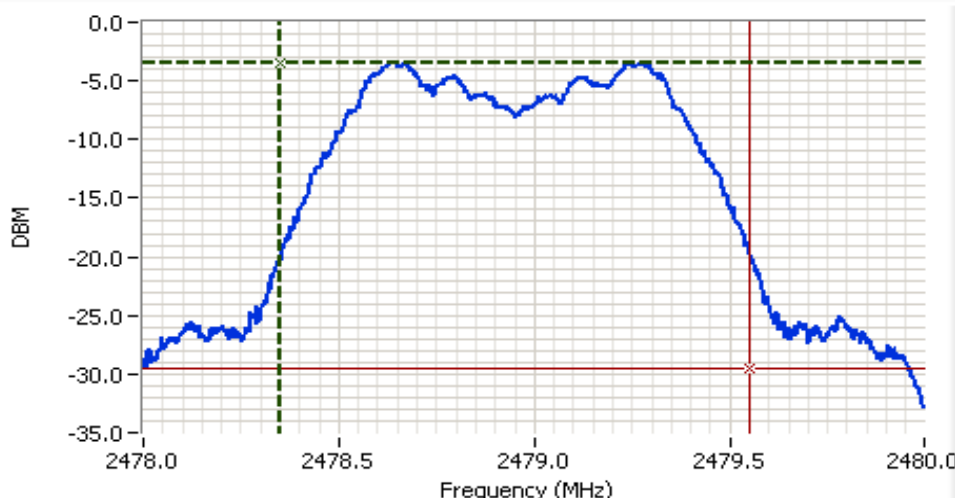

Analyzer Settings
HP8564E,EMI
CF: 2479.00 MHz
SPAN:2.000 MHz
RB 100 kHz
VB 300 kHz
Detector POS
Att 20
RL Offset 1.00
Sweep Time 50.0ms
Ref Lvl:5.20DBM

Comments
99% power bandwidth:
1.200 MHz
Power over span:
5.44dBm

Cursor 1	2478.35:	-3.47	
Cursor 2	2479.55:	-29.47	

Delta Freq. 1.200
Delta Amplitude 26.00





EMC Test Data

Client:	Horizon Hobby, Inc.	Job Number:	J65909
Model:	AR7000	T-Log Number:	T66072
Contact:	Paul Beard	Account Manager:	Sheareen Washington
Standard:	EN 300 440 V1.3.1/FCC 15.247	Class:	N/A

Run #3: Output Power

Maximum antenna gain: 2 dBi

Rate	Frequency (MHz)	Res BW MHz	Output Power ^{Note 1}		EIRP W	Average Power ^{Note 2}	
			dBm	W		dBm	W
64	2402	2	0.13	0.001	0.001		
64	2440	2	0.13	0.001	0.001		
64	2479	2	-0.40	0.001	0.001		

Note 1: Output power measured using a spectrum analyzer, RB= 2MHz, VB=3MHz

Run #4: Power Spectral Density

Rate	Operating Frequency (MHz)	Freq. @ PPSD	Res BW	P.S.D. (dBm/3kHz)
64	2402	2401.770	3 kHz	-10.03
64	2440	2441.686	3 kHz	-10.70
64	2479	2475.686	3 kHz	-12.37

Note 1: Freq. @ PPSD: Frequency of the Peak Power Spectral Density (PPSD)

Note 2: Power spectral density measured using RB=3 kHz, VB=10kHz with a sweep time set to ensure a dwell time of at least 1 second per 3kHz. The measurement is made at the frequency of PPSD determined from preliminary scans using RB=3kHz using multiple sweeps at a faster rate over the 6dB bandwidth of the signal.

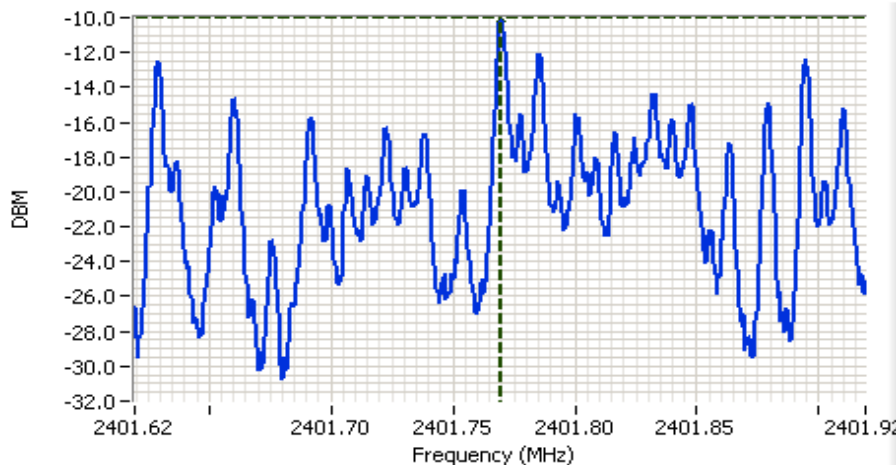

Analyzer Settings

HP8564E,EMI
 CF: 2401.77 MHz
 SPAN:300 kHz
 RB 3 kHz
 VB 10 kHz
 Detector POS
 Att 10
 RL Offset 1.00
 Sweep Time 100.0s
 Ref Lvl:0.30DBM

Comments

2402 MHz
 PSD

Cursor 1	2401.770	-10.03		
	0.000	0.00		





EMC Test Data

Client: Horizon Hobby, Inc.	Job Number: J65909
Model: AR7000	T-Log Number: T66072
Contact: Paul Beard	Account Manager: Sheareen Washington
Standard: EN 300 440 V1.3.1/FCC 15.247	Class: N/A

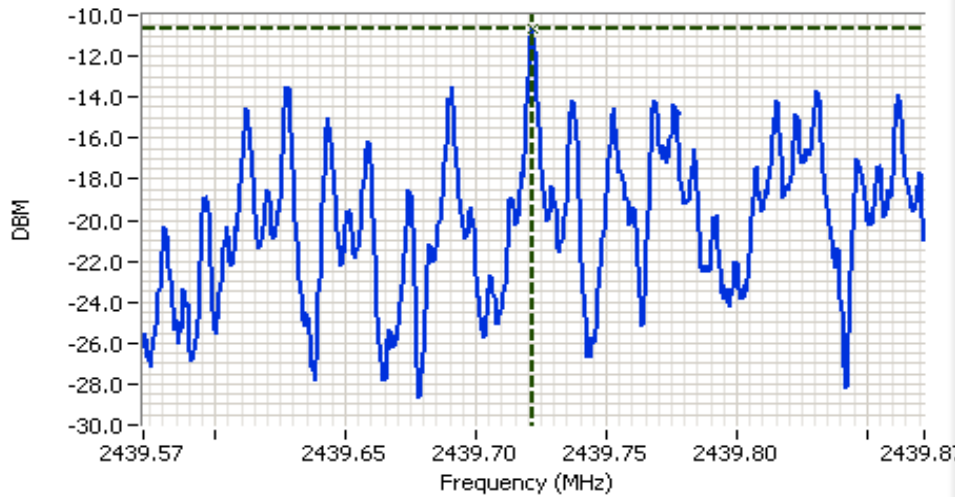

Analyzer Settings
HP8564E,EMI
CF: 2439.72 MHz
SPAN:300 kHz
RB 3 kHz
VB 10 kHz
Detector POS
Att 10
RL Offset 1.00
Sweep Time 100.0s
Ref Lvl:0.30DBM

Comments
2440 MHz
PSD

Cursor 1 2439.72: -10.70
0.000 0.00

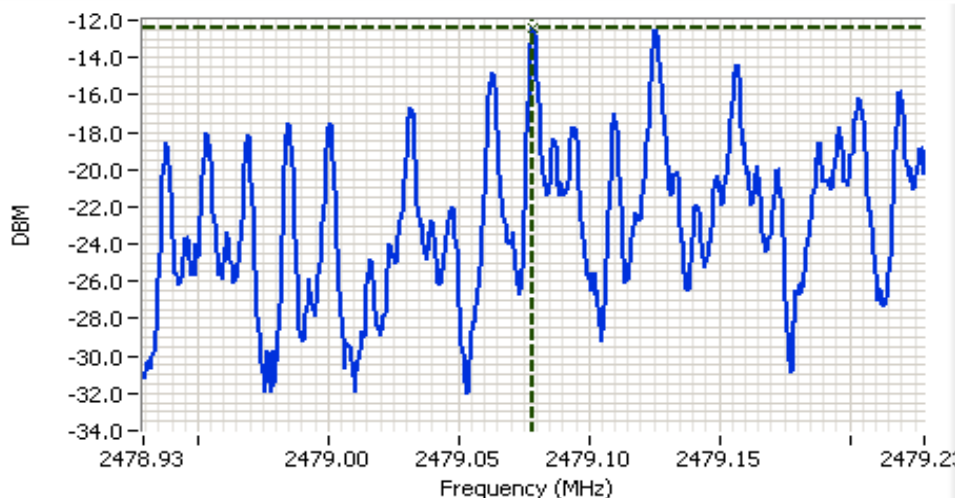

Analyzer Settings
HP8564E,EMI
CF: 2479.08 MHz
SPAN:300 kHz
RB 3 kHz
VB 10 kHz
Detector POS
Att 10
RL Offset 1.00
Sweep Time 100.0s
Ref Lvl:0.30DBM

Comments
2479 MHz
PSD

Cursor 1 2479.07: -12.37
0.000 0.00



EXHIBIT 3: Photographs of Test Configurations

2 Page

EXHIBIT 4: Proposed FCC ID Label & Label Location

2 Pages

**EXHIBIT 5: Detailed Photographs
of Horizon Hobby, Inc. Model AR7000 Construction**

4 Pages

**EXHIBIT 6: Operator's Manual
for Horizon Hobby, Inc. Model AR7000**

2 Pages

**EXHIBIT 7: Block Diagram
of Horizon Hobby, Inc. Model AR7000**

1 Page

**EXHIBIT 8: Schematic Diagrams
for Horizon Hobby, Inc. Model AR7000**

2 Pages

**EXHIBIT 9: Theory of Operation
for Horizon Hobby, Inc. Model AR7000**

2 Pages

EXHIBIT 10: RF Exposure Information

1 Page