

***Electromagnetic Emissions Test Report
and
Application for Grant of Equipment Authorization
pursuant to
Industry Canada RSS-Gen Issue 1 / RSS 210 Issue 6
FCC Part 15 Subpart C
FCC Part 15, Subpart C Section 15.247(DTS)
on the
Horizon Hobby, Inc.
Transmitter
Model: X1TXN Spektrum DSM X1***

UPN: 6157A-BRWDAMT
FCC ID: BRWDAMTX10

GRANTEE: Horizon Hobby, Inc.
4105 Fieldstone Road
Champaign, IL 61822

TEST SITE: Elliott Laboratories, Inc.
684 W. Maude Ave
Sunnyvale, CA 94086

REPORT DATE: December 1, 2005

FINAL TEST DATE: October 10 and November 23, 2005

AUTHORIZED SIGNATORY:



Mark Briggs
Principal Engineer



2016-01

Elliott Laboratories, Inc. is accredited by the A2LA, certificate number 2016-01, to perform the test(s) listed in this report. This report shall not be reproduced, except in its entirety, without the written approval of Elliott Laboratories, Inc.

Equipment Name and Model:

Transceiver X1TXN Spektrum DSM X1

Manufacturer:

Horizon Hobby, Inc.
4105 Fieldstone Road
Champaign, IL 61822

Tested to applicable standard:

Industry Canada RSS-Gen Issue 1
RSS 210 Issue 6 "Low-power Licence-exempt Radiocommunication Devices (All
Frequency Bands): Category I Equipment"

Test Report Prepared For:

Paul Beard
Horizon Hobby, Inc.
4105 Fieldstone Road
Champaign, IL 61822

Measurement Facility Description Filed With Department of Industry:

Departmental Acknowledgement Number: IC2845 SV1 Dated August 16, 2007

Declaration of Compliance

I declare that the testing was performed or supervised by me; that the test measurements were made in accordance with the above mentioned departmental standards (through the use of ANSI C63.4: 2003 as referenced by FCC Part 15 and by section 1.0 of RSS-212, Issue 1, "Test Facilities and Test Methods for Radio Equipment" / RSS-Gen Issue 1); and that the equipment performed in accordance with the data submitted in this report.

Signature



Name

Mark Briggs

Title

Principal Engineer

Elliott Laboratories Inc.

Address

684 W. Maude Ave
Sunnyvale, CA 94086
USA

Date:

December 1, 2005

TABLE OF CONTENTS

COVER PAGE..... 1

TABLE OF CONTENTS..... 3

SCOPE..... 5

OBJECTIVE..... 6

STATEMENT OF COMPLIANCE..... 7

TEST RESULTS SUMMARY 7

 DIGITAL TRANSMISSION SYSTEMS (2400 – 2483.5MHZ)..... 7

 GENERAL REQUIREMENTS APPLICABLE TO ALL BANDS 8

MEASUREMENT UNCERTAINTIES 8

EQUIPMENT UNDER TEST (EUT) DETAILS 9

 GENERAL..... 9

 ANTENNA SYSTEM 9

 ENCLOSURE..... 9

 MODIFICATIONS 9

 SUPPORT EQUIPMENT 9

 EUT INTERFACE PORTS..... 10

 EUT OPERATION..... 10

TEST SITE..... 11

 GENERAL INFORMATION 11

 CONDUCTED EMISSIONS CONSIDERATIONS 11

 RADIATED EMISSIONS CONSIDERATIONS..... 11

MEASUREMENT INSTRUMENTATION 12

 RECEIVER SYSTEM 12

 INSTRUMENT CONTROL COMPUTER 12

 LINE IMPEDANCE STABILIZATION NETWORK (LISN) 12

 FILTERS/ATTENUATORS 13

 ANTENNAS 13

 ANTENNA MAST AND EQUIPMENT TURNTABLE 13

 INSTRUMENT CALIBRATION 13

TEST PROCEDURES14

EUT AND CABLE PLACEMENT..... 14

CONDUCTED EMISSIONS 14

RADIATED EMISSIONS..... 15

CONDUCTED EMISSIONS FROM ANTENNA PORT 18

SPECIFICATION LIMITS AND SAMPLE CALCULATIONS..... 19

CONDUCTED EMISSIONS SPECIFICATION LIMITS: FCC 15.207; FCC 15.107(A), RSS GEN 19

GENERAL RADIATED EMISSIONS SPECIFICATION LIMITS 20

RECEIVER SPURIOUS EMISSIONS SPECIFICATION LIMITS..... 20

OUTPUT POWER LIMITS – DIGITAL TRANSMISSION SYSTEMS..... 21

TRANSMIT MODE SPURIOUS RADIATED EMISSIONS LIMITS – FHSS AND DTS SYSTEMS 21

SAMPLE CALCULATIONS - CONDUCTED EMISSIONS 21

SAMPLE CALCULATIONS - RADIATED EMISSIONS..... 22

SAMPLE CALCULATIONS - FIELD STRENGTH TO EIRP CONVERSION 23

EXHIBIT 1: Test Equipment Calibration Data..... 1

EXHIBIT 2: Test Measurement Data..... 2

EXHIBIT 3: Photographs of Test Configurations..... 3

EXHIBIT 4: Proposed FCC ID Label & Label Location 4

EXHIBIT 5: Detailed Photographs of..... 5

Horizon Hobby, Inc. Model X1TXN Spektrum DSM X1 Construction..... 5

EXHIBIT 6: Operator's Manual for..... 6

Horizon Hobby, Inc. Model X1TXN Spektrum DSM X1..... 6

EXHIBIT 7: Block Diagram of..... 7

Horizon Hobby, Inc. Model X1TXN Spektrum DSM X1..... 7

EXHIBIT 8: Schematic Diagrams for..... 8

Horizon Hobby, Inc. Model X1TXN Spektrum DSM X1..... 8

EXHIBIT 9: Theory of Operation for..... 9

Horizon Hobby, Inc. Model X1TXN Spektrum DSM X1..... 9

EXHIBIT 10: Modular Approval Requirements 10

EXHIBIT 11: RF Exposure Information 11

SCOPE

An electromagnetic emissions test has been performed on the Horizon Hobby, Inc model X1TXN Spektrum DSM X1 pursuant to the following rules:

Industry Canada RSS-Gen Issue 1
RSS 210 Issue 6 "Low-power Licence-exempt Radiocommunication Devices (All Frequency Bands): Category I Equipment"
FCC Part 15, Subpart C requirements for DTS devices

Conducted and radiated emissions data has been collected, reduced, and analyzed within this report in accordance with measurement guidelines set forth in the following reference standards and as outlined in Elliott Laboratories test procedures:

ANSI C63.4:2003
RSS-212 Issue 1 Test Facilities and Test Methods for Radio Equipment

The intentional radiator above has been tested in a simulated typical installation to demonstrate compliance with the relevant Industry Canada performance and procedural standards.

Final system data was gathered in a mode that tended to maximize emissions by varying orientation of EUT, orientation of power and I/O cabling, antenna search height, and antenna polarization.

Every practical effort was made to perform an impartial test using appropriate test equipment of known calibration. All pertinent factors have been applied to reach the determination of compliance.

The test results recorded herein are based on a single type test of the Horizon Hobby, Inc model X1TXN Spektrum DSM X1 and therefore apply only to the tested sample. The sample was selected and prepared by Paul Beard of Horizon Hobby, Inc.

OBJECTIVE

The primary objective of the manufacturer is compliance with the regulations outlined in the previous section. Certification of these devices is required as a prerequisite to marketing in the US and Canada.

The primary objective of the manufacturer is compliance with the regulations outlined in the previous section. Certification of these devices is required as a prerequisite to marketing in the US. Devices categorized as Class II equipment do not require certification by Industry Canada.

Certification is a procedure where the manufacturer submits test data and technical information to a certification body and receives a certificate or grant of equipment authorization upon successful completion of the certification body's review of the submitted documents. Once the equipment authorization has been obtained, the label indicating compliance must be attached to all identical units, which are subsequently manufactured.

Maintenance of compliance is the responsibility of the manufacturer. Any modification of the product which may result in increased emissions should be checked to ensure compliance has been maintained (i.e., printed circuit board layout changes, different line filter, different power supply, harnessing or I/O cable changes, etc.).

STATEMENT OF COMPLIANCE

The tested sample of Horizon Hobby, Inc model X1TXN Spektrum DSM X1 complied with the requirements of the following regulations:

Industry Canada RSS-Gen Issue 1

RSS 210 Issue 6 “Low-power Licence-exempt Radiocommunication Devices (All Frequency Bands): Category I Equipment”

FCC Part 15, Subpart C requirements for DTS devices

Maintenance of compliance is the responsibility of the manufacturer. Any modification of the product which may result in increased emissions should be checked to ensure compliance has been maintained (i.e., printed circuit board layout changes, different line filter, different power supply, harnessing or I/O cable changes, etc.).

TEST RESULTS SUMMARY**DIGITAL TRANSMISSION SYSTEMS (2400 – 2483.5MHz)**

FCC Part 15 Reference	RSS Reference	Description	Measured Value / Comments	Limit / Requirement	Result
15.247(a)	RSS 210 A8.2	Digital Modulation	Systems uses DSSS digital modulation techniques	-	Complies
15.247 (a) (2)	RSS 210 A8.2 (1)	6dB Bandwidth	843kHz min.	>500kHz	Complies
	RSP100	99% Bandwidth	1.2 MHz	Information only	Complies
15.247 (b) (3)	RSS 210 A8.2 (4)	Output Power (multipoint systems)	21 dBm (0.128 Watts) EIRP = 0.20 W ^{Note 1}	1Watt, EIRP limited to 4 Watts.	Complies
15.247(d)	RSS 210 A8.2 (2)	Power Spectral Density	5.29 dBm / 3KHz	8dBm/3kHz	Complies
15.247(c)	RSS 210 A8.5	Antenna Port Spurious Emissions 30MHz – 25 GHz	All spurious emissions were more than -20dBc	< -20dBc	Complies
15.247(c) / 15.209	RSS 210 A8.5	Radiated Spurious Emissions 30MHz – 25 GHz	53.1dBμV/m @ 4801.9MHz	15.207 in restricted bands, all others < -20dBc	Complies (-0.9dB)

Note 1: EIRP calculated using antenna gain of 2 dBi.

GENERAL REQUIREMENTS APPLICABLE TO ALL BANDS

FCC Part 15 Section	RSS 210 Section	Description	Measured Value / Comments	Limit / Requirement	Result (margin)
15.203	-	RF Connector	Connector is a non-standard micro-coax connector	Non-standard connector	Complies
15.109	RSS GEN 7.2.3 Table 1	Receiver spurious emissions			Complies (- ?? dB)
15.207	RSS GEN Table 2	AC Conducted Emissions	35.6dB μ V @ 0.358MHz	Refer to standard	Complies (-13.2dB)
15.247 (b) (5) 15.407 (f)	RSS 102	RF Exposure Requirements	Refer to MPE calculations in Exhibit 11, RSS 102 declaration and User Manual statements.	Refer to OET 65, FCC Part 1 and RSS 102	Complies

MEASUREMENT UNCERTAINTIES

ISO Guide 17025 requires that an estimate of the measurement uncertainties associated with the emissions test results be included in the report. The measurement uncertainties given below are based on a 95% confidence level and were calculated in accordance with UKAS document LAB 34.

Measurement Type	Frequency Range (MHz)	Calculated Uncertainty (dB)
Conducted Emissions	0.15 to 30	± 2.4
Radiated Emissions	0.015 to 30	$\pm ???$
Radiated Emissions	30 to 1000	± 3.6
Radiated Emissions	1000 to 40000	$\pm \pm ???$

EQUIPMENT UNDER TEST (EUT) DETAILS**GENERAL**

The Horizon Hobby, Inc model X1TXN Spektrum DSM X1 is a 2.4GHz DSSS transceiver module which is designed for model control and telemetry. This is a high power version of a previously certified module (FCC ID BRW DSMTX10)

Normally, the EUT would be placed on a table top during operation. The EUT was, therefore, treated as table-top equipment during testing to simulate the end-user environment. The electrical rating of the 9.6V DC 300mA

The sample was received on October 10, 2005 and tested on October 10 and November 23, 2005. The EUT consisted of the following component(s):

Manufacturer	Model	Description	Serial Number	FCC ID
Horizon Hobby	X1TXN	2.4GHz DSSS Transceiver Module	PFB101005	BRWDAMTX10

ANTENNA SYSTEM

The EUT antenna is a 2dBi Folded dipole. The antenna connects to the EUT via a non-standard micro-coax, thereby meeting the requirements of FCC 15.203.

ENCLOSURE

The EUT does not have an enclosure as it is designed to be installed within the enclosure of a host computer.

MODIFICATIONS

The EUT did not require modifications during testing in order to comply with emissions specifications.

SUPPORT EQUIPMENT

The following equipment was used as local support equipment for emissions testing:

Manufacturer	Model	Description	Serial Number	FCC ID
JR	XP9303	9# RC Unit	1953706	N/A
SPEKTRUM	SPM7101	AC-DC Adapter	-	N/A

EUT INTERFACE PORTS

The I/O cabling configuration during emissions testing was as follows:

Port	Connected To	Cable(s)		
		Description	Shielded or Unshielded	Length(m)
None	-	-	-	-

EUT OPERATION

The X1TXM module was configured to continuously transmit on a single channel (top, center or bottom) for transmit-mode tests. For receive mode tests the device was configured to continuously receive on the center channel.

TEST SITE

GENERAL INFORMATION

Final test measurements were taken on November 23, 2005 at the Elliott Laboratories Open Area Test Site #1 located at 684 West Maude Avenue, Sunnyvale, California. Pursuant to section 2.948 of the FCC's Rules and section 3.3 of RSP-100, construction, calibration, and equipment data has been filed with the Commission.

ANSI C63.4:2003 recommends that ambient noise at the test site be at least 6 dB below the allowable limits. Ambient levels are below this requirement with the exception of predictable local TV, radio, and mobile communications traffic. The test site contains separate areas for radiated and conducted emissions testing. Considerable engineering effort has been expended to ensure that the facilities conform to all pertinent requirements of ANSI C63.4:2003 and RSS 212.

CONDUCTED EMISSIONS CONSIDERATIONS

Conducted emissions testing is performed in conformance with ANSI C63.4:2003 and RSS 212. Measurements are made with the EUT connected to the public power network through a nominal, standardized RF impedance, which is provided by a line impedance stabilization network, known as a LISN. A LISN is inserted in series with each current-carrying conductor in the EUT power cord.

RADIATED EMISSIONS CONSIDERATIONS

The FCC has determined that radiation measurements made in a shielded enclosure are not suitable for determining levels of radiated emissions. Radiated measurements are performed in an open field environment or in a semi-anechoic chamber. The test sites are maintained free of conductive objects within the CISPR defined elliptical area incorporated in ANSI C63.4:2003 guidelines and meet the Normalized Site Attenuation (NSA) requirements of ANSI C63.4:2003 / RSS 212.

MEASUREMENT INSTRUMENTATION

RECEIVER SYSTEM

An EMI receiver as specified in CISPR 16-1 is used for emissions measurements. The receivers used can measure over the frequency range of 9 kHz up to 2000 MHz. These receivers allow both ease of measurement and high accuracy to be achieved. The receivers have Peak, Average, and CISPR (Quasi-peak) detectors built into their design so no external adapters are necessary. The receiver automatically sets the required bandwidth for the CISPR detector used during measurements. If the repetition frequency of the signal being measured is below 20Hz, peak measurements are made in lieu of Quasi-Peak measurements.

For measurements above the frequency range of the receivers, a spectrum analyzer is utilized because it provides visibility of the entire spectrum along with the precision and versatility required to support engineering analysis. Average measurements above 1000MHz are performed on the spectrum analyzer using the linear-average method with a resolution bandwidth of 1 MHz and a video bandwidth of 10 Hz, unless the signal is pulsed in which case the average (or video) bandwidth of the measuring instrument is reduced to onset of pulse desensitization and then increased.

INSTRUMENT CONTROL COMPUTER

The receivers utilize either a Rohde & Schwarz EZM Spectrum Monitor/Controller or contain an internal Spectrum Monitor/Controller to view and convert the receiver measurements to the field strength at an antenna or voltage developed at the LISN measurement port, which is then compared directly with the appropriate specification limit. This provides faster, more accurate readings by performing the conversions described under Sample Calculations within the Test Procedures section of this report. Results are printed in a graphic and/or tabular format, as appropriate. A personal computer is used to record all measurements made with the receivers.

The Spectrum Monitor provides a visual display of the signal being measured. In addition, the controller or a personal computer run automated data collection programs which control the receivers. This provides added accuracy since all site correction factors, such as cable loss and antenna factors are added automatically.

LINE IMPEDANCE STABILIZATION NETWORK (LISN)

Line conducted measurements utilize a fifty microhenry Line Impedance Stabilization Network as the monitoring point. The LISN used also contains a 250 uH CISPR adapter. This network provides for calibrated radio frequency noise measurements by the design of the internal low pass and high pass filters on the EUT and measurement ports, respectively.

FILTERS/ATTENUATORS

External filters and precision attenuators are often connected between the receiving antenna or LISN and the receiver. This eliminates saturation effects and non-linear operation due to high amplitude transient events.

ANTENNAS

A biconical antenna is used to cover the range from 30 MHz to 300 MHz and a log periodic antenna is utilized from 300 MHz to 1000 MHz. Narrowband tuned dipole antennas are used over the entire 30 to 1000 MHz range for precision measurements of field strength. Above 1000 MHz, a horn antenna is used. The antenna calibration factors are included in site factors programmed into the test receivers or incorporated into the test software.

ANTENNA MAST AND EQUIPMENT TURNTABLE

The antennas used to measure the radiated electric field strength are mounted on a non-conductive antenna mast equipped with a motor-drive to vary the antenna height.

ANSI C63.4:2003 and RSS 212 specify that the test height above ground for table mounted devices shall be 80 centimeters. Floor mounted equipment shall be placed on the ground plane if the device is normally used on a conductive floor or separated from the ground plane by insulating material from 3 to 12 mm if the device is normally used on a non-conductive floor. During radiated measurements, the EUT is positioned on a motorized turntable in conformance with this requirement.

INSTRUMENT CALIBRATION

All test equipment is regularly checked to ensure that performance is maintained in accordance with the manufacturer's specifications. All antennas are calibrated at regular intervals with respect to tuned half-wave dipoles. An exhibit of this report contains the list of test equipment used and calibration information.

TEST PROCEDURES

EUT AND CABLE PLACEMENT

The regulations require that interconnecting cables be connected to the available ports of the unit and that the placement of the unit and the attached cables simulate the worst case orientation that can be expected from a typical installation, so far as practicable. To this end, the position of the unit and associated cabling is varied within the guidelines of ANSI C63.4:2003, and the worst-case orientation is used for final measurements.

CONDUCTED EMISSIONS

Conducted emissions are measured at the plug end of the power cord supplied with the EUT. Excess power cord length is wrapped in a bundle between 30 and 40 centimeters in length near the center of the cord. Preliminary measurements are made to determine the highest amplitude emission relative to the specification limit for all the modes of operation. Placement of system components and varying of cable positions are performed in each mode. A final peak mode scan is then performed in the position and mode for which the highest emission was noted on all current carrying conductors of the power cord.

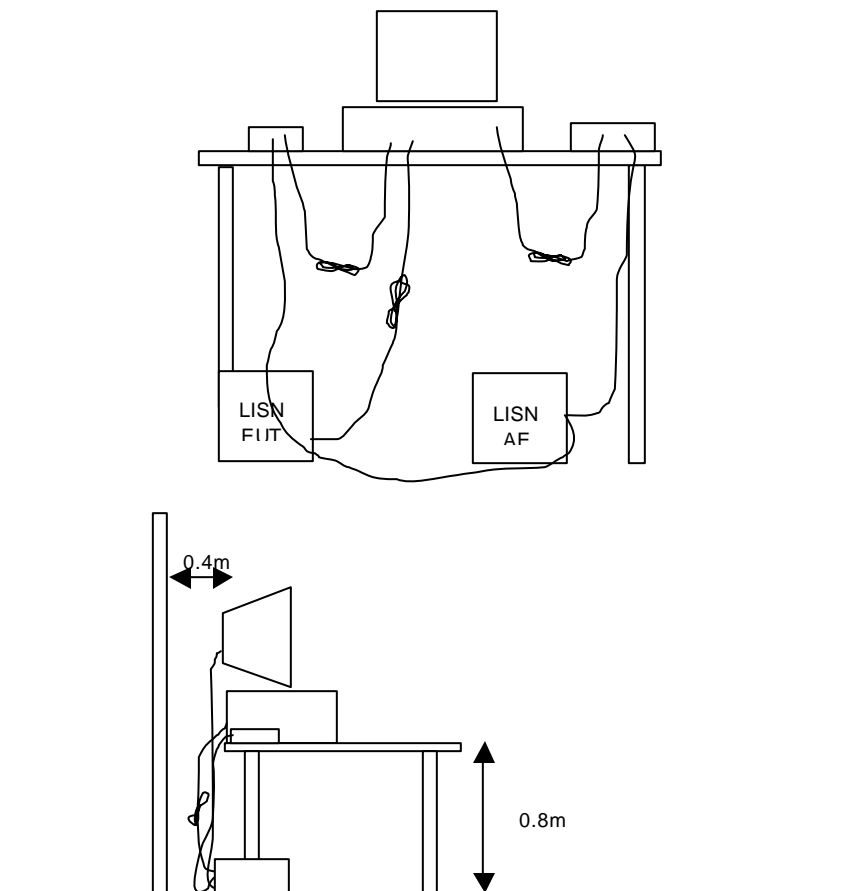

RADIATED EMISSIONS

Radiated emissions measurements are performed in two phases as well. A preliminary scan of emissions is conducted in which all significant EUT frequencies are identified with the system in a nominal configuration. At least two scans are performed from 30 MHz up to the frequency required by the regulation specified on page 1. One or more of these is with the antenna polarized vertically while the one or more of these is with the antenna polarized horizontally. During the preliminary scans, the EUT is rotated through 360°, the antenna height is varied and cable positions are varied to determine the highest emission relative to the limit. Preliminary scans may be performed in a fully anechoic chamber for the purposes of identifying the frequencies of the highest emissions from the EUT.

A speaker is provided in the receiver to aid in discriminating between EUT and ambient emissions. Other methods used during the preliminary scan for EUT emissions involve scanning with near field magnetic loops, monitoring I/O cables with RF current clamps, and cycling power to the EUT.

Final maximization is a phase in which the highest amplitude emissions identified in the spectral search are viewed while the EUT azimuth angle is varied from 0 to 360 degrees relative to the receiving antenna. The azimuth, which results in the highest emission is then maintained while varying the antenna height from one to four meters. The result is the identification of the highest amplitude for each of the highest peaks. Each recorded level is corrected in the receiver using appropriate factors for cables, connectors, antennas, and preamplifier gain. Emissions, which have values close to the specification limit may also be measured with a tuned dipole antenna to determine compliance.

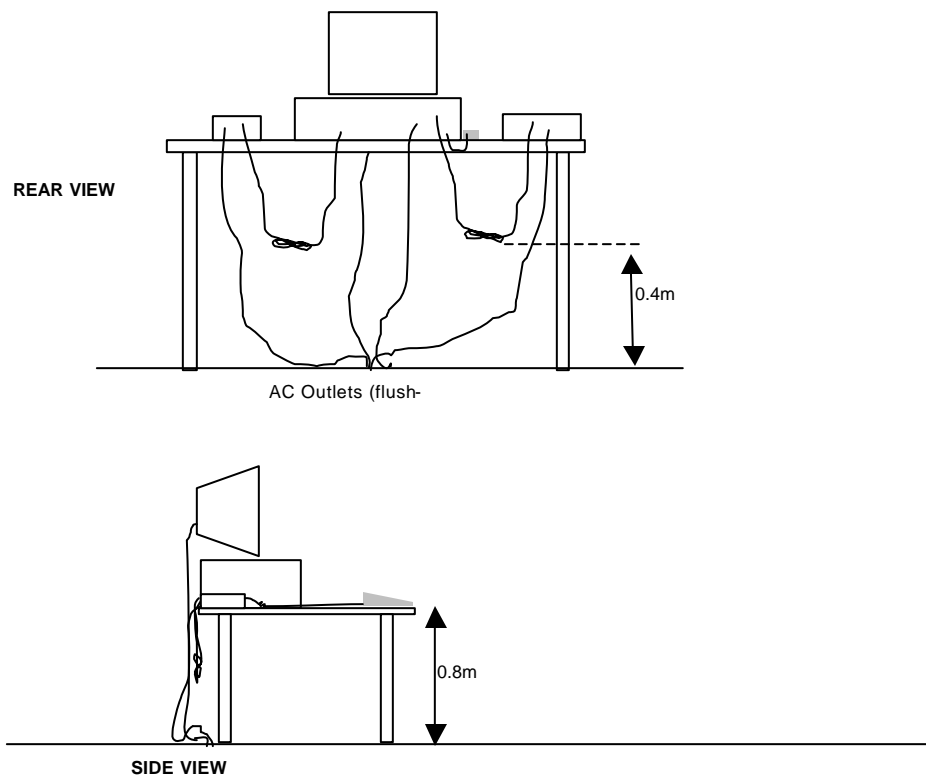

Typical Test Configuration for Radiated Field Strength Measurements

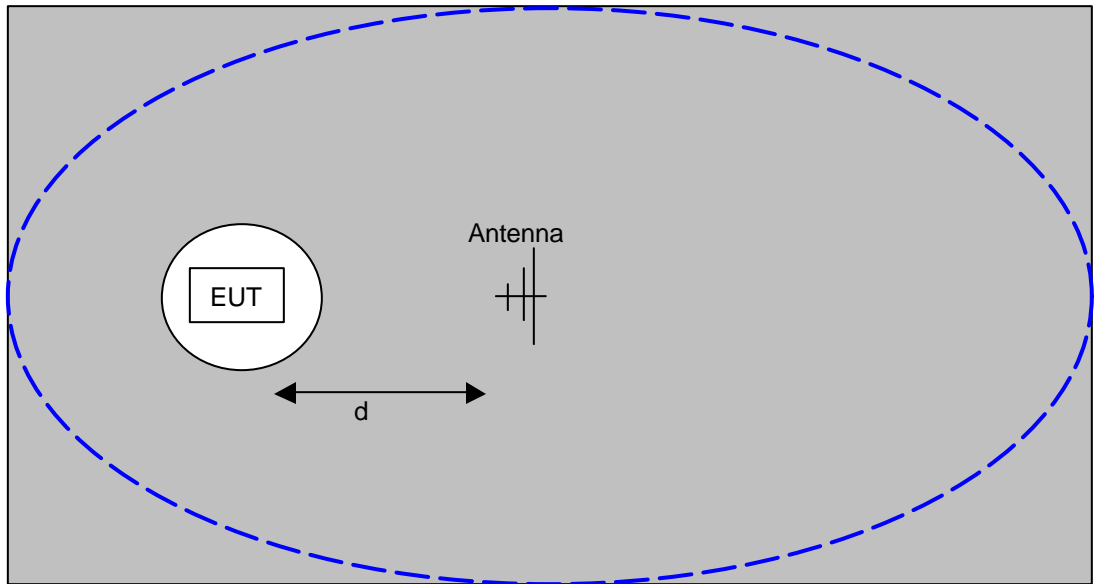

The ground plane extends beyond the ellipse defined in CISPR 16 / CISPR 22 / ANSI C63.4 and is large enough to accommodate test distances (d) of 3m and 10m. Refer to the test data tables for the actual measurement distance.

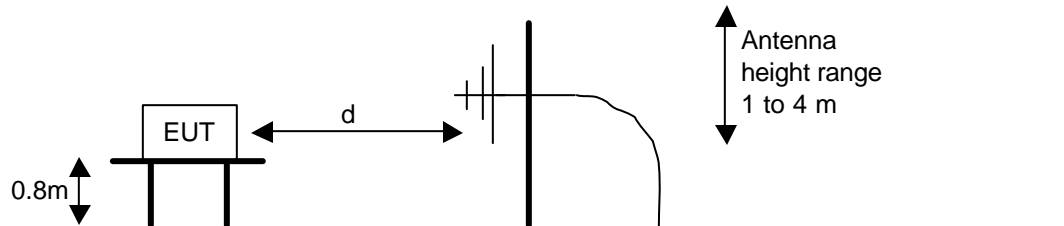

Test Configuration for Radiated Field Strength Measurements
OATS- Plan and Side Views

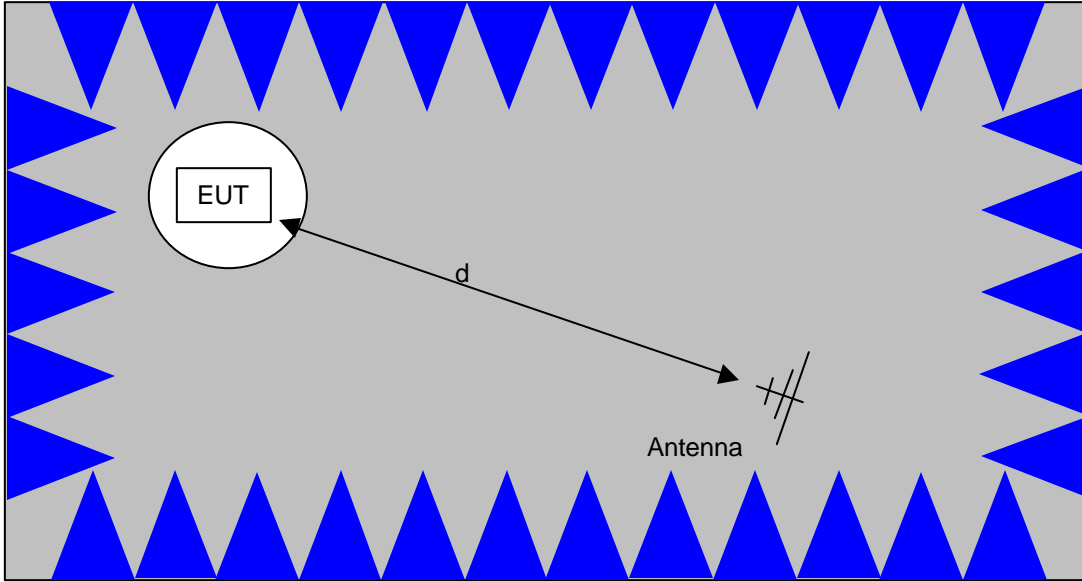

The anechoic materials on the walls and ceiling ensure compliance with the normalized site attenuation requirements of CISPR 16 / CISPR 22 / ANSI C63.4 for an alternate test site at the measurement distances used.

Floor-standing equipment is placed on the floor with insulating supports between the unit and the ground plane.

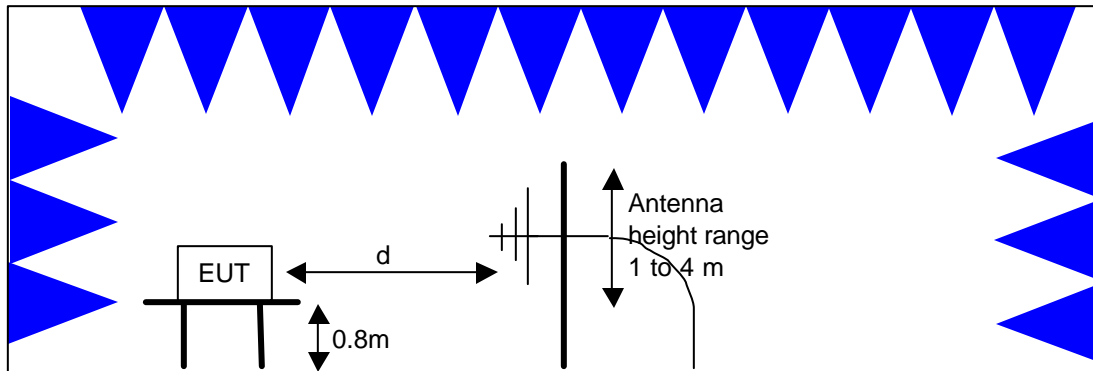

Test Configuration for Radiated Field Strength Measurements
Semi-Anechoic Chamber, Plan and Side Views

CONDUCTED EMISSIONS FROM ANTENNA PORT

Direct measurements of power, bandwidth and power spectral density are performed with the antenna port of the EUT connected to either the power meter or spectrum analyzer via a suitable attenuator and/or filter. These are used to ensure that the front end of the measurement instrument is not overloaded by the fundamental transmission.

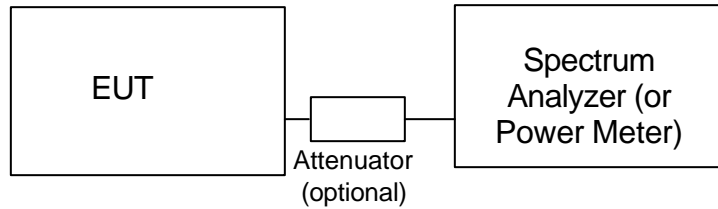

Test Configuration for Antenna Port Measurements

Measurement bandwidths (video and resolution) are set in accordance with the relevant standards and Elliott's test procedures for the type of radio being tested.

If a power meter is used to make output power measurements the sensor head type (peak or average) is stated in the test data table.

SPECIFICATION LIMITS AND SAMPLE CALCULATIONS

The limits for conducted emissions are given in units of microvolts, and the limits for radiated emissions are given in units of microvolts per meter at a specified test distance. Data is measured in the logarithmic form of decibels relative to one microvolt, or dB microvolts (dBuV). For radiated emissions, the measured data is converted to the field strength at the antenna in dB microvolts per meter (dBuV/m). The results are then converted to the linear forms of uV and uV/m for comparison to published specifications.

For reference, converting the specification limits from linear to decibel form is accomplished by taking the base ten logarithm, then multiplying by 20. These limits in both linear and logarithmic form are as follows:

CONDUCTED EMISSIONS SPECIFICATION LIMITS: FCC 15.207; FCC 15.107(a), RSS GEN

The table below shows the limits for the emissions on the AC power line from an intentional radiator and a receiver.

Frequency (MHz)	Average Limit (dBuV)	Quasi Peak Limit (dBuV)
0.150 to 0.500	Linear decrease on logarithmic frequency axis between 56.0 and 46.0	Linear decrease on logarithmic frequency axis between 66.0 and 56.0
0.500 to 5.000	46.0	56.0
5.000 to 30.000	50.0	60.0

GENERAL RADIATED EMISSIONS SPECIFICATION LIMITS

The table below shows the limits for the spurious emissions from transmitters that fall in restricted bands¹ (with the exception of transmitters operating under FCC Part 15 Subpart D) and the limits for all emissions for a low power device operating under the general rules of RSS 210, FCC Part 15 Subpart C.

Frequency Range (MHz)	Limit (uV/m)	Limit (dBuV/m @ 3m)
0.009-0.490	2400/F _{KHz} @ 300m	67.6-20*log ₁₀ (F _{KHz}) @ 300m
0.490-1.705	24000/F _{KHz} @ 30m	87.6-20*log ₁₀ (F _{KHz}) @ 30m
1.705 to 30	30 @ 30m	29.5 @ 30m
30 to 88	100 @ 3m	40 @ 3m
88 to 216	150 @ 3m	43.5 @ 3m
216 to 960	200 @ 3m	46.0 @ 3m
Above 960	500 @ 3m	54.0 @ 3m

RECEIVER SPURIOUS EMISSIONS SPECIFICATION LIMITS

The table below shows the limits for emissions from the receiver as detailed in FCC Part 15.109, RSS 210 table 2, RSS GEN table 1.

Frequency Range (MHz)	Limit (uV/m @ 3m)	Limit (dBuV/m @ 3m)
30 to 88	100	40
88 to 216	150	43.5
216 to 960	200	46.0
Above 960	500	54.0

¹ The restricted bands are detailed in FCC 15.203, RSS 210 Table 1 and RSS 310 Table 2

OUTPUT POWER LIMITS – DIGITAL TRANSMISSION SYSTEMS

The table below shows the limits for output power and output power density. Where the signal bandwidth is less than 20 MHz the maximum output power is reduced to the power spectral density limit plus 10 times the log of the bandwidth (in MHz).

Operating Frequency (MHz)	Output Power	Power Spectral Density
902 – 928	1 Watt (30 dBm)	8 dBm/3kHz
2400 – 2483.5	1 Watt (30 dBm)	8 dBm/3kHz
5725 – 5850	1 Watt (30 dBm)	8 dBm/3kHz

The maximum permitted output power is reduced by 1dB for every dB the antenna gain exceeds 6dBi. Fixed point-to-point applications using the 5725 – 5850 MHz band are not subject to this restriction.

TRANSMIT MODE SPURIOUS RADIATED EMISSIONS LIMITS – FHSS and DTS SYSTEMS

The limits for unwanted (spurious) emissions from the transmitter falling in the restricted bands are those specified in the general limits sections of FCC Part 15 and RSS 210. All other unwanted (spurious) emissions shall be at least 20dB below the level of the highest in-band signal level (30dB if the power is measured using the sample detector/power averaging method).

SAMPLE CALCULATIONS - CONDUCTED EMISSIONS

Receiver readings are compared directly to the conducted emissions specification limit (decibel form) as follows:

$$R_T - S = M$$

where:

R_T = Receiver Reading in dBuV

S = Specification Limit in dBuV

M = Margin to Specification in +/- dB

SAMPLE CALCULATIONS - RADIATED EMISSIONS

Receiver readings are compared directly to the specification limit (decibel form). The receiver internally corrects for cable loss, preamplifier gain, and antenna factor. The calculations are in the reverse direction of the actual signal flow, thus cable loss is added and the amplifier gain is subtracted. The Antenna Factor converts the voltage at the antenna coaxial connector to the field strength at the antenna elements.

A distance factor, when used for electric field measurements above 30MHz, is calculated by using the following formula:

$$F_d = 20 * \text{LOG}_{10} (D_m/D_s)$$

where:

$$F_d = \text{Distance Factor in dB}$$

$$D_m = \text{Measurement Distance in meters}$$

$$D_s = \text{Specification Distance in meters}$$

For electric field measurements below 30MHz the extrapolation factor is either determined by making measurements at multiple distances or a theoretical value is calculated using the formula:

$$F_d = 40 * \text{LOG}_{10} (D_m/D_s)$$

Measurement Distance is the distance at which the measurements were taken and Specification Distance is the distance at which the specification limits are based. The antenna factor converts the voltage at the antenna coaxial connector to the field strength at the antenna elements.

The margin of a given emission peak relative to the limit is calculated as follows:

$$R_c = R_r + F_d$$

and

$$M = R_c - L_s$$

where:

$$R_r = \text{Receiver Reading in dBuV/m}$$

$$F_d = \text{Distance Factor in dB}$$

$$R_c = \text{Corrected Reading in dBuV/m}$$

$$L_s = \text{Specification Limit in dBuV/m}$$

$$M = \text{Margin in dB Relative to Spec}$$

SAMPLE CALCULATIONS - FIELD STRENGTH TO EIRP CONVERSION

Where the radiated electric field strength is expressed in terms of the equivalent isotropic radiated power (eirp), or where a field strength measurement of output power is made in lieu of a direct measurement, the following formula is used to convert between eirp and field strength at a distance of 3m from the equipment under test:

$$E = \frac{1000000 \sqrt{30 P}}{3} \quad \text{microvolts per meter}$$

where P is the eirp (Watts)

EXHIBIT 1: Test Equipment Calibration Data

1 Page

Engineer: Mehran Birgani

<u>Manufacturer</u>	<u>Description</u>	<u>Model #</u>	<u>Asset #</u>	<u>Cal Due</u>
EMCO	Log Periodic Antenna, 0.2-2 GHz	3148	1321	30-Mar-07
Rohde & Schwarz	Test Receiver, 0.009-2750 MHz	ESN	1332	23-May-06
Hewlett Packard	EMC Spectrum Analyzer 9kHz - 40 GHz, Fremont (SA40)	8564E (84125C)	1393	26-Oct-05
EMCO	Horn antenna, D. Ridge 1-18GHz (SA40 system antenna)30Hz sunnyvale	3115	1142	11-Jun-06
Hewlett Packard	Microwave EMI test system head (includes W1 - W4, Asset 1143 and 1144)	84125C	1145	07-Sep-06
EMCO	Horn antenna, 18-26.5 GHz (SA40 30Hz)	3160-09 (84125C)	1150	12-Sep-06
Hewlett Packard	High Pass filter, 3.5GHz	P/N 84300-80038	1157	28-Apr-06

Radiated Emissions, 23-Nov-05

Engineer: Mehran Birgani

<u>Manufacturer</u>	<u>Description</u>	<u>Model #</u>	<u>Asset #</u>	<u>Cal Due</u>
Narda West	High Pass Filter 4.0 GHz,	HXF370	247	16-May-06
Hewlett Packard	Microwave Preamplifier, 1-26.5GHz	8449B	785	26-Apr-06
EMCO	Horn Antenna, D. Ridge 1-18GHz	3115	1242	19-Oct-06
Hewlett Packard	EMC Spectrum Analyzer, 9KHz - 22GHz	8593EM	1319	28-Mar-06

Conducted Emissions - AC Power Ports, 23-Nov-05

Engineer: Mehran Birgani

<u>Manufacturer</u>	<u>Description</u>	<u>Model #</u>	<u>Asset #</u>	<u>Cal Due</u>
Rohde& Schwarz	Pulse Limiter	ESH3 Z2	812	11-Feb-06
Fischer Custom Comm.	LISN, Freq. 0.9 -30 MHz,16 Amp	FCC-LISN-50/250-16-2	1079	07-Jul-06
Rohde & Schwarz	Test Receiver, 9kHz-2750MHz	ESCS 30	1337	12-Jan-06

EXHIBIT 2: Test Measurement Data

22 Pages



EMC Test Data

Client:	Horizon Hobby, Inc.	Job Number:	J61984
Model:	X1TXN Spedtrum DSM X1 module	Test-Log Number:	T61985
		Project Manager:	Ezther Zhu
Contact:	Paul Beard		
Emissions Spec:	FCC 15.247	Class:	-
Immunity Spec:	-	Environment:	-

EMC Test Data

For The

Horizon Hobby, Inc.

Model

X1TXN Spedtrum DSM X1 module

Date of Last Test: 11/23/2005



EMC Test Data

Client:	Horizon Hobby, Inc.	Job Number:	J61984
Model:	X1TXN Spedtrum DSM X1 module	Test-Log Number:	T61985
		Project Manager:	Ezther Zhu
Contact:	Paul Beard		
Emissions Spec:	FCC 15.247	Class:	-
Immunity Spec:	-	Environment:	-

EUT INFORMATION

General Description

The EUT is a 2.4GHz DSSS transceiver module which is designed for model control and telemetry. The EUT was mounted into a test fixture and the fixture was treated as table-top equipment during testing. The electrical rating of the module is 9.6V DC 300mA.

Equipment Under Test

Manufacturer	Model	Description	Serial Number	FCC ID
Horizon Hobby	X1TXN	2.4GHz DSSS	PFB101005	BRWDAMTX10

EUT Antenna (Intentional Radiators Only)

The EUT antenna is a 2dBi Folded dipole.

The antenna connects to the EUT via a non-standard micro-coax, thereby meeting the requirements of FCC 15.203.

EUT Enclosure

The EUT does not have an enclosure as it is designed to be installed within the enclosure of a host device.

Modification History

Mod. #	Test	Date	Modification
1	-	-	None

Modifications applied are assumed to be used on subsequent tests unless otherwise stated as a further modification.



EMC Test Data

Client:	Horizon Hobby, Inc.	Job Number:	J61984
Model:	X1TXN Spedtrum DSM X1 module	T-Log Number:	T61985
Contact:	Paul Beard	Project Manager:	Ezther Zhu
Emissions Spec:	FCC 15.247	Class:	-
Immunity Spec:	-	Environment:	-

Test Configuration #1

Local Support Equipment

Manufacturer	Model	Description	Serial Number	FCC ID
JR	XP9303	9# RC Unit	1953706	N/A
SPEKTRUM	SPM7101	AC-DC Adapter	-	N/A

The JR RC unit was used as a test fixture to provide the module with power and control signals during testing. AC adapter used for conducted emissions measurements. An external battery pack was used for radiated emissions.

Remote Support Equipment

Manufacturer	Model	Description	Serial Number	FCC ID
None				

Interface Cabling and Ports

Port	Connected To	Cable(s)		
		Description	Shielded or Unshielded	Length(m)
None				

EUT Operation During Emissions Tests

The X1TXM module was configured to continuously transmit on a single channel (top, center or bottom) for transmit-mode tests. For receive mode tests the device was configured to continuously receive on the center channel.



EMC Test Data

Client:	Horizon Hobby, Inc.	Job Number:	J61984
Model:	X1TXN Spedtrum DSM X1 module	T-Log Number:	T61985
		Account Manager:	Ezther Zhu
Contact:	Paul Beard		
Spec:	FCC 15.247	Class:	-

Radiated Emissions - Receive Mode

Test Specifics

Objective: The objective of this test session is to perform final qualification testing of the EUT with respect to the specification listed above.

Date of Test: 10/10/2005

Config. Used: 1

Test Engineer: Mehran Birgani

Config Change: None

Test Location: SVOATS #2

EUT Voltage: Battery

General Test Configuration

The EUT was located on the turntable for radiated emissions testing.

The test distance and extrapolation factor (if used) are detailed under each run description.

Note, **preliminary** testing indicates that the emissions were maximized by orientation of the EUT and elevation of the measurement antenna. **Maximized** testing indicated that the emissions were maximized by orientation of the EUT, elevation of the measurement antenna, and manipulation of the EUT's interface cables.

Note, for testing above 1 GHz, the FCC specifies the limit as an average measurement. In addition, the FCC states that the peak reading of any emission above 1 GHz, can not exceed the average limit by more than 20 dB.

Ambient Conditions: Temperature: 26 °C
 Rel. Humidity: 47 %

Summary of Results

Run #	Test Performed	Limit	Result	Margin
1	RE, 30 -8000 MHz	15.209	Pass	30.6dBµ V/m @ 798.828MHz (-15.4dB)

Modifications Made During Testing:

No modifications were made to the EUT during testing

Deviations From The Standard

No deviations were made from the requirements of the standard.



EMC Test Data

Client:	Horizon Hobby, Inc.	Job Number:	J61984
Model:	X1TXN Spedtrum DSM X1 module	T-Log Number:	T61985
		Account Manager:	Ezther Zhu
Contact:	Paul Beard		
Spec:	FCC 15.247	Class:	-

Run #1: Preliminary Radiated Emissions, 30-8000 MHz

Frequency	Level	Pol	15.209 / RSS 210		Detector	Azimuth	Height	Comments
			Limit	Margin				
MHz	dB μ V/m	V/H			Pk/QP/Avg	degrees	meters	
798.828	30.6	V	46.0	-15.4	QP	54	1.0	EUT Lay Down
798.828	30.4	H	46.0	-15.6	QP	25	1.0	EUT Standing Up
798.828	29.3	V	46.0	-16.7	QP	160	1.0	EUT Standing Up
1597.589	35.6	V	54.0	-18.4	AVG	361	1.0	EUT Standing Up
798.828	25.4	H	46.0	-20.6	QP	4	1.5	EUT Lay Down
1597.460	29.8	V	54.0	-24.2	AVG	274	1.0	EUT Lay Down
1597.521	28.2	H	54.0	-25.9	AVG	41	1.0	EUT Lay Down
1597.453	26.7	H	54.0	-27.3	AVG	54	1.0	EUT Standing Up
1597.589	41.2	V	74.0	-32.8	PK	361	1.0	EUT Standing Up
1597.460	38.3	V	74.0	-35.7	PK	274	1.0	EUT Lay Down
1597.521	37.1	H	74.0	-36.9	PK	41	1.0	EUT Lay Down
1597.453	36.9	H	74.0	-37.1	PK	54	1.0	EUT Standing Up

Note 1: All harmonics of LO were measured and signal levels were more than 20dBuV/m under the limit.



EMC Test Data

Client:	Horizon Hobby, Inc.	Job Number:	J61984
Model:	X1TXN Spedtrum DSM X1 module	T-Log Number:	T61985
		Account Manager:	Ezther Zhu
Contact:	Paul Beard		
Spec:	FCC 15.247	Class:	-

Conducted Emissions - Power Ports

Test Specifics

Objective: The objective of this test session is to perform final qualification testing of the EUT with respect to the specification listed above.

Date of Test: 11/23/2005

Config. Used: 1

Test Engineer: Mehran Birgani

Config Change: None

Test Location: SVOATS #1

EUT Voltage: 10Vdc

General Test Configuration

The EUT was located on a wooden table, 40 cm from a vertical coupling plane and 80cm from the LISN.

Ambient Conditions:

Temperature: 18 °C

Rel. Humidity: 51 %

Summary of Results

Run #	Test Performed	Limit	Result	Margin
2	CE, AC Power,120V/60Hz	FCC 15.207	Pass	35.6dB μ V @ 0.358MHz (-13.2dB)

Modifications Made During Testing:

No modifications were made to the EUT during testing

Deviations From The Standard

No deviations were made from the requirements of the standard.

Client:	Horizon Hobby, Inc.	Job Number:	J61984
Model:	X1TXN Spedtrum DSM X1 module	T-Log Number:	T61985
Contact:	Paul Beard	Account Manager:	Ezther Zhu
Spec:	FCC 15.247	Class:	-

Run #1: AC Power Port Conducted Emissions, 0.15 - 30MHz, 120V/ 60Hz

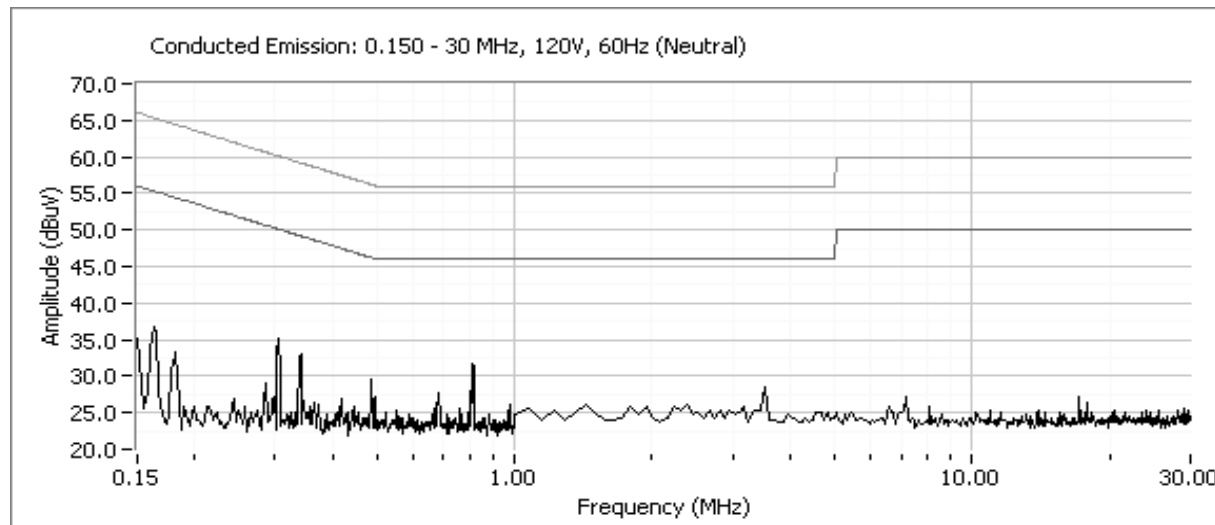
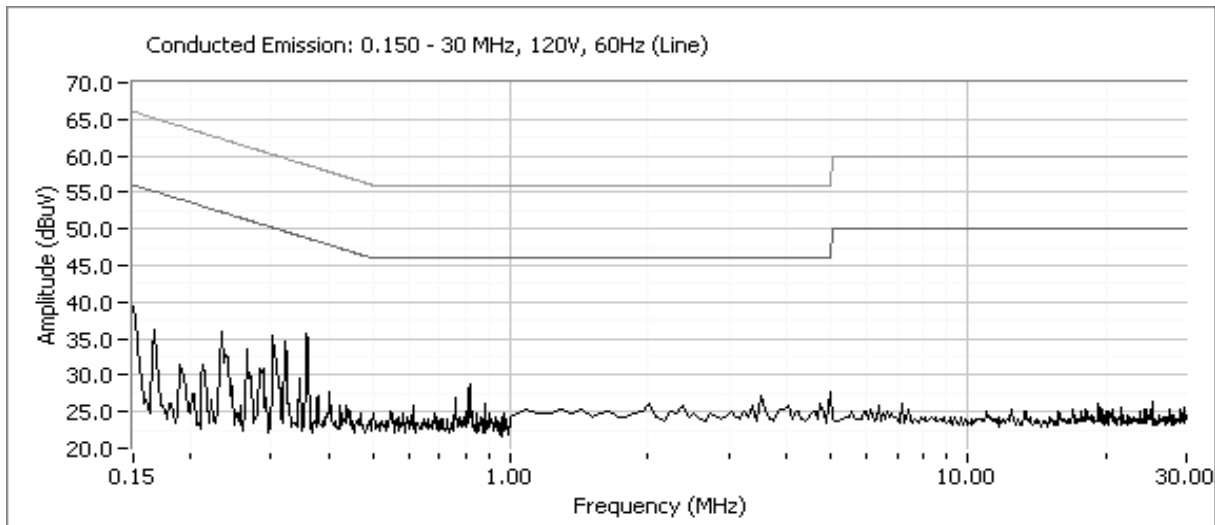



EMC Test Data

Client:	Horizon Hobby, Inc.	Job Number:	J61984
Model:	X1TXN Spedtrum DSM X1 module	T-Log Number:	T61985
		Account Manager:	Ezther Zhu
Contact:	Paul Beard		
Spec:	FCC 15.247	Class:	-

Run #1: AC Power Port Conducted Emissions, 0.15 - 30MHz, 120V/ 60Hz (Data)

Frequency MHz	Level dB μ V	AC Line	FCC 15.207		Detector QP/Ave	Comments
			Limit	Margin		
0.358	35.6	Line	48.8	-13.2	Peak	Peak reading with average limit
0.303	35.3	Line	50.2	-14.8	Peak	Peak reading with average limit
0.305	35.2	Neutral	50.1	-14.9	Peak	Peak reading with average limit
0.341	33.1	Neutral	49.2	-16.1	Peak	Peak reading with average limit
0.235	35.8	Line	52.3	-16.4	Peak	Peak reading with average limit
0.163	36.8	Neutral	55.3	-18.5	Peak	Peak reading with average limit



EMC Test Data

Client:	Horizon Hobby, Inc.	Job Number:	J61984
Model:	X1TXN Spedtrum DSM X1 module	T-Log Number:	T61985
		Account Manager:	Ezther Zhu
Contact:	Paul Beard		
Spec:	FCC 15.247	Class:	N/A

FCC 15.247 DTS - Power, Bandwidth and Spurious Emissions

Test Specifics

Objective: The objective of this test session is to perform final qualification testing of the EUT with respect to the specification listed above.

Date of Test: 11/23/2005	Config. Used: 1
Test Engineer: Mehran Birgani	Config Change: None
Test Location: SVOATS# 1	EUT Voltage: 10Vdc

General Test Configuration

The EUT was located on the turntable for radiated spurious emissions testing.

For radiated emissions testing the measurement antenna was located 3 meters from the EUT.

When measuring the conducted emissions from the EUT's antenna port, the antenna port of the EUT was connected to the spectrum analyzer or power meter via a suitable attenuator to prevent overloading the measurement system. All measurements are corrected to allow for the external attenuators used.

Ambient Conditions:

Temperature:	20 °C
Rel. Humidity:	43 %

Summary of Results

Run #	Test Performed	Limit	Pass / Fail	Result / Margin
1a - c	Radiated Spurious Emissions, 30 - 26,000 MHz	FCC Part 15.209 / 15.247(c)	Pass	53.1dBµV/m (453.9µV/m) @ 4801.9MHz (-0.9dB)
1d	RF Port Spurious Emissions, 30 - 26,000 MHz	FCC Part 15.209 / 15.247(c)	Pass	All emissions <-20dBc
2	6dB Bandwidth	15.247(a)	Pass	>843kHz
3	Output Power	15.247(b)	Pass	21.1
4	Power Spectral Density (PSD)	15.247(d)	Pass	5.29

Modifications Made During Testing:

No modifications were made to the EUT during testing

Deviations From The Standard

No deviations were made from the requirements of the standard.



EMC Test Data

Client:	Horizon Hobby, Inc.	Job Number:	J61984
Model:	X1TXN Spedtrum DSM X1 module	T-Log Number:	T61985
Contact:	Paul Beard	Account Manager:	Ezther Zhu
Spec:	FCC 15.247	Class:	N/A

Run #1a: Radiated Spurious Emissions, 1000 - 25,000 MHz. Low Channel @ 2402 MHz

Fundamental Signal Field Strength: Peak and average values measured in 1 MHz.

Frequency	Level	Pol	15.209 / 15.247		Detector	Azimuth	Height	Comments
MHz	dB μ V/m	V/H	Limit	Margin	Pk/QP/Avg	degrees	meters	
Standing								
2401.648	115.7	V	-	-	PK	63	1.1	RB = VB = 1MHz
2401.648	113.9	V	-	-	AVG	63	1.1	RB = 1MHz, VB = 10Hz
2401.648	106.6	H	-	-	PK	100	1.1	RB = VB = 1MHz
2401.648	104.8	H	-	-	AVG	100	1.1	RB = 1MHz, VB = 10Hz

Delta Marker - Peak	56.81 dB	Delta between highest in-band and highest
Delta Marker - Average	66.82 dB	

Band Edge Signal Field Strength

Frequency	Level	Pol	15.209 / 15.247		Detector	Azimuth	Height	Comments
MHz	dB μ V/m	V/H	Limit	Margin	Pk/QP/Avg	degrees	meters	
2390.000	48.1	V	54.0	-5.9	Avg	63	1.1	
2390.000	58.9	V	74.0	-15.1	Pk	63	1.1	

Note 1: Calculated by subtracting the marker delta values from the fundamental field strength measurements.



EMC Test Data

Client: Horizon Hobby, Inc.	Job Number: J61984
Model: X1TXN Spedtrum DSM X1 module	T-Log Number: T61985
Contact: Paul Beard	Account Manager: Ezther Zhu
Spec: FCC 15.247	Class: N/A

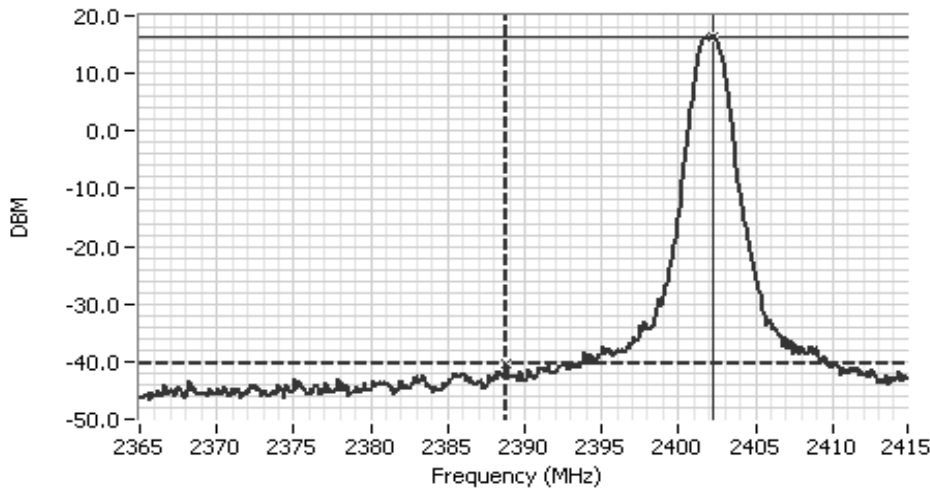

Analyzer Settings
 HP8595EM
 CF: 2390.0 MHz
 SPAN: 50.0 MHz
 RB 1.0 MHz
 VB 1.0 MHz
 Detector POS
 Att 30
 RL Offset 0.80
 Sweep Time 20.0ms
 Ref Lvl: 18.00DBM

Comments

Cursor 1	2388.81	-40.53	
Cursor 2	2402.28	16.28	

Delta Freq. 13.5 MHz
 Delta Amplitude 56.81

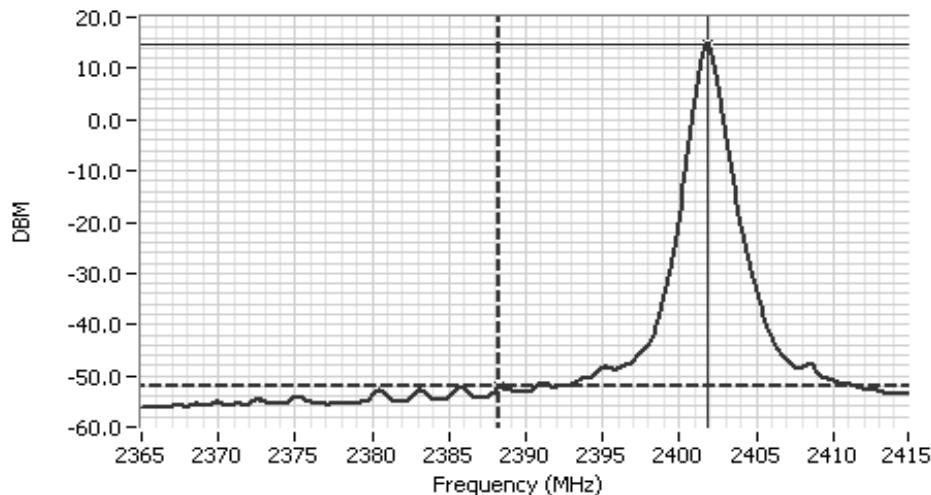

Analyzer Settings
 HP8595EM
 CF: 2390.0 MHz
 SPAN: 50.0 MHz
 RB 1.0 MHz
 VB 10 Hz
 Detector POS
 Att 30
 RL Offset 0.80
 Sweep Time 15.0s
 Ref Lvl: 16.00DBM

Comments

Cursor 1	2388.31	-52.11	
Cursor 2	2401.78	14.71	

Delta Freq. 13.5 MHz
 Delta Amplitude 66.82





EMC Test Data

Client:	Horizon Hobby, Inc.	Job Number:	J61984
Model:	X1TXN Spedtrum DSM X1 module	T-Log Number:	T61985
Contact:	Paul Beard	Account Manager:	Ezther Zhu
Spec:	FCC 15.247	Class:	N/A

Run 1a: Continue (Other Spurious Emissions)

Frequency	Level	Pol	15.209 / 15.247		Detector	Azimuth	Height	Comments
MHz	dB μ V/m	V/H	Limit	Margin	Pk/QP/Avg	degrees	meters	
4801.947	53.1	V	54.0	-0.9	Avg	134	1.0	
4801.550	51.3	H	54.0	-2.7	Avg	60	2.0	
4801.947	58.0	V	74.0	-16.0	Pk	134	1.0	
4801.550	56.4	H	74.0	-17.6	Pk	60	2.0	
7203.905	35.9	H	54.0	-18.1	Avg	53	1.0	Note 2
7203.860	34.9	V	54.0	-19.2	Avg	118	1.0	Note 2
7203.905	45.9	H	74.0	-28.1	Pk	53	1.0	Note 2
7203.860	45.7	V	74.0	-28.3	Pk	118	1.0	Note 2

Note 1: For emissions in restricted bands, the limit of 15.209 was used. For all other emissions, the limit was set 20dB below the level of the fundamental.

Note 2: The signal does not fall in a restricted band, but the more stringent limits of 15.209 were applied.

Run #1b: Radiated Spurious Emissions, 1000 - 25,000 MHz. Center Channel @ 2442 MHz

Other Spurious Emissions

Frequency	Level	Pol	15.209 / 15.247		Detector	Azimuth	Height	Comments
MHz	dB μ V/m	V/H	Limit	Margin	Pk/QP/Avg	degrees	meters	
4881.437	45.5	V	54.0	-8.6	AVG	101	1.0	
4881.707	43.0	H	54.0	-11.0	AVG	52	1.2	
7330.755	34.2	H	54.0	-19.8	AVG	242	1.0	Note 2
7333.425	34.2	V	54.0	-19.9	AVG	185	1.0	Note 2
4881.437	51.6	V	74.0	-22.4	PK	101	1.0	
4881.707	50.0	H	74.0	-24.0	PK	52	1.2	
7330.755	46.1	H	74.0	-27.9	PK	242	1.0	Note 2
7333.425	45.6	V	74.0	-28.4	PK	185	1.0	Note 2

Note 1: For emissions in restricted bands, the limit of 15.209 was used. For all other emissions, the limit was set 20dB below the level of the fundamental.

Note 2: The signal does not fall in a restricted band, but the more stringent limits of 15.209 were applied.



EMC Test Data

Client:	Horizon Hobby, Inc.	Job Number:	J61984
Model:	X1TXN Spedtrum DSM X1 module	T-Log Number:	T61985
Contact:	Paul Beard	Account Manager:	Ezther Zhu
Spec:	FCC 15.247	Class:	N/A

Run #1c: Radiated Spurious Emissions, 1000 - 25,000 MHz. High Channel @ 2477 MHz

Fundamental Signal Field Strength: Peak and average values measured in 1 MHz.

Frequency	Level	Pol	15.209 / 15.247		Detector	Azimuth	Height	Comments
MHz	dB μ V/m	V/H	Limit	Margin	Pk/QP/Avg	degrees	meters	

Standing up

2475.658	119.3	V	-	-	AVG	266	1.0	RB = VB = 1MHz
2475.658	120.8	V	-	-	PK	266	1.0	RB = 1MHz, VB = 10Hz
2475.838	113.3	H	-	-	AVG	183	1.1	RB = VB = 1MHz
2475.838	115.0	H	-	-	PK	183	1.1	RB = 1MHz, VB = 10Hz

Delta Marker - Average	66.3 dB	Delta between highest in-band and highest
Delta Marker - Peak	55.9 dB	

Band Edge Signal Field Strength

Frequency	Level	Pol	15.209 / 15.247		Detector	Azimuth	Height	Comments
MHz	dB μ V/m	V/H	Limit	Margin	Pk/QP/Avg	degrees	meters	
2483.500	53.0	V	54.0	-1.0	Avg	266	1.0	
2483.500	64.9	V	74.0	-9.1	Pk	266	1.0	

Note 1: Calculated by subtracting the marker delta values from the fundamental field strength measurements.

Other Spurious Emissions

Frequency	Level	Pol	15.209 / 15.247		Detector	Azimuth	Height	Comments
MHz	dB μ V/m	V/H	Limit	Margin	Pk/QP/Avg	degrees	meters	
4951.492	43.3	H	54.0	-10.7	AVG	34	1.1	
4951.483	42.4	V	54.0	-11.7	AVG	84	1.0	
7430.343	35.1	H	54.0	-18.9	AVG	305	1.0	
7428.723	35.0	V	54.0	-19.0	AVG	94	1.0	
4951.492	50.3	H	74.0	-23.7	PK	34	1.1	
4951.483	49.5	V	74.0	-24.5	PK	84	1.0	
7430.343	46.5	H	74.0	-27.5	PK	305	1.0	
7428.723	45.9	V	74.0	-28.1	PK	94	1.0	

Note 1: For emissions in restricted bands, the limit of 15.209 was used. For all other emissions, the limit was set 20dB below the level of the fundamental.



EMC Test Data

Client:	Horizon Hobby, Inc.	Job Number:	J61984
Model:	X1TXN Spedtrum DSM X1 module	T-Log Number:	T61985
Contact:	Paul Beard	Account Manager:	Ezther Zhu
Spec:	FCC 15.247	Class:	N/A

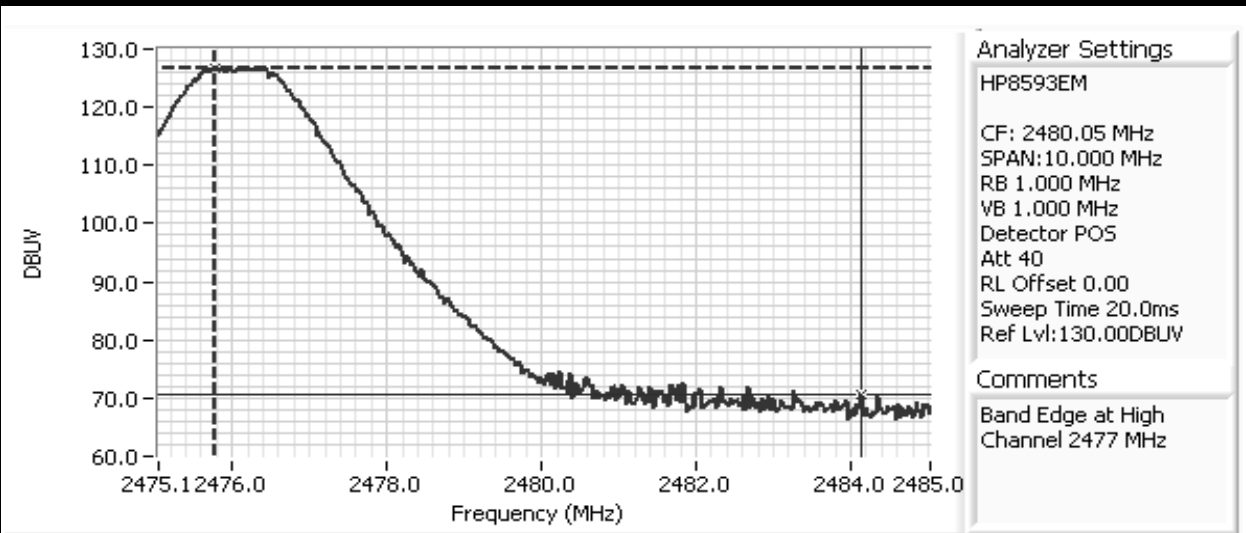

Cursor 1	2475.77	126.56		Delta Freq.	8.354	
Cursor 2	2484.12	70.70		Delta Amplitude	55.86	

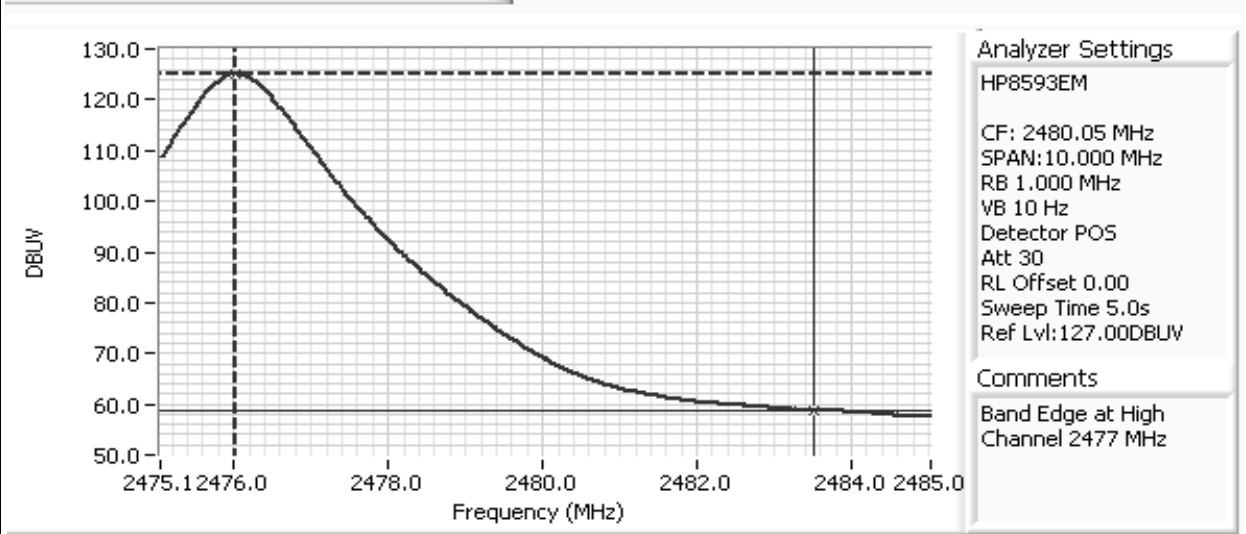

Cursor 1	2476.02	124.97		Delta Freq.	7.481	
Cursor 2	2483.50	58.71		Delta Amplitude	66.26	

Note | Band from 2483.5-2500 MHz was checked and the highest signal signal was found at 2483.5 MHz.



EMC Test Data

Client:	Horizon Hobby, Inc.	Job Number:	J61984
Model:	X1TXN Spedtrum DSM X1 module	T-Log Number:	T61985
Contact:	Paul Beard	Account Manager:	Ezther Zhu
Spec:	FCC 15.247	Class:	N/A

Run #1d: Antenna Conducted Spurious Emissions, 30 - 25,000 MHz.

Refer to plots below. Scans made using RBW=VB=100 KHz with the limit line set at 20dB below the highest in-band signal level.
[Spur at 30MHz in the first plot is actually artifact of 0Hz]

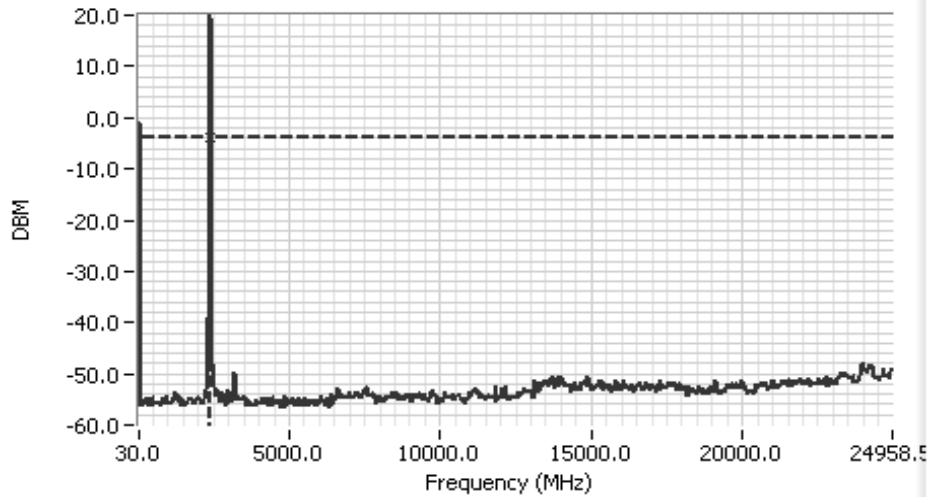

Analyzer Settings
 HP8564E,006,EMI,UK6
 CF: 12515.0 MHz
 SPAN:24970.0 MHz
 RB 100 kHz
 VB 100 kHz
 Detector Normal
 Att 30
 RL Offset 1.00
 Sweep Time 14.0s
 Ref Lvl:20.80DBM

Comments
 Channel @ 2402 MHz

Cursor 1 2398.20: -3.89
 0.000 0.00

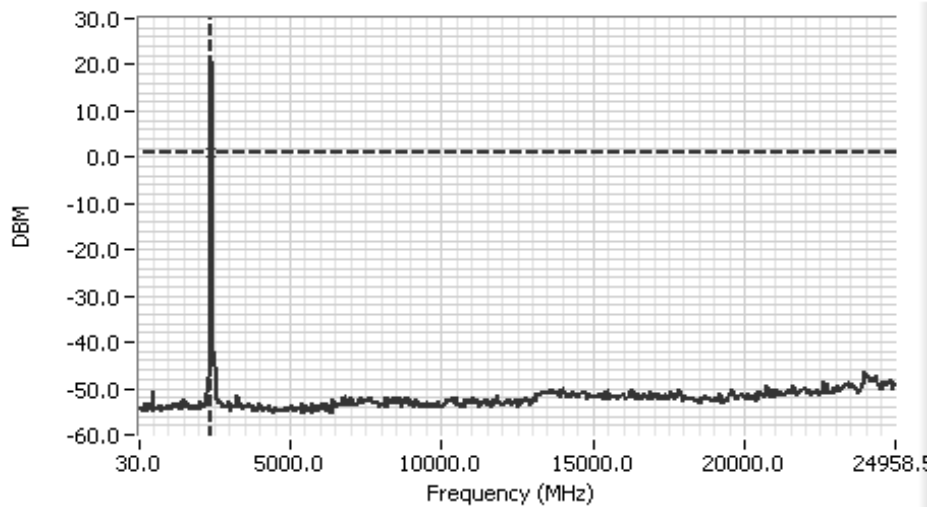

Analyzer Settings
 HP8564E,006,EMI,UK6
 CF: 12515.0 MHz
 SPAN:24970.0 MHz
 RB 100 kHz
 VB 100 kHz
 Detector POS
 Att 30
 RL Offset 1.00
 Sweep Time 14.0s
 Ref Lvl:20.80DBM

Comments
 Channel @ 2442 MHz

Cursor 1 2398.20: 1.00
 0.000 0.00





EMC Test Data

Client:	Horizon Hobby, Inc.	Job Number:	J61984
Model:	X1TXN Spedtrum DSM X1 module	T-Log Number:	T61985
Contact:	Paul Beard	Account Manager:	Ezther Zhu
Spec:	FCC 15.247	Class:	N/A

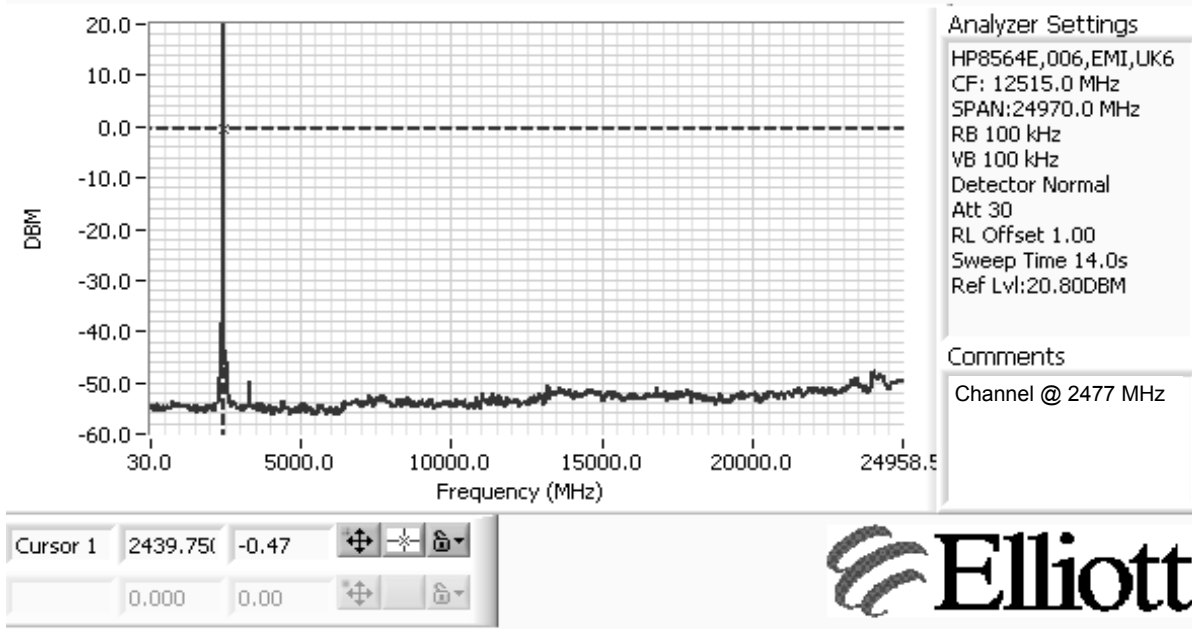

Run #2: Signal Bandwidth

Rate	Frequency (MHz)	Resolution Bandwidth	6dB Signal Bandwidth	99% Signal Bandwidth
64	2402	100kHz	868kHz	1.2 MHz
64	2442	100kHz	858kHz	1.2 MHz
64	2478	100kHz	843kHz	1.2 MHz

99% bandwidth measured on all three channels with RB=100kHz, VB=300kHz, peak detector (no averaging)
 6dB bandwidth measured using RB=100kHz, VB=100kHz, peak detector, no averaging



EMC Test Data

Client: Horizon Hobby, Inc.	Job Number: J61984
Model: X1TXN Spedtrum DSM X1 module	T-Log Number: T61985
Contact: Paul Beard	Account Manager: Ezther Zhu
Spec: FCC 15.247	Class: N/A

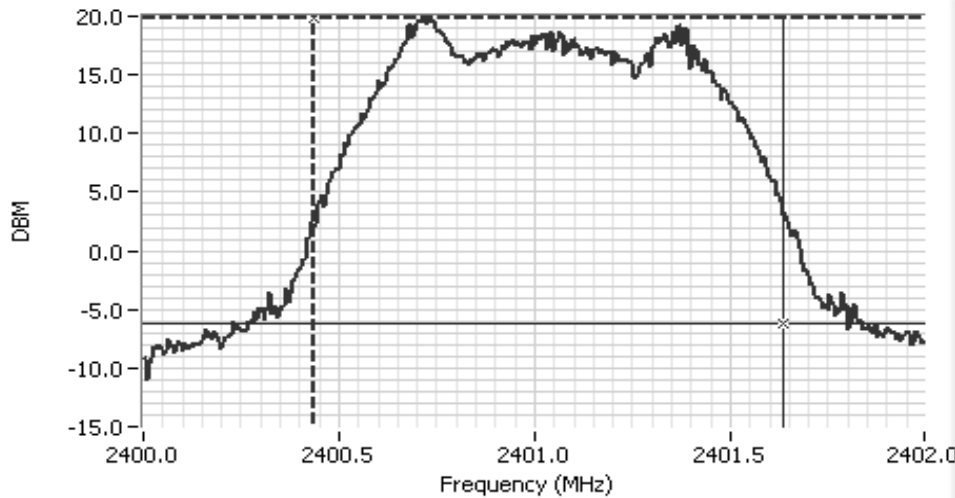

Analyzer Settings
HP8593EM
CF: 2401.00 MHz
SPAN:2.000 MHz
RB 100 kHz
VB 300 kHz
Detector POS
Att 40
RL Offset 0.00
Sweep Time 20.0ms
Ref Lvl:24.00DBM

Comments
99% power bandwidth:
1.200 MHz
Power over span:
28.24dBm

Cursor 1	2400.43	19.80	⊕ ⊖ 🔒
Cursor 2	2401.63	-6.20	⊕ ⊖ 🔒

Delta Freq. 1.200
Delta Amplitude 26.00

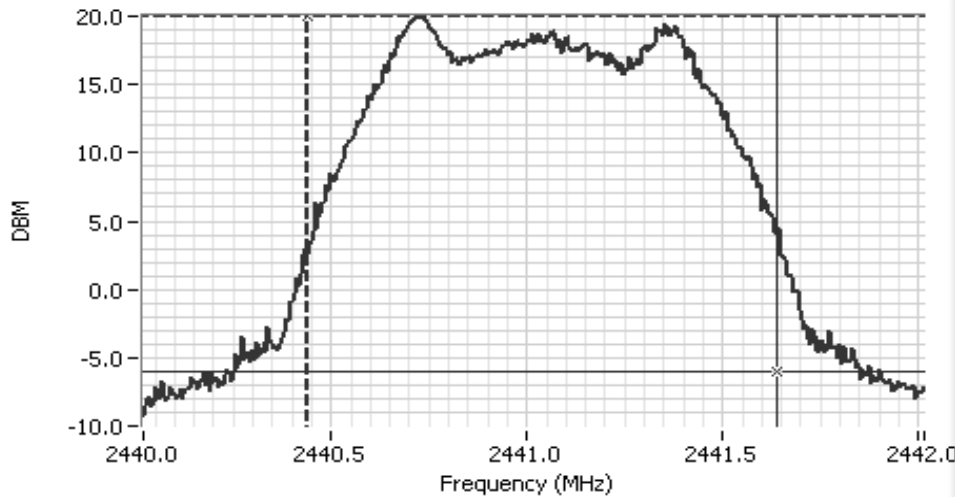

Analyzer Settings
HP8593EM
CF: 2441.02 MHz
SPAN:2.000 MHz
RB 100 kHz
VB 300 kHz
Detector POS
Att 40
RL Offset 0.00
Sweep Time 20.0ms
Ref Lvl:24.00DBM

Comments
99% power bandwidth:
1.200 MHz
Power over span:
28.59dBm

Cursor 1	2440.43	19.94	⊕ ⊖ 🔒
Cursor 2	2441.63	-6.06	⊕ ⊖ 🔒

Delta Freq. 1.200
Delta Amplitude 26.00





EMC Test Data

Client: Horizon Hobby, Inc.	Job Number: J61984
Model: X1TXN Spedtrum DSM X1 module	T-Log Number: T61985
Contact: Paul Beard	Account Manager: Ezhther Zhu
Spec: FCC 15.247	Class: N/A

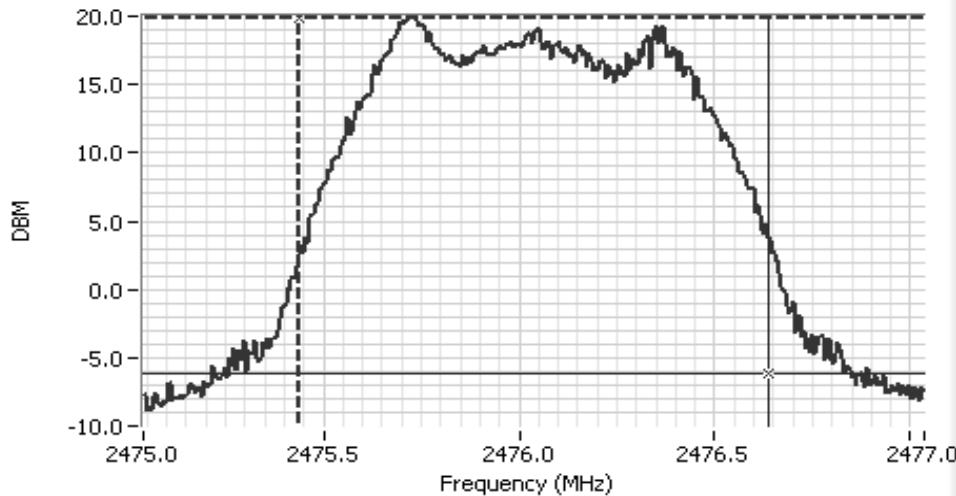

Analyzer Settings
HP8593EM
CF: 2476.04 MHz
SPAN: 2.000 MHz
RB 100 kHz
VB 300 kHz
Detector POS
Att 40
RL Offset 0.00
Sweep Time 20.0ms
Ref Lvl: 24.00DBM

Comments
99% power bandwidth:
1.200 MHz
Power over span:
28.65dBm

Cursor 1	2475.43	19.88	⊕ ⊖ 🔒
Cursor 2	2476.63	-6.12	⊕ ⊖ 🔒

Delta Freq. 1.200
Delta Amplitude 26.00

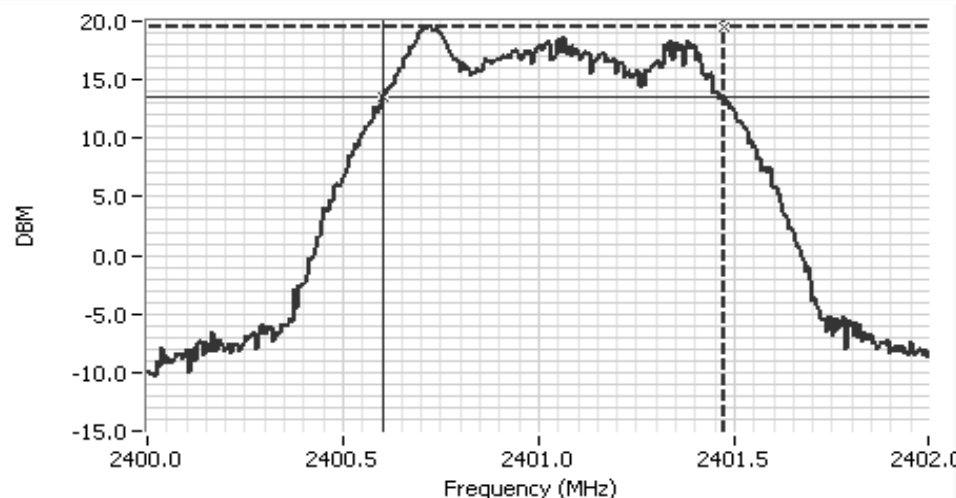

Analyzer Settings
HP8593EM
CF: 2401.00 MHz
SPAN: 2.000 MHz
RB 100 kHz
VB 100 kHz
Detector POS
Att 40
RL Offset 0.00
Sweep Time 20.0ms
Ref Lvl: 24.00DBM

Comments
6dB Bandwidth
Low Channel 2402 MHz

Cursor 1	2401.47	19.52	⊕ ⊖ 🔒
Cursor 2	2400.60	13.52	⊕ ⊖ 🔒

Delta Freq. 868 kHz
Delta Amplitude 6.00





EMC Test Data

Client: Horizon Hobby, Inc.	Job Number: J61984
Model: X1TXN Spedtrum DSM X1 module	T-Log Number: T61985
Contact: Paul Beard	Account Manager: Ezther Zhu
Spec: FCC 15.247	Class: N/A

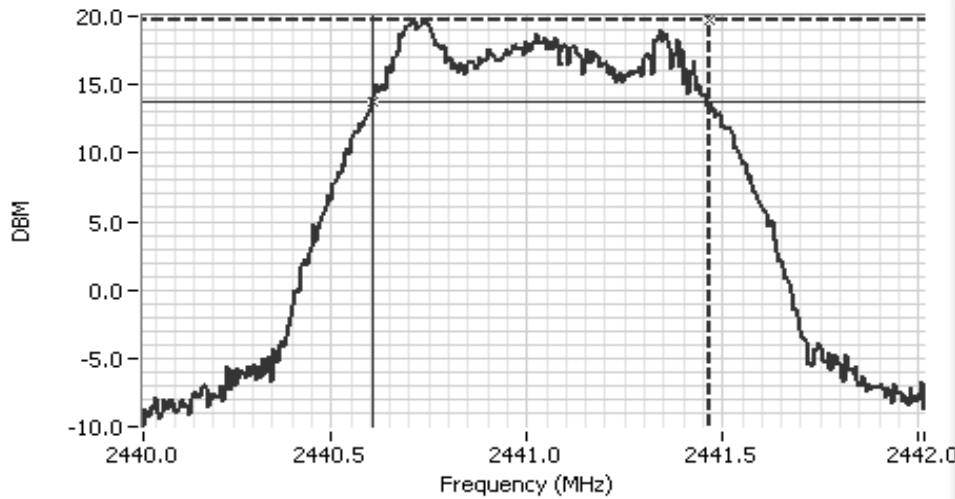

Analyzer Settings
HP8593EM

CF: 2441.02 MHz
SPAN: 2.000 MHz
RB 100 kHz
VB 100 kHz
Detector POS
Att 40
RL Offset 0.00
Sweep Time 20.0ms
Ref Lvl: 24.00DBM

Comments
6dB Bandwidth
Center Channel
2442 MHz

Cursor 1	2441.46	19.69	⊕ ⊖ 🔒
Cursor 2	2440.60	13.69	⊕ ⊖ 🔒

Delta Freq. 858 kHz
Delta Amplitude 6.00

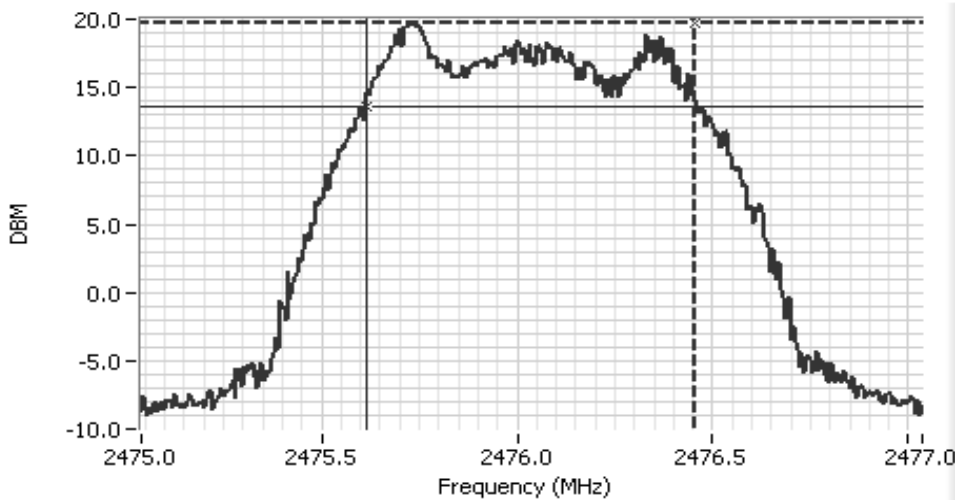

Analyzer Settings
HP8593EM

CF: 2476.04 MHz
SPAN: 2.000 MHz
RB 100 kHz
VB 100 kHz
Detector POS
Att 40
RL Offset 0.00
Sweep Time 20.0ms
Ref Lvl: 24.00DBM

Comments
6dB Bandwidth
High Channel
2477 MHz

Cursor 1	2476.45	19.67	⊕ ⊖ 🔒
Cursor 2	2475.61	13.67	⊕ ⊖ 🔒

Delta Freq. 843 kHz
Delta Amplitude 6.00





EMC Test Data

Client:	Horizon Hobby, Inc.	Job Number:	J61984
Model:	X1TXN Spedtrum DSM X1 module	T-Log Number:	T61985
Contact:	Paul Beard	Account Manager:	Ezther Zhu
Spec:	FCC 15.247	Class:	N/A

Run #3: Output Power

Maximum antenna gain: 2 dBi

Rate	Frequency (MHz)	Res BW MHz	Output Power ^{Note 1}		EIRP W	Average Power ^{Note 2}	
			dBm	W		dBm	W
64	2402	3	21.1	0.128	0.203		
64	2441	3	21.1	0.128	0.203		
64	2477	3	20.9	0.122	0.194		

Note 1: Output power measured using a spectrum analyzer, RB=VB=3MHz

Run #4: Power Spectral Density

Rate	Operating Frequency (MHz)	Freq. @ PPSD	Res BW	P.S.D. (dBm/3kHz)
64	2402	2400.716	3 kHz	4.02
64	2442	2440.725	3 kHz	5.29
64	2477	2475.718	3 kHz	4.08

Note 1: Freq. @ PPSD: Frequency of the Peak Power Spectral Density (PPSD)

Note 2: Power spectral density measured using RB=3 kHz, VB=10kHz with a sweep time set to ensure a dwell time of at least 1 second per 3kHz. The measurement is made at the frequency of PPSD determined from preliminary scans using RB=3kHz using multiple sweeps at a faster rate over the 6dB bandwidth of the signal.



EMC Test Data

Client:	Horizon Hobby, Inc.	Job Number:	J61984
Model:	X1TXN Spedtrum DSM X1 module	T-Log Number:	T61985
Contact:	Paul Beard	Account Manager:	Ezther Zhu
Spec:	FCC 15.247	Class:	N/A

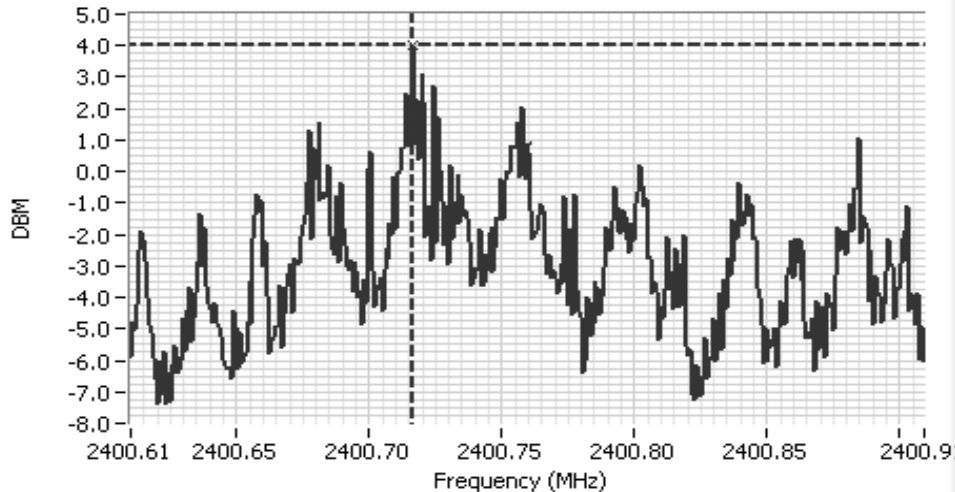

Analyzer Settings
HP8593EM
CF: 2400.76 MHz
SPAN: 300 kHz
RB 3 kHz
VB 10 kHz
Detector POS
Att 30
RL Offset 0.00
Sweep Time 100.0s
Ref Lvl: 15.00DBM

Comments
PSD, Low Channel
2402 MHz

Cursor 1 2400.71 4.02
0.000 0.00

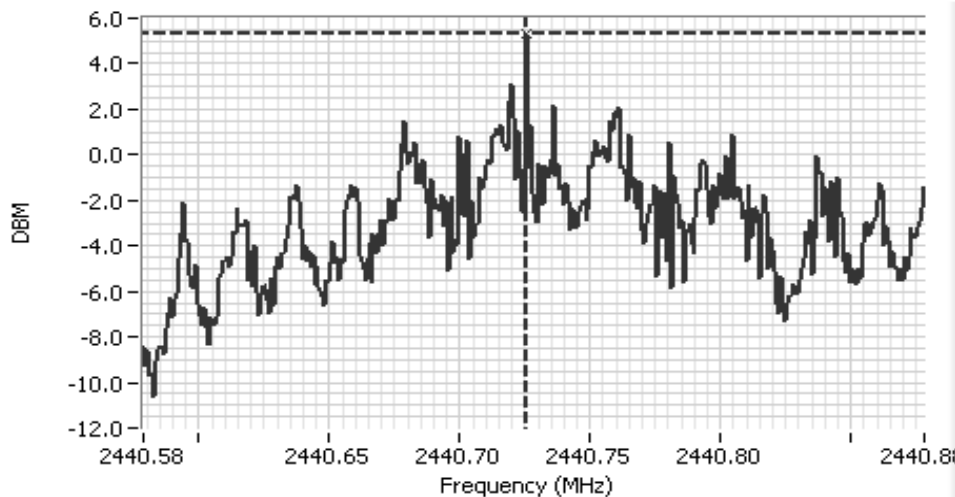

Analyzer Settings
HP8593EM
CF: 2440.73 MHz
SPAN: 300 kHz
RB 3 kHz
VB 10 kHz
Detector POS
Att 30
RL Offset 0.00
Sweep Time 100.0s
Ref Lvl: 15.00DBM

Comments
PSD, Center Channel
2442 MHz

Cursor 1 2440.72 5.29
0.000 0.00





EMC Test Data

Client:	Horizon Hobby, Inc.	Job Number:	J61984
Model:	X1TXN Spedtrum DSM X1 module	T-Log Number:	T61985
Contact:	Paul Beard	Account Manager:	Ezther Zhu
Spec:	FCC 15.247	Class:	N/A

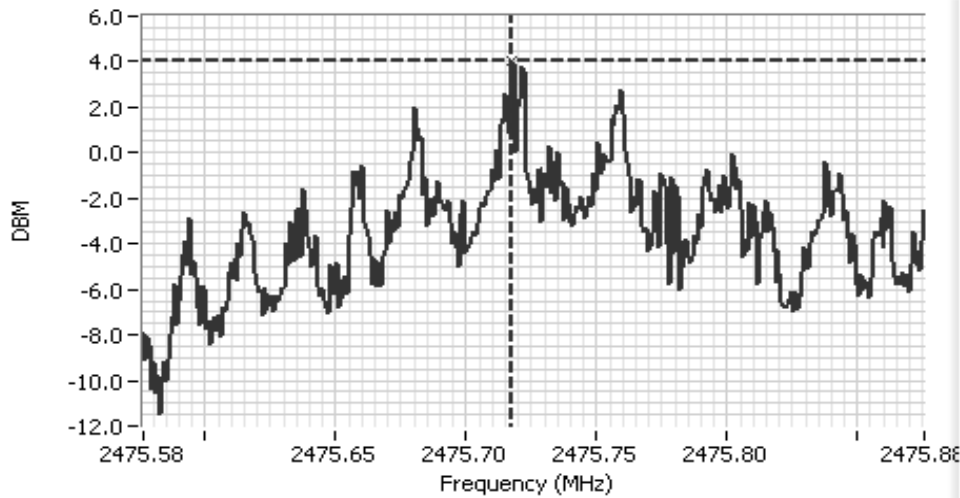

Analyzer Settings

HP8593EM
CF: 2475.73 MHz
SPAN: 300 kHz
RB 3 kHz
VB 10 kHz
Detector POS
Att 40
RL Offset 0.00
Sweep Time 100.0s
Ref Lvl: 23.00DBM

Comments

PSD, High Channel
2477 MHz

Cursor 1	2475.71	4.08	+	*	🔒
	0.000	0.00	+		🔒



EXHIBIT 3: Photographs of Test Configurations

4 Pages

EXHIBIT 4: Proposed FCC ID Label & Label Location

***EXHIBIT 5: Detailed Photographs of
Horizon Hobby, Inc. Model X1TXN Spektrum DSM X1 Construction***

2 Pages

**EXHIBIT 6: Operator's Manual for
Horizon Hobby, Inc. Model X1TXN Spektrum DSM X1**

Pages

**EXHIBIT 7: Block Diagram of
Horizon Hobby, Inc. Model X1TXN Spektrum DSM X1**

Pages

**EXHIBIT 8: Schematic Diagrams for
Horizon Hobby, Inc. Model X1TXN Spektrum DSM X1**

Pages

**EXHIBIT 9: Theory of Operation for
Horizon Hobby, Inc. Model X1TXN Spektrum DSM X1**

Pages

EXHIBIT 10: Modular Approval Requirements

Pages

EXHIBIT 11: RF Exposure Information

Pages