

DIGITAL PROPORTIONAL SYSTEM

2.4GHZ

ATX101

SYSTEM FEATURES

- Unique and functional pistol grip transmitter design
- Well balanced for precise control
- Non-slip foam steering wheel
- Well placed digital trim & D/R levers
- Optimum third channel switch location
- Low Battery warning
- Quick Binding and Fail Safe Setup
- High performance micro 2 channel receiver
- Ni-Cd charger jack in transmitter
- Sound Beep

SYSTEM SPECIFICATIONS

Transmitter

Model: ATX101

FHSS Output Power: <100mW

Operating Voltage: 4.8 or 6V

Power Supply: 4 Cell Alkaline/Ni-Cd/Ni-MH

Weight: 6.03 oz (171g)

Frequency/Modulation Type: 2.4GHz FHSS

Receiver + ESC

Model: MEGA-SRS

Frequency: 2.4GHz FHSS

Operating Voltage: 2s Li - poly or Ni - cd
/Ni - MH 6V ~ 8.4V

Weight: 1.59 oz (45g)

Dimensions: 2.15 x 2 x 0.79 in
(54.5 x 51 x 20 mm)

Receiver

Model: ARX101

Frequency: 2.4GHz FHSS

Operating Voltage: 4.8V ~ 6V

Weight: 0.39 oz (11g)

Dimensions: 1.75 x 1.59 x 0.45 in
(44.5 x 40.5 x 11.5 mm)

FEATURES DESCRIPTIONS

Receiver Antenna Wire: The antenna wire receives the transmitter signal. The antenna wire should be installed through a nylon tube (antenna tube) in the vertical position for the best reception.

Auxiliary Channel 3 Switch: Controls Auxiliary Channel 3 High and Low servo travel.

Battery Compartment: Houses the 4 'AA' Alkaline batteries that power the transmitter.

Bind Button: Used in the process of Binding the transmitter and receiver.

Bind LED: Displays the current status of the transmitter and receiver pair.

Steering Dual Rate (D/R): The Dual Rate knob are used to adjust the Steering Dual Rate quickly and easily during use.

Grip: The Grip is molded in an ergonomic shape for increased comfort, control and feel.

Power Indicator: Indicates that there is Power to the transmitter.

Power Switch: Turns the transmitter ON and OFF.

Steering Trim Knob (CH1): Used to adjust the center Trim of the Steering servo.

Steering Wheel (CH1): Proportionally operates the model's right and left steering control. The Steering Wheel features a molded grip for increased comfort, control and feel.

Throttle Trigger (CH2): Controls the speed of the model, both forward and backward, or the model's brake.

Throttle Trim Knob (CH2): Used to adjust the center Trim of the Throttle servo.

TRANSMITTER AND RECEIVER DIAGRAMS

Use the diagram below to familiarize yourself with the different parts of your **ATX101** transmitter and receiver. Descriptions of these parts can be found in the transmitter and receiver layout.

 The transmitter antenna is mounted internally and is located in the front portion of the transmitter. When you're driving your model, hold the transmitter so that it's orientated as close to vertical as possible at all times and try not to 'follow' your model with the transmitter. This provides the best RF signal between the transmitter and the receiver. Do NOT cover the front of the transmitter in any way during use! Doing so can block the RF signal, resulting in the loss of control of your model.

FRONT

ATX101

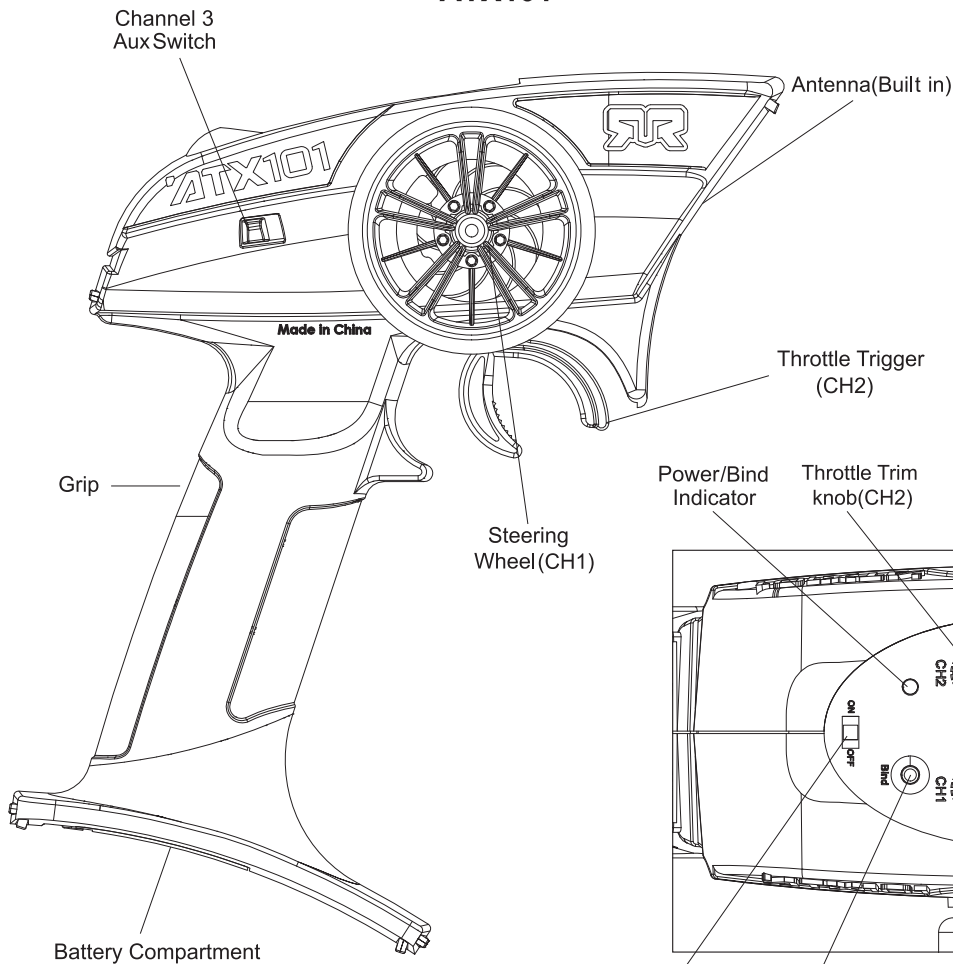

TOP

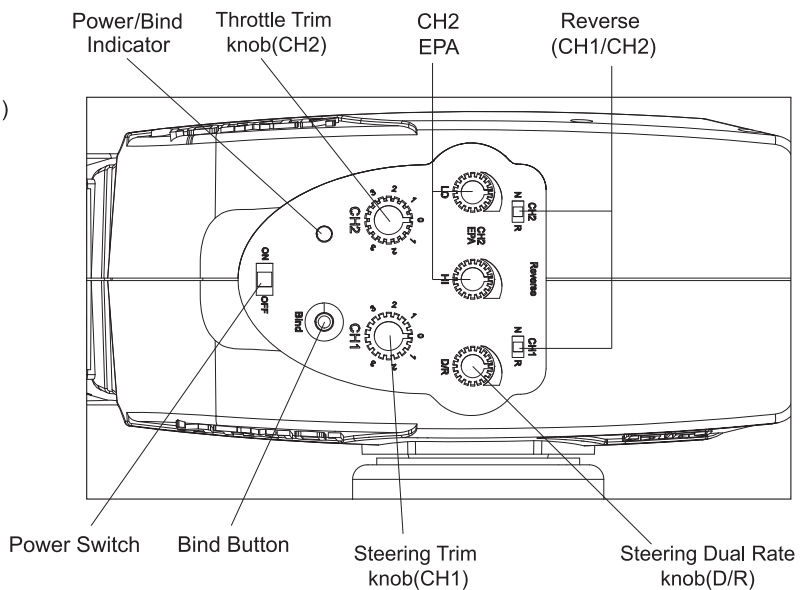

MEGA-SRS

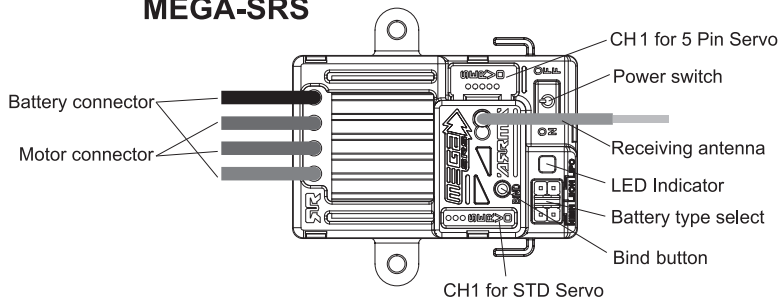

ARX101

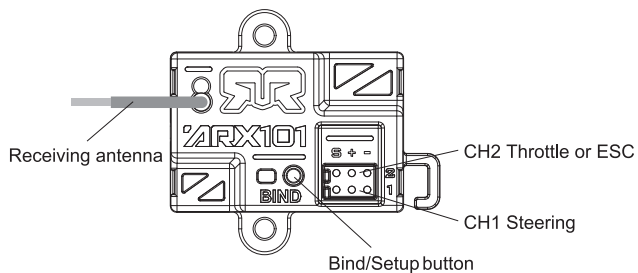

TRANSMITTER BATTERY INSTALLATION

To Open slide cover

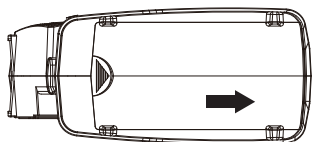

Install Batteries

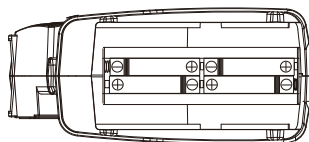

To Close slide cover

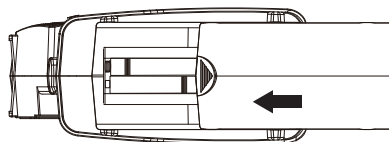

1. Press down on the battery cover and slide in the direction of the arrow to remove.
2. Install 4 AA alkaline cells (or Ni-Cd, or Ni-MH) as indicated inside the battery compartment. Make sure to match the polarity (+ and -) as shown in the battery compartment or the transmitter will not function.

3. Install the battery cover in place and slide to close.

WARNING: Improper installation of transmitter batteries can cause serious damage to your system.

RECEIVER CONNECTIONS AND MOUNTING

Use the diagram below to familiarize yourself with how to connect the switch harness, servos (available separately), and the battery to your receiver.

1) Install fresh batteries into the battery connector, making sure that the polarity is correct.

 The **MEGA-SRS** receiver's Nominal Input Voltage is 6v~8.4v, therefore, the receiver can be powered using a 5 or 7 cell Ni-Cd or Ni-MH battery pack (available separately) or 2s Li-poly battery.

- We suggest Binding the transmitter and receiver, prior to mounting the receiver in your model.
- The receiver should be mounted as far away from any electrical components as possible.
- Route the antenna wire up through a plastic tube so that it is in the vertical position.

 Set your model on a stand so the wheels are off the ground before turning on your radio control system or connecting your motor for the first time.

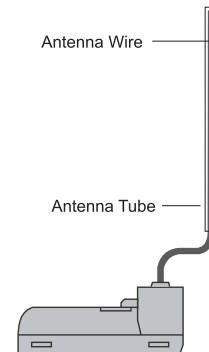

RECEIVER'S ANTENNA INSTALLATION

The wave length of the 2.4GHz is much shorter than that of the conventional frequencies, it is very susceptible to loss of signal which results in a receiving error.

To obtain the best results, please refer to the following instructions;

1. The antenna must be kept as straight as possible. Otherwise it will reduce the effective range.

2. The antenna should be perpendicular to the model. Larger models can have large metal objects that can attenuate the RF signal. In this case the antennas should be placed at sides of the model. Then the best RF signal condition is obtained at any attitude.

3. The antennas must be kept away from conductive materials, such as metal and carbon by at least a half inch. The coaxial part of the antennas does not need to follow these guidelines, but do not bend it in a small radius.

4. Keep the antennas away from the motor, ESC, and other noise so

*The main purpose of the photo demonstrates how the antenna should be placed.

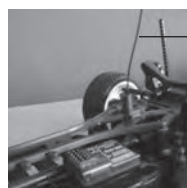
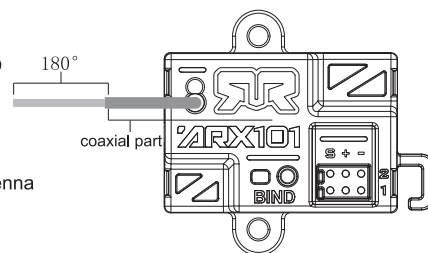
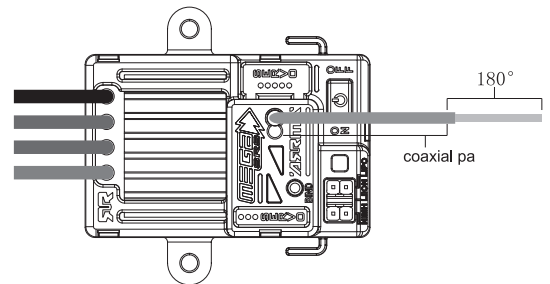

FAIL SAFE SETUP (ARX101 only)

Please note the setup must be based on pair procedure well.

1. Turn the power switch on the transmitter & receiver to the ON position, the LED on transmitter & receiver are continuously lit.
2. Move the steering wheel or throttle trigger to the position where you want the servo to move, press and hold the receiver setup button for 2 second until the red LED on the receiver flash slowly, then press and hold the receiver setup button again within 5 seconds (Note: after 5 seconds F/S setup will reset, you have to start over at step one above) until the receiver LED is continuously lit, that's mean the F/S function has been correctly set.
3. Verify if the failsafe function has been correctly set. Turn off the transmitter, then check if the servos moves to the position that you set.
4. Any new binding (pair procedure) will clear the preset Fail-Safe.

STEERING TRIM(CH1)

Steering neutral adjustments can be made by rotating the steering trim knob to the CW or C.CW. When you install a servo, always check to be sure the servo is at its neutral position. Adjust the servo horn position and linkage so both are parallel. Be sure the steering trim on the transmitter is at the neutral position.

Trim Operation And Maximum Travel

Changing the trim can affect the overall settings. When adjustments are made with the trims, recheck your installation for maximum travel. (Steering D/R at 100%)

When Trim Usage Is Extreme

If it takes most of your trim movement to get a servo to the neutral position, reposition the servo horn on the servo and inspect your linkage installation.

Steering Trim Knob

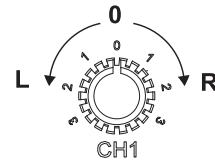

THROTTLE TRIM(CH2)

Throttle neutral adjustments can be made by rotating the throttle trim knob to the CW or C.CW. When using an electronic speed control, set the throttle trim to neutral and make adjustment to the speed control. On a gas powered model, set the trim to neutral and adjust the linkage to the point where the carburetor is fully closed in accordance with the engine instruction manual.

Trim Operation And Travel

Trim adjustments will affect the overall servo travel. Check the brake side (backward) movement when changes are made.

When Trim Movement Is Extreme

If you use most of the trim movement to get the servo to the neutral position, recenter the servo horn closer to the neutral position and inspect your throttle linkage.

Throttle Trim Knob

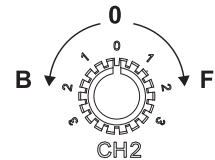

STEERING DUAL RATES(D/R-CH1)

Use this function to adjust the steering travel of your model. If the model understeers while cornering, add steering by rotating the CW side of the D/R knob. When the model oversteers, take away steering by rotating the C.CW of the D/R knob.

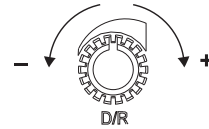

THROTTLE END POINT ADJUSTMENT(EPA-CH2)

This function is used to adjust the forward and brake side servo travel. Each direction can be adjusted independent of each other. Use this feature to set the throttle servo travel.

 Be sure that your throttle linkage does not apply excessive force to the servo. If your linkage installation causes an unreasonable amount of force to be applied to the servo, the servo may be damaged and result in loss of control.

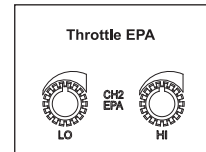



TRANSMITTER AND RECEIVER BINDING

The Binding function allows you to Bind the transmitter and receiver pair. When new, it is necessary to pair the transmitter and receiver to prevent interference from radio controllers operated by other users. This operation is referred to as 'binding'. Once the binding process is complete, the setting is remembered even when the transmitter and receiver are turned OFF. Therefore, this procedure usually only needs to be done once.

 Before beginning the binding process, connect the switch harness, servos, and the receiver battery to your receiver, using the diagram on page 5. Make sure that both the transmitter and the receiver are turned OFF.

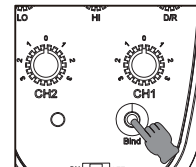
- 1) Turn the transmitter ON. The Power Indicator on the transmitter will illuminate solid red.
- 2) Press and hold the receiver setup button, then turn the power switch on the ON position. The receiver LED will flash quickly. Release the setup button after 1 second.
- 3) Press and hold the binding button on the transmitter for 1 second until the LED on the receiver is continuously lit.



 When the binding process is successful, the Bind LED on the receiver will stay solid red when both the transmitter and receiver are turned ON. If the Bind LED on the receiver is flashing rapidly or not illuminated at all, the transmitter and receiver are not paired. In this case, turn both the transmitter and receiver OFF, then repeat the binding process.

 Under some circumstances, the receiver may not operate after turning the transmitter and receiver ON. If this occurs, perform the binding process again.



FCC Statement

Any Changes or modifications not expressly approved by the party responsible for compliance could void the user's authority to operate the equipment.

This device complies with part 15 of the FCC Rules. Operation is subject to the following two conditions:

- (1) This device may not cause harmful interference, and
- (2) This device must accept any interference received, including interference that may cause undesired operation.

FCC Radiation Exposure Statement:

This equipment complies with FCC radiation exposure limits set forth for an uncontrolled environment, this device has been evaluated to meet general RF exposure requirement. The device can be used in portable exposure condition without restriction. The distance close to the finger usually should be 15mm.

ISED RSS Warning/ISED RF Exposure Statement

ISED RSS Warning: This device complies with Innovation, Science and Economic Development Canada licence-exempt RSS standard(s). Operation is subject to the following two conditions: (1) this device may not cause interference, and (2) this device must accept any interference, including interference that may cause undesired operation of the device.

Le présent appareil est conforme aux CNR d'ISED applicables aux appareils radio exempts de licence. L'exploitation est autorisée aux deux conditions suivantes: (1) l'appareil ne doit pas produire de brouillage, et (2) l'utilisateur de l'appareil doit accepter tout brouillage radioélectrique subi, même si le brouillage est susceptible d'en compromettre le fonctionnement.

ISED RF exposure statement:

Cet équipement est conforme aux limites d'exposition aux rayonnements spécifiées par ISED pour les environnements non contrôlés et a été évalué pour satisfaire aux exigences générales en matière d'exposition aux radiofréquences. L'appareil peut être utilisé sans restriction dans des conditions d'exposition portatives. La distance entre les doigts doit normalement être de 15 mm.