



MEASUREMENT REPORT

FCC PART 15 Subpart C Bluetooth

FCC ID: BRWAR9130T
IC: 6157A-AR9130T
APPLICANT: Horizon Hobby, LLC

Application Type: Certification
Product: PowerSafe Receiver
Model No.: SPMAR12310T
Brand Name: Spektrum
FCC Classification: FCC Part 15 Spread Spectrum Transmitter(DSS)
FCC Rule Part(s): Part15 Subpart C (Section 15.247)
IC Rule: RSS-247 Issue 2, RSS-Gen Issue 5
Test Procedure(s): ANSI C63.10-2013
Test Date: September 06 ~ 18, 2019

Reviewed By: 
(Sunny Sun)

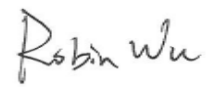
Approved By: 
(Robin Wu)



The test results relate only to the samples tested.

This equipment has been shown to be capable of compliance with the applicable technical standards as indicated in the measurement report and was tested in accordance with the measurement procedures specified in ANSI C63.10-2013. Test results reported herein relate only to the item(s) tested.

The test report shall not be reproduced except in full without the written approval of MRT Technology (Suzhou) Co., Ltd.

Revision History

Report No.	Version	Description	Issue Date	Note
1909RSU008-U1	Rev. 01	Initial Report	11-12-2019	Valid

Note: This report is prepared for FCC Class II permissive change and supplement to CTS Original “CGZ3161221-02440-EFI” report. We reassessed the output power, radiated spurious emission and band edge again.

CONTENTS

Description	Page
1. INTRODUCTION	6
1.1. Scope	6
1.2. MRT Test Location	6
2. PRODUCT INFORMATION.....	7
2.1. Equipment Description	7
2.2. Operation Frequency and Channel List.....	7
2.3. Test Configuration	7
2.4. EMI Suppression Device(s)/Modifications.....	8
2.5. Labeling Requirements	8
3. DESCRIPTION of TEST.....	9
3.1. Evaluation Procedure	9
3.2. AC Line Conducted Emissions.....	9
3.3. Radiated Emissions.....	10
4. ANTENNA REQUIREMENTS	11
5. TEST EQUIPMENT CALIBRATION DATE	12
6. MEASUREMENT UNCERTAINTY	14
7. TEST RESULT	15
7.1. Summary	15
7.2. Output Power Measurement	16
7.2.1. Test Limit	16
7.2.2. Test Procedure Used.....	16
7.2.3. Test Setting.....	16
7.2.4. Test Setup	17
7.2.5. Test Result.....	18
7.3. Radiated Spurious Emission Measurement	19
7.3.1. Test Limit	19
7.3.2. Test Procedure Used.....	19
7.3.3. Test Setting.....	19
7.3.4. Test Setup	20
7.3.5. Test Result.....	22
7.4. Radiated Restricted Band Edge Measurement	30
7.4.1. Test Procedure Used.....	33
7.4.2. Test Setting.....	33

7.4.3.	Test Setup	34
7.4.4.	Test Result.....	35
7.5.	AC Conducted Emissions Measurement.....	51
7.5.1.	Test Limit	51
7.5.2.	Test Setup	51
7.5.3.	Test Result.....	51
8.	CONCLUSION.....	52
	Appendix A - Test Setup Photograph.....	53
	Appendix B - EUT Photograph	54

§2.1033 General Information

Applicant:	Horizon Hobby, LLC
Applicant Address:	2904 Research Rd., Champaign IL 61822
Manufacturer:	Horizon Hobby, LLC
Manufacturer Address:	2904 Research Rd., Champaign IL 61822
Test Site:	MRT Technology (Suzhou) Co., Ltd
Test Site Address:	D8 Building, No.2 Tian'edang Rd., Wuzhong Economic Development Zone, Suzhou, China

Test Facility / Accreditations

Measurements were performed at MRT Laboratory located in Tian'edang Rd., Suzhou, China.

- MRT facility is a FCC registered (MRT Reg. No. 893164) test facility with the site description report on file and has met all the requirements specified in ANSI C63.4-2014.
- MRT facility is an IC registered (MRT Reg. No. 11384A-1) test laboratory with the site description on file at Industry Canada.
- MRT facility is a VCCI registered (R-20025, G-20034, C-20020, T-20020) test laboratory with the site description on file at VCCI Council.
- MRT Lab is accredited to ISO 17025 by the American Association for Laboratory Accreditation (A2LA) under the American Association for Laboratory Accreditation Program (A2LA Cert. No. 3628.01) in EMC, Telecommunications, Radio and SAR testing.



1. INTRODUCTION

1.1. Scope

Measurement and determination of electromagnetic emissions (EMC) of radio frequency devices including intentional and/or unintentional radiators for compliance with the technical rules and regulations of the Federal Communications Commission and the Innovation, Science and Economic Development Canada and Certification and Engineering Bureau.

1.2. MRT Test Location

The map below shows the location of the MRT LABORATORY, its proximity to the Taihu Lake. These measurement tests were conducted at the MRT Technology (Suzhou) Co., Ltd. Facility located at D8 Building, No.2 Tian'edang Rd., Wuzhong Economic Development Zone, Suzhou, China. The measurement facility compliant with the test site requirements specified in ANSI C63.4-2014.



2. PRODUCT INFORMATION

2.1. Equipment Description

Product Name:	PowerSafe Receiver
Model No.:	SPMAR12310T
Brand Name:	Spektrum
Operation Frequency:	2404MHz ~ 2476MHz
Modulation Technology:	FHSS
Channel Number:	23
Antenna Gain:	Ant 1: 1.5dBi Ant 2: 1.5dBi

Note: Two antennas cannot be simultaneously transmitted.

2.2. Operation Frequency and Channel List

Example of a 23 pseudo-random hopping frequency list:

Channel	Frequency	Channel	Frequency
00	2404 MHz	12	2442 MHz
01	2412 MHz	13	2446 MHz
02	2411 MHz	14	2450 MHz
03	2414 MHz	15	2452 MHz
04	2417 MHz	16	2456 MHz
05	2420 MHz	17	2459 MHz
06	2424 MHz	18	2463 MHz
07	2427 MHz	19	2466 MHz
08	2430 MHz	20	2469 MHz
09	2433 MHz	21	2473 MHz
10	2437 MHz	22	2476 MHz
11	2440 MHz	--	--

2.3. Test Configuration

The unit was tested per the guidance of ANSI C63.10-2013. ANSI C63.10-2013 was used to reference the appropriate EUT setup for radiated spurious emissions testing and AC line conducted testing.

2.4. EMI Suppression Device(s)/Modifications

No EMI suppression device(s) were added and/or no modifications were made during testing.

2.5. Labeling Requirements

Per 2.1074 & 15.19; Docket 95-19

The label shall be permanently affixed at a conspicuous location on the device; instruction manual or pamphlet supplied to the user and be readily visible to the purchaser at the time of purchase.

However, when the device is so small wherein placement of the label with specified statement is not practical, only the FCC ID must be displayed on the device per Section 15.19(a)(5). Please see attachment for FCC ID label and label location.

RSS-Gen Issue 5 Section 4

In addition to complying with the applicable RSSs and RSP-100, each unit of a product model (i.e. of a radio apparatus) shall meet the labelling requirements set out in this section prior to being marketed in Canada or imported into Canada.

For information regarding the labelling option, see Section 4.1, 4.2, 4.3 4.4. The label for the certified product represents the manufacturer's or importer's compliance with Innovation, Science and Economic Development Canada's (ISED) regulatory requirements.

Please see attachment for IC label and label location.

3. DESCRIPTION of TEST

3.1. Evaluation Procedure

The measurement procedures described in the American National Standard for Testing Unlicensed Wireless Devices (ANSI C63.10-2013), and the Filing was used in the measurement of the EUT.

Deviation from measurement procedure.....None

3.2. AC Line Conducted Emissions

The line-conducted facility is located inside an 8'x4'x4' shielded enclosure. A 1m x 2m wooden table 80cm high is placed 40cm away from the vertical wall and 80cm away from the sidewall of the shielded room. Two 10kHz-30MHz, 50Ω/50uH Line-Impedance Stabilization Networks (LISNs) are bonded to the shielded room floor. Power to the LISNs is filtered by external high-current high-insertion loss power line filters. These filters attenuate ambient signal noise from entering the measurement lines. These filters are also bonded to the shielded enclosure.

The EUT is powered from one LISN and the support equipment is powered from the second LISN. All interconnecting cables more than 1 meter were shortened to a 1 meter length by non-inductive bundling (serpentine fashion) and draped over the back edge of the test table. All cables were at least 40cm above the horizontal reference ground-plane. Power cables for support equipment were routed down to the second LISN while ensuring that that cables were not draped over the second LISN.

Sufficient time for the EUT, support equipment, and test equipment was allowed in order for them to warm up to their normal operating condition. The RF output of the LISN was connected to the receiver and exploratory measurements were made to determine the frequencies producing the maximum emission from the EUT. The receiver was scanned from 150kHz to 30MHz. The detector function was set to peak mode for exploratory measurements while the bandwidth of the analyzer was set to 9kHz. The EUT, support equipment, and interconnecting cables were arranged and manipulated to maximize each emission. Each emission was also maximized by varying: power lines, the mode of operation or data exchange speed, or support equipment whichever determined the worst-case emission. Once the worst case emissions have been identified, the one EUT cable configuration/arrangement and mode of operation that produced these emissions were used for final measurements on the same test site. The analyzer is set to CISPR quasi-peak and average detectors with a 9kHz resolution bandwidth for final measurements.

An extension cord was used to connect to a single LISN which powered by EUT. The extension cord was calibrated with LISN, the impedance and insertion loss are compliance with the requirements as stated in ANSI C63.10-2013.

3.3. Radiated Emissions

The radiated test facilities consisted of an indoor 3 meter semi-anechoic chamber used for final measurements and exploratory measurements, when necessary. The measurement area is contained within the semi-anechoic chamber which is shielded from any ambient interference. For measurements above 1GHz absorbers are arranged on the floor between the turn table and the antenna mast in such a way so as to maximize the reduction of reflections. For measurements below 1GHz, the absorbers are removed. An MF Model 210SS turntable is used for radiated measurement. It is a continuously rotatable, remote controlled, metallic turntable and 2 meters (6.56 ft.) in diameter. The turn table is flush with the raised floor of the chamber in order to maintain its function as a ground plane. An 80cm high PVC support structure is placed on top of the turntable.

For all measurements, the spectrum was scanned through all EUT azimuths and from 1 to 4 meter receive antenna height using a broadband antenna from 30MHz up to the upper frequency shown in 15.33(b)(1) depending on the highest frequency generated or used in the device or on which the device operates or tunes. For frequencies above 1GHz, linearly polarized double ridge horn antennas were used. For frequencies below 30MHz, a calibrated loop antenna was used. When exploratory measurements were necessary, they were performed at 1 meter test distance inside the semi-anechoic chamber using broadband antennas, broadband amplifiers, and spectrum analyzers to determine the frequencies and modes producing the maximum emissions. Sufficient time for the EUT, support equipment, and test equipment was allowed in order for them to warm up to their normal operating condition. The test set-up for frequencies below 1GHz was placed on top of the 0.8 meter high, 1 x 1.5 meter table; and test set-up for frequencies 1-40GHz was placed on top of the 1.5 meter high, 1 x 1.5 meter table. The EUT, support equipment, and interconnecting cables were arranged and manipulated to maximize each emission. Appropriate precaution was taken to ensure that all emissions from the EUT were maximized and investigated. The system configuration, clock speed, mode of operation or video resolution, if applicable, turntable azimuth, and receive antenna height was noted for each frequency found.

Final measurements were made in the semi-anechoic chamber using calibrated, linearly polarized broadband and horn antennas. The test setup was configured to the setup that produced the worst case emissions. The spectrum analyzer was set to investigate all frequencies required for testing to compare the highest radiated disturbances with respect to the specified limits. The turntable containing the EUT was rotated through 360 degrees and the height of the receive antenna was varied 1 to 4 meters and stopped at the azimuth and height producing the maximum emission. Each emission was maximized by changing the orientation of the EUT through three orthogonal planes and changing the polarity of the receive antenna, whichever produced the worst-case emissions. According to 3dB Beamwidth of horn antenna, the horn antenna should be always directed to the EUT when rising height.

4. ANTENNA REQUIREMENTS

Excerpt from §15.203 of the FCC Rules/Regulations:

“An intentional radiator antenna shall be designed to ensure that no antenna other than that furnished by the responsible party can be used with the device. The use of a permanently attached antenna or of an antenna that uses a unique coupling to the intentional radiator shall be considered sufficient to comply with the provisions of this section.”

Conclusion:

The unit complies with the requirement of §15.203.

5. TEST EQUIPMENT CALIBRATION DATE

Conducted Emissions - SR2

Instrument	Manufacturer	Type No.	Asset No.	Cali. Interval	Cali. Due Date
EMI Test Receiver	R&S	ESR3	MRTSUE06185	1 year	2020/04/15
Two-Line V-Network	R&S	ENV 216	MRTSUE06002	1 year	2020/06/13
Two-Line V-Network	R&S	ENV 216	MRTSUE06003	1 year	2020/06/13
Thermohygrometer	Testo	608-H1	MRTSUE06404	1 year	2020/08/08
Shielding Room	MIX-BEP	Chamber-SR2	MRTSUE06215	N/A	N/A

Radiated Emissions - AC1

Instrument	Manufacturer	Type No.	Asset No.	Cali. Interval	Cali. Due Date
EMI Test Receiver	R&S	ESR7	MRTSUE06001	1 year	2020/08/01
PXA Signal Analyzer	Keysight	9030B	MRTSUE06395	1 year	2020/09/03
Loop Antenna	Schwarzbeck	FMZB 1519	MRTSUE06025	1 year	2020/11/10
Bilog Period Antenna	Schwarzbeck	VULB 9168	MRTSUE06172	1 year	2020/03/31
Broad Band Horn Antenna	Schwarzbeck	BBHA 9120D	MRTSUE06023	1 year	2020/10/13
Broad Band Horn Antenna	Schwarzbeck	BBHA 9170	MRTSUE06024	1 year	2019/12/17
Microwave System Amplifier	Agilent	83017A	MRTSUE06076	1 year	2019/11/16
Preamplifier	Schwarzbeck	BBV 9721	MRTSUE06121	1 year	2020/06/11
Thermohygrometer	Testo	608-H1	MRTSUE06403	1 year	2020/08/08
Anechoic Chamber	TDK	Chamber-AC1	MRTSUE06212	1 year	2020/04/30

Radiated Emission - AC2

Instrument	Manufacturer	Type No.	Asset No.	Cali. Interval	Cali. Due Date
Spectrum Analyzer	Keysight	N9038A	MRTSUE06125	1 year	2020/08/01
Loop Antenna	Schwarzbeck	FMZB 1519	MRTSUE06025	1 year	2020/11/10
Bilog Period Antenna	Schwarzbeck	VULB 9162	MRTSUE06022	1 year	2020/10/13
Horn Antenna	Schwarzbeck	BBHA9120D	MRTSUE06171	1 year	2020/10/27
Broad Band Horn Antenna	Schwarzbeck	BBHA 9170	MRTSUE06024	1 year	2019/12/17
Broadband Coaxial Preamplifier	Schwarzbeck	BBV 9718	MRTSUE06176	1 year	2019/11/16
Preamplifier	Schwarzbeck	BBV 9721	MRTSUE06121	1 year	2020/06/11
Temperature/Humidity Meter	Minggao	ETH529	MRTSUE06170	1 year	2019/12/13
Anechoic Chamber	RIKEN	Chamber-AC2	MRTSUE06213	1 year	2020/04/30

Conducted Test Equipment - TR3

Instrument	Manufacturer	Type No.	Asset No.	Cali. Interval	Cali. Due Date
EXA Signal Analyzer	Agilent	N9020A	MRTSUE06106	1 year	2020/04/15
EXA Signal Analyzer	Keysight	N9010B	MRTSUE06452	1 year	2020/07/11
Signal Analyzer	R&S	FSV40	MRTSUE06218	1 year	2020/04/15
Power Meter	Agilent	U2021XA	MRTSUE06030	1 year	2019/11/16
USB wideband power sensor	Keysight	U2021XA	MRTSUE06446	1 year	2020/06/30
USB wideband power sensor	Keysight	U2021XA	MRTSUE06447	1 year	2020/06/30
Bluetooth Test Set	Anritsu	MT8852B-042	MRTSUE06389	1 year	2020/06/13
Audio Analyzer	Agilent	U8903B	MRTSUE06143	1 year	2020/06/13
Modulation Analyzer	HP	8901A	MRTSUE06098	1 year	2020/10/10
Wideband Radio Communication Tester	R&S	CMW 500	MRTSUE06243	1 year	2020/11/07
DC Power Supply	GWINSTEK	DPS-3303C	MRTSUE06064	N/A	N/A
Temperature & Humidity Chamber	BAOYT	BYH-150CL	MRTSUE06051	1 year	2019/11/16
Thermohygrometer	testo	608-H1	MRTSUE06401	1 year	2020/08/08

Software	Version	Function
EMI Software	V3	EMI Test Software

6. MEASUREMENT UNCERTAINTY

Where relevant, the following test uncertainty levels have been estimated for tests performed on the EUT as specified in CISPR 16-4-2. This uncertainty represents an expanded uncertainty expressed at approximately the 95% confidence level using a coverage factor of $k = 2$.

AC Conducted Emission Measurement - SR2	
Measuring Uncertainty for a Level of Confidence of 95% ($U=2Uc(y)$):	
150kHz~30MHz: 3.46dB	
Radiated Emission Measurement - AC1	
Measuring Uncertainty for a Level of Confidence of 95% ($U=2Uc(y)$):	
Horizontal: 30MHz~300MHz: 4.07dB	
300MHz~1GHz: 3.63dB	
1GHz~18GHz: 4.16dB	
Vertical: 30MHz~300MHz: 4.18dB	
300MHz~1GHz: 3.60dB	
1GHz~18GHz: 4.76dB	
Radiated Emission Measurement - AC2	
Measuring Uncertainty for a Level of Confidence of 95% ($U=2Uc(y)$):	
Horizontal: 30MHz~300MHz: 3.75dB	
300MHz~1GHz: 3.53dB	
1GHz~18GHz: 4.28dB	
Vertical: 30MHz~300MHz: 3.86dB	
300MHz~1GHz: 3.53dB	
1GHz~18GHz: 4.33dB	

7. TEST RESULT

7.1. Summary

FCC Part Section(s)	ISED Section(s)	Test Description	Test Limit	Test Condition	Test Result	Reference
15.247(b)(1)	RSS-247 [5.4(b)]	Output Power	<0.125 Watt	Conducted	Pass	Section 7.2
15.205, 15.209	RSS-247 [5.5]	General Field Strength Limits (Restricted Bands and Radiated Emission Limits)	Emissions in restricted bands must meet the radiated limits detailed in 15.209	Radiated	Pass	Section 7.3 Section 7.4
15.207	RSS-Gen [8.8]	AC Conducted Emissions 150kHz - 30MHz	< FCC 15.207 limits >	N/A	Pass	Section 7.5

Notes:

- 1) The analyzer plots shown in this section were all taken with a correction table loaded into the analyzer. The correction table was used to account for the losses of the cables and attenuators used as part of the system to connect the EUT to the analyzer at all frequencies of interest.
- 2) All modes of operation and data rates were investigated. For radiated emission test, every axis (X, Y, Z) was also verified. The test results shown in the following sections represent the worst case emissions.
- 3) "N/A" means that the test item is not applicable, and the detailed information refers to relevant section.

7.2. Output Power Measurement

7.2.1. Test Limit

For frequency hopping systems operating in the 2400-2483.5MHz band employing at least 75 non-overlapping hopping channels: 1 watt. For all other frequency hopping systems in the 2400-2483.5MHz band: 0.125 watt.

The E.I.R.P shall not exceed 4 Watt (36dBm).

7.2.2. Test Procedure Used

ANSI C63.10 - Section 11.9.1.3

ANSI C63.10 - Section 11.9.2.3.2

7.2.3. Test Setting

PKPM1 Peak power meter method

The maximum peak conducted output power may be measured using a broadband peak RF power meter. The power meter shall have a video bandwidth that is greater than or equal to the DTS bandwidth and shall use a fast-responding diode detector.

Method AVGPM-G

Method AVGPM-G is a measurement using a gated RF average power meter.

Alternatively, measurements may be performed using a wideband gated RF power meter provided that the gate parameters are adjusted such that the power is measured only when the EUT is transmitting at its maximum power control level. Because the measurement is made only during the ON time of the transmitter, no duty cycle correction factor is required.

7.2.4. Test Setup

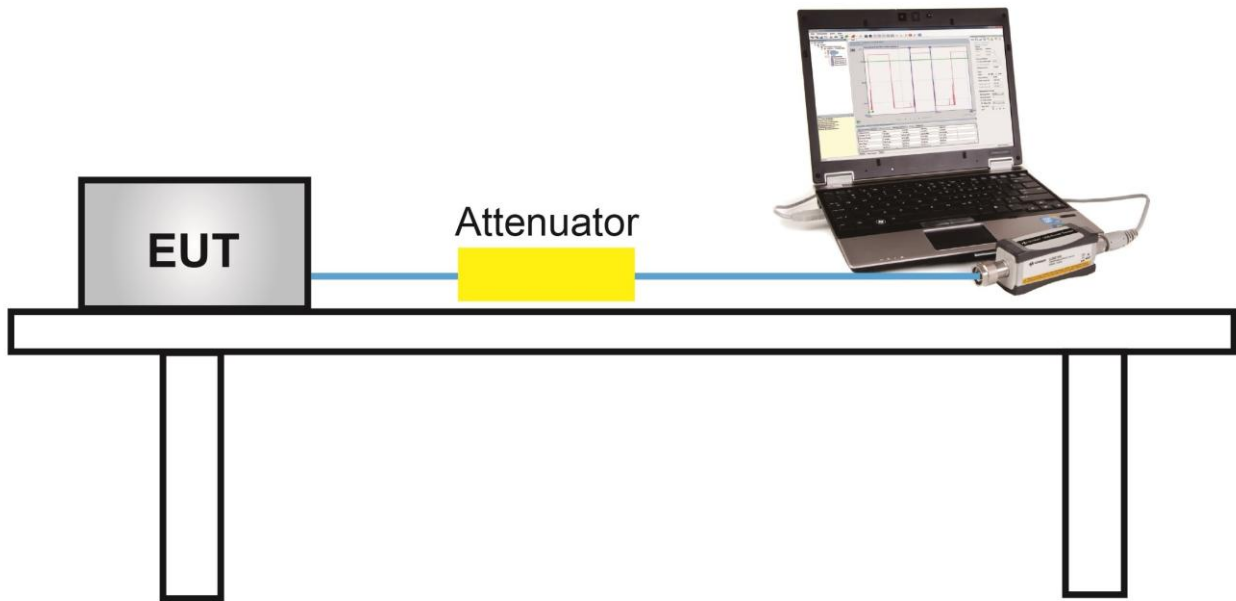

7.2.5. Test Result

Product	PowerSafe Receiver	Temperature	25°C
Test Engineer	Dandy Li	Relative Humidity	52%
Test Site	TR3	Test Date	2019/09/12

Freq. (MHz)	Average Power (dBm)		Limit (dBm)	E.I.R.P (dBm)		E.I.R.P Limit (dBm)	Result
	Ant 1	Ant 2		Ant 1	Ant 2		
2404	12.62	12.78	≤ 21.00	14.12	14.28	≤ 36.00	Pass
2440	18.59	19.18	≤ 21.00	20.09	20.68	≤ 36.00	Pass
2476	12.81	13.34	≤ 21.00	14.31	14.84	≤ 36.00	Pass

Note: E.I.R.P (dBm) = Peak Power (dBm) + Antenna Gain (dBi), Antenna Gain = 1.5 dBi.

7.3. Radiated Spurious Emission Measurement

7.3.1. Test Limit

All out of band emissions appearing in a restricted band as specified in Section 15.205 of the Title 47 CFR must not exceed the limits shown in Table per Section 15.209.

FCC Part 15 Subpart C Paragraph 15.209		
Frequency [MHz]	Field Strength [V/m]	Measured Distance [Meters]
0.009 - 0.490	2400/F (kHz)	300
0.490 - 1.705	24000/F (kHz)	30
1.705 - 30	30	30
30 - 88	100	3
88 - 216	150	3
216 - 960	200	3
Above 960	500	3

7.3.2. Test Procedure Used

ANSI C63.10 Section 6.3 (General Requirements)

ANSI C63.10 Section 6.4 (Standard test method below 30MHz)

ANSI C63.10 Section 6.5 (Standard test method above 30MHz to 1GHz)

ANSI C63.10 Section 6.6 (Standard test method above 1GHz)

7.3.3. Test Setting

Table 1 - RBW as a function of frequency

Frequency	RBW
9 ~ 150 kHz	200 ~ 300 Hz
0.15 ~ 30 MHz	9 ~ 10 kHz
30 ~ 1000 MHz	100 ~ 120 kHz
> 1000 MHz	1 MHz

Quasi-Peak Measurements below 1GHz

1. Analyzer center frequency was set to the frequency of the radiated spurious emission of interest
2. Span was set greater than 1MHz
3. RBW = as specified in Table 1

4. Detector = CISPR quasi-peak
5. Sweep time = auto couple
6. Trace was allowed to stabilize

Peak Measurements above 1GHz

1. Analyzer center frequency was set to the frequency of the radiated spurious emission of interest
2. RBW = 1MHz
3. VBW = 3MHz
4. Detector = peak
5. Sweep time = auto couple
6. Trace mode = max hold
7. Trace was allowed to stabilize

7.3.4. Test Setup

30MHz ~ 1GHz Test Setup:

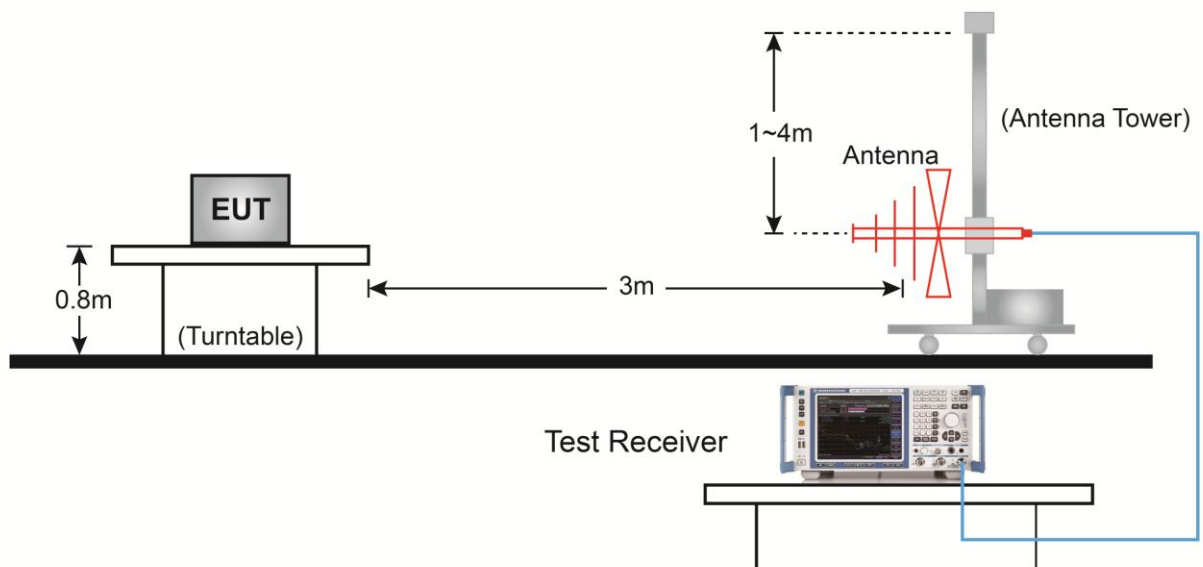

Above 1GHz Test Setup:

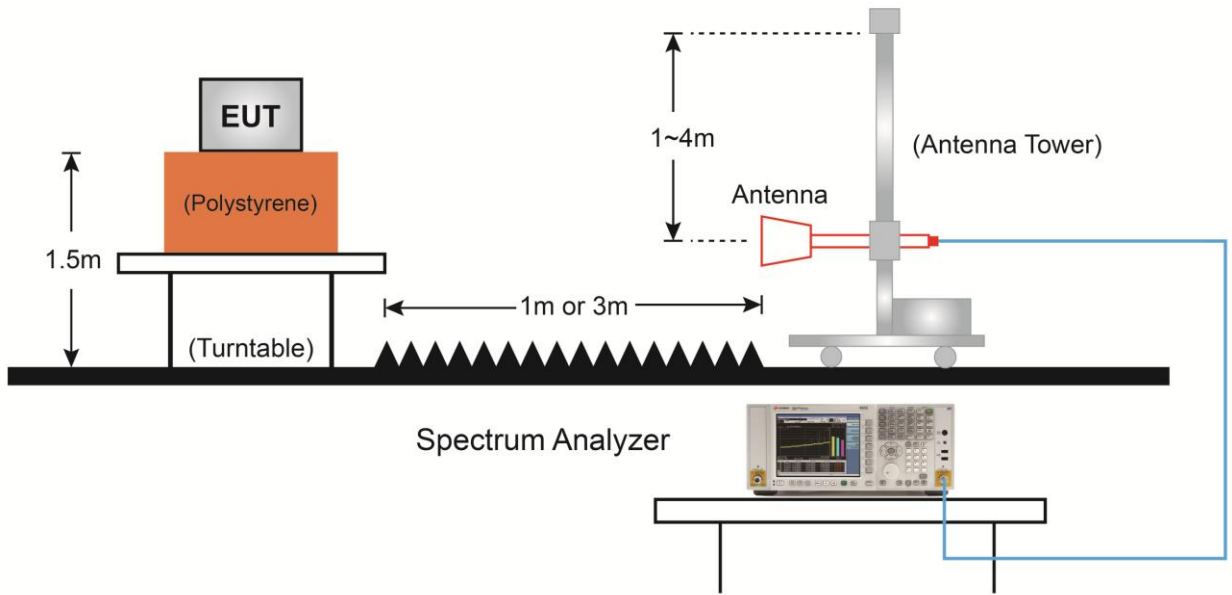

7.3.5. Test Result

Product	PowerSafe Receiver	Temperature	25°C
Test Engineer	David Lv	Relative Humidity	56%
Test Site	AC2	Test Date	2019/09/11
Test Frequency:	2404 MHz - Ant 1		
Remark:	1. Average measurement was not performed if peak level lower than average limit. 2. Other frequency was 20dB below limit line within 1-18GHz, there is not show in the report.		

Mark	Frequency (MHz)	Reading Level (dBμV)	Factor (dB)	Measure Level (dBμV/m)	Limit (dBμV/m)	Margin (dB)	Detector	Polarization
	4808.0	42.6	3.5	46.1	74.0	-27.9	Peak	Horizontal
*	5904.5	34.4	6.0	40.4	74.0	-33.6	Peak	Horizontal
	7349.5	32.5	11.7	44.2	74.0	-29.8	Peak	Horizontal
*	10103.5	32.0	14.7	46.7	74.0	-27.3	Peak	Horizontal
	4808.0	43.0	3.5	46.5	74.0	-27.5	Peak	Vertical
*	6652.5	33.4	8.4	41.8	74.0	-32.2	Peak	Vertical
	7460.0	30.8	11.6	42.4	74.0	-31.6	Peak	Vertical
*	10469.0	31.7	16.3	48.0	74.0	-26.0	Peak	Vertical

Note 1: "*" is not in restricted band, its limit is 30dBc of the fundamental emission level (98.9dBμV/m) or 15.209 which is higher.

Note 2: Peak Measure Level (dBμV/m) = Reading Level (dBμV) + Factor (dB)

Average Measure Level = Peak Measure Level + Duty Cycle Factor

Factor (dB) = Cable Loss (dB) + Antenna Factor (dB/m) - Pre Amplifier Gain (dB)

Note 3: Average measurement was not performed when the peak level lower than average limit.

Product	PowerSafe Receiver	Temperature	25°C
Test Engineer	David Lv	Relative Humidity	56%
Test Site	AC2	Test Date	2019/09/11
Test Frequency:	2440 MHz - Ant 1		
Remark:	1. Average measurement was not performed if peak level lower than average limit. 2. Other frequency was 20dB below limit line within 1-18GHz, there is not show in the report.		

Mark	Frequency (MHz)	Reading Level (dBμV)	Factor (dB)	Measure Level (dBμV/m)	Limit (dBμV/m)	Margin (dB)	Detector	Polarization
	4884.5	54.3	3.5	57.8	74.0	-16.2	Peak	Horizontal
*	6627.0	35.2	8.2	43.4	74.0	-30.6	Peak	Horizontal
	7315.5	60.5	11.9	72.4	74.0	-1.6	Peak	Horizontal
*	9755.0	40.1	14.0	54.1	74.0	-19.9	Peak	Horizontal
	4876.0	55.7	3.6	59.3	74.0	-14.7	Peak	Vertical
*	6542.0	33.0	8.5	41.5	74.0	-32.5	Peak	Vertical
	7315.5	54.1	11.9	66.0	74.0	-8.0	Peak	Vertical
*	9763.5	34.9	14.0	48.9	74.0	-25.1	Peak	Vertical

Note 1: "*" is not in restricted band, its limit is 30dBc of the fundamental emission level (99.5dBμV/m) or 15.209 which is higher.

Note 2: Peak Measure Level (dBμV/m) = Reading Level (dBμV) + Factor (dB)

Average Measure Level = Peak Measure Level + Duty Cycle Factor

Factor (dB) = Cable Loss (dB) + Antenna Factor (dB/m) - Pre Amplifier Gain (dB)

Note 3: Average measurement was not performed when the peak level lower than average limit.

Product	PowerSafe Receiver	Temperature	25°C
Test Engineer	David Lv	Relative Humidity	56%
Test Site	AC2	Test Date	2019/09/11
Test Frequency:	2476 MHz - Ant 1		
Remark:	1. Average measurement was not performed if peak level lower than average limit. 2. Other frequency was 20dB below limit line within 1-18GHz, there is not show in the report.		

Mark	Frequency (MHz)	Reading Level (dBμV)	Factor (dB)	Measure Level (dBμV/m)	Limit (dBμV/m)	Margin (dB)	Detector	Polarization
	4952.5	52.7	3.5	56.2	74.0	-17.8	Peak	Horizontal
*	6508.0	33.2	8.4	41.6	74.0	-32.4	Peak	Horizontal
	7426.0	37.2	11.9	49.1	74.0	-24.9	Peak	Horizontal
*	10069.5	31.1	14.8	45.9	74.0	-28.1	Peak	Horizontal
	4952.5	50.7	3.5	54.2	74.0	-19.8	Peak	Vertical
*	6287.0	33.7	7.1	40.8	74.0	-33.2	Peak	Vertical
	7426.0	35.7	11.9	47.6	74.0	-26.4	Peak	Vertical
*	10035.5	31.7	14.5	46.2	74.0	-27.8	Peak	Vertical

Note 1: "*" is not in restricted band, its limit is 30dBc of the fundamental emission level (99.8dBμV/m) or 15.209 which is higher.

Note 2: Peak Measure Level (dBμV/m) = Reading Level (dBμV) + Factor (dB)

Average Measure Level = Peak Measure Level + Duty Cycle Factor

Factor (dB) = Cable Loss (dB) + Antenna Factor (dB/m) - Pre Amplifier Gain (dB)

Note 3: Average measurement was not performed when the peak level lower than average limit.

Product	PowerSafe Receiver	Temperature	25°C
Test Engineer	David Lv	Relative Humidity	56%
Test Site	AC2	Test Date	2019/09/11
Test Frequency:	2404 MHz - Ant 2		
Remark:	1. Average measurement was not performed if peak level lower than average limit. 2. Other frequency was 20dB below limit line within 1-18GHz, there is not show in the report.		

Mark	Frequency (MHz)	Reading Level (dBμV)	Factor (dB)	Measure Level (dBμV/m)	Limit (dBμV/m)	Margin (dB)	Detector	Polarization
	3949.5	36.7	0.1	36.8	74.0	-37.2	Peak	Horizontal
	4808.0	43.0	3.5	46.5	74.0	-27.5	Peak	Horizontal
*	6397.5	34.3	7.4	41.7	74.0	-32.3	Peak	Horizontal
*	7213.5	34.8	11.6	46.4	74.0	-27.6	Peak	Horizontal
	4085.5	36.1	0.9	37.0	74.0	-37.0	Peak	Vertical
	4808.0	40.7	3.5	44.2	74.0	-29.8	Peak	Vertical
*	6117.0	34.3	6.5	40.8	74.0	-33.2	Peak	Vertical
*	6584.5	34.0	8.2	42.2	74.0	-31.8	Peak	Vertical

Note 1: "*" is not in restricted band, its limit is 30dBc of the fundamental emission level (103.4dBμV/m) or 15.209 which is higher.

Note 2: Peak Measure Level (dBμV/m) = Reading Level (dBμV) + Factor (dB)

Average Measure Level = Peak Measure Level + Duty Cycle Factor

Factor (dB) = Cable Loss (dB) + Antenna Factor (dB/m) - Pre Amplifier Gain (dB)

Note 3: Average measurement was not performed when the peak level lower than average limit.

Product	PowerSafe Receiver	Temperature	25°C
Test Engineer	David Lv	Relative Humidity	56%
Test Site	AC2	Test Date	2019/09/11
Test Frequency:	2440 MHz - Ant 2		
Remark:	1. Average measurement was not performed if peak level lower than average limit. 2. Other frequency was 20dB below limit line within 1-18GHz, there is not show in the report.		

Mark	Frequency (MHz)	Reading Level (dBμV)	Factor (dB)	Measure Level (dBμV/m)	Limit (dBμV/m)	Margin (dB)	Detector	Polarization
	4876.0	52.5	3.6	56.1	74.0	-17.9	Peak	Horizontal
	7315.5	57.4	11.9	69.3	74.0	-4.7	Peak	Horizontal
*	9755.0	37.4	14.0	51.4	74.0	-22.6	Peak	Horizontal
*	10316.0	32.3	15.6	47.9	74.0	-26.1	Peak	Horizontal
	4876.0	54.2	3.6	57.8	74.0	-16.2	Peak	Vertical
	7315.5	47.6	11.9	59.5	74.0	-14.5	Peak	Vertical
*	7842.5	30.4	11.5	41.9	74.0	-32.1	Peak	Vertical
*	9763.5	34.1	14.0	48.1	74.0	-25.9	Peak	Vertical

Note 1: "*" is not in restricted band, its limit is 30dBc of the fundamental emission level (103.6dBμV/m) or 15.209 which is higher.

Note 2: Peak Measure Level (dBμV/m) = Reading Level (dBμV) + Factor (dB)

Average Measure Level = Peak Measure Level + Duty Cycle Factor

Factor (dB) = Cable Loss (dB) + Antenna Factor (dB/m) - Pre Amplifier Gain (dB)

Note 3: Average measurement was not performed when the peak level lower than average limit.

Product	PowerSafe Receiver	Temperature	25°C
Test Engineer	David Lv	Relative Humidity	56%
Test Site	AC2	Test Date	2019/09/11
Test Frequency:	2476 MHz - Ant 2		
Remark:	1. Average measurement was not performed if peak level lower than average limit. 2. Other frequency was 20dB below limit line within 1-18GHz, there is not show in the report.		

Mark	Frequency (MHz)	Reading Level (dBμV)	Factor (dB)	Measure Level (dBμV/m)	Limit (dBμV/m)	Margin (dB)	Detector	Polarization
	4952.5	51.0	3.5	54.5	74.0	-19.5	Peak	Horizontal
	7426.0	34.2	11.9	46.1	74.0	-27.9	Peak	Horizontal
*	7851.0	31.5	11.5	43.0	74.0	-31.0	Peak	Horizontal
*	8633.0	32.1	12.2	44.3	74.0	-29.7	Peak	Horizontal
	4952.5	51.1	3.5	54.6	74.0	-19.4	Peak	Vertical
	7426.0	34.9	11.9	46.8	74.0	-27.2	Peak	Vertical
*	7910.5	33.3	11.6	44.9	74.0	-29.1	Peak	Vertical
*	8633.0	32.1	12.2	44.3	74.0	-29.7	Peak	Vertical

Note 1: "*" is not in restricted band, its limit is 30dBc of the fundamental emission level (103.8dBμV/m) or 15.209 which is higher.

Note 2: Peak Measure Level (dBμV/m) = Reading Level (dBμV) + Factor (dB)

Average Measure Level = Peak Measure Level + Duty Cycle Factor

Factor (dB) = Cable Loss (dB) + Antenna Factor (dB/m) - Pre Amplifier Gain (dB)

Note 3: Average measurement was not performed when the peak level lower than average limit.

The Worst Case of Radiated Emission below 1GHz:

Site: AC2	Time: 2019/09/18 - 23:35
Limit: FCC_Part15.209_RE(3m)	Engineer: David Lv
Probe: VULB9162_0.03-8GHz	Polarity: Horizontal
EUT: PowerSafe Receiver	Power: By Battery
Test Mode: Transmit at channel 2404MHz	

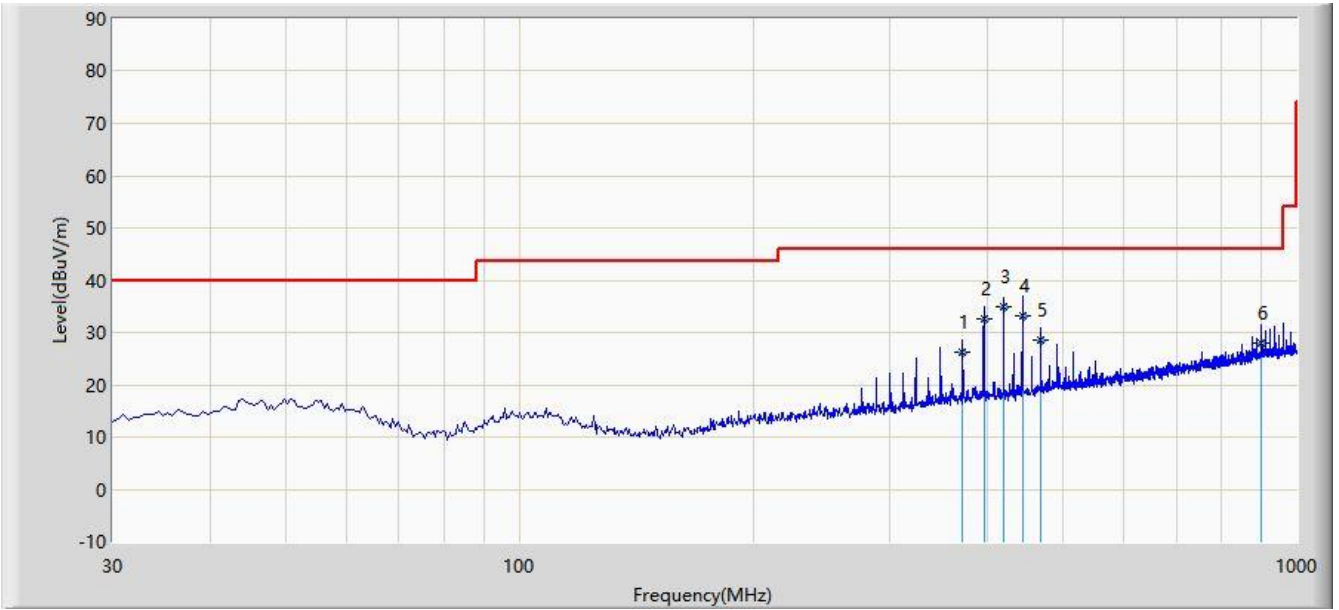

No	Flag	Mark	Frequency (MHz)	Measure Level (dBuV/m)	Reading Level (dBuV)	Over Limit (dB)	Limit (dBuV/m)	Factor (dB)	Type
1			371.925	26.174	10.285	-19.826	46.000	15.890	QP
2			396.175	32.599	16.254	-13.401	46.000	16.345	QP
3		*	419.940	35.067	18.365	-10.933	46.000	16.702	QP
4			444.190	33.235	16.244	-12.765	46.000	16.991	QP
5			467.955	28.672	11.234	-17.328	46.000	17.438	QP
6			900.900	27.897	4.265	-18.103	46.000	23.632	QP

Note 1: Measure Level (dBμV/m) = Reading Level (dBμV) + Factor (dB)

Factor (dB) = Cable Loss (dB) + Antenna Factor (dB/m)

Note 2: The test trace is same as the ambient noise and the amplitude of the emissions are attenuated more than 20dB below the permissible (the test frequency range: 9kHz ~ 30MHz, 18GHz ~ 25GHz), therefore no data appear in the report.

Site: AC2	Time: 2019/01/22 - 00:45
Limit: FCC_Part15.209_RE(3m)	Engineer: David Lv
Probe: VULB9162_0.03-8GHz	Polarity: Vertical
EUT: PowerSafe Receiver	Power: By Battery
Test Mode: Transmit at channel 2404MHz	

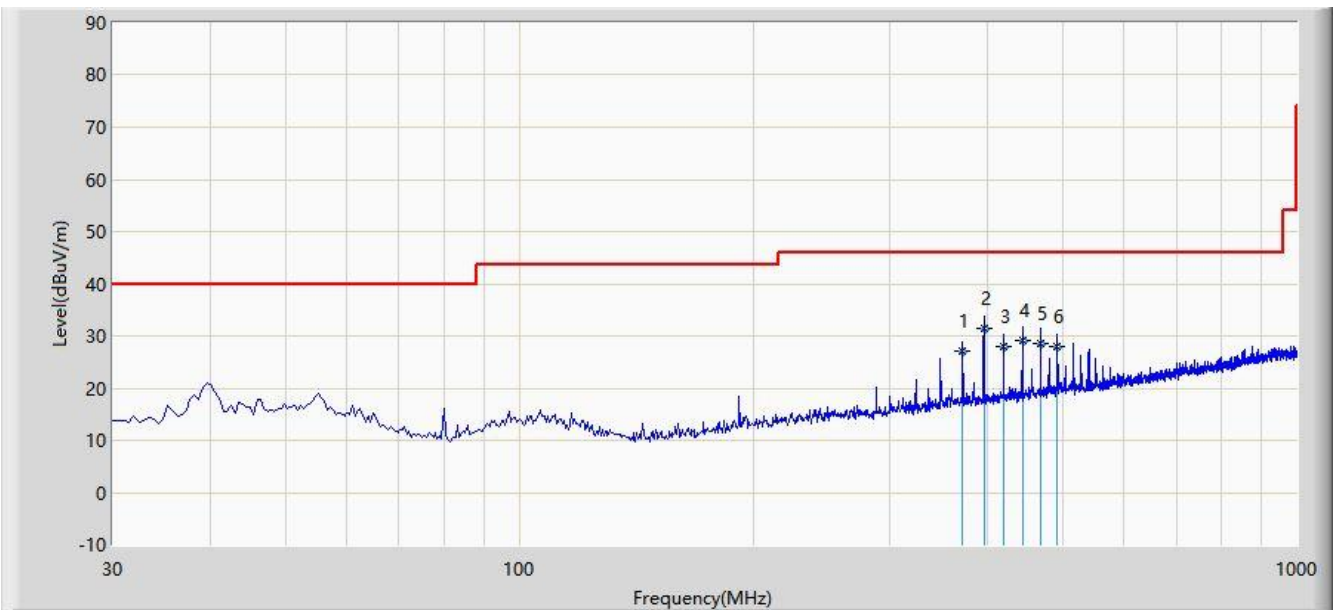

No	Flag	Mark	Frequency (MHz)	Measure Level (dBuV/m)	Reading Level (dBuV)	Over Limit (dB)	Limit (dBuV/m)	Factor (dB)	Type
1			371.925	27.101	11.212	-18.899	46.000	15.890	QP
2		*	396.175	31.379	15.034	-14.621	46.000	16.345	QP
3			419.940	27.976	11.274	-18.024	46.000	16.702	QP
4			444.190	29.145	12.154	-16.855	46.000	16.991	QP
5			467.955	28.678	11.240	-17.322	46.000	17.438	QP
6			492.205	27.979	10.103	-18.021	46.000	17.875	QP

Note 1: Measure Level (dB μ V/m) = Reading Level (dB μ V) + Factor (dB)

Factor (dB) = Cable Loss (dB) + Antenna Factor (dB/m)

Note 2: The test trace is same as the ambient noise and the amplitude of the emissions are attenuated more than 20dB below the permissible (the test frequency range: 9kHz ~ 30MHz, 18GHz ~ 25GHz), therefore no data appear in the report.

7.4. Radiated Restricted Band Edge Measurement

For 15.205 requirement:

Radiated emissions which fall in the restricted bands, as defined in Section 15.205(a) of FCC part 15, must also comply with the radiated emission limits specified in Section 15.209(a).

Frequency (MHz)	Frequency (MHz)	Frequency (MHz)	Frequency (GHz)
0.090 - 0.110	16.42 - 16.423	399.9 - 410	4.5 - 5.15
¹ 0.495 - 0.505	16.69475 - 16.69525	608 - 614	5.35 - 5.46
2.1735 - 2.1905	16.80425 - 16.80475	960 - 1240	7.25 - 7.75
4.125 - 4.128	25.5 - 25.67	1300 - 1427	8.025 - 8.5
4.17725 - 4.17775	37.5 - 38.25	1435 - 1626.5	9.0 - 9.2
4.20725 - 4.20775	73 - 74.6	1645.5 - 1646.5	9.3 - 9.5
6.215 - 6.218	74.8 - 75.2	1660 - 1710	10.6 - 12.7
6.26775 - 6.26825	108 - 121.94	1718.8 - 1722.2	13.25 - 13.4
6.31175 - 6.31225	123 - 138	2200 - 2300	14.47 - 14.5
8.291 - 8.294	149.9 - 150.05	2310 - 2390	15.35 - 16.2
8.362 - 8.366	156.52475 - 156.52525	2483.5 - 2500	17.7 - 21.4
8.37625 - 8.38675	156.7 - 156.9	2690 - 2900	22.01 - 23.12
8.41425 - 8.41475	162.0125 - 167.17	3260 - 3267	23.6 - 24.0
12.29 - 12.293	167.72 - 173.2	3332 - 3339	31.2 - 31.8
12.51975 - 12.52025	240 - 285	3345.8 - 3358	36.43 - 36.5
12.57675 - 12.57725	322 - 335.4	3600 - 4400	(²)
13.36 - 13.41	--	--	--

All out of band emissions appearing in a restricted band as specified in Section 15.205 of the Title 47CFR must not exceed the limits shown in Table per Section 15.209.

FCC Part 15 Subpart C Paragraph 15.209		
Frequency [MHz]	Field Strength [uV/m]	Measured Distance [Meters]
0.009 - 0.490	2400/F (kHz)	300
0.490 - 1.705	24000/F (kHz)	30
1.705 - 30	30	30
30 - 88	100	3
88 - 216	150	3
216 - 960	200	3
Above 960	500	3

For RSS-Gen Section 8.10 requirement:

Radiated emissions which fall in the restricted bands, as defined in Section 8.10 of RSS-Gen, must also comply with the radiated emission limits specified in Section 8.9.

Frequency (MHz)	Frequency (MHz)	Frequency (GHz)
0.090 - 0.110	149.9 - 150.05	9.0 - 9.2
0.495 - 0.505	156.52475 - 156.52525	9.3 - 9.5
2.1735 - 2.1905	156.7 - 156.9	10.6 - 12.7
3.020 - 3.026	162.0125 - 167.17	13.25 - 13.4
4.125 - 4.128	167.72 - 173.2	14.47 - 14.5
4.17725 - 4.17775	240 - 285	15.35 - 16.2
4.20725 - 4.20775	322 - 335.4	17.7 - 21.4
5.677 - 5.683	399.9 - 410	22.01 - 23.12
6.215 - 6.218	608 - 614	23.6 - 24.0
6.26775 - 6.26825	960 - 1427	31.2 - 31.8
6.31175 - 6.31225	1435 - 1626.5	36.43 - 36.5
8.291 - 8.294	1645.5 - 1646.5	Above 38.6
8.362 - 8.366	1660 - 1710	
8.37625 - 8.38675	1718.8 - 1722.2	
8.41425 - 8.41475	2200 - 2300	
12.29 - 12.293	2310 - 2390	
12.51975 - 12.52025	2483.5 - 2500	
12.57675 - 12.57725	2655 - 2900	
13.36 - 13.41	3260 - 3267	
16.42 - 16.423	3332 - 3339	
16.69475 - 16.69525	3345.8 - 3358	
16.80425 - 16.80475	3500 - 4400	
25.5 - 25.67	4500 - 5150	
37.5 - 38.25	5350 - 5460	
73 - 74.6	7250 - 7750	
74.8 - 75.2	8025 - 8500	
108 - 138		

All out of band emissions appearing in a restricted band as specified in Section 8.10 of the RSS-Gen must not exceed the limits shown in Table per Section 8.9.

RSS-Gen Section 8.9			
Frequency [MHz]	Field Strength [uV/m]	Magnetic Field Strength (H-Field) (uA/m)	Measured Distance [Meters]
0.009 - 0.490	--	6.37/F (F in kHz)	300
0.490 - 1.705	--	6.37/F (F in kHz)	30
1.705 - 30	--	0.08	30
30 - 88	100	--	3
88 - 216	150	--	3
216 - 960	200	--	3
Above 960	500	--	3

7.4.1. Test Procedure Used

ANSI C63.10 Section 6.3 (General Requirements)

ANSI C63.10 Section 6.6 (Standard test method above 1GHz)

7.4.2. Test Setting

Peak Field Strength Measurements

1. Analyzer center frequency was set to the frequency of the radiated spurious emission of interest
2. RBW = 1MHz
3. VBW = 3MHz
4. Detector = peak
5. Sweep time = auto couple
6. Trace mode = max hold
7. Trace was allowed to stabilize

Average Measurements above 1GHz (Method VB)

1. Analyzer center frequency was set to the frequency of the radiated spurious emission of interest
2. RBW = 1MHz
3. VBW; If the EUT is configured to transmit with duty cycle $\geq 98\%$, set VBW = 10 Hz.
If the EUT duty cycle is $< 98\%$, set VBW $\geq 1/T$. T is the minimum transmission duration.

4. Detector = Peak
5. Sweep time = auto
6. Trace mode = max hold
7. Trace was allowed to stabilize

7.4.3. Test Setup

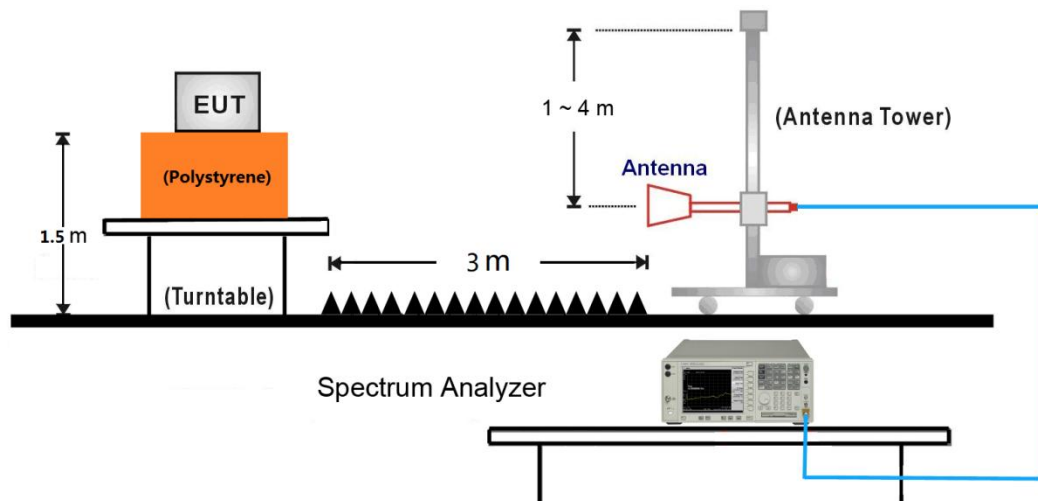

7.4.4. Test Result

Site: AC2	Time: 2019/09/06 - 05:02
Limit: FCC_Part15_Band Edge(3m)	Engineer: David Lv
Probe: BBHA9120D_1-18GHz	Polarity: Horizontal
EUT: 12310T	Power: By Battery
Note: Transmit at Channel 2404MHz Ant1	

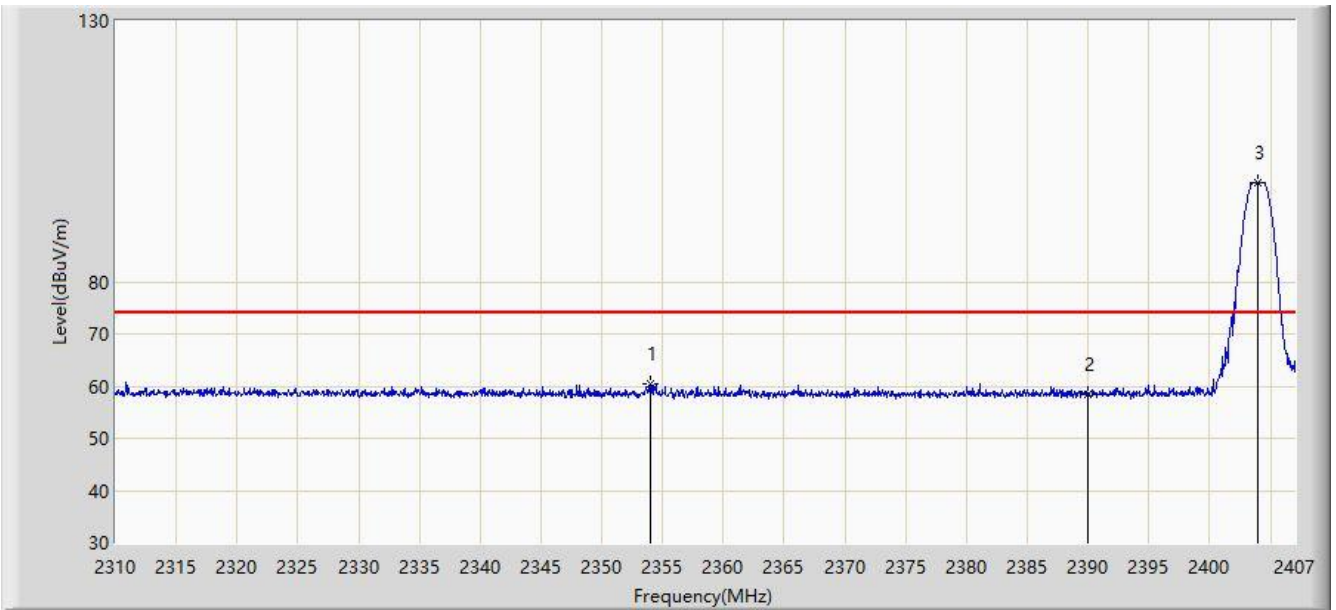

No	Flag	Mark	Frequency (MHz)	Measure Level (dBuV/m)	Reading Level (dBuV)	Margin (dB)	Limit (dBuV/m)	Factor (dB)	Type
1			2354.002	60.496	29.004	-13.504	74.000	31.492	PK
2			2390.000	58.299	26.850	-15.701	74.000	31.449	PK
3		*	2403.982	98.920	67.505	N/A	N/A	31.415	PK

Note: Measure Level (dB μ V/m) = Reading Level (dB μ V) + Factor (dB)

Factor (dB) = Cable Loss (dB) + Antenna Factor (dB/m)

Site: AC2	Time: 2019/09/06 - 05:06
Limit: FCC_Part15_Band Edge(3m)	Engineer: David Lv
Probe: BBHA9120D_1-18GHz	Polarity: Horizontal
EUT: 12310T	Power: By Battery
Note: Transmit at Channel 2404MHz Ant1	

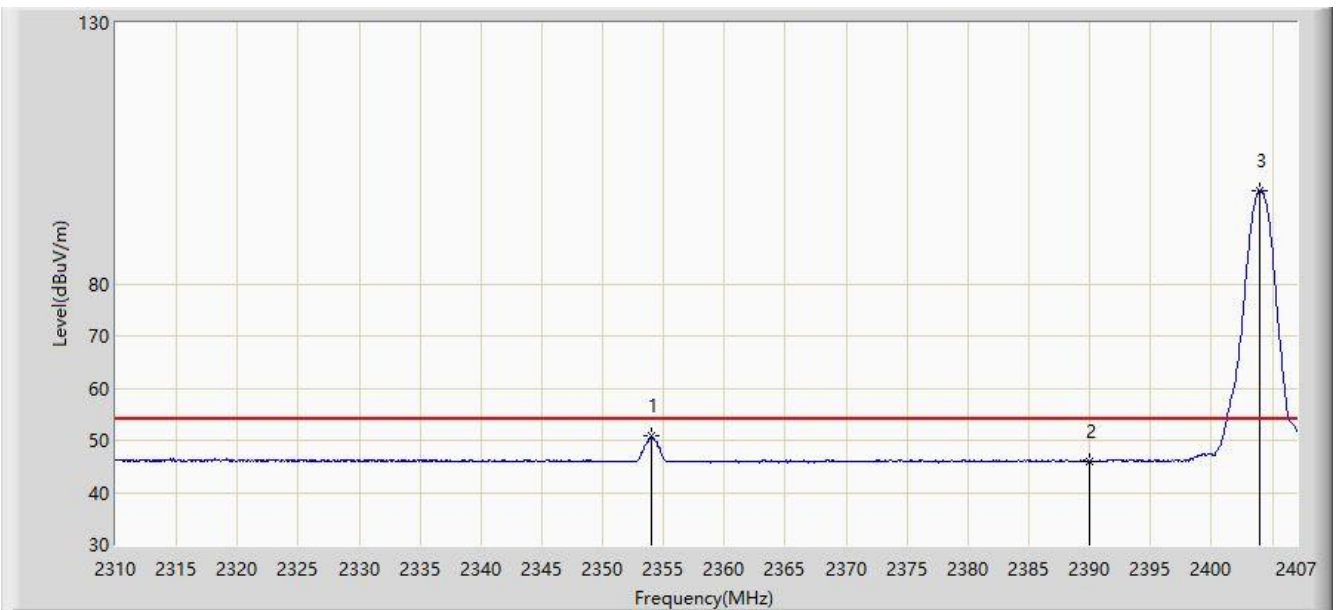

No	Flag	Mark	Frequency (MHz)	Measure Level (dBuV/m)	Reading Level (dBuV)	Margin (dB)	Limit (dBuV/m)	Factor (dB)	Type
1			2354.002	50.812	19.320	-3.188	54.000	31.492	AV
2			2390.000	46.034	14.585	-7.966	54.000	31.449	AV
3		*	2403.933	97.900	66.485	N/A	N/A	31.415	AV

Note: Measure Level (dB μ V/m) = Reading Level (dB μ V) + Factor (dB)

Factor (dB) = Cable Loss (dB) + Antenna Factor (dB/m)

Site: AC2	Time: 2019/09/06 - 05:11
Limit: FCC_Part15_Band Edge(3m)	Engineer: David Lv
Probe: BBHA9120D_1-18GHz	Polarity: Vertical
EUT: 12310T	Power: By Battery
Note: Transmit at Channel 2404MHz Ant1	

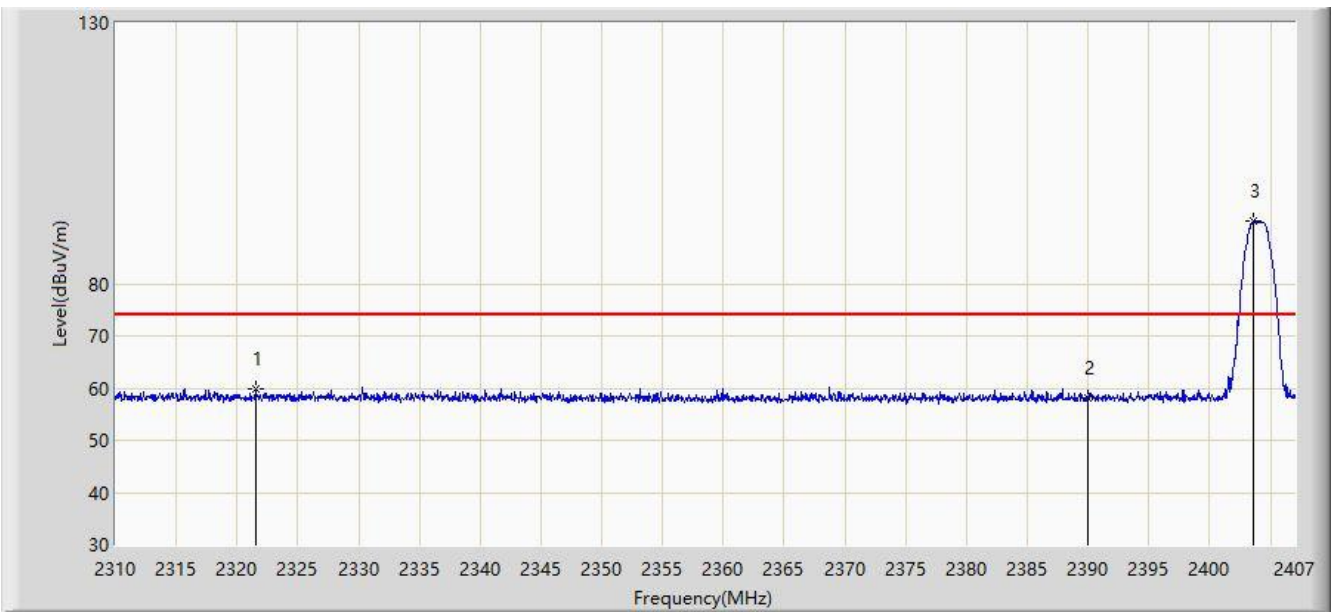

No	Flag	Mark	Frequency (MHz)	Measure Level (dBuV/m)	Reading Level (dBuV)	Margin (dB)	Limit (dBuV/m)	Factor (dB)	Type
1			2321.515	59.884	28.249	-14.116	74.000	31.635	PK
2			2390.000	58.168	26.719	-15.832	74.000	31.449	PK
3		*	2403.639	91.959	60.543	N/A	N/A	31.416	PK

Note: Measure Level (dB μ V/m) = Reading Level (dB μ V) + Factor (dB)

Factor (dB) = Cable Loss (dB) + Antenna Factor (dB/m)

Site: AC2	Time: 2019/09/06 - 05:15
Limit: FCC_Part15_Band Edge(3m)	Engineer: David Lv
Probe: BBHA9120D_1-18GHz	Polarity: Vertical
EUT: 12310T	Power: By Battery
Note: Transmit at Channel 2404MHz Ant1	

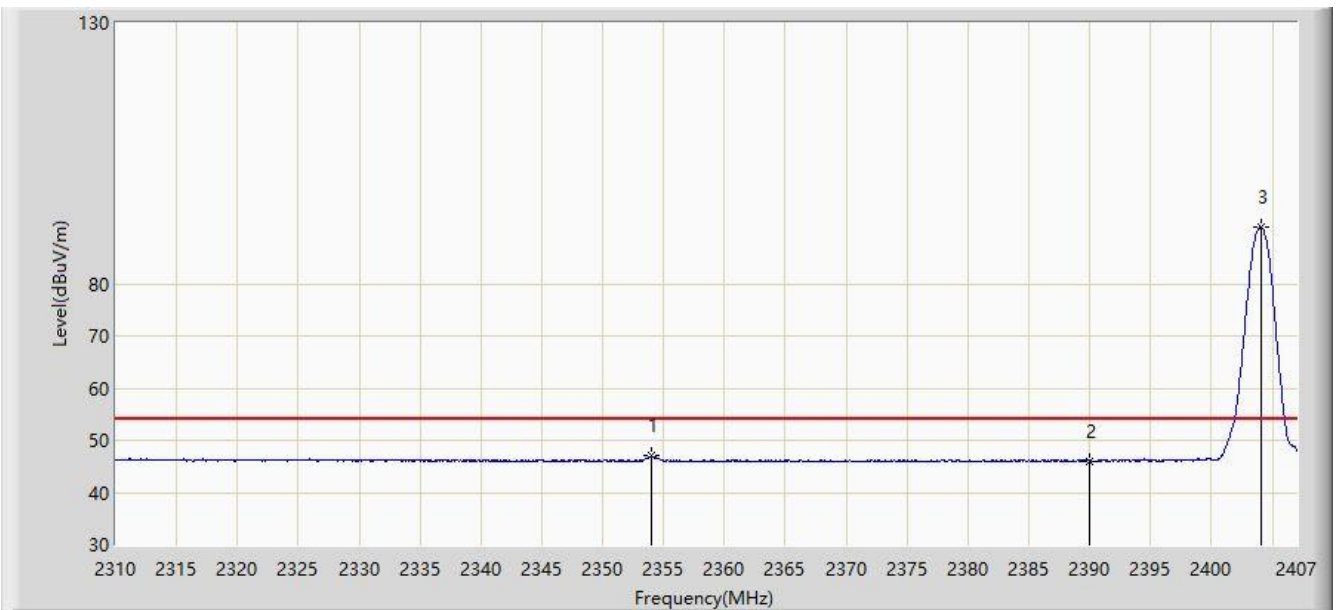

No	Flag	Mark	Frequency (MHz)	Measure Level (dBuV/m)	Reading Level (dBuV)	Margin (dB)	Limit (dBuV/m)	Factor (dB)	Type
1			2354.002	46.959	15.467	-7.041	54.000	31.492	AV
2			2390.000	46.075	14.626	-7.925	54.000	31.449	AV
3		*	2404.129	90.819	59.405	N/A	N/A	31.414	AV

Note: Measure Level (dB μ V/m) = Reading Level (dB μ V) + Factor (dB)

Factor (dB) = Cable Loss (dB) + Antenna Factor (dB/m)

Site: AC2	Time: 2019/09/06 - 05:18
Limit: FCC_Part15_Band Edge(3m)	Engineer: David Lv
Probe: BBHA9120D_1-18GHz	Polarity: Horizontal
EUT: 12310T	Power: By Battery
Note: Transmit at Channel 2476MHz Ant1	

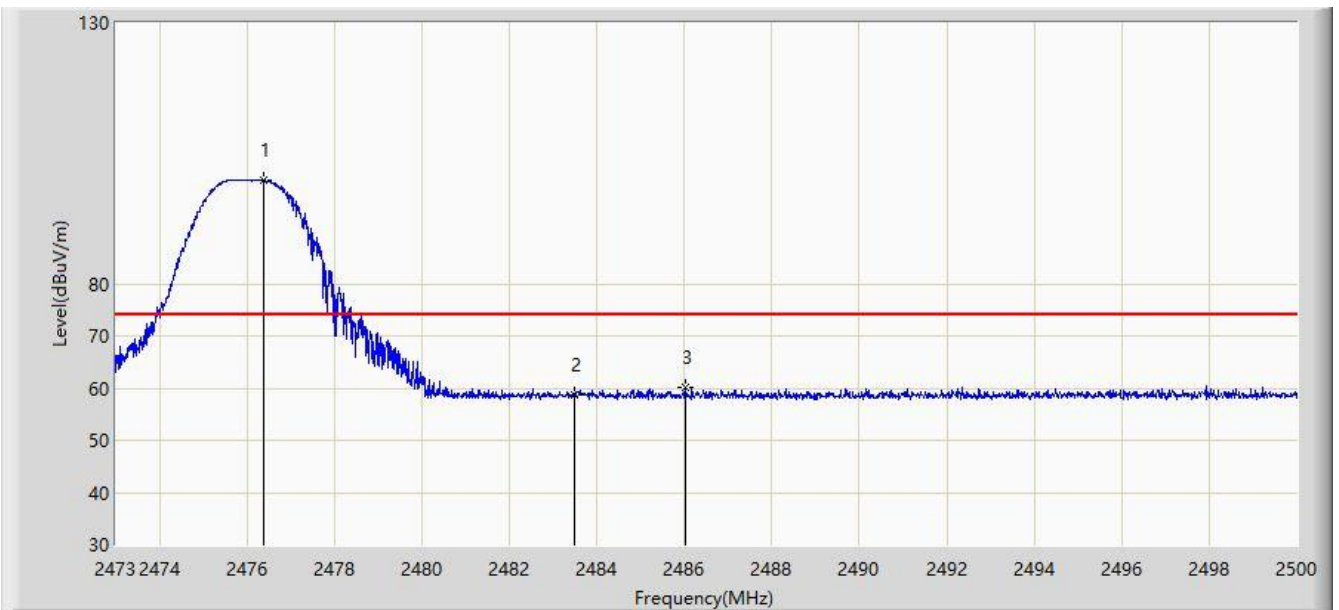

No	Flag	Mark	Frequency (MHz)	Measure Level (dBuV/m)	Reading Level (dBuV)	Margin (dB)	Limit (dBuV/m)	Factor (dB)	Type
1		*	2476.388	99.786	68.405	N/A	N/A	31.381	PK
2			2483.500	58.584	27.181	-15.416	74.000	31.403	PK
3			2486.014	60.082	28.671	-13.918	74.000	31.411	PK

Note: Measure Level (dB μ V/m) = Reading Level (dB μ V) + Factor (dB)

Factor (dB) = Cable Loss (dB) + Antenna Factor (dB/m)

Site: AC2	Time: 2019/09/06 - 05:22
Limit: FCC_Part15_Band Edge(3m)	Engineer: David Lv
Probe: BBHA9120D_1-18GHz	Polarity: Horizontal
EUT: 12310T	Power: By Battery
Note: Transmit at Channel 2476MHz Ant1	

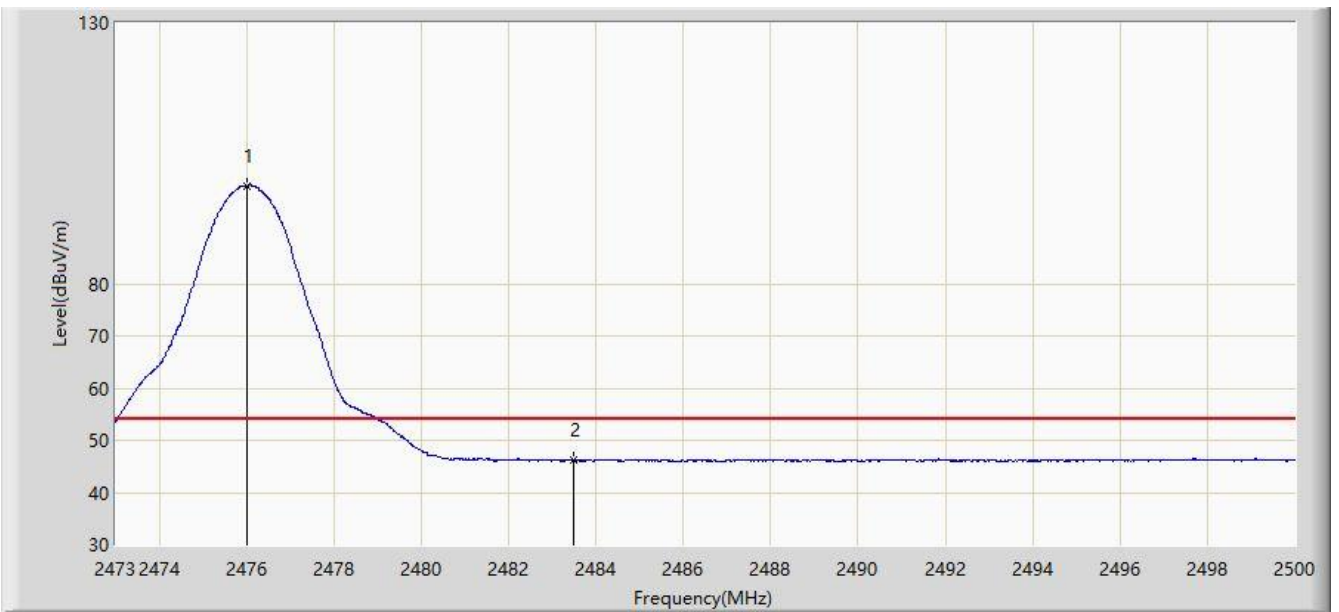

No	Flag	Mark	Frequency (MHz)	Measure Level (dBuV/m)	Reading Level (dBuV)	Margin (dB)	Limit (dBuV/m)	Factor (dB)	Type
1		*	2476.010	98.802	67.422	N/A	N/A	31.380	AV
2			2483.500	46.235	14.832	-7.765	54.000	31.403	AV

Note: Measure Level (dBμV/m) = Reading Level (dBμV) + Factor (dB)

Factor (dB) = Cable Loss (dB) + Antenna Factor (dB/m)

Site: AC2	Time: 2019/09/06 - 05:25
Limit: FCC_Part15_Band Edge(3m)	Engineer: David Lv
Probe: BBHA9120D_1-18GHz	Polarity: Vertical
EUT: 12310T	Power: By Battery
Note: Transmit at Channel 2476MHz Ant1	

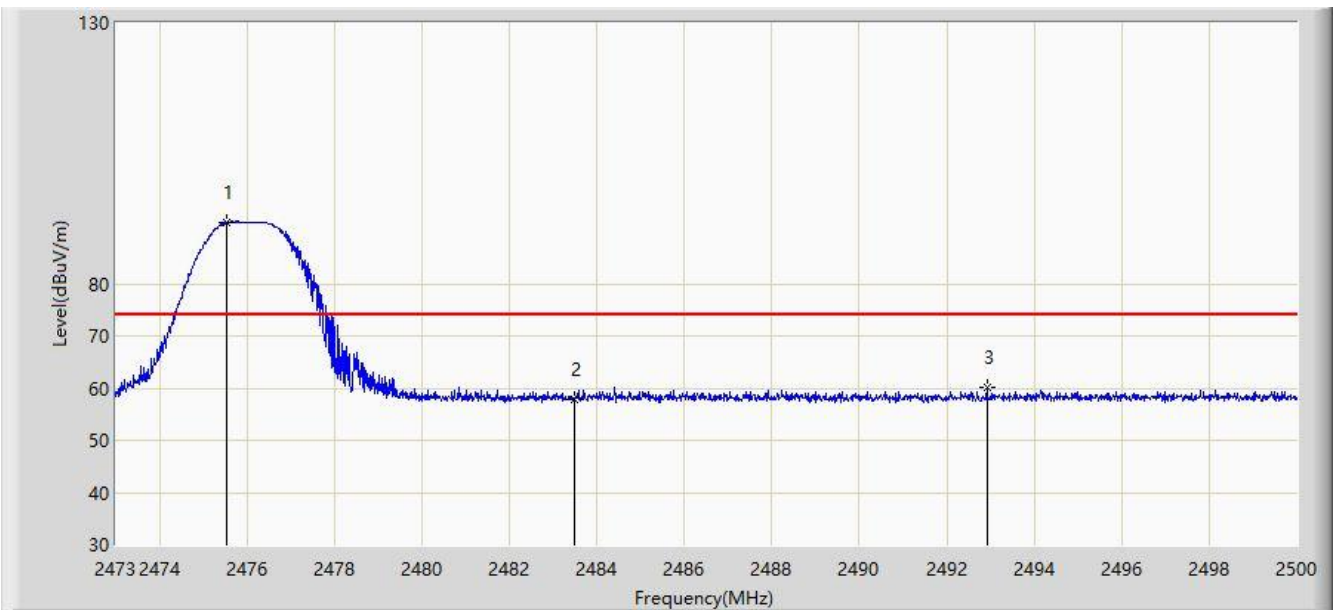

No	Flag	Mark	Frequency (MHz)	Measure Level (dBuV/m)	Reading Level (dBuV)	Margin (dB)	Limit (dBuV/m)	Factor (dB)	Type
1		*	2475.552	91.723	60.344	N/A	N/A	31.379	PK
2			2483.500	57.936	26.533	-16.064	74.000	31.403	PK
3			2492.913	60.149	28.714	-13.851	74.000	31.435	PK

Note: Measure Level (dB μ V/m) = Reading Level (dB μ V) + Factor (dB)

Factor (dB) = Cable Loss (dB) + Antenna Factor (dB/m)

Site: AC2	Time: 2019/09/06 - 05:29
Limit: FCC_Part15_Band Edge(3m)	Engineer: David Lv
Probe: BBHA9120D_1-18GHz	Polarity: Vertical
EUT: 12310T	Power: By Battery
Note: Transmit at Channel 2476MHz Ant1	

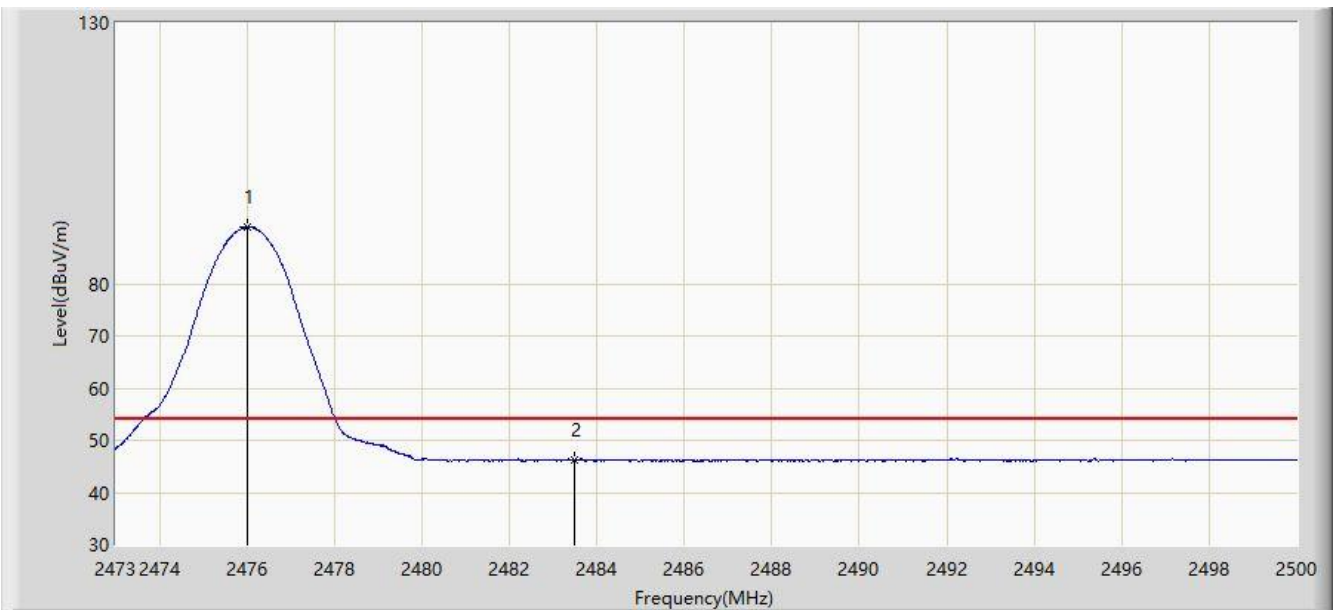

No	Flag	Mark	Frequency (MHz)	Measure Level (dBuV/m)	Reading Level (dBuV)	Margin (dB)	Limit (dBuV/m)	Factor (dB)	Type
1		*	2476.010	90.833	59.453	N/A	N/A	31.380	AV
2			2483.500	46.256	14.853	-7.744	54.000	31.403	AV

Note: Measure Level (dB μ V/m) = Reading Level (dB μ V) + Factor (dB)

Factor (dB) = Cable Loss (dB) + Antenna Factor (dB/m)

Site: AC2	Time: 2019/09/11 - 20:06
Limit: FCC_Part15_Band Edge(3m)	Engineer: David Lv
Probe: BBHA9120D_1-18GHz	Polarity: Horizontal
EUT: 12310T	Power: By Battery
Note: Transmit at Channel 2404MHz Ant2	

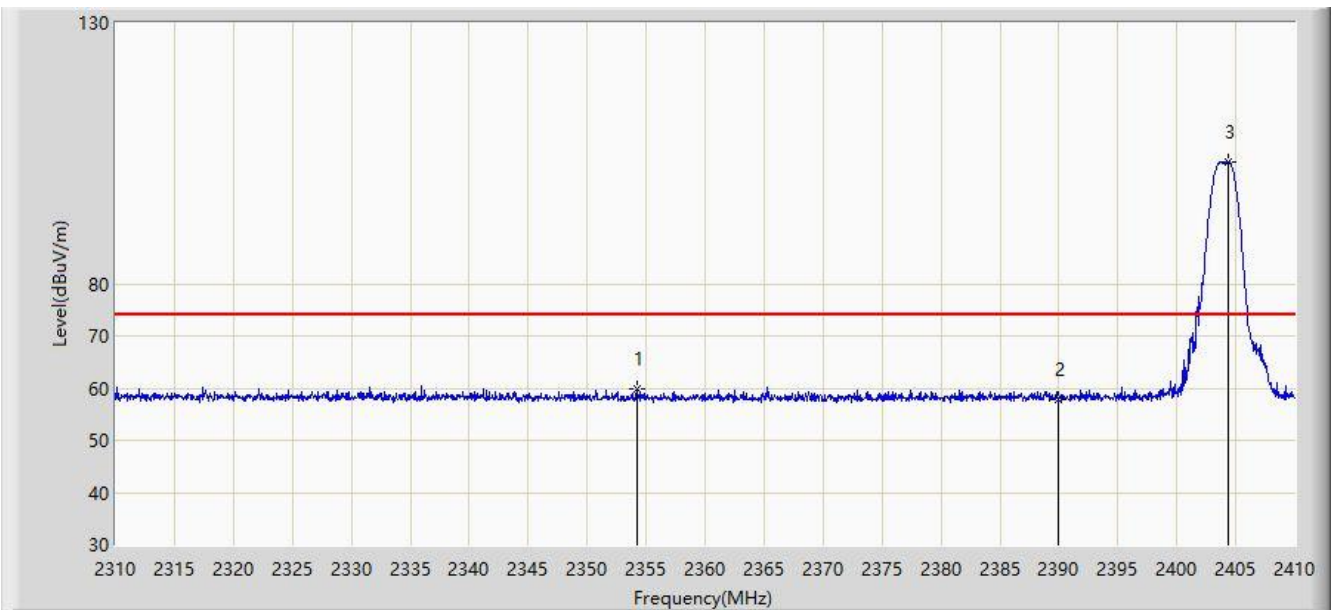

No	Flag	Mark	Frequency (MHz)	Measure Level (dBuV/m)	Reading Level (dBuV)	Margin (dB)	Limit (dBuV/m)	Factor (dB)	Type
1			2354.250	59.985	28.494	-14.015	74.000	31.491	PK
2			2390.000	57.923	26.474	-16.077	74.000	31.449	PK
3		*	2404.300	103.415	72.001	N/A	N/A	31.414	PK

Note: Measure Level (dB μ V/m) = Reading Level (dB μ V) + Factor (dB)

Factor (dB) = Cable Loss (dB) + Antenna Factor (dB/m)

Site: AC2	Time: 2019/09/11 - 20:25
Limit: FCC_Part15_Band Edge(3m)	Engineer: David Lv
Probe: BBHA9120D_1-18GHz	Polarity: Horizontal
EUT: 12310T	Power: By Battery
Note: Transmit at Channel 2404MHz Ant2	

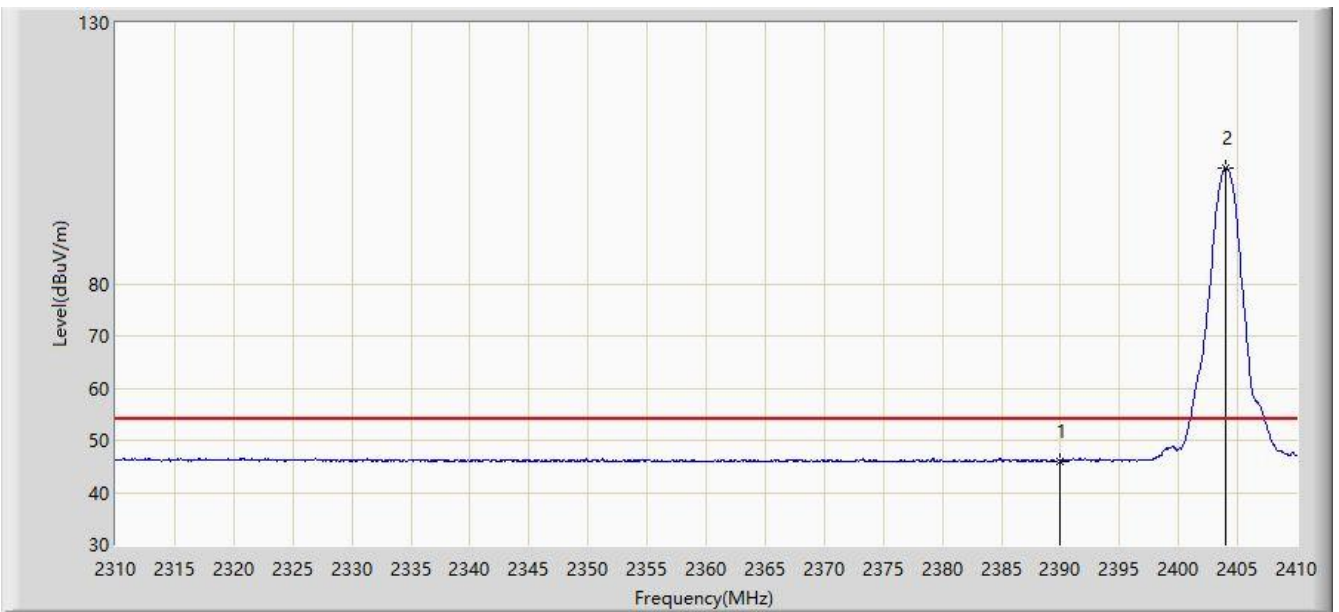

No	Flag	Mark	Frequency (MHz)	Measure Level (dBuV/m)	Reading Level (dBuV)	Margin (dB)	Limit (dBuV/m)	Factor (dB)	Type
1			2390.000	46.044	14.595	-7.956	54.000	31.449	AV
2		*	2403.950	102.232	70.817	N/A	N/A	31.415	AV

Note: Measure Level (dB μ V/m) = Reading Level (dB μ V) + Factor (dB)

Factor (dB) = Cable Loss (dB) + Antenna Factor (dB/m)

Site: AC2	Time: 2019/09/11 - 20:26
Limit: FCC_Part15_Band Edge(3m)	Engineer: David Lv
Probe: BBHA9120D_1-18GHz	Polarity: Vertical
EUT: 12310T	Power: By Battery
Note: Transmit at Channel 2404MHz Ant2	

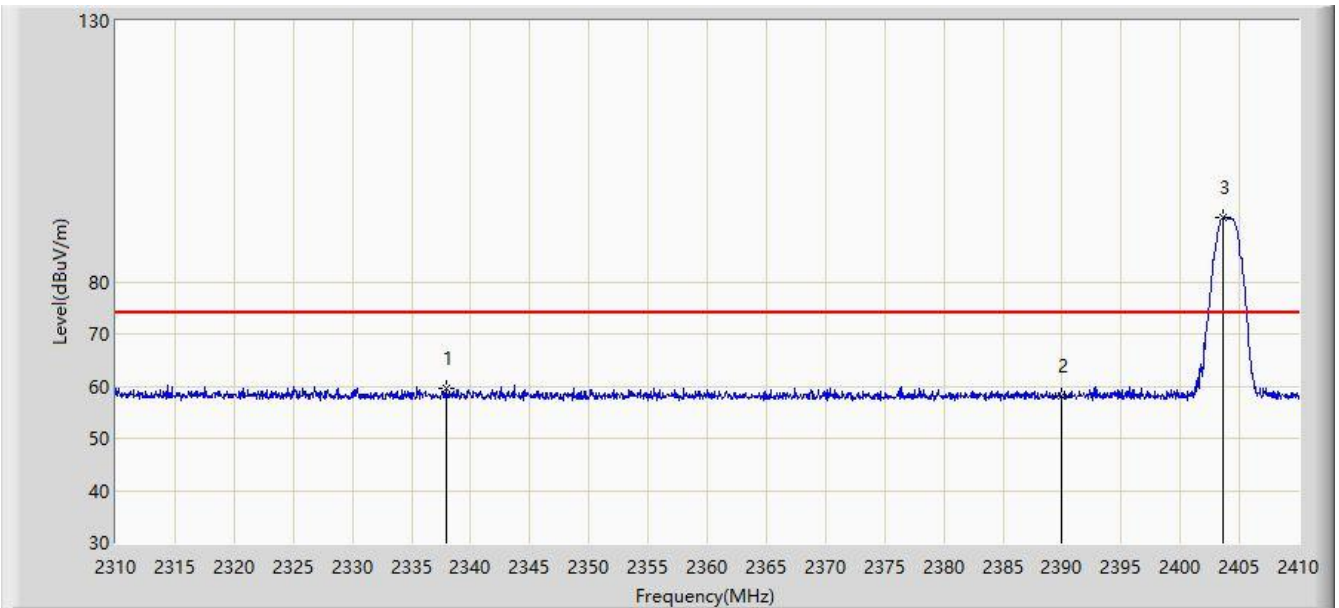

No	Flag	Mark	Frequency (MHz)	Measure Level (dBuV/m)	Reading Level (dBuV)	Margin (dB)	Limit (dBuV/m)	Factor (dB)	Type
1			2337.900	59.585	28.026	-14.415	74.000	31.559	PK
2			2390.000	58.249	26.800	-15.751	74.000	31.449	PK
3		*	2403.550	92.267	60.851	N/A	N/A	31.416	PK

Note: Measure Level (dB μ V/m) = Reading Level (dB μ V) + Factor (dB)

Factor (dB) = Cable Loss (dB) + Antenna Factor (dB/m)

Site: AC2	Time: 2019/09/11 - 20:28
Limit: FCC_Part15_Band Edge(3m)	Engineer: David Lv
Probe: BBHA9120D_1-18GHz	Polarity: Vertical
EUT: 12310T	Power: By Battery
Note: Transmit at Channel 2404MHz Ant2	

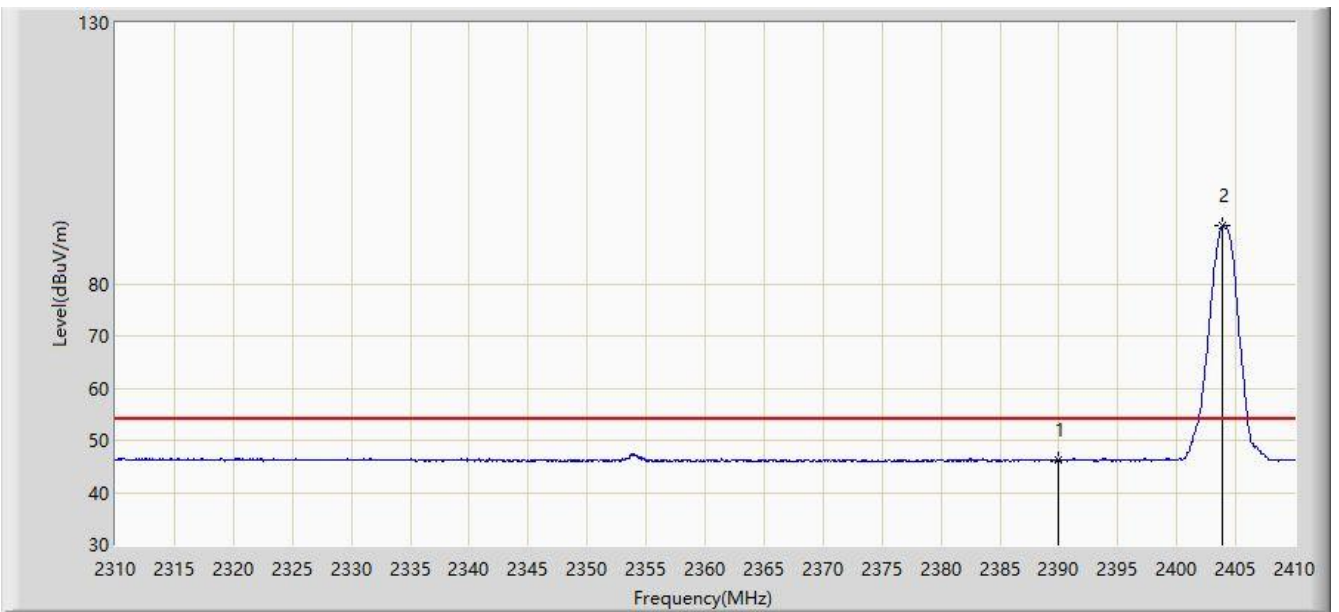

No	Flag	Mark	Frequency (MHz)	Measure Level (dBuV/m)	Reading Level (dBuV)	Margin (dB)	Limit (dBuV/m)	Factor (dB)	Type
1			2390.000	46.139	14.690	-7.861	54.000	31.449	AV
2		*	2403.900	91.124	59.709	N/A	N/A	31.415	AV

Note: Measure Level (dBμV/m) = Reading Level (dBμV) + Factor (dB)

Factor (dB) = Cable Loss (dB) + Antenna Factor (dB/m)

Site: AC2	Time: 2019/09/11 - 20:29
Limit: FCC_Part15_Band Edge(3m)	Engineer: David Lv
Probe: BBHA9120D_1-18GHz	Polarity: Horizontal
EUT: 12310T	Power: By Battery
Note: Transmit at Channel 2476MHz Ant2	

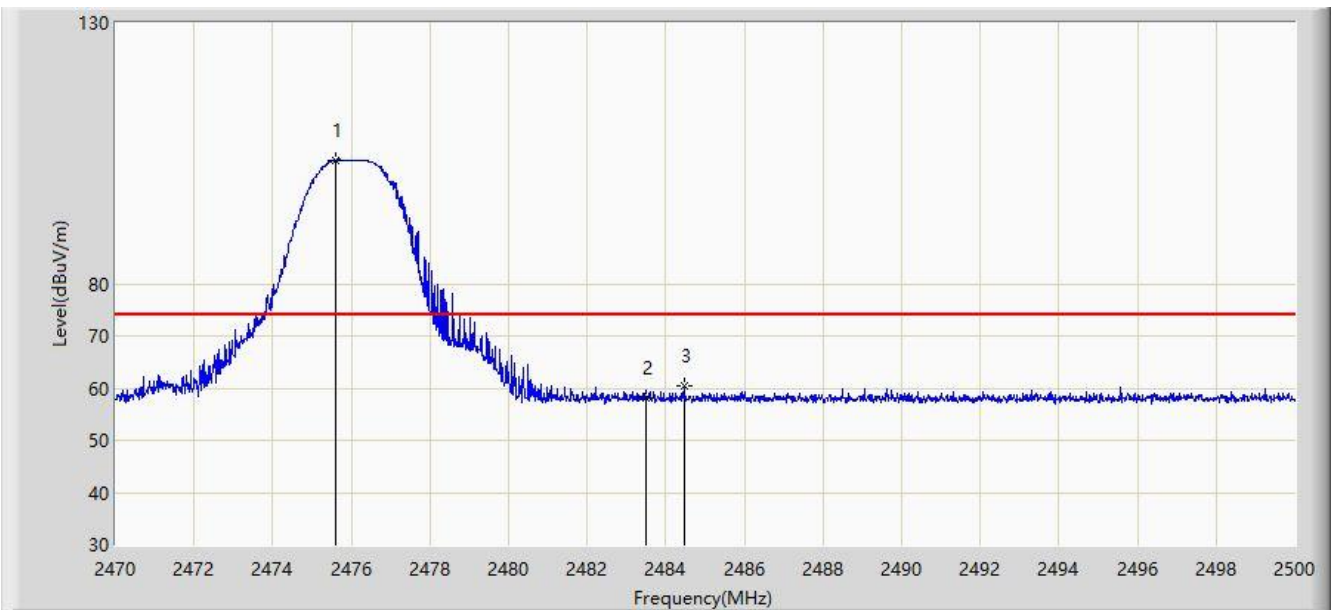

No	Flag	Mark	Frequency (MHz)	Measure Level (dBuV/m)	Reading Level (dBuV)	Margin (dB)	Limit (dBuV/m)	Factor (dB)	Type
1		*	2475.595	103.763	72.384	N/A	N/A	31.379	PK
2			2483.500	58.038	26.635	-15.962	74.000	31.403	PK
3			2484.460	60.359	28.953	-13.641	74.000	31.406	PK

Note: Measure Level (dB μ V/m) = Reading Level (dB μ V) + Factor (dB)

Factor (dB) = Cable Loss (dB) + Antenna Factor (dB/m)

Site: AC2	Time: 2019/09/11 - 20:32
Limit: FCC_Part15_Band Edge(3m)	Engineer: David Lv
Probe: BBHA9120D_1-18GHz	Polarity: Horizontal
EUT: 12310T	Power: By Battery
Note: Transmit at Channel 2476MHz Ant2	

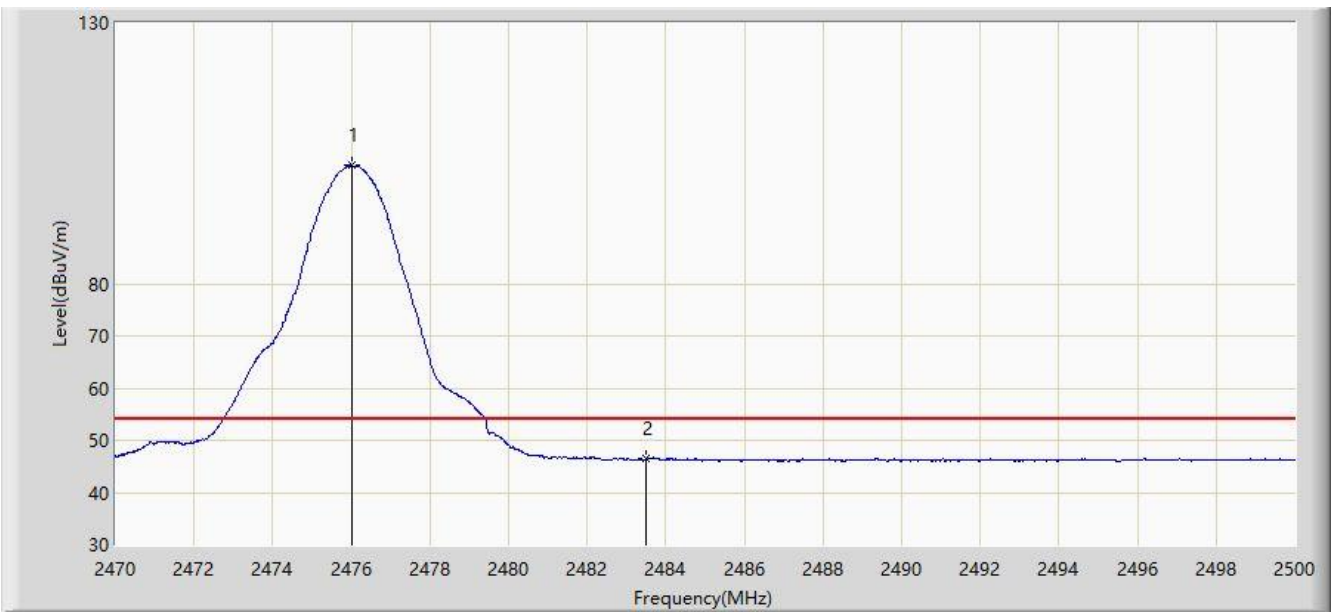

No	Flag	Mark	Frequency (MHz)	Measure Level (dBuV/m)	Reading Level (dBuV)	Margin (dB)	Limit (dBuV/m)	Factor (dB)	Type
1		*	2476.000	102.689	71.309	N/A	N/A	31.380	AV
2			2483.500	46.398	14.995	-7.602	54.000	31.403	AV

Note: Measure Level (dB μ V/m) = Reading Level (dB μ V) + Factor (dB)

Factor (dB) = Cable Loss (dB) + Antenna Factor (dB/m)

Site: AC2	Time: 2019/09/11 - 20:32
Limit: FCC_Part15_Band Edge(3m)	Engineer: David Lv
Probe: BBHA9120D_1-18GHz	Polarity: Vertical
EUT: 12310T	Power: By Battery
Note: Transmit at Channel 2476MHz Ant2	

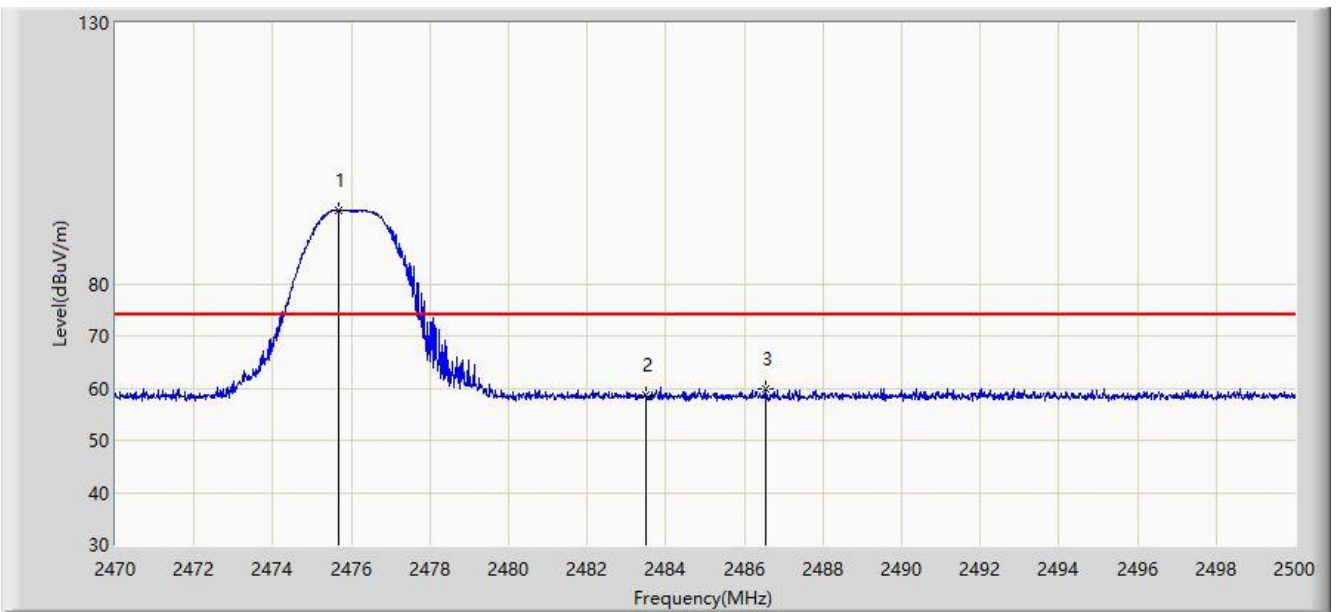

No	Flag	Mark	Frequency (MHz)	Measure Level (dBuV/m)	Reading Level (dBuV)	Margin (dB)	Limit (dBuV/m)	Factor (dB)	Type
1		*	2475.670	94.093	62.714	N/A	N/A	31.379	PK
2			2483.500	58.631	27.228	-15.369	74.000	31.403	PK
3			2486.560	59.981	28.568	-14.019	74.000	31.413	PK

Note: Measure Level (dB μ V/m) = Reading Level (dB μ V) + Factor (dB)

Factor (dB) = Cable Loss (dB) + Antenna Factor (dB/m)

Site: AC2	Time: 2019/09/11 - 20:35
Limit: FCC_Part15_Band Edge(3m)	Engineer: David Lv
Probe: BBHA9120D_1-18GHz	Polarity: Vertical
EUT: 12310T	Power: By Battery
Note: Transmit at Channel 2476MHz Ant2	

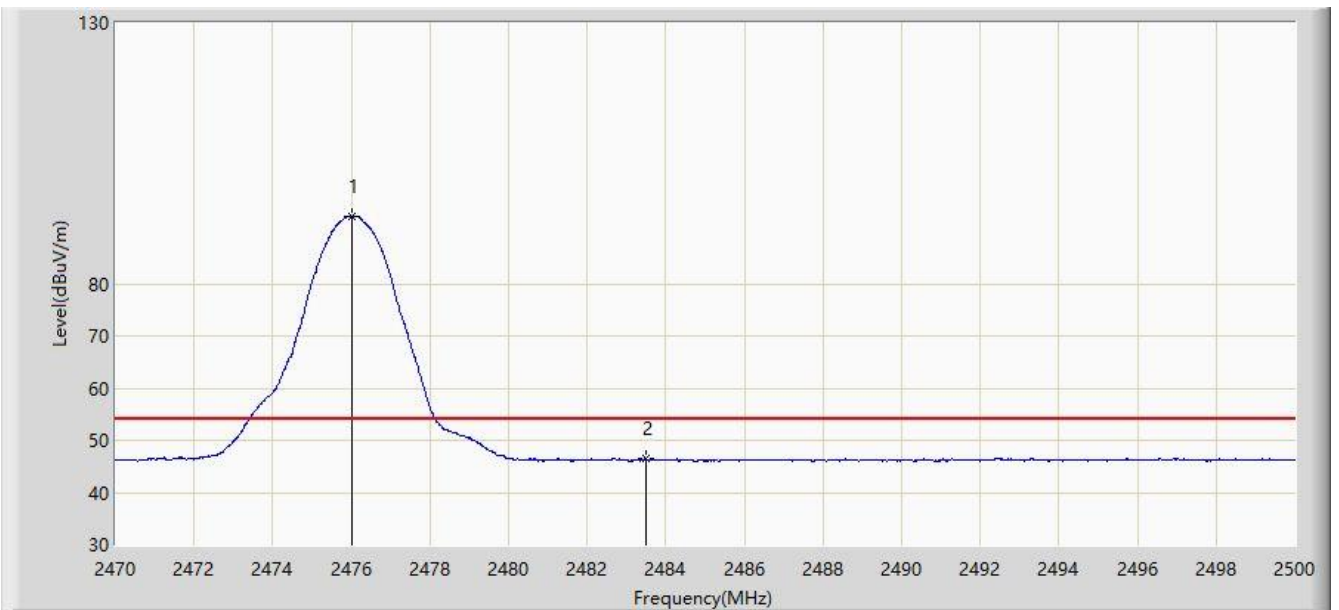

No	Flag	Mark	Frequency (MHz)	Measure Level (dBuV/m)	Reading Level (dBuV)	Margin (dB)	Limit (dBuV/m)	Factor (dB)	Type
1		*	2476.000	92.972	61.592	38.972	54.000	31.380	AV
2			2483.500	46.382	14.979	-7.618	54.000	31.403	AV

Note: Measure Level (dB μ V/m) = Reading Level (dB μ V) + Factor (dB)

Factor (dB) = Cable Loss (dB) + Antenna Factor (dB/m)

7.5. AC Conducted Emissions Measurement

7.5.1. Test Limit

FCC Part 15 Subpart C Paragraph 15.207 Limits		
Frequency (MHz)	QP (dBuV)	AV (dBuV)
0.15 - 0.50	66 - 56	56 - 46
0.50 - 5.0	56	46
5.0 - 30	60	50

Note 1: The lower limit shall apply at the transition frequencies.

Note 2: The limit decreases linearly with the logarithm of the frequency in the range 0.15MHz to 0.5MHz.

7.5.2. Test Setup

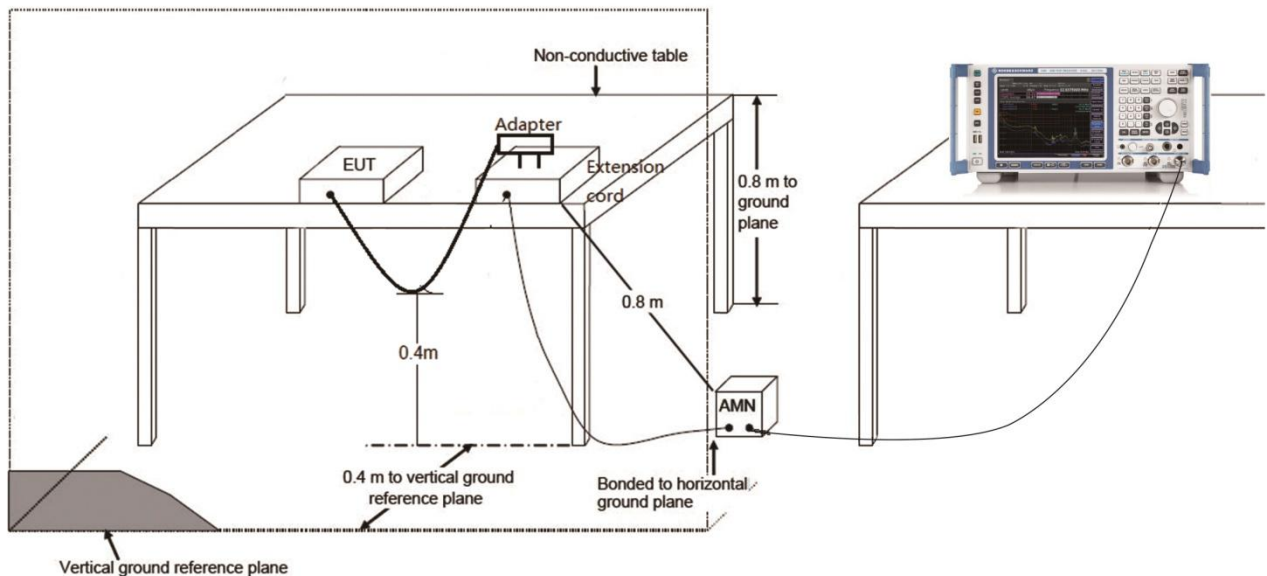

7.5.3. Test Result

The EUT is powered by DC Source, so this item is not applicable.

8. CONCLUSION

The data collected relate only the item(s) tested and show that unit is in compliance with FCC rules and ISED rules.

Appendix A - Test Setup Photograph

Refer to "1909RSU008-UT" file.

Appendix B - EUT Photograph

Refer to "1909RSU008-UE" file.

_____ The End _____