

ADI CONFIDENTIAL PAPERS
 DO NOT COPY
 REFERENCE
 117

W. Y. Wang
 DATE: 1.7.99
 DATE: 1/7/99

ADI CORP. (CONFIDENTIAL PAPERS)
 QD-1861GCD-1861T (G861G18) POWER BOARD
 Document Number: 814-178-001
 Issue: 1
 Date: 1.7.99

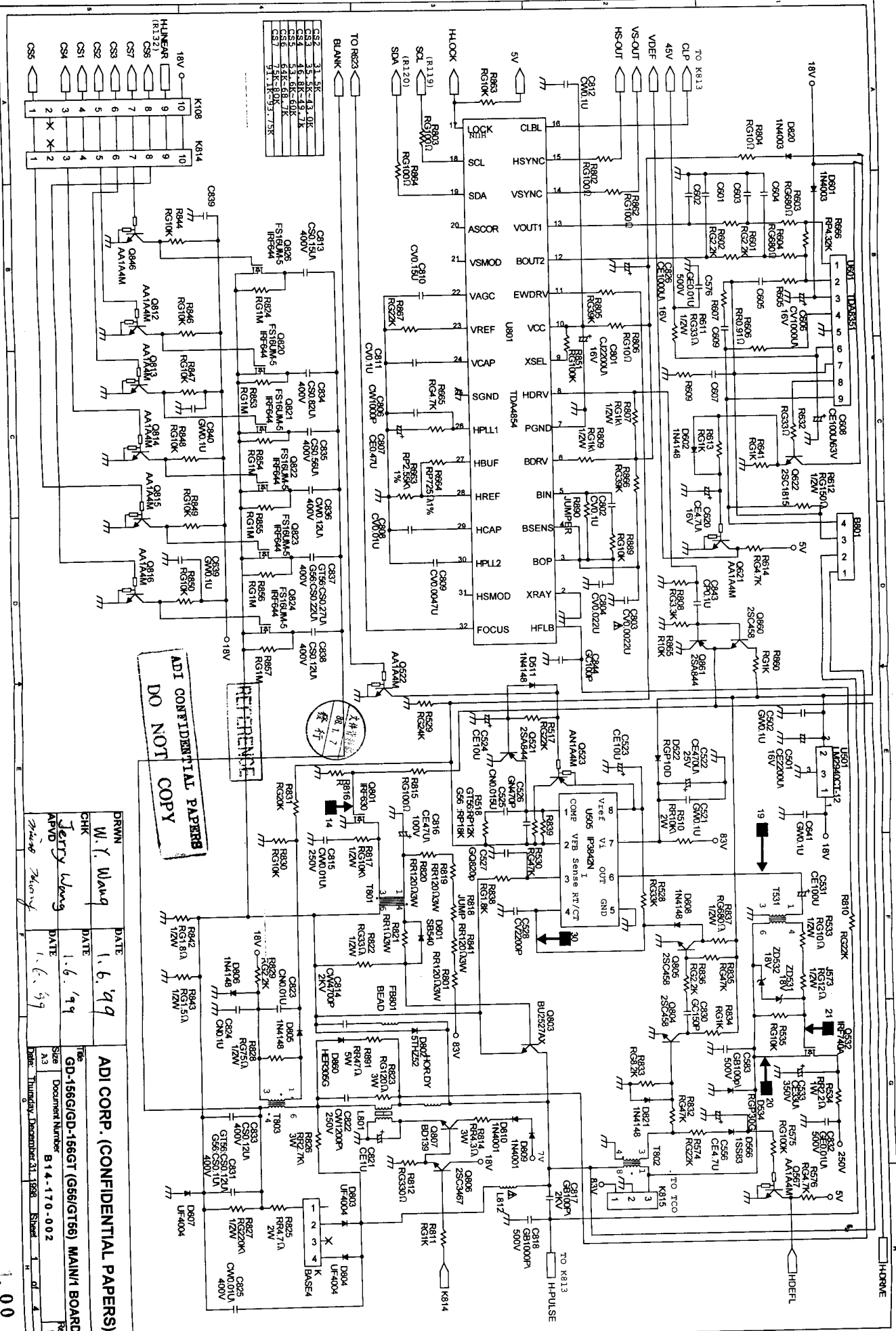

ADI CONFIDENTIAL PAPERS
DO NOT COPY

DRWN	W. Y. Wang	DATE	1.6.99
CHK	Jerry Wang	DATE	1.6.99
APVD	Thimo Thimo	DATE	1.6.99
ADI CORP. (CONFIDENTIAL PAPERS)			
Title: GD-156G/GD-156GT (G56/GT56) MAIN/ BOARD			
Size	A3	Document Number	B14-170-002
Rev	D	Date	Thursday, December 31, 1998
Page 1 of 4		Sheet	1 of 4

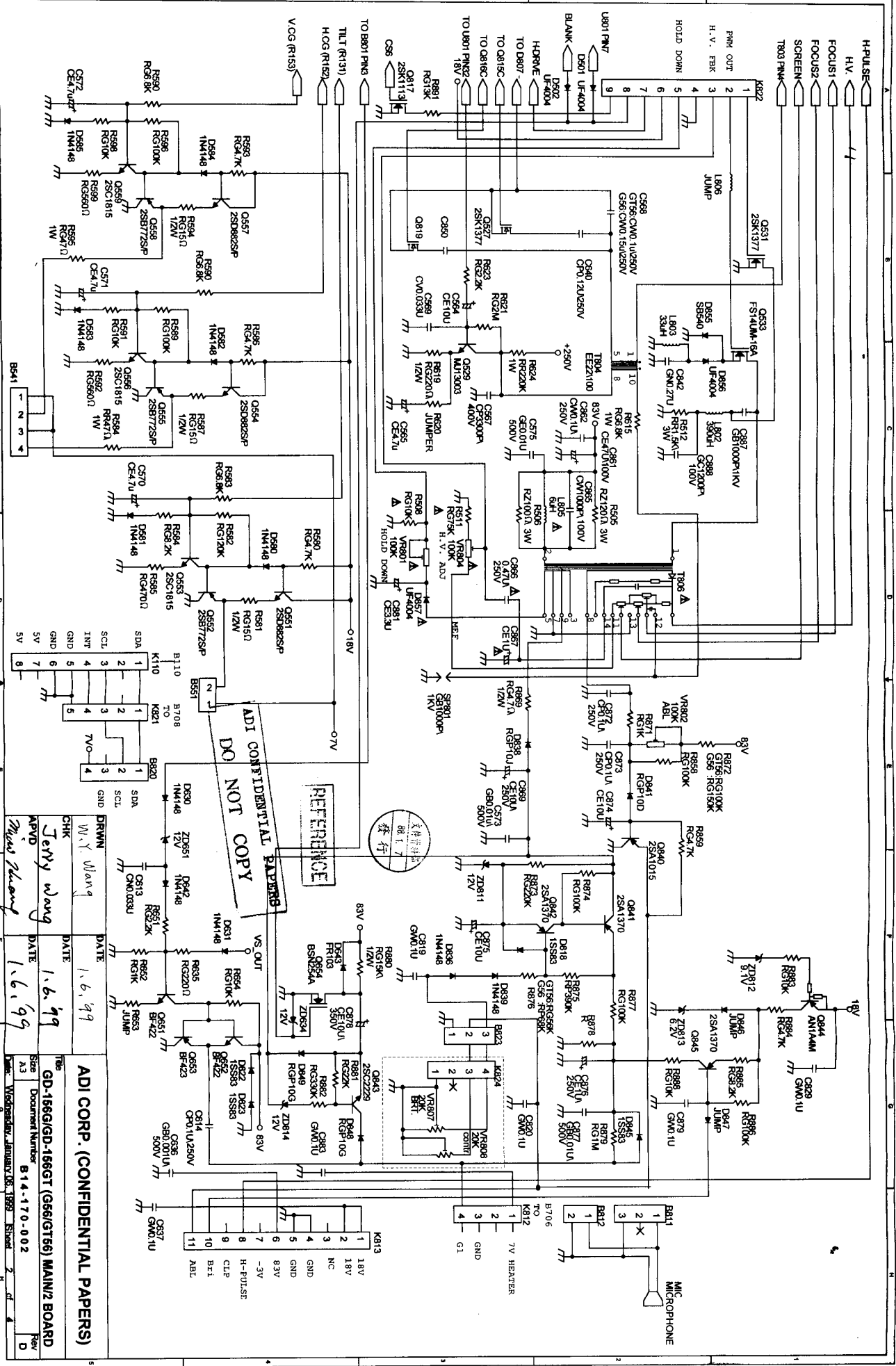

CHK	DATE	DATE	DATE
W. Y. Wang	1.6.99	1.6.99	1.6.99
Jerry Wang			
APVD	DATE	DATE	DATE
Miao Wang	1.6.99		

ADI CORP. (CONFIDENTIAL PAPERS)

GD-156G/GD-156GT (G56/GT56) MAINZ BOARD

Size A3 Document Number B14-170-002

Version: January 08, 1992 Sheet 2 of 4

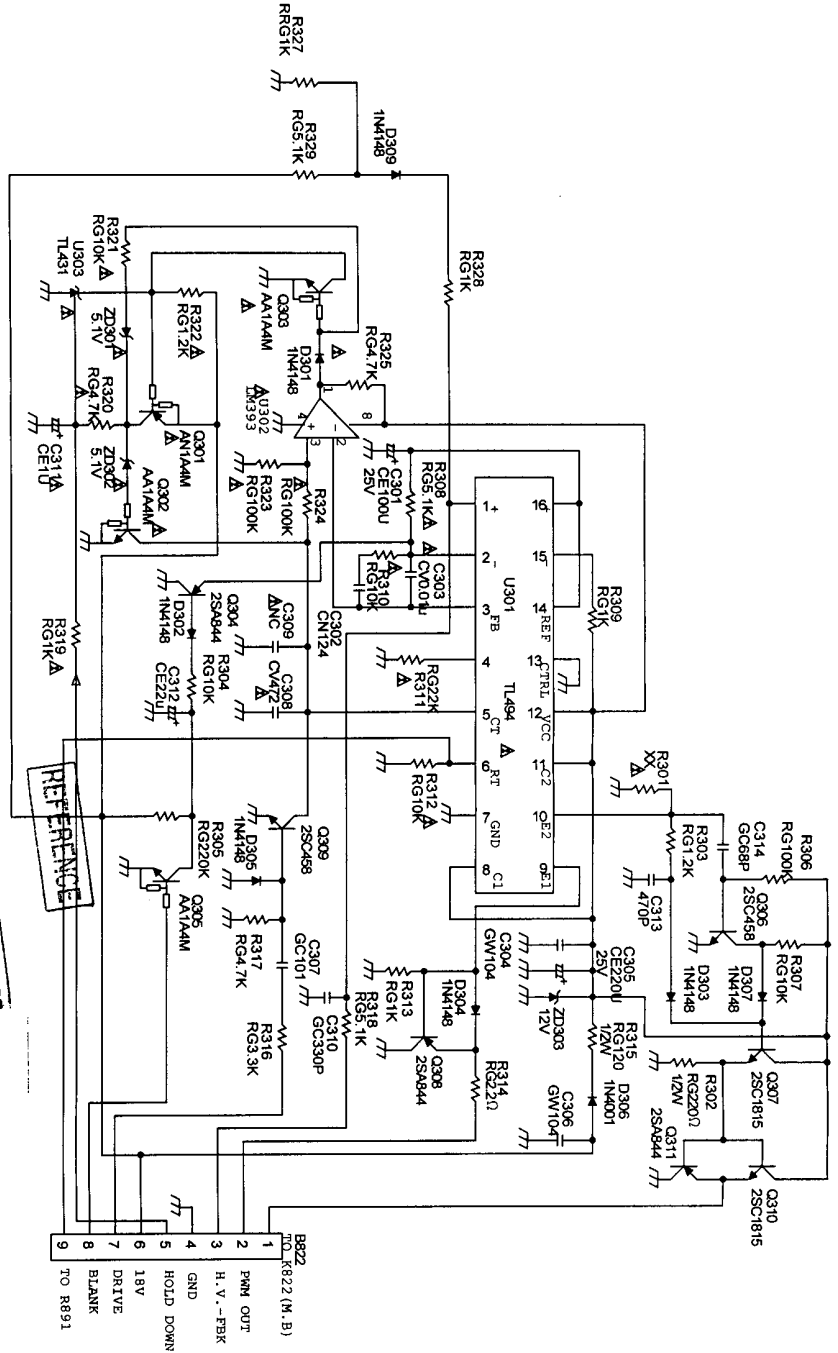

ADI CONFIDENTIAL PAPERS
DO NOT COPY

DRWN	W. Y. Wang	DATE	1. 6. '99
CHK	Jerry Wang	DATE	1. 6. '99
APVD	Thurs Zhang	DATE	1. 6. '99
ADI CORP. (CONFIDENTIAL PAPERS)			
The GD-156G/GD-156GT (G56/GT56) PWM BOARD			
Size	Document Number	B 14-170-002	
A3	Rev	D	
Printed	Tuesday, December 29, 1998	Sheet	3 of 4

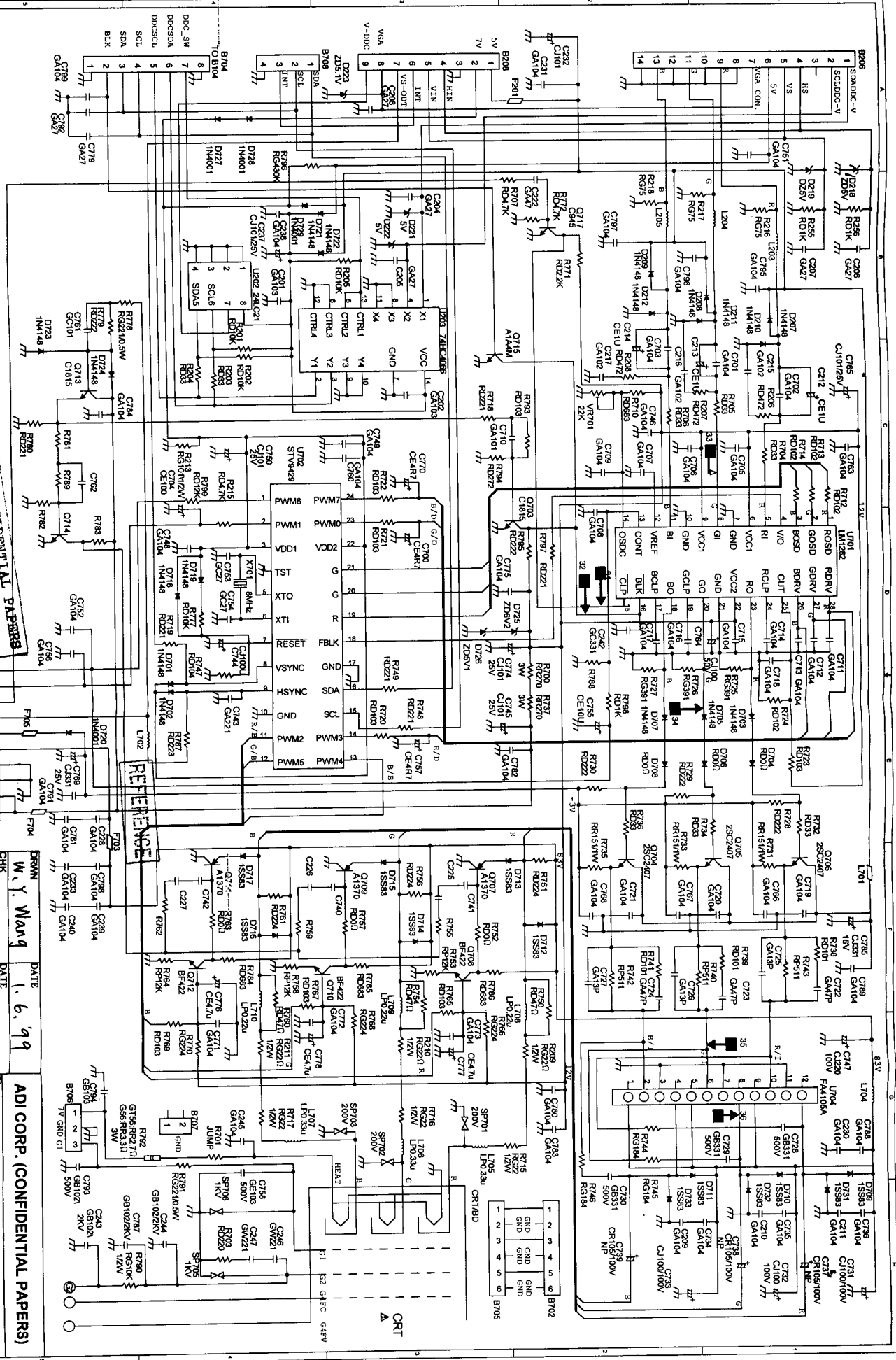

DO NOT CONFIDENTIAL PAPERS

W. Y. Wang
 DATE 1. 6. '99
 DATE 1. 6. '99

ADI CORP. (CONFIDENTIAL PAPERS)
 GD-156G/GD-156GT (G56/G156) CRT BOARD
 Document Number B14-170-002
 Revision 1
 Date Tuesday, December 21, 1988
 Sheet 4 of 4

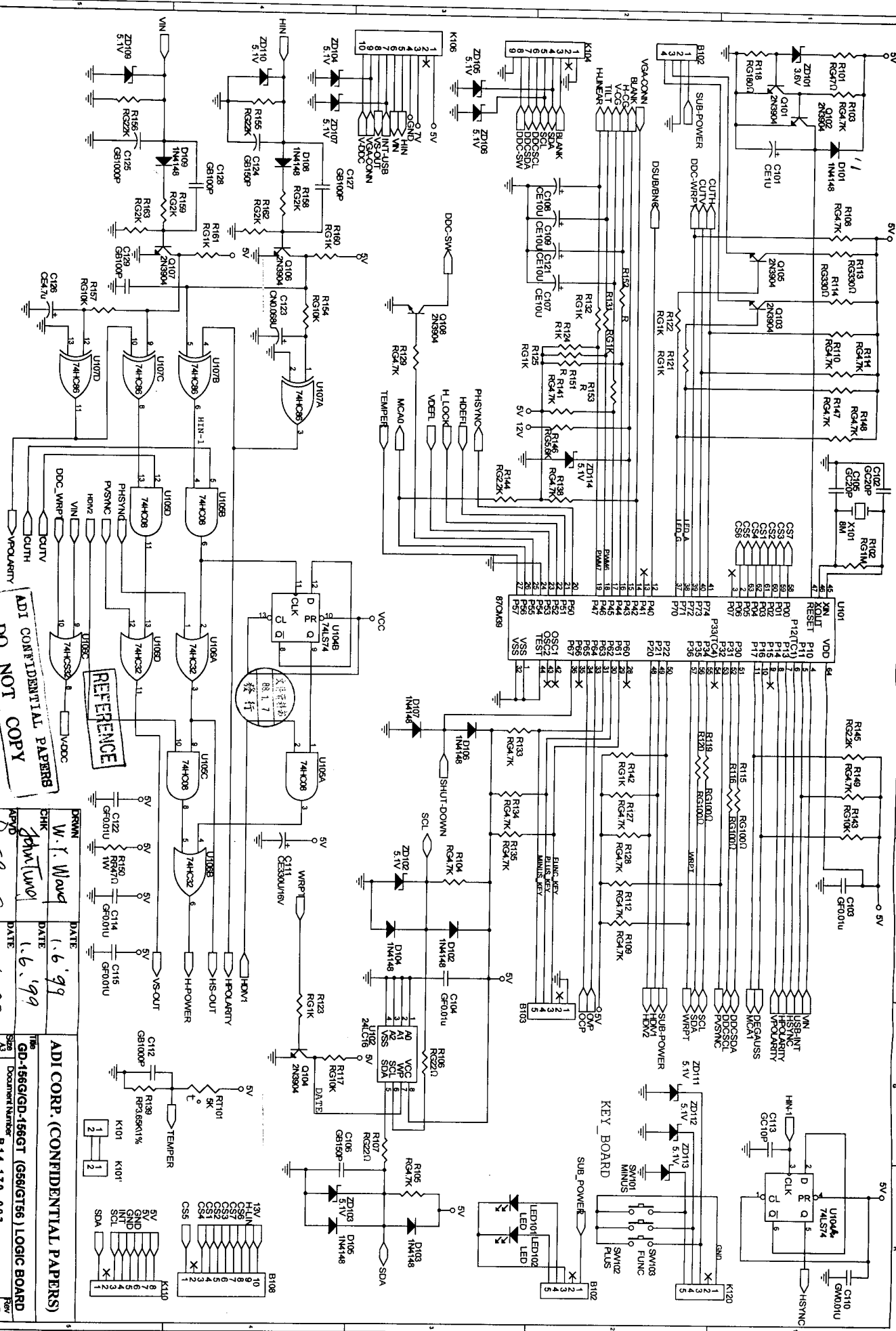

DO NOT CONFIDENTIAL PAPERS
 COPY

REFERENCE
 74HC08

W. Y. WANG
 1.6.99
 DATE
 1.6.99
 DATE
 1.6.99
 DATE

ADI CORP. (CONFIDENTIAL PAPERS)
 THE GD-156GGD-156GT (656GT/56) LOGIC BOARD
 Document Number B 14-170-003
 1 of 2

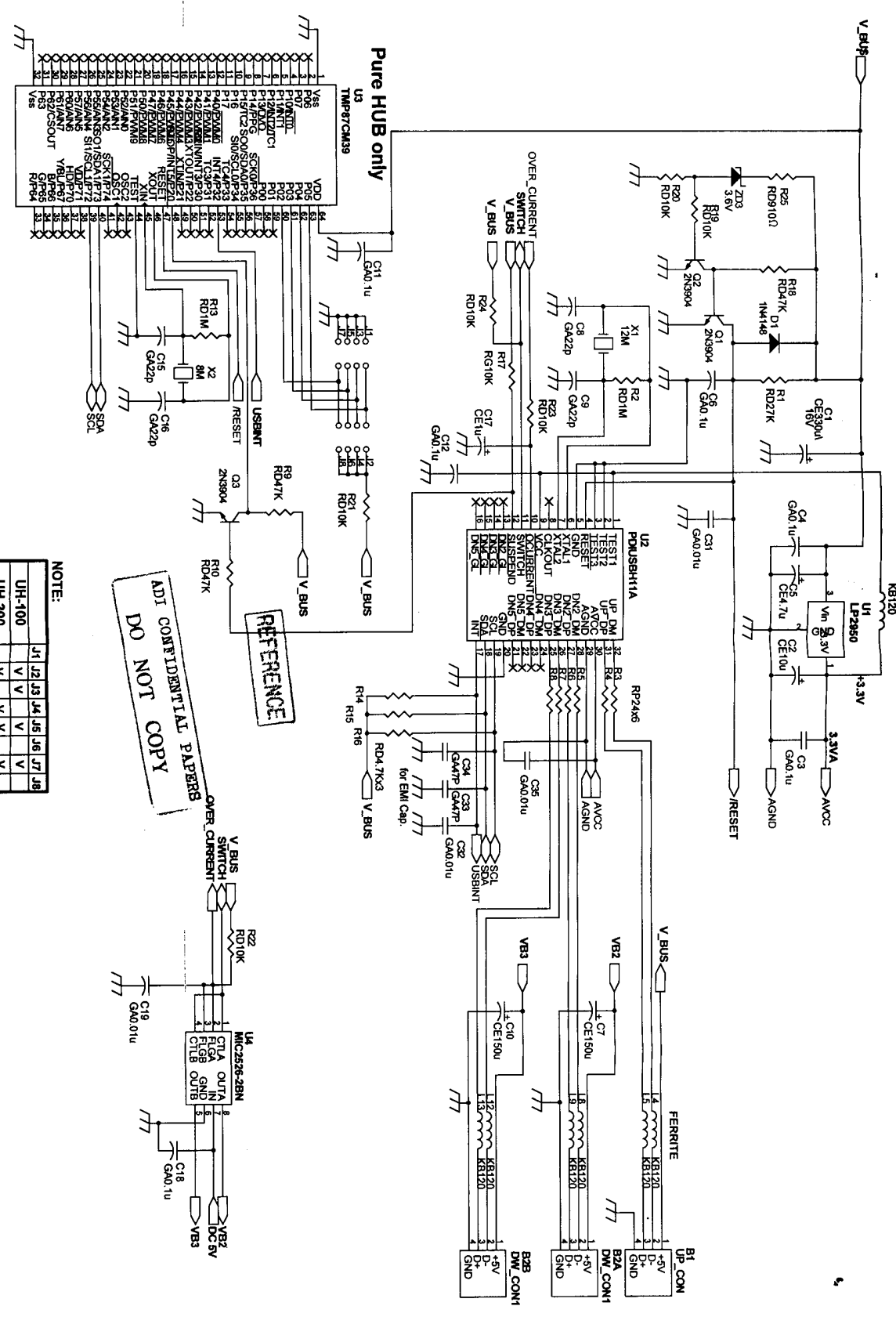

ADI CONFIDENTIAL PAPERS
DO NOT COPY

NOTE:

J1	J2	J3	J4	J5	J6	J7	J8
UH-100	V	V	V	V	V	V	V
UH-200	V	V	V	V	V	V	V
SM-996	V	V	V	V	V	V	V

DRWN	W. Y. MAW	DATE	1.6 '99
CHKD	John Tuay	DATE	1.6. '99
APPD	Borsan Gu	DATE	1/6/99

ADI CORP. (CONFIDENTIAL PAPERS)

The GD-156GGD-156GT (G56GT56) USB HUB BOARD

Doc# 156GGGT-156GT Rev 1.0

Document Number 814-170-005

Worcester, January 08, 1999

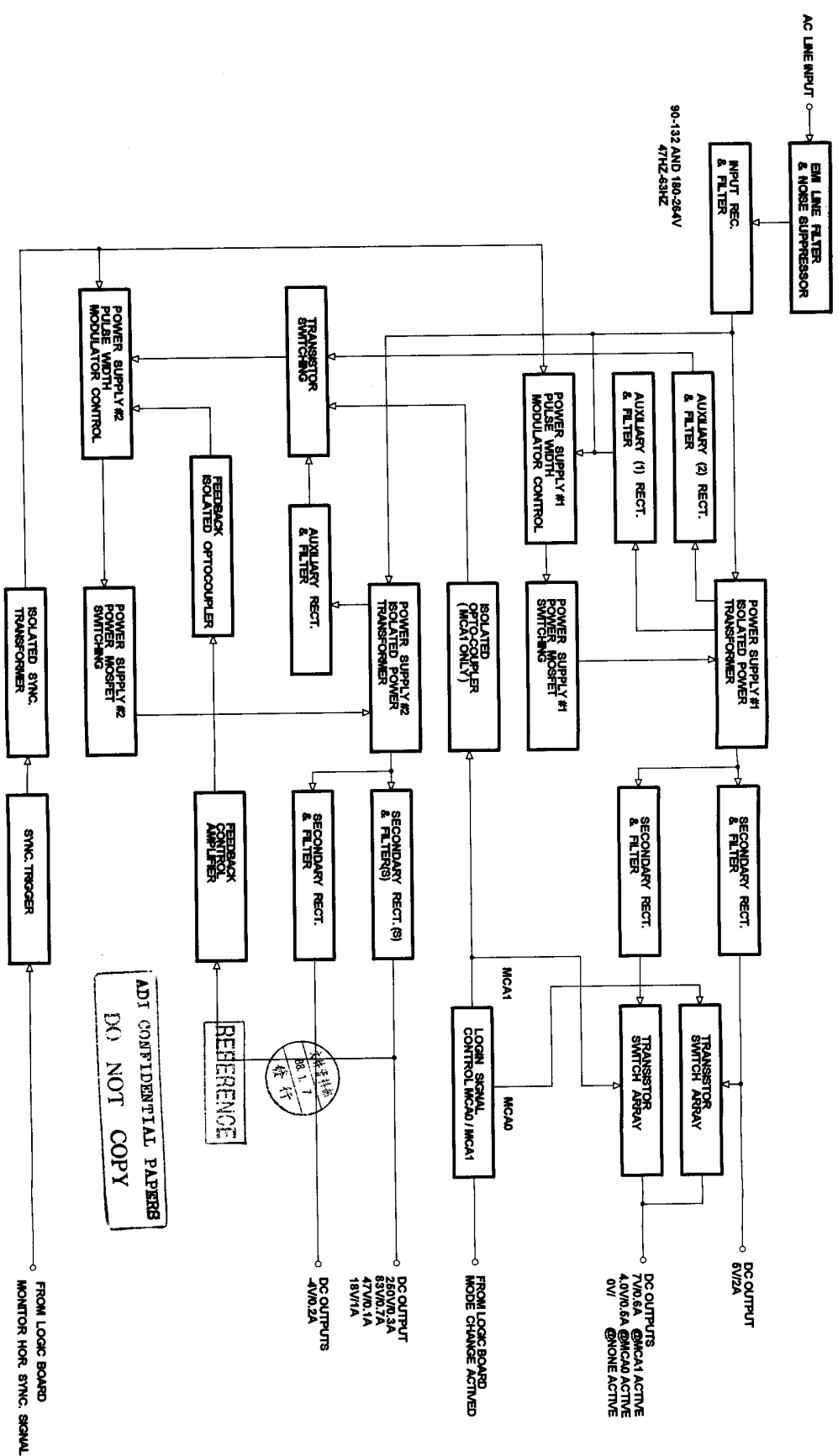

ADI CONFIDENTIAL PAPERS
DO NOT COPY

検査合格
No. 11
発行

DRAWN	DATE	DATE	DATE
W. Y. Wang	9.1.98	9.1.98	9.1.98
CHK	DATE	DATE	DATE
Edward Ho	9.1.98	9.1.98	9.1.98
REV	DATE	DATE	DATE
E.O. Lee	9.1.98	9.1.98	9.1.98

ADI CORP. (CONFIDENTIAL PAPERS)
The GD-186G (G&G) POWER BLOCK DIAGRAM
Document Number 814-170-001-B
Thursday, September 09, 1998 Sheet 1 of 1

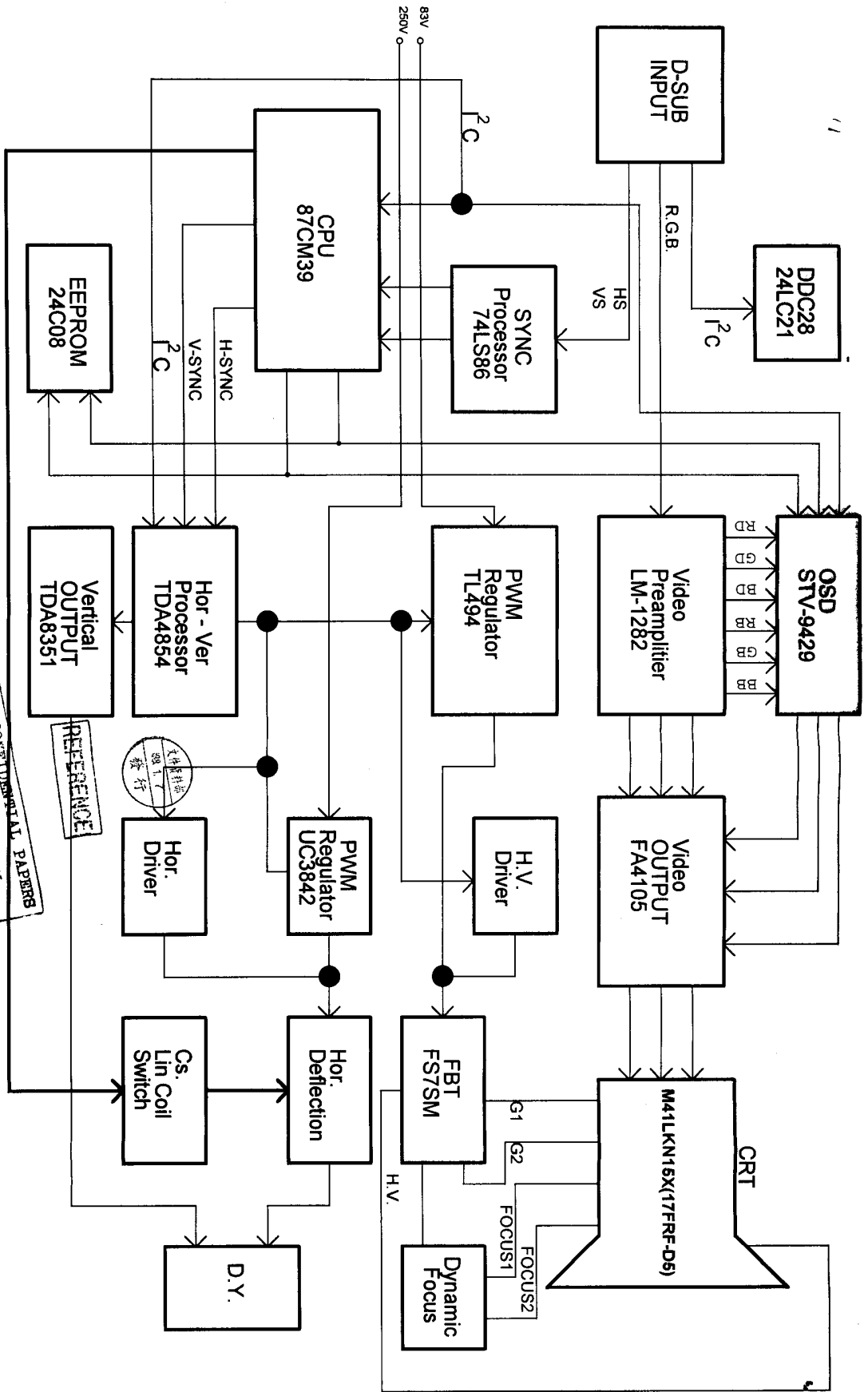

ADI CONFIDENTIAL PAPERS
DO NOT COPY

DRWN	DATE	ADJ CORP. (CONFIDENTIAL PAPERS)
W. Y. Wang	9.7.98	The GD-156G (G56) MONITOR BLOCK DIAGRAM GD-156G (G156)
D. L. Liu	9.8.98	
APVD	9.8.98	
Size	A3	Document Number B 14-170-002-B
Rev	A	Drawn Thursday, September 03, 1998 Sheet 1 of 1

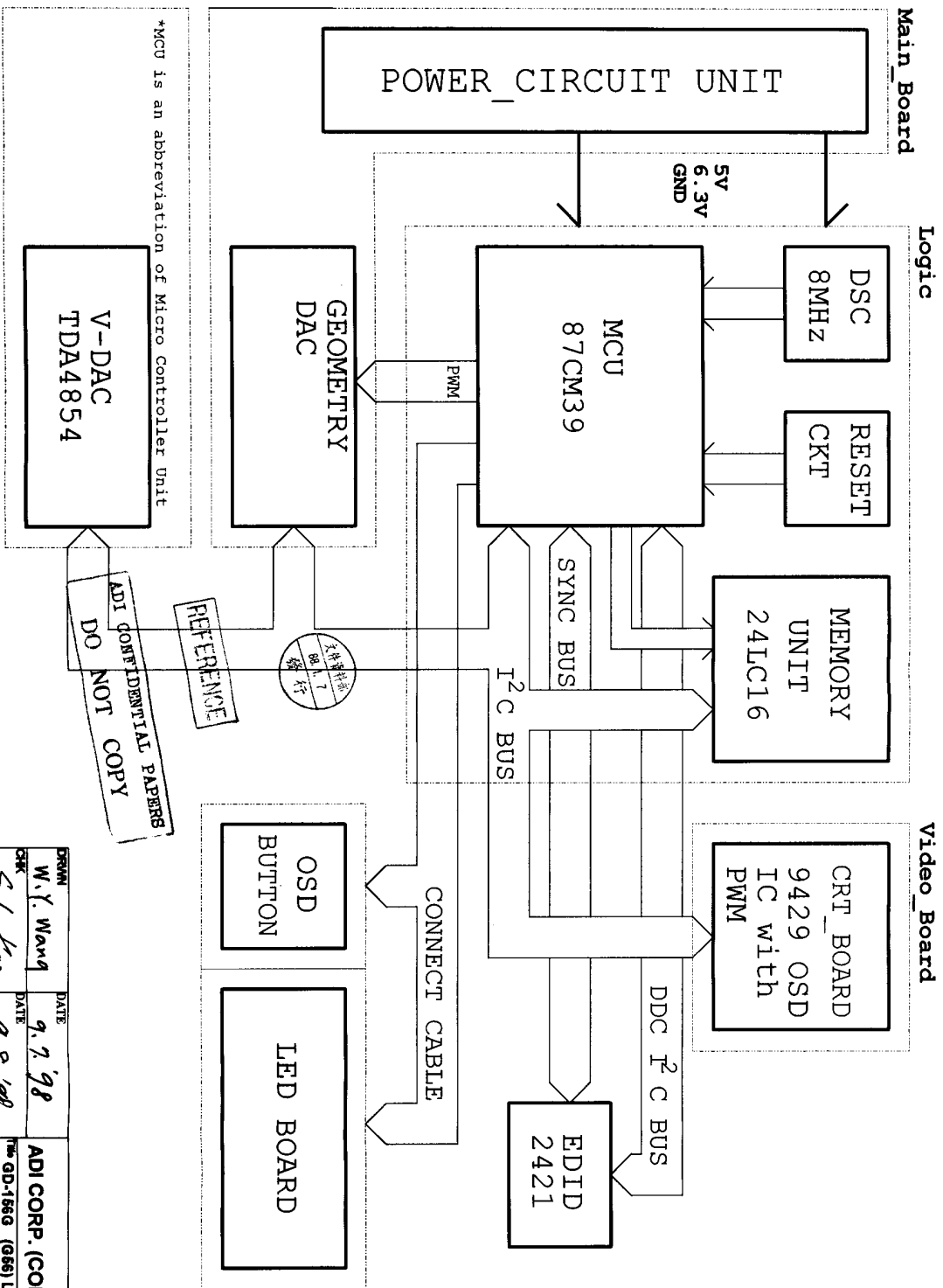

*MCU is an abbreviation of Micro Controller Unit

ADI CONFIDENTIAL PAPERS
DO NOT COPY



REFERENCE

DATE	DATE	DATE	DATE
9.7.98	9.8.98	9/8/98	
W.Y. Wang	S.L. Kao	Roxlan Gu	
DESIGNER	CHECKER	APPROVER	
ADI CORP. (CONFIDENTIAL PAPERS)			
The GD-156G (G56) LOGIC BLOCK DIAGRAM			
GT-156GT (G76)			
Document Number: B14-170-003-B			
REV	REV		
A	A		

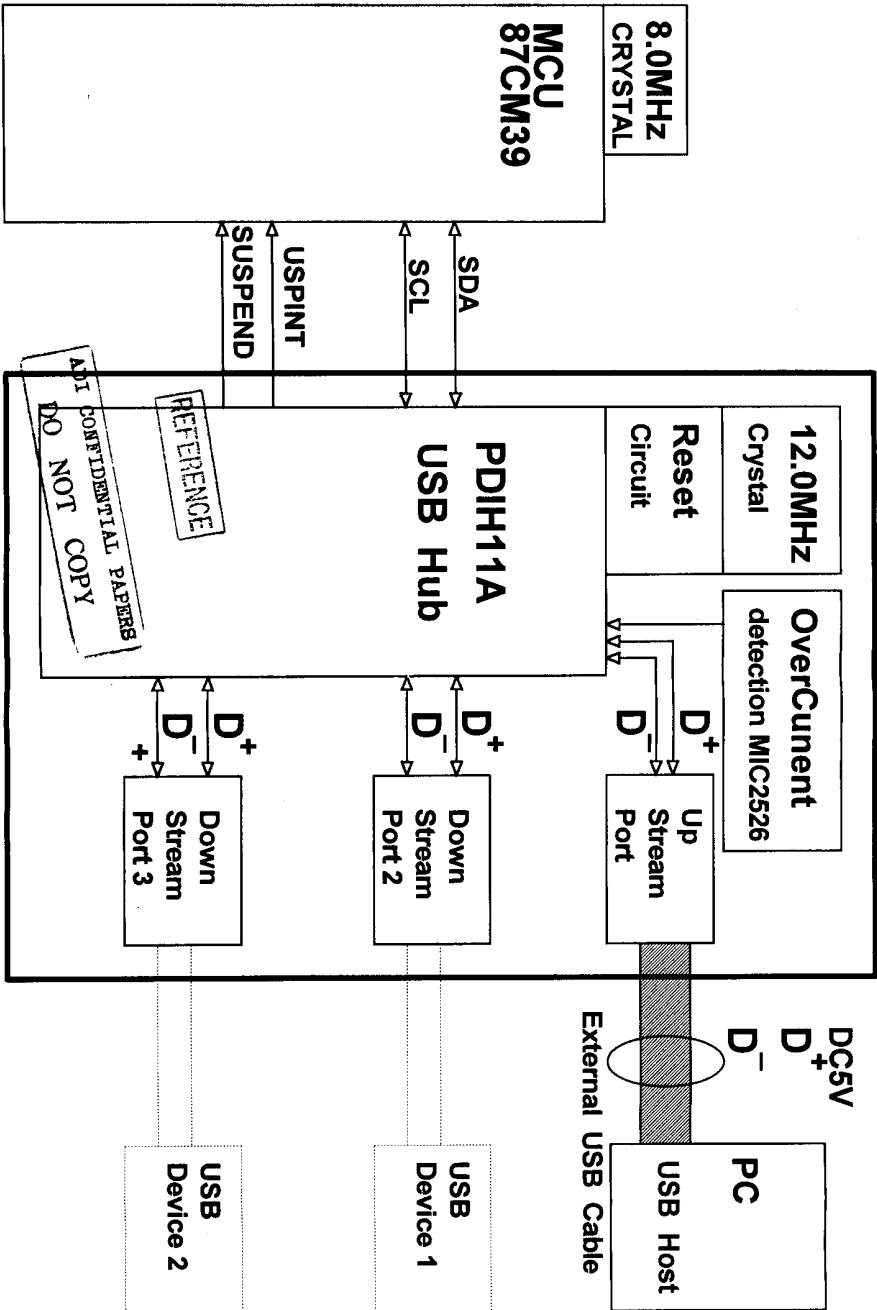

DRWN	DATE	APVD	DATE	Title	Size	Date	Rev
W. Y. Wang	9.7.98	S. L. Kuo	9.8.98	ADI CORP. (CONFIDENTIAL PAPERS)	A4	Monday, September 07, 1998	A
CHK	DATE	APVD	DATE	GD-156G (G56) USB HUB BLOCK DIAGRAM	A4		
				GT-156G1 (GT156)			
				Document Number			
				B 14-170-003-B			