



# Owner's Manual for Users MTXA300JA

## FCC Statement

This equipment has been tested and found to comply with the limits for a Class B digital device, pursuant to Part 15 of the FCC Rules. These limits are designed to provide reasonable protection against harmful interference in a residential installation. This equipment generates uses and can radiate radio frequency energy and, if not installed and used in accordance with the instructions, may cause harmful interference to radio communications. However, there is no guarantee that interference will not occur in a particular installation. If this equipment does cause harmful interference to radio or television reception, which can be determined by turning the equipment off and on, the user is encouraged to try to correct the interference by one or more of the following measures:

- Reorient or relocate the receiving antenna.
- Increase the separation between the equipment and receiver.
- Connect the equipment into an outlet on a circuit different from that to which the receiver is connected.
- Consult the dealer or an experienced radio/TV technician for help.

Changes or modifications not expressly approved by the party responsible for compliance could void the user's authority to operate the equipment.

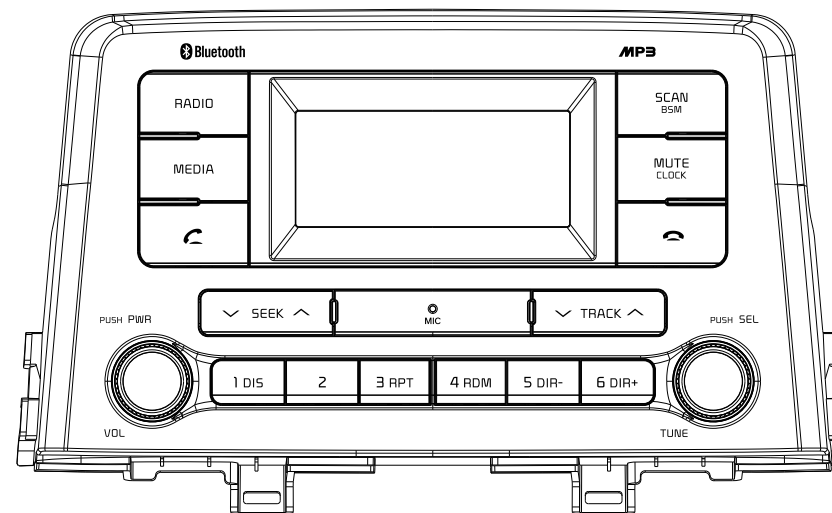

**MP3/USB/AUX/  
BLUETOOTH  
WITH FM/AM RADIO**



**!!!!!!!!!! ATTENTION !!!!!!!!!!**

Any Abnormal Operation or interference of frequency, the radio may get caused malfunction. If so, set RESET to the radio. Press and hold both 1DIS and 6DIR+ buttons about 5seconds simultaneously.





## Table of Contents

Bluetooth Summary .....	2
Identification of Controls and Functions .....	3
General Operating Instructions	
Power ON/OFF .....	4
Volume Control .....	4
I-VOL Set-up .....	4
Clock ON/OFF .....	4
Contrast Control .....	4
ID3 Language Selection .....	4
Traffic ON/OFF .....	4
Bass Control .....	5
Middle Control .....	5
Treble Control .....	5
Balance Control .....	5
Fader Control .....	5
Beep Control .....	6
MUTE .....	6
Clock Set-up .....	6
Media Selection .....	6
Radio Section Operation	
Band Selection .....	7
Area Selection .....	7
Manual Tuning .....	7
Auto Tuning .....	7
Station Preset .....	7
Presets Scan .....	7
Best Stations Memory .....	7
RDS Station .....	7
USB Operation	
Track UP/Down .....	8
Directory/File Search .....	8
Directory UP/Down .....	8
Track/Folder Scan .....	8
Track/Folder Repeat .....	8
Track/Folder Random .....	9
ID3 Display .....	9
Smart Phone Charge .....	9
iPod/iPhone Operation	
Supported Devices .....	10
iPod/iPhone Connect .....	10
Track Up/Down .....	10
Repeat Play .....	10
Random Play .....	10
AUX Input .....	11
Bluetooth Operation	
Bluetooth Special Notes .....	12
Pair with Bluetooth Device .....	13
Connect/Disconnect .....	13
Handsfree .....	14
Audio Transfer .....	14
Last Call Dial .....	14
Make Call by Phone .....	14
Make Call by Audio Unit .....	15
Make Call by Phone Book .....	15
Memory Phone Number .....	15
Recall Memorized Number .....	15
BT Music Play .....	15
BT Music ID3 display .....	15
Reset Function and Precautions .....	16
Specifications .....	17

**Before operating the unit,  
please read this manual  
thoroughly and retain it for  
future reference.**



## Bluetooth Summary

The BLUETOOTH features are subject to Bluetooth V2.1+EDR/Bluetooth 3.0

The Bluetooth technology is a wireless connection with a short range. That is, the cellular phone must be in between 30cm to 1 meter close to the car audio system (in the vehicle).

The integrated Bluetooth module in your audio unit allows the hands-free use of a phone via a Bluetooth connection. The cellular phone can remain in the bag or the glove compartment, while you have both hands free for steering.

The Bluetooth feature:

- A2DP, AVRCP, HS/HFP, PBAP
- Audio transfer between Audio Unit and Cellular Phone
- Noise Reduction
- Acoustic Echo cancellation
- Range up to ten meters cable free connection with Bluetooth devices
- Stereo audio play, pause, track up, track down, repeat play, random play
- PhoneBook
- Shows ID3

### IMPORTANT NOTES:

Keeping well your phone connection with Bluetooth technology, followings are recommended.

- Talking better close to the Audio Unit.
- Off road driving or opening window, higher speed (over 30Km) should be heard loud noise whilst phone conversation.
- Talking the call through out the speaker phone with other hand free kits must be heard loud noise or unclear talks.
- Air conditioner or heater may cause interruption noise to be heard.
- Cell phone are not too close to the audio unit to avoid GSM noise caused. (No closer than 30CM to the radio unit).
- Extreme weather may cause not to work the Bluetooth function in the audio unit.



## Identification of Controls and Functions

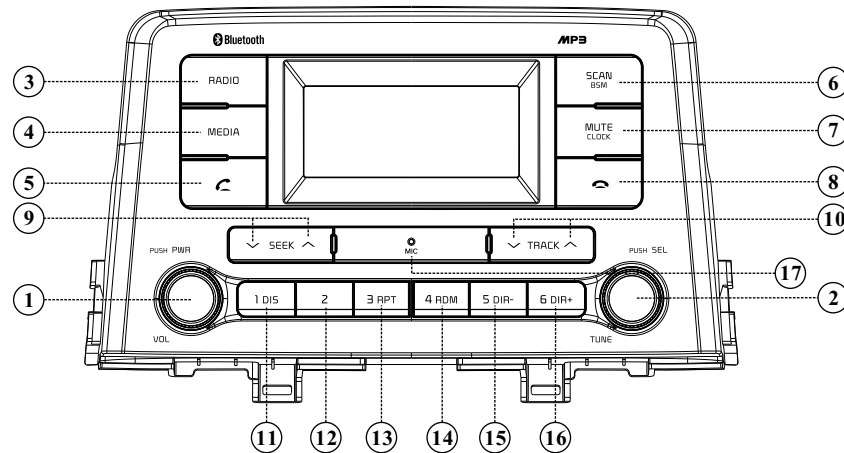

1. Power ON/OFF, Volume UP/DOWN button
2. Manual UP/DOWN Tuning, File Search, Enter button
3. Radio button (FM1 --> FM2 --> AM)
4. MEDIA button (USB --> AUX --> BT MUSIC)
5. Call & Pair button
6. SCAN/BSM button, Scan Play button
7. Audio Mute/Clock button
8. Call End button
9. Seek Up/Down button
10. Track Up/Down button
11. Station Preset 1, Display button
12. Station Preset 2 button
13. Station Preset 3, Repeat Play button
14. Station Preset 4, Random Play button
15. Station Preset 5, Directory Down button
16. Station Preset 6, Directory Up button
17. MIC Hole

## General Operating Instructions

### 1-1. Power On/Off button

Press Power button (1) to turn the unit on or off.

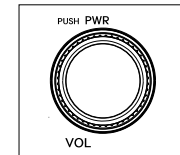

### 1-2. Volume Up/Down Control knob

Turn VOL knob (1) right to increase the volume level;

Turn VOL knob (1) left to decrease the volume.

After 5 seconds the display will return to the previous display mode.

### 1-3. System Setting MENU

With unit powered on, press and hold VOL button for 2s to enter system setting menu, then repeat short press this knob (1), LCD displays as follows:

I-VOL --> CLOCK --> CONTRAST --> ID3 LANGUAGE --> TRAFFIC

#### 1.3.1 Initial Volume Level Set Up

I-VOL is the volume level the unit will play at when next turned on. To adjust the I-VOL level, press and hold VOL button (1) for longer than 2 seconds. The current volume level displays on the display panel. Then turn button (1) right or left to set the volume level as the I-VOL level.

#### 1-3.2 Clock ON/OFF Control

To select Clock ON or OFF, press and hold VOL button (1) for longer than 2 seconds, then repeatedly press VOL button momentarily until CLOCK appears on the display panel. Then turn knob (1) right or left within 5 seconds to select CLOCK ON or OFF.

**Note:** Due to the time tolerance, the clock display on the Audio Unit and on the Car might have little difference.

#### 1-3.3 Contrast Control

To adjust the display Contrast, press and hold VOL button (1) for longer than 2 seconds, then repeatedly press VOL button momentarily until CONTRAST appears on the display panel. Then turn knob (1) right or left within 5 seconds to adjust level of contrast.

#### 1.3.4 ID3 Language Selection

To select the ID3 display language, press and hold VOL button (1) for longer than 2 seconds, then repeatedly press VOL button momentarily until ID3 appears on the display panel. Then turn knob (1) right or left within 5 seconds to select ID3 display language among English, Spanish, French, Arabic.

**Note:** The language selection only affect the ID3 display. All other display always in English.

#### 1.3.5 Traffic on/off Selection

The unit default at Traffic off. To select Traffic on, press and hold VOL button (1) for longer than 2 seconds, then repeatedly press VOL button momentarily until TRAFFIC appears on the display panel. Then turn knob (1) right or left within 5 seconds to select Traffic ON. With Traffic on selected, it will auto seek the Traffic stations with TA SEEK appears on the display panel.

## General Operating Instructions

### 2. Menu Selection

This button can adjust the sound effect and other things. Each time you press this button (2), LCD displays as follows:

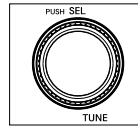

→ BASS --> MIDDLE --> TREBLE --> BALANCE --> FADER --> BEEP

At each setting, adjust the level by turning TUNE knob (2). When the last adjustment is made, the display will automatically return to previous display mode after 5 seconds.

#### 2-1. Bass Control

To adjust bass tone level, first select bass mode by pressing button (2). With BASS appears on the display panel, turn knob (2) right or left within 5 seconds to adjust bass level as desired. The bass level will be shown on the display panel from a minimum of BASS -7 to a maximum of BASS+7.

#### 2-2. Middle Control

To adjust middle tone level, first select middle mode by pressing button (2) repeatedly until MIDDLE appears on the display panel. Then turn knob (2) right or left within 5 seconds to adjust middle level as desired. The middle level will be shown on the display panel from a minimum of MIDDLE -7 to a maximum of MIDDLE +7.

#### 2-3. Treble Control

To adjust treble tone level, first select treble mode by pressing button (2) repeatedly until TREBLE appears on the display panel. Then turn knob (2) right or left within 5 seconds to adjust treble level as desired. The treble level will be shown on the display panel from a minimum of TREBLE -7 to a maximum of TREBLE +7.

#### 2-4. Balance Control

To adjust the left-right speaker balance, first select Balance mode by pressing button (2) repeatedly until BALANCE appears on the display panel. Then turn knob (2) right or left within 5 seconds to adjust balance as desired. The balance position will be shown on the display panel from BALANCE 10L (full left) to BALANCE 10R (full right).

#### 2-5. Fader Control

To adjust the front-rear speaker balance, first select Fader mode by pressing button (2) repeatedly until FADER appears on the display panel. Then turn knob (2) right or left within 5 seconds to adjust the front-rear speaker level as desired. The fader position will be shown on the display panel from FADER 10F (full front) to FADER 10R (full rear).

#### 2-6. Beep Control

To adjust the BEEP mode, first select the BEEP mode by pressing button (2) repeatedly until BEEP display panel. Then turn knob (2) left or right within 5 seconds to select BEEP OFF, BEEP 2ND, or BEEP ON.

BEEP 2ND: You will only hear the beep sound when the buttons are held down for more than 2 seconds.

BEEP OFF: You can not hear the sound beep when you press the buttons.

BEEP ON: You can hear the beep sound each time you press the buttons.

## General Operating Instructions

### 3. MUTE/CLOCK Control

Press MUTE button momentarily to mute sound output with MUTE ON displays on the LCD. Press the button again to cancel MUTE function and resume to normal playing mode.



With clock display on LCD, press and hold CLOCK button for more than 2 seconds, the Hour will blink, turn TUNE knob (2) right or left to adjust hour.

Simply press CLOCK again, the Minute will blink, turn TUNE knob to adjust minute. Once finished, press CLOCK to confirm.

### 4. MEDIA Selection

Press MEDIA button to switch between USB, AUX, BLUETOOTH.

**Note:** If there is no USB, AUX, Bluetooth Phone connected, it would display "NO MEDIA" when you press MEDIA button.

## Radio Section Operation

### 1. RADIO button

Each time you press button, LCD display as follows:

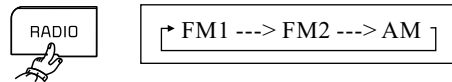

Note: Press and hold RADIO button for longer than 5 seconds, it will display the software version on display panel.

### 2. AREA Selection (Wrong AREA Selection may cause Poor Radio Frequency Receipt)

There are four areas for selection: USA, EUROPE, ASIA, LATIN AMERICA.

To select a area, press and hold related buttons at FM1 band for about 3 seconds.

RADIO + 1DIS buttons: USA      RADIO + 2 buttons: EUROPE

RADIO + 3RPT buttons: ASIA      RADIO + 4RDM buttons: LATIN AMERICA

### 3. Manual Tuning button

To manually tune to a radio station, simply turn encoder volume (2) left or right to increase or decrease the radio frequency.

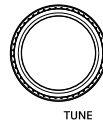

### 4. Auto Tuning button

To automatically select a radio station, simply press SEEK UP or Down button.



### 5. Station Preset buttons

In radio mode, pressing buttons will recall the radio stations that are memorized. To store desired stations into any of the 6 preset memories, in either the AM or FM bands, use the following procedure:

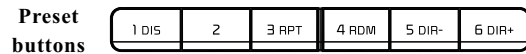

- Select the desired station.
- Press and hold one of the preset buttons for more than 2 seconds to store the current station into preset memory. Six stations can be memorized on each of FM1, FM2, and AM.

### 6. Presets Scan (PS) and Best Station Memory (BSM) button

Press BSM button momentarily to scan the 6 preset stations stored in the selected band. When you hear your desired station, press it again to listen to it.

Press BSM button for longer than 2 seconds to activate the Best Station Memory feature which will automatically scan and enter each station into memory.

Note: If you have already set the preset memories to your favorite stations, activating the BSM tuning feature will erase those stations and enter into the new ones. This BSM feature is most useful when traveling to a new area where you are not familiar with the local stations.

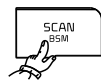

(Short push = Presets Scan)

(Long push = Best Station Memory)

### 7. RDS Station

It displays the Station Name if the received station was an RDS station.

## USB Operation

### 1. USB Playback

Get to USB mode, press MEDIA button momentarily or gently insert a USB stick. It will display USB Reading, then automatically begin to play the music files in the USB device.

If there is no music file in the USB device, it will convert back to previous mode after display NO FILE.

### 2. Track Up & Down button

Simply press TRACK UP to select the next track. Press Track Down button for the first time to back to the beginning of current track and press it within 5 seconds to select the previous track.



Press and hold the button to advance the track rapidly in the forward or backward direction.

### 3. MP3 Directory / File Searching

Button (2) is used to select a particular directory and file on a MP3 disc. Turn button (2) right or left to display the available directories. Press button (2) momentarily when the desired directory is displayed, then turn button (2) right or left again to display the tracks in that directory. Press button (2) to begin playback when the desired file is displayed.

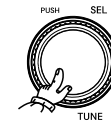

### 4. Directory Up & Down button

During MP3/WMA playback, simply press DIR- button to select the previous directory (if available on the MP3 disc); simply press DIR+ button to select the next directory (if available on the MP3 disc).

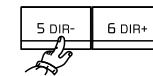

#### Note:

- If the MP3/WMA disc does not contain directories, it would play MP3/WMA tracks at 10- file when you press DIR- button, and play MP3/WMA tracks at 10+ file when you press DIR+ button.
- If the Disc does not contain any MP3 and WMA file, this function does not operate.

### 5. Track Scan Play (SCAN) button

- SCAN playback: simply press SCAN BSM to play the first 10s of each track.
- SCAN Folder: press and hold SCAN BSM for longer than 2s to scan play the tracks in current folder.
- SCAN off: simply press it again to cancel SCAN feature.



**Note:** Function of SCAN folder is only available for MP3/WMA playing mode.

### 6. Track Repeat Play (RPT) button



- REPEAT playback: simply press 3 RPT to play current track repeatedly.
- REPEAT Folder: press and hold 3 RPT for longer than 2s to repeat play the tracks in current folder.
- REPEAT off: simply press it again to cancel REPEAT feature.



**Note:** Function of REPEAT folder is only available for MP3/WMA playing mode.

## USB Operation

### 7. Track Random Play (RDM) button

- RANDOM playback: simply press  to play the tracks in random sequence.
- RANDOM Folder: press and hold  for longer than 2s to random play the tracks in current folder.
- RANDOM off: simply press it again to cancel RANDOM feature.

**Note:** Function of RANDOM folder is only available for MP3/WMA playing mode.

### 8. ID3 (DISP)

While playing a MP3 file, press DISP button to display ID3 information. Each time you push DISP button, the display changes to show the information as shown at right.

**Note:** If the MP3 disc does not have any ID3 information, the display will show NO ID3 on the display panel.

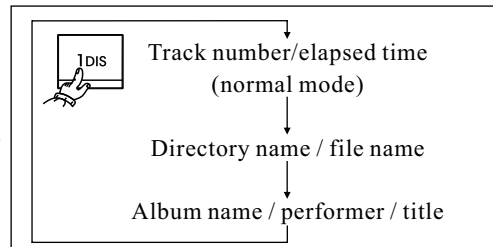

### \* USB Information and Notice

- 1) Playback FILE SYSTEM and Condition allowance.
  - FAT, FAT12, FAT16 and FAT32 in the file system.
  - V1.1, V2.2 and V2.3 in the TAG (ID3) Version.
- 2) Display up to 32 characters in the LCD display.
- 3) No support any of MULTI-CAED Reader.
- 4) No High Speed playback but only playing with normal full speed.

Note:

- DRM files in the USB may cause malfunction to playback in the radio unit.
- The temperature below -10 Celsius, the Audio Unit with USB hook up would be affected to play well.

### 9. Smart Phone Charge via USB jack

Simply plug your smart phone to the USB jack via USB data cable, it would begin to charge the phone with display USB Charge.

**WARNING: Do not try to play the music in your Android smart phone via USB mode, otherwise, the contents in your phone memory card might be lost. If already happened above situation, please simply disconnect and restart your same phone.**



## iPod/iPhone Operation



“Made for iPod”, and “Made for iPhone” mean that an electronic accessory has been designed to connect specifically to iPod, or iPhone, respectively, and has been certified by the developer to meet Apple performance standards. Apple is not responsible for the operation of this device or its compliance with safety and regulatory standards. Please note that the use of this accessory with iPod, or iPhone may affect wireless performance.

iPhone, iPod, iPod classic, iPod nano, and iPod touch are trademarks of Apple Inc., Registered in the U.S. and other countries.

Supported iPod/iPhone devices:

iPhone X	iPhone 8
iPhone 7 Plus	iPhone 7
iPhone SE	iPhone 6s Plus
iPhone 6s	iPhone 6 Plus
iPhone 6	iPhone 5s
iPhone 5c	iPhone 5
iPod touch (6th generation)	

### 1. Connect

Once you connect an iPod/iPhone to the USB input, it will read the files automatically. The track information displays on the screen once playback starts.

### 3. Track Up/Down

While iPod/iPhone is playing, simply press TRACK UP to select the next track.

Press Track Down button for the first time to back to the beginning of current track and press it again within 5 seconds to select the previous track.

Press and hold the button to go through the track rapidly until the button released.

### 3. Repeat play

This function allows you to play the current track repeatedly or play all tracks in your iPod/iPhone repeatedly by repeat press RPT button. RPT1 or PPT will appear on the display to show one track repeat or all tracks repeat.

### 4. Random play

This function allows you to play all tracks recorded on your iPod/iPhone in random sequence by pressing RDM button. RDM will appear on the display to show the random enabled.

Note: Please make sure the iPod/iPhone cable is connected correctly. And it is recommended to use the original cable for connection.

## AUX Input

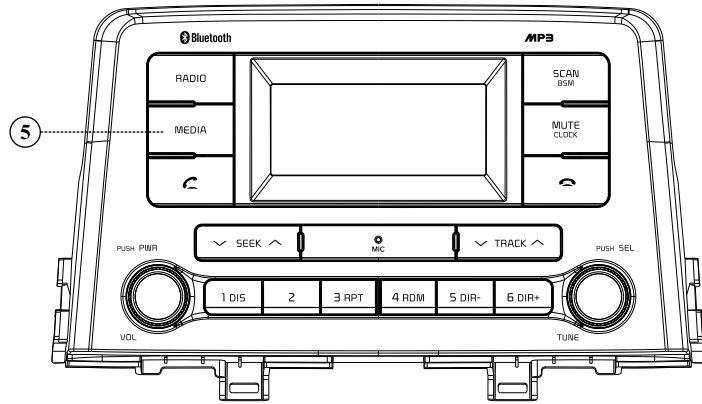

It is possible to connect your portable media player to the car audio system for playback of the audio tracks via the car speakers.

To get the best results when connecting the portable media to the car audio system, follow these steps:

- Use a 3.5mm stereo plug cable to connect the media player headphone socket at each end as follows.
- Adjust the portable media player to approximately 3/4 volume and start playback.
- Press the MEDIA button on the car audio unit to change into AUX mode.
- The volume and tone can now be adjusted on the Audio Unit to the desired level.

Note:

- The audio quality of your media player and the audio tracks on it may not be of the same sound quality as the car audio system is CD Player.
- If the sound of the media player is too low compared with the radio or CD, increase the volume of the player.
- If the sound of the media player is too loud and/or distorted, decrease the volume of the player.
- When in AUX mode, only the Volume, Bass, Middle, Treble, Mode functions of the car audio unit can be used.
- For technical information regarding the AUX input, refer to the specification section at the end of this operation manual.

## Bluetooth Operation

### Bluetooth Special Notes

1. Please confirm your Phone supports Bluetooth features before trying to use the Bluetooth function of this unit.
  - \* Some Bluetooth enabled devices may not function properly with the unit.
  - \* Motrex can not guarantee the compatibility of all mobile device together with unit.

### 2. Trouble Shooting Guide

Interference Frequency in the air sometimes interrupt your phone and block the radio to function properly.

Any troubles not work BLUETOOTH function on the radio with your phone, hereby recommended to following Trouble Shooting in sequence.

1. Key "ACC OFF" in your car.
2. Get to "Bluetooth Menu" on the Phone, so as to remove any pre-registered device list-up.
3. Take the battery in the Phone out for a while and get into again for "Power On".
4. Key "ACC ON" in your car and proceed "PAIRING" with the radio once again.

### 1. Using a Bluetooth wireless connection

- 1) Your Audio Unit supports Bluetooth wireless technology. You can set up a wireless link with Bluetooth cellular phone.
- 2) Keep PAIRING the cellular phone with Audio Unit in a few minutes as the phone are being switched on well enough.

**Note:**

- Since this Audio Unit is on standby to connect with your cellular phone via Bluetooth wireless technology, using this Audio Unit without running the engine can result battery drainage.
- This Audio Units phone call reception is on standby when ignition switch is set to ACC OFF or ON.
- The line-of-sight distance between this Audio Unit and your cellular phone must be 10 meters or less for sending and receiving voice and data via Bluetooth wireless technology. However the transmission distance may become shorter than the estimated distance depending on the environment in use.
- Digital Noise & Echo suppression system provides the best sound clarity with little or no distortion (Echo & side tone will happen depending on Cellular Phone or service network).
- To ensure the quality of calling, you should select a proper Bluetooth VR Level. This Audio Unit have already set with the best Bluetooth VR Level.

### 2. Pairing Your Audio Unit and Bluetooth Phone

This Audio Unit supports Hand Free profile, Headset profile, A2DP (Audio Advanced Distribution profile) and AVRCP (Audio Video Remote Control profile).

## Bluetooth Operation

### 3. Pairing in Hands Free modes

- 1) Press and Hold CALL button for 2 seconds to display Pairing on the display.
- 2) For the next procedure, go to 4. Cellular Phone Pairing Mode.
- 3) If you want to exit pairing mode, press CALL END button briefly while pairing, then it will show PAIR CLR on the display.
- 4) Once paired OK, it shows HF/AV and follows with the name of the paired device.

### 4. Cellular Phone Pairing mode

- 1) Browse your Cellular Phone menu and find the connectivity or Bluetooth connection section.
- 2) Select search for a new Handsfree device function and allow the phone to find the unit.
- 3) MORNING should appear on your Cellular Phone screen.
- 4) Press connect menu among the Handsfree option on your cellular phone.
- 5) Insert pin code 1234 if the Cellular Phone prompt for it.
- 6) The Cellular Phone should confirm that it has established a new paired connection.
- 7) Close the menu. The Pairing is now completed.
- 8) If the pairing failed, it appears PAIR FAIL on the display for 3 seconds.

#### Note:

- Each cellular phone type has distinct phone menu so you may need to refer to your manufactures instruction for the correct procedure on how to connect a new Bluetooth device.
- Please retry to the pairing instruction if MORNING does not appear on the cellular phone.
- Please select authorized, if there is authorized menu in the menu of Bluetooth connection in your cellular phone.
- Once the Bluetooth pairing is completed between your cellular phone and this Audio Unit, the both Units will be automatically recognized on its pairing and when you turn on the key in your car even though this Audio Unit is turned off.
- This Audio Unit can store up to 6 phones pairings. If the memory is full, the first stored paired phone will be deleted.
- The connecting priority will be given to the last connected Cellular Phone.
- If you want to change the connecting priority, try to connect this Audio Unit from the Cellular Phone.

### 5. Bluetooth connection and disconnection

- 1) To disconnect Bluetooth Link  
Press and hold CALL END button for 2 seconds until it shows DIS CON on display.
- 2) To connect Bluetooth Link  
Press CALL button briefly, it will show HF CONNECT just after it established a Bluetooth connection between this Audio Unit and the Cellular Phone; and follow with HF/AV when handsfree & AV profile connected.

#### Note:

- When your Cellular Phone battery is at low charge, the Bluetooth connection may occasionally be lost. To maintain good connectivity ensure that your Phone battery is adequately charged.

## Bluetooth Operation

- In case of failure of Bluetooth pairing:
  - \* Delete items in paired list on your phone.
  - \* Reset both phone by power off/on and the Audio Unit by ACC off/on.
- Connecting priority of Handsfree profile is higher than headset profile.
- The Headset mode does not support Caller ID, Reject call and Call Transfer.

### 6. Using the Audio Unit as a Handsfree Device

- 1) When there is an incoming call, it shows CALL FROM and follows with the Phone number on the display.
- 2) To accept call  
Press CALL button, it appears TALKING on the display.
- 3) To end call  
To end call, press CALL END button, it appears CALL OFF on the display.
- 4) To reject call  
To reject call, press button when ringing, it appears CALL OFF on the display.

#### Note:

- It displays phone number just before you answer the calling.
- It does not support to display talking time and contact while talking.
- It does not support three-way calling.

### 7. Audio Transfer Between the Audio Unit and Phone

The audio transfer function is for switching the talking from the Audio Unit to the connected phone for private conversation.

- 1) Press CALL button briefly during conversation, it appears CALL TRANS on the display. To switch back to the Audio Unit, press button again during private conversation, then it appears CALL TRANS on the display again.

#### Note:

- This function might cause disconnection of Bluetooth link in some phones, but do not worry about it, just press the CALL button during private conversation and switch back to the Audio Unit automatically.
- The quality of calling between Cellular Phone and Audio Unit is better than calling between one Audio Unit and another one.

### 8. Last Call number dialing

Press CALL button briefly, it appears CALL TO, then simply press CALL button once again, it would make the last call with phone number display on LCD.

#### Note:

- If you are using Samsung phone, then you may need to press the CALL button one more time to make the last call out. First press button shows phone contact list in your phone, then second press make the last call.

### 9. To Make a Call by Cellular Phone

- 1) With ignition on, and Audio Unit powered off, it will automatically power on when you make a call by Phone or when there is an incoming call. And once the talking finished, it power off by itself.
- 2) When you make a call process by Cellular Phone, it shows CALL TO and follows TALKING once the other side answers the call.
- 3) When you receive a call, it shows CALL FROM and follows the the phone number on the display.



## Bluetooth Operation

### 10. To Make a Call by Audio Unit

#### - To Select a Number from the Phone Book

With a phone paired OK, press and hold SEL button for more than 2 seconds, it would display NAME SCAN on the LCD, then simply turn TUNE knob to scroll display the phone book in the paired phone. At your desired number, press CALL button to make the call.

To exit the Phone Book, simply press SEL button once again at the NAME SCAN mode.

1. For some phones, you would receive a "phonebook access request" while pairing process. You should accept the request, otherwise, the phonebook would not allow to access via the Audio Unit.
2. For some phones, it might scan the Phone Book slowly. It depends to the run speed of the paired phone.



#### - To Store the Phone Number into the Audio Unit

Simply press the numeral button 1~6 while Bluetooth talking to store the current phone number into the corresponding button.

#### - To Recall the Stored Phone Number

With a phone paired OK, press CALL button, it would display CALL TO on the display, then press one of the numeral buttons to dial the number which stored in the corresponding button.

### 11. To Play the Bluetooth Music

The Audio Unit supports A2DP (Audio Advanced Distribution Profile) and AVRCP (Audio Video Remote Control Profile), and both profiles are available to listen music at the Audio Unit via cellular phone which is supporting the two profiles above.

- 1) With a phone paired OK, press MEDIA button on the Audio Unit to change to BLUETOOTH mode, it would begin to play the music files in the paired Phone.

Note: For some phones, it might need to activate music play via the phone first.

- 2) During BT MUSIC playing, you could operate following functions on the Audio Unit or via the paired Phone.

Next Track: Press Track up button.

Previous Track: Press Track down button.

Note: if the track elapse time is over 5 seconds, then need to press track down twice to select the previous track. First press to go back to the beginning of the track, press it again within 5s to go to previous track.)

MUTE: Press MUTE button mute sound output; press it again to resume.

Play/Pause: Press CALL END button to pause the music; press it again to resume.

- 3) ID3 Tag display

This Audio Unit could scroll display the ID3 of the songs while BT MUSIC playing. (ID3 tag: Title/Artist/Album).



The ID3 could only be displayed when the paired phone supports AVRCP1.4 profile.

## Reset and Precautions

### 1. Reset function

Interfere noise or abnormal compressed files in the MP3 disc or USB instrument may cause extraordinary operation (or unit frozen/locking up). It's strongly recommended to use appropriate Disc play or USB Storage not cause any malfunction to the audio unit. In the unlikely event that the player fails to operate correctly, try out to Reset unit by any of following two methods.

- I. Press and hold  simultaneously for about 5 seconds.

- II. Take out the Fuse for the Audio System in the vehicle once and then plug again.

**Note:** It will be necessary to re-enter the radio preset memories as these will have been erased when the microprocessor was reset. After resetting the player, ensure all functions are operation correctly.

### 2. Precautions

When the inside of the car is very cold and the player is used soon after switching on the heater, moisture may form on the disc or the optical parts of the player and proper playback may not be possible. If moisture forms on the optical parts of the player, do not use the player for about one hour. The condensation will disappear naturally allowing normal operation.

## *Specifications*

---

Operation Voltage ----- 12 volts DC, negative  
Input Current ----- 10A  
Output Power ----- 160 watts maximum  
(40 watts x 4 channels)  
Output Impedance ----- compatible with 4 ~8 ohm speakers  
Tuning Range ----- AM: 530 ~ 1,710 KHz. (10KHz step)  
FM: 87.5 ~107.9 MHz. (100KHz step)  
Sensitivity ----- AM: 33 dBu  
FM: 6 dBu  
FM Stereo Separation ----- 30 dB  
USB Frequency Response ----- 20 ~20,000 Hz  
USB S/N Ratio ----- 63 dB  
USB Channel Separation ----- 50 dB  
AUX Input Sensitivity ----- 2V (VOLUME STEP 20)  
400 and 800mV@10K ohm  
Bluetooth ----- Version 3.0  
- Output Power ----- +4 dBm Max  
- Profile ----- Advanced Audio Distribution Profile  
Audio/Video Remote Control Profile  
Hands-Free Profile  
Headset Profile