

- Part 15.205(a): Restricted band of operation

| MHz | MHz | MHz | MHz | GHz | GHz |
|---------------------|-----------------------|-------------------------|-------------------|--------------|---------------|
| 0.009 ~ 0.110 | 8.414 25 ~ 8.414 75 | 108 ~ 121.94 | 1 300 ~ 1 427 | 4.5 ~ 5.15 | 14.47 ~ 14.5 |
| 0.495 ~ 0.505 | 12.29 ~ 12.293 | 123 ~ 138 | 1 435 ~ 1 626.5 | 5.35 ~ 5.46 | 15.35 ~ 16.2 |
| 2.173 5 ~ 2.190 5 | 12.519 75 ~ 12.520 25 | 149.9 ~ 150.05 | 1 645.5 ~ 1 646.5 | 7.25 ~ 7.75 | 17.7 ~ 21.4 |
| 4.125 ~ 4.128 | 12.576 75 ~ 12.577 25 | 156.524 75 ~ 156.525 25 | 1 660 ~ 1 710 | 8.025 ~ 8.5 | 22.01 ~ 23.12 |
| 4.177 25 ~ 4.177 75 | 13.36 ~ 13.41 | 156.7 ~ 156.9 | 1 718.8 ~ 1 722.2 | 9.0 ~ 9.2 | 23.6 ~ 24.0 |
| 4.207 25 ~ 4.207 75 | 16.42 ~ 16.423 | 162.012 5 ~ 167.17 | 2 200 ~ 2 300 | 9.3 ~ 9.5 | 31.2 ~ 31.8 |
| 6.215 ~ 6.218 | 16.694 75 ~ 16.695 25 | 167.72 ~ 173.2 | 2 310 ~ 2 390 | 10.6 ~ 12.7 | 36.43 ~ 36.5 |
| 6.267 75 ~ 6.268 25 | 16.804 25 ~ 16.804 75 | 240 ~ 285 | 2 483.5 ~ 2 500 | 13.25 ~ 13.4 | Above 38.6 |
| 6.311 75 ~ 6.312 25 | 25.5 ~ 25.67 | 322 ~ 335.4 | 2 655 ~ 2 900 | | |
| 8.291 ~ 8.294 | 37.5 ~ 38.25 | 399.90 ~ 410 | 3 260 ~ 3 267 | | |
| 8.362 ~ 8.366 | 73 ~ 74.6 | 608 ~ 614 | 3 332 ~ 3 339 | | |
| 8.376 25 ~ 8.386 75 | 74.8 ~ 75.2 | 960 ~ 1 240 | 3 345.8 ~ 3 358 | | |
| | | | 3 600 ~ 4 400 | | |

9.3. Test Procedures

9.3.1. Test Procedures for Unwanted Emissions(Radiated)

1. The EUT is placed on a non-conductive table. For emission measurements at or below 1 GHz, the table height is 80 cm. For emission measurements above 1 GHz, the table height is 1.5 m. The table was rotated 360 degrees to determine the position of the highest radiation.
2. During performing radiated emission below 1 GHz, the EUT was set 3 meters away from the interference receiving antenna, which was mounted on the top of a variable-height antenna tower. During performing radiated emission above 1 GHz, the EUT was set 1 or 3 meter away from the interference-receiving antenna.
3. For measurements above 1 GHz absorbers are placed on the floor between the turn table and the antenna mast in such a way so as to maximize the reduction of reflections. For measurements below 1 GHz, the absorbers are removed.
4. The antenna is a broadband antenna, and its height is varied from one meter to four meters above the ground to determine the maximum value of the field strength. Both horizontal and vertical polarizations of the antenna are set to make the measurement.
5. For each suspected emission, the EUT was arranged to its worst case and then the antenna was tuned to heights from 1 meter to 4 meters and the table was turned from 0 degrees to 360 degrees to find the maximum reading.
6. The test-receiver system was set to Peak Detect Function and Specified Bandwidth with Maximum Hold Mode.
7. If the emission level of the EUT in peak mode was 10 dB lower than the limit specified, then testing could be stopped and the peak values of the EUT would be reported. Otherwise the emissions that did not have 10 dB margin would be re-tested one by one using peak, quasi-peak or average method as specified and then reported in a data sheet.

Measurement Instrument Setting

- Frequencies less than or equal to 1 000 MHz
The resolution bandwidth and video bandwidth of test receiver/spectrum analyzer is 120 kHz for Quasi-peak detection (QP) at frequency below 1 GHz.
- Frequencies above 1 000 MHz
The resolution bandwidth and video bandwidth of test receiver/spectrum analyzer is 1 MHz for Peak detection and frequency above 1 GHz.
The result of Average measurement is calculated using PK result and duty correction factor.

9.3.2. Test Procedures for Unwanted Emissions(Conducted)

1. The transmitter output was connected to the spectrum analyzer.
2. The **reference level** of the fundamental frequency was measured with the spectrum analyzer using RBW = 100 kHz, VBW = 300 kHz.
3. The conducted spurious emission was tested each ranges were set as below.

Frequency range : 9 kHz ~ 30 MHz

RBW = 100 kHz, VBW = 300 kHz, SWEEP TIME = AUTO, DETECTOR = PEAK, TRACE = MAX HOLD, SWEEP POINT : 40 001

Frequency range : 30 MHz ~ 10 GHz, 10 GHz ~ 25 GHz

RBW = 1 MHz, VBW = 3 MHz, SWEEP TIME = AUTO, DETECTOR = PEAK, TRACE = MAX HOLD, SWEEP POINT : 40 001

LIMIT LINE = 20 dB below of the reference level of above measurement procedure Step 2. (RBW = 100 kHz, VBW = 300 kHz)

If the emission level with above setting was close to the limit (ie, less than 3 dB margin) then zoom scan is required using RBW = 100 kHz, VBW = 300 kHz, SPAN = 100 MHz and BINS = 2 001 to get accurate emission level within 100 kHz BW.

Also the path loss for conducted measurement setup was used as described on the Appendix I of this test report.

9.4. Test Results

9.4.1. Unwanted Emissions(Radiated)

▪ Test Notes.

- The radiated emissions were investigated 9 kHz to 25 GHz. And no other spurious and harmonic emissions were found below listed frequencies.
- Information of Distance Correction Factor
For finding emissions, measurements may be performed at a distance closer than that specified in the regulations. In this case, the distance correction factor is applied to the result.
- Calculation of distance factor
At frequencies below 30 MHz = $40 \log(\text{tested distance} / \text{specified distance})$
At frequencies at or above 30 MHz = $20 \log(\text{tested distance} / \text{specified distance})$
When distance factor is "N/A", the measurements were performed at the specified distance and distance factor is not applied.
- DCCF Calculation. (DCCF = Duty Cycle Correction Factor)
- Time to cycle through all channels = $\Delta t = T [\text{ms}] \times 20$ minimum hopping channels , where T = pulse width = **2.88 ms**
- $100 \text{ ms} / \Delta t [\text{ms}] = H \rightarrow$ Round up to next highest integer, to account for worst case, $H' = 100 / (2.88 \times 20) = 1.74 \approx 2$
- The Worst Case Dwell Time = $T [\text{ms}] \times H' = 2.88 \text{ ms} \times 2 = 5.76 \text{ ms}$
- $\text{DCCF} = 20 \text{ Log}(\text{The Worst Case Dwell Time} / 100 \text{ ms}) \text{ dB} = 20 \text{ log}(5.76 / 100) = -24.79 \text{ dB}$
- Sample Calculation.
 $\text{Margin} = \text{Limit} - \text{Result} / \text{Result} = \text{Reading} + \text{TF} + \text{DCCF} + \text{DCF} / \text{TF} = \text{AF} + \text{CL} + \text{HL} + \text{AL} - \text{AG}$
Where, TF = Total Factor, AF = Antenna Factor, CL = Cable Loss, AG = Amplifier Gain, HL = High pass filter Loss, AL = Attenuator Loss, DCCF = Duty Cycle Correction Factor, DCF = Distance Correction Factor

9 kHz ~ 25 GHz Data (Modulation : GFSK)

▪ Lowest Channel

| Frequency (MHz) | ANT Pol | EUT Position (Axis) | Detector Mode | Reading (dBuV) | TF (dB/m) | DCCF (dB) | DCF (dB) | Result (dBuV/m) | Limit (dBuV/m) | Margin (dB) |
|-----------------|---------|---------------------|---------------|----------------|-----------|-----------|----------|-----------------|----------------|-------------|
| 2 386.15 | V | X | PK | 50.52 | 4.46 | N/A | N/A | 54.98 | 74.00 | 19.02 |
| 2 386.15 | V | X | AV | 50.52 | 4.46 | -24.79 | N/A | 30.19 | 54.00 | 23.81 |
| 4 804.06 | H | X | PK | 50.77 | 1.64 | N/A | N/A | 52.41 | 74.00 | 21.59 |
| 4 804.06 | H | X | AV | 50.77 | 1.64 | -24.79 | N/A | 27.62 | 54.00 | 26.38 |

▪ Middle Channel

| Frequency (MHz) | ANT Pol | EUT Position (Axis) | Detector Mode | Reading (dBuV) | TF (dB/m) | DCCF (dB) | DCF (dB) | Result (dBuV/m) | Limit (dBuV/m) | Margin (dB) |
|-----------------|---------|---------------------|---------------|----------------|-----------|-----------|----------|-----------------|----------------|-------------|
| 4 882.24 | H | X | PK | 49.27 | 1.90 | N/A | N/A | 51.17 | 74.00 | 22.83 |
| 4 882.24 | H | X | AV | 49.27 | 1.90 | -24.79 | N/A | 26.38 | 54.00 | 27.62 |

▪ Highest Channel

| Frequency (MHz) | ANT Pol | EUT Position (Axis) | Detector Mode | Reading (dBuV) | TF (dB/m) | DCCF (dB) | DCF (dB) | Result (dBuV/m) | Limit (dBuV/m) | Margin (dB) |
|-----------------|---------|---------------------|---------------|----------------|-----------|-----------|----------|-----------------|----------------|-------------|
| 2 484.75 | V | X | PK | 50.01 | 5.00 | N/A | N/A | 55.01 | 74.00 | 18.99 |
| 2 484.75 | V | X | AV | 50.01 | 5.00 | -24.79 | N/A | 30.22 | 54.00 | 23.78 |
| 4 960.92 | H | X | PK | 49.56 | 2.51 | N/A | N/A | 52.07 | 74.00 | 21.93 |
| 4 960.92 | H | X | AV | 49.56 | 2.51 | -24.79 | N/A | 27.28 | 54.00 | 26.72 |

9 kHz ~ 25 GHz Data (Modulation : $\pi/4$ DQPSK)

▪ Lowest Channel

| Frequency (MHz) | ANT Pol | EUT Position (Axis) | Detector Mode | Reading (dBuV) | TF (dB/m) | DCCF (dB) | DCF (dB) | Result (dBuV/m) | Limit (dBuV/m) | Margin (dB) |
|-----------------|---------|---------------------|---------------|----------------|-----------|-----------|----------|-----------------|----------------|-------------|
| 2 388.61 | V | X | PK | 51.19 | 4.47 | N/A | N/A | 55.66 | 74.00 | 18.34 |
| 2 388.61 | V | X | AV | 51.19 | 4.47 | -24.79 | N/A | 30.87 | 54.00 | 23.13 |
| 4 804.01 | H | X | PK | 50.46 | 1.64 | N/A | N/A | 52.10 | 74.00 | 21.90 |
| 4 804.01 | H | X | AV | 50.46 | 1.64 | -24.79 | N/A | 27.31 | 54.00 | 26.69 |

▪ Middle Channel

| Frequency (MHz) | ANT Pol | EUT Position (Axis) | Detector Mode | Reading (dBuV) | TF (dB/m) | DCCF (dB) | DCF (dB) | Result (dBuV/m) | Limit (dBuV/m) | Margin (dB) |
|-----------------|---------|---------------------|---------------|----------------|-----------|-----------|----------|-----------------|----------------|-------------|
| 4 882.36 | H | X | PK | 50.72 | 1.90 | N/A | N/A | 52.62 | 74.00 | 21.38 |
| 4 882.36 | H | X | AV | 50.72 | 1.90 | -24.79 | N/A | 27.83 | 54.00 | 26.17 |

▪ Highest Channel

| Frequency (MHz) | ANT Pol | EUT Position (Axis) | Detector Mode | Reading (dBuV) | TF (dB/m) | DCCF (dB) | DCF (dB) | Result (dBuV/m) | Limit (dBuV/m) | Margin (dB) |
|-----------------|---------|---------------------|---------------|----------------|-----------|-----------|----------|-----------------|----------------|-------------|
| 2 486.51 | V | X | PK | 50.49 | 5.04 | N/A | N/A | 55.53 | 74.00 | 18.47 |
| 2 486.51 | V | X | AV | 50.49 | 5.04 | -24.79 | N/A | 30.74 | 54.00 | 23.26 |
| 4 959.01 | H | X | PK | 49.10 | 2.52 | N/A | N/A | 51.62 | 74.00 | 22.38 |
| 4 959.01 | H | X | AV | 49.10 | 2.52 | -24.79 | N/A | 26.83 | 54.00 | 27.17 |

9 kHz ~ 25 GHz Data (Modulation : 8DPSK)

▪ Lowest Channel

| Frequency (MHz) | ANT Pol | EUT Position (Axis) | Detector Mode | Reading (dBuV) | TF (dB/m) | DCCF (dB) | DCF (dB) | Result (dBuV/m) | Limit (dBuV/m) | Margin (dB) |
|-----------------|---------|---------------------|---------------|----------------|-----------|-----------|----------|-----------------|----------------|-------------|
| 2 389.46 | V | X | PK | 50.11 | 4.48 | N/A | N/A | 54.59 | 74.00 | 19.41 |
| 2 389.46 | V | X | AV | 50.11 | 4.48 | -24.79 | N/A | 29.80 | 54.00 | 24.20 |
| 4 803.18 | H | X | PK | 50.92 | 1.64 | N/A | N/A | 52.56 | 74.00 | 21.44 |
| 4 803.18 | H | X | AV | 50.92 | 1.64 | -24.79 | N/A | 27.77 | 54.00 | 26.23 |

▪ Middle Channel

| Frequency (MHz) | ANT Pol | EUT Position (Axis) | Detector Mode | Reading (dBuV) | TF (dB/m) | DCCF (dB) | DCF (dB) | Result (dBuV/m) | Limit (dBuV/m) | Margin (dB) |
|-----------------|---------|---------------------|---------------|----------------|-----------|-----------|----------|-----------------|----------------|-------------|
| 4 882.33 | H | X | PK | 50.62 | 1.90 | N/A | N/A | 52.52 | 74.00 | 21.48 |
| 4 882.33 | H | X | AV | 50.62 | 1.90 | -24.79 | N/A | 27.73 | 54.00 | 26.27 |

▪ Highest Channel

| Frequency (MHz) | ANT Pol | EUT Position (Axis) | Detector Mode | Reading (dBuV) | TF (dB/m) | DCCF (dB) | DCF (dB) | Result (dBuV/m) | Limit (dBuV/m) | Margin (dB) |
|-----------------|---------|---------------------|---------------|----------------|-----------|-----------|----------|-----------------|----------------|-------------|
| 2 484.63 | V | X | PK | 51.80 | 5.00 | N/A | N/A | 56.80 | 74.00 | 17.20 |
| 2 484.63 | V | X | AV | 51.80 | 5.00 | -24.79 | N/A | 32.01 | 54.00 | 21.99 |
| 4 960.90 | H | X | PK | 49.31 | 2.51 | N/A | N/A | 51.82 | 74.00 | 22.18 |
| 4 960.90 | H | X | AV | 49.31 | 2.51 | -24.79 | N/A | 27.03 | 54.00 | 26.97 |

9.4.2. Unwanted Emissions(Conducted)

Low Band-edge

Lowest Channel & Modulation : GFSK

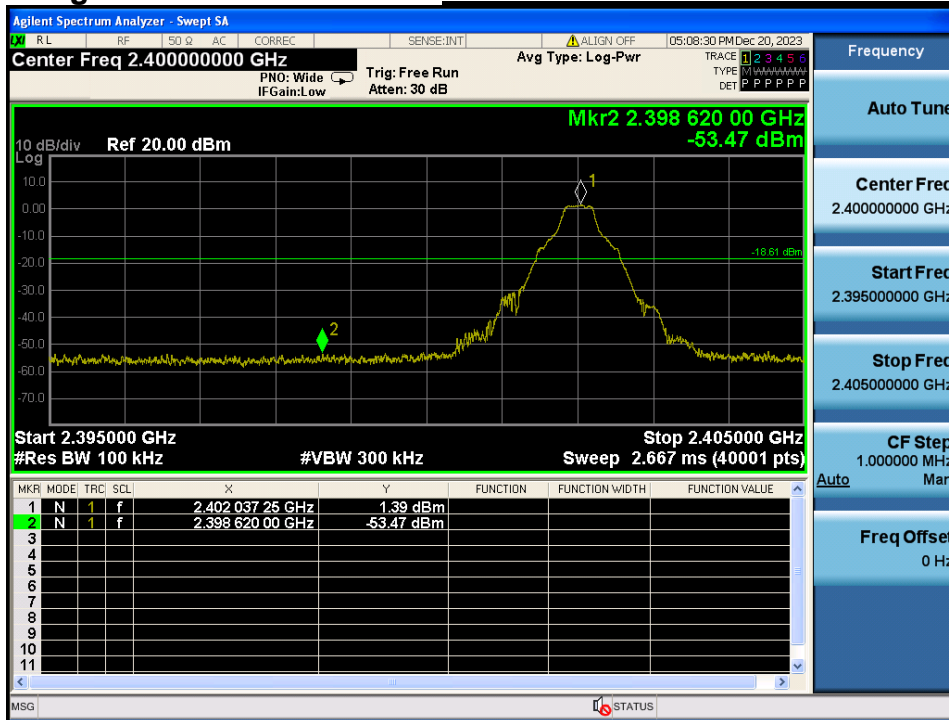

Low Band-edge

Hopping mode & Modulation : GFSK

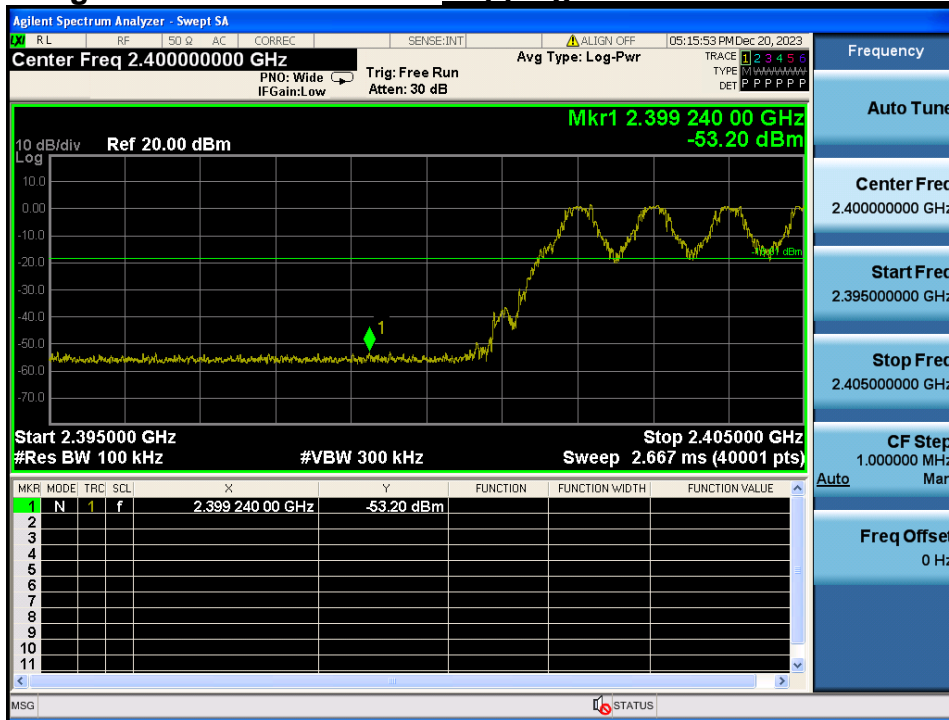

Conducted Spurious Emissions **Lowest Channel & Modulation : GFSK**

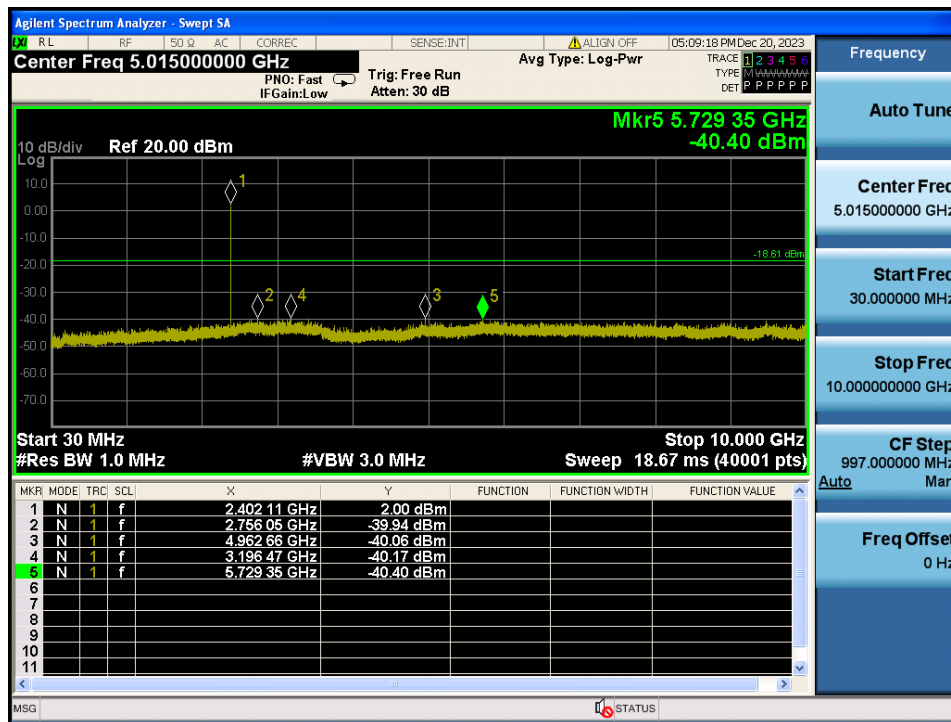
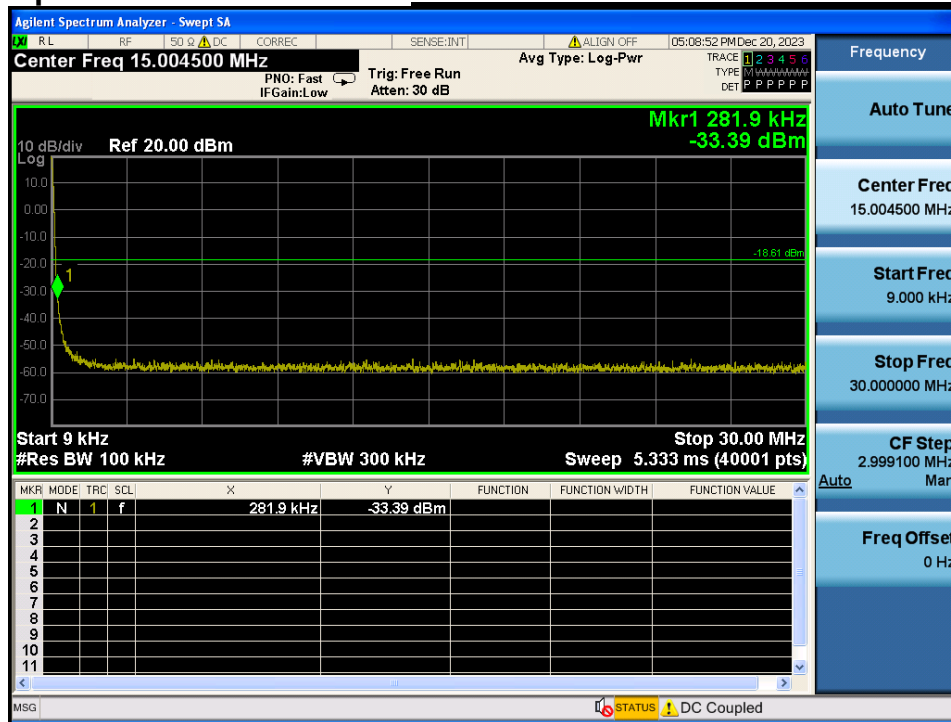

Conducted Spurious Emissions **Lowest Channel & Modulation : GFSK**

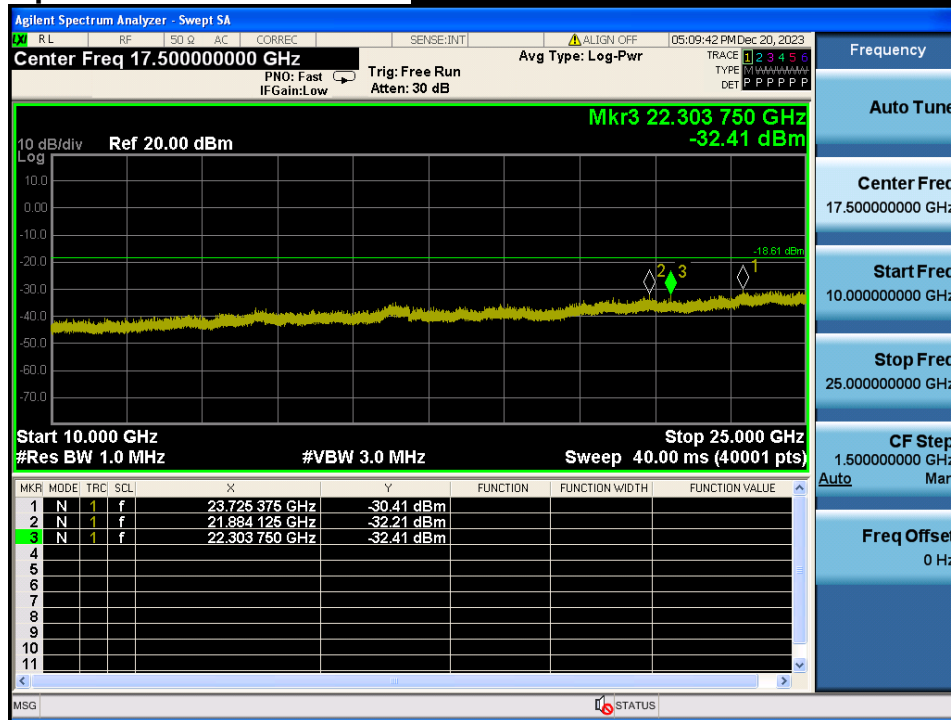

Reference for limit

Middle Channel & Modulation : GFSK

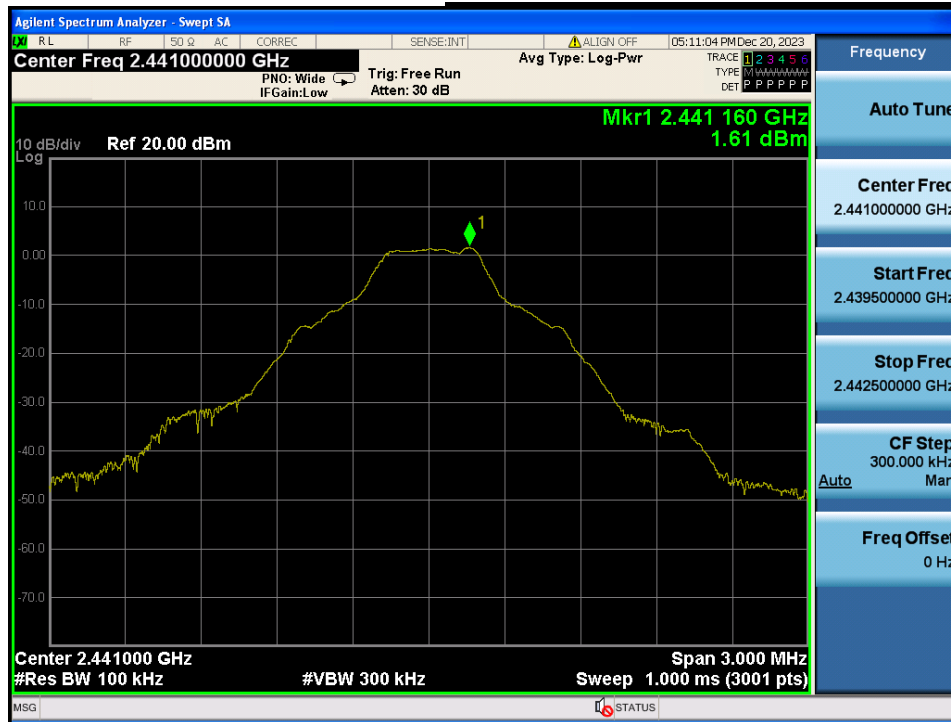

Conducted Spurious Emissions

Middle Channel & Modulation : GFSK

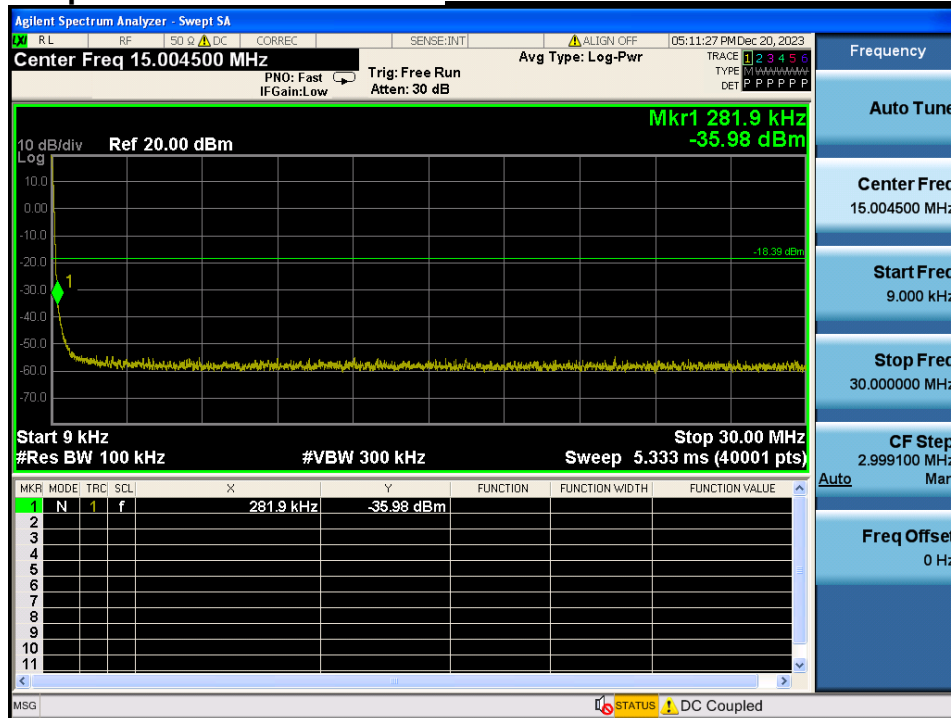

Conducted Spurious Emissions *Middle Channel & Modulation : GFSK*

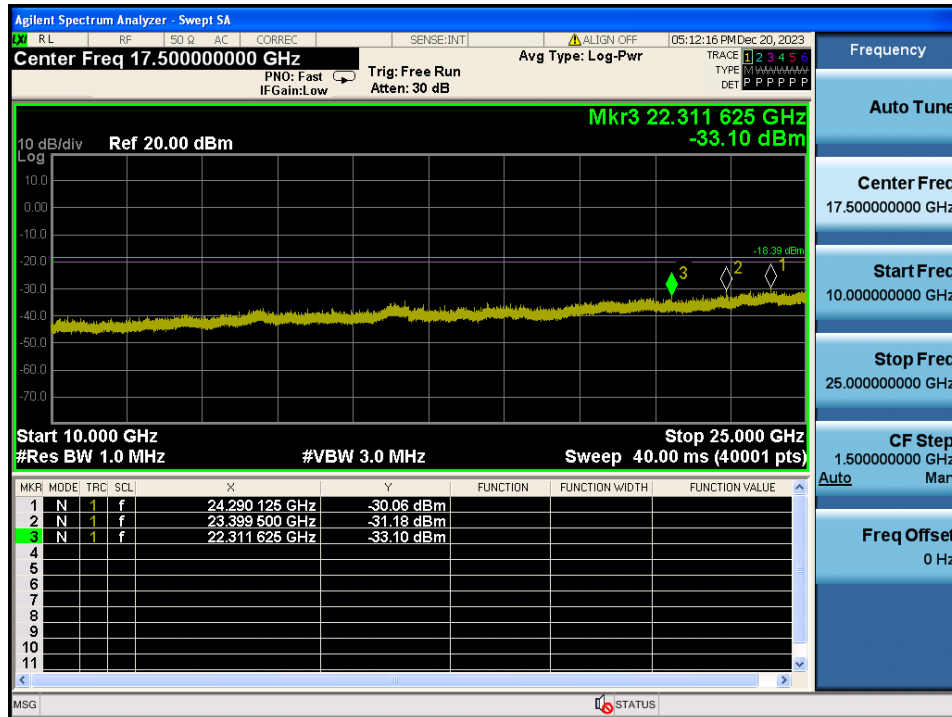
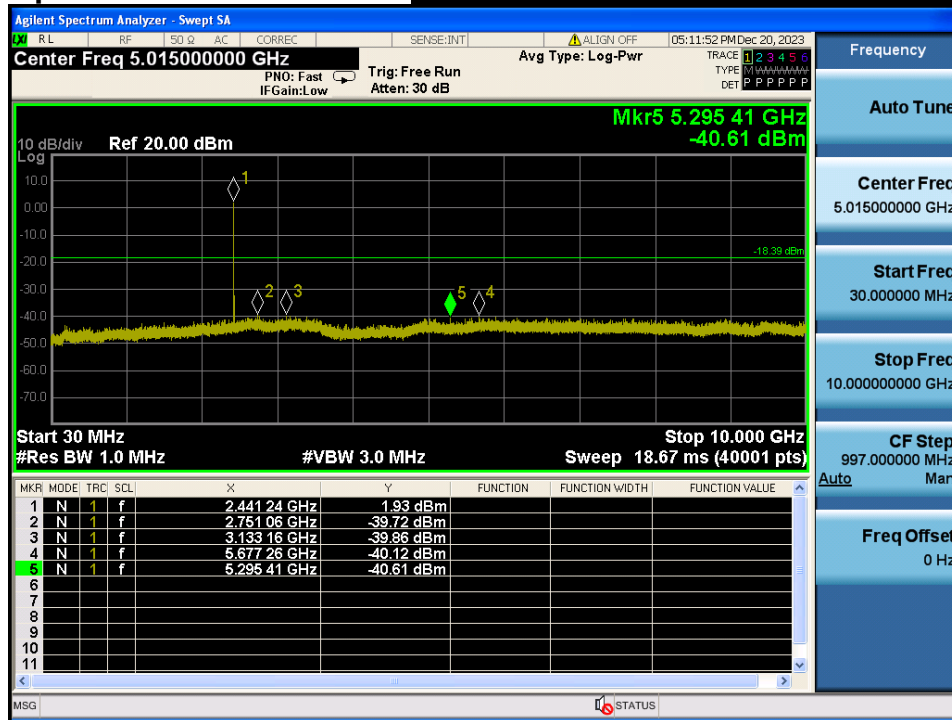

High Band-edge

Highest Channel & Modulation : GFSK

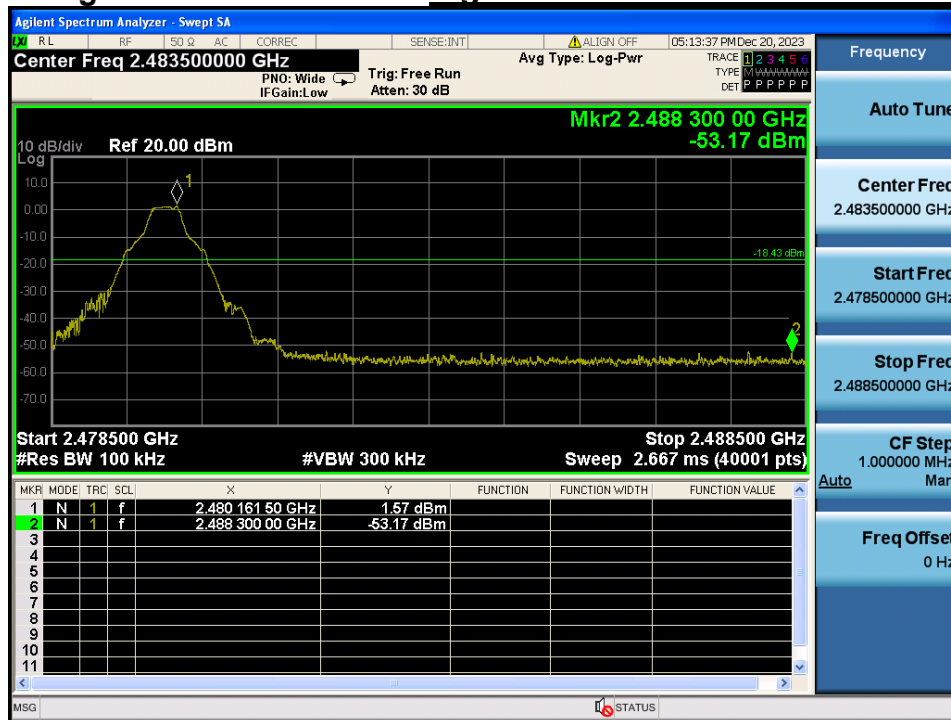

High Band-edge

Hopping mode & Modulation : GFSK

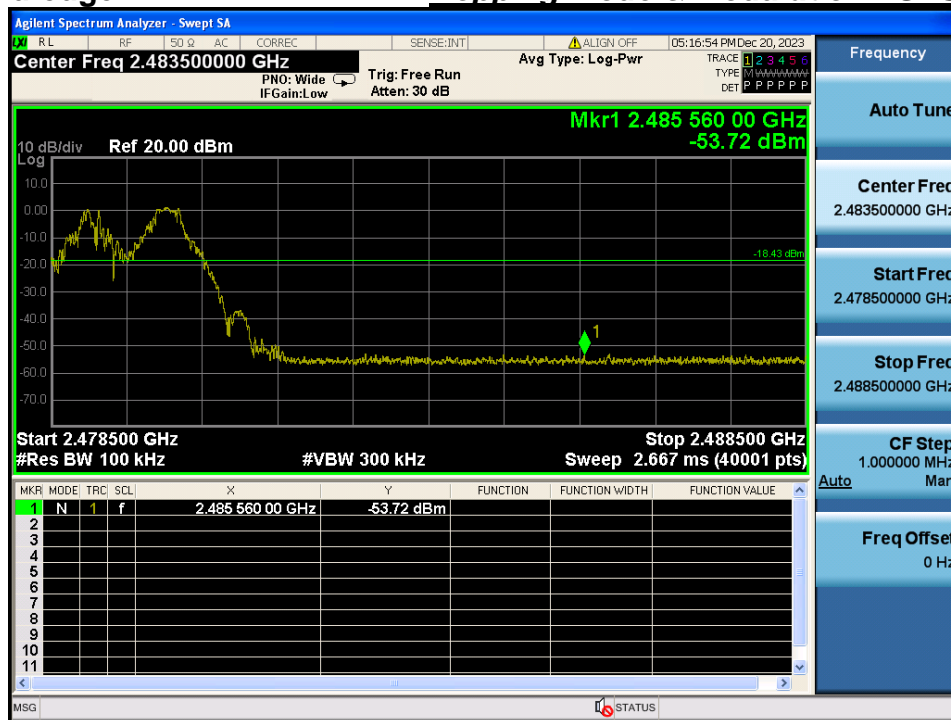

Conducted Spurious Emissions **Highest Channel & Modulation : GFSK**

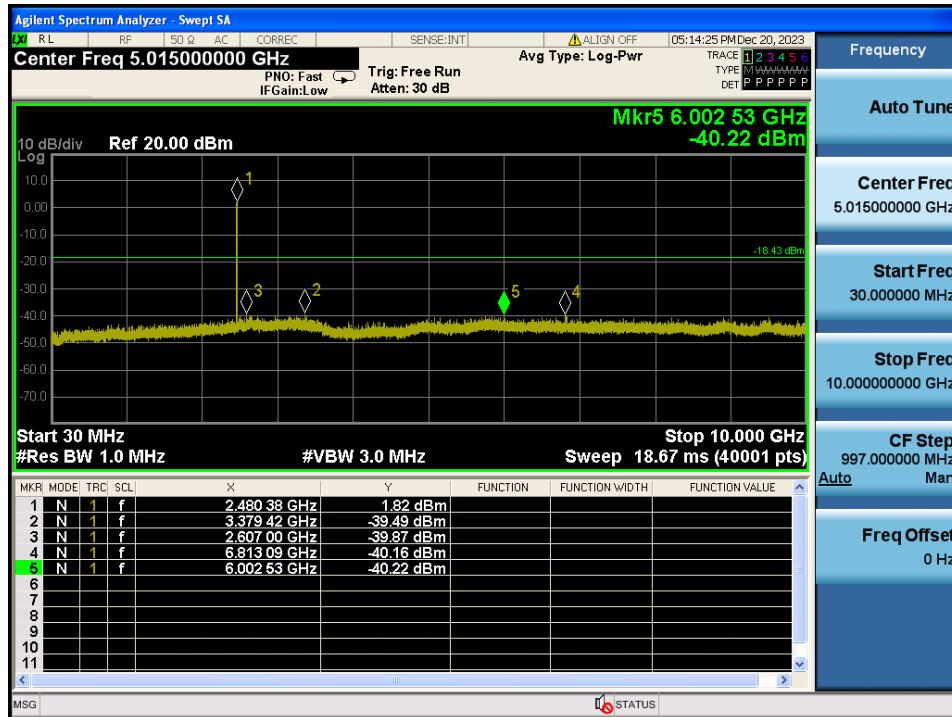
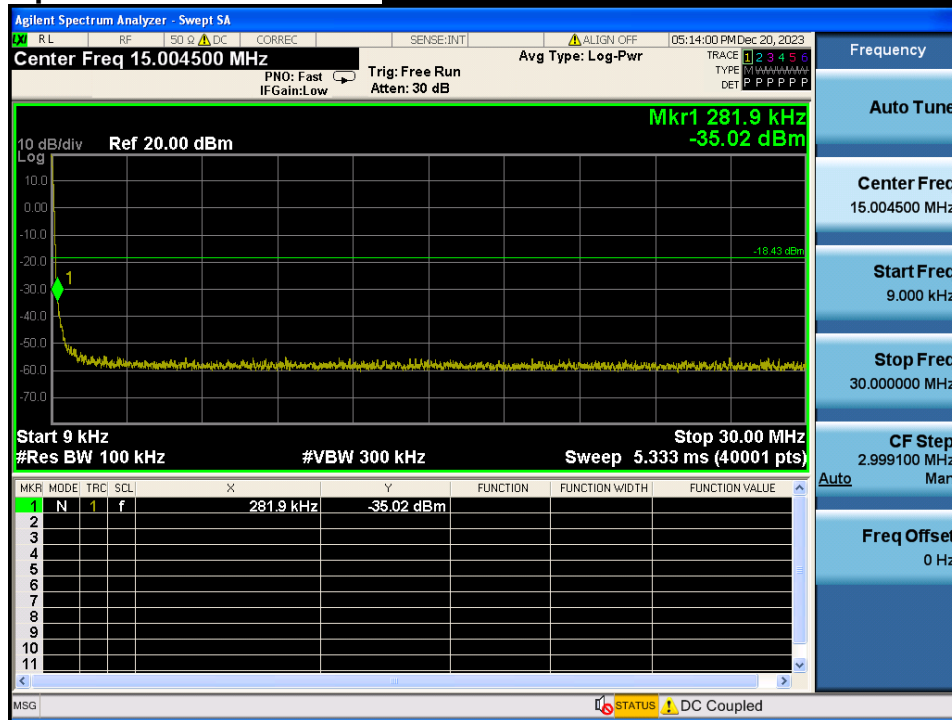

Conducted Spurious Emissions **Highest Channel & Modulation : GFSK**

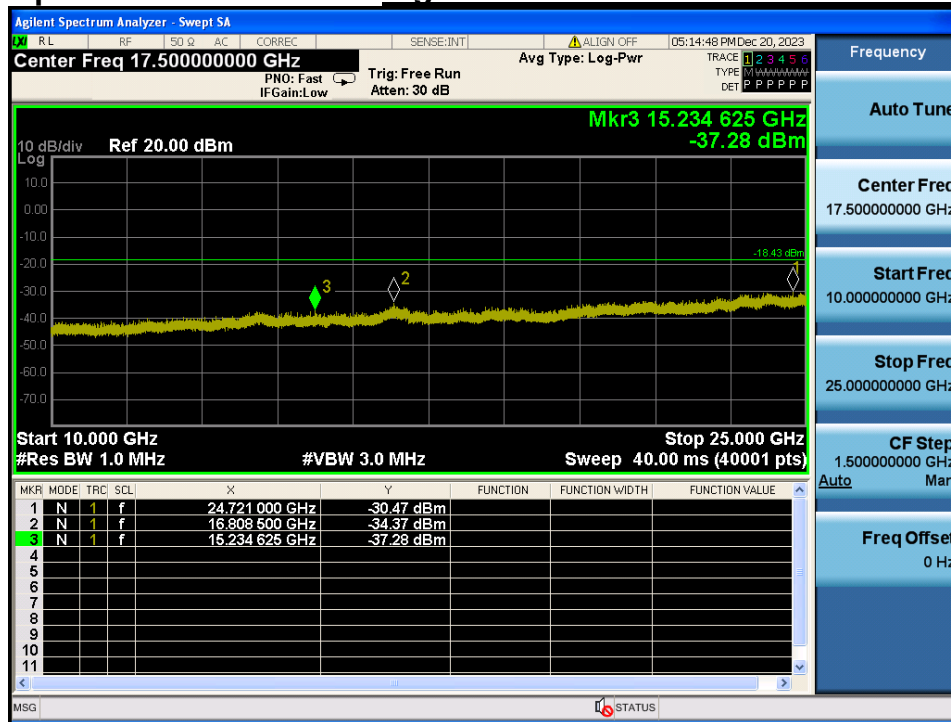

Low Band-edge

Lowest Channel & Modulation : $\pi/4$ DQPSK

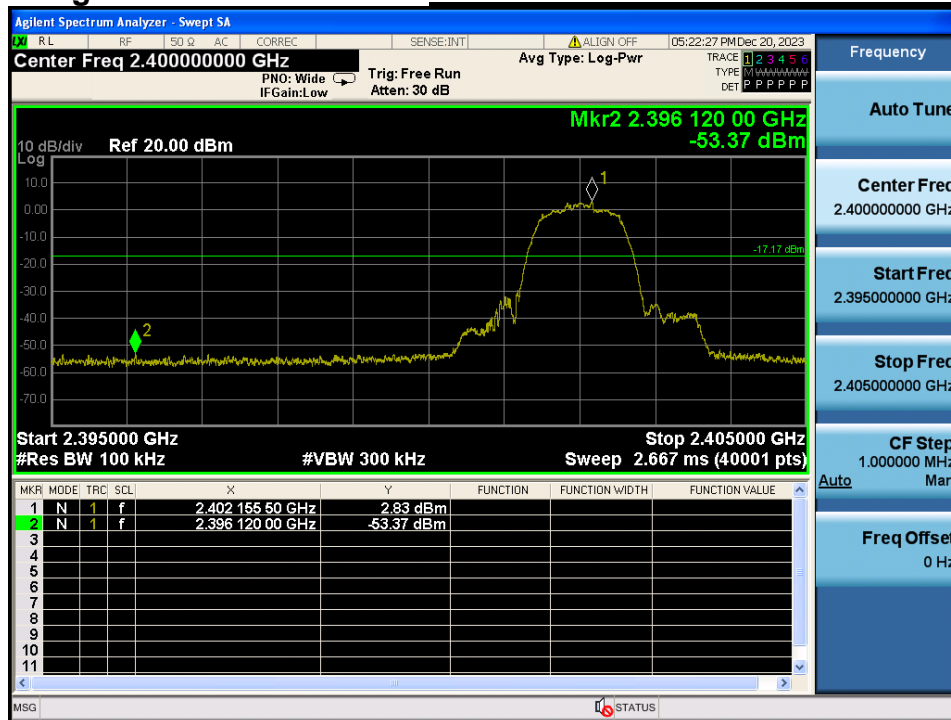

Low Band-edge

Hopping mode & Modulation : $\pi/4$ DQPSK

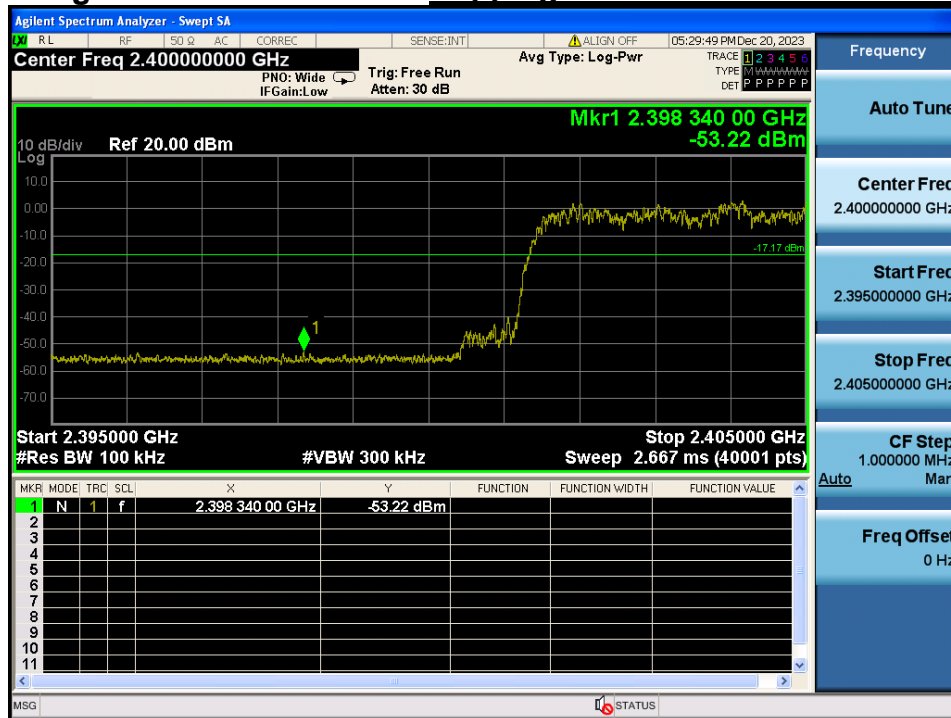

Conducted Spurious Emissions **Lowest Channel & Modulation : $\pi/4$ DQPSK**

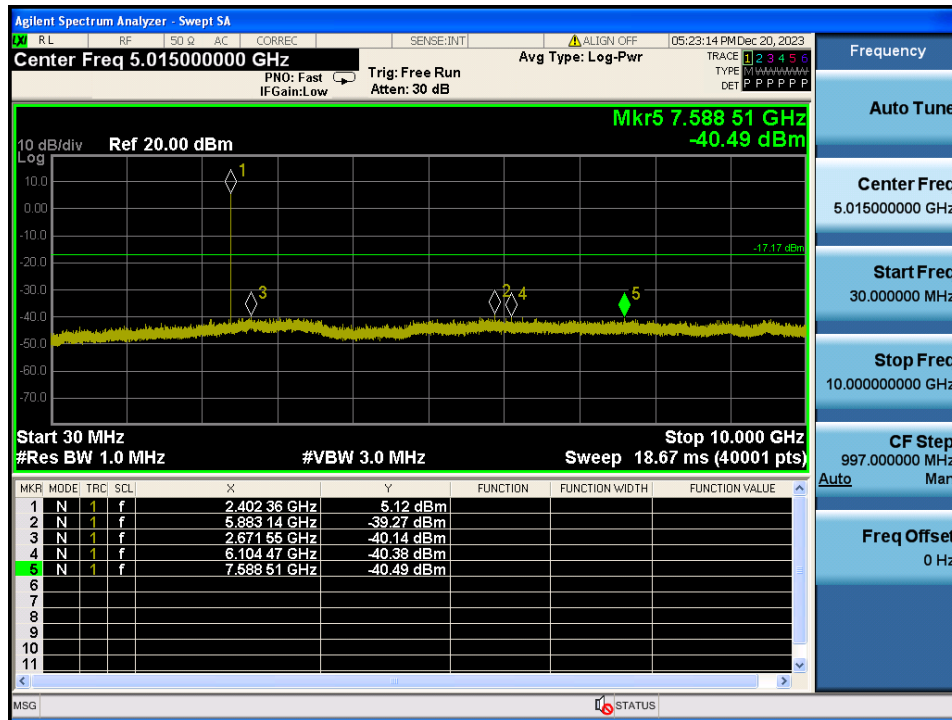
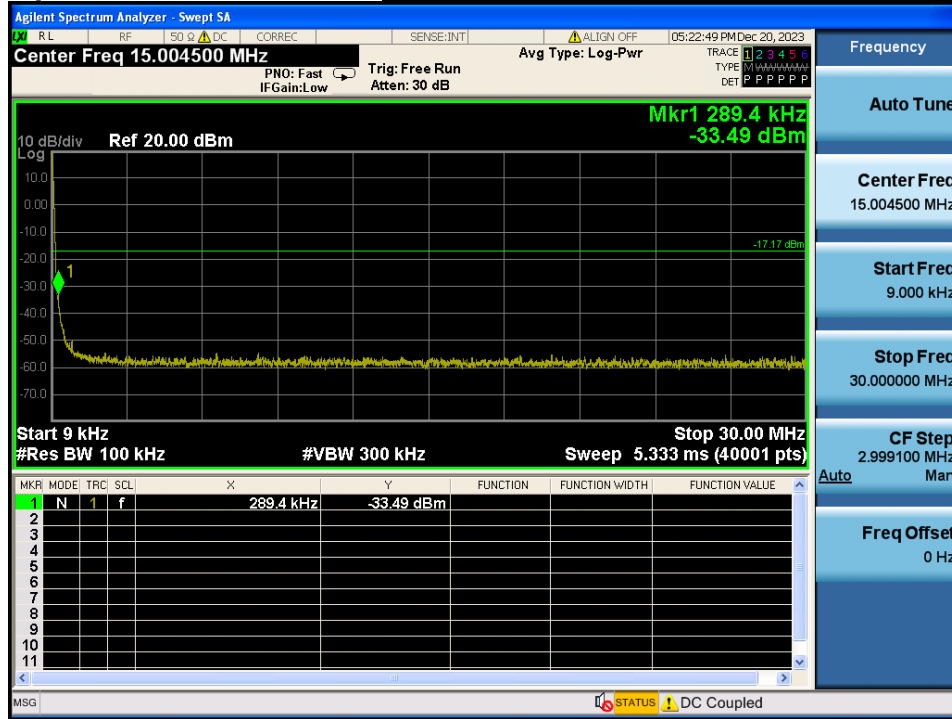

Conducted Spurious Emissions **Lowest Channel & Modulation : $\pi/4$ DQPSK**

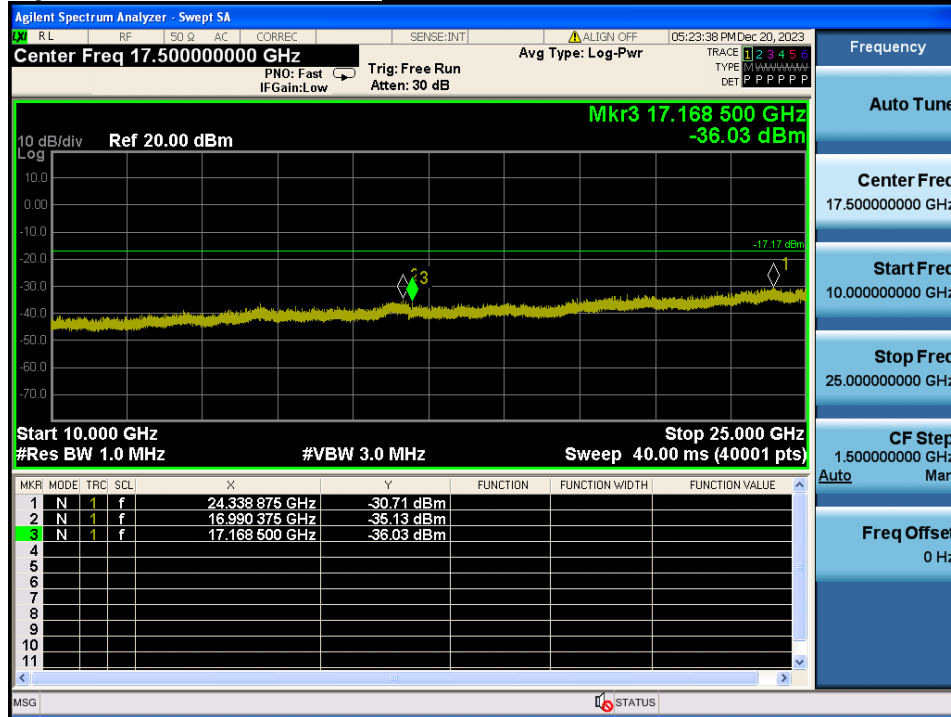

Reference for limit

Middle Channel & Modulation : $\pi/4$ DQPSK

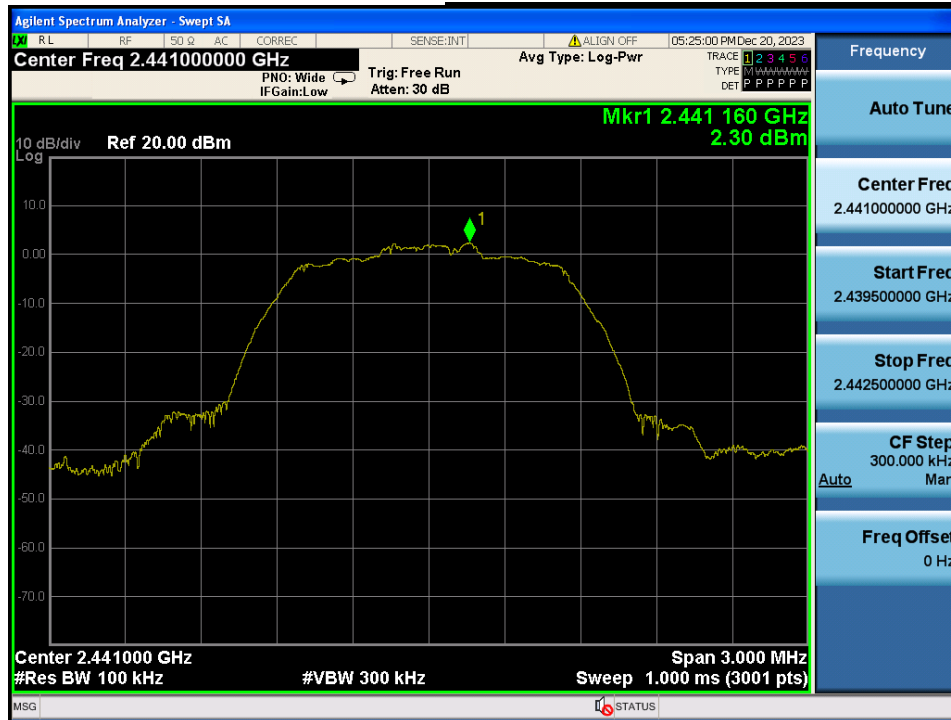

Conducted Spurious Emissions

Middle Channel & Modulation : $\pi/4$ DQPSK

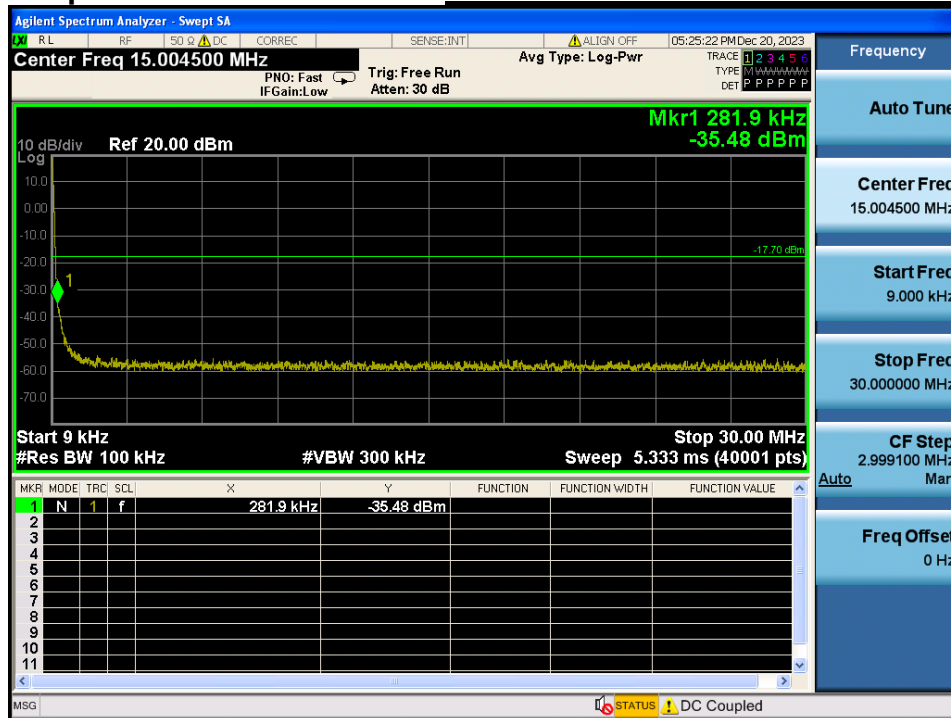

Conducted Spurious Emissions *Middle Channel & Modulation : $\pi/4$ DQPSK*

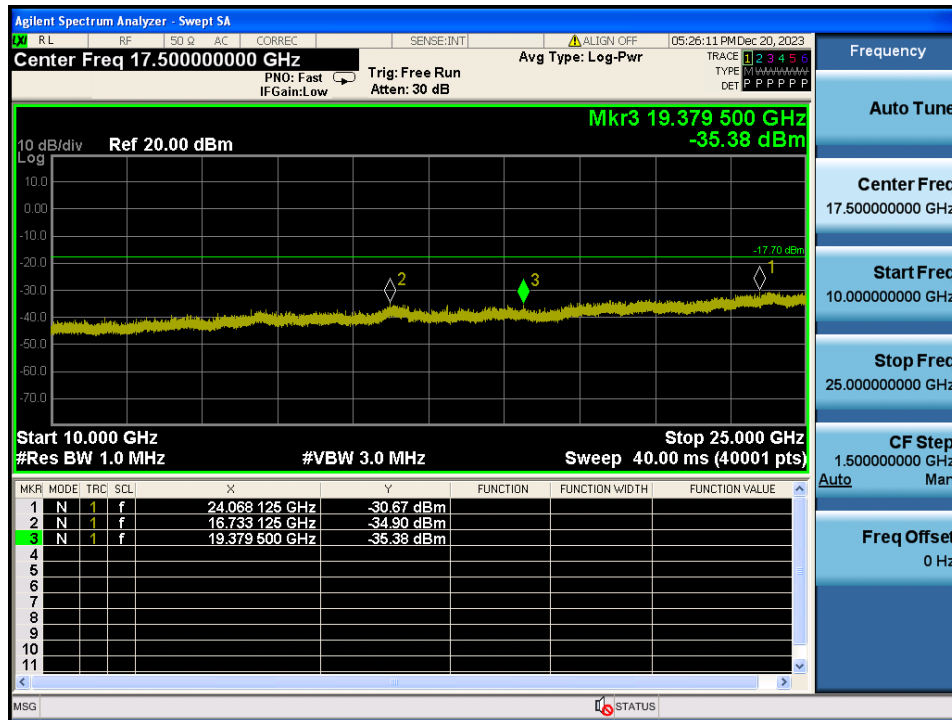
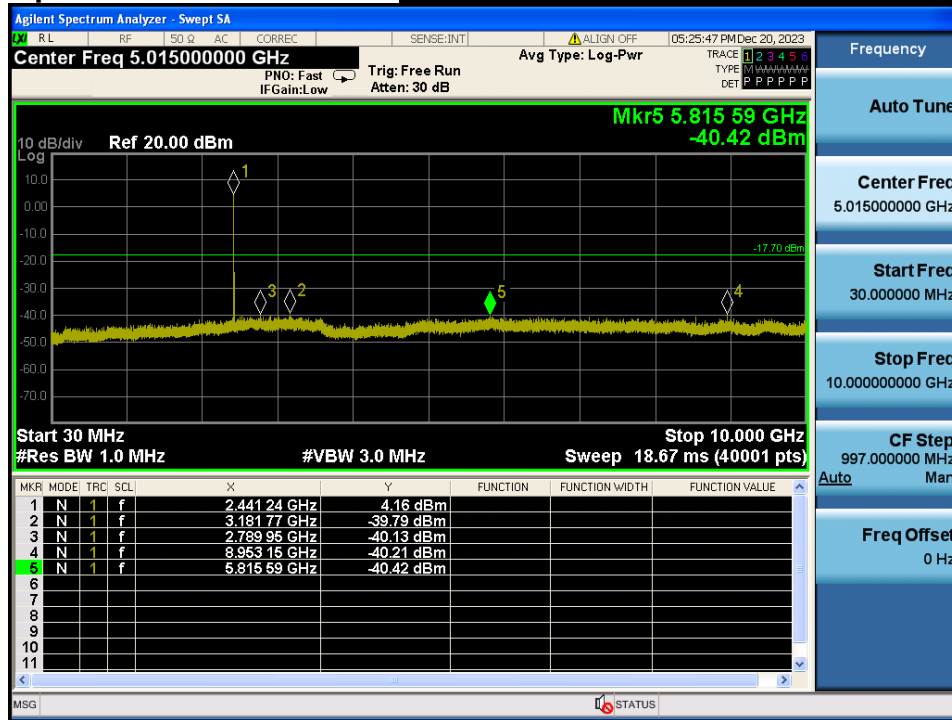

High Band-edge

Highest Channel & Modulation : $\pi/4$ DQPSK

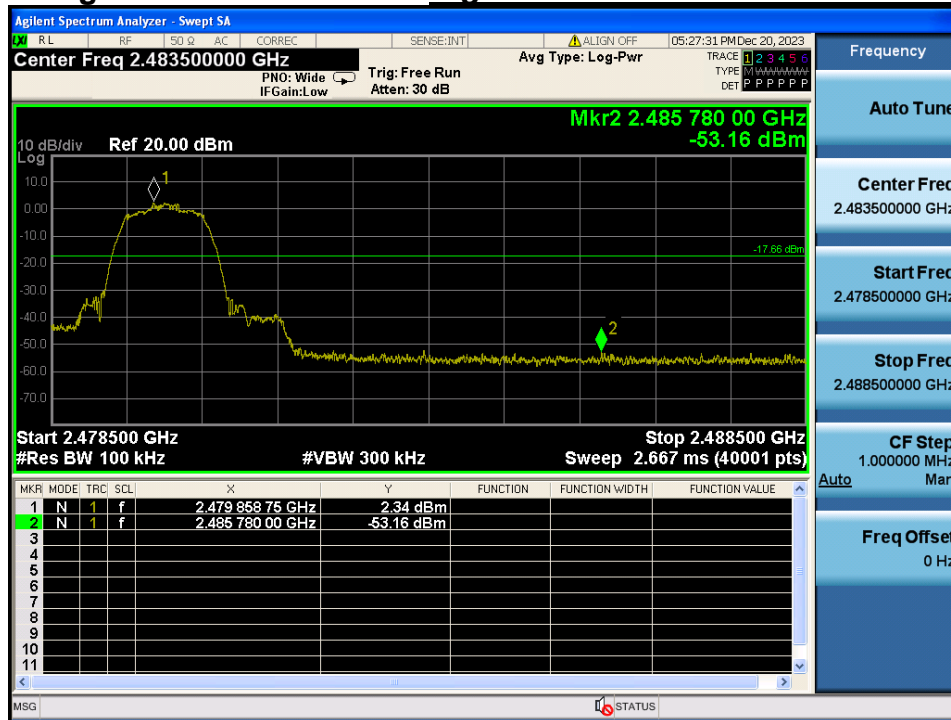

High Band-edge

Hopping mode & Modulation : $\pi/4$ DQPSK

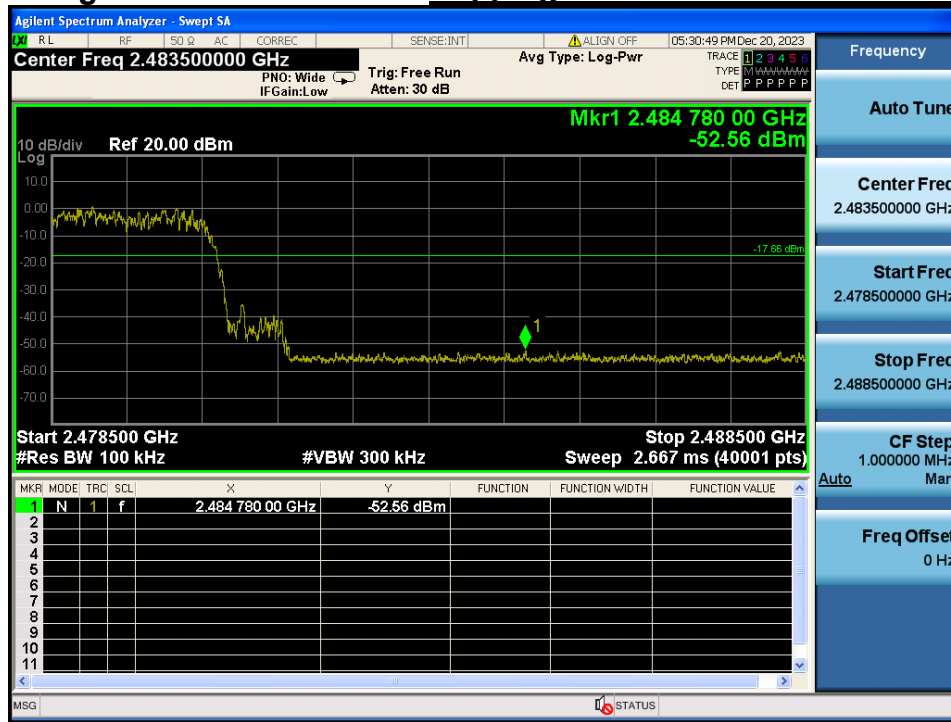

Conducted Spurious Emissions

Highest Channel & Modulation : $\pi/4$ DQPSK

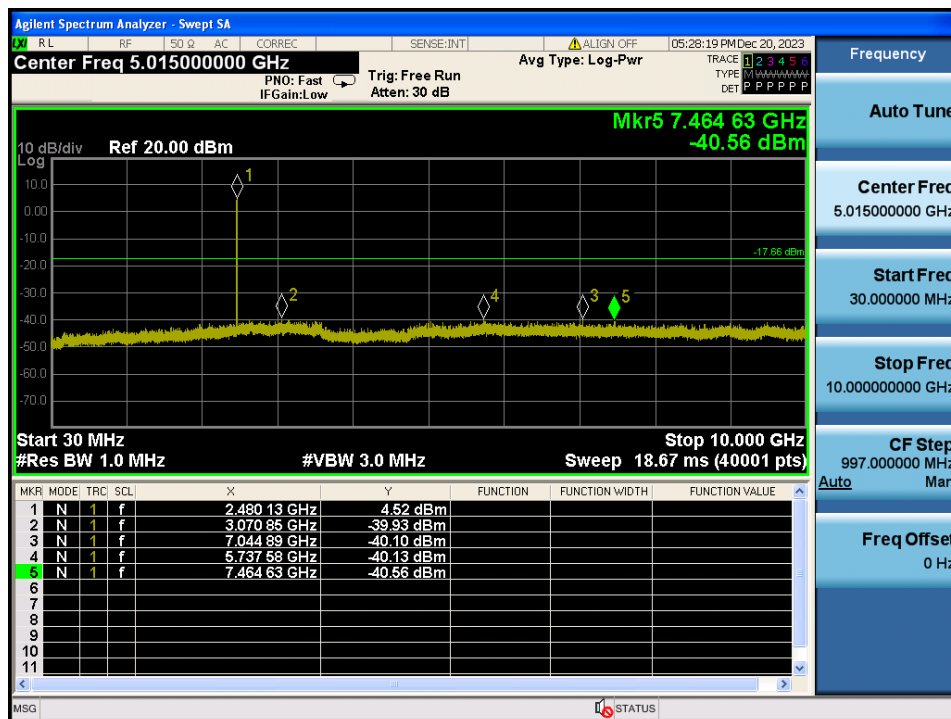
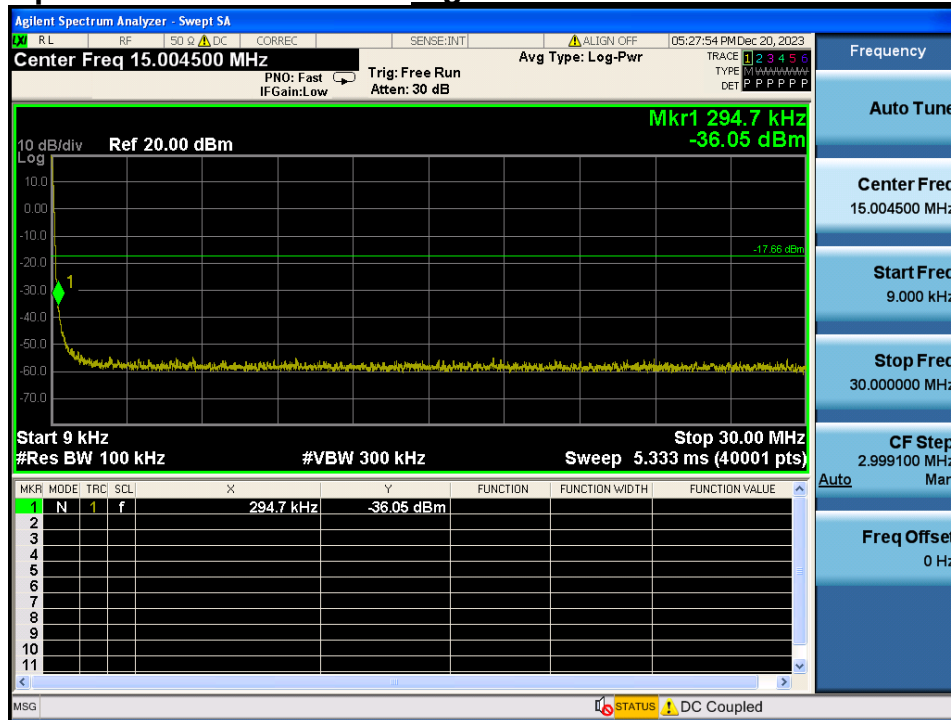

Conducted Spurious Emissions

Highest Channel & Modulation : $\pi/4$ DQPSK

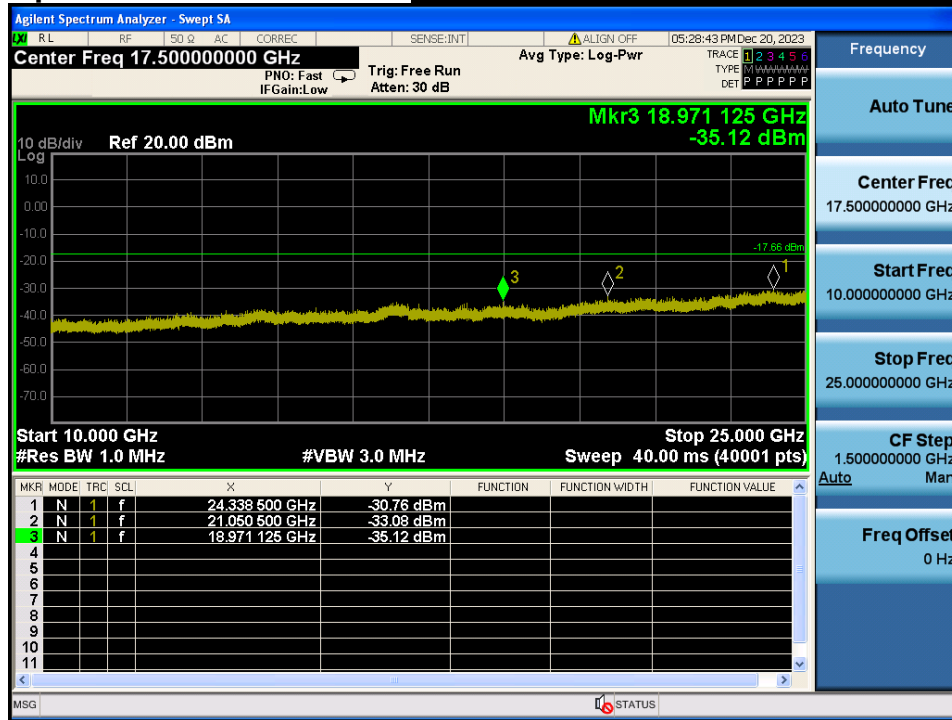

Low Band-edge

Lowest Channel & Modulation : 8DPSK

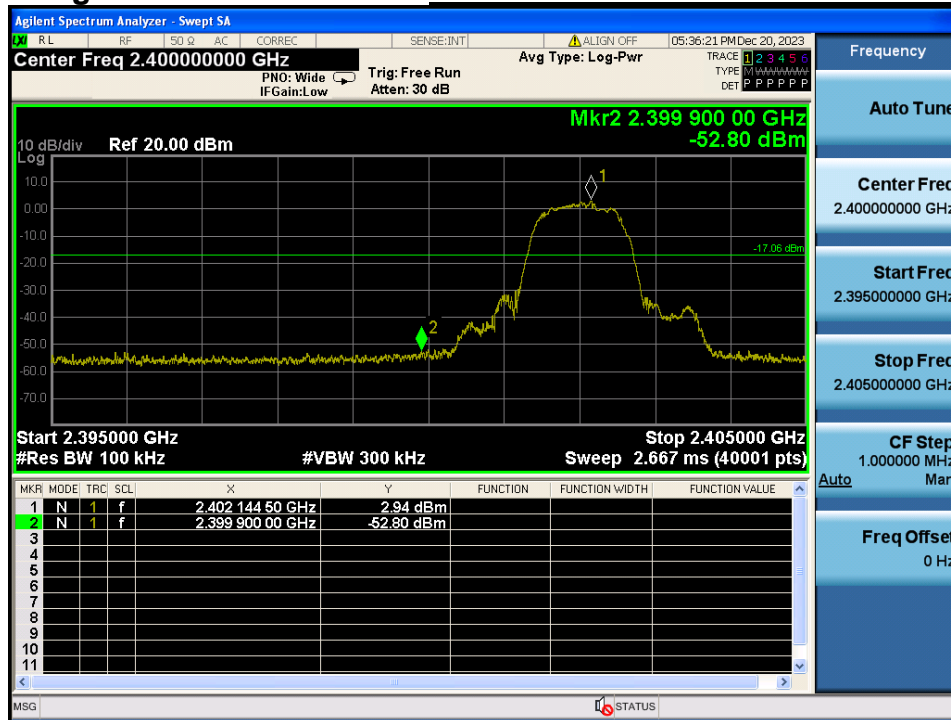

Low Band-edge

Hopping mode & Modulation : 8DPSK

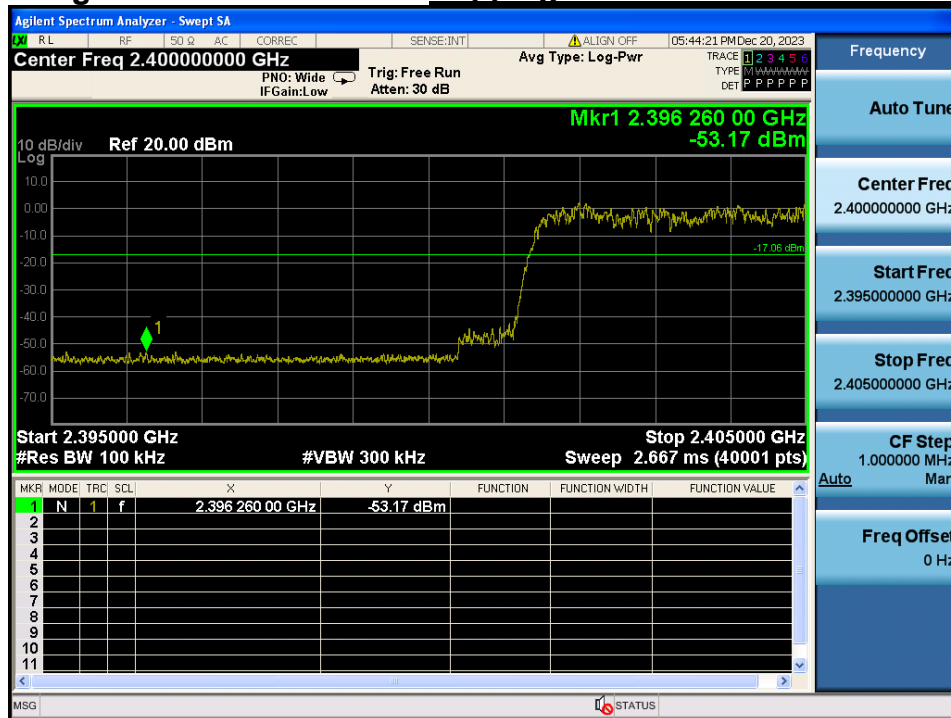

Conducted Spurious Emissions **Lowest Channel & Modulation : 8DPSK**

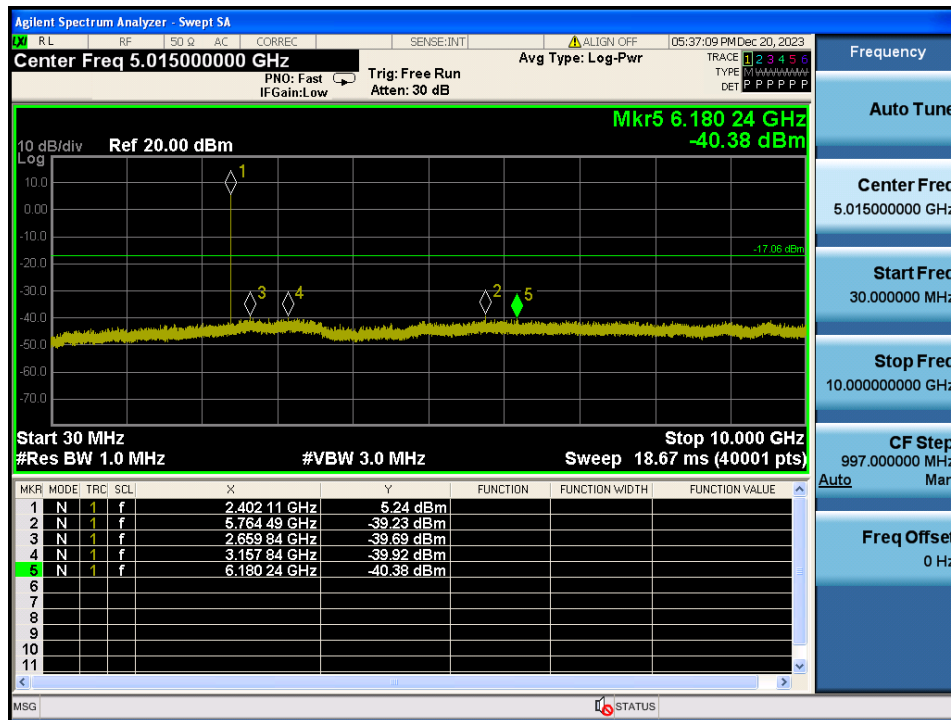
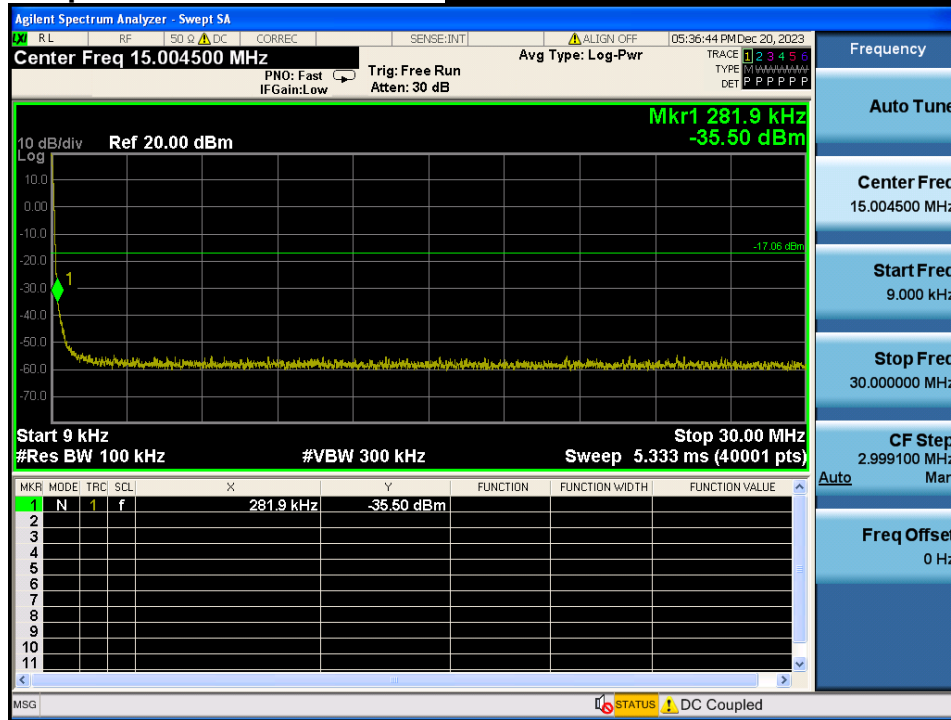

Conducted Spurious Emissions **Lowest Channel & Modulation : 8DPSK**

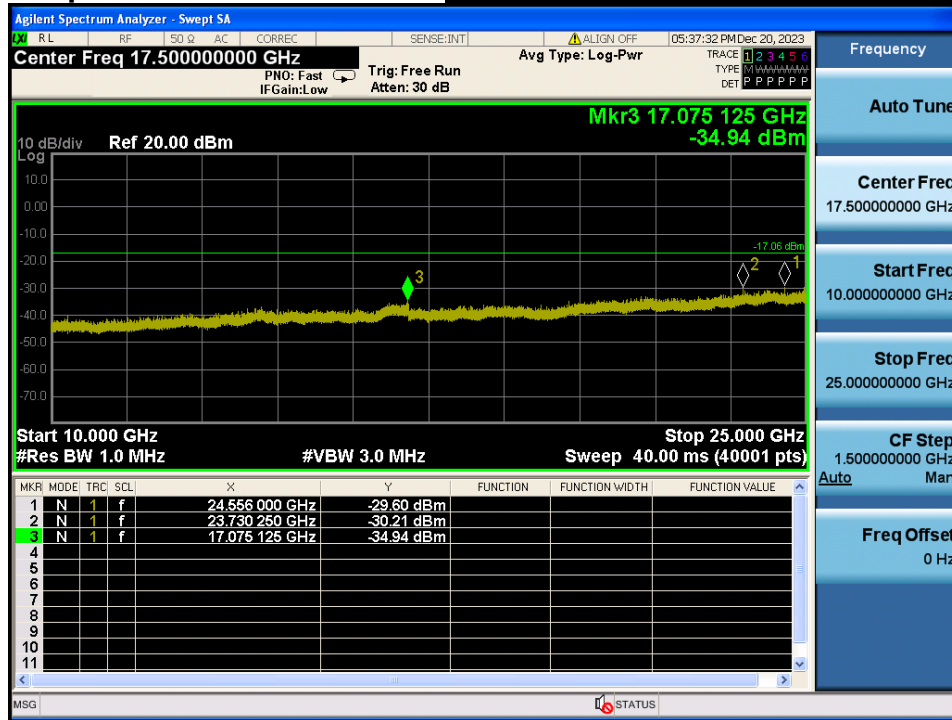

Reference for limit

Middle Channel & Modulation : 8DPSK

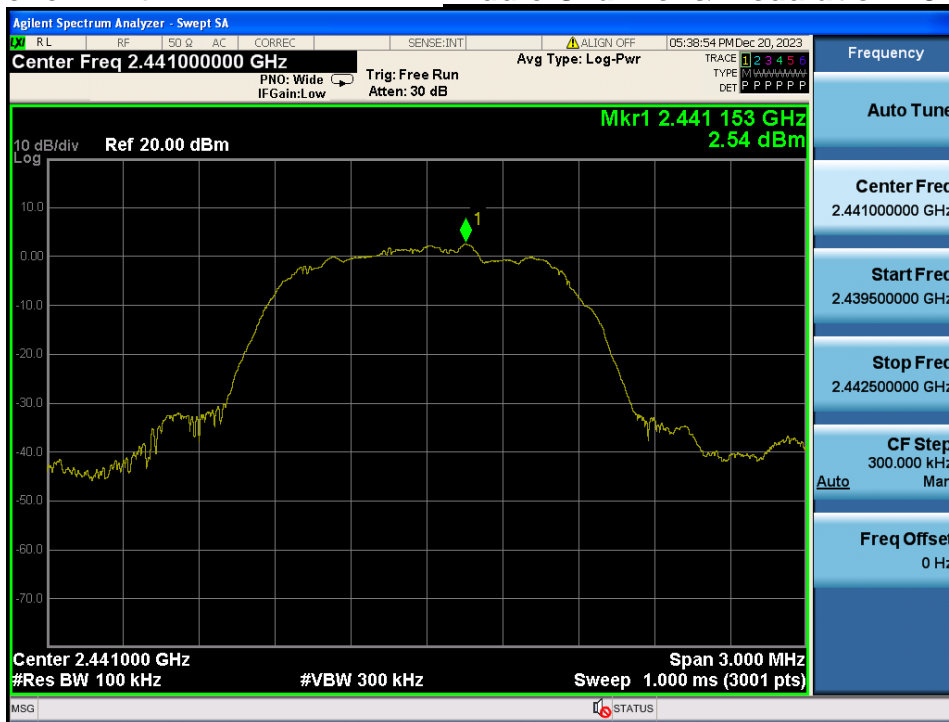

Conducted Spurious Emissions

Middle Channel & Modulation : 8DPSK

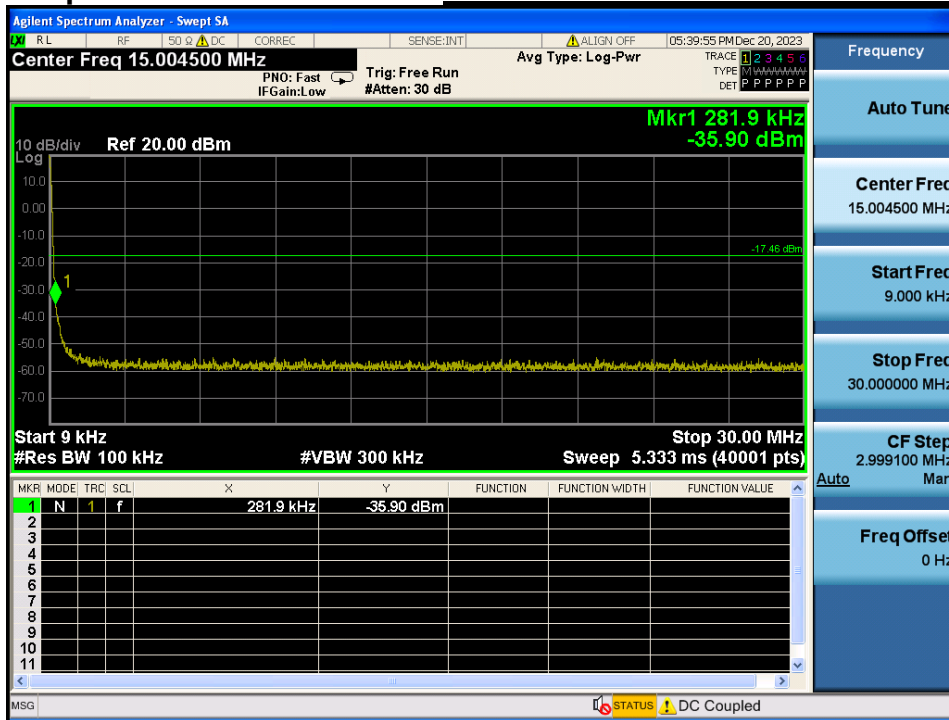

Conducted Spurious Emissions *Middle Channel & Modulation : 8DPSK*

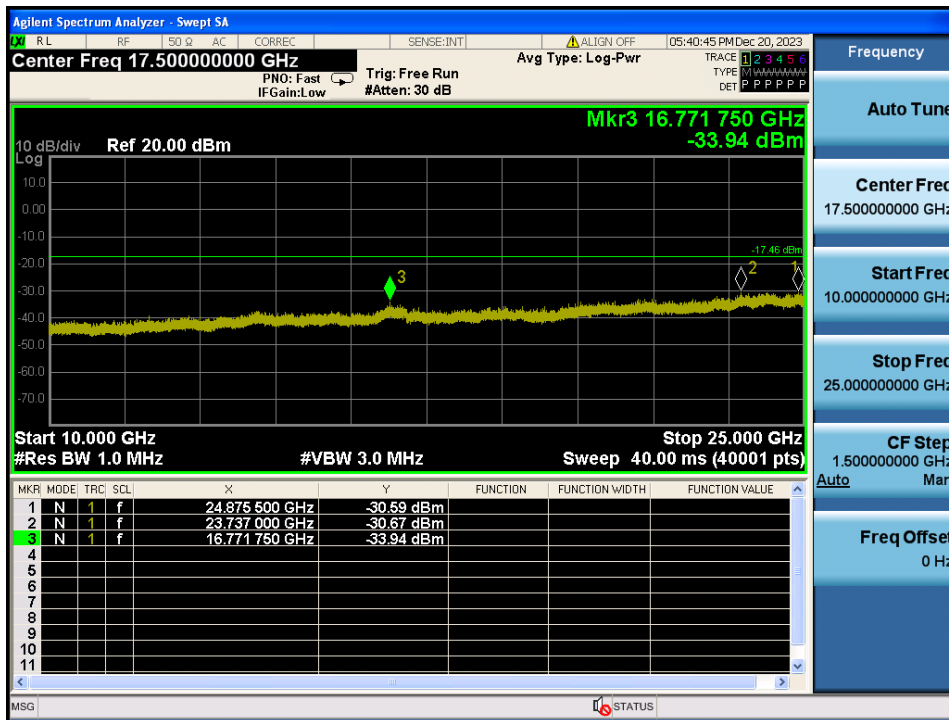
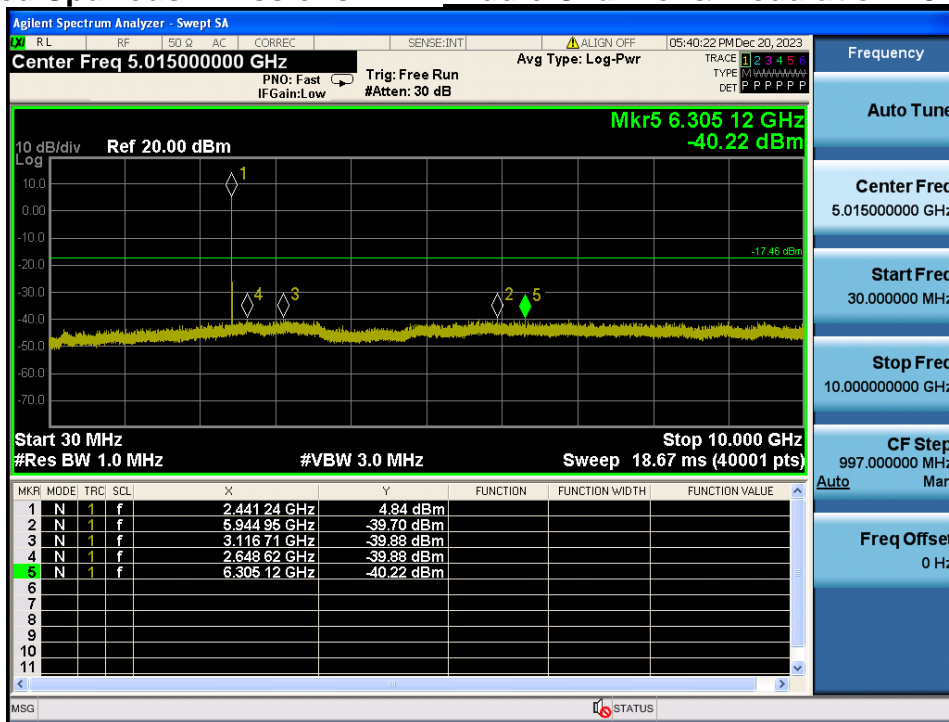

High Band-edge

Highest Channel & Modulation : 8DPSK

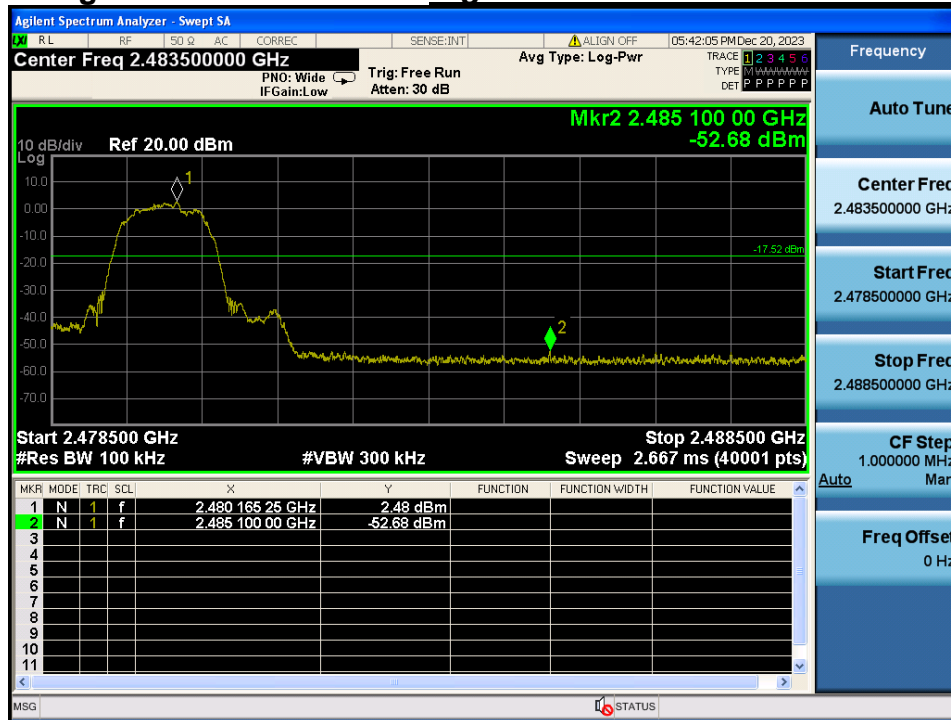

High Band-edge

Hopping mode & Modulation : 8DPSK

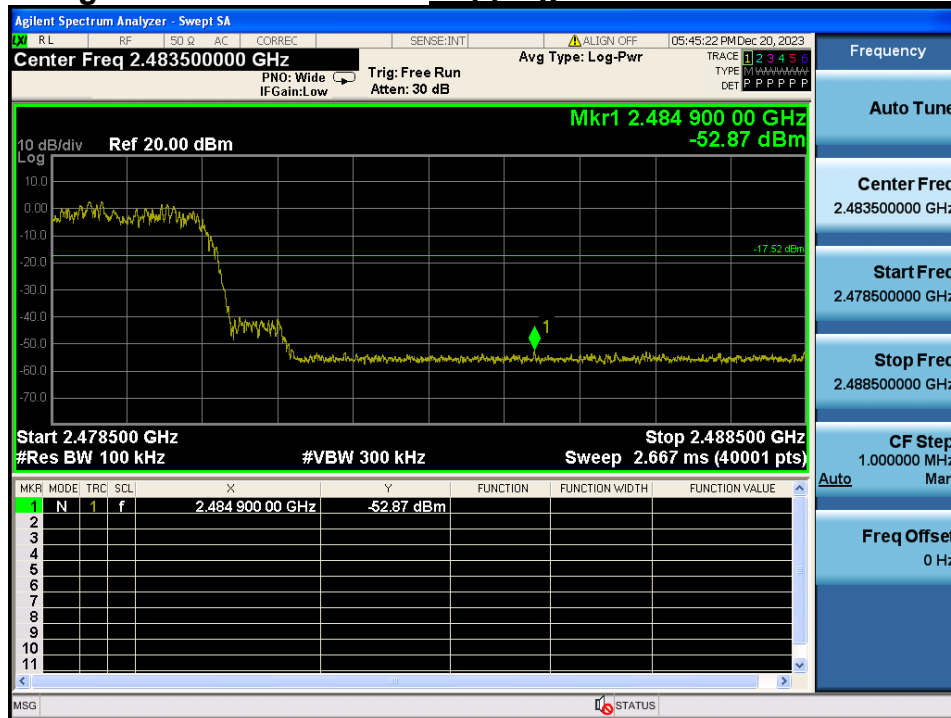

Conducted Spurious Emissions **Highest Channel & Modulation : 8DPSK**

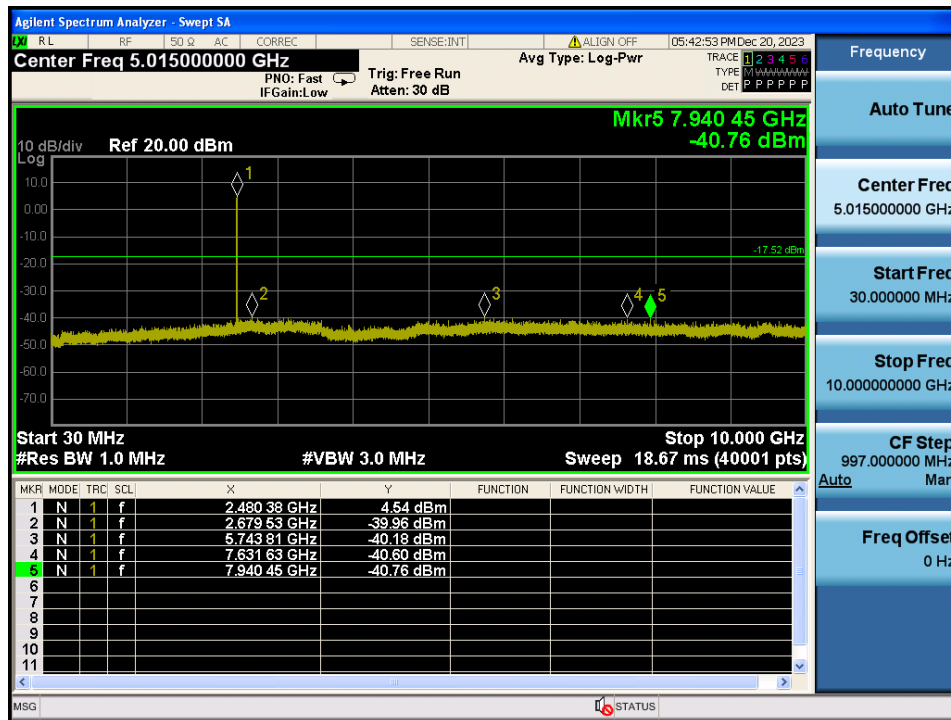
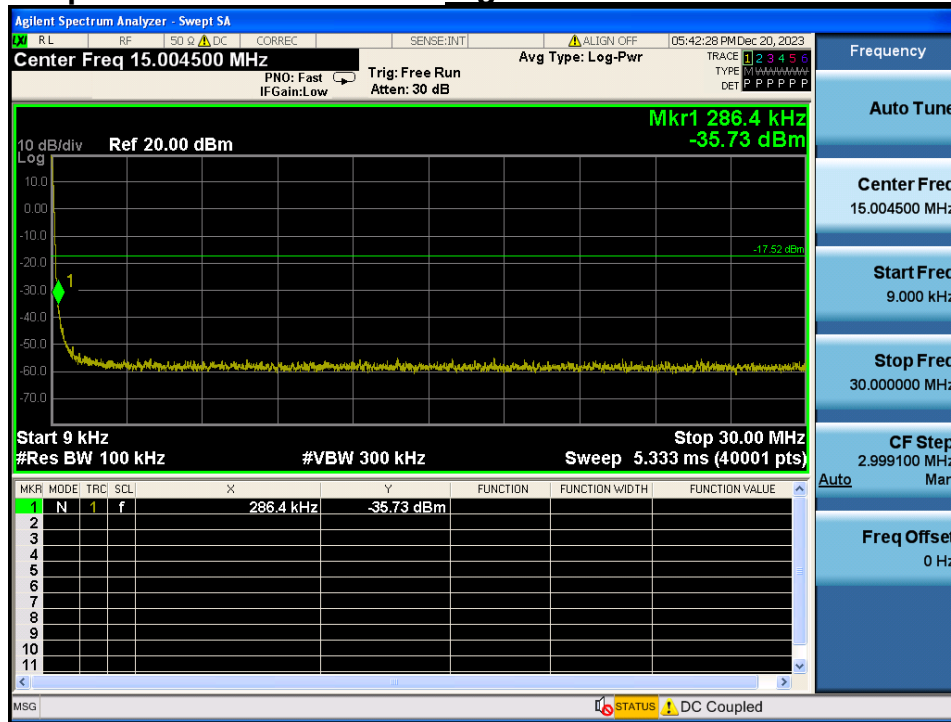

Conducted Spurious Emissions **Highest Channel & Modulation : 8DPSK**

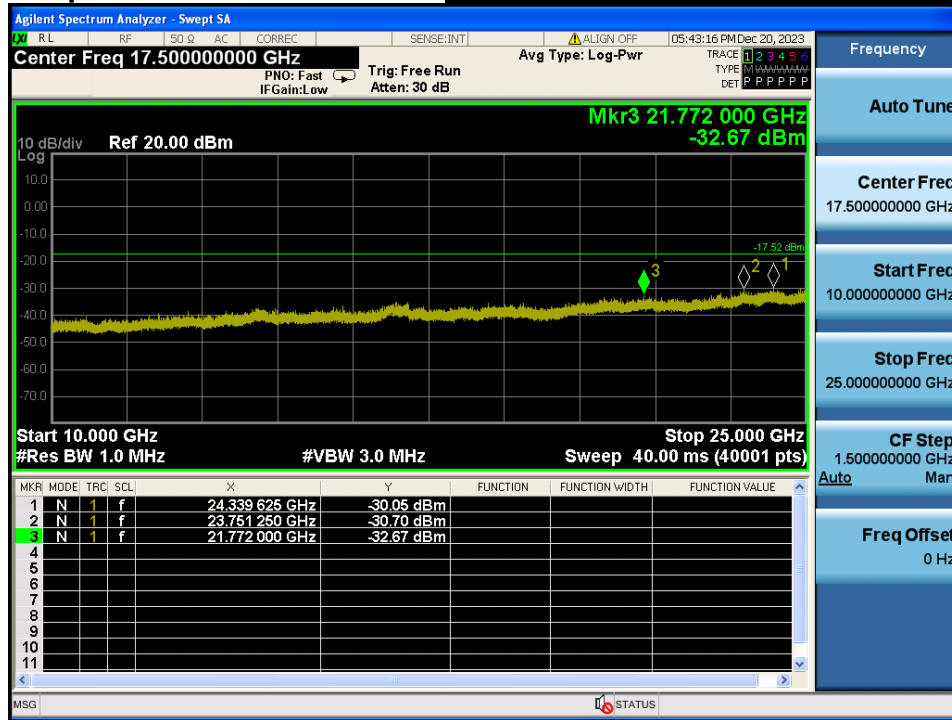

10. AC Power-Line Conducted Emissions

10.1. Test Setup

NA

10.2. Limit

According to §15.207(a) for an intentional radiator that is designed to be connected to the public utility (AC) power line, the radio frequency voltage that is conducted back onto the AC power line on any frequency or frequencies, within the band 150 kHz to 30 MHz, shall not exceed the limits in the following table, as measured using a 50 uH/50 ohm line impedance stabilization network (LISN).

Compliance with the provision of this paragraph shall on the measurement of the radio frequency voltage between each power line and ground at the power terminal. The lower applies at the boundary between the frequency ranges.

| Frequency Range (MHz) | Conducted Limit (dBuV) | |
|-----------------------|------------------------|------------|
| | Quasi-Peak | Average |
| 0.15 ~ 0.50 | 66 to 56 * | 56 to 46 * |
| 0.5 ~ 5.0 | 56 | 46 |
| 5 ~ 30 | 60 | 50 |

* Decreases with the logarithm of the frequency

10.3. Test Procedure

Conducted emissions from the EUT were measured according to the ANSI C63.10.

1. The test procedure is performed in a 6.5 m × 3.5 m × 3.5 m (L × W × H) shielded room. The EUT along with its peripherals were placed on a 1.0 m (W) × 1.5 m (L) and 0.8 m in height wooden table and the EUT was adjusted to maintain a 0.4 meter space from a vertical reference plane.
2. The EUT was connected to power mains through a line impedance stabilization network (LISN) which provides 50 ohm coupling impedance for measuring instrument and the chassis ground was bounded to the horizontal ground plane of shielded room.
3. All peripherals were connected to the second LISN and the chassis ground also bounded to the horizontal ground plane of shielded room.
4. The excess power cable between the EUT and the LISN was bundled. The power cables of peripherals were unbundled. All connecting cables of EUT and peripherals were moved to find the maximum emission.

10.4. Test Results

NA

APPENDIX I

Test set up diagrams

▪ Radiated Measurement

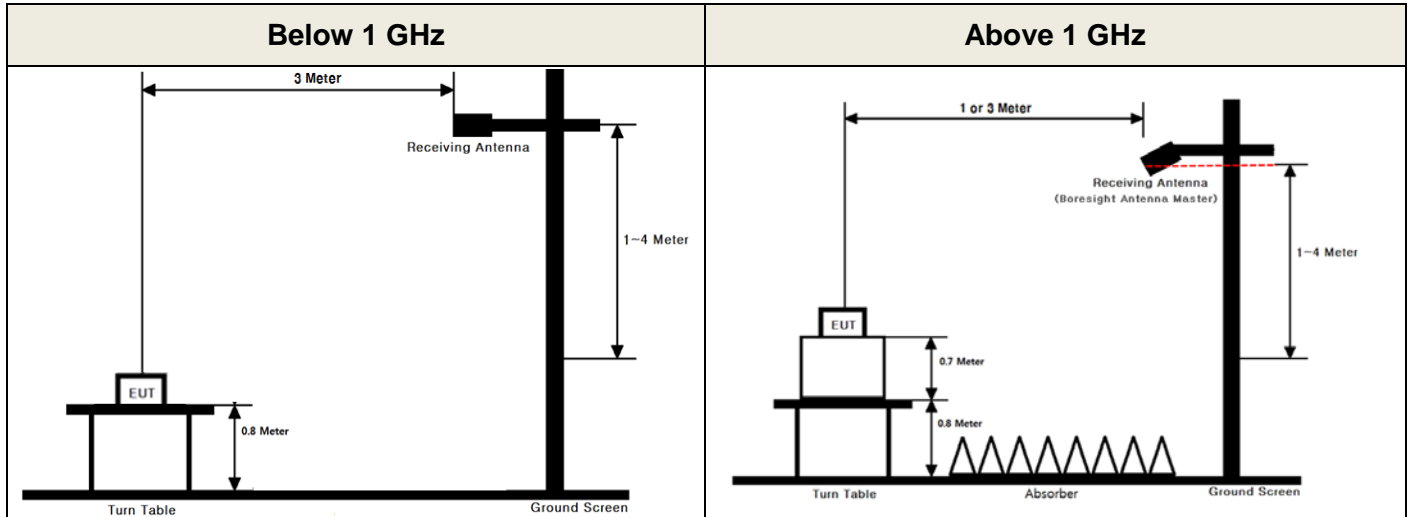

▪ Conducted Measurement

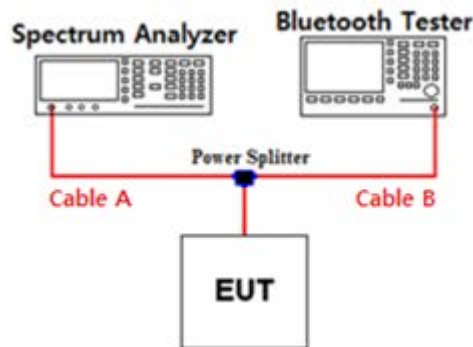

Path loss information

| Frequency (GHz) | Path Loss (dB) | Frequency (GHz) | Path Loss (dB) |
|-----------------------|----------------|-----------------|----------------|
| 0.03 | 6.53 | 15 | 7.83 |
| 1 | 6.83 | 20 | 8.09 |
| 2.402 & 2.441 & 2.480 | 6.96 | 25 | 8.69 |
| 5 | 7.04 | - | - |
| 10 | 7.38 | - | - |

Note 1: The path loss from EUT to Spectrum analyzer was measured and used for test.
 Path loss (S/A's correction factor) = Cable A + Power Splitter

APPENDIX II

Unwanted Emissions (Radiated) Test Plot

GFSK & Lowest & X & Ver

Detector Mode : PK

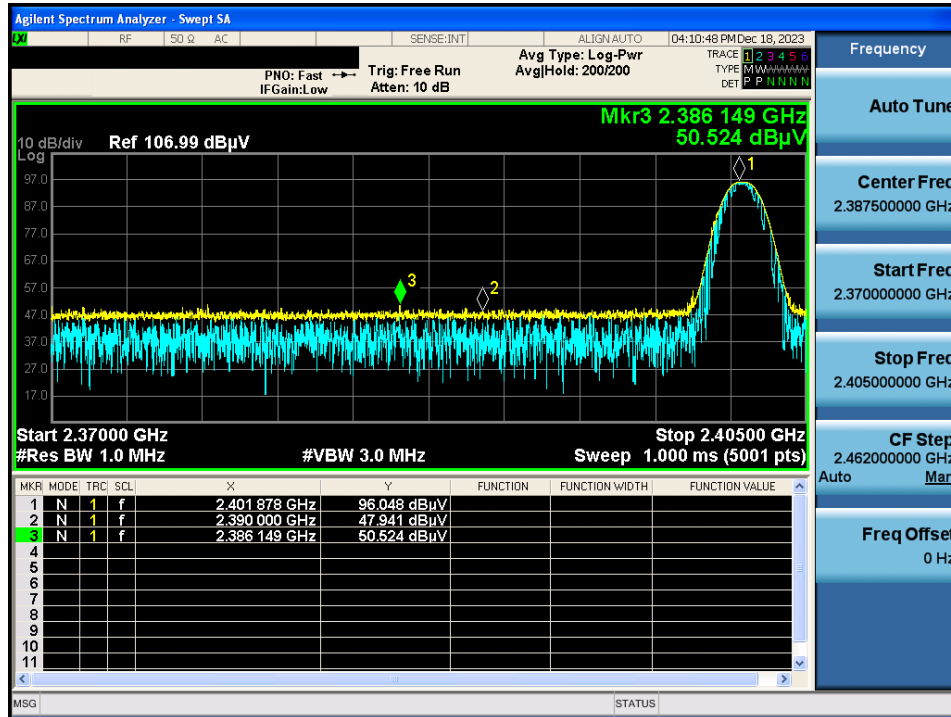

GFSK & Highest & X & Ver

Detector Mode : PK

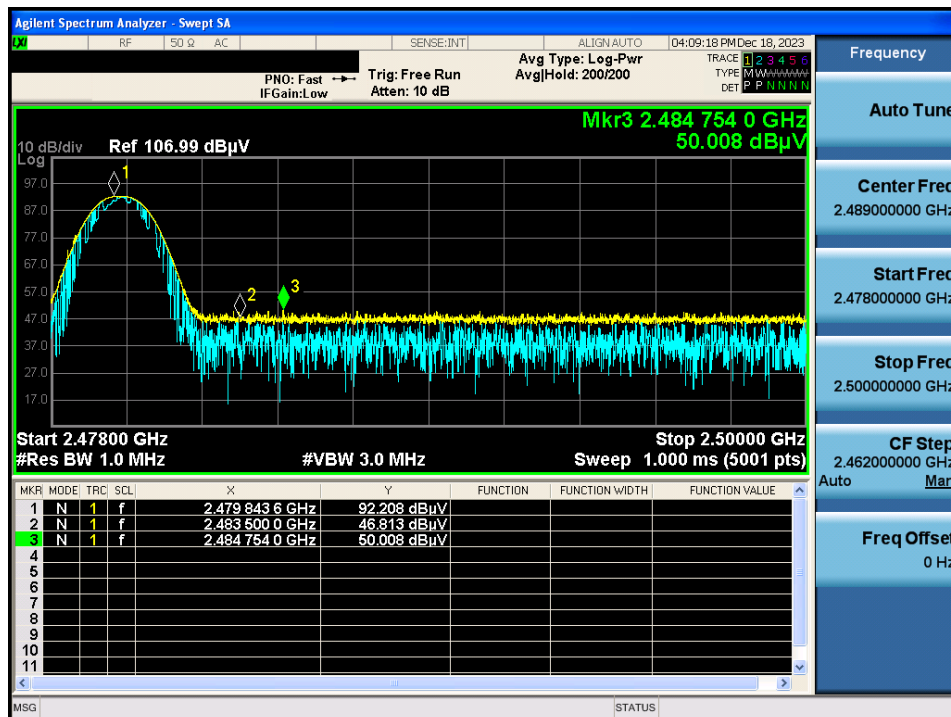

$\pi/4$ DQPSK & Lowest & X & Ver

Detector Mode : PK

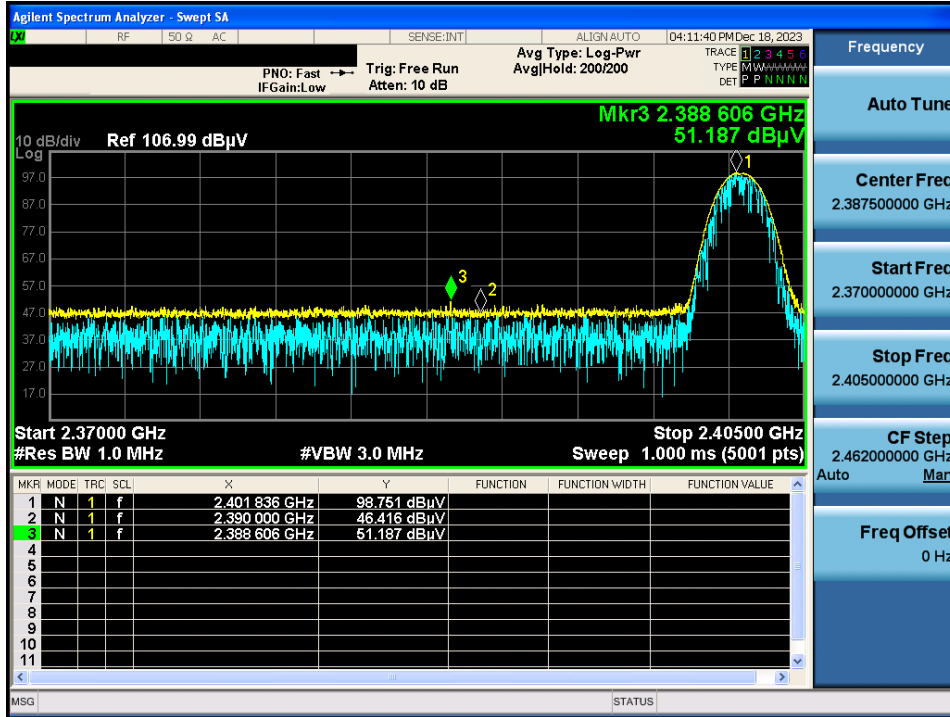

$\pi/4$ DQPSK & Highest & X & Ver

Detector Mode : PK

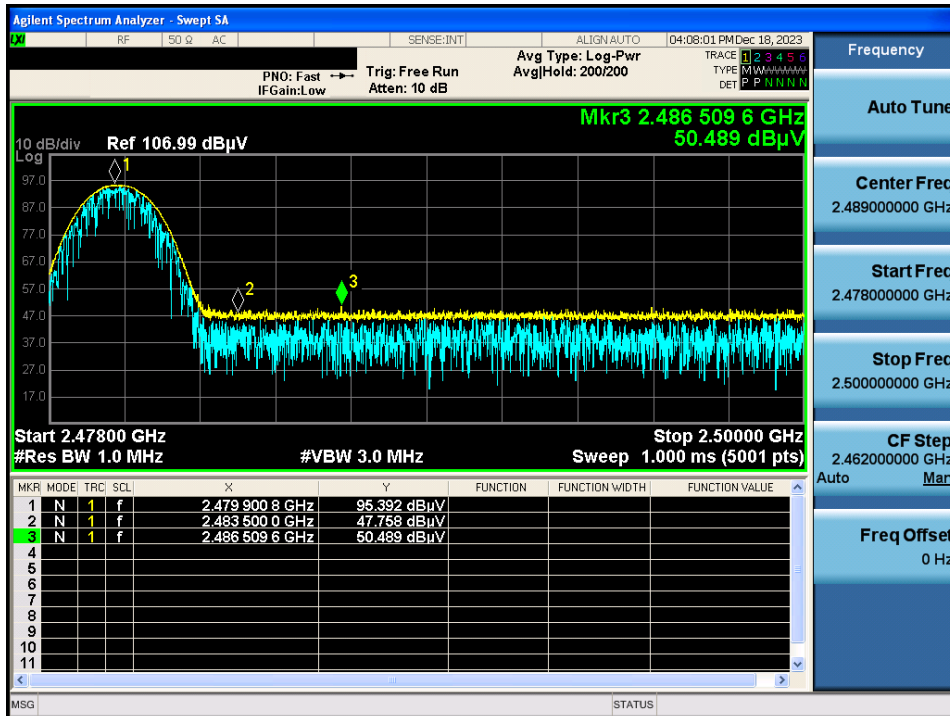

8DPSK & Lowest & X & Ver

Detector Mode : PK

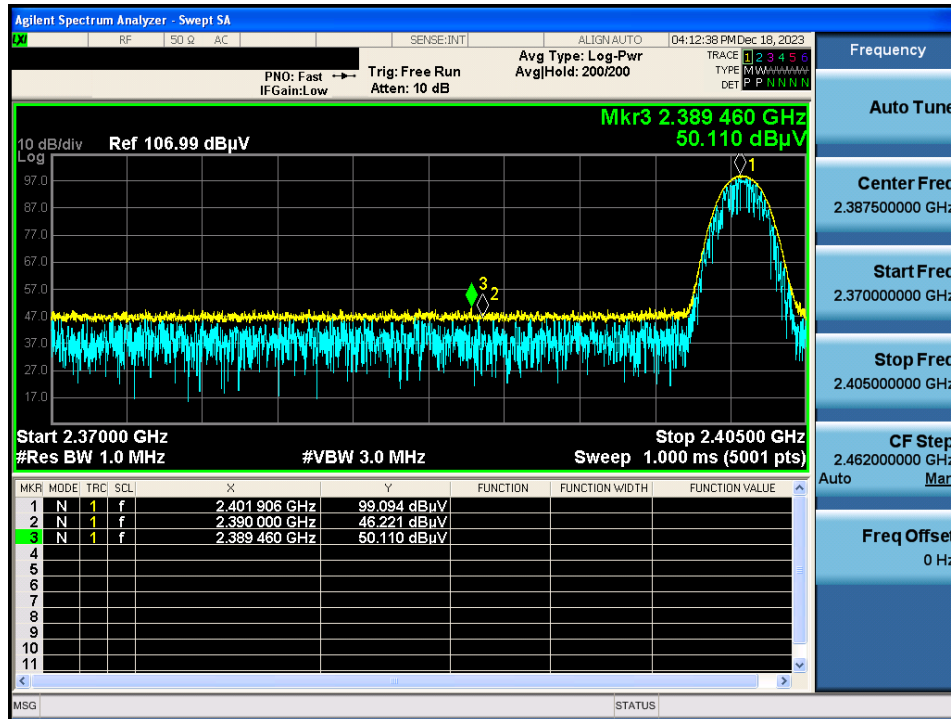

8DPSK & Highest & X & Ver

Detector Mode : PK

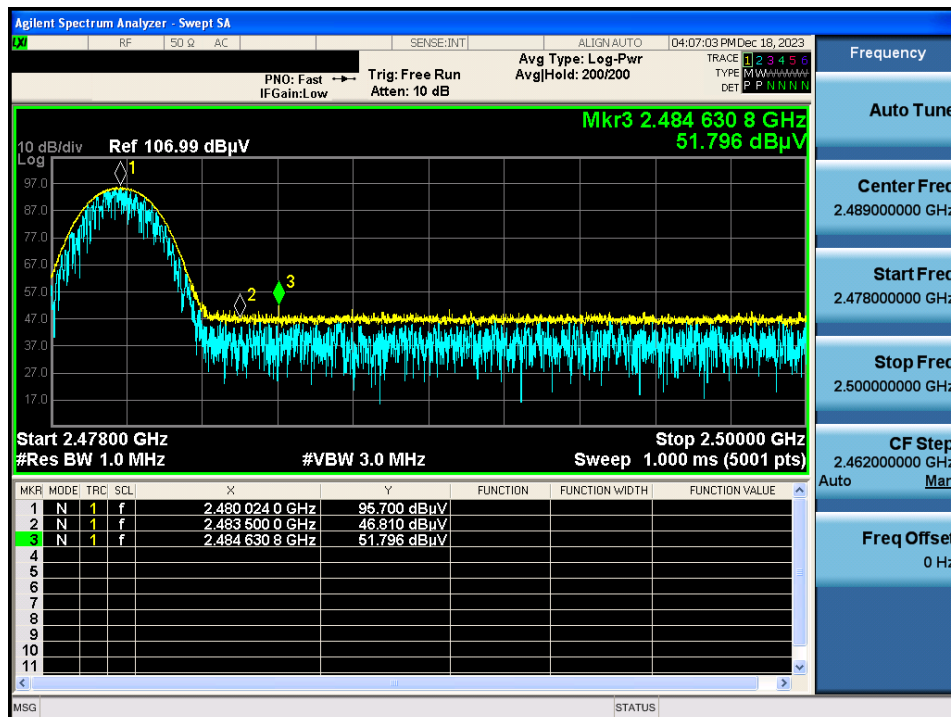

GFSK & Lowest & X & Hor

Detector Mode : PK

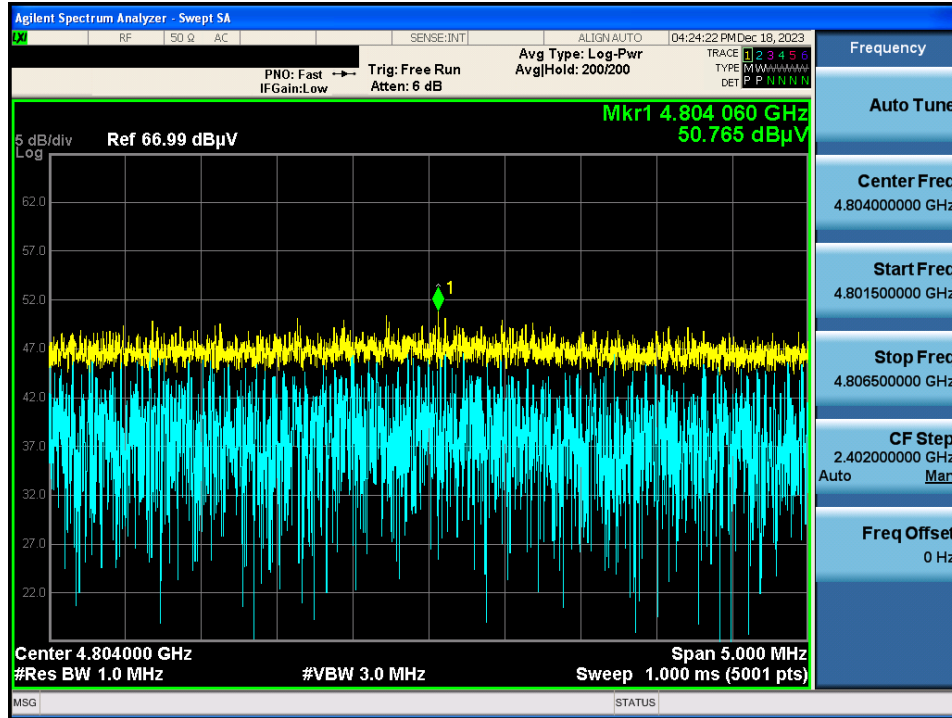

$\pi/4$ DQPSK & Middle & X & Hor

Detector Mode : PK

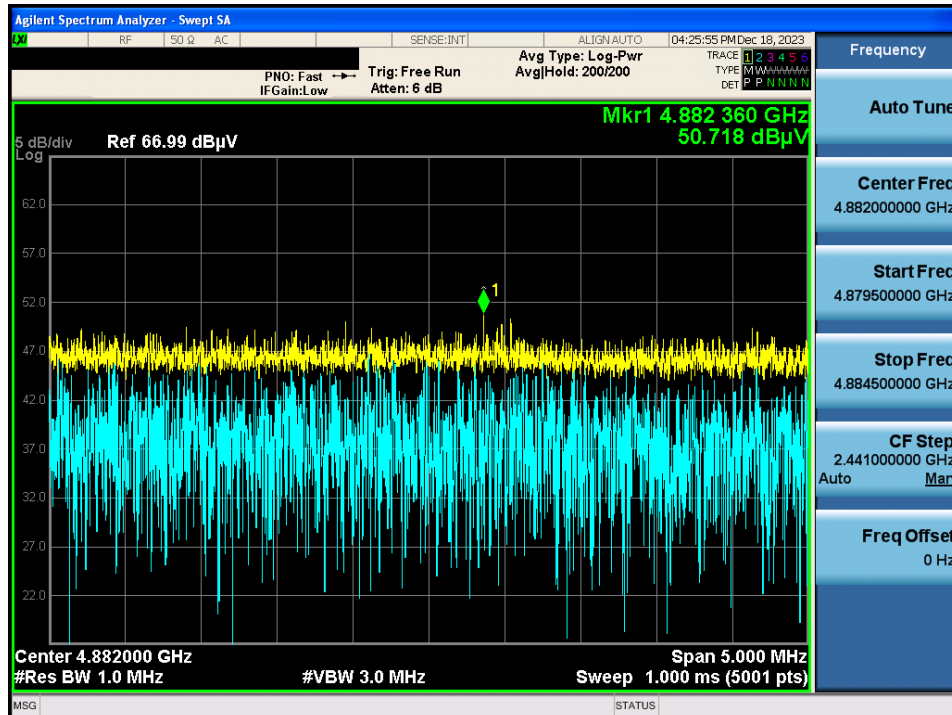

8DPSK & Lowest & X & Hor

Detector Mode : PK

