

Register your product and get support at

www.philips.com/welcome

SCD610

SCD609



User manual

PHILIPS

Contents

1	Introduction	24
----------	---------------------	-----------

2	Important Safety Instructions	26
	Electromagnetic fields (EMF)	27
	Recycling	27

3	Overview	28
	Parent unit	28
	Baby unit	28

4	Get started	30
	Charge the parent unit	30
	Set up the baby unit	31
	Wall mount the baby unit	31

5	Use your baby monitor	33
	Operating range	33

6	Menu	34
	Zoom & Pan	34
	Voice activation	34
	Adjust brightness	34
	Add/delete cameras	34
	Change the language	35
	Reset	35

7	Optimize the battery life of the parent unit	36
----------	---	-----------

8	Guarantee and service	36
----------	------------------------------	-----------

9	Frequently asked questions	37
----------	-----------------------------------	-----------

1 Introduction

Congratulations on your purchase and welcome to Philips AVENT! To fully benefit from the support that Philips AVENT offers, register your product at www.philips.com/AVENT.

Philips AVENT is dedicated to producing caring and reliable products that give parents the reassurance that they need. This Philips AVENT baby monitor provides round-the-clock support by ensuring that you can see and hear your baby in perfect clarity.

The instructions are intended for both SCD610 and SCD609.

- SCD610

Parent unit

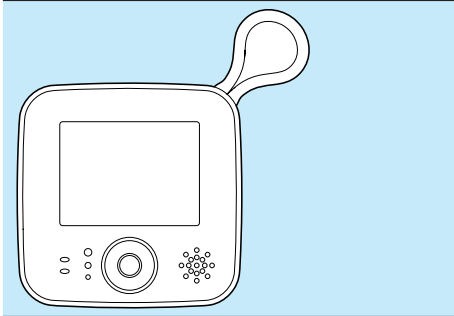

Baby unit



- SCD609

Baby unit

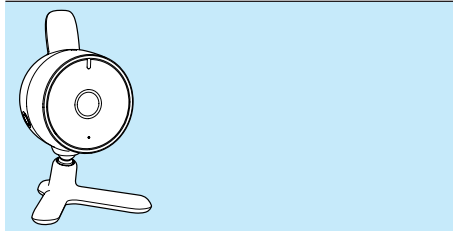

Know these safety symbols



 This “bolt of lightning” indicates uninsulated material within your unit may cause an electrical shock. For the safety of everyone in your household, please do not remove product covering.

 The “exclamation point” calls attention to features for which you should read the enclosed literature closely to prevent operating and maintenance problems.

WARNING: To reduce the risk of fire or electric shock, this apparatus should not be exposed to rain or moisture and objects filled with liquids, such as vases, should not be placed on this apparatus.

CAUTION: To prevent electric shock, match wide blade of plug to wide slot, fully insert.

Compliance information

The FCC ID number is located on the casing bottom of the parent unit and in the battery compartment of the baby unit.

The term 'IC' before the certification number signifies that Industry Canada technical specifications were met. This certification means that the equipment meets certain radio communications and operational requirements. This device complies with Part 15 of the FCC Rules and RSS-210 of Industry Canada. Operation is subject to the following two conditions: (1) this device may not cause harmful interference, and (2) this device must accept any interference received, including interference that may cause undesired operation.

Radio interference

This equipment has been tested and found to comply with the limits for a Class B digital device, pursuant to Part 15 of the FCC Rules and ICES-003 of Industry Canada. These limits are designed to provide reasonable protection against harmful interference in a residential installation. This equipment generates, uses and can radiate radio frequency energy and, if not installed and used in accordance with the instructions, may cause harmful interference to radio communications. However, there is no guarantee that interference will not occur in a particular installation. If this equipment does cause harmful interference to radio or television reception, which can be determined by turning the equipment off and on, the user is encouraged to try to correct the interference by one or more of the following measures:

- Reorient or relocate the receiving antenna.
- Increase the separation between the equipment and receiver.
- Connect the equipment to an outlet on a circuit different from that to which the receiver is connected.

RF Radiation Exposure Statement

This equipment complies with FCC RF radiation exposure limits set forth for an uncontrolled environment. This equipment should be installed and operated with a minimum distance of 7 3/4 inches / 20 centimeters between the radiator and your body. For handheld operation, this equipment has been tested and meets the FCC RF exposure guidelines. For body-worn operation, this product has been tested and meets the FCC RF exposure guideline when used with the belt clip supplied with this product. This transmitter must not be co-located or operating in conjunction with any other antenna or transmitter. Use of other accessories may not ensure compliance with FCC RF exposure guidelines. This equipment also complies with Industry Canada RSS-102 with respect to Canada's Health Code 6 for Exposure of Humans to RF Fields.

Do not attempt to repair or modify this equipment

Any repairs or alterations made by the user to the equipment may void the warranty and compliance of the equipment. Changes or modifications made to this equipment not expressly approved by Philips AVENT may void the FCC authorization to operate this equipment. For assistance visit our website www.philips.com/AVENT or call 1-800-54-AVENT (1-800-542-8368).

2 Important Safety Instructions

Read this user manual carefully before you use the baby monitor and save the user manual for future reference.



Warning

- To prevent strangulation with the power cord, always keep the baby unit and the power cord out of baby's reach, at least 1 meter/3.5 feet away. Do not use extension cords.

Caution: Risk of explosion, electric shock, short circuit, or leakage

- The apparatus shall not be exposed to dripping or splashing and no objects filled with liquids, such as vases, shall not be placed on the apparatus.
- Before you connect the baby monitor to the mains, make sure that the voltage indicated on the adapters of the baby monitor corresponds to the local mains voltage.
- Where the MAINS plug is used as the disconnect device, the disconnect device shall remain readily operable.
- Use the supplied adapter to connect the baby unit to the mains.
- Use the supplied adapter to charge the parent unit.
- To prevent electric shock, do not open the housing of the baby unit or parent unit except for the battery compartments.
- Make sure that your hands are dry when you insert or replace batteries (battery pack).
- For the parent unit, use only the rechargeable battery pack supplied with the baby monitor. Charge the rechargeable battery pack as described in this user manual.
- To avoid a risk of explosion, replace the battery with a correct type.

- Dispose of used batteries according to instructions.
- To prevent battery explosion or leakage, which can damage the baby monitor and cause burns and skin or eye irritation:
 - do not recharge non-rechargeable batteries,
 - insert batteries in the right direction (+/-),
 - remove batteries if you are not going to use the product for more than 30 days,
 - keep the battery away from excessive heat such as sunshine, fire or the like,
- To prevent the battery from heating up or releasing toxic materials, hydrogen, or oxygen, do not:
 - overcharge,
 - short circuit,
 - reverse charge, or
 - mutilate batteries.
- To handle damaged or leaked batteries, wear protective gloves to protect your skin.

Adult supervision

- This baby monitor is intended as an aid. It is not a substitute for responsible and proper adult supervision and should not be used as such.
- Never place the baby unit inside the baby bed or playpen.
- To prevent overheating, do not cover the baby monitor with a towel, blanket, or any other items.
- When your baby monitor uses a power outlet, make sure that you can easily access the power outlet.
- For their safety, do not allow children to play with the baby monitor:

Storage precautions

- Use and store the baby monitor between 10°C (50°F) and 35°C (95°F). Keep the baby monitor out of direct sunlight.

Replacement

- If you need to replace the adapters, use the type of adapters specified in this user manual.
- If you need to replace the battery, please contact the customer care center.

Electromagnetic fields (EMF)

This Philips AVENT appliance complies with all standards regarding electromagnetic fields (EMF). If handled properly and according to the instructions in this user manual, the appliance is safe to use based on scientific evidence available today.

Recycling



Your product is designed and manufactured with high quality materials and components, which can be recycled and reused. When you see the crossed-out wheel bin symbol attached to a product, it means the product is covered by the European Directive 2002/96/EC:



Never dispose of your product with other household waste. Please inform yourself about the local rules on the separate collection of electrical and electronic products. The correct disposal of your old product helps prevent potentially negative consequences on the environment and human health.

Your product contains batteries covered by the European Directive 2006/66/EC, which cannot be disposed of with normal household waste.

When you see the crossed-out wheel bin symbol with the chemical symbol 'Pb', it means that the batteries comply with the requirement set by the directive for lead:



Please inform yourself about the local rules on separate collection of batteries. The correct disposal of batteries helps prevent potentially negative consequences on the environment and human health.

3 Overview

Parent unit

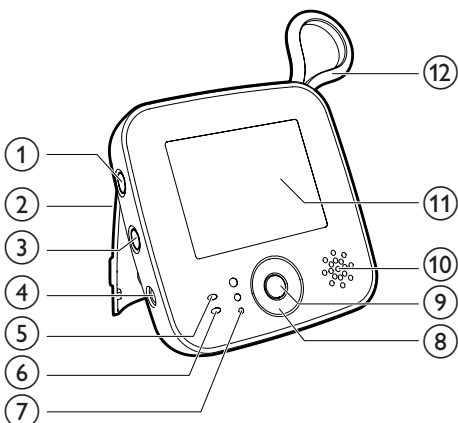

- ① **ON/OFF switch**
 - Press and hold to turn the parent unit on or off
- ② **Stand**
- ③ **Voice activation button**
 - Press and hold to turn voice activation on or off
- ④ **Connector for the supplied DC adapter**
- ⑤ **Power on/off light**
 - Flashing red: The rechargeable battery is low in power.
 - Flashing green: The rechargeable battery is in charging mode.
 - Solid green: The unit is running.
- ⑥ **Voice activation light**
- ⑦ **Sound level lights**
 - Indicate the level of sound in your baby's room
- ⑧ **Key**
 - + [UP]
 - [DOWN]
 - ◀ [LEFT]

▶ [RIGHT]

- ⑨ **Menu**
- ⑩ **Speaker**
- ⑪ **Video display**
 - ▬ Signal strength indicator
 - ▬ Battery power indicator
 - ▬ Low battery power indicator
- ⑫ **Antenna**

Connector for the supplied AC/DC adapter

 - Input: 100-240V AC
 - Output: 6.0V DC, 500 mA
 - Model number: For UK, SSW-1920UK-2; For the other European countries, SSW-1920EU-2

Baby unit

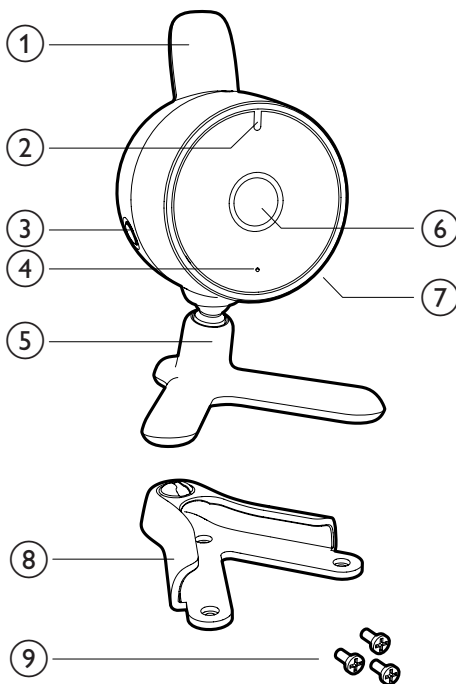

- ① **Antenna**
- ② **Power-on light**

- In green: The baby unit is turned on

③ **ON/OFF switch**

- Press and hold to turn the baby unit on or off
- Short press to pair the parent unit while the baby unit is on.

④ **Microphone**

⑤ **Stand**

⑥ **Lens**

⑦ **Connector for the supplied DC adapter**

⑧ **Wall mount**

⑨ **Wall mount screws**

Connector for the supplied AC/DC adapter

- Input: 100-240V AC
- Output: 6.0V DC, 500 mA
- Model number: For UK, SSW-1920UK-2; For the other European countries, SSW-1920EU-2

4 Get started

Charge the parent unit

Note

- Make sure your hands and the unit are dry when you insert and remove the rechargeable battery.

Do as follows to charge the parent unit before you use it for the first time or when the parent unit indicates that the battery is low.

- ↳ The empty battery symbol flashes on the video display and the battery on/off light on the parent unit flashes red.

Note

- If the battery is completely empty, the parent unit automatically switches off.
- The batter Model No. is BL-5C, 1050mAh.

- 1 To remove the battery door, slide to the right.

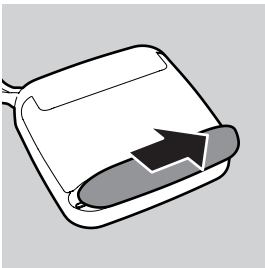

- 2 Insert the rechargeable battery.

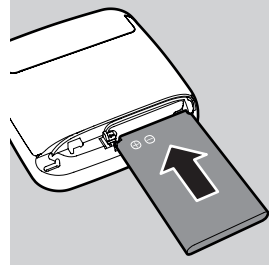

- 3 Reattach the lid.
- 4 Insert the plug into parent unit and put the adapter in a wall socket.

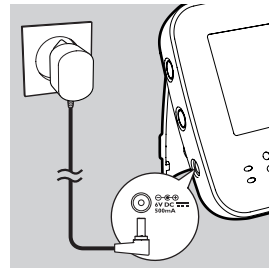

- ↳ The battery on/off light on the parent unit flashes green.
- ↳ When the battery is fully charged, the battery light turns solid green.

Note

- When you charge the parent unit for the first time or after a long time not being used, switch it off and let it charge continuously for at least 8 hours.
- When the parent unit has been charged for the first time, the operating time is less than 7 hours. The rechargeable battery only reaches its full capacity after you have charged and discharged it three times.
- The battery gradually discharges, even when the parent unit is switched off.

Tip

- Charging normally takes 5 hours, but it takes longer when the parent unit is switched on during charging. To keep the charging time as short as possible, switch off the parent unit during charging.
- When the battery is fully charged, the parent unit can be used cordlessly for approximately 7 hours if it is in voice activation mode. If the video is on continuously, the parent unit can be used cordlessly for approx. 5 hours.

Set up the baby unit

Caution

- Keep the baby unit out of the reach of the baby. Never place the baby unit inside or mount it on the baby's bed or playpen.

Note

- If you use wireless devices, microwave oven or a DECT-system and you experience interference on either the parent unit or baby unit, move the parent unit further away until there is no more interference.

- 1 Place the baby unit at least 1 meter/3.5 feet away from your baby.
- 2 Place the baby unit on a stable surface. You may also mount the baby unit on a wall mount which is provided. For more information, please refer to the next section.
- 3 Adjust the position of the baby unit in a way that ensures the best visibility of your baby.

- 4 Insert the plug into the baby unit and put the adapter in a wall socket.

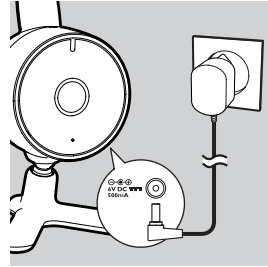

- 5 Place the parent unit within the operation range of the baby unit. Make sure it is at least 1.5 metre/5 feet away from the baby unit to avoid acoustic feedback.
- 6 For more information on the operating range, see section "Operating range" below.

Tip

- Position the baby unit at a higher level to get a good overview of the baby's bed or playpen.

Wall mount the baby unit

Caution

- When the baby unit is wall mounted, manage the cord of the baby unit so that it is fixed on the wall, not accessible by the baby.

- 1 Use the paper template to mark the positions of the three screws to wall mount your baby unit.
- 2 Drill holes at the three positions.
- 3 Place wall plugs in the wall.

- 4 Screw in the wall-mount.

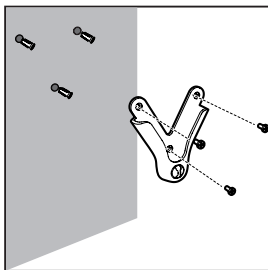

- 5 Put the baby unit into the wall-mount.

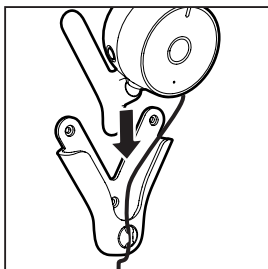

- 6 Place the cable into the holder at the wall-mount.

- 7 Adjust the baby unit so that you can get a best view of your baby.

5 Use your baby monitor

To see your baby,

- 1 Press  on the parent/baby unit.
 - ↳ The parent/baby unit turns on, and all indicators on the parent/baby unit light up briefly.

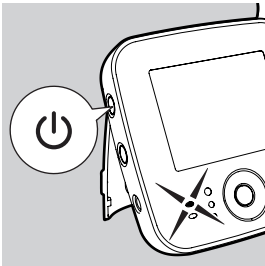
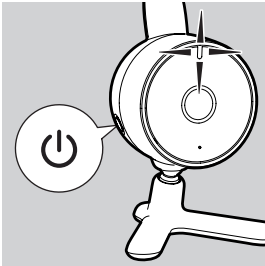

- ↳ Philips AVENT logo appears on the display briefly.
- ↳ If no link is established, a **[NOT LINKED!CAM1 OUT OF RANGE]** message is flashing on screen. The parent unit beeps from time to time.

Tip

- It takes about 15 seconds to establish the link between the parent unit and the baby unit.
- The battery symbol  flashes before the battery runs out of power.

Operating range

The operating range of the baby monitor is 150 metres/490 feet in open air. The range varies depending on the surroundings and other disturbing factors.

This monitor is designed to operate at its best within a 150m range, suitable for most household environments. The operating range and quality of the connection varies depending on the number of obstructions, like walls or buildings, in between the two units.

Note

- The CAM1 refers to the default camera.

6 Menu

- 1 Press menu button on the parent unit.
↳ Menu is displayed.
- 2 Press +/- to move up or down the menu/submenu, and press ◀/▶ to move left or right across menu/submenu.
- 3 To confirm, press the center key or ▶
- 4 To exit, press ◀.

Zoom & Pan

- 1 Press menu button.
- 2 Select **[ZOOM & PAN]** from the menu to zoom in and out the view, and pan your view.

Menu option	Description
[ZOOM+]	Zoom in the view
[PAN]	Pan the view to adjust the focus of the view
[ZOOM-]	Zoom out the view

Voice activation

Voice activation

When the voice activation mode is on, the video display only switches on when the baby unit picks up a sound. As long as no sound is detected, the video display is off to save power. When you press a key or a sound is detected, the parent unit is activated, and will be off again after 20 seconds time-out. The timer is reset each time when:

- A sound exceeds the set voice activation level
- One button on parent unit (menu, +, -, ◀, ▶) is pressed on.

Turn on voice activation

Press the button  on the side of the parent unit, and the voice activation indicator slowly blinks.

Change voice activation level

- 1 Press menu button on the parent unit.
- 2 Select **[VOICE ACTIVATION LEVEL]** of the baby unit.

Menu option	Description
[HIGH]	High voice activation level
[MID]	Medium voice activation level
[LOW]	Low voice activation level

Note

- When voice activation is active, the LOOP ALL CAMs in the switch CAM dialogue is not available.
- When the LOOP ALL CAMs is active, the VOICE ACTIVATION function is not available. An info screen will be shown when you press the VOX button.

Adjust brightness

- 1 Press menu button on the parent unit.
- 2 Select **[ADJUST BRIGHTNESS]**.
- 3 Press +/- to adjust the brightness of the video display.

Add/delete cameras

Add a new camera

A maximum of 4 cameras can be paired to a parent unit. The menu has 4 positions named CAM1 up to CAM4. Your default setting will be at CAM1. You can select any of the positions in the list to assign a camera. It is up to you to decide which camera is which item in the list.

Note

- Only when a position is empty in the list, a new camera can be paired.

- 1 Press menu button on the parent unit.
- 2 Select **[ADD/DEL CAM]**.
↳ The paired CAM list is displayed.

Note

- A paired CAM cannot be paired again on another position when it is assigned to a position.

- 3 Select **[ADD CAM]**.
↳ An info screen will indicate that the parent unit is searching for the new camera. You are prompted to shortly press **⏻** of the baby unit, with the baby unit being on.
- 4 Short press **⏻** of the baby unit, less than 1 second.
↳ An info screen will confirm when the pairing process is successful.

Delete a camera

- 1 From the paired CAM list, select the camera to be deleted.
↳ The dialog **[DELETE CAM1 FROM LIST?]** is displayed.

- 2 Press **▶** or menu button to confirm, or press **◀** to return.

For example, when "CAM1 DELETE" is highlighted and selected, CAM1 will be deleted.

Select other cameras

When multiple CAMs are listed in the paired camera list, you may switch between different cameras.

- 1 Press **◀** or **▶** to show the CAM identification bar indicating which camera is currently linked to the parent unit.

Note

- When only one camera is in the paired list, the camera identification bar, i.e. pressing **◀** and **▶** will not be displayed.

- 2 Press **◀** and **▶** to navigate this bar to select other CAMs in the list, i.e. parent unit tries to connect to camera.

Loop all cameras

Switch on the tab LOOP ALL cameras to check what is going on through all paired cameras.

Note

- When VOICE ACTIVATION is active, the LOOP ALL function is not selectable.

Change the language

- 1 Press menu button on the parent unit
- 2 select **[LANGUAGE]** to define your desired language.

Menu option	Description
GB	English
FR	French

Reset

To reset the parent unit:

- 1 Press and hold **⏻** to turn off the parent unit.
- 2 Press and hold **-** on the parent unit.
- 3 When you hold **-**, turn on the parent unit.
↳ The parent unit is reset.

7 Optimize the battery life of the parent unit

- Recharge the parent unit when you see the low battery icon. Fully recharge the parent unit before you use it again, as completely draining the rechargeable battery may reduce its life.
- Remove the rechargeable battery pack from the parent unit if you are not going to use it for a week or longer.
- Always fully recharge the parent after a long period of time.
- If you experience any issue while charging your battery, you may contact your dealer or a Philips service centre.

8 Guarantee and service

If you need service or information or if you have a problem, please visit the Philips AVENT website at www.philips.com/AVENT welcome or contact the Philips Consumer Care Centre in your country. You can find the phone number of the Philips Consumer Care Centre in the worldwide guarantee leaflet. If there is no Philips Consumer Care Centre in your country, please visit the local Philips dealer.

9 Frequently asked questions

If you don't find the solution you need in this section, you can get support at www.philips.com/AVENT or contact the Philips Consumer Care Center in your country.

Problems	Possible causes	Solutions
My parent/baby unit will not switch on.	The unit is not connected to the power supply.	Connect the unit to a power supply.
	The battery is empty.	Replace the battery and make sure that it is correctly inserted.
My baby unit will not switch on.	The unit is not connected to a power supply.	Connect the unit to a power supply.
I cannot establish a connection. The parent unit beeps and the a "NOT LINKED! CAMx OUT OF RANGE" message is flashing on.	The units are out of range.	Move the units closer (see "Operating range")
	Parent and baby units are too far apart.	Move the parent unit at least 1.5 metres/ 5 feet away from the baby unit.
I get interference. I can only hear intermittently.	The baby unit is switched off.	Switch on the baby unit.
	The units are out of range.	Move the units closer.
I cannot hear anything through my parent unit.	The parent unit picks up signals from other appliances or baby monitors.	Move the parent unit away from other 2.4GHz wireless appliances such as telephones.
	The volume of parent unit is set too low or it is on mute.	Increase the volume of the parent unit.
	The units are out of range.	Move the units closer.
	You have switched on the automatic voice activation.	When it is activated, the video is displayed on when the baby unit picks up a sound. As long as no sound is detected, the video display is off to save power.
My range is less than 150 metres/ 490 feet.	The voice activation level is set too high.	Increase the voice activation level.
	Environmental obstructions may be affecting your range.	Move the units closer.

The battery light on the parent unit flashes red.	The rechargeable battery of the parent unit is running low.	Recharge the battery.
The battery of the parent unit runs low quickly.	The volume is set too high and the unit consumes more power.	Decrease the volume.
	The video display is switched on continuously and the unit consumes more energy.	Activate the automatic voice activation mode to increase the operating time.
Is my baby unit secure from eavesdropping?		The 2.4GHz digital technology of this baby monitor guarantees no eavesdropping.
I hear other sounds from my parent unit.	The baby unit is too far from the baby	Move the baby unit closer to your baby with a minimum distance of 1 metre/ 3.5 feet.
	The voice activation level is set too low.	Increase the voice activation level.
	The baby unit is close to other sound source.	Move the baby unit away from the sound source.
The charging of the parent unit takes a long time.	The unit is used for the first time or after a long period of disuse.	Allow at least 8 hours of charging time.
	The parent unit is switched on during charging	Switch off the parent unit during charging.
The video monitor makes some a high-pitched noise.	The units may be too close to each other:	Move the parent unit at least 1.5 metres/ 5 feet away from the baby unit.
	The volume of the parent unit may be set too high.	Decrease the volume of the parent unit.
The parent unit makes a buzzing sound.	The units are out of range.	Move the units closer:
	The parent unit picks up signals from other appliances or baby monitors.	Move the parent unit away from other 2.4GHz wireless appliances such as telephones.
	The rechargeable battery of the parent unit may be low.	Recharge the battery.
The video display flickers.	The units are nearly out of range.	Move the units closer:
	The parent unit picks up signals from other appliances or baby monitors.	Move the parent unit away from other 2.4GHz wireless appliances such as telephones.
	The rechargeable battery of the parent unit may be low.	Recharge the battery.
There is no image on the video display when the power on light is on.	The parent unit may be in the automatic voice activation mode.	Press the automatic voice activation button again to switch on the video display.
The image on the video display is unclear.	The display brightness may be set too low or too high.	Adjust the display brightness.

The image on the video display is unclear in night vision.	The distance between the baby and the baby unit may be too long.	Make sure that the baby unit is placed 1 to 1.5 metres/ 3.5 to 5 feet away from the baby.
The parent unit does not charge when I have plugged it in.	The rechargeable battery may have reached the end of its life.	Replace the rechargeable battery.
The night vision LED is still ON when the ambient condition is bright enough.	The baby unit's light sensor (located on top of the housing near the antenna) is blocked from the ambient light.	Relocate the baby unit or leave it as it is. It will not affect the picture of the display.



Tip

- Product information is subject to change without prior notice.

In US manufactured for Philips Consumer Lifestyle,
A division of Philips Electronics North America Corporation,
P.O. Box 10313, Stamford, CT 06904

In Canada imported for Philips Electronics Ltd,
281 Hillmount Road, Markham, ON L6C2S3
Call TOLL-FREE 1.800.54.AVENT

En EE.UU. fabricado para Philips Consumer Lifestyle,
Una división de Philips Electronics North America Corporation,
P.O. Box 10313,, Stamford, CT 06904

En Canadá importado para Philips Electronics Ltd,
281 Hillmount Road, Markham, ON L6C2S3
Llame gratuitamente: 1.800.54.AVENT

Aux États-Unis fabriqué pour: Mode de Vie/ Consommateurs Philips,
une division de Philips Electronics North America Corporation,
P.O. Box 10313, Stamford, CT 06904

Au Canada importé pour Philips Électronique Ltée,
281 Hillmount Road, Markham, ON L6C2S3
Appelez SANS FRAIS: 1.800.54.AVENT

R&TTE Directive 1999/5 EC

AT ✓	DK ✓	DE ✓	IT ✓	MT ✓	SK ✓	GB ✓	CH ✓
BE ✓	EE ✓	GR ✓	LV ✓	NL ✓	SI ✓	IS ✓	BG ✓
CY ✓	FI ✓	HU ✓	LT ✓	PL ✓	ES ✓	LI ✓	RO ✓
CZ ✓	FR ✓	IE ✓	LU ✓	PT ✓	SE ✓	NO ✓	TR ✓



PHILIPS
SCD610_609



CE01680

 100% recycled paper
100% papier recyclé
100% papel reciclado