

PHILIPS

© N.V. Philips Gloeilampenfabrieken NV, N.V. Philips Gloeilampenfabrieken US.
 Alle rechten voorbehouden. Vervoerswijze: Air freight is reserved. Reproduction is
 prohibited without the written consent of the copyright owner.
 Alle rechten voorbehouden. Vervoerswijze: Luchtvervoer is voorbehouden.
 Het is toegestaan het ontwerp te kopiëren voor gebruik op andere producten.
 All rights reserved. Transportation mode: Air freight is reserved. Reproduction is
 prohibited without the written consent of the copyright owner.

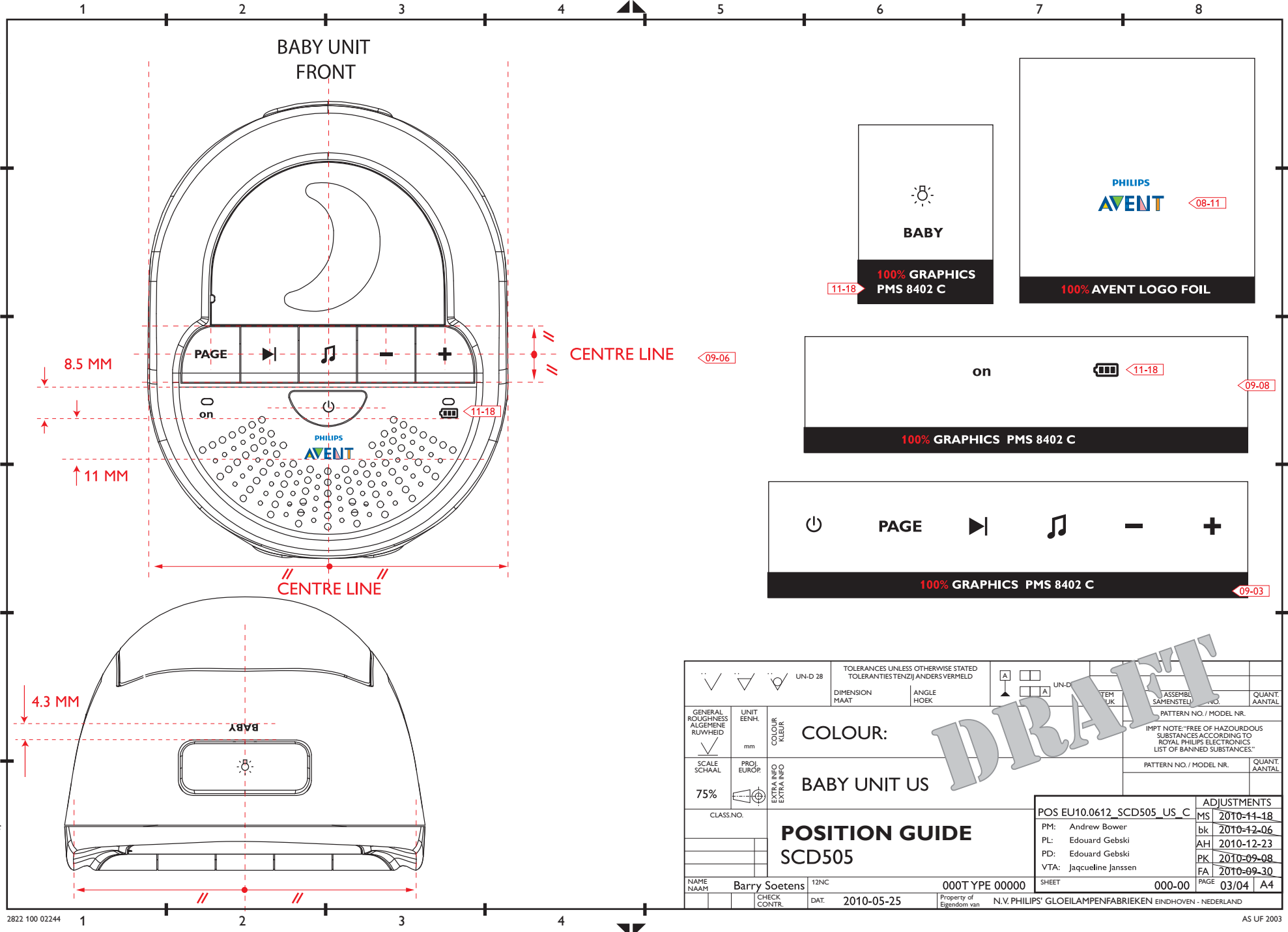

UN-D 28		TOLERANCES UNLESS OTHERWISE STATED TOLERANTIES TENZIJ ANDERS VERMELD		UN-D	
DIMENSION MAAT		ANGLE HOEK		ITEM LUK	
GENERAL ROUGHNESS ALGEMENE RUWHEID		UNIT EENH. mm		PATTERN NO. / MODEL NR.	
SCALE SCHAAL		PROJ. EUROR.		ASSEMBLY SAMENSTEL.	
75%		EXTRA INFO EXTRA INFO		NO. AANTAL	
CLASS.NO.		COLOUR: BABY UNIT US		IMPT NOTE: "FREE OF HAZARDOUS SUBSTANCES ACCORDING TO ROYAL PHILIPS ELECTRONICS LIST OF BANNED SUBSTANCES"	
NAME NAAM		12NC		PATTERN NO. / MODEL NR.	
Barry Soetens		000T YPE 00000		QUANT. AANTAL	
CHECK CONTR.		DAT. 2010-05-25		POS EU10.0612_SCD505_US_C	
Property of Eigendom van		N.V. PHILIPS' GLOEILAMPENFABRIEKEN EINDHOVEN - NEDERLAND		ADJUSTMENTS	
SHEET		000-00		MS 2010-11-18	
PAGE		03/04		bk 2010-12-06	
A4				AH 2010-12-23	
				PK 2010-09-08	
				FA 2010-09-30	

PHILIPS

© N.V. Philips' Gloeilampenfabrieken 19...
 Alle rechten voorbehouden. Het verspreiden van...
 is niet toegestaan. Het kopiëren van de afbeeldingen...
 is niet toegestaan.

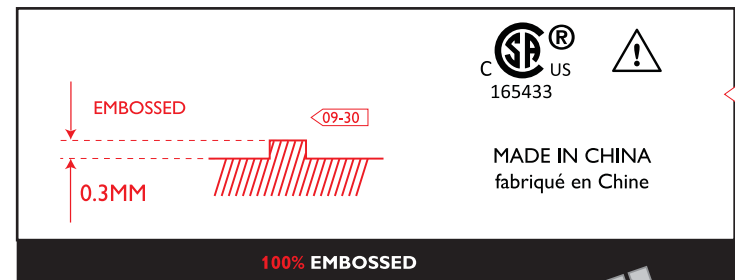
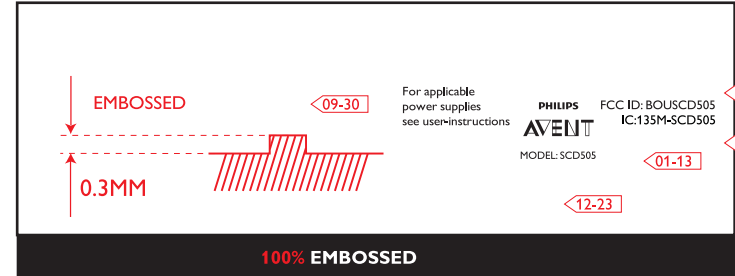
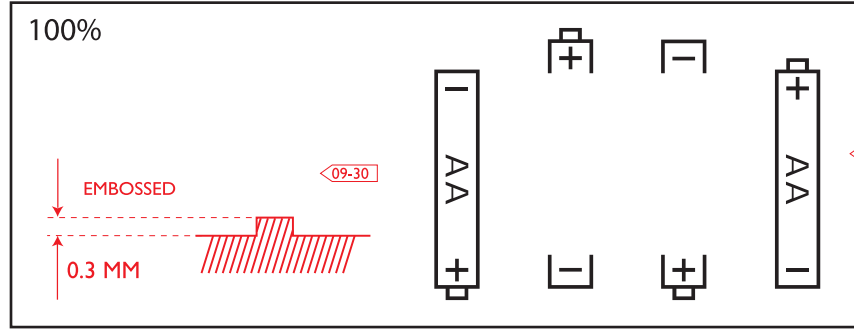
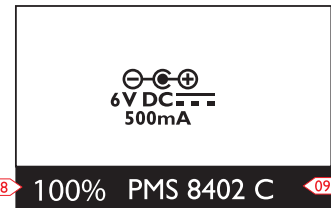
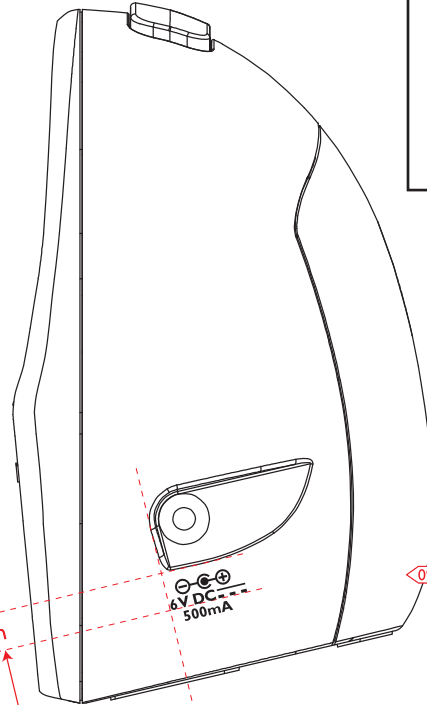
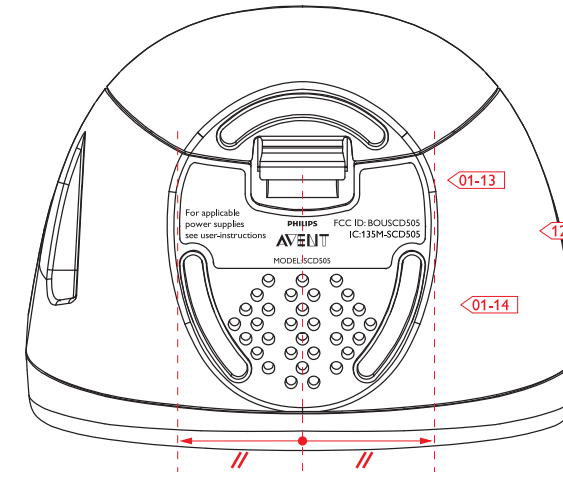
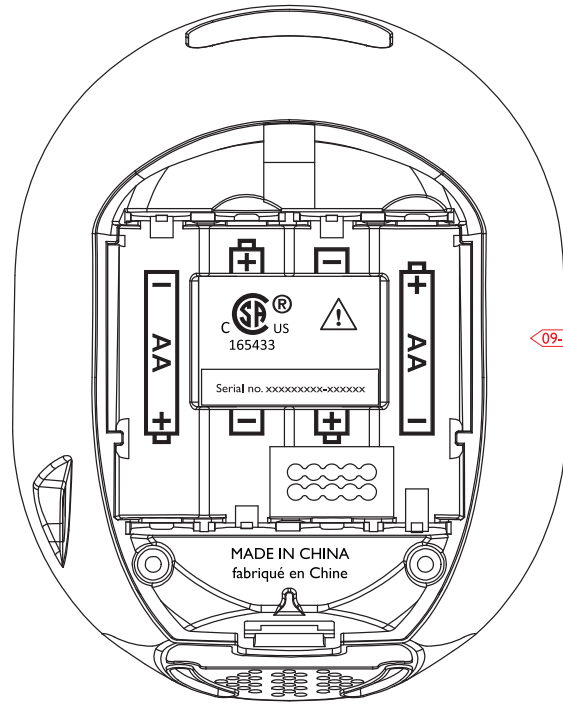

UN-D 28		TOLERANCES UNLESS OTHERWISE STATED TOLERANTIES TENZIJ ANDERS VERMELD		UN-D		ITEM NO.		ASSEMBLY NO.		QUANT. AANTAL	
GENERAL ROUGHNESS ALGEMENE RUWHEID		UNIT EENH.		DIMENSION MAAT		ANGLE HOEK		PATTERN NO. / MODEL NR.		QUANT. AANTAL	
SCALE SCHAAL		PROJ. EUROP.		COLOUR: KLEUR		EXTRA INFO EXTRA INFO		IMPT NOTE: "FREE OF HAZARDOUS SUBSTANCES ACCORDING TO ROYAL PHILIPS ELECTRONICS LIST OF BANNED SUBSTANCES."		QUANT. AANTAL	
75%				BABY UNIT US				PATTERN NO. / MODEL NR.		QUANT. AANTAL	
CLASS. NO.		POSITION GUIDE SCD505		POS EU10.0612_SCD505_US_C		ADJUSTMENTS					
NAME NAAM		Barry Soetens		12NC		000T YPE 00000		MS		2010-11-18	
CHECK CONTR.		DAT.		2010-05-25		Property of Eigendom van		N.V. PHILIPS' GLOEILAMPENFABRIEKEN EINDHOVEN - NEDERLAND		PAGE 04/04	
								BK		2011-01-13	

DRAFT