

Always there to help you

Register your product and get support at
www.philips.com/welcome



AEA7100/17

AEA7000/07

AEA7100/37

AEA7000/37

User manual

PHILIPS

Contents

1 Important	2
Safety	2
Notice	3

2 Your Wireless Microphone and Bluetooth Docking Speaker	6
Introduction	6
What's in the box	6
Overview of the unit	6

3 Get started	8
Connect power	8
Switch on the Bluetooth docking speaker	8
Install/replace microphone batteries	8

4 Play	10
Sing along through the wireless microphone	10
Play from a Bluetooth enabled device	11
Play and charge your iPad through the dock connector directly	12
Play from an external device	13

5 Product information	14
Specifications	14

6 Troubleshooting	15
MAV-AEA7000-Troubleshooting- Failed to set up connection between the microphone and speaker	15

1 Important

Safety



This 'bolt of lightning' indicates uninsulated material within the device may cause an electrical shock. For the safety of everyone in your household, please do not remove the covering.

The 'exclamation mark' calls attention to features for which you should read the enclosed literature closely to prevent operating and maintenance problems.

WARNING: To reduce the risk of fire or electric shock, the device should not be exposed to rain or moisture and objects filled with liquids, such as vases, should not be placed on the device.

CAUTION: To prevent electric shock, fully insert the plug. (For regions with polarized plugs: To prevent electric shock, match wide blade to wide slot.)

Important Safety Instructions

- 1 Read these instructions.
- 2 Keep these instructions.
- 3 Heed all warnings.
- 4 Follow all instructions.
- 5 Do not use this apparatus near water.
- 6 Clean only with dry cloth.
- 7 Do not block any ventilation openings. Install in accordance with the manufacturer's instructions.

- 8 Do not install near any heat sources such as radiators, heat registers, stoves, or other apparatus (including amplifiers) that produce heat.
- 9 Do not defeat the safety purpose of the polarized or grounding-type plug. A polarized plug has two blades with one wider than the other. A grounding type plug has two blades and a third grounding prong. The wide blade or the third prong are provided for your safety. If the provided plug does not fit into your outlet, consult an electrician for replacement of the obsolete outlet.

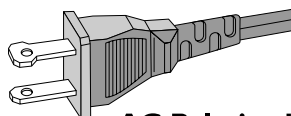

AC Polarized Plug

- 10 Protect the power cord from being walked on or pinched, particularly at plugs, convenience receptacles, and the point where they exit from the apparatus.
- 11 Only use attachments/accessories specified by the manufacturer.
- 12 Use only with the cart, stand, tripod, bracket, or table specified by the manufacturer or sold with the apparatus. When a cart is used, use caution when moving the cart/apparatus combination to avoid injury from tip-over.



- 13 Unplug this apparatus during lightning storms or when unused for long periods of time.

- ⑭ Refer all servicing to qualified service personnel. Servicing is required when the apparatus has been damaged in any way, such as power-supply cord or plug is damaged, liquid has been spilled or objects have fallen into the apparatus, the apparatus has been exposed to rain or moisture, does not operate normally, or has been dropped.
- ⑮ Battery usage **CAUTION** – To prevent battery leakage which may result in bodily injury, property damage, or damage to the unit:
 - Install all batteries correctly, + and - as marked on the unit.
 - Remove batteries when the unit is not used for a long time.
 - Perchlorate Material-special handling may apply. See www.dtsc.ca.gov/hazardouswaste/perchlorate.
- ⑯ Apparatus shall not be exposed to dripping or splashing, keep it away from direct sunlight, naked flames or heat.
- ⑰ Where the MAINS plug or an appliance coupler is used as the disconnect device, the disconnect device shall remain readily operable.

 **Warning**

- Never remove the casing of this apparatus.
- Never lubricate any part of this apparatus.
- Never place this apparatus on other electrical equipment.
- Keep this apparatus away from direct sunlight, naked flames or heat.
- Ensure that you always have easy access to the power cord, plug or adaptor to disconnect this apparatus from the power.

Risk of overheating! Never install this apparatus in a confined space. Always leave a space of at least four inches around this apparatus for ventilation. Ensure curtains or other objects never cover the ventilation slots on this apparatus.

Information about the use of batteries:

 **Caution**

- Risk of leakage: Only use the specified type of batteries. Do not mix new and used batteries. Do not mix different brands of batteries. Observe correct polarity. Remove batteries from products that are not in use for a longer period of time. Store batteries in a dry place.
- Risk of injury: Wear gloves when handling leaking batteries. Keep batteries out of reach of children and pets.
- Risk of explosion: Do not short circuit batteries. Do not expose batteries to excessive heat. Do not throw batteries into the fire. Do not damage or disassemble batteries. Do not recharge non-rechargeable batteries.

Notice

Notice of compliance

Modifications

The user is cautioned that changes or modifications not expressly approved by the party responsible for compliance could void the user's authority to operate the equipment.

FCC & RSS compliance statement

This device complies with Part 15 of the FCC Rules and Industry Canada licence-exempt RSS standard(s). Operation is subject to the following two conditions:

- ① This device may not cause harmful interference, and
- ② This device must accept any interference received, including interference that may cause undesired operation.

FCC Radiation Exposure Statement

This equipment complies with FCC's and IC's RF radiation exposure limits set forth for an uncontrolled environment. The antenna(s) used for this transmitter must be installed and operated to provide a separation distance of at least 20 cm from all persons and must not be collocated or operating in conjunction with

any other antenna or transmitter. Installers must ensure that 20cm separation distance will be maintained between the device (excluding its handset) and users.

FCC rules

This equipment has been tested and found to comply with the limits for a Class B digital device, pursuant to Part 15 of the FCC Rules. These limits are designed to provide reasonable protection against harmful interference in a residential installation. This equipment generates, uses and can radiate radio frequency energy and, if not installed and used in accordance with the instructions, may cause harmful interference to radio communications. However, there is no guarantee that interference will not occur in a particular installation.

If this equipment does cause harmful interference to radio or television reception, which can be determined by turning the equipment off and on, the user is encouraged to try to correct the interference by one or more of the following measures:

- Reorient or relocate the receiving antenna.
- Increase the separation between the equipment and receiver.
- Connect the equipment into an outlet on a circuit different from that to which the receiver is connected.
- Consult the dealer or an experienced radio/TV technician for help.

Canada:

This Class B digital apparatus complies with Canadian ICES-003.

Disposal of your old product and batteries

Your product is designed and manufactured with high quality materials and components, which can be recycled and reused. Never dispose of your product with other household waste. Please inform yourself about the local rules on the separate collection of electrical and electronic products and batteries.

The correct disposal of these products helps prevent potentially negative consequences on the environment and human health.

Your product contains batteries, which cannot be disposed of with normal household waste. Please inform yourself about the local rules on separate collection of batteries. The correct disposal of batteries helps prevent potentially negative consequences on the environment and human health.

Please visit www.recycle.philips.com for additional information on a recycling center in your area.

Environmental information

All unnecessary packaging has been omitted. We have tried to make the packaging easy to separate into three materials: cardboard (box), polystyrene foam (buffer) and polyethylene (bags, protective foam sheet.)

Your system consists of materials which can be recycled and reused if disassembled by a specialized company. Please observe the local regulations regarding the disposal of packaging materials, exhausted batteries and old equipment.



"Made for iPad" means that an electronic accessory has been designed to connect specifically to iPad, and has been certified by the developer to meet Apple performance standards. Apple is not responsible for the operation of this device or its compliance with safety and regulatory standards. Please note that the use of this accessory with iPad may affect wireless performance.

iPad is a trademark of Apple Inc., registered in the U.S. and other countries.

The Bluetooth® word mark and logos are registered trademarks owned by Bluetooth SIG, Inc. and any use of such marks by Philips is under license.



Note

- The type plate is located on the back of the unit.

2 Your Wireless Microphone and Bluetooth Docking Speaker

Congratulations on your purchase, and welcome to Philips! To fully benefit from the support that Philips offers, register your product at www.philips.com/welcome.

If you contact Philips, you will be asked for the model and serial number of this apparatus. The model number and serial number are on the back of the apparatus. Write the numbers here:

Model No. _____

Serial No. _____

Introduction

With the wireless microphone and Bluetooth docking speaker, you can:

- dock your iPad onto the speaker to sing along with music from the app (**StarMaker Karaoke + Auto-Tune®**) through the wireless microphone.

With the Bluetooth docking speaker, you can:

- play music from a Bluetooth enabled device that supports A2DP (Advanced Audio Distribution Profile).
- charge or play music from your iPad directly through the dock connector.
- play music from other audio devices through the **AUDIO-IN** socket.

What's in the box

Check and identify the contents of your package:

- Wireless microphone
- Bluetooth docking speaker
- AC power cord
- 3 X AAA batteries
- Quick start guide
- Safety sheet

Overview of the unit

Wireless microphone

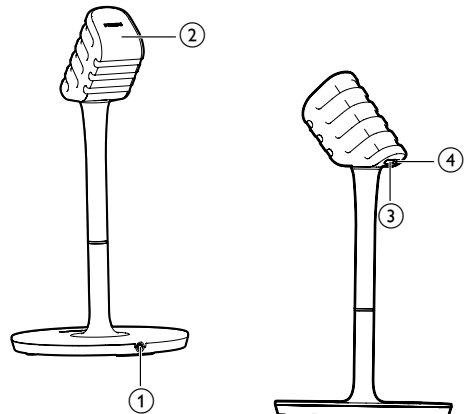

- ① **Line out socket**
 - (To use the microphone separately) connect to the MIC input socket of an existing audio system.
- ② **Battery compartment**
- ③ **ON/OFF**
 - Switch the microphone on or off.
- ④ **Power indicator**
 - Light up red when the wireless microphone is switched on.
 - Flash red when the battery level is low.

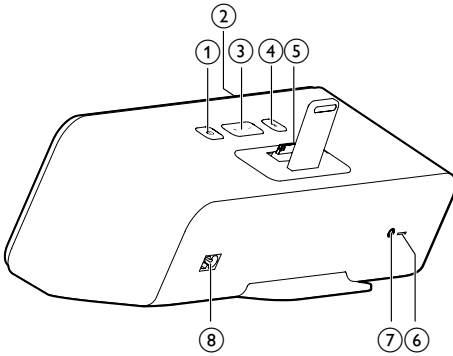

- ① 
 - Turn the unit on/off.
- ② **Power/Bluetooth indicator**
 - Indicate the power/Bluetooth status.
- ③ **-/+**
 - Adjust volume.
- ④ *****
 - (Press) pair with a Bluetooth enabled device that supports A2DP (Advanced Audio Distribution Profile).
 - (Press and hold) pair with the wireless microphone in case automatic pairing fails.
- ⑤ **Dock for iPad**
- ⑥ **SOFTWARE UPGRADE (for engineering use only)**
- ⑦ **AUDIO-IN**
 - Connect an external audio player through a 3.5mm audio input cable (not supplied).
- ⑧ **AC power socket**

3 Get started

Always follow the instructions in this chapter in sequence.

Connect power

! Caution

- Risk of product damage! Make sure that the power supply voltage corresponds to the voltage printed on the back of the unit.
- Risk of electric shock! When you unplug the AC power cord, always pull the plug from the socket. Never pull the cord.
- Before you connect the AC power cord, make sure that you have completed all the other connections.

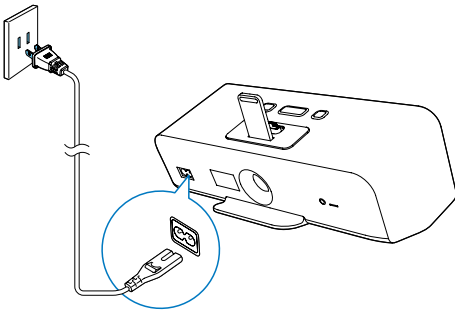

- Connect the AC power cord to
 - the **AC MAINS~** socket on the back of the Bluetooth docking speaker.
 - the wall power socket.

Switch on the Bluetooth docking speaker

- Press **⏻** on the top of the Bluetooth docking speaker:
 - ↳ The power indicator lights up white.
- To switch the unit to standby mode, press **⏻** on the top panel.

- To switch the unit on from standby mode, press **⏻** again.

Tip

- If the speaker stays idle for more than 15 minutes, it switches to standby mode automatically.

Install/replace microphone batteries

! Caution

- Risk of explosion! Keep batteries away from heat, sunshine, or fire. Never discard batteries in fire.
- Danger of explosion if batteries are incorrectly replaced. Replace only with the same or equivalent type.
- Batteries contain chemical substances, so they should be disposed of properly.

- 1 Open the battery compartment and take out the battery cartridge.

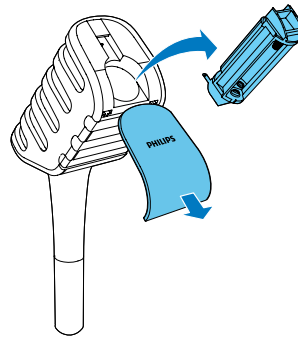

- 2 Insert 3 x AAA batteries (supplied) into the cartridge with correct polarity (+/-) as indicated.

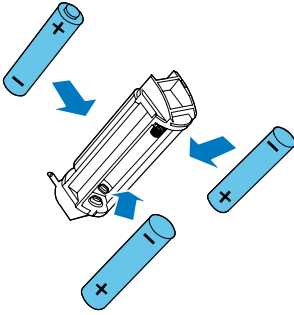

- 3 Push back the battery cartridge, then close the battery compartment.



Note

- If you are not going to use the microphone for a long time, remove the batteries.
- New batteries installed in the microphone support up to 30 hours of continuous use.
- When the power indicator flashes red, it indicates that the power level is low and you need to replace the batteries.

4 Play

Sing along through the wireless microphone

Note

- The effective operation range between the wireless microphone and Bluetooth docking speaker is approximately 10 meters (30 feet).
- If the Bluetooth docking speaker is already paired and connected with another Bluetooth enabled device, press **⌘** on the top panel of the speaker to remove the existing Bluetooth connection.
- Before you dock your iPad onto the Bluetooth docking speaker; you can use the supplied bumper for better support if necessary.

1 Dock your iPad onto the Bluetooth docking speaker:

↳ A prompt pops up on the iPad screen, asking you to install the relevant app.

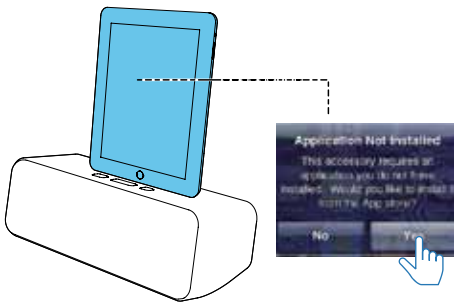

2 Tap **YES** on the prompt to install the app (**StarMaker Karaoke + Auto-Tune®**) from Apple App Store.

3 After successful installation, run **StarMaker Karaoke + Auto-Tune®** on the iPad.



- 4 Slide the **ON/OFF** switch on the wireless microphone to the **ON** position.
- ↳ The Bluetooth indicator on the Bluetooth docking speaker flashes blue.
 - ↳ The wireless microphone starts to pair with the Bluetooth docking speaker automatically.
 - ↳ After successful pairing and connection, the Bluetooth indicator turns solid blue.

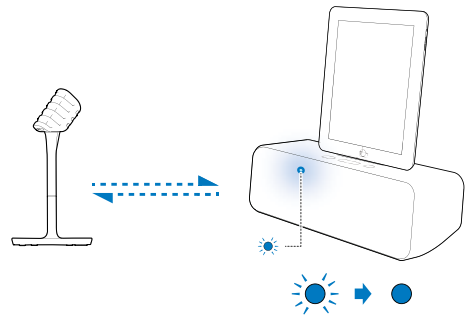

5 Find and download a tutorial from **StarMaker Karaoke + Auto-Tune®**, then tap **Sing->RECORD** for how to sing along through the wireless microphone and Bluetooth docking speaker.

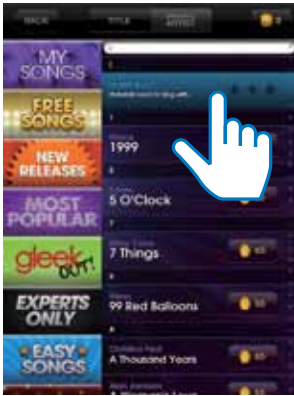

- 6 Select a song from **StarMaker Karaoke + Auto-Tune®** and sing along through the wireless microphone.

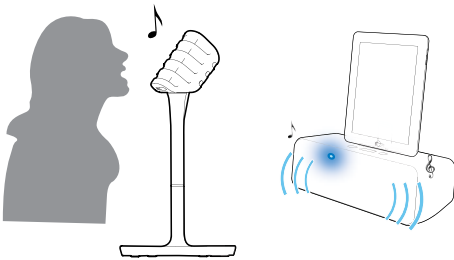

- 7 Use **-/+** on the top of the Bluetooth docking speaker to adjust volume.

Tip

- If the wireless microphone stays disconnected from the speaker for more than 15 minutes, it switches to standby mode automatically. To switch it on again, you need to slide the **ON/OFF** switch on the microphone to the **OFF** position and then back to the **ON** position.
- You can use controls available on the app to adjust sound effects.
- If you experience howling or echo, try to increase the distance between the microphone and speaker or adjust the angle of the microphone towards the speaker.

Play from a Bluetooth enabled device

Note

- The effective operation range between the Bluetooth docking speaker and your Bluetooth enabled device is approximately 10 meters (30 feet).
- To pair with a Bluetooth enabled mobile device, make sure that: no iPad is docked; or you have stopped music play on your docked iPad and the **StarMaker Karaoke + Auto-Tune®** app is not running.
- To pair with a new mobile device, you can press **⌘** to remove the existing Bluetooth connection.
- To play from a Bluetooth-enabled device, make sure that you are not playing music from your iPad docked on the Bluetooth docking speaker.

- 1 Press **⌘** on the top of the Bluetooth docking speaker:
↳ The Bluetooth indicator flashes blue.

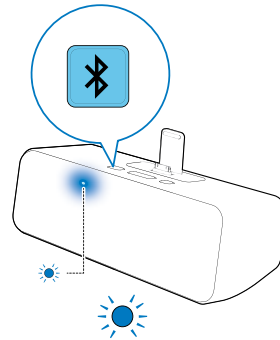

- 2 Enable Bluetooth on your device that supports A2DP (Advanced Audio Distribution Profile).

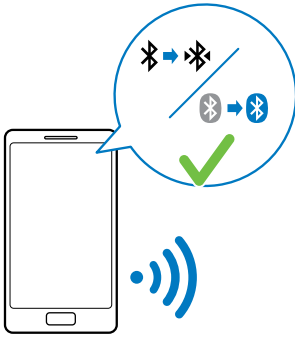

- 3** Select '**PHILIPS_AEA7100/17**' on your Bluetooth enabled device (if necessary, input '0000' as the pairing password).
 ↳ After successful pairing and connection, the Bluetooth indicator on the speaker turns solid blue and the speaker beeps twice.

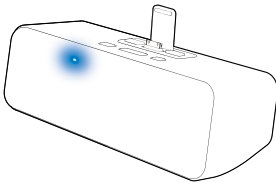

- 4** Start music play on your Bluetooth enabled device.

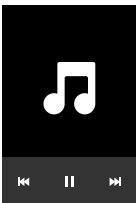

- 5** Use **-/+** on the top of the Bluetooth docking speaker to adjust volume.

Play and charge your iPad through the dock connector directly

Compatible iPad

This unit supports play and charge of the following iPad models:

- New iPad
- iPad 2
- iPad

Load the iPad

- Dock your iPad.

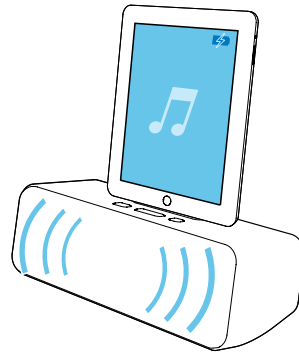

To remove the iPad

- Pull the iPad out of the dock.

Listen to the iPad

- 1** Make sure that the iPad has been loaded correctly.
- 2** Start music play on your iPad.
 ↳ The connected iPad starts to play.
- 3** Use **-/+** on the top of the Bluetooth docking speaker to adjust volume.

Charge the iPad

The docked iPad begins to charge as soon as the unit is connected to AC power.

Play from an external device

You can also listen to an external audio player through the Bluetooth docking speaker:

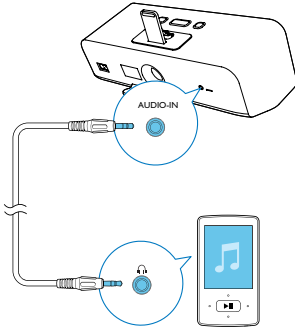

- 1 Connect a 3.5mm audio cable to:
 - the **AUDIO-IN** socket on the back of the Bluetooth docking speaker.
 - the headphone socket on an external audio player.
- 2 Start music play on the external audio player.
- 3 Use **-/+** on the top of the Bluetooth docking speaker to adjust volume.

5 Product information



Note

- Product information is subject to change without prior notice.

Dimensions (W x H x D)	300 x 162 x 148mm
• Main Unit	148mm
• Microphone	162 x 333 x 162mm

Weight	2.5 kg
• With Packing	1.3kg
• Speaker	0.3kg
• Microphone	

Specifications

Amplifier

Rated Output Power	2W RMS
Signal to Noise Ratio	>70dB
Aux-in Link	600 mV RMS, 10 kohm

Speakers

Speaker Impedance	4 ohm
Speaker Driver	70mm full range
Sensitivity	> 84dB/1m/1W

Bluetooth

Bluetooth specification	V2.1
Supported Profiles	AD2PV1.2
Advanced features	Echo and noise cancelation
Range	10 m/33 feet line of sight

General information

AC power	120 V~, 60 Hz
Operation Power	20 W
Consumption	

6 Troubleshooting



Warning

- Never remove the casing of this apparatus.

To keep the warranty valid, never try to repair the system yourself.

If you encounter problems when using this apparatus, check the following points before requesting service. If the problem remains unsolved, go to the Philips web site (www.philips.com/welcome). When you contact Philips, ensure that the apparatus is nearby and the model number and serial number are available.

No power to the Bluetooth docking speaker

- Make sure that the AC power plug of the device is connected properly.
- Make sure that there is power at the AC outlet.
- As a power-saving feature, the speaker switches to standby mode automatically after staying idle for more than 15 minutes. Switch on the speaker again (see 'Switch on the Bluetooth docking speaker' on page 8).

No power to the wireless microphone

- The batteries may be installed incorrectly or drained. Install or replace the batteries properly (see 'Install/replace microphone batteries' on page 8).
- As a power-saving feature, the microphone switches to standby mode automatically after staying disconnected from the speaker for more than 15 minutes. To switch it on again, you need to slide the **ON/OFF** switch on the microphone to the **OFF** position and then back to the **ON** position.

No sound or poor sound

- Adjust volume.
- Check the Bluetooth connection.
- Check whether you have started music play on the connected device.

MAV-AEA7000- Troubleshooting-Failed to set up connection between the microphone and speaker

Failed to set up connection between the microphone and speaker

- Check whether both the wireless microphone and Bluetooth docking speaker are switched on.
- Make sure that the wireless microphone and Bluetooth docking speaker are within the effective operation range, that is, approximately 10 meters (30 feet).
- Press and hold **⌘** on the top of the Bluetooth docking speaker for more than 10 seconds to set up wireless connection manually.

Howling or echo from the wireless microphone

- Adjust volume.
- Increase the distance between the microphone and speaker or adjust the angle of the microphone towards the speaker.

No response from the Bluetooth docking speaker

- Disconnect and reconnect the AC power plug, and then switch on the device again.



Specifications are subject to change without notice
© 2012 Koninklijke Philips Electronics N.V.
All rights reserved.

Document order number: 000000000000

