



RADIO TEST REPORT

Test Report No. 14263329S-A-R2

Customer	SEIKO EPSON CORPORATION
Description of EUT	Printer
Model Number of EUT	M382A
FCC ID	BKMFBM382A
Test Regulation	FCC Part 15 Subpart C
Test Result	Complied (Refer to SECTION 3)
Issue Date	July 8, 2022
Remarks	Wireless LAN (2.4 GHz band) part

Representative Test Engineer

Shiro Kobayashi
Engineer

Approved By

Kazutaka Takeyama
Leader



CERTIFICATE 1266.03

- The testing in which "Non-accreditation" is displayed is outside the accreditation scopes in UL Japan, Inc.
 There is no testing item of "Non-accreditation".

Report Cover Page - Form-ULID-003532 (DCS:13-EM-F0429) Issue# 20.0

ANNOUNCEMENT

- This test report shall not be reproduced in full or partial, without the written approval of UL Japan, Inc.
- The results in this report apply only to the sample tested.
- This sample tested is in compliance with the limits of the above regulation.
- The test results in this test report are traceable to the national or international standards.
- This test report must not be used by the customer to claim product certification, approval, or endorsement by the A2LA accreditation body.
- This test report covers Radio technical requirements.
It does not cover administrative issues such as Manual or non-Radio test related Requirements. (if applicable)
- The all test items in this test report are conducted by UL Japan, Inc Shonan EMC Lab.
- The opinions and the interpretations to the result of the description in this report are outside scopes where UL Japan, Inc. has been accredited.
- The information provided from the applicant for this report is identified in Section 1.
- For test report(s) referred in this report, the latest version (including any revisions) is always referred.

REVISION HISTORY

Original Test Report No.: 14263329S-A

This report is a revised version of 14263329S-A-R1. 14263329S-A-R1 is replaced with this report.

Revision	Test Report No.	Date	Page Revised Contents
- (Original)	14263329S-A	June 24, 2022	-
1	14263329S-A-R1	July 5, 2022	P.10 Correction of description the worst antenna port has been deleted. P.13 Correction of Test Distance: From “* Test Distance: (3 + SVSWR Volume /2) - r = 3.95 m” to “* Test Distance: (3 + SVSWR Volume /2) - r = 3.945 m” P 25 to P 36 Correction of Test Distance: From “3.95 m” to “3.945 m”
2	14263329S-A-R2	July 8, 2022	P.13 Correction of “r (Radius of an outer periphery of EUT)” From “0.05 m” to: “0.055 m”

Reference: Abbreviations (Including words undescribed in this report)

A2LA	The American Association for Laboratory Accreditation	ICES	Interference-Causing Equipment Standard
AC	Alternating Current	IEC	International Electrotechnical Commission
AFH	Adaptive Frequency Hopping	IEEE	Institute of Electrical and Electronics Engineers
AM	Amplitude Modulation	IF	Intermediate Frequency
Amp, AMP	Amplifier	ILAC	International Laboratory Accreditation Conference
ANSI	American National Standards Institute	ISED	Innovation, Science and Economic Development Canada
Ant, ANT	Antenna	ISO	International Organization for Standardization
AP	Access Point	JAB	Japan Accreditation Board
ASK	Amplitude Shift Keying	LAN	Local Area Network
Atten., ATT	Attenuator	LIMS	Laboratory Information Management System
AV	Average	MCS	Modulation and Coding Scheme
BPSK	Binary Phase-Shift Keying	MRA	Mutual Recognition Arrangement
BR	Bluetooth Basic Rate	N/A	Not Applicable
BT	Bluetooth	NIST	National Institute of Standards and Technology
BT LE	Bluetooth Low Energy	NS	No signal detect.
BW	BandWidth	NSA	Normalized Site Attenuation
Cal Int	Calibration Interval	NVLAP	National Voluntary Laboratory Accreditation Program
CCK	Complementary Code Keying	OBW	Occupied Band Width
Ch., CH	Channel	OFDM	Orthogonal Frequency Division Multiplexing
CISPR	Comite International Special des Perturbations Radioelectriques	P/M	Power meter
CW	Continuous Wave	PCB	Printed Circuit Board
DBPSK	Differential BPSK	PER	Packet Error Rate
DC	Direct Current	PHY	Physical Layer
D-factor	Distance factor	PK	Peak
DFS	Dynamic Frequency Selection	PN	Pseudo random Noise
DQPSK	Differential QPSK	PRBS	Pseudo-Random Bit Sequence
DSSS	Direct Sequence Spread Spectrum	PSD	Power Spectral Density
EDR	Enhanced Data Rate	QAM	Quadrature Amplitude Modulation
EIRP, e.i.r.p.	Equivalent Isotropically Radiated Power	QP	Quasi-Peak
EMC	ElectroMagnetic Compatibility	QPSK	Quadri-Phase Shift Keying
EMI	ElectroMagnetic Interference	RBW	Resolution Band Width
EN	European Norm	RDS	Radio Data System
ERP, e.r.p.	Effective Radiated Power	RE	Radio Equipment
EU	European Union	RF	Radio Frequency
EUT	Equipment Under Test	RMS	Root Mean Square
Fac.	Factor	RSS	Radio Standards Specifications
FCC	Federal Communications Commission	Rx	Receiving
FHSS	Frequency Hopping Spread Spectrum	SA, S/A	Spectrum Analyzer
FM	Frequency Modulation	SG	Signal Generator
Freq.	Frequency	SVSWR	Site-Voltage Standing Wave Ratio
FSK	Frequency Shift Keying	TR	Test Receiver
GFSK	Gaussian Frequency-Shift Keying	Tx	Transmitting
GNSS	Global Navigation Satellite System	VBW	Video BandWidth
GPS	Global Positioning System	Vert.	Vertical
Hori.	Horizontal	WLAN	Wireless LAN

CONTENTS	PAGE
SECTION 1: Customer Information	5
SECTION 2: Equipment Under Test (EUT).....	5
SECTION 3: Test Specification, Procedures & Results.....	7
SECTION 4: Operation of EUT during testing	10
SECTION 5: Radiated Spurious Emission	12
SECTION 6: Antenna Terminal Conducted Tests.....	14
APPENDIX 1: Test Data.....	15
99 % Occupied Bandwidth and 6 dB Bandwidth.....	15
Maximum Peak Output Power	19
Average Output Power	22
Radiated Spurious Emission	25
Conducted Spurious Emission	39
Power Density	40
APPENDIX 2: Test Instruments.....	43
APPENDIX 3: Photographs of Test Setup	45
Radiated Spurious Emission	45
Pre-check of Worst Case Position.....	46
Antenna Terminal Conducted Tests.....	47

SECTION 1: Customer Information

Company Name	SEIKO EPSON CORPORATION
Address	80 Hirooka Harashinden,Shiojiri-shi,Nagano-ken 399-0705 Japan
Telephone Number	+81-263-52-2552
Contact Person	Takayuki Kuwahara

The information provided from the customer is as follows;

- Customer, Description of EUT, Model Number of EUT, FCC ID on the cover and other relevant pages
- Operating/Test Mode(s) (Mode(s)) on all the relevant pages
- SECTION 1: Customer Information
- SECTION 2: Equipment Under Test (EUT) other than the Receipt Date and Test Date
- SECTION 4: Operation of EUT during testing

* The laboratory is exempted from liability of any test results affected from the above information in SECTION 2 and 4.

SECTION 2: Equipment Under Test (EUT)

2.1 Identification of EUT

Description	Printer
Model Number	M382A
Serial Number	Refer to SECTION 4.2
Condition	Engineering prototype (Not for Sale: This sample is equivalent to mass-produced items.)
Modification	No Modification by the test lab
Receipt Date	March 14, 2022
Test Date	April 8 to May 24, 2022

2.2 Product Description

General Specification

Rating	DC 7.2 V (Battery)
Operating temperature	-15 deg. C to +50 deg. C

Radio Specification

WLAN (IEEE802.11b/11g/11n-20)

Equipment Type	Transceiver
Frequency of Operation	2412 MHz to 2462 MHz
Type of Modulation	DSSS, OFDM
Antenna Type	PCB Printed Antenna
Antenna Gain	Ant1: 3.09 dBi, Ant2: 2.53 dBi

WLAN (IEEE802.11a/11n-20/11ac-20/11n-40/11ac-40/11ac-80)

Equipment Type	Transceiver	
Frequency of Operation	20 MHz Band:	5180 MHz to 5240 MHz 5260 MHz to 5320 MHz 5500 MHz to 5700 MHz 5745 MHz to 5825 MHz
	40 MHz Band:	5190 MHz to 5230 MHz 5270 MHz to 5310 MHz 5510 MHz to 5670 MHz 5755 MHz to 5795 MHz
	80 MHz Band:	5210 MHz 5290 MHz 5530 MHz 5775 MHz
Type of Modulation	DSSS, OFDM	
Antenna Type	PCB Printed Antenna	
Antenna Gain	5150 MHz to 5350 MHz:	Ant1: 5.94 dBi, Ant2: 3.94 dBi
	5470 MHz to 5725 MHz:	Ant1: 6.29 dBi, Ant2: 5.10 dBi
	5725 MHz to 5850 MHz:	Ant1: 7.12 dBi, Ant2: 5.23 dBi

SECTION 3: Test Specification, Procedures & Results

3.1 Test Specification

Test Specification	FCC Part 15 Subpart C FCC Part 15 final revised on April 1, 2022 and effective May 2, 2022
Title	FCC 47 CFR Part 15 Radio Frequency Device Subpart C Intentional Radiators Section 15.207 Conducted limits Section 15.247 Operation within the bands 902-928 MHz, 2400-2483.5 MHz, and 5725-5850 MHz

- * The revision does not affect the test result conducted before its effective date.
- * Also the EUT complies with FCC Part 15 Subpart B.

3.2 Procedures and Results

Item	Test Procedure	Specification	Worst Margin	Results	Remarks
Conducted Emission	FCC: ANSI C63.10-2013 6. Standard test methods ----- ISED: RSS-Gen 8.8	FCC: Section 15.207 ----- ISED: RSS-Gen 8.8	-	N/A	*1)
6 dB Bandwidth	FCC: KDB 558074 D01 15.247 Meas Guidance v05r02 ----- ISED: -	FCC: Section 15.247(a)(2) ----- ISED: RSS-247 5.2(a)	See data.	Complied a)	Conducted
Maximum Peak Output Power	FCC: KDB 558074 D01 15.247 Meas Guidance v05r02 ----- ISED: RSS-Gen 6.12	FCC: Section 15.247(b)(3) ----- ISED: RSS-247 5.4(d)		Complied b)	Conducted
Power Density	FCC: KDB 558074 D01 15.247 Meas Guidance v05r02 ----- ISED: -	FCC: Section 15.247(e) ----- ISED: RSS-247 5.2(b)		Complied c)	Conducted
Spurious Emission Restricted Band Edges	FCC: KDB 558074 D01 15.247 Meas Guidance v05r02 ----- ISED: RSS-Gen 6.13	FCC: Section 15.247(d) ----- ISED: RSS-247 5.5 RSS-Gen 8.9 RSS-Gen 8.10	4.8 dB 2483.500 MHz, AV, Hori. Mode: Tx 11n-20 2462 MHz	Complied d), e)	Conducted (below 30 MHz)/ Radiated (above 30 MHz) *2)
<p>Note: UL Japan, Inc.'s EMI Work Procedures: Work Instructions-ULID-003591 and Work Instructions-ULID-003593. * In case any questions arise about test procedure, ANSI C63.10: 2013 is also referred.</p> <p>*1) The test is not applicable since the radio function does not operate while connected to AC power line. *2) Radiated test was selected over 30 MHz based on FCC 15.407 (b) and KDB 789033 D02 G.3.b).</p> <p>a) Refer to APPENDIX 1 (data of 99 % Occupied Bandwidth and 6 dB Bandwidth) b) Refer to APPENDIX 1 (data of Maximum Peak Output Power) c) Refer to APPENDIX 1 (data of Power Density) d) Refer to APPENDIX 1 (data of Conducted Spurious Emission) e) Refer to APPENDIX 1 (data of Radiated Spurious Emission)</p>					
<p>Symbols: Complied The data of this test item has enough margin, more than the measurement uncertainty. Complied# The data of this test item meets the limits unless the measurement uncertainty is taken into consideration</p>					

FCC Part 15.31 (e)

This EUT provides the stable voltage constantly to RF Part regardless of input voltage.
Therefore, this EUT complies with the requirement.

FCC Part 15.203 Antenna requirement

It is impossible for end users to replace the antenna, because the antenna is mounted inside of the EUT.
Therefore, the equipment complies with the antenna requirement of Section 15.203.

3.3 Addition to Standard

Item	Test Procedure	Specification	Worst Margin	Results	Remarks
99 % Occupied Bandwidth	ISED: RSS-Gen 6.7	ISED: -	N/A	- a)	Conducted
a) Refer to APPENDIX 1 (data of 6 dB Bandwidth and 99 % Occupied Bandwidth and 6 dB Bandwidth)					

Other than above, no addition, exclusion nor deviation has been made from the standard.

3.4 Uncertainty

There is no applicable rule of uncertainty in this applied standard. Therefore, the results are derived depending on whether or not laboratory uncertainty is applied.

The following uncertainties have been calculated to provide a confidence level of 95 % using a coverage factor $k=2$.
Shonan EMC Lab.

Item	Frequency range	Uncertainty (+/-)		
		No. 1 SAC / SR	No. 2 SAC / SR	No. 3 SAC / SR
Radiated emission (Measurement distance: 3 m)	9 kHz-30 MHz	3.2 dB	3.1 dB	3.1 dB
	30 MHz-200 MHz	4.6 dB	4.6 dB	4.6 dB
	200 MHz-1 GHz	6.0 dB	6.1 dB	6.1 dB
	1 GHz-6 GHz	4.7 dB	4.7 dB	4.7 dB
	6 GHz-18 GHz	5.2 dB	5.3 dB	5.3 dB
	18 GHz-40 GHz	5.4 dB	5.5 dB	5.5 dB
Radiated emission (Measurement distance: 1 m)	1 GHz-18 GHz	5.6 dB	5.6 dB	5.6 dB
	18 GHz-40 GHz	5.8 dB	5.8 dB	5.8 dB

SAC=Semi-Anechoic Chamber

SR= Shielded Room is applied besides radiated emission

Antenna terminal test	Uncertainty (+/-)
Power Measurement above 1 GHz (Average Detector)_SPM-06	1.2 dB
Power Measurement above 1 GHz (Peak Detector)_SPM-06	2.0 dB
Power Measurement above 1 GHz (Average Detector)_SPM-07	1.2 dB
Power Measurement above 1 GHz (Peak Detector)_SPM-07	1.3 dB
Power Measurement above 1 GHz (Average Detector)_SPM-13	1.3 dB
Power Measurement above 1 GHz (Peak Detector)_SPM-13	1.3 dB
Spurious emission (Conducted) below 1 GHz	0.93 dB
Conducted emissions Power Density Measurement 1 GHz-3 GHz	0.92 dB
Conducted emissions Power Density Measurement 3 GHz-18 GHz	2.3 dB
Spurious emission (Conducted) 18 GHz-26.5 GHz	2.3 dB
Spurious emission (Conducted) 26.5 GHz-40 GHz	2.3 dB
Bandwidth Measurement	0.012 %
Duty cycle and Time Measurement	0.27 %
Temperature_SCH-01	0.93 deg.C.
Humidity_SCH-01	4.1 %
Temperature_SCH-02	2.0 deg.C.
Humidity_SCH-02	6.6 %
Voltage	0.97 %

3.5 Test Location

UL Japan, Inc. Shonan EMC Lab.

1-22-3, Megumigaoka, Hiratsuka-shi, Kanagawa-ken 259-1220 JAPAN

Telephone: +81 463 50 6400, Facsimile: +81 463 50 6401

A2LA Certificate Number: 1266.03

(FCC test firm registration number: 626366, ISED lab company number: 2973D / CAB identifier: JP0001)

Test site	IC Registration Number	Width x Depth x Height (m)	Size of reference ground plane (m) / horizontal conducting plane	Maximum measurement distance
No.1 Semi-anechoic chamber	2973D-1	20.6 x 11.3 x 7.65	20.6 x 11.3	10 m
No.2 Semi-anechoic chamber	2973D-2	20.6 x 11.3 x 7.65	20.6 x 11.3	10 m
No.3 Semi-anechoic chamber	2973D-3	12.7 x 7.7 x 5.35	12.7 x 7.7	5 m
No.4 Semi-anechoic chamber	-	8.1 x 5.1 x 3.55	8.1 x 5.1	-
No.1 Shielded room	-	6.8 x 4.1 x 2.7	6.8 x 4.1	-
No.2 Shielded room	-	6.8 x 4.1 x 2.7	6.8 x 4.1	-
No.3 Shielded room	-	6.3 x 4.7 x 2.7	6.3 x 4.7	-
No.4 Shielded room	-	4.4 x 4.7 x 2.7	4.4 x 4.7	-
No.5 Shielded room	-	7.8 x 6.4 x 2.7	7.8 x 6.4	-
No.6 Shielded room	-	7.8 x 6.4 x 2.7	7.8 x 6.4	-
No.8 Shielded room	-	3.45 x 5.5 x 2.4	3.45 x 5.5	-
No.1 Measurement room	-	2.55 x 4.1 x 2.5	-	-

3.6 Test Data, Test Instruments, and Test Set Up

Refer to APPENDIX.

SECTION 4: Operation of EUT during testing

4.1 Operating Mode(s)

Test operating mode was determined as follows according to “Section 1 of 6 802.11 a/b/g/n testing - Managing Complex Regulatory Approvals - ” of TCB Council Workshop October 2009.

Mode	Remarks*
IEEE 802.11b (11b)	11 Mbps, PN9
IEEE 802.11g (11g)	36 Mbps, PN9
IEEE 802.11n 20 MHz BW (11n-20)	MCS 5, PN9
*Transmitting duty was 100 % on all tests.	
*The worst condition was determined based on the test result of Maximum Peak Output Power (Mid Channel)	
*Power of the EUT was set by the software as follows; Power Setting: 11b: 29, 11g/11n-20: 40 (Setting Value) Software: Realtek 11ac 8821C USB WLAN MP Diagnostic Program Version: 0.0003.01. (Date: 2022.03 14, Storage location: Driven by connected PC)	
*This setting of software is the worst case. Any conditions under the normal use do not exceed the condition of setting.	
In addition, end users cannot change the settings of the output power of the product.	

*The Details Of Operating Mode(s)

Test Item	Operating Mode	Tested Antenna *2)	Tested Frequency
Conducted Spurious Emission, Radiated Spurious Emission (Below 1 GHz)	Tx 11g *1)	1	2437 MHz
Radiated Spurious Emission (Above 1 GHz) *3), 6 dB Bandwidth, Maximum Peak Output Power, Power Density, 99 % Occupied Bandwidth	Tx 11b Tx 11g Tx 11n-20	1	2412 MHz 2437 MHz 2462 MHz
*1) The mode was tested as a representative, because it had the highest power at antenna terminal test.			
*2) As a result of pre-check in Radiated Emission, The test was performed with the antenna that had higher power as a representative.			
*3) Test for spot check was performed on below mode. Radiated Spurious Emission (Below 1 GHz): Tx 11g 2437 MHz Radiated Spurious Emission (Above 1 GHz): Tx 11b/g/n-20 (2412 MHz / 2462 MHz) (Band Edge Compliance) Tx 11g 2437 MHz (Other Spurious Emission)			

4.2 Configuration and Peripherals

<For Radiated Emission test>

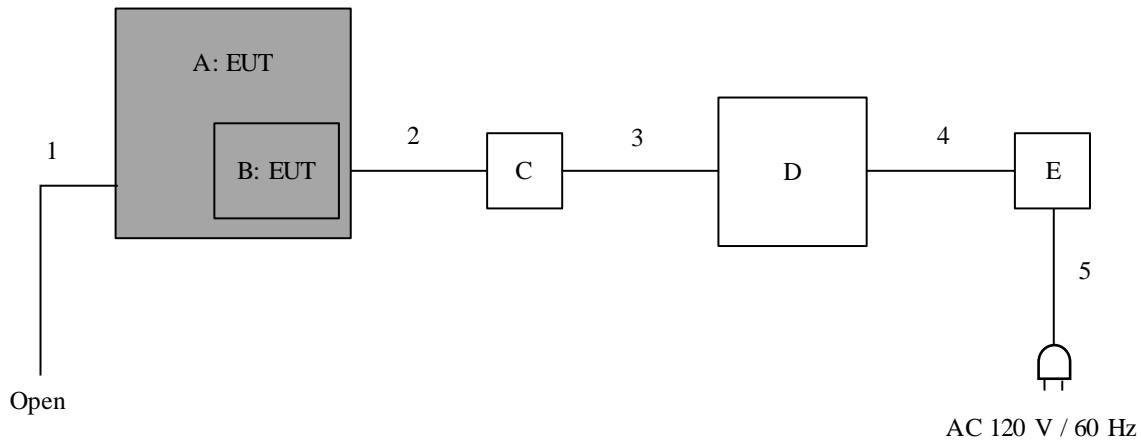

* Cabling and setup(s) were taken into consideration and test data was taken under worse case conditions.

<For Antenna Terminal Conducted test>

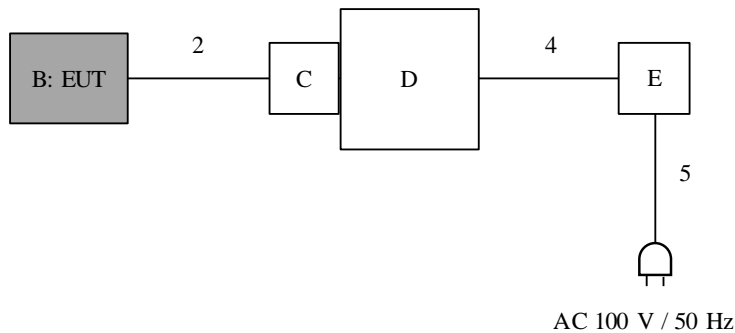

Description of EUT and Support Equipment

No.	Item	Model number	Serial Number	Manufacturer	Remarks
A	Printer	M382A	EHLF000014	SEIKO EPSON CORPORATION	EUT
B	11ac + BT Combo module	J26H005	221805500 E0AA14747	Foxconn	EUT
C	Test board	-	-	Foxconn	-
D	Laptop Computer	7666-77J	LV-B8PZ8 08/05	Lenovo	-
E	AC Adapter	92P1213	11S92P1213Z1ZD DZ92C2WU	Lenovo	-

List of Cables Used

No.	Name	Length (m)	Shield		Remarks
			Cable	Connector	
1	USB	1.0	Shielded	Shielded	-
2	Signal	0.5	Unshielded	Unshielded	-
3	USB	2.0	Shielded	Shielded	-
4	DC	1.8	Unshielded	Unshielded	-
5	AC	0.9	Unshielded	Unshielded	-

SECTION 5: Radiated Spurious Emission

Test Procedure

It was measured based on "8.5 and 8.6 of KDB 558074 D01 15.247 Meas Guidance v05r02".

[For below 1 GHz]

EUT was placed on a urethane platform of nominal size, 1.0 m by 1.5 m, raised 0.8 m above the conducting ground plane. The Radiated Electric Field Strength has been measured in a Semi Anechoic Chamber with a ground plane.

[For above 1 GHz]

EUT was placed on a urethane platform of nominal size, 0.5 m by 0.5 m, raised 1.5 m above the conducting ground plane. The Radiated Electric Field Strength has been measured in a Semi Anechoic Chamber with absorbent materials lined on a ground plane.

The height of the measuring antenna varied between 1 m and 4 m and EUT was rotated a full revolution in order to obtain the maximum value of the electric field strength.

Test antenna was aimed at the EUT for receiving the maximum signal and always kept within the illumination area of the 3 dB beamwidth of the antenna. (Above 1 GHz)

The measurements were performed for both vertical and horizontal antenna polarization with the Test Receiver, or the Spectrum Analyzer.

The measurements were made with the following detector function of the test receiver and the Spectrum analyzer (in linear mode).

The test was made with the detector (RBW/VBW) in the following table.

When using Spectrum analyzer, the test was made with adjusting span to zero by using peak hold.

Test Antennas are used as below;

Frequency	30 MHz to 200 MHz	200 MHz to 1 GHz	Above 1 GHz
Antenna Type	Biconical	Logperiodic	Horn

In any 100 kHz bandwidth outside the restricted band in which the spread spectrum intentional radiator is operating, the radio frequency power that is produced by the intentional radiator confirmed 20 dB below that in the 100 kHz bandwidth within the band that contains the highest level of the desired power, based on a radiated measurement.

20 dBc was applied to the frequency over the limit of FCC 15.209 / Table 4 of RSS-Gen 8.9(ISED) and outside the restricted band of FCC15.205 / Table 6 of RSS-Gen 8.10 (ISED).

Frequency	Below 1 GHz	Above 1 GHz		20 dBc
Instrument Used	Test Receiver	Spectrum Analyzer		Spectrum Analyzer
Detector	QP	PK	AV *1)	PK
IF Bandwidth	BW 120 kHz	RBW: 1 MHz VBW: 3 MHz	11,12,2.5.2 RBW: 1 MHz VBW: 3 MHz Detector: Power Averaging (Linear voltage) Trace: 100 traces Duty factor was added to the results.	RBW: 100 kHz VBW: 300 kHz

*1) Average Power Measurement was performed based on ANSI C63.10-2013.

Figure 2: Test Setup

Below 1 GHz

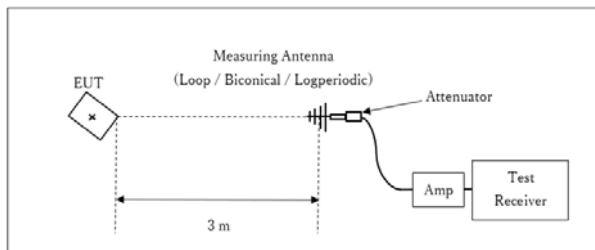

× : Center of turn table

Test Distance: 3 m

1 GHz to 10 GHz

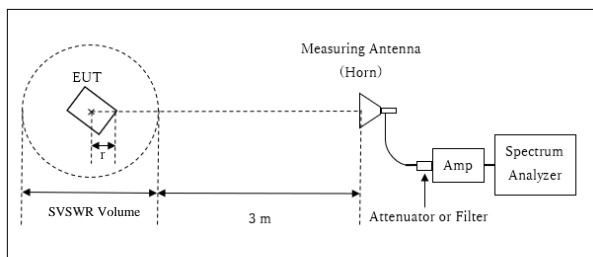

r : Radius of an outer periphery of EUT
× : Center of turn table

Distance Factor: $20 \times \log(3.945 \text{ m} / 3.0 \text{ m}) = 2.38 \text{ dB}$
* Test Distance: $(3 + \text{SVSWR Volume} / 2) - r = 3.945 \text{ m}$

SVSWR Volume : 2.0 m
(SVSWR Volume has been calibrated based on CISPR 16-1-4.)
 $r = 0.055 \text{ m}$

10 GHz to 26.5 GHz

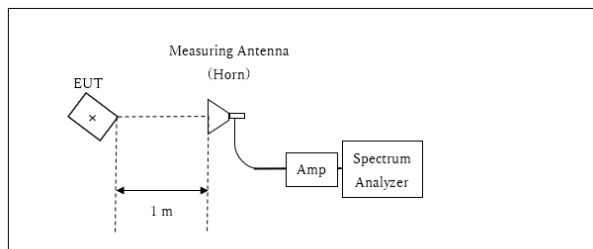

× : Center of turn table

Distance Factor: $20 \times \log(1.0 \text{ m} / 3.0 \text{ m}) = -9.54 \text{ dB}$
*Test Distance: 1 m

- The carrier level and noise levels were confirmed at each position of X, Y and Z axes of EUT to see the position of maximum noise, and the test was made at the position that has the maximum noise.

Antenna polarization	Carrier	Spurious (30 MHz - 1 GHz)	Spurious (1 GHz - 2.8 GHz)	Spurious (2.8 GHz - 13 GHz)	Spurious (13 GHz - 18 GHz)	Spurious (18 GHz - 26.5 GHz)
Horizontal	Z	Z	Z	Z	X	X
Vertical	X	Z	X	Y	X	X

The test results and limit are rounded off to one decimal place, so some differences might be observed.

Measurement Range : 30 MHz to 26.5 GHz
Test Data : APPENDIX
Test Result : Pass

SECTION 6: Antenna Terminal Conducted Tests

Test Procedure

The tests were made with below setting connected to the antenna port.

Test	Span	RBW	VBW	Sweep time	Detector	Trace	Instrument Used
6 dB Bandwidth	50 MHz	100 kHz	300 kHz	Auto	Peak	Max Hold	Spectrum Analyzer
99 % Occupied Bandwidth *1)	Enough width to display emission skirts	1 to 5 % of OBW	Three times of RBW	Auto	Peak	Max Hold	Spectrum Analyzer
Maximum Peak Output Power	-	-	-	Auto	Peak/Average *2)	-	Power Meter (Sensor: 160 MHz BW)
Peak Power Density	1.5 times the 6 dB Bandwidth	3 kHz	9.1 kHz	Auto	Peak	Max Hold	Spectrum Analyzer *3)
Conducted Spurious Emission *4) *5)	9kHz to 150kHz	200 Hz	620 Hz	Auto	Peak	Max Hold	Spectrum Analyzer
	150kHz to 30MHz	10 kHz	30 kHz				

*1) Peak hold was applied as Worst-case measurement.

*2) Reference data

*3) Section 11.10.2 Method PKPSD (peak PSD) of "ANSI C63.10-2013".

*4) In the frequency range below 30MHz, RBW was narrowed to separate the noise contents.

Then, wide-band noise near the limit was checked separately, however the noise was not detected as shown in the chart.

(9 kHz - 150 kHz: RBW = 200 Hz, 150 kHz - 30 MHz: RBW = 10 kHz)

*5) The limits in CFR 47, Part 15, Subpart C, paragraph 15.209(a), are identical to those in RSS-Gen section 8.9, Table 6, since the measurements are performed in terms of magnetic field strength and converted to electric field strength levels (as reported in the table) using the free space impedance of 377 Ohms. For example, the measurement at frequency 9 kHz resulted in a level of 45.5 dBuV/m, which is equivalent to $45.5 - 51.5 = -6.0$ dBuA/m, which has the same margin, 3 dB, to the corresponding RSS-Gen Table 6 limit as it has to 15.209(a) limit.

The test results and limit are rounded off to two decimals place, so some differences might be observed.
The equipment and cables were not used for factor 0 dB of the data sheets.

Test Data : **APPENDIX**

Test Result : **Pass**

APPENDIX 1: Test Data

99 % Occupied Bandwidth and 6 dB Bandwidth

Test place Shonan EMC Lab. No.5 Shielded Room
 Date May 24, 2022
 Temperature / Humidity 25 deg. C / 46 % RH
 Engineer Shiro Kobayashi
 Mode Tx

11b

Frequency [MHz]	99 % Occupied Bandwidth [kHz]	6 dB Bandwidth [MHz]	Limit for 6 dB Bandwidth [MHz]
2412	14957.2	10.141	> 0.5000
2437	14966.1	10.137	> 0.5000
2462	14958.3	10.133	> 0.5000

11g

Frequency [MHz]	99 % Occupied Bandwidth [kHz]	6 dB Bandwidth [MHz]	Limit for 6 dB Bandwidth [MHz]
2412	16811.9	16.512	> 0.5000
2437	16774.8	16.541	> 0.5000
2462	16762.3	16.531	> 0.5000

11n-20 (SISO)

Frequency [MHz]	99 % Occupied Bandwidth [kHz]	6 dB Bandwidth [MHz]	Limit for 6 dB Bandwidth [MHz]
2412	17779.2	17.712	> 0.5000
2437	17776.0	17.725	> 0.5000
2462	17777.3	17.682	> 0.5000

99 % Occupied Bandwidth and 6 dB Bandwidth

11b

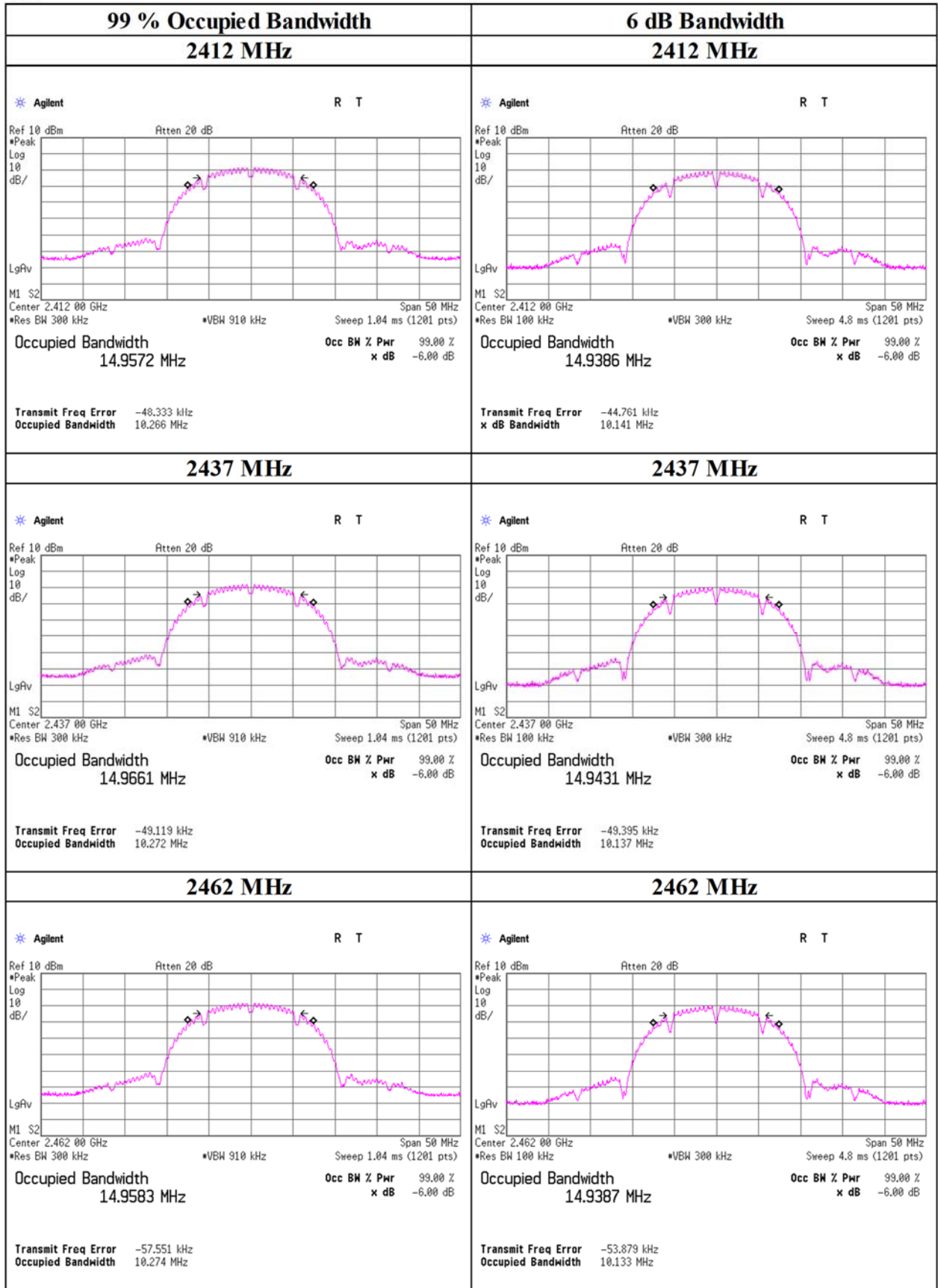

99 % Occupied Bandwidth and 6 dB Bandwidth

11g

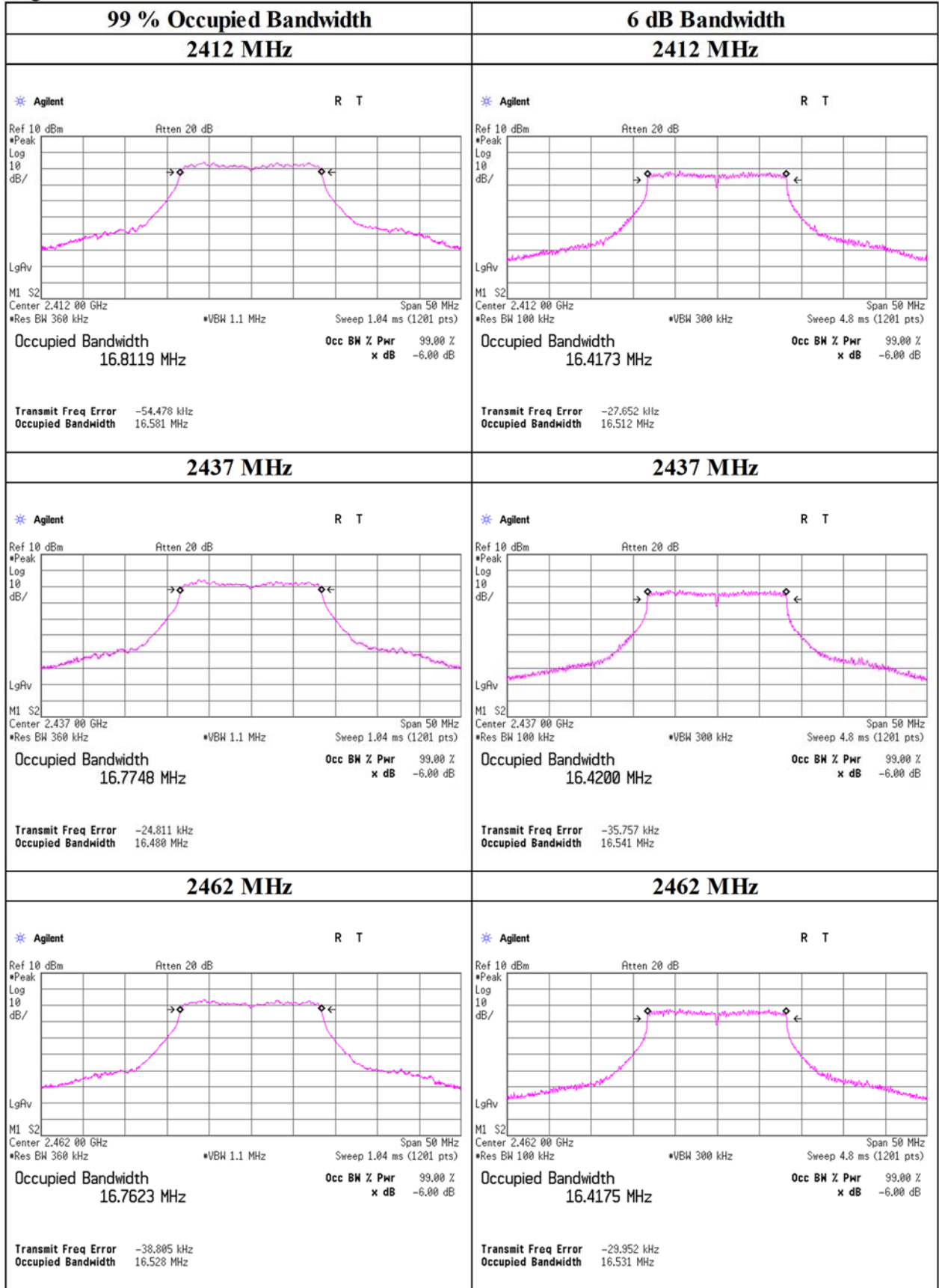

99 % Occupied Bandwidth and 6 dB Bandwidth

11n-20

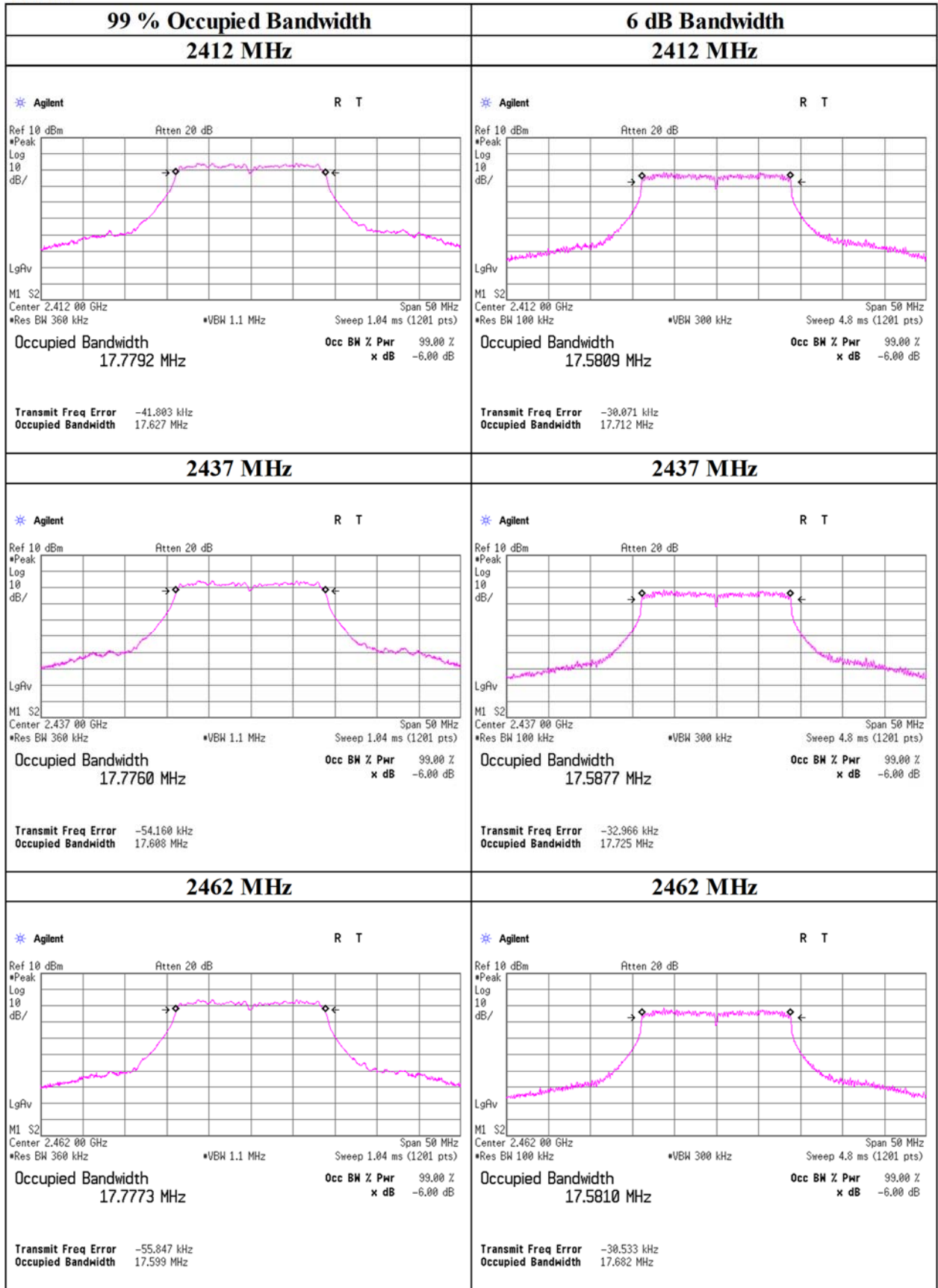

Maximum Peak Output Power

Test place Shonan EMC Lab. No.5 Shielded Room
 Date April 8, 2022
 Temperature / Humidity 23 deg. C / 52 % RH
 Engineer Hiromasa Sato
 Mode Tx 11b

Freq.	Reading	Cable Loss	Atten. Loss	Conducted Power					e.i.r.p. for RSS-247					
				Result		Limit		Margin	Antenna Gain	Result		Limit		Margin
				[dBm]	[mW]	[dBm]	[mW]			[dB]	[dBm]	[mW]	[dBm]	
2412	4.34	2.15	9.82	16.31	42.76	30.00	1000	13.69	3.09	19.40	87.10	36.02	4000	16.62
2437	4.55	2.16	9.82	16.53	44.98	30.00	1000	13.47	3.09	19.62	91.62	36.02	4000	16.40
2462	3.78	2.16	9.82	15.76	37.67	30.00	1000	14.24	3.09	18.85	76.74	36.02	4000	17.17

Sample Calculation:

Result = Reading + Cable Loss (including the cable(s) customer supplied) + Attenuator Loss

e.i.r.p. Result = Conducted Power Result + Antenna Gain

2437 MHz

Rate	Reading	Remark
[Mbps]	[dBm]	
1	4.22	-
2	3.90	-
5.5	4.47	-
11	4.55	*

*: Worst Rate

All comparison were carried out on same frequency and measurement factors.

Maximum Peak Output Power

Test place Shonan EMC Lab. No.5 Shielded Room
 Date April 8, 2022
 Temperature / Humidity 23 deg. C / 52 % RH
 Engineer Hiromasa Sato
 Mode Tx 11g

Freq.	Reading	Cable Loss	Atten. Loss	Conducted Power					e.i.r.p. for RSS-247					
				Result		Limit		Margin	Antenna Gain	Result		Limit		Margin
				[dBm]	[mW]	[dBm]	[mW]			[dB]	[dBi]	[dBm]	[mW]	
2412	11.37	2.15	9.82	23.34	215.77	30.00	1000	6.66	3.09	26.43	439.54	36.02	4000	9.59
2437	11.40	2.16	9.82	23.38	217.77	30.00	1000	6.62	3.09	26.47	443.61	36.02	4000	9.55
2462	10.86	2.16	9.82	22.84	192.31	30.00	1000	7.16	3.09	25.93	391.74	36.02	4000	10.09

Sample Calculation:

Result = Reading + Cable Loss (including the cable(s) customer supplied) + Attenuator Loss

e.i.r.p. Result = Conducted Power Result + Antenna Gain

2437 MHz

Rate	Reading	Remark
[Mbps]	[dBm]	
6	11.01	-
9	10.94	-
12	11.00	-
18	10.92	-
24	10.96	-
36	11.40	*
48	10.97	-
54	10.75	-

*: Worst Rate

All comparison were carried out on same frequency and measurement factors.

Maximum Peak Output Power

Test place Shonan EMC Lab. No.5 Shielded Room
 Date April 8, 2022
 Temperature / Humidity 23 deg. C / 52 % RH
 Engineer Hiromasa Sato
 Mode Tx 11n-20

Freq. [MHz]	Reading [dBm]	Cable Loss [dB]	Atten. Loss [dB]	Conducted Power					e.i.r.p. for RSS-247					
				Result		Limit		Margin [dB]	Antenna Gain [dBi]	Result		Limit		Margin [dB]
				[dBm]	[mW]	[dBm]	[mW]			[dBm]	[mW]	[dBm]	[mW]	
2412	11.11	2.15	9.82	23.08	203.24	30.00	1000	6.92	3.09	26.17	414.00	36.02	4000	9.85
2437	11.07	2.16	9.82	23.05	201.84	30.00	1000	6.95	3.09	26.14	411.15	36.02	4000	9.88
2462	10.76	2.16	9.82	22.74	187.93	30.00	1000	7.26	3.09	25.83	382.82	36.02	4000	10.19

Sample Calculation:

Result = Reading + Cable Loss (including the cable(s) customer supplied) + Attenuator Loss

e.i.r.p. Result = Conducted Power Result + Antenna Gain

2437 MHz

Rate	Reading	Remark
[MCS]	[dBm]	
0	10.90	-
1	10.74	-
2	10.69	-
3	10.72	-
4	10.78	-
5	11.07	*
6	10.69	-
7	10.79	-

*: Worst Rate

All comparison were carried out on same frequency and measurement factors.

Average Output Power
(Reference data for RF Exposure)

Test place Shonan EMC Lab. No.5 Shielded Room
Date April 8, 2022
Temperature / Humidity 23 deg. C / 52 % RH
Engineer Hiromasa Sato
Mode Tx

11b 11 Mbps

Freq. [MHz]	Reading [dBm]	Cable Loss [dB]	Atten. Loss [dB]	Result (Time average)		Duty factor [dB]	Result (Burst power average)	
				[dBm]	[mW]		[dBm]	[mW]
2412	1.39	2.15	9.82	13.36	21.68	0.00	13.36	21.68
2437	1.37	2.16	9.82	13.35	21.63	0.00	13.35	21.63
2462	1.07	2.16	9.82	13.05	20.18	0.00	13.05	20.18

11g 36 Mbps

Freq. [MHz]	Reading [dBm]	Cable Loss [dB]	Atten. Loss [dB]	Result (Time average)		Duty factor [dB]	Result (Burst power average)	
				[dBm]	[mW]		[dBm]	[mW]
2412	1.89	2.15	9.82	13.86	24.32	0.00	13.86	24.32
2437	1.96	2.16	9.82	13.94	24.77	0.00	13.94	24.77
2462	1.38	2.16	9.82	13.36	21.68	0.00	13.36	21.68

11n-20 MCS 5

Freq. [MHz]	Reading [dBm]	Cable Loss [dB]	Atten. Loss [dB]	Result (Time average)		Duty factor [dB]	Result (Burst power average)	
				[dBm]	[mW]		[dBm]	[mW]
2412	1.94	2.15	9.82	13.91	24.60	0.00	13.91	24.60
2437	1.69	2.16	9.82	13.67	23.28	0.00	13.67	23.28
2462	1.56	2.16	9.82	13.54	22.59	0.00	13.54	22.59

Sample Calculation:

Result (Time average) = Reading + Cable Loss (including the cable(s) customer supplied) + Attenuator Loss

Result (Burst power average) = Time average + Duty factor

Average Output Power
(Reference data for RF Exposure)

Test place Shonan EMC Lab. No.5 Shielded Room
Date April 8, 2022
Temperature / Humidity 23 deg. C / 52 % RH
Engineer Hiromasa Sato
Mode Tx

11b 2437 MHz

Rate [Mbps]	Reading [dBm]	Duty Factor [dB]	Result [dBm]	Remark
1	1.01	0.00	1.01	-
2	1.33	0.00	1.33	-
5.5	1.35	0.00	1.35	-
11	1.37	0.00	1.37	*

*: Worst Rate

11g 2437 MHz

Rate [Mbps]	Reading [dBm]	Duty Factor [dB]	Result [dBm]	Remark
6	1.89	0.00	1.89	-
9	1.90	0.00	1.90	-
12	1.93	0.00	1.93	-
18	1.59	0.00	1.59	-
24	1.91	0.00	1.91	-
36	1.96	0.00	1.96	*
48	1.67	0.00	1.67	-
54	1.81	0.00	1.81	-

*: Worst Rate

11n-20 2437 MHz

MCS	Reading [dBm]	Duty Factor [dB]	Result [dBm]	Remark
0	1.57	0.00	1.57	-
1	1.52	0.00	1.52	-
2	1.68	0.00	1.68	-
3	1.57	0.00	1.57	-
4	1.66	0.00	1.66	-
5	1.69	0.00	1.69	*
6	1.53	0.00	1.53	-
7	1.40	0.00	1.40	-

*: Worst Rate

Sample Calculation:

All comparisons were carried out on same frequency and measurement factors.

Burst rate confirmation

Test place Shonan EMC Lab. No.5 Shielded Room
 Date April 8, 2022
 Temperature / Humidity 23 deg. C / 52 % RH
 Engineer Hiromasa Sato
 Mode Tx

11b 11 Mbps

11g 36 Mbps

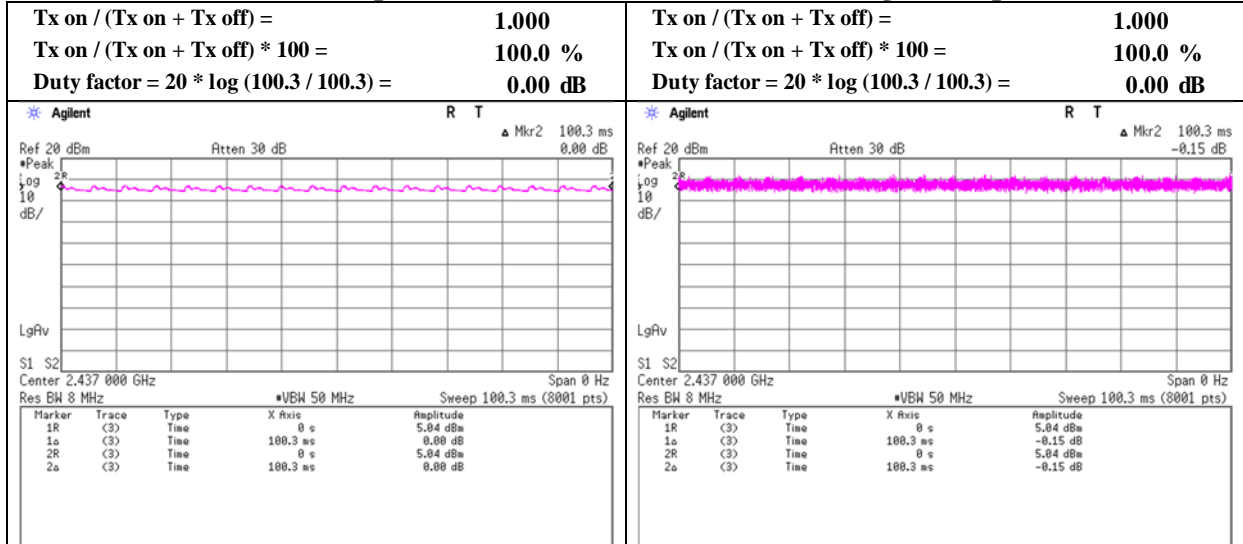

11n-20 MCS 5

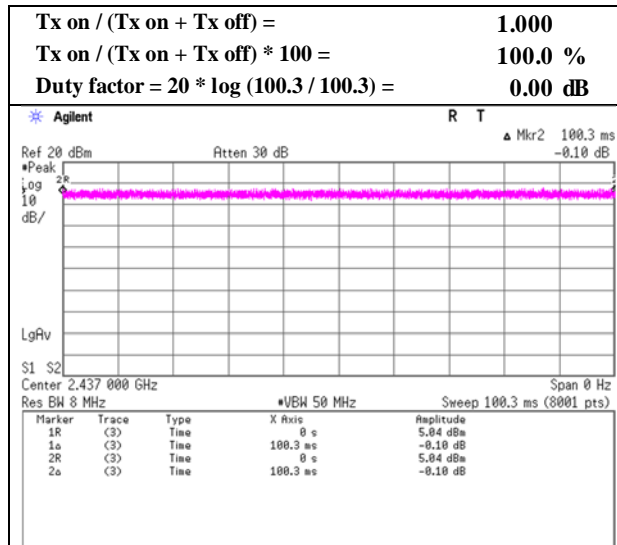

* Since the burst rate is not different between the channels, the data has been obtained on the representative channel.

Radiated Spurious Emission

Test place Shonan EMC Lab.
Semi Anechoic Chamber 3
Date April 20, 2022
Temperature / Humidity 23 deg.C, 43 %RH
Engineer Shiro Kobayashi
 (1 GHz -2.8 GHz)
Mode Tx 11b 2412 MHz

(* PK: Peak, AV: Average, QP: Quasi-Peak)

Polarity	Frequency [MHz]	Detector	Reading [dBuV]	Ant.Fac. [dB/m]	Loss [dB]	Gain [dB]	Distance Factor [dB]	Result [dBuV/m]	Limit [dBuV/m]	Margin [dB]	Height [cm]	Angle [deg]	Remark
Hori.	2386.400	PK	48.40	28.19	14.26	41.63	2.38	51.60	73.9	22.3	133	286	-
Hori.	2390.000	PK	48.25	28.18	14.26	41.63	2.38	51.44	73.9	22.4	133	286	-
Hori.	2386.400	AV	39.11	28.19	14.26	41.63	2.38	42.31	53.9	11.5	133	286	-
Hori.	2390.000	AV	38.53	28.18	14.26	41.63	2.38	41.72	53.9	12.1	133	286	-
Vert.	2386.720	PK	48.66	28.19	14.26	41.63	2.38	51.86	73.9	22.0	234	292	-
Vert.	2390.000	PK	47.91	28.18	14.26	41.63	2.38	51.10	73.9	22.8	234	292	-
Vert.	2386.720	AV	38.87	28.19	14.26	41.63	2.38	42.07	53.9	11.8	234	292	-
Vert.	2390.000	AV	38.47	28.18	14.26	41.63	2.38	41.66	53.9	12.2	234	292	-

Result = Reading + Ant.Fac. + Loss (Cable+(Attenuator or Filter)(below 18 GHz)) - Gain(Amplifier) + Distance factor

Distance factor : 1 GHz - 10 GHz : $20\log(3.945\text{ m} / 3.0\text{ m}) = 2.38\text{ dB}$

10 GHz - 40 GHz : $20\log(1.0\text{ m} / 3.0\text{ m}) = -9.54\text{ dB}$

20 dBc Data Sheet (RBW 100 kHz, VBW 300 kHz)

Polarity	Frequency [MHz]	Detector	Reading [dBuV]	Ant.Fac. [dB/m]	Loss [dB]	Gain [dB]	Distance Factor [dB]	Result [dBuV/m]	Limit [dBuV/m]	Margin [dB]	Remark
Hori.	2412.000	PK	91.75	28.15	14.28	41.64	2.38	94.92	-	-	Carrier
Hori.	2398.010	PK	48.42	28.17	14.27	41.64	2.38	51.60	74.9	23.3	-
Hori.	2400.000	PK	44.93	28.17	14.28	41.64	2.38	48.12	74.9	26.7	-
Vert.	2412.000	PK	90.67	28.15	14.28	41.64	2.38	93.84	-	-	Carrier
Vert.	2398.510	PK	46.69	28.17	14.27	41.64	2.38	49.87	73.8	23.9	-
Vert.	2400.000	PK	43.87	28.17	14.28	41.64	2.38	47.06	73.8	26.7	-

Result = Reading + Ant.Fac. + Loss (Cable+(Attenuator or Filter)(below 18 GHz)) - Gain(Amplifier) + Distance factor

Distance factor : 1 GHz - 10 GHz : $20\log(3.945\text{ m} / 3.0\text{ m}) = 2.38\text{ dB}$

10 GHz - 40 GHz : $20\log(1.0\text{ m} / 3.0\text{ m}) = -9.54\text{ dB}$

Radiated Spurious Emission (Reference Plot for band-edge)

Test place	Shonan EMC Lab.
Semi Anechoic Chamber	3
Date	April 20, 2022
Temperature / Humidity	23 deg.C, 43 %RH
Engineer	Shiro Kobayashi
	(1 GHz -2.8 GHz)
Mode	Tx 11b 2412 MHz

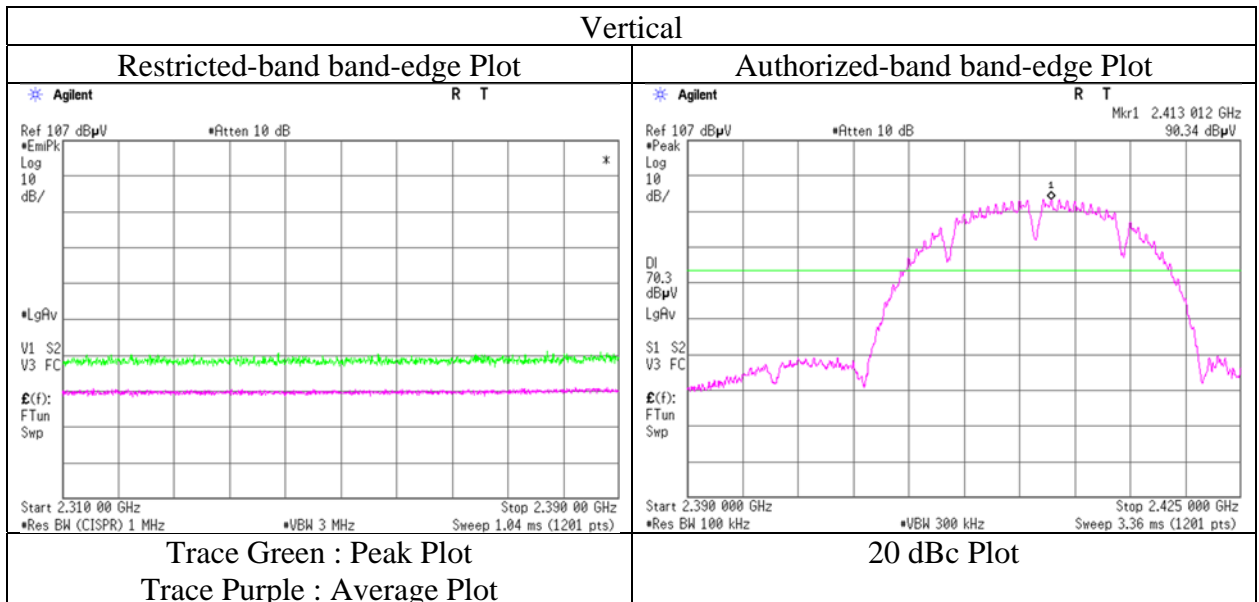
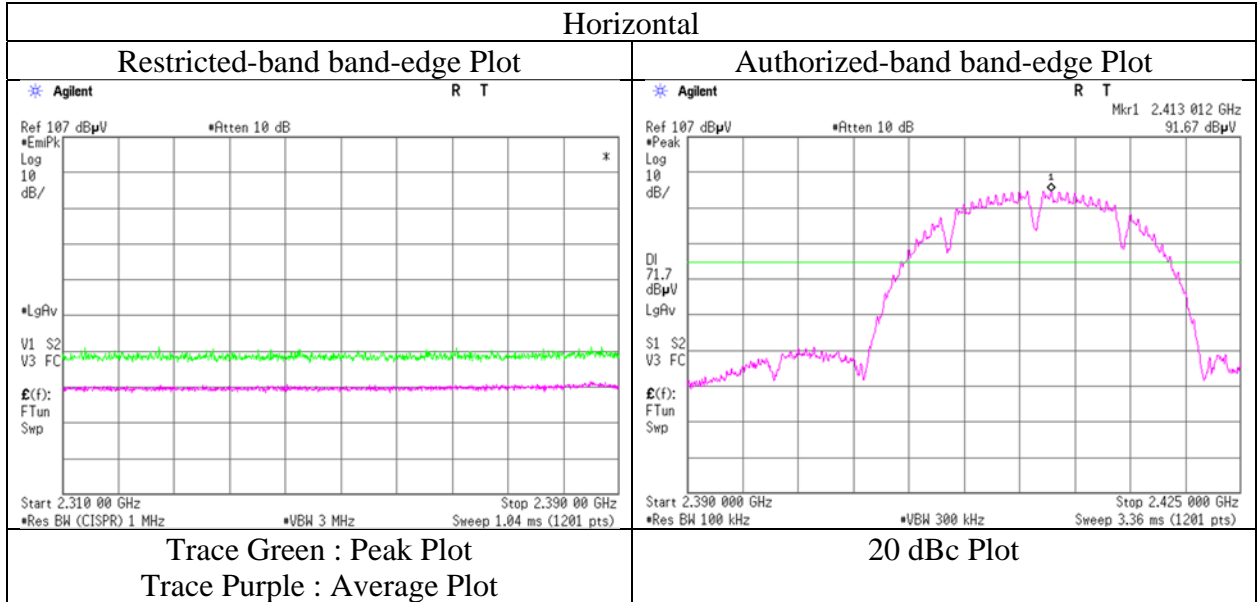

* The measurement was conducted for a sufficiently long enough time to detect any possible spurious emissions. Final result of restricted band edge was shown in tabular data.

Radiated Spurious Emission

Test place Shonan EMC Lab.
Semi Anechoic Chamber 3
Date April 20, 2022
Temperature / Humidity 23 deg.C, 43 %RH
Engineer Shiro Kobayashi
 (1 GHz -2.8 GHz)
Mode Tx 11b 2462 MHz

(* PK: Peak, AV: Average, QP: Quasi-Peak)

Polarity	Frequency [MHz]	Detector	Reading [dBuV]	Ant.Fac. [dB/m]	Loss [dB]	Gain [dB]	Distance Factor [dB]	Result [dBuV/m]	Limit [dBuV/m]	Margin [dB]	Height [cm]	Angle [deg]	Remark
Hori.	2483.500	PK	48.70	28.08	14.36	41.68	2.38	51.84	73.9	22.0	142	279	-
Hori.	2487.592	PK	48.70	28.08	14.36	41.68	2.38	51.84	73.9	22.0	142	279	-
Hori.	2483.500	AV	38.57	28.08	14.36	41.68	2.38	41.71	53.9	12.1	142	279	-
Hori.	2487.592	AV	39.14	28.08	14.36	41.68	2.38	42.28	53.9	11.6	142	279	-
Vert.	2483.500	PK	48.43	28.08	14.36	41.68	2.38	51.57	73.9	22.3	249	285	-
Vert.	2487.608	PK	48.54	28.08	14.36	41.68	2.38	51.68	73.9	22.2	249	285	-
Vert.	2483.500	AV	38.60	28.08	14.36	41.68	2.38	41.74	53.9	12.1	249	285	-
Vert.	2487.608	AV	38.96	28.08	14.36	41.68	2.38	42.10	53.9	11.8	249	285	-

Result = Reading + Ant.Fac. + Loss (Cable+(Attenuator or Filter)(below 18 GHz)) - Gain(Amplifier) + Distance factor

Distance factor : 1 GHz - 10 GHz : $20\log(3.945\text{ m} / 3.0\text{ m}) = 2.38\text{ dB}$

10 GHz - 40 GHz : $20\log(1.0\text{ m} / 3.0\text{ m}) = -9.54\text{ dB}$

Radiated Spurious Emission

Test place Shonan EMC Lab.
Semi Anechoic Chamber 3
Date April 20, 2022
Temperature / Humidity 23 deg.C, 43 %RH
Engineer Shiro Kobayashi
 (1 GHz -2.8 GHz)
Mode Tx 11g 2412 MHz

(* PK: Peak, AV: Average, QP: Quasi-Peak)

Polarity	Frequency [MHz]	Detector	Reading [dBuV]	Ant.Fac. [dB/m]	Loss [dB]	Gain [dB]	Distance Factor [dB]	Result [dBuV/m]	Limit [dBuV/m]	Margin [dB]	Height [cm]	Angle [deg]	Remark
Hori.	2390.000	PK	52.74	28.18	14.26	41.63	2.38	55.93	73.9	17.9	134	286	-
Hori.	2390.000	AV	41.13	28.18	14.26	41.63	2.38	44.32	53.9	9.5	134	286	-
Vert.	2390.000	PK	51.74	28.18	14.26	41.63	2.38	54.93	73.9	18.9	234	292	-
Vert.	2390.000	AV	40.27	28.18	14.26	41.63	2.38	43.46	53.9	10.4	234	292	-

Result = Reading + Ant.Fac. + Loss (Cable+(Attenuator or Filter)(below 18 GHz)) - Gain(Amplifier) + Distance factor

Distance factor : 1 GHz - 10 GHz : $20\log(3.945\text{ m} / 3.0\text{ m}) = 2.38\text{ dB}$

10 GHz - 40 GHz : $20\log(1.0\text{ m} / 3.0\text{ m}) = -9.54\text{ dB}$

20 dBc Data Sheet (RBW 100 kHz, VBW 300 kHz)

Polarity	Frequency [MHz]	Detector	Reading [dBuV]	Ant.Fac. [dB/m]	Loss [dB]	Gain [dB]	Distance Factor [dB]	Result [dBuV/m]	Limit [dBuV/m]	Margin [dB]	Remark
Hori.	2412.000	PK	89.87	28.15	14.28	41.64	2.38	93.04	-	-	Carrier
Hori.	2400.000	PK	52.34	28.17	14.28	41.64	2.38	55.53	73.0	17.4	-
Vert.	2412.000	PK	88.74	28.15	14.28	41.64	2.38	91.91	-	-	Carrier
Vert.	2400.000	PK	50.53	28.17	14.28	41.64	2.38	53.72	71.9	18.1	-

Result = Reading + Ant.Fac. + Loss (Cable+(Attenuator or Filter)(below 18 GHz)) - Gain(Amplifier) + Distance factor

Distance factor : 1 GHz - 10 GHz : $20\log(3.945\text{ m} / 3.0\text{ m}) = 2.38\text{ dB}$

10 GHz - 40 GHz : $20\log(1.0\text{ m} / 3.0\text{ m}) = -9.54\text{ dB}$

Radiated Spurious Emission (Reference Plot for band-edge)

Test place	Shonan EMC Lab.
Semi Anechoic Chamber	3
Date	April 20, 2022
Temperature / Humidity	23 deg.C, 43 %RH
Engineer	Shiro Kobayashi (1 GHz -2.8 GHz)
Mode	Tx 11g 2412 MHz

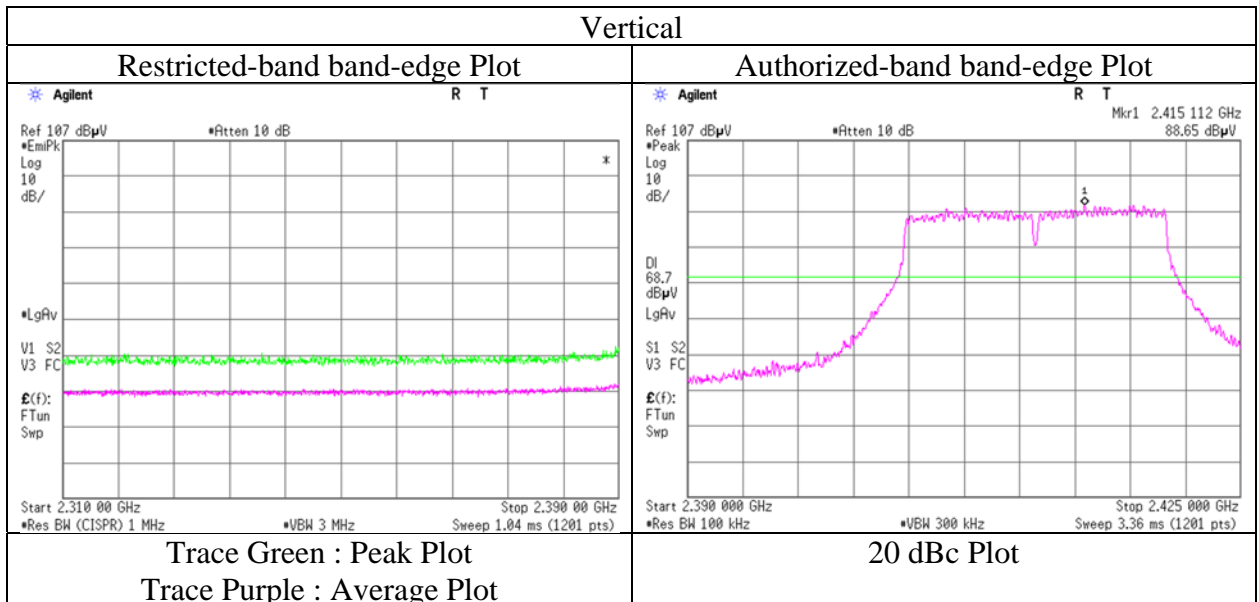
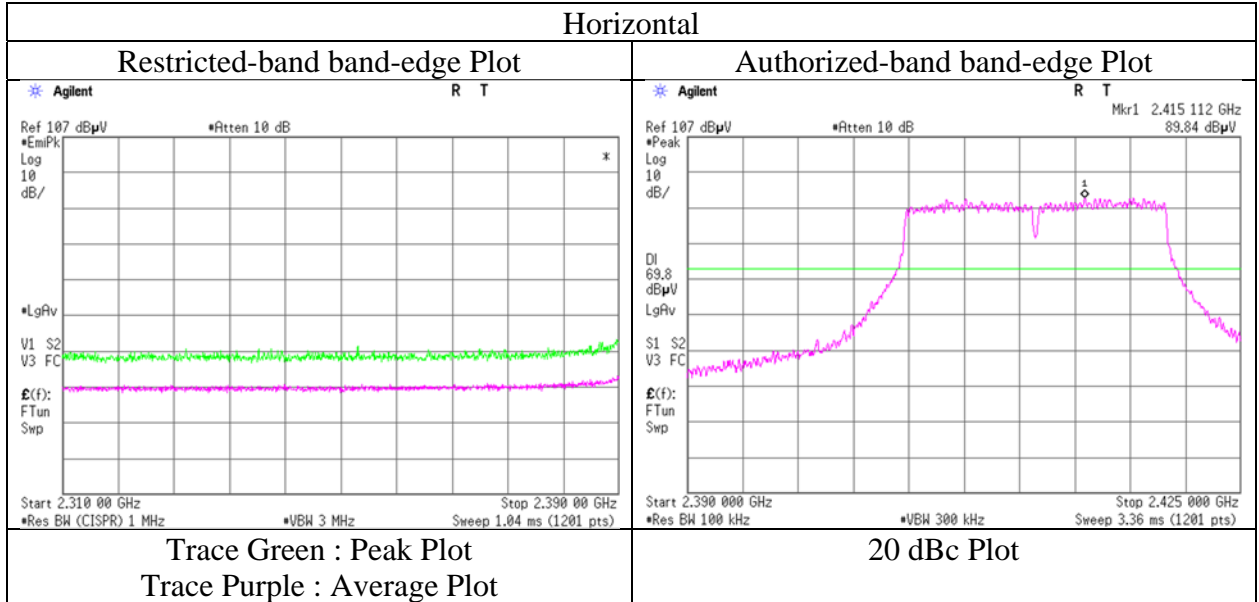

* The measurement was conducted for a sufficiently long enough time to detect any possible spurious emissions. Final result of restricted band edge was shown in tabular data.

Radiated Spurious Emission

Test place	Shonan EMC Lab.			
Semi Anechoic Chamber	1	3	2	1
Date	April 17, 2022	April 20, 2022	April 18, 2022	April 14, 2022
Temperature / Humidity	20 deg.C, 43 %RH	23 deg.C, 43 %RH	22 deg.C, 48 %RH	22 deg.C, 52 %RH
Engineer	Shito Koayashi (30 MHz -1 GHz)	Shiro Kobayashi (1 GHz -2.8 GHz)	Shito Koayashi (2.8 GHz -18 GHz)	Hiromasa Sato (18 GHz -26.5 GHz)
Mode	Tx 11g 2437 MHz			

(* PK: Peak, AV: Average, QP: Quasi-Peak)

Polarity	Frequency [MHz]	Detector	Reading [dBuV]	Ant.Fac. [dB/m]	Loss [dB]	Gain [dB]	Distance Factor [dB]	Result [dBuV/m]	Limit [dBuV/m]	Margin [dB]	Height [cm]	Angle [deg]	Remark
Hori.	233.709	QP	33.20	17.18	9.51	31.76	0.00	28.13	46.0	17.8	140	57	-
Hori.	4874.000	PK	49.02	31.92	6.80	38.58	2.38	51.54	73.9	22.3	132	358	-
Hori.	7311.000	PK	46.06	37.64	8.42	39.22	2.38	55.28	73.9	18.6	150	0	-
Hori.	9748.000	PK	45.18	39.25	9.64	39.73	2.38	56.72	73.9	17.1	150	0	-
Hori.	4874.000	AV	38.82	31.92	6.80	38.58	2.38	41.34	53.9	12.5	132	358	-
Hori.	7311.000	AV	34.40	37.64	8.42	39.22	2.38	43.62	53.9	10.2	150	0	Floor noise
Hori.	9748.000	AV	34.61	39.25	9.64	39.73	2.38	46.15	53.9	7.7	150	0	Floor noise
Vert.	32.426	QP	29.90	17.34	7.09	31.84	0.00	22.49	40.0	17.5	100	194	-
Vert.	36.284	QP	29.40	16.24	7.19	31.84	0.00	20.99	40.0	19.0	154	12	-
Vert.	42.949	QP	31.60	13.82	7.34	31.83	0.00	20.93	40.0	19.0	100	340	-
Vert.	62.308	QP	41.40	7.70	7.24	31.83	0.00	24.51	40.0	15.4	100	114	-
Vert.	66.290	QP	45.50	7.07	7.30	31.82	0.00	28.05	40.0	11.9	100	138	-
Vert.	71.589	QP	47.60	6.50	7.67	31.82	0.00	29.95	40.0	10.0	100	150	-
Vert.	77.048	QP	40.60	6.35	8.15	31.82	0.00	23.28	40.0	16.7	100	151	-
Vert.	120.045	QP	44.90	13.07	8.20	31.80	0.00	34.37	43.5	9.1	100	156	-
Vert.	221.884	QP	35.90	16.86	9.40	31.77	0.00	30.39	46.0	15.6	100	147	-
Vert.	4874.000	PK	50.07	31.92	6.80	38.58	2.38	52.59	73.9	21.3	101	300	-
Vert.	7311.000	PK	45.59	37.64	8.42	39.22	2.38	54.81	73.9	19.0	150	0	-
Vert.	9748.000	PK	45.39	39.25	9.64	39.73	2.38	56.93	73.9	16.9	150	0	-
Vert.	4874.000	AV	38.75	31.92	6.80	38.58	2.38	41.27	53.9	12.6	101	300	-
Vert.	7311.000	AV	34.45	37.64	8.42	39.22	2.38	43.67	53.9	10.2	150	0	Floor noise
Vert.	9748.000	AV	34.64	39.25	9.64	39.73	2.38	46.18	53.9	7.7	150	0	Floor noise

Result = Reading + Ant.Fac. + Loss (Cable+(Attenuator or Filter)(below 18 GHz)) - Gain(Amplifier) + Distance factor

Distance factor : 1 GHz - 10 GHz : $20\log(3.945\text{ m} / 3.0\text{ m}) = 2.38\text{ dB}$

10 GHz - 40 GHz : $20\log(1.0\text{ m} / 3.0\text{ m}) = -9.54\text{ dB}$

Radiated Spurious Emission

Test place	Shonan EMC Lab.
Semi Anechoic Chamber	3
Date	April 20, 2022
Temperature / Humidity	23 deg.C, 43 %RH
Engineer	Shiro Kobayashi (1 GHz -2.8 GHz)
Mode	Tx 11g 2462 MHz

(* PK: Peak, AV: Average, QP: Quasi-Peak)

Polarity	Frequency [MHz]	Detector	Reading [dBuV]	Ant.Fac. [dB/m]	Loss [dB]	Gain [dB]	Distance Factor [dB]	Result [dBuV/m]	Limit [dBuV/m]	Margin [dB]	Height [cm]	Angle [deg]	Remark
Hori.	2483.500	PK	56.72	28.08	14.36	41.68	2.38	59.86	73.9	14.0	143	279	-
Hori.	2483.500	AV	43.48	28.08	14.36	41.68	2.38	46.62	53.9	7.2	143	279	-
Vert.	2483.500	PK	56.38	28.08	14.36	41.68	2.38	59.52	73.9	14.3	252	288	-
Vert.	2483.500	AV	43.02	28.08	14.36	41.68	2.38	46.16	53.9	7.7	252	288	-

Result = Reading + Ant.Fac. + Loss (Cable+(Attenuator or Filter)(below 18 GHz)) - Gain(Amplifier) + Distance factor

Distance factor : 1 GHz - 10 GHz : $20\log(3.945\text{ m} / 3.0\text{ m}) = 2.38\text{ dB}$

10 GHz - 40 GHz : $20\log(1.0\text{ m} / 3.0\text{ m}) = -9.54\text{ dB}$

Radiated Spurious Emission (Reference Plot for band-edge)

Test place Shonan EMC Lab.
Semi Anechoic Chamber 3
Date April 20, 2022
Temperature / Humidity 23 deg.C, 43 %RH
Engineer Shiro Kobayashi
 (1 GHz -2.8 GHz)
Mode Tx 11g 2462 MHz

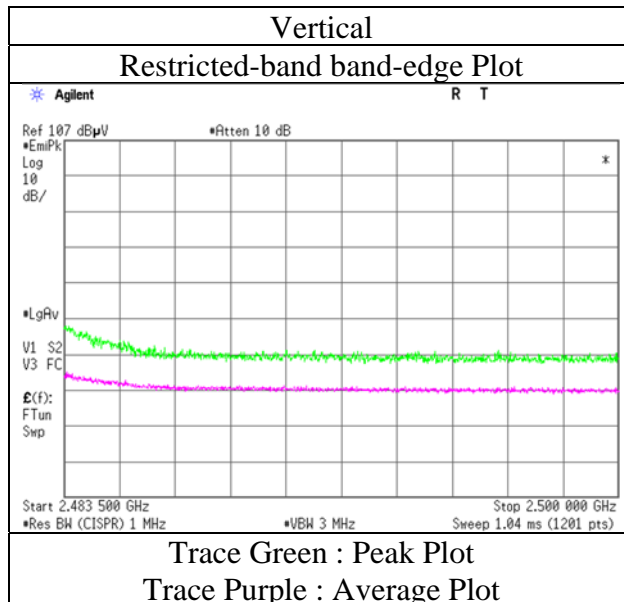
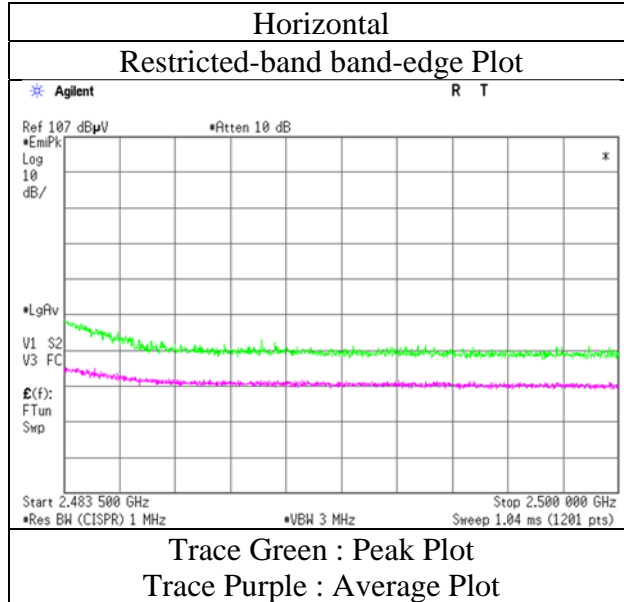

* The measurement was conducted for a sufficiently long enough time to detect any possible spurious emissions. Final result of restricted band edge was shown in tabular data.

Radiated Spurious Emission

Test place Shonan EMC Lab.
Semi Anechoic Chamber 3
Date April 20, 2022
Temperature / Humidity 23 deg.C, 43 %RH
Engineer Shiro Kobayashi
 (1 GHz -2.8 GHz)
Mode Tx 11n-20 2412 MHz

(* PK: Peak, AV: Average, QP: Quasi-Peak)

Polarity	Frequency [MHz]	Detector	Reading [dBuV]	Ant.Fac. [dB/m]	Loss [dB]	Gain [dB]	Distance Factor [dB]	Result [dBuV/m]	Limit [dBuV/m]	Margin [dB]	Height [cm]	Angle [deg]	Remark
Hori.	2390.000	PK	54.85	28.18	14.26	41.63	2.38	58.04	73.9	15.8	135	286	-
Hori.	2390.000	AV	42.82	28.18	14.26	41.63	2.38	46.01	53.9	7.8	135	286	-
Vert.	2390.000	PK	53.47	28.18	14.26	41.63	2.38	56.66	73.9	17.2	232	291	-
Vert.	2390.000	AV	41.79	28.18	14.26	41.63	2.38	44.98	53.9	8.9	232	291	-

Result = Reading + Ant.Fac. + Loss (Cable+(Attenuator or Filter)(below 18 GHz)) - Gain(Amplifier) + Distance factor

Distance factor : 1 GHz - 10 GHz : 20log (3.945 m / 3.0 m) = 2.38 dB

10 GHz - 40 GHz : 20log (1.0 m / 3.0 m) = -9.54 dB

20 dBc Data Sheet (RBW 100 kHz, VBW 300 kHz)

Polarity	Frequency [MHz]	Detector	Reading [dBuV]	Ant.Fac. [dB/m]	Loss [dB]	Gain [dB]	Distance Factor [dB]	Result [dBuV/m]	Limit [dBuV/m]	Margin [dB]	Remark
Hori.	2412.000	PK	90.70	28.15	14.28	41.64	2.38	93.87	-	-	Carrier
Hori.	2400.000	PK	53.51	28.17	14.28	41.64	2.38	56.70	73.8	17.1	-
Vert.	2412.000	PK	89.56	28.15	14.28	41.64	2.38	92.73	-	-	Carrier
Vert.	2400.000	PK	51.84	28.17	14.28	41.64	2.38	55.03	72.7	17.6	-

Result = Reading + Ant.Fac. + Loss (Cable+(Attenuator or Filter)(below 18 GHz)) - Gain(Amplifier) + Distance factor

Distance factor : 1 GHz - 10 GHz : 20log (3.945 m / 3.0 m) = 2.38 dB

10 GHz - 40 GHz : 20log (1.0 m / 3.0 m) = -9.54 dB

Radiated Spurious Emission (Reference Plot for band-edge)

Test place	Shonan EMC Lab.
Semi Anechoic Chamber	3
Date	April 20, 2022
Temperature / Humidity	23 deg.C, 43 %RH
Engineer	Shiro Kobayashi
	(1 GHz -2.8 GHz)
Mode	Tx 11n-20 2412 MHz

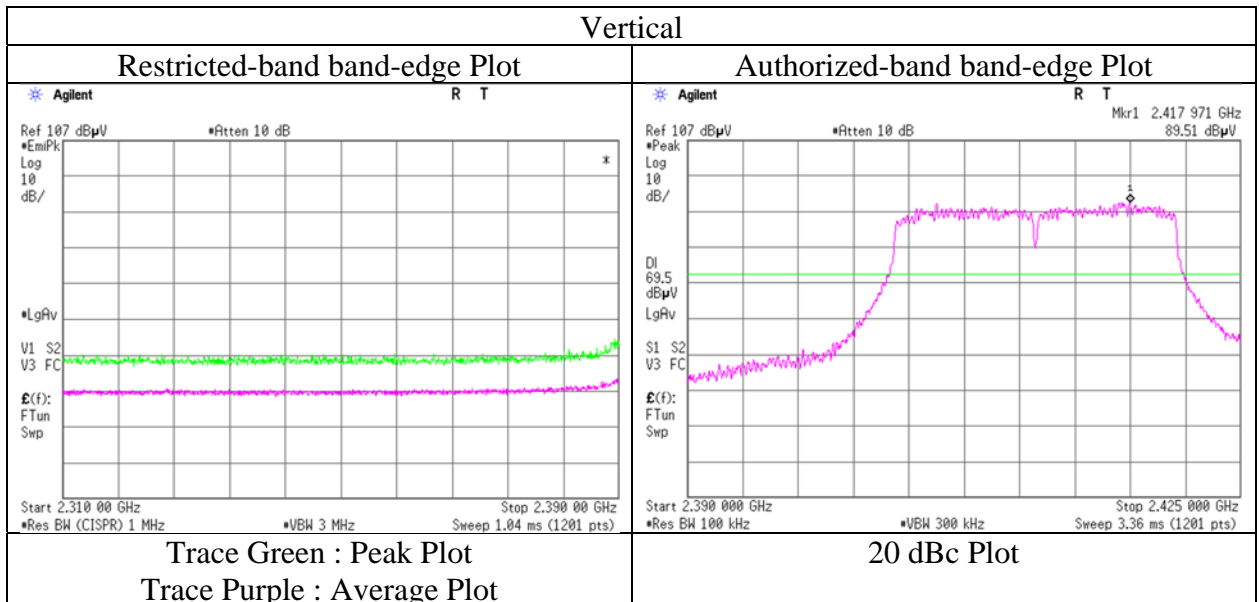
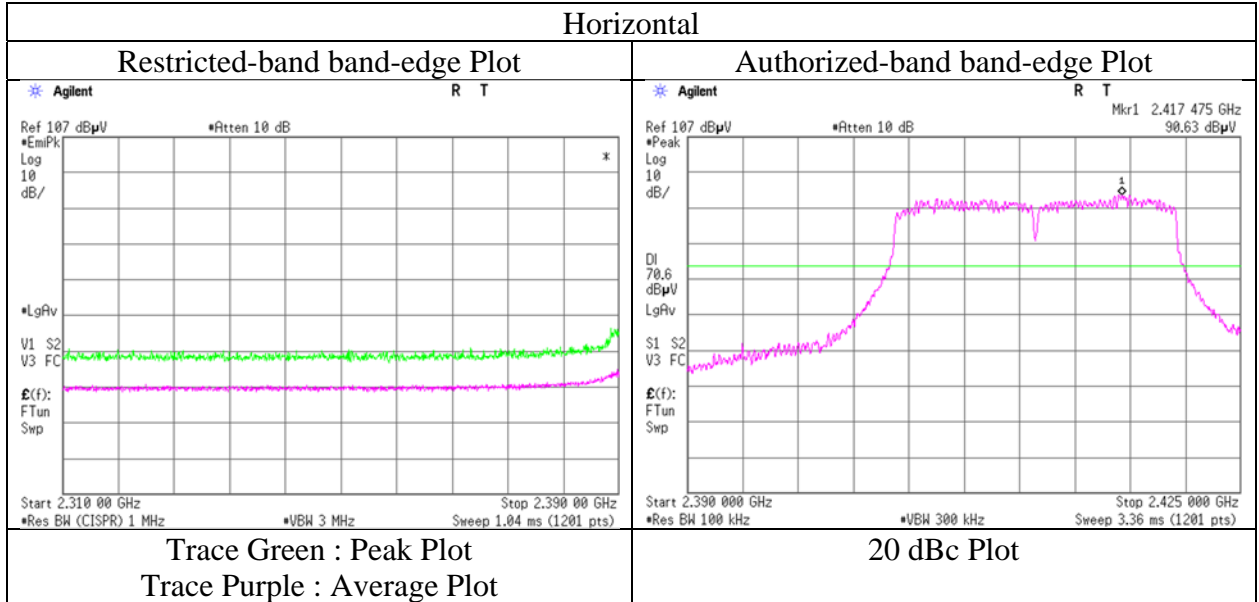

* The measurement was conducted for a sufficiently long enough time to detect any possible spurious emissions. Final result of restricted band edge was shown in tabular data.

Radiated Spurious Emission

Test place	Shonan EMC Lab.
Semi Anechoic Chamber	3
Date	April 20, 2022
Temperature / Humidity	23 deg.C, 43 %RH
Engineer	Shiro Kobayashi (1 GHz -2.8 GHz)
Mode	Tx 11n-20 2462 MHz

(* PK: Peak, AV: Average, QP: Quasi-Peak)

Polarity	Frequency [MHz]	Detector	Reading [dBuV]	Ant.Fac. [dB/m]	Loss [dB]	Gain [dB]	Distance Factor [dB]	Result [dBuV/m]	Limit [dBuV/m]	Margin [dB]	Height [cm]	Angle [deg]	Remark
Hori.	2483.500	PK	59.12	28.08	14.36	41.68	2.38	62.26	73.9	11.6	142	277	-
Hori.	2483.500	AV	45.92	28.08	14.36	41.68	2.38	49.06	53.9	4.8	142	277	-
Vert.	2483.500	PK	58.66	28.08	14.36	41.68	2.38	61.80	73.9	12.1	261	287	-
Vert.	2483.500	AV	44.89	28.08	14.36	41.68	2.38	48.03	53.9	5.8	261	287	-

Result = Reading + Ant.Fac. + Loss (Cable+(Attenuator or Filter)(below 18 GHz)) - Gain(Amplifier) + Distance factor

Distance factor : 1 GHz - 10 GHz : $20\log(3.945\text{ m} / 3.0\text{ m}) = 2.38\text{ dB}$

10 GHz - 40 GHz : $20\log(1.0\text{ m} / 3.0\text{ m}) = -9.54\text{ dB}$

Radiated Spurious Emission (Reference Plot for band-edge)

Test place Shonan EMC Lab.
Semi Anechoic Chamber 3
Date April 20, 2022
Temperature / Humidity 23 deg.C, 43 %RH
Engineer Shiro Kobayashi
 (1 GHz -2.8 GHz)
Mode Tx 11n-20 2462 MHz

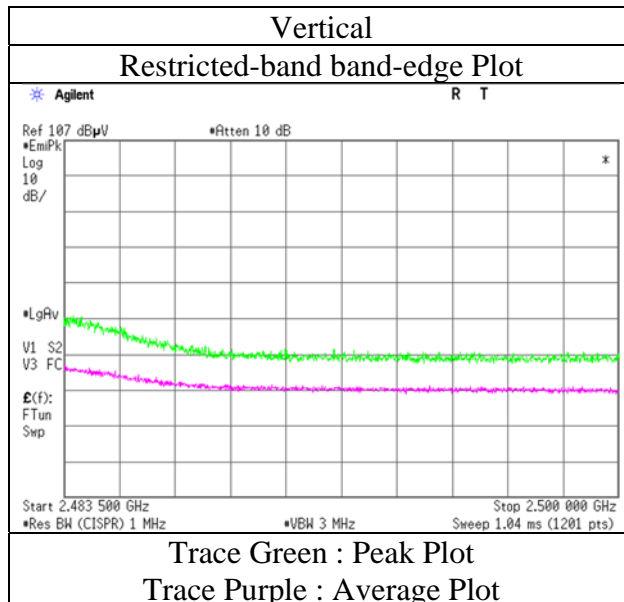
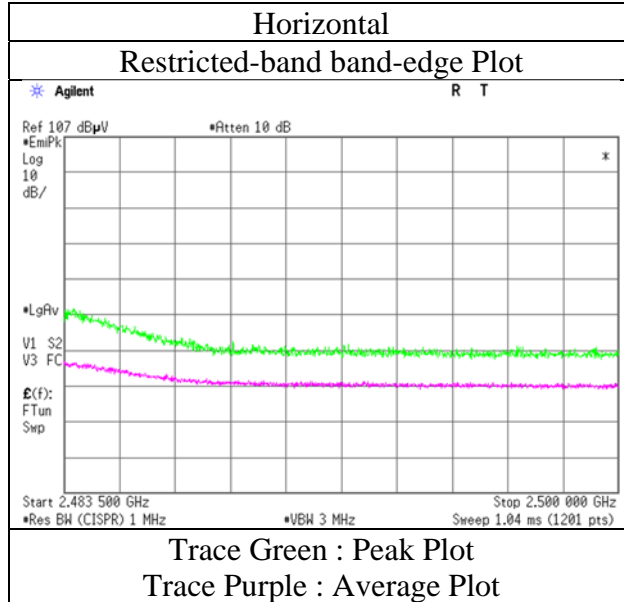

* The measurement was conducted for a sufficiently long enough time to detect any possible spurious emissions. Final result of restricted band edge was shown in tabular data.

Radiated Spurious Emission
(Plot data, Worst case mode for Maximum Peak Output Power)

Test place	Shonan EMC Lab.			
Semi Anechoic Chamber	1	3	2	1
Date	April 17, 2022	April 20, 2022	April 18, 2022	April 14, 2022
Temperature / Humidity	20 deg.C, 43 %RH	23 deg.C, 43 %RH	22 deg.C, 48 %RH	22 deg.C, 52 %RH
Engineer	Shito Koayashi (30 MHz -1 GHz)	Shiro Kobayashi (1 GHz -2.8 GHz)	Shito Koayashi (2.8 GHz -18 GHz)	Hiromasa Sato (18 GHz -26.5 GHz)
Mode	Tx 11g 2437 MHz			

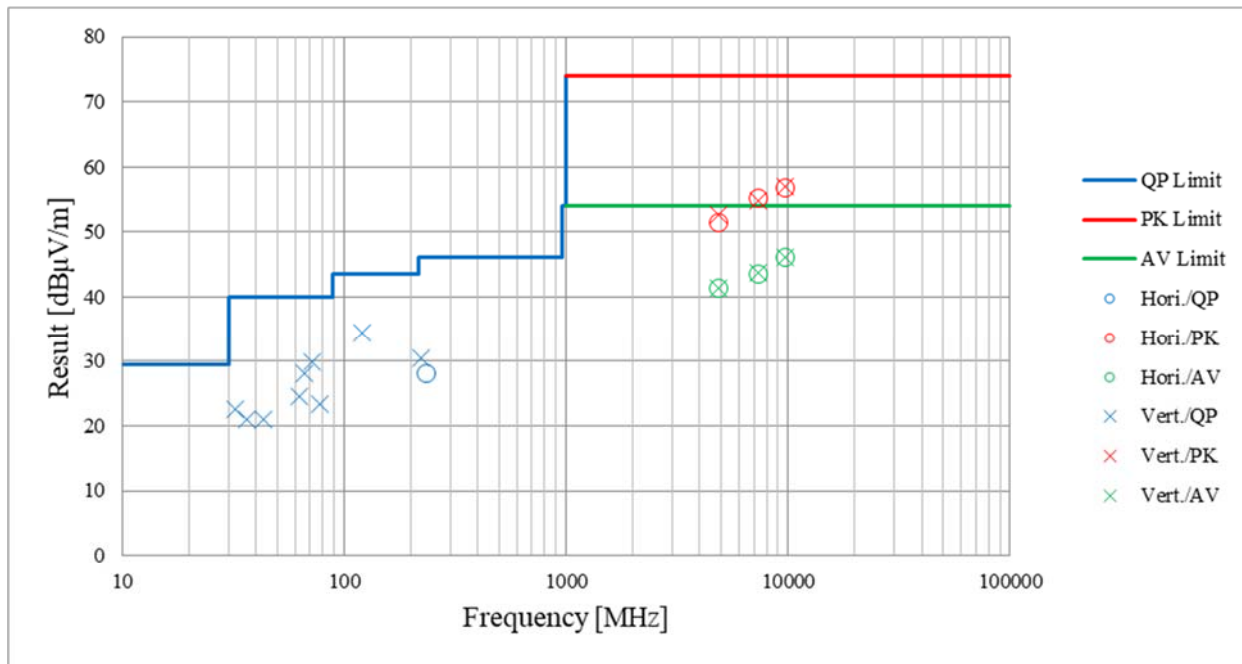

*These plots data contains sufficient number to show the trend of characteristic features for EUT.

Conducted Spurious Emission

Test place	Shonan EMC Lab. No.5 Shielded Room
Date	May 17, 2022
Temperature / Humidity	25 deg. C / 48 % RH
Engineer	Hiromasa Sato
Mode	Tx 11g 2437 MHz

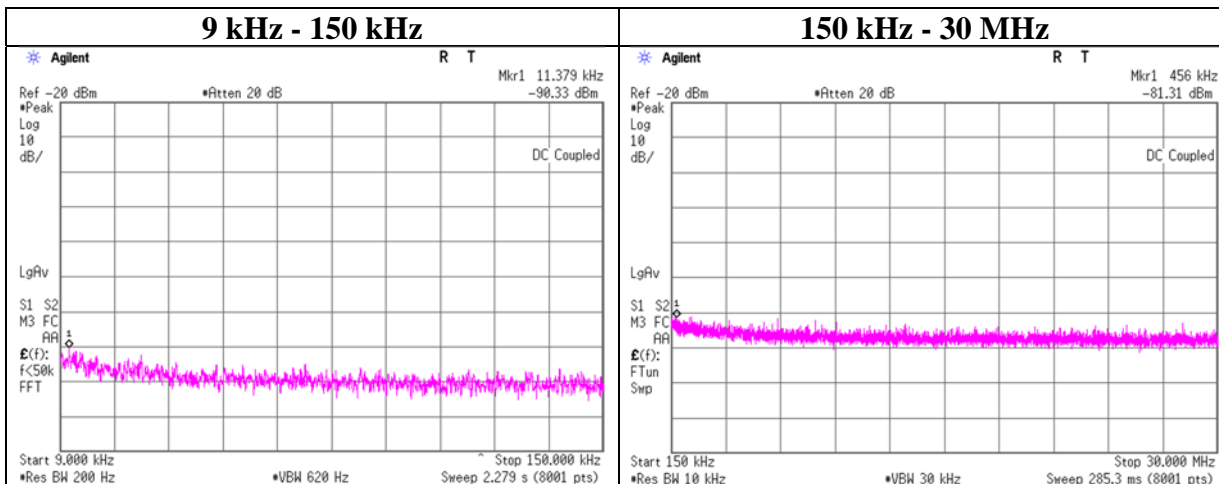

Frequency [kHz]	Reading [dBm]	Cable Loss [dB]	Attenuator Loss [dB]	Antenna Gain [dBi]	N (Number of Output)	EIRP [dBm]	Distance [m]	Ground bounce [dB]	E (field strength) [dBuV/m]	Limit [dBuV/m]	Margin [dB]	Remark
11.379	-90.33	1.50	9.74	3.09	1	-76.0	300	6.0	-14.7	46.4	61.1	-
456.000	-81.31	1.51	9.74	3.09	1	-67.0	300	6.0	-5.7	14.4	20.1	-

$E [dBuV/m] = EIRP [dBm] - 20 \log (Distance [m]) + Ground\ bounce [dB] + 104.8 [dBuV/m]$

$EIRP [dBm] = Reading [dBm] + Cable\ loss [dB] + Attenuator\ Loss [dB] + Antenna\ gain [dBi] + 10 * \log (N)$

N: Number of output

Power Density

Test place	Shonan EMC Lab. No.5 Shielded Room
Date	May 24, 2022
Temperature / Humidity	25 deg. C / 46 % RH
Engineer	Shiro Kobayashi
Mode	Tx

11b

Frequency [MHz]	Measured Frequency [MHz]	Reading [dBm/3 kHz]	Cable Loss [dB]	Atten. Loss [dB]	Result [dBm/3 kHz]	Limit [dBm/3 kHz]	Margin [dB]
2412	2412.000	-29.70	2.15	10.17	-17.38	8.00	25.38
2437	2437.000	-28.98	2.16	10.18	-16.64	8.00	24.64
2462	2462.000	-29.67	2.16	10.18	-17.33	8.00	25.33

11g

Frequency [MHz]	Measured Frequency [MHz]	Reading [dBm/3 kHz]	Cable Loss [dB]	Atten. Loss [dB]	Result [dBm/3 kHz]	Limit [dBm/3 kHz]	Margin [dB]
2412	2412.000	-24.55	2.15	10.17	-12.23	8.00	20.23
2437	2437.000	-24.72	2.16	10.18	-12.38	8.00	20.38
2462	2462.000	-25.00	2.16	10.18	-12.66	8.00	20.66

11n-20 (SISO)

Frequency [MHz]	Measured Frequency [MHz]	Reading [dBm/3 kHz]	Cable Loss [dB]	Atten. Loss [dB]	Result [dBm/3 kHz]	Limit [dBm/3 kHz]	Margin [dB]
2412	2412.000	-23.90	2.15	10.17	-11.58	8.00	19.58
2437	2437.000	-23.82	2.16	10.18	-11.48	8.00	19.48
2462	2462.000	-24.23	2.16	10.18	-11.89	8.00	19.89

Sample Calculation:

Result = Reading + Cable Loss (including the cable(s) customer supplied) + Attenuator Loss

*The equipment and cables were not used for factor 0 dB of the data sheets.

Power Density

11b, 11 Mbps

11g, 36 Mbps

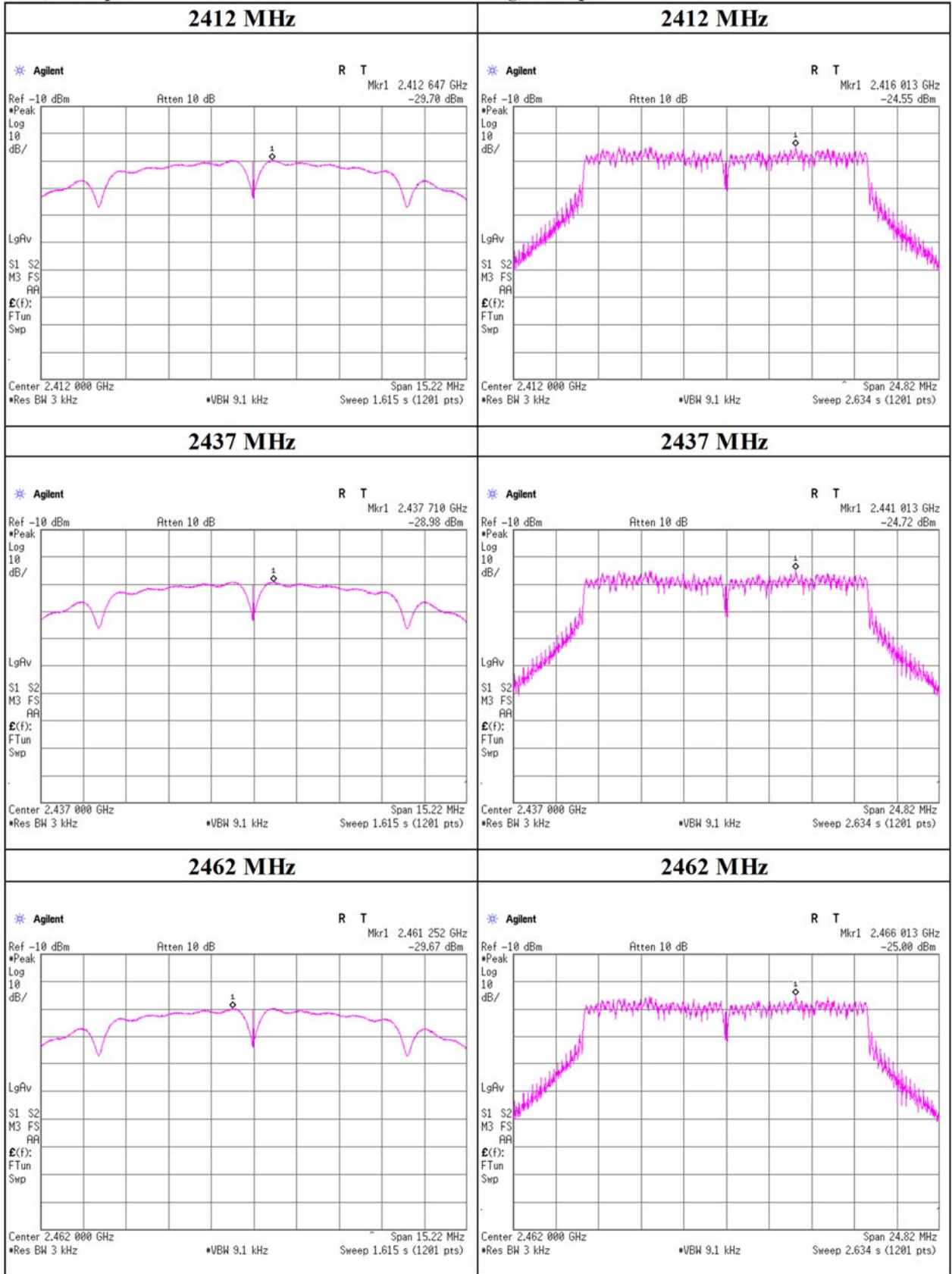

Power Density

11n-20, MCS 5

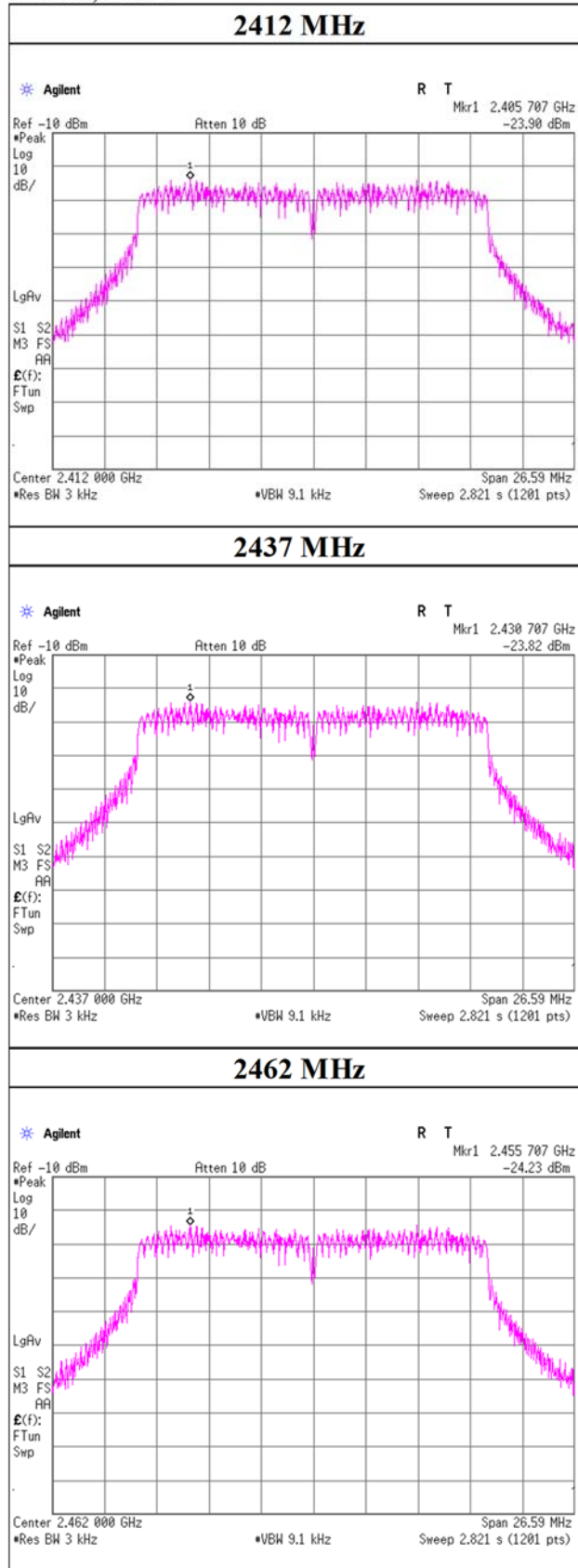

APPENDIX 2: Test Instruments

Test Equipment [1/2]

Test Item	Local ID	LIMS ID	Description	Manufacturer	Model	Serial	Last Calibration Date	Cal Int
RE	COTS-SEMI-5	170932	EMI Software	TSJ (Techno Science Japan)	TEPTO-DV3 (RE,CE,ME,PE)	-	-	-
RE	KAT6-04	144899	Attenuator	Inmet	18N-6dB	-	2021/12/10	12
RE	KBA-01	146343	Biconical Antenna	Schwarzbeck Mess- Elektronik OHG	BBA9106	1748	2021/06/12	12
RE	KJM-02	146432	Measure	TAJIMA	GL19-55	-	-	-
RE	KSA-08	145089	Spectrum Analyzer	Keysight Technologies Inc	E4446A	MY46180525	2021/10/13	12
RE	SAEC-01(NSA)	145597	Semi-Anechoic Chamber	TDK	SAEC-01(NSA)	1	2022/04/11	12
RE	SAEC-01(SVSWR)	145561	Semi-Anechoic Chamber	TDK	SAEC-01(SVSWR)	1	2021/05/09	12
RE	SAEC-02(SVSWR)	145598	Semi-Anechoic Chamber	TDK	SAEC-02(SVSWR)	2	2021/05/20	12
RE	SAEC-03(SVSWR)	145566	Semi-Anechoic Chamber	TDK	SAEC-03(SVSWR)	3	2021/05/21	12
RE	SAF-01	145003	Pre Amplifier	SONOMA	310N	290211	2022/02/24	12
RE	SAF-05	145128	Pre Amplifier	Toyo Corporation	TPA0118-36	1440490	2021/05/17	12
RE	SAF-06	145005	Pre Amplifier	Toyo Corporation	TPA0118-36	1440491	2022/02/04	12
RE	SAF-08	145007	Pre Amplifier	Toyo Corporation	HAP18-26W	19	2022/03/03	12
RE	SAF-10	145129	Pre Amplifier	Toyo Corporation	HAP26-40W	10	2022/03/03	12
RE	SAT10-05	145136	Attenuator	Keysight Technologies Inc	8493C-010	74864	2021/10/07	12
RE	SAT3-09	144959	Attenuator	JFW	50HF-003N	-	2021/08/16	12
RE	SCC- A1/A3/A5/A7/ A8/A13/SRSE- 01	144967	Coaxial Cable&RF Selector	Fujikura/Fujikura/Suhner/Suhner/Suhner/Suhner/TOYO	8D2W/12DSFA/141PE/141PE/141PE/141PE/NS4906	-/0901-269(RF Selector)	2022/04/20	12
RE	SCC- A2/A4/A6/A7/ A8/A13/SRSE- 01	144968	Coaxial Cable&RF Selector	Fujikura/Fujikura/Suhner/Suhner/Suhner/Suhner/TOYO	8D2W/12DSFA/141PE/141PE/141PE/141PE/NS4906	-/0901-269(RF Selector)	2022/04/20	12
RE	SCC-G15	145176	Coaxial Cable	Suhner	SUCOFLEX 102	32703/2	2022/03/03	12
RE	SCC-G40	166491	Coaxial Cable	Junkosha	MWX221-01000NFSNMS/B	1612S005	2022/01/06	12
RE	SCC-G41	151617	Coaxial Cable	Junkosha	MWX221-01000NFSNMS/B	1612S006	2022/01/06	12
RE	SCC-G43	156380	Coaxial Cable	Huber+Suhner	SUCOFLEX_104_E	SN MY 13406/4E	2021/05/17	12
RE	SCC-G50	178573	Coaxial Cable	Huber+Suhner	SUCOFLEX_104_E	MY13407/4E	2022/03/03	12
RE	SCC-G51	178572	Coaxial Cable	Huber+Suhner	SUCOFLEX 104	800288 /4A	2022/03/03	12
RE	SCC-G57	179540	Coaxial Cable	Huber+Suhner	SUCOFLEX 102	802815/2	2021/05/18	12
RE	SCC-G58	183047	Coaxial Cable	Huber+Suhner	SUCOFLEX 104	800287/4A	2021/05/17	12
RE	SCC-G69	200009	Coaxial Cable	Huber+Suhner	SUCOFLEX 104	575617/4	2021/07/06	12
RE	SFL-02	145301	Highpass Filter	MICRO-TRONICS	HPM50111	51	2021/10/07	12
RE	SHA-02	145384	Horn Antenna	Schwarzbeck Mess- Elektronik OHG	BBHA9120D	9120D-726	2022/03/10	12

Test Equipment [2/2]

Test Item	Local ID	LIMS ID	Description	Manufacturer	Model	Serial	Last Calibration Date	Cal Int
RE	SHA-03	145501	Horn Antenna	Schwarzbeck Mess-Elektronik OHG	BBHA9120D	9120D-739	2022/03/16	12
RE	SHA-04	145512	Horn Antenna	ETS-Lindgren	3160-09	00094868	2021/06/14	12
RE	SHA-06	145514	Horn Antenna	ETS-Lindgren	3160-10	00092383	2021/06/14	12
RE	SHA-09	194684	Horn Antenna	Schwarzbeck Mess-Elektronik OHG	BBHA 9120 C	695	2022/03/10	12
RE	SJM-20	207277	Measuring	ASKUL	-	-	-	-
RE	SJM-22	207279	Measuring Tool, Tape Measure	ASKUL	-	-	-	-
RE	SLA-01	145531	Logperiodic Antenna	Schwarzbeck Mess-Elektronik OHG	UHALP9108A	UHALP 9108-A 0888	2021/06/12	12
RE	SOS-20	191837	Humidity Indicator	CUSTOM. Inc	CTH-201	-	2021/08/02	12
RE	SOS-21	191838	Humidity Indicator	CUSTOM. Inc	CTH-201	-	2021/08/02	12
RE	SOS-23	191840	Humidity Indicator	CUSTOM. Inc	CTH-201	-	2021/08/02	12
RE	SSA-03	145801	Spectrum Analyzer	Keysight Technologies Inc	E4448A	MY48250152	2021/08/09	12
RE	STR-01	145790	Test Receiver	Rohde & Schwarz	ESU40	100093	2022/04/28	12
RE	STS-01	145792	Digital Hitester	HIOKI E.E. CORPORATION	3805-50	80997812	2021/09/14	12
RE	STS-02	145793	Digital Hitester	HIOKI E.E. CORPORATION	3805-50	80997819	2022/04/07	12
RE	STS-03	146210	Digital Hitester	HIOKI E.E. CORPORATION	3805-50	80997823	2021/09/14	12
AT	SAT10-14	154591	Attenuator	Weinschel Corp.	54A-10	81595	2022/04/01	12
AT	SAT10-15	160493	Attenuator	Weinschel Corp.	54A-10	83406	2021/12/07	12
AT	SCC-G63	196946	Coaxial Cable	Huber+Suhner	SUCOFLEX 102	803411/2	2022/03/01	12
AT	SCC-G65	196942	Coaxial Cable	Huber+Suhner	SUCOFLEX 102	803416/2	2022/03/01	12
AT	SOS-27	191845	Humidity Indicator	CUSTOM. Inc	CTH-201	-	2021/08/02	12
AT	SPM-13	169910	Power Meter	Keysight Technologies Inc	8990B	MY51000448	2022/01/25	12
AT	SPSS-06	169911	Power sensor	Keysight Technologies Inc	N1923A	MY57270004	2022/01/25	12
AT	SRENT-22	202830	Spectrum Analyzer	Keysight Technologies Inc	E4440A	MY48250036	2021/12/01	12

*Hyphens for Last Calibration Date and Cal Int (month) are instruments that Calibration is not required (e.g. software), or instruments checked in advance before use.

The expiration date of the calibration is the end of the expired month.

As for some calibrations performed after the tested dates, those test equipment have been controlled by means of an unbroken chains of calibrations.

All equipment is calibrated with valid calibrations. Each measurement data is traceable to the national or international standards.

Test item: **RE: Radiated Emission**
 AT: Antenna Terminal Conducted