

FCC Test Report

Report No.: RF170918E11-1

FCC ID: BKMFBJ26H005

Test Model: J26H005

Received Date: Sep. 18, 2017

Test Date: Sep. 27 to Oct. 06, 2017

Issued Date: Nov. 23, 2017

Applicant: Seiko Epson Corporation

Address: 3-3-5 Owa Suwa-shi Nagano-Ken 392-8502, Japan

Issued By: Bureau Veritas Consumer Products Services (H.K.) Ltd., Taoyuan Branch
Hsin Chu Laboratory

Lab Address: E-2, No.1, Li Hsin 1st Road, Hsinchu Science Park, Hsinchu City 300,
Taiwan R.O.C.

Test Location : E-2, No.1, Li Hsin 1st Road, Hsinchu Science Park, Hsinchu City 300,
Taiwan R.O.C.

**FCC Registration /
Designation Number:** 723255 / TW2022



This report is for your exclusive use. Any copying or replication of this report to or for any other person or entity, or use of our name or trademark, is permitted only with our prior written permission. This report sets forth our findings solely with respect to the test samples identified herein. The results set forth in this report are not indicative or representative of the quality or characteristics of the lot from which a test sample was taken or any similar or identical product unless specifically and expressly noted. Our report includes all of the tests requested by you and the results thereof based upon the information that you provided to us. You have 60 days from date of issuance of this report to notify us of any material error or omission caused by our negligence, provided, however, that such notice shall be in writing and shall specifically address the issue you wish to raise. A failure to raise such issue within the prescribed time shall constitute your unqualified acceptance of the completeness of this report, the tests conducted and the correctness of the report contents. Unless specific mention, the uncertainty of measurement has been explicitly taken into account to declare the compliance or non-compliance to the specification. The report must not be used by the client to claim product certification, approval, or endorsement by TAF or any government agencies.

Table of Contents

Release Control Record	4
1 Certificate of Conformity	5
2 Summary of Test Results	6
2.1 Measurement Uncertainty	6
2.2 Modification Record	6
3 General Information	7
3.1 General Description of EUT	7
3.2 Description of Test Modes	9
3.2.1 Test Mode Applicability and Tested Channel Detail	11
3.3 Duty Cycle of Test Signal	13
3.4 Description of Support Units	14
3.4.1 Configuration of System under Test	14
3.5 General Description of Applied Standard	15
4 Test Types and Results	16
4.1 Radiated Emission and Bandedge Measurement	16
4.1.1 Limits of Radiated Emission and Bandedge Measurement	16
4.1.2 Test Instruments	17
4.1.3 Test Procedure	19
4.1.4 Deviation from Test Standard	19
4.1.5 Test Setup	20
4.1.6 EUT Operating Condition	21
4.1.7 Test Results	22
4.2 Conducted Emission Measurement	61
4.2.1 Limits of Conducted Emission Measurement	61
4.2.2 Test Instruments	61
4.2.3 Test Procedure	62
4.2.4 Deviation from Test Standard	62
4.2.5 Test Setup	62
4.2.6 EUT Operating Condition	62
4.2.7 Test Results	63
4.3 Transmit Power Measurement	65
4.3.1 Limits of Transmit Power Measurement	65
4.3.2 Test Setup	65
4.3.3 Test Instruments	65
4.3.4 Test Procedure	66
4.3.5 Deviation from Test Standard	66
4.3.6 EUT Operating Condition	66
4.3.7 Test Result	67
4.4 Occupied Bandwidth Measurement	74
4.4.1 Test Setup	74
4.4.2 Test Instruments	74
4.4.3 Test Procedure	74
4.4.4 Test Results	75
4.5 Peak Power Spectral Density Measurement	80
4.5.1 Limits of Peak Power Spectral Density Measurement	80
4.5.2 Test Setup	80
4.5.3 Test Instruments	80
4.5.4 Test Procedure	80
4.5.5 Deviation from Test Standard	81
4.5.6 EUT Operating Condition	81
4.5.7 Test Results	82
4.6 Frequency Stability Measurement	87
4.6.1 Limits of Frequency Stability Measurement	87

4.6.2	Test Setup.....	87
4.6.3	Test Instruments	87
4.6.4	Test Procedure	87
4.6.5	Deviation from Test Standard	87
4.6.6	EUT Operating Condition	87
4.6.7	Test Results	88
4.7	6dB Bandwidth Measurement	89
4.7.1	Limits of 6dB Bandwidth Measurement.....	89
4.7.2	Test Setup.....	89
4.7.3	Test Instruments	89
4.7.4	Test Procedure	89
4.7.5	Deviation from Test Standard	89
4.7.6	EUT Operating Condition	89
4.7.7	Test Results	90
5	Pictures of Test Arrangements.....	92
	Annex A- Radiated Out of Band Emission (OOBE) Measurement (For U-NII-3 band)	93
	Appendix – Information on the Testing Laboratories	96

Release Control Record

Issue No.	Description	Date Issued
RF170918E11-1	Original release.	Nov. 23, 2017

1 Certificate of Conformity

Product: 11ac+BT Combo Module

Brand: Epson

Test Model: J26H005

Sample Status: ENGINEERING SAMPLE

Applicant: Seiko Epson Corporation

Test Date: Sep. 27 to Oct. 06, 2017

Standard: 47 CFR FCC Part 15, Subpart E (Section 15.407)
ANSI C63.10: 2013

The above equipment has been tested by **Bureau Veritas Consumer Products Services (H.K.) Ltd., Taoyuan Branch**, and found compliance with the requirement of the above standards. The test record, data evaluation & Equipment Under Test (EUT) configurations represented herein are true and accurate accounts of the measurements of the sample's EMC characteristics under the conditions specified in this report.

Prepared by : Wendy Wu , **Date:** Nov. 23, 2017
Wendy Wu / Specialist

Approved by : May Chen , **Date:** Nov. 23, 2017
May Chen / Manager

2 Summary of Test Results

47 CFR FCC Part 15, Subpart E (Section 15.407)			
FCC Clause	Test Item	Result	Remarks
15.407(b)(6)	AC Power Conducted Emissions	Pass	Meet the requirement of limit. Minimum passing margin is -8.95dB at 16.46484MHz.
15.407(b) (1/2/3/4(i/ii)/6)	Radiated Emissions & Band Edge Measurement*	Pass	Meet the requirement of limit. Minimum passing margin is -0.1dB at 5150.00MHz, 5350.00MHz, 5470.00MHz, 5725.00MHz.
15.407(a)(1/2/3)	Max Average Transmit Power	Pass	Meet the requirement of limit.
---	Occupied Bandwidth Measurement	-	Reference only.
15.407(a)(1/2/3)	Peak Power Spectral Density	Pass	Meet the requirement of limit.
15.407(e)	6dB bandwidth	Pass	Meet the requirement of limit. (U-NII-3 Band only)
15.407(g)	Frequency Stability	Pass	Meet the requirement of limit.
15.203	Antenna Requirement	Pass	No antenna connector is used.

*For U-NII-3 band compliance with rule part 15.407(b)(4)(i), the OOB test plots were recorded in Annex A.

2.1 Measurement Uncertainty

Where relevant, the following measurement uncertainty levels have been estimated for tests performed on the EUT as specified in CISPR 16-4-2:

Measurement	Frequency	Expanded Uncertainty (k=2) (\pm)
Conducted Emissions at mains ports	150kHz ~ 30MHz	1.84 dB
Radiated Emissions up to 1 GHz	30MHz ~ 1GHz	5.32 dB
Radiated Emissions above 1 GHz	1GHz ~ 6GHz	5.14 dB
	6GHz ~ 18GHz	5.04 dB
	18GHz ~ 40GHz	5.25 dB

2.2 Modification Record

There were no modifications required for compliance.

3 General Information

3.1 General Description of EUT

Product	11ac+BT Combo Module
Brand	Epson
Test Model	J26H005
Status of EUT	ENGINEERING SAMPLE
Power Supply Rating	3.3Vdc from host equipment
Modulation Type	CCK, DQPSK, DBPSK for DSSS 64QAM, 16QAM, QPSK, BPSK for OFDM 256QAM for OFDM in 11ac mode only
Modulation Technology	DSSS, OFDM
Transfer Rate	802.11b: up to 11Mbps 802.11a/g: up to 54Mbps 802.11n: up to 150Mbps 802.11ac: up to 433.3Mbps
Operating Frequency	2.4GHz: 2.412 ~ 2.462GHz 5GHz: 5.18 ~ 5.24GHz, 5.26 ~ 5.32GHz, 5.50 ~ 5.70GHz, 5.745 ~ 5.825GHz
Number of Channel	2.4GHz: 802.11b, 802.11g, 802.11n (HT20): 11 5GHz: 802.11a, 802.11n (HT20), 802.11ac (VHT20): 24 802.11n (HT40), 802.11ac (VHT40): 11 802.11ac (VHT80): 5
Output Power	2.4GHz: 316.957mW 5GHz: 5.18 ~ 5.24GHz: 102.802mW 5.26 ~ 5.32GHz: 97.949mW 5.50 ~ 5.70GHz: 92.683mW 5.745 ~ 5.825GHz: 120.504mW
Antenna Type	Refer to Note
Antenna Connector	Refer to Note
Accessory Device	NA
Data Cable Supplied	NA

Note:

1. There are WLAN, BT technology used for the EUT.
2. Simultaneously transmission condition.

Condition	Technology		
1	WLAN 2.4GHz	WLAN 5GHz	Bluetooth

Note: The emission of the simultaneous operation has been evaluated and no non-compliance was found.

3. The antennas provided to the EUT, please refer to the following table:

Ant No.	Antenna Gain (dBi)	Frequency rang (GHz)	Antenna type	Connector type
1	3.09	2.4~2.4835	PCB Printed	none
	5.94	5.15~5.25		
	5.94	5.25~5.35		
	6.29	5.47~5.725		
	7.12	5.725~5.85		
2	2.53	2.4~2.4835	PCB Printed	none
	3.94	5.15~5.25		
	3.94	5.25~5.35		
	5.10	5.47~5.725		
	5.23	5.725~5.85		

Note: This report chose the max. Antenna gain to do final test.

4. The EUT incorporates a SISO function.

2.4GHz Band			
MODULATION MODE	DATA RATE (MCS)	TX & RX CONFIGURATION	
802.11b	1 ~ 11Mbps	1TX diversity	1RX diversity
802.11g	6 ~ 54Mbps	1TX diversity	1RX diversity
802.11n (HT20)	MCS 0~7	1TX diversity	1RX diversity
5GHz Band			
MODULATION MODE	DATA RATE (MCS)	TX & RX CONFIGURATION	
802.11a	6 ~ 54Mbps	1TX diversity	1RX diversity
802.11n (HT20)	MCS 0~7	1TX diversity	1RX diversity
802.11n (HT40)	MCS 0~7	1TX diversity	1RX diversity
802.11ac (VHT20)	MCS0~8 Nss=1	1TX diversity	1RX diversity
802.11ac (VHT40)	MCS0~9 Nss=1	1TX diversity	1RX diversity
802.11ac (VHT80)	MCS0~9 Nss=1	1TX diversity	1RX diversity

5. The above EUT information is declared by manufacturer and for more detailed features description, please refer to the manufacturer's specifications or user's manual.

3.2 Description of Test Modes

FOR 5180 ~ 5240MHz

4 channels are provided for 802.11a, 802.11n (HT20), 802.11ac (VHT20):

Channel	Frequency	Channel	Frequency
36	5180 MHz	44	5220 MHz
40	5200 MHz	48	5240 MHz

2 channels are provided for 802.11n (HT40), 802.11ac (VHT40):

Channel	Frequency	Channel	Frequency
38	5190 MHz	46	5230 MHz

1 channel is provided for 802.11ac (VHT80):

Channel	Frequency
42	5210MHz

FOR 5260 ~ 5320MHz

4 channels are provided for 802.11a, 802.11n (HT20), 802.11ac (VHT20):

Channel	Frequency	Channel	Frequency
52	5260 MHz	60	5300 MHz
56	5280 MHz	64	5320 MHz

2 channels are provided for 802.11n (HT40), 802.11ac (VHT40):

Channel	Frequency	Channel	Frequency
54	5270 MHz	62	5310 MHz

1 channel is provided for 802.11ac (VHT80):

Channel	Frequency
58	5290MHz

FOR 5500 ~ 5700MHz

11 channels are provided for 802.11a, 802.11n (HT20), 802.11ac (VHT20):

Channel	Frequency	Channel	Frequency
100	5500 MHz	124	5620 MHz
104	5520 MHz	128	5640 MHz
108	5540 MHz	132	5660 MHz
112	5560 MHz	136	5680 MHz
116	5580 MHz	140	5700 MHz
120	5600 MHz		

5 channels are provided for 802.11n (HT40), 802.11ac (VHT40):

Channel	Frequency	Channel	Frequency
102	5510 MHz	126	5630 MHz
110	5550 MHz	134	5670 MHz
118	5590 MHz		

2 channels are provided for 802.11ac (VHT80):

Channel	Frequency	Channel	Frequency
106	5530 MHz	122	5610 MHz

FOR 5745 ~ 5825MHz:

5 channels are provided for 802.11a, 802.11n (HT20), 802.11ac (VHT20):

Channel	Frequency	Channel	Frequency
149	5745 MHz	161	5805 MHz
153	5765 MHz	165	5825 MHz
157	5785 MHz		

2 channels are provided for 802.11n (HT40), 802.11ac (VHT40):

Channel	Frequency	Channel	Frequency
151	5755 MHz	159	5795 MHz

1 channel is provided for 802.11ac (VHT80):

Channel	Frequency
155	5775 MHz

3.2.1 Test Mode Applicability and Tested Channel Detail

EUT Configure Mode	Applicable To				Description
	RE \geq 1G	RE $<$ 1G	PLC	APCM	
-	√	√	√	√	-

Where **RE \geq 1G**: Radiated Emission above 1GHz **RE $<$ 1G**: Radiated Emission below 1GHz
PLC: Power Line Conducted Emission **APCM**: Antenna Port Conducted Measurement

NOTE: The EUT had been pre-tested on the positioned of each 3 axis. The worst case was found when positioned on **Z-plane**.

Radiated Emission Test (Above 1GHz):

- Pre-Scan has been conducted to determine the worst-case mode from all possible combinations between available modulations, data rates and antenna ports (if EUT with antenna diversity architecture).
- Following channel(s) was (were) selected for the final test as listed below.

Mode	FREQ. Band (MHz)	Available Channel	Tested Channel	Modulation Technology	Modulation Type	Data Rate (Mbps)
802.11a	5180-5240	36 to 48	36, 40, 48	OFDM	BPSK	6
802.11n (HT20)		36 to 48	36, 40, 48	OFDM	BPSK	6.5
802.11n (HT40)		38 to 46	38, 46	OFDM	BPSK	13.5
802.11ac (VHT80)		42	42	OFDM	BPSK	29.3
802.11a	5260-5320	52 to 64	52, 60, 64	OFDM	BPSK	6
802.11n (HT20)		52 to 64	52, 60, 64	OFDM	BPSK	6.5
802.11n (HT40)		54 to 62	54, 62	OFDM	BPSK	13.5
802.11ac (VHT80)		58	58	OFDM	BPSK	29.3
802.11a	5500-5700	100 to 140	100, 116, 140	OFDM	BPSK	6
802.11n (HT20)		100 to 140	100, 116, 140	OFDM	BPSK	6.5
802.11n (HT40)		102 to 134	102, 110, 134	OFDM	BPSK	13.5
802.11ac (VHT80)		106 to 122	106, 122	OFDM	BPSK	29.3
802.11a	5745-5825	149 to 165	149, 157, 165	OFDM	BPSK	6
802.11n (HT20)		149 to 165	149, 157, 165	OFDM	BPSK	6.5
802.11n (HT40)		151 to 159	151, 159	OFDM	BPSK	13.5
802.11ac (VHT80)		155	155	OFDM	BPSK	29.3

Radiated Emission Test (Below 1GHz):

- Pre-Scan has been conducted to determine the worst-case mode from all possible combinations between available modulations, data rates and antenna ports (if EUT with antenna diversity architecture).
- Following channel(s) was (were) selected for the final test as listed below.

Mode	FREQ. Band (MHz)	Available Channel	Tested Channel	Modulation Technology	Modulation Type	Data Rate (Mbps)
802.11a	5180-5240 5745-5825 5500-5700 5745-5825	36 to 48 52 to 64 100 to 140 149 to 165	149	OFDM	BPSK	6

Power Line Conducted Emission Test:

- Pre-Scan has been conducted to determine the worst-case mode from all possible combinations between available modulations, data rates and antenna ports (if EUT with antenna diversity architecture).
- Following channel(s) was (were) selected for the final test as listed below.

Mode	FREQ. Band (MHz)	Available Channel	Tested Channel	Modulation Technology	Modulation Type	Data Rate (Mbps)
802.11a	5180-5240 5745-5825 5500-5700 5745-5825	149 to 165	149	OFDM	BPSK	6

Antenna Port Conducted Measurement:

- This item includes all test value of each mode, but only includes spectrum plot of worst value of each mode.
- Pre-Scan has been conducted to determine the worst-case mode from all possible combinations between available modulations, data rates and antenna ports (if EUT with antenna diversity architecture).
- Following channel(s) was (were) selected for the final test as listed below.

Mode	FREQ. Band (MHz)	Available Channel	Tested Channel	Modulation Technology	Modulation Type	Data Rate (Mbps)
802.11a	5180-5240	36 to 48	36, 40, 48	OFDM	BPSK	6
802.11n (HT20)		36 to 48	36, 40, 48	OFDM	BPSK	6.5
802.11n (HT40)		38 to 46	38, 46	OFDM	BPSK	13.5
802.11ac (VHT80)		42	42	OFDM	BPSK	29.3
802.11a	5260-5320	52 to 64	52, 60, 64	OFDM	BPSK	6
802.11n (HT20)		52 to 64	52, 60, 64	OFDM	BPSK	6.5
802.11n (HT40)		54 to 62	54, 62	OFDM	BPSK	13.5
802.11ac (VHT80)		58	58	OFDM	BPSK	29.3
802.11a	5500-5700	100 to 140	100, 116, 140	OFDM	BPSK	6
802.11n (HT20)		100 to 140	100, 116, 140	OFDM	BPSK	6.5
802.11n (HT40)		102 to 134	102, 110, 134	OFDM	BPSK	13.5
802.11ac (VHT80)		106 to 122	106, 122	OFDM	BPSK	29.3
802.11a	5745-5825	149 to 165	149, 157, 165	OFDM	BPSK	6
802.11n (HT20)		149 to 165	149, 157, 165	OFDM	BPSK	6.5
802.11n (HT40)		151 to 159	151, 159	OFDM	BPSK	13.5
802.11ac (VHT80)		155	155	OFDM	BPSK	29.3

Test Condition:

Applicable To	ENVIRONMENTAL CONDITIONS	INPUT POWER (System)	TESTED BY
RE \geq 1G	23deg. C, 68%RH	120Vac, 60Hz	Weiwei Lo
RE<1G	23deg. C, 68%RH	120Vac, 60Hz	Weiwei Lo
PLC	26deg. C, 74%RH	120Vac, 60Hz	Andy Ho
APCM	25deg. C, 60%RH	120Vac, 60Hz	Anderson Chen

3.3 Duty Cycle of Test Signal

Duty cycle of test signal is 100 %, duty factor is not required.

802.11a

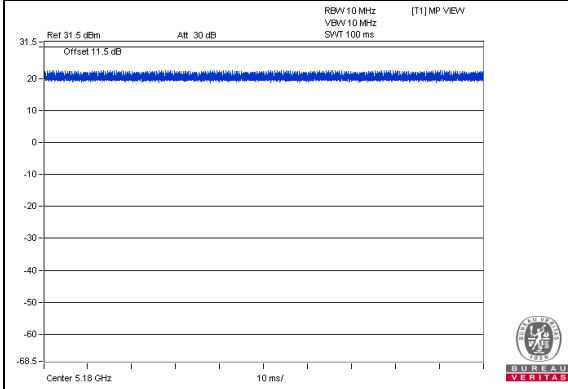

802.11ac (VHT20)

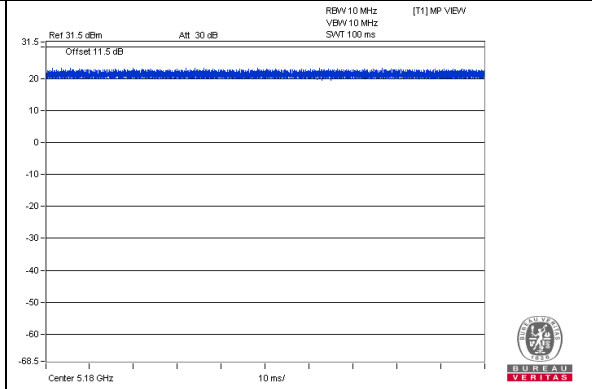

802.11ac (VHT40)

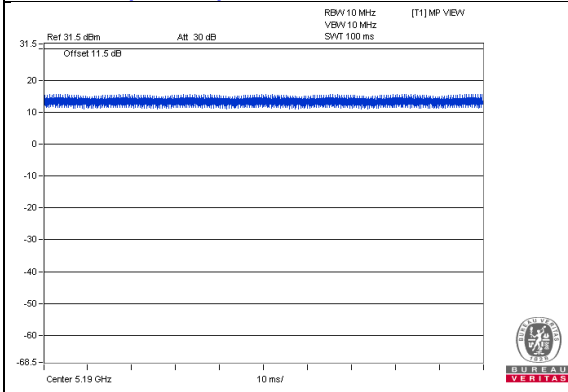

802.11ac (VHT80)

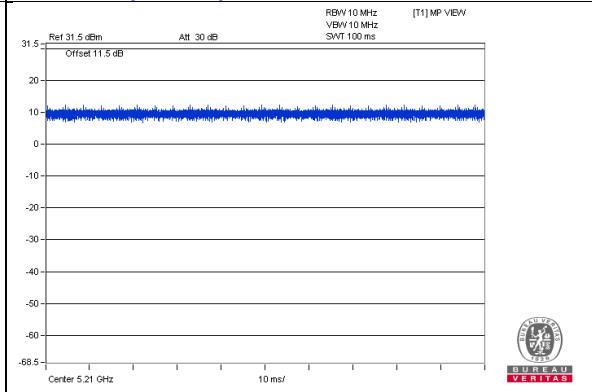

3.4 Description of Support Units

The EUT has been tested as an independent unit together with other necessary accessories or support units. The following support units or accessories were used to form a representative test configuration during the tests.

ID	Product	Brand	Model No.	Serial No.	FCC ID	Remarks
A.	Laptop	DELL	E6420	482T3R1	FCC DoC	Provided by Lab
B.	Test Tool	HON HAI	NA	NA	NA	Supplied by client

Note:

1. All power cords of the above support units are non-shielded (1.8m).

ID	Descriptions	Qty.	Length (m)	Shielding (Yes/No)	Cores (Qty.)	Remarks
1.	Console Cable	1	0.06	No	0	Supplied by client(for RF Setup)

3.4.1 Configuration of System under Test

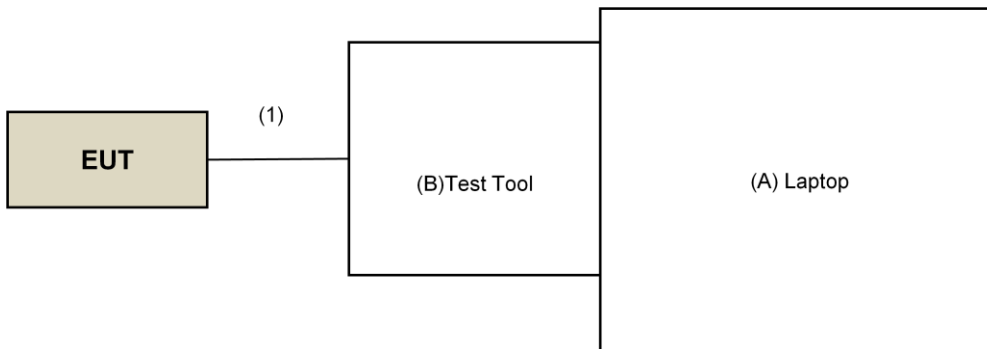

3.5 General Description of Applied Standard

The EUT is a RF Product. According to the specifications of the manufacturer, it must comply with the requirements of the following standards:

FCC Part 15, Subpart E (15.407)
KDB 789033 D02 General UNII Test Procedure New Rules v01r04
ANSI C63.10-2013

All test items have been performed and recorded as per the above standards.

NOTE: The EUT has been verified to comply with the requirements of FCC Part 15, Subpart B, Class B (DoC). The test report has been issued separately.

4 Test Types and Results

4.1 Radiated Emission and Bandedge Measurement

4.1.1 Limits of Radiated Emission and Bandedge Measurement

Radiated emissions which fall in the restricted bands must comply with the radiated emission limits specified as below table.

Frequencies (MHz)	Field Strength (microvolts/meter)	Measurement Distance (meters)
0.009 ~ 0.490	2400/F(kHz)	300
0.490 ~ 1.705	24000/F(kHz)	30
1.705 ~ 30.0	30	30
30 ~ 88	100	3
88 ~ 216	150	3
216 ~ 960	200	3
Above 960	500	3

NOTE:

1. The lower limit shall apply at the transition frequencies.
2. Emission level (dBuV/m) = 20 log Emission level (uV/m).
3. For frequencies above 1000MHz, the field strength limits are based on average detector, however, the peak field strength of any emission shall not exceed the maximum permitted average limits, specified above by more than 20dB under any condition of modulation.

Limits of unwanted emission out of the restricted bands

Applicable To		Limit	
789033 D02 General UNII Test Procedure New Rules v01r04		Field Strength at 3m	
		PK:74 (dBuV/m)	AV:54 (dBuV/m)
Frequency Band	Applicable To	EIRP Limit	Equivalent Field Strength at 3m
5150~5250 MHz	15.407(b)(1)	PK:-27 (dBm/MHz)	PK:68.2(dBuV/m)
5250~5350 MHz	15.407(b)(2)		
5470~5725 MHz	15.407(b)(3)		
5725~5850 MHz	<input checked="" type="checkbox"/> 15.407(b)(4)(i)	PK:-27 (dBm/MHz) ^{*1} PK:10 (dBm/MHz) ^{*2} PK:15.6 (dBm/MHz) ^{*3} PK:27 (dBm/MHz) ^{*4}	PK: 68.2(dBuV/m) ^{*1} PK:105.2 (dBuV/m) ^{*2} PK: 110.8(dBuV/m) ^{*3} PK:122.2 (dBuV/m) ^{*4}
	<input type="checkbox"/> 15.407(b)(4)(ii)	Emission limits in section 15.247(d)	
^{*1} beyond 75 MHz or more above of the band edge.		^{*2} below the band edge increasing linearly to 10 dBm/MHz at 25 MHz above.	
^{*3} below the band edge increasing linearly to a level of 15.6 dBm/MHz at 5 MHz above.		^{*4} from 5 MHz above or below the band edge increasing linearly to a level of 27 dBm/MHz at the band edge.	

Note:

The following formula is used to convert the equipment isotropic radiated power (eirp) to field strength:

$$E = \frac{1000000\sqrt{30P}}{3} \mu\text{V/m, where P is the eirp (Watts).}$$

4.1.2 Test Instruments

For below 1GHz test:

DESCRIPTION & MANUFACTURER	MODEL NO.	SERIAL NO.	CALIBRATED DATE	CALIBRATED UNTIL
Test Receiver Agilent	N9038A	MY50010156	July 12, 2017	July 11, 2018
Pre-Amplifier ^(*) EMCI	EMC001340	980142	Jan. 20, 2016	Jan. 19, 2018
Loop Antenna ^(*) Electro-Metrics	EM-6879	264	Dec. 16, 2016	Dec. 15, 2018
RF Cable	NA	LOOPCAB-001 LOOPCAB-002	Jan. 17, 2017	Jan. 16, 2018
Pre-Amplifier Mini-Circuits	ZFL-1000VH2B	AMP-ZFL-05	May 06, 2017	May 05, 2018
Trilog Broadband Antenna SCHWARZBECK	VULB 9168	9168-361	Dec. 29, 2016	Dec. 28, 2017
RF Cable	8D	966-3-1 966-3-2 966-3-3	Apr. 01, 2017	Mar. 31, 2018
Fixed attenuator Mini-Circuits	UNAT-5+	PAD-3m-3-01	Oct. 03, 2017	Oct. 02, 2018
Software	ADT_Radiated_V8.7.08	NA	NA	NA
Antenna Tower & Turn Table Max-Full	MF-7802	MF780208406	NA	NA

Note:

1. The calibration interval of the above test instruments is 12 months and the calibrations are traceable to NML/ROC and NIST/USA.
2. *The calibration interval of the above test instruments is 24 months and the calibrations are traceable to NML/ROC and NIST/USA.
3. The test was performed in 966 Chamber No. 3.
4. Loop antenna was used for all emissions below 30 MHz.
5. The CANADA Site Registration No. is 20331-1
6. Tested Date: Oct. 06, 2017

For other test:

DESCRIPTION & MANUFACTURER	MODEL NO.	SERIAL NO.	CALIBRATED DATE	CALIBRATED UNTIL
Test Receiver Agilent	N9038A	MY50010156	July 12, 2017	July 11, 2018
Horn_Antenna SCHWARZBECK	BBHA9120-D	9120D-406	Dec. 28, 2016	Dec. 27, 2017
Pre-Amplifier EMCI	EMC12630SE	980384	Feb. 02, 2017	Feb. 01, 2018
RF Cable	EMC104-SM-SM-1200 EMC104-SM-SM-2000 EMC104-SM-SM-5000	160922 150317 150322	Feb. 02, 2017 Mar. 29, 2017 Mar. 29, 2017	Feb. 01, 2018 Mar. 28, 2018 Mar. 28, 2018
Spectrum Analyzer Keysight	N9030A	MY54490679	July 25, 2017	July 24, 2018
Pre-Amplifier EMCI	EMC184045SE	980386	Feb. 02, 2017	Feb. 01, 2018
Horn_Antenna SCHWARZBECK	BBHA 9170	BBHA9170608	Dec. 15, 2016	Dec. 14, 2017
RF Cable	SUCOFLEX 102	36432/2 36433/2	Jan. 15, 2017	Jan. 14, 2018
Software	ADT_Radiated_V8.7.08	NA	NA	NA
Antenna Tower & Turn Table Max-Full	MF-7802	MF780208406	NA	NA
Boresight Antenna Fixture	FBA-01	FBA-SIP01	NA	NA
Spectrum Analyzer R&S	FSv40	100964	July 1, 2017	June 30, 2018
Power meter Anritsu	ML2495A	1014008	May 11, 2017	May 10, 2018
Power sensor Anritsu	MA2411B	0917122	May 11, 2017	May 10, 2018
Temperature & Humidity Chamber Giant Force	GTH-150-40-SP-AR	MAA0812-008	Jan. 11, 2017	Jan. 10, 2018
DC Power Supply Topward	6603D	795558	NA	NA
Digital Multimeter FLUKE	87III	73680266	Nov. 10, 2016	Nov. 09, 2017

Note:

1. The calibration interval of the above test instruments is 12 months and the calibrations are traceable to NML/ROC and NIST/USA.
2. The test was performed in 966 Chamber No. 3.
3. The CANADA Site Registration No. is 20331-1
4. Tested Date: Sep. 27 to 30 2017

4.1.3 Test Procedure

For Radiated emission below 30MHz

- a. The EUT was placed on the top of a rotating table 0.8 meters above the ground at a 3 meter chamber room. The table was rotated 360 degrees to determine the position of the highest radiation.
- b. The EUT was set 3 meters away from the interference-receiving antenna, which was mounted on the top of a variable-height antenna tower.
- c. Both X and Y axes of the antenna are set to make the measurement.
- d. For each suspected emission, the EUT was arranged to its worst case and the rotatable table was turned from 0 degrees to 360 degrees to find the maximum reading.
- e. The test-receiver system was set to Quasi-Peak Detect Function and Specified Bandwidth with Maximum Hold Mode.

NOTE:

1. The resolution bandwidth and video bandwidth of test receiver/spectrum analyzer is 9kHz at frequency below 30MHz.

For Radiated emission above 30MHz

- a. The EUT was placed on the top of a rotating table 0.8 meters (for 30MHz ~ 1GHz) / 1.5 meters (for above 1GHz) above the ground at 3 meter chamber room for test. The table was rotated 360 degrees to determine the position of the highest radiation.
- b. The EUT was set 3 meters away from the interference-receiving antenna, which was mounted on the top of a variable-height antenna tower.
- c. The height of antenna is varied from one meter to four meters above the ground to determine the maximum value of the field strength. Both horizontal and vertical polarizations of the antenna are set to make the measurement.
- d. For each suspected emission, the EUT was arranged to its worst case and then the antenna was tuned to heights from 1 meter to 4 meters and the rotatable table was turned from 0 degrees to 360 degrees to find the maximum reading.
- e. The test-receiver system was set to quasi-peak detect function and specified bandwidth with maximum hold mode when the test frequency is below 1 GHz.
- f. The test-receiver system was set to peak and average detect function and specified bandwidth with maximum hold mode when the test frequency is above 1 GHz. If the peak reading value also meets average limit, measurement with the average detector is unnecessary.

Note:

1. The resolution bandwidth and video bandwidth of test receiver/spectrum analyzer is 120kHz for Quasi-peak detection (QP) at frequency below 1GHz.
2. The resolution bandwidth of test receiver/spectrum analyzer is 1 MHz and the video bandwidth is 3 MHz for Peak detection (PK) at frequency above 1GHz.
3. The resolution bandwidth of test receiver/spectrum analyzer is 1MHz and the video bandwidth is $\geq 1/T$ (Duty cycle < 98%) or 10Hz (Duty cycle $\geq 98\%$) for Average detection (AV) at frequency above 1GHz.
4. All modes of operation were investigated and the worst-case emissions are reported.

4.1.4 Deviation from Test Standard

No deviation.

4.1.5 Test Setup

For Radiated emission below 30MHz

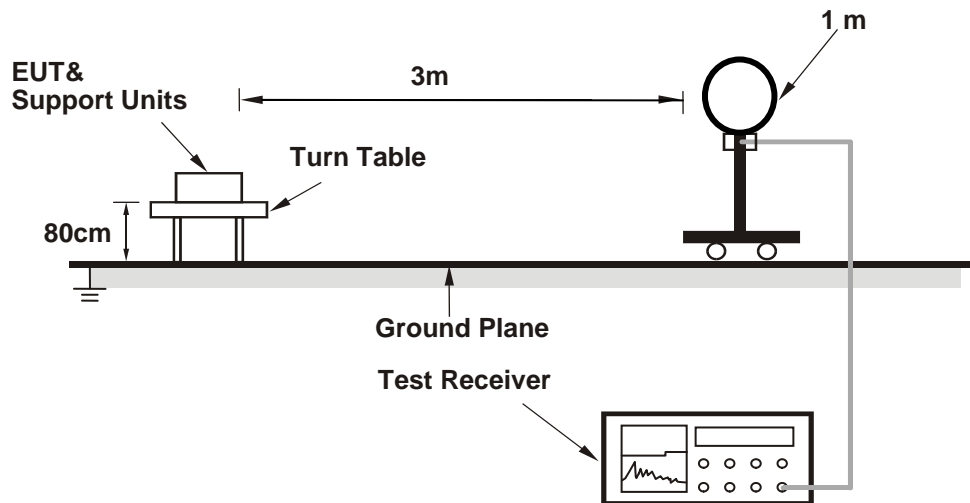

For Radiated emission 30MHz to 1GHz

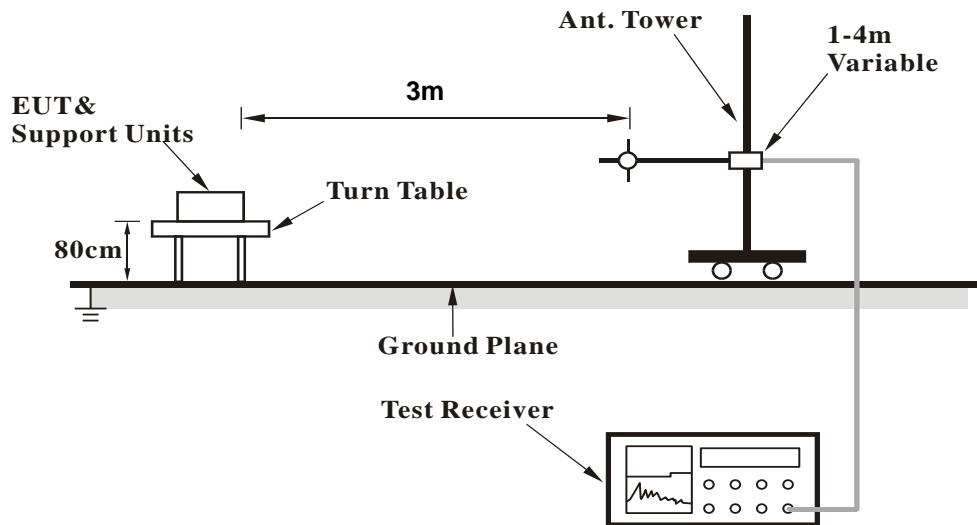

For Radiated emission above 1GHz

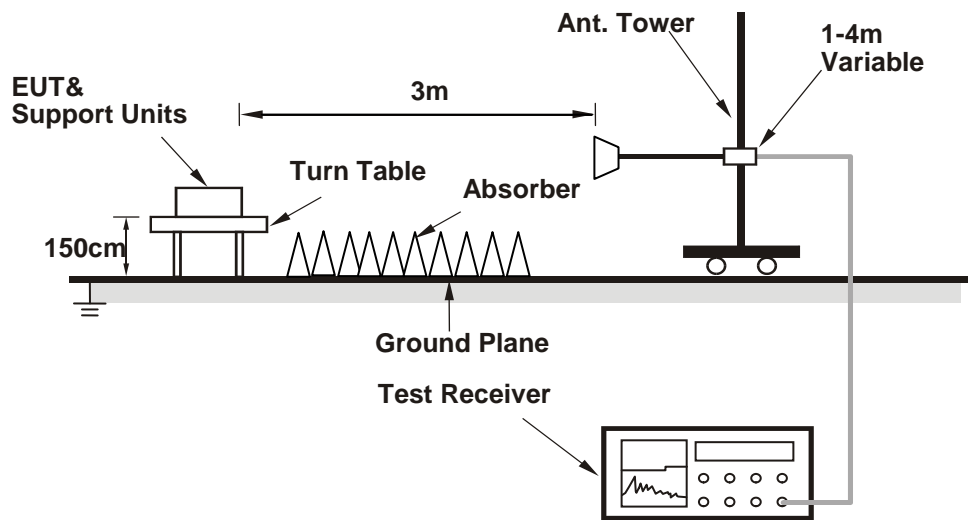

For the actual test configuration, please refer to the attached file (Test Setup Photo).

4.1.6 EUT Operating Condition

- a. Connected the EUT with the Laptop.
- b. Controlling software (MPTool.exe[Ver1.0.0.10]) has been activated to set the EUT on specific status.

4.1.7 Test Results

Above 1GHz Data:

802.11a

CHANNEL	TX Channel 36	DETECTOR FUNCTION	Peak (PK)
FREQUENCY RANGE	1GHz ~ 40GHz		Average (AV)

ANTENNA POLARITY & TEST DISTANCE: HORIZONTAL AT 3 M

NO.	FREQ. (MHz)	EMISSION LEVEL (dBuV/m)	LIMIT (dBuV/m)	MARGIN (dB)	ANTENNA HEIGHT (m)	TABLE ANGLE (Degree)	RAW VALUE (dBuV)	CORRECTION FACTOR (dB/m)
1	5150.00	65.1 PK	74.0	-8.9	3.13 H	155	61.4	3.7
2	5150.00	50.8 AV	54.0	-3.2	3.13 H	155	47.1	3.7
3	*5180.00	108.0 PK			3.13 H	155	104.3	3.7
4	*5180.00	99.9 AV			3.13 H	155	96.2	3.7
5	#10360.00	48.0 PK	74.0	-26.0	1.61 H	122	35.0	13.0
6	#10360.00	34.5 AV	54.0	-19.5	1.61 H	122	21.5	13.0
7	15540.00	55.5 PK	74.0	-18.5	1.82 H	194	42.4	13.1
8	15540.00	43.1 AV	54.0	-10.9	1.82 H	194	30.0	13.1

ANTENNA POLARITY & TEST DISTANCE: VERTICAL AT 3 M

NO.	FREQ. (MHz)	EMISSION LEVEL (dBuV/m)	LIMIT (dBuV/m)	MARGIN (dB)	ANTENNA HEIGHT (m)	TABLE ANGLE (Degree)	RAW VALUE (dBuV)	CORRECTION FACTOR (dB/m)
1	5150.00	67.5 PK	74.0	-6.5	2.04 V	95	63.8	3.7
2	5150.00	53.8 AV	54.0	-0.2	2.04 V	95	50.1	3.7
3	*5180.00	109.4 PK			2.04 V	95	105.7	3.7
4	*5180.00	100.7 AV			2.04 V	95	97.0	3.7
5	#10360.00	49.6 PK	74.0	-24.4	1.31 V	322	36.6	13.0
6	#10360.00	37.8 AV	54.0	-16.2	1.31 V	322	24.8	13.0
7	15540.00	55.5 PK	74.0	-18.5	1.82 V	165	42.4	13.1
8	15540.00	42.4 AV	54.0	-11.6	1.82 V	165	29.3	13.1

REMARKS:

1. Emission Level(dBuV/m) = Raw Value(dBuV) + Correction Factor(dB/m)
2. Correction Factor(dB/m) = Antenna Factor(dB/m) + Cable Factor(dB) – Pre-Amplifier Factor(dB)
3. The other emission levels were very low against the limit.
4. Margin value = Emission Level – Limit value
5. " * ": Fundamental frequency.
6. " # ": The radiated frequency is out of the restricted band.

CHANNEL	TX Channel 40	DETECTOR FUNCTION	Peak (PK)
FREQUENCY RANGE	1GHz ~ 40GHz		Average (AV)

ANTENNA POLARITY & TEST DISTANCE: HORIZONTAL AT 3 M

NO.	FREQ. (MHz)	EMISSION LEVEL (dBuV/m)	LIMIT (dBuV/m)	MARGIN (dB)	ANTENNA HEIGHT (m)	TABLE ANGLE (Degree)	RAW VALUE (dBuV)	CORRECTION FACTOR (dB/m)
1	*5200.00	108.5 PK			3.19 H	150	104.8	3.7
2	*5200.00	101.1 AV			3.19 H	150	97.4	3.7
3	#10400.00	47.9 PK	74.0	-26.1	1.65 H	135	34.9	13.0
4	#10400.00	34.6 AV	54.0	-19.4	1.65 H	135	21.6	13.0
5	15600.00	55.3 PK	74.0	-18.7	1.81 H	184	42.0	13.3
6	15600.00	43.1 AV	54.0	-10.9	1.81 H	184	29.8	13.3

ANTENNA POLARITY & TEST DISTANCE: VERTICAL AT 3 M

NO.	FREQ. (MHz)	EMISSION LEVEL (dBuV/m)	LIMIT (dBuV/m)	MARGIN (dB)	ANTENNA HEIGHT (m)	TABLE ANGLE (Degree)	RAW VALUE (dBuV)	CORRECTION FACTOR (dB/m)
1	*5200.00	110.3 PK			2.02 V	90	106.6	3.7
2	*5200.00	101.4 AV			2.02 V	90	97.7	3.7
3	#10400.00	48.9 PK	74.0	-25.1	1.31 V	309	35.9	13.0
4	#10400.00	37.5 AV	54.0	-16.5	1.31 V	309	24.5	13.0
5	15600.00	55.7 PK	74.0	-18.3	1.89 V	180	42.4	13.3
6	15600.00	43.4 AV	54.0	-10.6	1.89 V	180	30.1	13.3

REMARKS:

1. Emission Level(dBuV/m) = Raw Value(dBuV) + Correction Factor(dB/m)
2. Correction Factor(dB/m) = Antenna Factor(dB/m) + Cable Factor(dB) – Pre-Amplifier Factor(dB)
3. The other emission levels were very low against the limit.
4. Margin value = Emission Level – Limit value
5. " * ": Fundamental frequency.
6. " # ": The radiated frequency is out of the restricted band.

CHANNEL	TX Channel 48	DETECTOR FUNCTION	Peak (PK)
FREQUENCY RANGE	1GHz ~ 40GHz		Average (AV)

ANTENNA POLARITY & TEST DISTANCE: HORIZONTAL AT 3 M

NO.	FREQ. (MHz)	EMISSION LEVEL (dBuV/m)	LIMIT (dBuV/m)	MARGIN (dB)	ANTENNA HEIGHT (m)	TABLE ANGLE (Degree)	RAW VALUE (dBuV)	CORRECTION FACTOR (dB/m)
1	*5240.00	107.4 PK			3.14 H	157	103.6	3.8
2	*5240.00	100.4 AV			3.14 H	157	96.6	3.8
3	5350.00	51.1 PK	74.0	-22.9	3.14 H	157	47.0	4.1
4	5350.00	39.2 AV	54.0	-14.8	3.14 H	157	35.1	4.1
5	#10480.00	47.3 PK	74.0	-26.7	1.64 H	119	34.1	13.2
6	#10480.00	34.1 AV	54.0	-19.9	1.64 H	119	20.9	13.2
7	15720.00	55.3 PK	74.0	-18.7	1.81 H	180	41.7	13.6
8	15720.00	42.9 AV	54.0	-11.1	1.81 H	180	29.3	13.6

ANTENNA POLARITY & TEST DISTANCE: VERTICAL AT 3 M

NO.	FREQ. (MHz)	EMISSION LEVEL (dBuV/m)	LIMIT (dBuV/m)	MARGIN (dB)	ANTENNA HEIGHT (m)	TABLE ANGLE (Degree)	RAW VALUE (dBuV)	CORRECTION FACTOR (dB/m)
1	*5240.00	109.8 PK			2.04 V	94	106.0	3.8
2	*5240.00	100.9 AV			2.04 V	94	97.1	3.8
3	5350.00	51.4 PK	74.0	-22.6	2.04 V	94	47.3	4.1
4	5350.00	39.3 AV	54.0	-14.7	2.04 V	94	35.2	4.1
5	#10480.00	49.8 PK	74.0	-24.2	1.34 V	316	36.6	13.2
6	#10480.00	38.1 AV	54.0	-15.9	1.34 V	316	24.9	13.2
7	15720.00	55.6 PK	74.0	-18.4	1.80 V	176	42.0	13.6
8	15720.00	42.6 AV	54.0	-11.4	1.80 V	176	29.0	13.6

REMARKS:

1. Emission Level(dBuV/m) = Raw Value(dBuV) + Correction Factor(dB/m)
2. Correction Factor(dB/m) = Antenna Factor(dB/m) + Cable Factor(dB) – Pre-Amplifier Factor(dB)
3. The other emission levels were very low against the limit.
4. Margin value = Emission Level – Limit value
5. " * ": Fundamental frequency.
6. " # ": The radiated frequency is out of the restricted band.

CHANNEL	TX Channel 52	DETECTOR FUNCTION	Peak (PK)
FREQUENCY RANGE	1GHz ~ 40GHz		Average (AV)

ANTENNA POLARITY & TEST DISTANCE: HORIZONTAL AT 3 M

NO.	FREQ. (MHz)	EMISSION LEVEL (dBuV/m)	LIMIT (dBuV/m)	MARGIN (dB)	ANTENNA HEIGHT (m)	TABLE ANGLE (Degree)	RAW VALUE (dBuV)	CORRECTION FACTOR (dB/m)
1	5150.00	51.0 PK	74.0	-23.0	3.20 H	135	47.3	3.7
2	5150.00	39.4 AV	54.0	-14.6	3.20 H	135	35.7	3.7
3	*5260.00	109.0 PK			3.20 H	135	105.0	4.0
4	*5260.00	101.4 AV			3.20 H	135	97.4	4.0
5	#10520.00	48.0 PK	74.0	-26.0	1.64 H	140	34.8	13.2
6	#10520.00	34.9 AV	54.0	-19.1	1.64 H	140	21.7	13.2
7	15780.00	55.7 PK	74.0	-18.3	1.86 H	182	42.1	13.6
8	15780.00	43.5 AV	54.0	-10.5	1.86 H	182	29.9	13.6

ANTENNA POLARITY & TEST DISTANCE: VERTICAL AT 3 M

NO.	FREQ. (MHz)	EMISSION LEVEL (dBuV/m)	LIMIT (dBuV/m)	MARGIN (dB)	ANTENNA HEIGHT (m)	TABLE ANGLE (Degree)	RAW VALUE (dBuV)	CORRECTION FACTOR (dB/m)
1	5150.00	51.6 PK	74.0	-22.4	2.16 V	97	47.9	3.7
2	5150.00	39.6 AV	54.0	-14.4	2.16 V	97	35.9	3.7
3	*5260.00	110.6 PK			2.16 V	97	106.6	4.0
4	*5260.00	101.3 AV			2.16 V	97	97.3	4.0
5	#10520.00	49.4 PK	74.0	-24.6	1.34 V	307	36.2	13.2
6	#10520.00	37.7 AV	54.0	-16.3	1.34 V	307	24.5	13.2
7	15780.00	56.1 PK	74.0	-17.9	1.83 V	175	42.5	13.6
8	15780.00	42.9 AV	54.0	-11.1	1.83 V	175	29.3	13.6

REMARKS:

1. Emission Level(dBuV/m) = Raw Value(dBuV) + Correction Factor(dB/m)
2. Correction Factor(dB/m) = Antenna Factor(dB/m) + Cable Factor(dB) – Pre-Amplifier Factor(dB)
3. The other emission levels were very low against the limit.
4. Margin value = Emission Level – Limit value
5. " * ": Fundamental frequency.
6. " # ": The radiated frequency is out of the restricted band.

CHANNEL	TX Channel 60	DETECTOR FUNCTION	Peak (PK)
FREQUENCY RANGE	1GHz ~ 40GHz		Average (AV)

ANTENNA POLARITY & TEST DISTANCE: HORIZONTAL AT 3 M

NO.	FREQ. (MHz)	EMISSION LEVEL (dBuV/m)	LIMIT (dBuV/m)	MARGIN (dB)	ANTENNA HEIGHT (m)	TABLE ANGLE (Degree)	RAW VALUE (dBuV)	CORRECTION FACTOR (dB/m)
1	*5300.00	108.2 PK			3.14 H	151	104.1	4.1
2	*5300.00	100.7 AV			3.14 H	151	96.6	4.1
3	10600.00	47.9 PK	74.0	-26.1	1.70 H	136	34.4	13.5
4	10600.00	34.5 AV	54.0	-19.5	1.70 H	136	21.0	13.5
5	15900.00	55.5 PK	74.0	-18.5	1.80 H	170	42.6	12.9
6	15900.00	43.1 AV	54.0	-10.9	1.80 H	170	30.2	12.9

ANTENNA POLARITY & TEST DISTANCE: VERTICAL AT 3 M

NO.	FREQ. (MHz)	EMISSION LEVEL (dBuV/m)	LIMIT (dBuV/m)	MARGIN (dB)	ANTENNA HEIGHT (m)	TABLE ANGLE (Degree)	RAW VALUE (dBuV)	CORRECTION FACTOR (dB/m)
1	*5300.00	110.7 PK			2.17 V	85	106.6	4.1
2	*5300.00	101.5 AV			2.17 V	85	97.4	4.1
3	10600.00	48.8 PK	74.0	-25.2	1.37 V	312	35.3	13.5
4	10600.00	37.4 AV	54.0	-16.6	1.37 V	312	23.9	13.5
5	15900.00	55.9 PK	74.0	-18.1	1.78 V	188	43.0	12.9
6	15900.00	42.4 AV	54.0	-11.6	1.78 V	188	29.5	12.9

REMARKS:

1. Emission Level(dBuV/m) = Raw Value(dBuV) + Correction Factor(dB/m)
2. Correction Factor(dB/m) = Antenna Factor(dB/m) + Cable Factor(dB) – Pre-Amplifier Factor(dB)
3. The other emission levels were very low against the limit.
4. Margin value = Emission Level – Limit value
5. " * ": Fundamental frequency.

CHANNEL	TX Channel 64	DETECTOR FUNCTION	Peak (PK)
FREQUENCY RANGE	1GHz ~ 40GHz		Average (AV)

ANTENNA POLARITY & TEST DISTANCE: HORIZONTAL AT 3 M

NO.	FREQ. (MHz)	EMISSION LEVEL (dBuV/m)	LIMIT (dBuV/m)	MARGIN (dB)	ANTENNA HEIGHT (m)	TABLE ANGLE (Degree)	RAW VALUE (dBuV)	CORRECTION FACTOR (dB/m)
1	*5320.00	107.6 PK			3.17 H	168	103.5	4.1
2	*5320.00	100.6 AV			3.17 H	168	96.5	4.1
3	5350.00	65.4 PK	74.0	-8.6	3.17 H	168	61.3	4.1
4	5350.00	50.2 AV	54.0	-3.8	3.17 H	168	46.1	4.1
5	10640.00	48.1 PK	74.0	-25.9	1.63 H	123	34.6	13.5
6	10640.00	34.8 AV	54.0	-19.2	1.63 H	123	21.3	13.5
7	15960.00	55.5 PK	74.0	-18.5	1.85 H	185	42.6	12.9
8	15960.00	43.0 AV	54.0	-11.0	1.85 H	185	30.1	12.9

ANTENNA POLARITY & TEST DISTANCE: VERTICAL AT 3 M

NO.	FREQ. (MHz)	EMISSION LEVEL (dBuV/m)	LIMIT (dBuV/m)	MARGIN (dB)	ANTENNA HEIGHT (m)	TABLE ANGLE (Degree)	RAW VALUE (dBuV)	CORRECTION FACTOR (dB/m)
1	*5320.00	108.3 PK			2.00 V	94	104.2	4.1
2	*5320.00	99.6 AV			2.00 V	94	95.5	4.1
3	5350.00	68.2 PK	74.0	-5.8	2.00 V	94	64.1	4.1
4	5350.00	53.9 AV	54.0	-0.1	2.00 V	94	49.8	4.1
5	10640.00	48.6 PK	74.0	-25.4	1.37 V	312	35.1	13.5
6	10640.00	37.2 AV	54.0	-16.8	1.37 V	312	23.7	13.5
7	15960.00	56.4 PK	74.0	-17.6	1.81 V	189	43.5	12.9
8	15960.00	43.0 AV	54.0	-11.0	1.81 V	189	30.1	12.9

REMARKS:

1. Emission Level(dBuV/m) = Raw Value(dBuV) + Correction Factor(dB/m)
2. Correction Factor(dB/m) = Antenna Factor(dB/m) + Cable Factor(dB) – Pre-Amplifier Factor(dB)
3. The other emission levels were very low against the limit.
4. Margin value = Emission Level – Limit value
5. " * ": Fundamental frequency.

CHANNEL	TX Channel 100	DETECTOR FUNCTION	Peak (PK)
FREQUENCY RANGE	1GHz ~ 40GHz		Average (AV)

ANTENNA POLARITY & TEST DISTANCE: HORIZONTAL AT 3 M

NO.	FREQ. (MHz)	EMISSION LEVEL (dBuV/m)	LIMIT (dBuV/m)	MARGIN (dB)	ANTENNA HEIGHT (m)	TABLE ANGLE (Degree)	RAW VALUE (dBuV)	CORRECTION FACTOR (dB/m)
1	#5470.00	65.8 PK	74.0	-8.2	3.20 H	170	61.6	4.2
2	#5470.00	50.4 AV	54.0	-3.6	3.20 H	170	46.2	4.2
3	*5500.00	107.4 PK			3.20 H	170	103.2	4.2
4	*5500.00	100.3 AV			3.20 H	170	96.1	4.2
5	11000.00	47.6 PK	74.0	-26.4	1.71 H	130	33.5	14.1
6	11000.00	34.5 AV	54.0	-19.5	1.71 H	130	20.4	14.1
7	#16500.00	55.1 PK	74.0	-18.9	1.84 H	175	40.6	14.5
8	#16500.00	42.7 AV	54.0	-11.3	1.84 H	175	28.2	14.5

ANTENNA POLARITY & TEST DISTANCE: VERTICAL AT 3 M

NO.	FREQ. (MHz)	EMISSION LEVEL (dBuV/m)	LIMIT (dBuV/m)	MARGIN (dB)	ANTENNA HEIGHT (m)	TABLE ANGLE (Degree)	RAW VALUE (dBuV)	CORRECTION FACTOR (dB/m)
1	#5470.00	69.1 PK	74.0	-4.9	2.06 V	100	64.9	4.2
2	#5470.00	53.9 AV	54.0	-0.1	2.06 V	100	49.7	4.2
3	*5500.00	110.0 PK			2.06 V	100	105.8	4.2
4	*5500.00	100.8 AV			2.06 V	100	96.6	4.2
5	11000.00	49.9 PK	74.0	-24.1	1.29 V	320	35.8	14.1
6	11000.00	37.9 AV	54.0	-16.1	1.29 V	320	23.8	14.1
7	#16500.00	55.8 PK	74.0	-18.2	1.79 V	170	41.3	14.5
8	#16500.00	42.8 AV	54.0	-11.2	1.79 V	170	28.3	14.5

REMARKS:

1. Emission Level(dBuV/m) = Raw Value(dBuV) + Correction Factor(dB/m)
2. Correction Factor(dB/m) = Antenna Factor(dB/m) + Cable Factor(dB) – Pre-Amplifier Factor(dB)
3. The other emission levels were very low against the limit.
4. Margin value = Emission Level – Limit value
5. " * ": Fundamental frequency.
6. " # ": The radiated frequency is out of the restricted band.

CHANNEL	TX Channel 116	DETECTOR FUNCTION	Peak (PK)
FREQUENCY RANGE	1GHz ~ 40GHz		Average (AV)

ANTENNA POLARITY & TEST DISTANCE: HORIZONTAL AT 3 M

NO.	FREQ. (MHz)	EMISSION LEVEL (dBuV/m)	LIMIT (dBuV/m)	MARGIN (dB)	ANTENNA HEIGHT (m)	TABLE ANGLE (Degree)	RAW VALUE (dBuV)	CORRECTION FACTOR (dB/m)
1	*5580.00	108.0 PK			3.09 H	164	103.8	4.2
2	*5580.00	100.7 AV			3.09 H	164	96.5	4.2
3	11160.00	47.8 PK	74.0	-26.2	1.61 H	140	34.1	13.7
4	11160.00	34.7 AV	54.0	-19.3	1.61 H	140	21.0	13.7
5	#16740.00	55.4 PK	74.0	-18.6	1.86 H	186	39.7	15.7
6	#16740.00	42.9 AV	54.0	-11.1	1.86 H	186	27.2	15.7

ANTENNA POLARITY & TEST DISTANCE: VERTICAL AT 3 M

NO.	FREQ. (MHz)	EMISSION LEVEL (dBuV/m)	LIMIT (dBuV/m)	MARGIN (dB)	ANTENNA HEIGHT (m)	TABLE ANGLE (Degree)	RAW VALUE (dBuV)	CORRECTION FACTOR (dB/m)
1	*5580.00	110.3 PK			2.10 V	89	106.1	4.2
2	*5580.00	101.5 AV			2.10 V	89	97.3	4.2
3	11160.00	49.9 PK	74.0	-24.1	1.38 V	308	36.2	13.7
4	11160.00	38.0 AV	54.0	-16.0	1.38 V	308	24.3	13.7
5	#16740.00	56.5 PK	74.0	-17.5	1.83 V	177	40.8	15.7
6	#16740.00	43.1 AV	54.0	-10.9	1.83 V	177	27.4	15.7

REMARKS:

1. Emission Level(dBuV/m) = Raw Value(dBuV) + Correction Factor(dB/m)
2. Correction Factor(dB/m) = Antenna Factor(dB/m) + Cable Factor(dB) – Pre-Amplifier Factor(dB)
3. The other emission levels were very low against the limit.
4. Margin value = Emission Level – Limit value
5. " * ": Fundamental frequency.
6. " # ": The radiated frequency is out of the restricted band.

CHANNEL	TX Channel 140	DETECTOR FUNCTION	Peak (PK)
FREQUENCY RANGE	1GHz ~ 40GHz		Average (AV)

ANTENNA POLARITY & TEST DISTANCE: HORIZONTAL AT 3 M

NO.	FREQ. (MHz)	EMISSION LEVEL (dBuV/m)	LIMIT (dBuV/m)	MARGIN (dB)	ANTENNA HEIGHT (m)	TABLE ANGLE (Degree)	RAW VALUE (dBuV)	CORRECTION FACTOR (dB/m)
1	*5700.00	108.0 PK			3.09 H	145	103.5	4.5
2	*5700.00	100.2 AV			3.09 H	145	95.7	4.5
3	#5725.00	65.2 PK	74.0	-8.8	3.09 H	145	60.8	4.4
4	#5725.00	50.6 AV	54.0	-3.4	3.09 H	145	46.2	4.4
5	11400.00	47.4 PK	74.0	-26.6	1.64 H	125	33.8	13.6
6	11400.00	34.3 AV	54.0	-19.7	1.64 H	125	20.7	13.6
7	#17100.00	54.9 PK	74.0	-19.1	1.80 H	179	37.5	17.4
8	#17100.00	42.6 AV	54.0	-11.4	1.80 H	179	25.2	17.4

ANTENNA POLARITY & TEST DISTANCE: VERTICAL AT 3 M

NO.	FREQ. (MHz)	EMISSION LEVEL (dBuV/m)	LIMIT (dBuV/m)	MARGIN (dB)	ANTENNA HEIGHT (m)	TABLE ANGLE (Degree)	RAW VALUE (dBuV)	CORRECTION FACTOR (dB/m)
1	*5700.00	108.8 PK			2.06 V	99	104.3	4.5
2	*5700.00	99.9 AV			2.06 V	99	95.4	4.5
3	#5725.00	69.8 PK	74.0	-4.2	2.06 V	99	65.4	4.4
4	#5725.00	53.9 AV	54.0	-0.1	2.06 V	99	49.5	4.4
5	11400.00	49.4 PK	74.0	-24.6	1.32 V	319	35.8	13.6
6	11400.00	37.7 AV	54.0	-16.3	1.32 V	319	24.1	13.6
7	#17100.00	56.9 PK	74.0	-17.1	1.83 V	187	39.5	17.4
8	#17100.00	43.4 AV	54.0	-10.6	1.83 V	187	26.0	17.4

REMARKS:

1. Emission Level(dBuV/m) = Raw Value(dBuV) + Correction Factor(dB/m)
2. Correction Factor(dB/m) = Antenna Factor(dB/m) + Cable Factor(dB) – Pre-Amplifier Factor(dB)
3. The other emission levels were very low against the limit.
4. Margin value = Emission Level – Limit value
5. " * ": Fundamental frequency.
6. " # ": The radiated frequency is out of the restricted band.

CHANNEL	TX Channel 149	DETECTOR FUNCTION	Peak (PK)
FREQUENCY RANGE	1GHz ~ 40GHz		Average (AV)

ANTENNA POLARITY & TEST DISTANCE: HORIZONTAL AT 3 M

NO.	FREQ. (MHz)	EMISSION LEVEL (dBuV/m)	LIMIT (dBuV/m)	MARGIN (dB)	ANTENNA HEIGHT (m)	TABLE ANGLE (Degree)	RAW VALUE (dBuV)	CORRECTION FACTOR (dB/m)
1	#5648.72	53.2 PK	68.2	-15.0	3.09 H	124	48.8	4.4
2	*5745.00	108.7 PK			3.09 H	124	104.3	4.4
3	*5745.00	100.9 AV			3.09 H	124	96.5	4.4
4	#6004.84	52.6 PK	68.2	-15.6	3.09 H	124	47.8	4.8
5	11490.00	50.8 PK	74.0	-23.2	1.99 H	193	37.3	13.5
6	11490.00	39.7 AV	54.0	-14.3	1.99 H	193	26.2	13.5
7	#17235.00	50.2 PK	74.0	-23.8	1.65 H	267	32.9	17.3
8	#17235.00	39.2 AV	54.0	-14.8	1.65 H	267	21.9	17.3

ANTENNA POLARITY & TEST DISTANCE: VERTICAL AT 3 M

NO.	FREQ. (MHz)	EMISSION LEVEL (dBuV/m)	LIMIT (dBuV/m)	MARGIN (dB)	ANTENNA HEIGHT (m)	TABLE ANGLE (Degree)	RAW VALUE (dBuV)	CORRECTION FACTOR (dB/m)
1	#5622.63	57.3 PK	68.2	-10.9	2.02 V	92	52.9	4.4
2	*5745.00	112.4 PK			2.02 V	92	108.0	4.4
3	*5745.00	105.0 AV			2.02 V	92	100.6	4.4
4	#5969.40	58.4 PK	68.2	-9.8	2.02 V	92	53.7	4.7
5	11490.00	55.8 PK	74.0	-18.2	2.11 V	177	42.3	13.5
6	11490.00	42.4 AV	54.0	-11.6	2.11 V	177	28.9	13.5
7	#17235.00	53.3 PK	74.0	-20.7	2.29 V	158	36.0	17.3
8	#17235.00	40.6 AV	54.0	-13.4	2.29 V	158	23.3	17.3

REMARKS:

- Emission Level(dBuV/m) = Raw Value(dBuV) + Correction Factor(dB/m)
- Correction Factor(dB/m) = Antenna Factor(dB/m) + Cable Factor(dB) – Pre-Amplifier Factor(dB)
- The other emission levels were very low against the limit.
- Margin value = Emission Level – Limit value
- " * ": Fundamental frequency.
- " # ": The radiated frequency is out of the restricted band.

CHANNEL	TX Channel 157	DETECTOR FUNCTION	Peak (PK)
FREQUENCY RANGE	1GHz ~ 40GHz		Average (AV)

ANTENNA POLARITY & TEST DISTANCE: HORIZONTAL AT 3 M

NO.	FREQ. (MHz)	EMISSION LEVEL (dBuV/m)	LIMIT (dBuV/m)	MARGIN (dB)	ANTENNA HEIGHT (m)	TABLE ANGLE (Degree)	RAW VALUE (dBuV)	CORRECTION FACTOR (dB/m)
1	#5629.69	52.5 PK	68.2	-15.7	3.10 H	121	48.1	4.4
2	*5785.00	108.4 PK			3.10 H	121	104.0	4.4
3	*5785.00	100.9 AV			3.10 H	121	96.5	4.4
4	#5954.53	53.2 PK	68.2	-15.0	3.10 H	121	48.5	4.7
5	11570.00	50.3 PK	74.0	-23.7	1.98 H	191	36.8	13.5
6	11570.00	39.4 AV	54.0	-14.6	1.98 H	191	25.9	13.5
7	#17355.00	50.0 PK	74.0	-24.0	1.69 H	278	32.0	18.0
8	#17355.00	39.1 AV	54.0	-14.9	1.69 H	278	21.1	18.0

ANTENNA POLARITY & TEST DISTANCE: VERTICAL AT 3 M

NO.	FREQ. (MHz)	EMISSION LEVEL (dBuV/m)	LIMIT (dBuV/m)	MARGIN (dB)	ANTENNA HEIGHT (m)	TABLE ANGLE (Degree)	RAW VALUE (dBuV)	CORRECTION FACTOR (dB/m)
1	#5631.72	58.3 PK	68.2	-9.9	1.96 V	92	53.9	4.4
2	*5785.00	112.0 PK			1.96 V	92	107.6	4.4
3	*5785.00	104.7 AV			1.96 V	92	100.3	4.4
4	#5996.68	57.7 PK	68.2	-10.5	1.96 V	92	53.0	4.7
5	11570.00	55.5 PK	74.0	-18.5	2.07 V	170	42.0	13.5
6	11570.00	42.4 AV	54.0	-11.6	2.07 V	170	28.9	13.5
7	#17355.00	53.5 PK	74.0	-20.5	2.27 V	147	35.5	18.0
8	#17355.00	41.1 AV	54.0	-12.9	2.27 V	147	23.1	18.0

REMARKS:

1. Emission Level(dBuV/m) = Raw Value(dBuV) + Correction Factor(dB/m)
2. Correction Factor(dB/m) = Antenna Factor(dB/m) + Cable Factor(dB) – Pre-Amplifier Factor(dB)
3. The other emission levels were very low against the limit.
4. Margin value = Emission Level – Limit value
5. " * ": Fundamental frequency.
6. " # ": The radiated frequency is out of the restricted band.

CHANNEL	TX Channel 165	DETECTOR FUNCTION	Peak (PK)
FREQUENCY RANGE	1GHz ~ 40GHz		Average (AV)

ANTENNA POLARITY & TEST DISTANCE: HORIZONTAL AT 3 M

NO.	FREQ. (MHz)	EMISSION LEVEL (dBuV/m)	LIMIT (dBuV/m)	MARGIN (dB)	ANTENNA HEIGHT (m)	TABLE ANGLE (Degree)	RAW VALUE (dBuV)	CORRECTION FACTOR (dB/m)
1	#5572.52	52.6 PK	68.2	-15.6	3.03 H	122	48.4	4.2
2	*5825.00	108.1 PK			3.03 H	122	103.7	4.4
3	*5825.00	100.6 AV			3.03 H	122	96.2	4.4
4	#5964.79	52.8 PK	68.2	-15.4	3.03 H	122	48.1	4.7
5	11650.00	51.4 PK	74.0	-22.6	1.97 H	206	37.7	13.7
6	11650.00	40.1 AV	54.0	-13.9	1.97 H	206	26.4	13.7
7	#17475.00	50.5 PK	74.0	-23.5	1.71 H	282	31.9	18.6
8	#17475.00	39.5 AV	54.0	-14.5	1.71 H	282	20.9	18.6

ANTENNA POLARITY & TEST DISTANCE: VERTICAL AT 3 M

NO.	FREQ. (MHz)	EMISSION LEVEL (dBuV/m)	LIMIT (dBuV/m)	MARGIN (dB)	ANTENNA HEIGHT (m)	TABLE ANGLE (Degree)	RAW VALUE (dBuV)	CORRECTION FACTOR (dB/m)
1	#5600.43	58.9 PK	68.2	-9.3	2.04 V	107	54.5	4.4
2	*5825.00	111.7 PK			2.04 V	107	107.3	4.4
3	*5825.00	104.5 AV			2.04 V	107	100.1	4.4
4	#5989.98	58.1 PK	68.2	-10.1	2.04 V	107	53.4	4.7
5	11650.00	56.2 PK	74.0	-17.8	2.08 V	165	42.5	13.7
6	11650.00	42.6 AV	54.0	-11.4	2.08 V	165	28.9	13.7
7	#17475.00	53.1 PK	74.0	-20.9	2.35 V	164	34.5	18.6
8	#17475.00	40.5 AV	54.0	-13.5	2.35 V	164	21.9	18.6

REMARKS:

- Emission Level(dBuV/m) = Raw Value(dBuV) + Correction Factor(dB/m)
- Correction Factor(dB/m) = Antenna Factor(dB/m) + Cable Factor(dB) – Pre-Amplifier Factor(dB)
- The other emission levels were very low against the limit.
- Margin value = Emission Level – Limit value
- " * ": Fundamental frequency.
- " # ": The radiated frequency is out of the restricted band.

802.11ac (VHT20)

CHANNEL	TX Channel 36	DETECTOR FUNCTION	Peak (PK)
FREQUENCY RANGE	1GHz ~ 40GHz		Average (AV)

ANTENNA POLARITY & TEST DISTANCE: HORIZONTAL AT 3 M								
NO.	FREQ. (MHz)	EMISSION LEVEL (dBuV/m)	LIMIT (dBuV/m)	MARGIN (dB)	ANTENNA HEIGHT (m)	TABLE ANGLE (Degree)	RAW VALUE (dBuV)	CORRECTION FACTOR (dB/m)
1	5150.00	67.8 PK	74.0	-6.2	3.16 H	146	64.1	3.7
2	5150.00	51.9 AV	54.0	-2.1	3.16 H	146	48.2	3.7
3	*5180.00	109.4 PK			3.16 H	146	105.7	3.7
4	*5180.00	99.9 AV			3.16 H	146	96.2	3.7
5	#10360.00	48.6 PK	74.0	-25.4	1.69 H	131	35.6	13.0
6	#10360.00	35.4 AV	54.0	-18.6	1.69 H	131	22.4	13.0
7	15540.00	55.1 PK	74.0	-18.9	1.87 H	168	42.0	13.1
8	15540.00	43.2 AV	54.0	-10.8	1.87 H	168	30.1	13.1

ANTENNA POLARITY & TEST DISTANCE: VERTICAL AT 3 M								
NO.	FREQ. (MHz)	EMISSION LEVEL (dBuV/m)	LIMIT (dBuV/m)	MARGIN (dB)	ANTENNA HEIGHT (m)	TABLE ANGLE (Degree)	RAW VALUE (dBuV)	CORRECTION FACTOR (dB/m)
1	5150.00	71.3 PK	74.0	-2.7	2.00 V	96	67.6	3.7
2	5150.00	53.9 AV	54.0	-0.1	2.00 V	96	50.2	3.7
3	*5180.00	109.9 PK			2.00 V	96	106.2	3.7
4	*5180.00	100.4 AV			2.00 V	96	96.7	3.7
5	#10360.00	49.1 PK	74.0	-24.9	1.31 V	299	36.1	13.0
6	#10360.00	37.7 AV	54.0	-16.3	1.31 V	299	24.7	13.0
7	15540.00	55.4 PK	74.0	-18.6	1.79 V	180	42.3	13.1
8	15540.00	42.4 AV	54.0	-11.6	1.79 V	180	29.3	13.1

REMARKS:

- Emission Level(dBuV/m) = Raw Value(dBuV) + Correction Factor(dB/m)
- Correction Factor(dB/m) = Antenna Factor(dB/m) + Cable Factor(dB) – Pre-Amplifier Factor(dB)
- The other emission levels were very low against the limit.
- Margin value = Emission Level – Limit value
- " * ": Fundamental frequency.
- " # ": The radiated frequency is out of the restricted band.

CHANNEL	TX Channel 40	DETECTOR FUNCTION	Peak (PK)
FREQUENCY RANGE	1GHz ~ 40GHz		Average (AV)

ANTENNA POLARITY & TEST DISTANCE: HORIZONTAL AT 3 M

NO.	FREQ. (MHz)	EMISSION LEVEL (dBuV/m)	LIMIT (dBuV/m)	MARGIN (dB)	ANTENNA HEIGHT (m)	TABLE ANGLE (Degree)	RAW VALUE (dBuV)	CORRECTION FACTOR (dB/m)
1	*5200.00	109.6 PK			3.12 H	153	105.9	3.7
2	*5200.00	100.0 AV			3.12 H	153	96.3	3.7
3	#10400.00	49.1 PK	74.0	-24.9	1.70 H	140	36.1	13.0
4	#10400.00	35.7 AV	54.0	-18.3	1.70 H	140	22.7	13.0
5	15600.00	54.6 PK	74.0	-19.4	1.93 H	176	41.3	13.3
6	15600.00	43.0 AV	54.0	-11.0	1.93 H	176	29.7	13.3

ANTENNA POLARITY & TEST DISTANCE: VERTICAL AT 3 M

NO.	FREQ. (MHz)	EMISSION LEVEL (dBuV/m)	LIMIT (dBuV/m)	MARGIN (dB)	ANTENNA HEIGHT (m)	TABLE ANGLE (Degree)	RAW VALUE (dBuV)	CORRECTION FACTOR (dB/m)
1	*5200.00	110.8 PK			2.03 V	94	107.1	3.7
2	*5200.00	101.7 AV			2.03 V	94	98.0	3.7
3	#10400.00	49.1 PK	74.0	-24.9	1.27 V	306	36.1	13.0
4	#10400.00	37.6 AV	54.0	-16.4	1.27 V	306	24.6	13.0
5	15600.00	55.3 PK	74.0	-18.7	1.83 V	169	42.0	13.3
6	15600.00	43.2 AV	54.0	-10.8	1.83 V	169	29.9	13.3

REMARKS:

1. Emission Level(dBuV/m) = Raw Value(dBuV) + Correction Factor(dB/m)
2. Correction Factor(dB/m) = Antenna Factor(dB/m) + Cable Factor(dB) – Pre-Amplifier Factor(dB)
3. The other emission levels were very low against the limit.
4. Margin value = Emission Level – Limit value
5. " * ": Fundamental frequency.
6. " # ": The radiated frequency is out of the restricted band.

CHANNEL	TX Channel 48	DETECTOR FUNCTION	Peak (PK)
FREQUENCY RANGE	1GHz ~ 40GHz		Average (AV)

ANTENNA POLARITY & TEST DISTANCE: HORIZONTAL AT 3 M

NO.	FREQ. (MHz)	EMISSION LEVEL (dBuV/m)	LIMIT (dBuV/m)	MARGIN (dB)	ANTENNA HEIGHT (m)	TABLE ANGLE (Degree)	RAW VALUE (dBuV)	CORRECTION FACTOR (dB/m)
1	*5240.00	109.3 PK			3.14 H	139	105.5	3.8
2	*5240.00	99.7 AV			3.14 H	139	95.9	3.8
3	5350.00	52.0 PK	74.0	-22.0	3.14 H	139	47.9	4.1
4	5350.00	39.3 AV	54.0	-14.7	3.14 H	139	35.2	4.1
5	#10480.00	48.2 PK	74.0	-25.8	1.72 H	133	35.0	13.2
6	#10480.00	35.2 AV	54.0	-18.8	1.72 H	133	22.0	13.2
7	15720.00	55.5 PK	74.0	-18.5	1.85 H	159	41.9	13.6
8	15720.00	43.7 AV	54.0	-10.3	1.85 H	159	30.1	13.6

ANTENNA POLARITY & TEST DISTANCE: VERTICAL AT 3 M

NO.	FREQ. (MHz)	EMISSION LEVEL (dBuV/m)	LIMIT (dBuV/m)	MARGIN (dB)	ANTENNA HEIGHT (m)	TABLE ANGLE (Degree)	RAW VALUE (dBuV)	CORRECTION FACTOR (dB/m)
1	*5240.00	109.8 PK			2.03 V	96	106.0	3.8
2	*5240.00	100.7 AV			2.03 V	96	96.9	3.8
3	5350.00	51.8 PK	74.0	-22.2	2.03 V	96	47.7	4.1
4	5350.00	39.2 AV	54.0	-14.8	2.03 V	96	35.1	4.1
5	#10480.00	48.8 PK	74.0	-25.2	1.30 V	314	35.6	13.2
6	#10480.00	37.4 AV	54.0	-16.6	1.30 V	314	24.2	13.2
7	15720.00	55.1 PK	74.0	-18.9	1.81 V	163	41.5	13.6
8	15720.00	42.8 AV	54.0	-11.2	1.81 V	163	29.2	13.6

REMARKS:

1. Emission Level(dBuV/m) = Raw Value(dBuV) + Correction Factor(dB/m)
2. Correction Factor(dB/m) = Antenna Factor(dB/m) + Cable Factor(dB) – Pre-Amplifier Factor(dB)
3. The other emission levels were very low against the limit.
4. Margin value = Emission Level – Limit value
5. " * ": Fundamental frequency.
6. " # ": The radiated frequency is out of the restricted band.

CHANNEL	TX Channel 52	DETECTOR FUNCTION	Peak (PK)
FREQUENCY RANGE	1GHz ~ 40GHz		Average (AV)

ANTENNA POLARITY & TEST DISTANCE: HORIZONTAL AT 3 M

NO.	FREQ. (MHz)	EMISSION LEVEL (dBuV/m)	LIMIT (dBuV/m)	MARGIN (dB)	ANTENNA HEIGHT (m)	TABLE ANGLE (Degree)	RAW VALUE (dBuV)	CORRECTION FACTOR (dB/m)
1	5150.00	51.4 PK	74.0	-22.6	3.26 H	173	47.7	3.7
2	5150.00	38.9 AV	54.0	-15.1	3.26 H	173	35.2	3.7
3	*5260.00	108.0 PK			3.26 H	173	104.0	4.0
4	*5260.00	100.6 AV			3.26 H	173	96.6	4.0
5	#10520.00	48.0 PK	74.0	-26.0	1.69 H	138	34.8	13.2
6	#10520.00	35.0 AV	54.0	-19.0	1.69 H	138	21.8	13.2
7	15780.00	55.2 PK	74.0	-18.8	1.87 H	166	41.6	13.6
8	15780.00	42.9 AV	54.0	-11.1	1.87 H	166	29.3	13.6

ANTENNA POLARITY & TEST DISTANCE: VERTICAL AT 3 M

NO.	FREQ. (MHz)	EMISSION LEVEL (dBuV/m)	LIMIT (dBuV/m)	MARGIN (dB)	ANTENNA HEIGHT (m)	TABLE ANGLE (Degree)	RAW VALUE (dBuV)	CORRECTION FACTOR (dB/m)
1	5150.00	51.7 PK	74.0	-22.3	2.03 V	98	48.0	3.7
2	5150.00	39.4 AV	54.0	-14.6	2.03 V	98	35.7	3.7
3	*5260.00	110.4 PK			2.03 V	98	106.4	4.0
4	*5260.00	101.0 AV			2.03 V	98	97.0	4.0
5	#10520.00	49.1 PK	74.0	-24.9	1.34 V	300	35.9	13.2
6	#10520.00	37.4 AV	54.0	-16.6	1.34 V	300	24.2	13.2
7	15780.00	56.5 PK	74.0	-17.5	1.77 V	178	42.9	13.6
8	15780.00	43.0 AV	54.0	-11.0	1.77 V	178	29.4	13.6

REMARKS:

1. Emission Level(dBuV/m) = Raw Value(dBuV) + Correction Factor(dB/m)
2. Correction Factor(dB/m) = Antenna Factor(dB/m) + Cable Factor(dB) – Pre-Amplifier Factor(dB)
3. The other emission levels were very low against the limit.
4. Margin value = Emission Level – Limit value
5. " * ": Fundamental frequency.
6. " # ": The radiated frequency is out of the restricted band.

CHANNEL	TX Channel 60	DETECTOR FUNCTION	Peak (PK)
FREQUENCY RANGE	1GHz ~ 40GHz		Average (AV)

ANTENNA POLARITY & TEST DISTANCE: HORIZONTAL AT 3 M

NO.	FREQ. (MHz)	EMISSION LEVEL (dBuV/m)	LIMIT (dBuV/m)	MARGIN (dB)	ANTENNA HEIGHT (m)	TABLE ANGLE (Degree)	RAW VALUE (dBuV)	CORRECTION FACTOR (dB/m)
1	*5300.00	108.2 PK			3.29 H	166	104.1	4.1
2	*5300.00	100.6 AV			3.29 H	166	96.5	4.1
3	10600.00	47.9 PK	74.0	-26.1	1.70 H	123	34.4	13.5
4	10600.00	35.2 AV	54.0	-18.8	1.70 H	123	21.7	13.5
5	15900.00	55.5 PK	74.0	-18.5	1.86 H	176	42.6	12.9
6	15900.00	43.0 AV	54.0	-11.0	1.86 H	176	30.1	12.9

ANTENNA POLARITY & TEST DISTANCE: VERTICAL AT 3 M

NO.	FREQ. (MHz)	EMISSION LEVEL (dBuV/m)	LIMIT (dBuV/m)	MARGIN (dB)	ANTENNA HEIGHT (m)	TABLE ANGLE (Degree)	RAW VALUE (dBuV)	CORRECTION FACTOR (dB/m)
1	*5300.00	110.2 PK			2.04 V	97	106.1	4.1
2	*5300.00	101.4 AV			2.04 V	97	97.3	4.1
3	10600.00	49.0 PK	74.0	-25.0	1.31 V	295	35.5	13.5
4	10600.00	37.5 AV	54.0	-16.5	1.31 V	295	24.0	13.5
5	15900.00	56.2 PK	74.0	-17.8	1.78 V	186	43.3	12.9
6	15900.00	42.7 AV	54.0	-11.3	1.78 V	186	29.8	12.9

REMARKS:

1. Emission Level(dBuV/m) = Raw Value(dBuV) + Correction Factor(dB/m)
2. Correction Factor(dB/m) = Antenna Factor(dB/m) + Cable Factor(dB) – Pre-Amplifier Factor(dB)
3. The other emission levels were very low against the limit.
4. Margin value = Emission Level – Limit value
5. " * ": Fundamental frequency.

CHANNEL	TX Channel 64	DETECTOR FUNCTION	Peak (PK)
FREQUENCY RANGE	1GHz ~ 40GHz		Average (AV)

ANTENNA POLARITY & TEST DISTANCE: HORIZONTAL AT 3 M

NO.	FREQ. (MHz)	EMISSION LEVEL (dBuV/m)	LIMIT (dBuV/m)	MARGIN (dB)	ANTENNA HEIGHT (m)	TABLE ANGLE (Degree)	RAW VALUE (dBuV)	CORRECTION FACTOR (dB/m)
1	*5320.00	109.3 PK			3.18 H	155	105.2	4.1
2	*5320.00	99.8 AV			3.18 H	155	95.7	4.1
3	5350.00	67.6 PK	74.0	-6.4	3.18 H	155	63.5	4.1
4	5350.00	51.6 AV	54.0	-2.4	3.18 H	155	47.5	4.1
5	10640.00	48.5 PK	74.0	-25.5	1.73 H	128	35.0	13.5
6	10640.00	35.4 AV	54.0	-18.6	1.73 H	128	21.9	13.5
7	15960.00	55.6 PK	74.0	-18.4	1.89 H	150	42.7	12.9
8	15960.00	43.7 AV	54.0	-10.3	1.89 H	150	30.8	12.9

ANTENNA POLARITY & TEST DISTANCE: VERTICAL AT 3 M

NO.	FREQ. (MHz)	EMISSION LEVEL (dBuV/m)	LIMIT (dBuV/m)	MARGIN (dB)	ANTENNA HEIGHT (m)	TABLE ANGLE (Degree)	RAW VALUE (dBuV)	CORRECTION FACTOR (dB/m)
1	*5320.00	108.9 PK			2.01 V	94	104.8	4.1
2	*5320.00	99.7 AV			2.01 V	94	95.6	4.1
3	5350.00	71.0 PK	74.0	-3.0	2.01 V	94	66.9	4.1
4	5350.00	53.7 AV	54.0	-0.3	2.01 V	94	49.6	4.1
5	10640.00	49.2 PK	74.0	-24.8	1.32 V	297	35.7	13.5
6	10640.00	37.3 AV	54.0	-16.7	1.32 V	297	23.8	13.5
7	15960.00	56.2 PK	74.0	-17.8	1.83 V	179	43.3	12.9
8	15960.00	42.9 AV	54.0	-11.1	1.83 V	179	30.0	12.9

REMARKS:

1. Emission Level(dBuV/m) = Raw Value(dBuV) + Correction Factor(dB/m)
2. Correction Factor(dB/m) = Antenna Factor(dB/m) + Cable Factor(dB) – Pre-Amplifier Factor(dB)
3. The other emission levels were very low against the limit.
4. Margin value = Emission Level – Limit value
5. " * ": Fundamental frequency.

CHANNEL	TX Channel 100	DETECTOR FUNCTION	Peak (PK)
FREQUENCY RANGE	1GHz ~ 40GHz		Average (AV)

ANTENNA POLARITY & TEST DISTANCE: HORIZONTAL AT 3 M

NO.	FREQ. (MHz)	EMISSION LEVEL (dBuV/m)	LIMIT (dBuV/m)	MARGIN (dB)	ANTENNA HEIGHT (m)	TABLE ANGLE (Degree)	RAW VALUE (dBuV)	CORRECTION FACTOR (dB/m)
1	#5470.00	68.0 PK	74.0	-6.0	3.17 H	146	63.8	4.2
2	#5470.00	52.2 AV	54.0	-1.8	3.17 H	146	48.0	4.2
3	*5500.00	109.6 PK			3.17 H	146	105.4	4.2
4	*5500.00	100.1 AV			3.17 H	146	95.9	4.2
5	11000.00	48.5 PK	74.0	-25.5	1.77 H	127	34.4	14.1
6	11000.00	35.4 AV	54.0	-18.6	1.77 H	127	21.3	14.1
7	#16500.00	55.1 PK	74.0	-18.9	1.81 H	173	40.6	14.5
8	#16500.00	43.6 AV	54.0	-10.4	1.81 H	173	29.1	14.5

ANTENNA POLARITY & TEST DISTANCE: VERTICAL AT 3 M

NO.	FREQ. (MHz)	EMISSION LEVEL (dBuV/m)	LIMIT (dBuV/m)	MARGIN (dB)	ANTENNA HEIGHT (m)	TABLE ANGLE (Degree)	RAW VALUE (dBuV)	CORRECTION FACTOR (dB/m)
1	#5470.00	69.0 PK	74.0	-5.0	2.07 V	89	64.8	4.2
2	#5470.00	53.8 AV	54.0	-0.2	2.07 V	89	49.6	4.2
3	*5500.00	110.4 PK			2.07 V	89	106.2	4.2
4	*5500.00	101.2 AV			2.07 V	89	97.0	4.2
5	11000.00	49.6 PK	74.0	-24.4	1.31 V	318	35.5	14.1
6	11000.00	38.0 AV	54.0	-16.0	1.31 V	318	23.9	14.1
7	#16500.00	55.9 PK	74.0	-18.1	1.86 V	174	41.4	14.5
8	#16500.00	42.5 AV	54.0	-11.5	1.86 V	174	28.0	14.5

REMARKS:

1. Emission Level(dBuV/m) = Raw Value(dBuV) + Correction Factor(dB/m)
2. Correction Factor(dB/m) = Antenna Factor(dB/m) + Cable Factor(dB) – Pre-Amplifier Factor(dB)
3. The other emission levels were very low against the limit.
4. Margin value = Emission Level – Limit value
5. " * ": Fundamental frequency.
6. " # ": The radiated frequency is out of the restricted band.

CHANNEL	TX Channel 116	DETECTOR FUNCTION	Peak (PK)
FREQUENCY RANGE	1GHz ~ 40GHz		Average (AV)

ANTENNA POLARITY & TEST DISTANCE: HORIZONTAL AT 3 M

NO.	FREQ. (MHz)	EMISSION LEVEL (dBuV/m)	LIMIT (dBuV/m)	MARGIN (dB)	ANTENNA HEIGHT (m)	TABLE ANGLE (Degree)	RAW VALUE (dBuV)	CORRECTION FACTOR (dB/m)
1	*5580.00	108.5 PK			3.14 H	128	104.3	4.2
2	*5580.00	99.2 AV			3.14 H	128	95.0	4.2
3	11160.00	47.8 PK	74.0	-26.2	1.73 H	124	34.1	13.7
4	11160.00	34.7 AV	54.0	-19.3	1.73 H	124	21.0	13.7
5	#16740.00	55.4 PK	74.0	-18.6	1.79 H	160	39.7	15.7
6	#16740.00	43.4 AV	54.0	-10.6	1.79 H	160	27.7	15.7

ANTENNA POLARITY & TEST DISTANCE: VERTICAL AT 3 M

NO.	FREQ. (MHz)	EMISSION LEVEL (dBuV/m)	LIMIT (dBuV/m)	MARGIN (dB)	ANTENNA HEIGHT (m)	TABLE ANGLE (Degree)	RAW VALUE (dBuV)	CORRECTION FACTOR (dB/m)
1	*5580.00	110.3 PK			2.03 V	98	106.1	4.2
2	*5580.00	101.2 AV			2.03 V	98	97.0	4.2
3	11160.00	49.5 PK	74.0	-24.5	1.40 V	293	35.8	13.7
4	11160.00	37.5 AV	54.0	-16.5	1.40 V	293	23.8	13.7
5	#16740.00	56.3 PK	74.0	-17.7	1.89 V	161	40.6	15.7
6	#16740.00	43.3 AV	54.0	-10.7	1.89 V	161	27.6	15.7

REMARKS:

1. Emission Level(dBuV/m) = Raw Value(dBuV) + Correction Factor(dB/m)
2. Correction Factor(dB/m) = Antenna Factor(dB/m) + Cable Factor(dB) – Pre-Amplifier Factor(dB)
3. The other emission levels were very low against the limit.
4. Margin value = Emission Level – Limit value
5. " * ": Fundamental frequency.
6. " # ": The radiated frequency is out of the restricted band.

CHANNEL	TX Channel 140	DETECTOR FUNCTION	Peak (PK)
FREQUENCY RANGE	1GHz ~ 40GHz		Average (AV)

ANTENNA POLARITY & TEST DISTANCE: HORIZONTAL AT 3 M

NO.	FREQ. (MHz)	EMISSION LEVEL (dBuV/m)	LIMIT (dBuV/m)	MARGIN (dB)	ANTENNA HEIGHT (m)	TABLE ANGLE (Degree)	RAW VALUE (dBuV)	CORRECTION FACTOR (dB/m)
1	*5700.00	109.0 PK			3.10 H	145	104.5	4.5
2	*5700.00	99.2 AV			3.10 H	145	94.7	4.5
3	#5725.00	67.0 PK	74.0	-7.0	3.10 H	145	62.6	4.4
4	#5725.00	51.4 AV	54.0	-2.6	3.10 H	145	47.0	4.4
5	11400.00	48.7 PK	74.0	-25.3	1.71 H	122	35.1	13.6
6	11400.00	35.5 AV	54.0	-18.5	1.71 H	122	21.9	13.6
7	#17100.00	55.5 PK	74.0	-18.5	1.89 H	144	38.1	17.4
8	#17100.00	43.9 AV	54.0	-10.1	1.89 H	144	26.5	17.4

ANTENNA POLARITY & TEST DISTANCE: VERTICAL AT 3 M

NO.	FREQ. (MHz)	EMISSION LEVEL (dBuV/m)	LIMIT (dBuV/m)	MARGIN (dB)	ANTENNA HEIGHT (m)	TABLE ANGLE (Degree)	RAW VALUE (dBuV)	CORRECTION FACTOR (dB/m)
1	*5700.00	109.3 PK			2.10 V	91	104.8	4.5
2	*5700.00	100.2 AV			2.10 V	91	95.7	4.5
3	#5725.00	70.2 PK	74.0	-3.8	2.08 V	94	65.8	4.4
4	#5725.00	53.7 AV	54.0	-0.3	2.08 V	94	49.3	4.4
5	11400.00	49.4 PK	74.0	-24.6	1.30 V	291	35.8	13.6
6	11400.00	37.7 AV	54.0	-16.3	1.30 V	291	24.1	13.6
7	#17100.00	56.0 PK	74.0	-18.0	1.77 V	179	38.6	17.4
8	#17100.00	42.9 AV	54.0	-11.1	1.77 V	179	25.5	17.4

REMARKS:

1. Emission Level(dBuV/m) = Raw Value(dBuV) + Correction Factor(dB/m)
2. Correction Factor(dB/m) = Antenna Factor(dB/m) + Cable Factor(dB) – Pre-Amplifier Factor(dB)
3. The other emission levels were very low against the limit.
4. Margin value = Emission Level – Limit value
5. " * ": Fundamental frequency.
6. " # ": The radiated frequency is out of the restricted band.

CHANNEL	TX Channel 149	DETECTOR FUNCTION	Peak (PK)
FREQUENCY RANGE	1GHz ~ 40GHz		Average (AV)

ANTENNA POLARITY & TEST DISTANCE: HORIZONTAL AT 3 M

NO.	FREQ. (MHz)	EMISSION LEVEL (dBuV/m)	LIMIT (dBuV/m)	MARGIN (dB)	ANTENNA HEIGHT (m)	TABLE ANGLE (Degree)	RAW VALUE (dBuV)	CORRECTION FACTOR (dB/m)
1	#5594.58	52.6 PK	68.2	-15.6	2.99 H	110	48.3	4.3
2	*5745.00	107.5 PK			2.99 H	110	103.1	4.4
3	*5745.00	100.1 AV			2.99 H	110	95.7	4.4
4	#5993.34	52.5 PK	68.2	-15.7	2.99 H	110	47.8	4.7
5	11490.00	51.1 PK	74.0	-22.9	1.94 H	203	37.6	13.5
6	11490.00	39.6 AV	54.0	-14.4	1.94 H	203	26.1	13.5
7	#17235.00	50.6 PK	74.0	-23.4	1.77 H	271	33.3	17.3
8	#17235.00	39.8 AV	54.0	-14.2	1.77 H	271	22.5	17.3

ANTENNA POLARITY & TEST DISTANCE: VERTICAL AT 3 M

NO.	FREQ. (MHz)	EMISSION LEVEL (dBuV/m)	LIMIT (dBuV/m)	MARGIN (dB)	ANTENNA HEIGHT (m)	TABLE ANGLE (Degree)	RAW VALUE (dBuV)	CORRECTION FACTOR (dB/m)
1	#5613.18	59.2 PK	68.2	-9.0	1.98 V	98	54.8	4.4
2	*5745.00	113.4 PK			1.98 V	98	109.0	4.4
3	*5745.00	105.3 AV			1.98 V	98	100.9	4.4
4	#5944.94	58.4 PK	68.2	-9.8	1.98 V	98	53.7	4.7
5	11490.00	55.9 PK	74.0	-18.1	2.14 V	168	42.4	13.5
6	11490.00	42.5 AV	54.0	-11.5	2.14 V	168	29.0	13.5
7	#17235.00	53.6 PK	74.0	-20.4	2.38 V	165	36.3	17.3
8	#17235.00	41.0 AV	54.0	-13.0	2.38 V	165	23.7	17.3

REMARKS:

1. Emission Level(dBuV/m) = Raw Value(dBuV) + Correction Factor(dB/m)
2. Correction Factor(dB/m) = Antenna Factor(dB/m) + Cable Factor(dB) – Pre-Amplifier Factor(dB)
3. The other emission levels were very low against the limit.
4. Margin value = Emission Level – Limit value
5. " * ": Fundamental frequency.
6. " # ": The radiated frequency is out of the restricted band.

CHANNEL	TX Channel 157	DETECTOR FUNCTION	Peak (PK)
FREQUENCY RANGE	1GHz ~ 40GHz		Average (AV)

ANTENNA POLARITY & TEST DISTANCE: HORIZONTAL AT 3 M

NO.	FREQ. (MHz)	EMISSION LEVEL (dBuV/m)	LIMIT (dBuV/m)	MARGIN (dB)	ANTENNA HEIGHT (m)	TABLE ANGLE (Degree)	RAW VALUE (dBuV)	CORRECTION FACTOR (dB/m)
1	#5578.55	52.4 PK	68.2	-15.8	3.03 H	123	48.2	4.2
2	*5785.00	108.6 PK			3.03 H	123	104.2	4.4
3	*5785.00	100.8 AV			3.03 H	123	96.4	4.4
4	#5949.63	51.5 PK	68.2	-16.7	3.03 H	123	46.8	4.7
5	11570.00	51.1 PK	74.0	-22.9	1.94 H	194	37.6	13.5
6	11570.00	39.7 AV	54.0	-14.3	1.94 H	194	26.2	13.5
7	#17355.00	50.3 PK	74.0	-23.7	1.67 H	287	32.3	18.0
8	#17355.00	39.1 AV	54.0	-14.9	1.67 H	287	21.1	18.0

ANTENNA POLARITY & TEST DISTANCE: VERTICAL AT 3 M

NO.	FREQ. (MHz)	EMISSION LEVEL (dBuV/m)	LIMIT (dBuV/m)	MARGIN (dB)	ANTENNA HEIGHT (m)	TABLE ANGLE (Degree)	RAW VALUE (dBuV)	CORRECTION FACTOR (dB/m)
1	#5618.89	59.0 PK	68.2	-9.2	1.99 V	84	54.6	4.4
2	*5785.00	112.5 PK			1.99 V	84	108.1	4.4
3	*5785.00	104.7 AV			1.99 V	84	100.3	4.4
4	#6015.02	57.7 PK	68.2	-10.5	1.99 V	84	52.9	4.8
5	11570.00	55.7 PK	74.0	-18.3	2.09 V	186	42.2	13.5
6	11570.00	42.5 AV	54.0	-11.5	2.09 V	186	29.0	13.5
7	#17355.00	53.3 PK	74.0	-20.7	2.40 V	165	35.3	18.0
8	#17355.00	40.9 AV	54.0	-13.1	2.40 V	165	22.9	18.0

REMARKS:

1. Emission Level(dBuV/m) = Raw Value(dBuV) + Correction Factor(dB/m)
2. Correction Factor(dB/m) = Antenna Factor(dB/m) + Cable Factor(dB) – Pre-Amplifier Factor(dB)
3. The other emission levels were very low against the limit.
4. Margin value = Emission Level – Limit value
5. " * ": Fundamental frequency.
6. " # ": The radiated frequency is out of the restricted band.

CHANNEL	TX Channel 165	DETECTOR FUNCTION	Peak (PK)
FREQUENCY RANGE	1GHz ~ 40GHz		Average (AV)

ANTENNA POLARITY & TEST DISTANCE: HORIZONTAL AT 3 M

NO.	FREQ. (MHz)	EMISSION LEVEL (dBuV/m)	LIMIT (dBuV/m)	MARGIN (dB)	ANTENNA HEIGHT (m)	TABLE ANGLE (Degree)	RAW VALUE (dBuV)	CORRECTION FACTOR (dB/m)
1	#5623.23	51.5 PK	68.2	-16.7	3.01 H	110	47.1	4.4
2	*5825.00	108.1 PK			3.01 H	110	103.7	4.4
3	*5825.00	100.9 AV			3.01 H	110	96.5	4.4
4	#5987.74	51.7 PK	68.2	-16.5	3.01 H	110	47.0	4.7
5	11650.00	51.9 PK	74.0	-22.1	1.96 H	219	38.2	13.7
6	11650.00	40.4 AV	54.0	-13.6	1.96 H	219	26.7	13.7
7	#17475.00	50.4 PK	74.0	-23.6	1.66 H	296	31.8	18.6
8	#17475.00	39.3 AV	54.0	-14.7	1.66 H	296	20.7	18.6

ANTENNA POLARITY & TEST DISTANCE: VERTICAL AT 3 M

NO.	FREQ. (MHz)	EMISSION LEVEL (dBuV/m)	LIMIT (dBuV/m)	MARGIN (dB)	ANTENNA HEIGHT (m)	TABLE ANGLE (Degree)	RAW VALUE (dBuV)	CORRECTION FACTOR (dB/m)
1	#5643.94	59.5 PK	68.2	-8.7	2.03 V	91	55.1	4.4
2	*5825.00	112.4 PK			2.03 V	91	108.0	4.4
3	*5825.00	104.6 AV			2.03 V	91	100.2	4.4
4	#5975.05	58.9 PK	68.2	-9.3	2.03 V	91	54.2	4.7
5	11650.00	55.6 PK	74.0	-18.4	2.06 V	172	41.9	13.7
6	11650.00	42.5 AV	54.0	-11.5	2.06 V	172	28.8	13.7
7	#17475.00	53.2 PK	74.0	-20.8	2.30 V	148	34.6	18.6
8	#17475.00	40.5 AV	54.0	-13.5	2.30 V	148	21.9	18.6

REMARKS:

1. Emission Level(dBuV/m) = Raw Value(dBuV) + Correction Factor(dB/m)
2. Correction Factor(dB/m) = Antenna Factor(dB/m) + Cable Factor(dB) – Pre-Amplifier Factor(dB)
3. The other emission levels were very low against the limit.
4. Margin value = Emission Level – Limit value
5. " * ": Fundamental frequency.
6. " # ": The radiated frequency is out of the restricted band.

802.11ac (VHT40)

CHANNEL	TX Channel 38	DETECTOR FUNCTION	Peak (PK)
FREQUENCY RANGE	1GHz ~ 40GHz		Average (AV)

ANTENNA POLARITY & TEST DISTANCE: HORIZONTAL AT 3 M

NO.	FREQ. (MHz)	EMISSION LEVEL (dBuV/m)	LIMIT (dBuV/m)	MARGIN (dB)	ANTENNA HEIGHT (m)	TABLE ANGLE (Degree)	RAW VALUE (dBuV)	CORRECTION FACTOR (dB/m)
1	5150.00	67.0 PK	74.0	-7.0	3.16 H	146	63.3	3.7
2	5150.00	53.4 AV	54.0	-0.6	3.16 H	146	49.7	3.7
3	*5190.00	101.4 PK			3.16 H	146	97.7	3.7
4	*5190.00	91.5 AV			3.16 H	146	87.8	3.7
5	5350.00	51.1 PK	74.0	-22.9	3.16 H	146	47.0	4.1
6	5350.00	38.4 AV	54.0	-15.6	3.16 H	146	34.3	4.1
7	#10380.00	48.0 PK	74.0	-26.0	1.75 H	119	34.9	13.1
8	#10380.00	34.8 AV	54.0	-19.2	1.75 H	119	21.7	13.1
9	15570.00	55.6 PK	74.0	-18.4	1.86 H	146	42.3	13.3
10	15570.00	43.8 AV	54.0	-10.2	1.86 H	146	30.5	13.3

ANTENNA POLARITY & TEST DISTANCE: VERTICAL AT 3 M

NO.	FREQ. (MHz)	EMISSION LEVEL (dBuV/m)	LIMIT (dBuV/m)	MARGIN (dB)	ANTENNA HEIGHT (m)	TABLE ANGLE (Degree)	RAW VALUE (dBuV)	CORRECTION FACTOR (dB/m)
1	5150.00	68.3 PK	74.0	-5.7	2.01 V	96	64.6	3.7
2	5150.00	53.9 AV	54.0	-0.1	2.01 V	96	50.2	3.7
3	*5190.00	103.5 PK			2.01 V	96	99.8	3.7
4	*5190.00	93.9 AV			2.01 V	96	90.2	3.7
5	5350.00	51.2 PK	74.0	-22.8	2.01 V	96	47.1	4.1
6	5350.00	38.9 AV	54.0	-15.1	2.01 V	96	34.8	4.1
7	#10380.00	48.5 PK	74.0	-25.5	1.24 V	301	35.4	13.1
8	#10380.00	37.3 AV	54.0	-16.7	1.24 V	301	24.2	13.1
9	15570.00	55.2 PK	74.0	-18.8	1.79 V	166	41.9	13.3
10	15570.00	43.3 AV	54.0	-10.7	1.79 V	166	30.0	13.3

REMARKS:

- Emission Level(dBuV/m) = Raw Value(dBuV) + Correction Factor(dB/m)
- Correction Factor(dB/m) = Antenna Factor(dB/m) + Cable Factor(dB) – Pre-Amplifier Factor(dB)
- The other emission levels were very low against the limit.
- Margin value = Emission Level – Limit value
- " * ": Fundamental frequency.
- " # ": The radiated frequency is out of the restricted band.

CHANNEL	TX Channel 46	DETECTOR FUNCTION	Peak (PK)
FREQUENCY RANGE	1GHz ~ 40GHz		Average (AV)

ANTENNA POLARITY & TEST DISTANCE: HORIZONTAL AT 3 M

NO.	FREQ. (MHz)	EMISSION LEVEL (dBuV/m)	LIMIT (dBuV/m)	MARGIN (dB)	ANTENNA HEIGHT (m)	TABLE ANGLE (Degree)	RAW VALUE (dBuV)	CORRECTION FACTOR (dB/m)
1	*5230.00	105.8 PK			3.12 H	158	102.0	3.8
2	*5230.00	95.8 AV			3.12 H	158	92.0	3.8
3	5350.00	52.7 PK	74.0	-21.3	3.12 H	158	48.6	4.1
4	5350.00	39.4 AV	54.0	-14.6	3.12 H	158	35.3	4.1
5	#10460.00	48.3 PK	74.0	-25.7	1.79 H	129	35.2	13.1
6	#10460.00	35.1 AV	54.0	-18.9	1.79 H	129	22.0	13.1
7	15690.00	55.5 PK	74.0	-18.5	1.88 H	130	41.7	13.8
8	15690.00	43.7 AV	54.0	-10.3	1.88 H	130	29.9	13.8

ANTENNA POLARITY & TEST DISTANCE: VERTICAL AT 3 M

NO.	FREQ. (MHz)	EMISSION LEVEL (dBuV/m)	LIMIT (dBuV/m)	MARGIN (dB)	ANTENNA HEIGHT (m)	TABLE ANGLE (Degree)	RAW VALUE (dBuV)	CORRECTION FACTOR (dB/m)
1	*5230.00	106.5 PK			2.02 V	95	102.7	3.8
2	*5230.00	97.4 AV			2.02 V	95	93.6	3.8
3	5350.00	52.5 PK	74.0	-21.5	2.02 V	95	48.4	4.1
4	5350.00	39.6 AV	54.0	-14.4	2.02 V	95	35.5	4.1
5	#10460.00	49.1 PK	74.0	-24.9	1.30 V	301	36.0	13.1
6	#10460.00	37.7 AV	54.0	-16.3	1.30 V	301	24.6	13.1
7	15690.00	55.7 PK	74.0	-18.3	1.89 V	175	41.9	13.8
8	15690.00	43.5 AV	54.0	-10.5	1.89 V	175	29.7	13.8

REMARKS:

1. Emission Level(dBuV/m) = Raw Value(dBuV) + Correction Factor(dB/m)
2. Correction Factor(dB/m) = Antenna Factor(dB/m) + Cable Factor(dB) – Pre-Amplifier Factor(dB)
3. The other emission levels were very low against the limit.
4. Margin value = Emission Level – Limit value
5. " * ": Fundamental frequency.
6. " # ": The radiated frequency is out of the restricted band.

CHANNEL	TX Channel 54	DETECTOR FUNCTION	Peak (PK)
FREQUENCY RANGE	1GHz ~ 40GHz		Average (AV)

ANTENNA POLARITY & TEST DISTANCE: HORIZONTAL AT 3 M

NO.	FREQ. (MHz)	EMISSION LEVEL (dBuV/m)	LIMIT (dBuV/m)	MARGIN (dB)	ANTENNA HEIGHT (m)	TABLE ANGLE (Degree)	RAW VALUE (dBuV)	CORRECTION FACTOR (dB/m)
1	5150.00	52.7 PK	74.0	-21.3	3.12 H	146	49.0	3.7
2	5150.00	39.9 AV	54.0	-14.1	3.12 H	146	36.2	3.7
3	*5270.00	106.4 PK			3.12 H	146	102.4	4.0
4	*5270.00	96.6 AV			3.12 H	146	92.6	4.0
5	#10540.00	48.4 PK	74.0	-25.6	1.83 H	115	35.1	13.3
6	#10540.00	35.3 AV	54.0	-18.7	1.83 H	115	22.0	13.3
7	15810.00	55.4 PK	74.0	-18.6	1.89 H	116	42.0	13.4
8	15810.00	43.5 AV	54.0	-10.5	1.89 H	116	30.1	13.4

ANTENNA POLARITY & TEST DISTANCE: VERTICAL AT 3 M

NO.	FREQ. (MHz)	EMISSION LEVEL (dBuV/m)	LIMIT (dBuV/m)	MARGIN (dB)	ANTENNA HEIGHT (m)	TABLE ANGLE (Degree)	RAW VALUE (dBuV)	CORRECTION FACTOR (dB/m)
1	5150.00	53.0 PK	74.0	-21.0	1.99 V	93	49.3	3.7
2	5150.00	40.1 AV	54.0	-13.9	1.99 V	93	36.4	3.7
3	*5270.00	107.9 PK			1.99 V	93	103.9	4.0
4	*5270.00	98.5 AV			1.99 V	93	94.5	4.0
5	#10540.00	49.2 PK	74.0	-24.8	1.33 V	318	35.9	13.3
6	#10540.00	37.5 AV	54.0	-16.5	1.33 V	318	24.2	13.3
7	15810.00	55.1 PK	74.0	-18.9	1.83 V	156	41.7	13.4
8	15810.00	43.3 AV	54.0	-10.7	1.83 V	156	29.9	13.4

REMARKS:

1. Emission Level(dBuV/m) = Raw Value(dBuV) + Correction Factor(dB/m)
2. Correction Factor(dB/m) = Antenna Factor(dB/m) + Cable Factor(dB) – Pre-Amplifier Factor(dB)
3. The other emission levels were very low against the limit.
4. Margin value = Emission Level – Limit value
5. " * ": Fundamental frequency.
6. " # ": The radiated frequency is out of the restricted band.

CHANNEL	TX Channel 62	DETECTOR FUNCTION	Peak (PK)
FREQUENCY RANGE	1GHz ~ 40GHz		Average (AV)

ANTENNA POLARITY & TEST DISTANCE: HORIZONTAL AT 3 M

NO.	FREQ. (MHz)	EMISSION LEVEL (dBuV/m)	LIMIT (dBuV/m)	MARGIN (dB)	ANTENNA HEIGHT (m)	TABLE ANGLE (Degree)	RAW VALUE (dBuV)	CORRECTION FACTOR (dB/m)
1	*5310.00	101.5 PK			3.22 H	134	97.4	4.1
2	*5310.00	91.7 AV			3.22 H	134	87.6	4.1
3	5350.00	66.7 PK	74.0	-7.3	3.22 H	134	62.6	4.1
4	5350.00	53.2 AV	54.0	-0.8	3.22 H	134	49.1	4.1
5	10620.00	47.8 PK	74.0	-26.2	1.80 H	132	34.3	13.5
6	10620.00	34.8 AV	54.0	-19.2	1.80 H	132	21.3	13.5
7	15930.00	56.0 PK	74.0	-18.0	1.80 H	150	43.2	12.8
8	15930.00	43.9 AV	54.0	-10.1	1.80 H	150	31.1	12.8

ANTENNA POLARITY & TEST DISTANCE: VERTICAL AT 3 M

NO.	FREQ. (MHz)	EMISSION LEVEL (dBuV/m)	LIMIT (dBuV/m)	MARGIN (dB)	ANTENNA HEIGHT (m)	TABLE ANGLE (Degree)	RAW VALUE (dBuV)	CORRECTION FACTOR (dB/m)
1	*5310.00	102.8 PK			2.06 V	96	98.7	4.1
2	*5310.00	93.2 AV			2.06 V	96	89.1	4.1
3	5350.00	68.6 PK	74.0	-5.4	2.06 V	96	64.5	4.1
4	5350.00	53.9 AV	54.0	-0.1	2.06 V	96	49.8	4.1
5	10620.00	49.8 PK	74.0	-24.2	1.28 V	301	36.3	13.5
6	10620.00	38.0 AV	54.0	-16.0	1.28 V	301	24.5	13.5
7	15930.00	55.3 PK	74.0	-18.7	1.78 V	169	42.5	12.8
8	15930.00	43.3 AV	54.0	-10.7	1.78 V	169	30.5	12.8

REMARKS:

1. Emission Level(dBuV/m) = Raw Value(dBuV) + Correction Factor(dB/m)
2. Correction Factor(dB/m) = Antenna Factor(dB/m) + Cable Factor(dB) – Pre-Amplifier Factor(dB)
3. The other emission levels were very low against the limit.
4. Margin value = Emission Level – Limit value
5. " * ": Fundamental frequency.

CHANNEL	TX Channel 102	DETECTOR FUNCTION	Peak (PK)
FREQUENCY RANGE	1GHz ~ 40GHz		Average (AV)

ANTENNA POLARITY & TEST DISTANCE: HORIZONTAL AT 3 M

NO.	FREQ. (MHz)	EMISSION LEVEL (dBuV/m)	LIMIT (dBuV/m)	MARGIN (dB)	ANTENNA HEIGHT (m)	TABLE ANGLE (Degree)	RAW VALUE (dBuV)	CORRECTION FACTOR (dB/m)
1	#5470.00	63.0 PK	74.0	-11.0	3.13 H	165	58.8	4.2
2	#5470.00	50.1 AV	54.0	-3.9	3.13 H	165	45.9	4.2
3	*5510.00	101.7 PK			3.13 H	165	97.5	4.2
4	*5510.00	92.1 AV			3.13 H	165	87.9	4.2
5	11020.00	47.9 PK	74.0	-26.1	1.85 H	128	33.9	14.0
6	11020.00	34.9 AV	54.0	-19.1	1.85 H	128	20.9	14.0
7	#16530.00	55.9 PK	74.0	-18.1	1.83 H	137	41.0	14.9
8	#16530.00	44.0 AV	54.0	-10.0	1.83 H	137	29.1	14.9

ANTENNA POLARITY & TEST DISTANCE: VERTICAL AT 3 M

NO.	FREQ. (MHz)	EMISSION LEVEL (dBuV/m)	LIMIT (dBuV/m)	MARGIN (dB)	ANTENNA HEIGHT (m)	TABLE ANGLE (Degree)	RAW VALUE (dBuV)	CORRECTION FACTOR (dB/m)
1	#5470.00	67.9 PK	74.0	-6.1	2.11 V	97	63.7	4.2
2	#5470.00	53.6 AV	54.0	-0.4	2.11 V	97	49.4	4.2
3	*5510.00	104.4 PK			2.11 V	97	100.2	4.2
4	*5510.00	95.3 AV			2.11 V	97	91.1	4.2
5	11020.00	49.2 PK	74.0	-24.8	1.24 V	309	35.2	14.0
6	11020.00	37.8 AV	54.0	-16.2	1.24 V	309	23.8	14.0
7	#16530.00	54.8 PK	74.0	-19.2	1.88 V	180	39.9	14.9
8	#16530.00	42.9 AV	54.0	-11.1	1.88 V	180	28.0	14.9

REMARKS:

1. Emission Level(dBuV/m) = Raw Value(dBuV) + Correction Factor(dB/m)
2. Correction Factor(dB/m) = Antenna Factor(dB/m) + Cable Factor(dB) – Pre-Amplifier Factor(dB)
3. The other emission levels were very low against the limit.
4. Margin value = Emission Level – Limit value
5. " * ": Fundamental frequency.
6. " # ": The radiated frequency is out of the restricted band.

CHANNEL	TX Channel 110	DETECTOR FUNCTION	Peak (PK)
FREQUENCY RANGE	1GHz ~ 40GHz		Average (AV)

ANTENNA POLARITY & TEST DISTANCE: HORIZONTAL AT 3 M

NO.	FREQ. (MHz)	EMISSION LEVEL (dBuV/m)	LIMIT (dBuV/m)	MARGIN (dB)	ANTENNA HEIGHT (m)	TABLE ANGLE (Degree)	RAW VALUE (dBuV)	CORRECTION FACTOR (dB/m)
1	*5550.00	105.6 PK			3.17 H	163	101.4	4.2
2	*5550.00	95.5 AV			3.17 H	163	91.3	4.2
3	11100.00	48.7 PK	74.0	-25.3	1.84 H	129	34.9	13.8
4	11100.00	35.6 AV	54.0	-18.4	1.84 H	129	21.8	13.8
5	#16650.00	55.2 PK	74.0	-18.8	1.84 H	130	39.6	15.6
6	#16650.00	43.6 AV	54.0	-10.4	1.84 H	130	28.0	15.6

ANTENNA POLARITY & TEST DISTANCE: VERTICAL AT 3 M

NO.	FREQ. (MHz)	EMISSION LEVEL (dBuV/m)	LIMIT (dBuV/m)	MARGIN (dB)	ANTENNA HEIGHT (m)	TABLE ANGLE (Degree)	RAW VALUE (dBuV)	CORRECTION FACTOR (dB/m)
1	*5550.00	108.6 PK			2.14 V	93	104.4	4.2
2	*5550.00	99.3 AV			2.14 V	93	95.1	4.2
3	11100.00	49.4 PK	74.0	-24.6	1.28 V	318	35.6	13.8
4	11100.00	38.0 AV	54.0	-16.0	1.28 V	318	24.2	13.8
5	#16650.00	55.0 PK	74.0	-19.0	1.84 V	155	39.4	15.6
6	#16650.00	42.8 AV	54.0	-11.2	1.84 V	155	27.2	15.6

REMARKS:

1. Emission Level(dBuV/m) = Raw Value(dBuV) + Correction Factor(dB/m)
2. Correction Factor(dB/m) = Antenna Factor(dB/m) + Cable Factor(dB) – Pre-Amplifier Factor(dB)
3. The other emission levels were very low against the limit.
4. Margin value = Emission Level – Limit value
5. " * ": Fundamental frequency.
6. " # ": The radiated frequency is out of the restricted band.

CHANNEL	TX Channel 134	DETECTOR FUNCTION	Peak (PK)
FREQUENCY RANGE	1GHz ~ 40GHz		Average (AV)

ANTENNA POLARITY & TEST DISTANCE: HORIZONTAL AT 3 M

NO.	FREQ. (MHz)	EMISSION LEVEL (dBuV/m)	LIMIT (dBuV/m)	MARGIN (dB)	ANTENNA HEIGHT (m)	TABLE ANGLE (Degree)	RAW VALUE (dBuV)	CORRECTION FACTOR (dB/m)
1	*5670.00	104.1 PK			3.10 H	140	99.8	4.3
2	*5670.00	94.4 AV			3.10 H	140	90.1	4.3
3	#5725.00	65.8 PK	74.0	-8.2	3.10 H	140	61.4	4.4
4	#5725.00	49.5 AV	54.0	-4.5	3.10 H	140	45.1	4.4
5	11340.00	48.9 PK	74.0	-25.1	1.79 H	138	35.3	13.6
6	11340.00	35.6 AV	54.0	-18.4	1.79 H	138	22.0	13.6
7	#17010.00	54.8 PK	74.0	-19.2	1.79 H	114	37.7	17.1
8	#17010.00	43.3 AV	54.0	-10.7	1.79 H	114	26.2	17.1

ANTENNA POLARITY & TEST DISTANCE: VERTICAL AT 3 M

NO.	FREQ. (MHz)	EMISSION LEVEL (dBuV/m)	LIMIT (dBuV/m)	MARGIN (dB)	ANTENNA HEIGHT (m)	TABLE ANGLE (Degree)	RAW VALUE (dBuV)	CORRECTION FACTOR (dB/m)
1	*5670.00	105.8 PK			2.15 V	94	101.5	4.3
2	*5670.00	96.6 AV			2.15 V	94	92.3	4.3
3	#5725.00	71.0 PK	74.0	-3.0	2.15 V	94	66.6	4.4
4	#5725.00	53.3 AV	54.0	-0.7	2.15 V	94	48.9	4.4
5	11340.00	48.5 PK	74.0	-25.5	1.31 V	311	34.9	13.6
6	11340.00	37.3 AV	54.0	-16.7	1.31 V	311	23.7	13.6
7	#17010.00	55.0 PK	74.0	-19.0	1.82 V	169	37.9	17.1
8	#17010.00	43.0 AV	54.0	-11.0	1.82 V	169	25.9	17.1

REMARKS:

1. Emission Level(dBuV/m) = Raw Value(dBuV) + Correction Factor(dB/m)
2. Correction Factor(dB/m) = Antenna Factor(dB/m) + Cable Factor(dB) – Pre-Amplifier Factor(dB)
3. The other emission levels were very low against the limit.
4. Margin value = Emission Level – Limit value
5. " * ": Fundamental frequency.
6. " # ": The radiated frequency is out of the restricted band.

CHANNEL	TX Channel 151	DETECTOR FUNCTION	Peak (PK)
FREQUENCY RANGE	1GHz ~ 40GHz		Average (AV)

ANTENNA POLARITY & TEST DISTANCE: HORIZONTAL AT 3 M

NO.	FREQ. (MHz)	EMISSION LEVEL (dBuV/m)	LIMIT (dBuV/m)	MARGIN (dB)	ANTENNA HEIGHT (m)	TABLE ANGLE (Degree)	RAW VALUE (dBuV)	CORRECTION FACTOR (dB/m)
1	#5646.60	55.3 PK	68.2	-12.9	3.08 H	153	50.9	4.4
2	*5755.00	107.5 PK			3.08 H	153	103.1	4.4
3	*5755.00	99.7 AV			3.08 H	153	95.3	4.4
4	#6008.07	50.6 PK	68.2	-17.6	3.08 H	153	45.8	4.8
5	11510.00	49.2 PK	74.0	-24.8	1.77 H	133	35.6	13.6
6	11510.00	37.8 AV	54.0	-16.2	1.77 H	133	24.2	13.6
7	#17265.00	55.8 PK	74.0	-18.2	1.78 H	123	38.2	17.6
8	#17265.00	43.6 AV	54.0	-10.4	1.78 H	123	26.0	17.6

ANTENNA POLARITY & TEST DISTANCE: VERTICAL AT 3 M

NO.	FREQ. (MHz)	EMISSION LEVEL (dBuV/m)	LIMIT (dBuV/m)	MARGIN (dB)	ANTENNA HEIGHT (m)	TABLE ANGLE (Degree)	RAW VALUE (dBuV)	CORRECTION FACTOR (dB/m)
1	#5644.63	60.9 PK	68.2	-7.3	1.98 V	98	56.5	4.4
2	*5755.00	109.2 PK			1.98 V	98	104.8	4.4
3	*5755.00	101.0 AV			1.98 V	98	96.6	4.4
4	#5951.49	58.6 PK	68.2	-9.6	1.98 V	98	53.9	4.7
5	11510.00	48.6 PK	74.0	-25.4	1.32 V	293	35.0	13.6
6	11510.00	37.4 AV	54.0	-16.6	1.32 V	293	23.8	13.6
7	#17265.00	55.7 PK	74.0	-18.3	1.86 V	156	38.1	17.6
8	#17265.00	43.4 AV	54.0	-10.6	1.86 V	156	25.8	17.6

REMARKS:

1. Emission Level(dBuV/m) = Raw Value(dBuV) + Correction Factor(dB/m)
2. Correction Factor(dB/m) = Antenna Factor(dB/m) + Cable Factor(dB) – Pre-Amplifier Factor(dB)
3. The other emission levels were very low against the limit.
4. Margin value = Emission Level – Limit value
5. " * ": Fundamental frequency.
6. " # ": The radiated frequency is out of the restricted band.

CHANNEL	TX Channel 159	DETECTOR FUNCTION	Peak (PK)
FREQUENCY RANGE	1GHz ~ 40GHz		Average (AV)

ANTENNA POLARITY & TEST DISTANCE: HORIZONTAL AT 3 M

NO.	FREQ. (MHz)	EMISSION LEVEL (dBuV/m)	LIMIT (dBuV/m)	MARGIN (dB)	ANTENNA HEIGHT (m)	TABLE ANGLE (Degree)	RAW VALUE (dBuV)	CORRECTION FACTOR (dB/m)
1	#5646.72	52.1 PK	68.2	-16.1	3.07 H	148	47.7	4.4
2	*5795.00	107.9 PK			3.07 H	148	103.5	4.4
3	*5795.00	100.1 AV			3.07 H	148	95.7	4.4
4	#5995.19	53.1 PK	68.2	-15.1	3.07 H	148	48.4	4.7
5	11590.00	49.2 PK	74.0	-24.8	1.73 H	121	35.7	13.5
6	11590.00	38.1 AV	54.0	-15.9	1.73 H	121	24.6	13.5
7	#17385.00	56.1 PK	74.0	-17.9	1.78 H	113	37.8	18.3
8	#17385.00	43.9 AV	54.0	-10.1	1.78 H	113	25.6	18.3

ANTENNA POLARITY & TEST DISTANCE: VERTICAL AT 3 M

NO.	FREQ. (MHz)	EMISSION LEVEL (dBuV/m)	LIMIT (dBuV/m)	MARGIN (dB)	ANTENNA HEIGHT (m)	TABLE ANGLE (Degree)	RAW VALUE (dBuV)	CORRECTION FACTOR (dB/m)
1	#5649.06	59.5 PK	68.2	-8.7	1.99 V	94	55.1	4.4
2	*5795.00	110.2 PK			1.99 V	94	105.8	4.4
3	*5795.00	101.8 AV			1.99 V	94	97.4	4.4
4	#5931.54	58.7 PK	68.2	-9.5	1.99 V	94	54.0	4.7
5	11590.00	49.5 PK	74.0	-24.5	1.26 V	294	36.0	13.5
6	11590.00	37.9 AV	54.0	-16.1	1.26 V	294	24.4	13.5
7	#17385.00	55.2 PK	74.0	-18.8	1.80 V	179	36.9	18.3
8	#17385.00	43.0 AV	54.0	-11.0	1.80 V	179	24.7	18.3

REMARKS:

1. Emission Level(dBuV/m) = Raw Value(dBuV) + Correction Factor(dB/m)
2. Correction Factor(dB/m) = Antenna Factor(dB/m) + Cable Factor(dB) – Pre-Amplifier Factor(dB)
3. The other emission levels were very low against the limit.
4. Margin value = Emission Level – Limit value
5. " * ": Fundamental frequency.
6. " # ": The radiated frequency is out of the restricted band.

802.11ac (VHT80)

CHANNEL	TX Channel 42	DETECTOR FUNCTION	Peak (PK)
FREQUENCY RANGE	1GHz ~ 40GHz		Average (AV)

ANTENNA POLARITY & TEST DISTANCE: HORIZONTAL AT 3 M

NO.	FREQ. (MHz)	EMISSION LEVEL (dBuV/m)	LIMIT (dBuV/m)	MARGIN (dB)	ANTENNA HEIGHT (m)	TABLE ANGLE (Degree)	RAW VALUE (dBuV)	CORRECTION FACTOR (dB/m)
1	5150.00	64.8 PK	74.0	-9.2	3.09 H	142	61.1	3.7
2	5150.00	50.7 AV	54.0	-3.3	3.09 H	142	47.0	3.7
3	*5210.00	101.7 PK			3.11 H	151	98.0	3.7
4	*5210.00	90.3 AV			3.11 H	151	86.6	3.7
5	5350.00	53.6 PK	74.0	-20.4	3.11 H	151	49.5	4.1
6	5350.00	40.1 AV	54.0	-13.9	3.11 H	151	36.0	4.1
7	#10420.00	48.1 PK	74.0	-25.9	1.65 H	127	35.0	13.1
8	#10420.00	34.7 AV	54.0	-19.3	1.65 H	127	21.6	13.1
9	15630.00	55.4 PK	74.0	-18.6	1.77 H	197	41.8	13.6
10	15630.00	43.0 AV	54.0	-11.0	1.77 H	197	29.4	13.6

ANTENNA POLARITY & TEST DISTANCE: VERTICAL AT 3 M

NO.	FREQ. (MHz)	EMISSION LEVEL (dBuV/m)	LIMIT (dBuV/m)	MARGIN (dB)	ANTENNA HEIGHT (m)	TABLE ANGLE (Degree)	RAW VALUE (dBuV)	CORRECTION FACTOR (dB/m)
1	5150.00	68.1 PK	74.0	-5.9	2.01 V	94	64.4	3.7
2	5150.00	53.8 AV	54.0	-0.2	2.01 V	94	50.1	3.7
3	*5210.00	102.0 PK			2.01 V	94	98.3	3.7
4	*5210.00	92.8 AV			2.01 V	94	89.1	3.7
5	5350.00	54.0 PK	74.0	-20.0	2.01 V	94	49.9	4.1
6	5350.00	40.4 AV	54.0	-13.6	2.01 V	94	36.3	4.1
7	#10420.00	48.8 PK	74.0	-25.2	1.24 V	290	35.7	13.1
8	#10420.00	37.1 AV	54.0	-16.9	1.24 V	290	24.0	13.1
9	15630.00	55.2 PK	74.0	-18.8	1.87 V	182	41.6	13.6
10	15630.00	43.3 AV	54.0	-10.7	1.87 V	182	29.7	13.6

REMARKS:

1. Emission Level(dBuV/m) = Raw Value(dBuV) + Correction Factor(dB/m)
2. Correction Factor(dB/m) = Antenna Factor(dB/m) + Cable Factor(dB) – Pre-Amplifier Factor(dB)
3. The other emission levels were very low against the limit.
4. Margin value = Emission Level – Limit value
5. " * ": Fundamental frequency.
6. " # ": The radiated frequency is out of the restricted band.

CHANNEL	TX Channel 58	DETECTOR FUNCTION	Peak (PK)
FREQUENCY RANGE	1GHz ~ 40GHz		Average (AV)

ANTENNA POLARITY & TEST DISTANCE: HORIZONTAL AT 3 M

NO.	FREQ. (MHz)	EMISSION LEVEL (dBuV/m)	LIMIT (dBuV/m)	MARGIN (dB)	ANTENNA HEIGHT (m)	TABLE ANGLE (Degree)	RAW VALUE (dBuV)	CORRECTION FACTOR (dB/m)
1	5150.00	52.6 PK	74.0	-21.4	3.10 H	149	48.9	3.7
2	5150.00	39.5 AV	54.0	-14.5	3.10 H	149	35.8	3.7
3	*5290.00	102.0 PK			3.10 H	149	97.9	4.1
4	*5290.00	90.7 AV			3.10 H	149	86.6	4.1
5	5350.00	64.4 PK	74.0	-9.6	3.10 H	149	60.3	4.1
6	5350.00	50.4 AV	54.0	-3.6	3.10 H	149	46.3	4.1
7	#10580.00	48.3 PK	74.0	-25.7	1.64 H	122	34.9	13.4
8	#10580.00	34.7 AV	54.0	-19.3	1.64 H	122	21.3	13.4
9	15870.00	55.6 PK	74.0	-18.4	1.82 H	204	42.6	13.0
10	15870.00	43.3 AV	54.0	-10.7	1.82 H	204	30.3	13.0

ANTENNA POLARITY & TEST DISTANCE: VERTICAL AT 3 M

NO.	FREQ. (MHz)	EMISSION LEVEL (dBuV/m)	LIMIT (dBuV/m)	MARGIN (dB)	ANTENNA HEIGHT (m)	TABLE ANGLE (Degree)	RAW VALUE (dBuV)	CORRECTION FACTOR (dB/m)
1	5150.00	52.5 PK	74.0	-21.5	2.08 V	95	48.8	3.7
2	5150.00	39.7 AV	54.0	-14.3	2.08 V	95	36.0	3.7
3	*5290.00	101.2 PK			2.08 V	95	97.1	4.1
4	*5290.00	91.4 AV			2.08 V	95	87.3	4.1
5	5350.00	67.5 PK	74.0	-6.5	2.08 V	95	63.4	4.1
6	5350.00	53.7 AV	54.0	-0.3	2.08 V	95	49.6	4.1
7	#10580.00	48.6 PK	74.0	-25.4	1.29 V	319	35.2	13.4
8	#10580.00	37.4 AV	54.0	-16.6	1.29 V	319	24.0	13.4
9	15870.00	55.6 PK	74.0	-18.4	1.83 V	155	42.6	13.0
10	15870.00	43.2 AV	54.0	-10.8	1.83 V	155	30.2	13.0

REMARKS:

- Emission Level(dBuV/m) = Raw Value(dBuV) + Correction Factor(dB/m)
- Correction Factor(dB/m) = Antenna Factor(dB/m) + Cable Factor(dB) – Pre-Amplifier Factor(dB)
- The other emission levels were very low against the limit.
- Margin value = Emission Level – Limit value
- " * ": Fundamental frequency.
- " # ": The radiated frequency is out of the restricted band.

CHANNEL	TX Channel 106	DETECTOR FUNCTION	Peak (PK)
FREQUENCY RANGE	1GHz ~ 40GHz		Average (AV)

ANTENNA POLARITY & TEST DISTANCE: HORIZONTAL AT 3 M

NO.	FREQ. (MHz)	EMISSION LEVEL (dBuV/m)	LIMIT (dBuV/m)	MARGIN (dB)	ANTENNA HEIGHT (m)	TABLE ANGLE (Degree)	RAW VALUE (dBuV)	CORRECTION FACTOR (dB/m)
1	#5470.00	63.9 PK	74.0	-10.1	3.16 H	163	59.7	4.2
2	#5470.00	49.9 AV	54.0	-4.1	3.16 H	163	45.7	4.2
3	*5530.00	102.2 PK			3.16 H	163	98.0	4.2
4	*5530.00	91.2 AV			3.16 H	163	87.0	4.2
5	#5725.00	52.7 PK	74.0	-21.3	3.16 H	163	48.3	4.4
6	#5725.00	39.5 AV	54.0	-14.5	3.16 H	163	35.1	4.4
7	11060.00	48.7 PK	74.0	-25.3	1.63 H	133	34.8	13.9
8	11060.00	35.0 AV	54.0	-19.0	1.63 H	133	21.1	13.9
9	#16590.00	55.8 PK	74.0	-18.2	1.80 H	197	40.2	15.6
10	#16590.00	43.7 AV	54.0	-10.3	1.80 H	197	28.1	15.6

ANTENNA POLARITY & TEST DISTANCE: VERTICAL AT 3 M

NO.	FREQ. (MHz)	EMISSION LEVEL (dBuV/m)	LIMIT (dBuV/m)	MARGIN (dB)	ANTENNA HEIGHT (m)	TABLE ANGLE (Degree)	RAW VALUE (dBuV)	CORRECTION FACTOR (dB/m)
1	#5470.00	68.2 PK	74.0	-5.8	2.14 V	93	64.0	4.2
2	#5470.00	53.6 AV	54.0	-0.4	2.14 V	93	49.4	4.2
3	*5530.00	102.0 PK			2.14 V	93	97.8	4.2
4	*5530.00	92.0 AV			2.14 V	93	87.8	4.2
5	#5725.00	52.4 PK	74.0	-21.6	2.14 V	93	48.0	4.4
6	#5725.00	39.7 AV	54.0	-14.3	2.14 V	93	35.3	4.4
7	11060.00	49.3 PK	74.0	-24.7	1.31 V	306	35.4	13.9
8	11060.00	37.8 AV	54.0	-16.2	1.31 V	306	23.9	13.9
9	#16590.00	55.6 PK	74.0	-18.4	1.88 V	168	40.0	15.6
10	#16590.00	43.6 AV	54.0	-10.4	1.88 V	168	28.0	15.6

REMARKS:

1. Emission Level(dBuV/m) = Raw Value(dBuV) + Correction Factor(dB/m)
2. Correction Factor(dB/m) = Antenna Factor(dB/m) + Cable Factor(dB) – Pre-Amplifier Factor(dB)
3. The other emission levels were very low against the limit.
4. Margin value = Emission Level – Limit value
5. " * ": Fundamental frequency.
6. " # ": The radiated frequency is out of the restricted band.

CHANNEL	TX Channel 122	DETECTOR FUNCTION	Peak (PK)
FREQUENCY RANGE	1GHz ~ 40GHz		Average (AV)

ANTENNA POLARITY & TEST DISTANCE: HORIZONTAL AT 3 M

NO.	FREQ. (MHz)	EMISSION LEVEL (dBuV/m)	LIMIT (dBuV/m)	MARGIN (dB)	ANTENNA HEIGHT (m)	TABLE ANGLE (Degree)	RAW VALUE (dBuV)	CORRECTION FACTOR (dB/m)
1	*5610.00	100.2 PK			3.12 H	161	95.8	4.4
2	*5610.00	92.9 AV			3.12 H	161	88.5	4.4
3	#5725.00	58.9 PK	74.0	-15.1	3.12 H	161	54.5	4.4
4	#5725.00	44.7 AV	54.0	-9.3	3.12 H	161	40.3	4.4
5	11220.00	48.5 PK	74.0	-25.5	1.57 H	128	34.8	13.7
6	11220.00	35.0 AV	54.0	-19.0	1.57 H	128	21.3	13.7
7	#16830.00	55.5 PK	74.0	-18.5	1.80 H	192	39.6	15.9
8	#16830.00	43.3 AV	54.0	-10.7	1.80 H	192	27.4	15.9

ANTENNA POLARITY & TEST DISTANCE: VERTICAL AT 3 M

NO.	FREQ. (MHz)	EMISSION LEVEL (dBuV/m)	LIMIT (dBuV/m)	MARGIN (dB)	ANTENNA HEIGHT (m)	TABLE ANGLE (Degree)	RAW VALUE (dBuV)	CORRECTION FACTOR (dB/m)
1	*5610.00	106.3 PK			2.12 V	92	101.9	4.4
2	*5610.00	96.0 AV			2.12 V	92	91.6	4.4
3	#5725.00	69.8 PK	74.0	-4.2	2.12 V	92	65.4	4.4
4	#5725.00	53.7 AV	54.0	-0.3	2.12 V	92	49.3	4.4
5	11220.00	48.9 PK	74.0	-25.1	1.29 V	315	35.2	13.7
6	11220.00	37.7 AV	54.0	-16.3	1.29 V	315	24.0	13.7
7	#16830.00	54.7 PK	74.0	-19.3	1.89 V	157	38.8	15.9
8	#16830.00	42.9 AV	54.0	-11.1	1.89 V	157	27.0	15.9

REMARKS:

1. Emission Level(dBuV/m) = Raw Value(dBuV) + Correction Factor(dB/m)
2. Correction Factor(dB/m) = Antenna Factor(dB/m) + Cable Factor(dB) – Pre-Amplifier Factor(dB)
3. The other emission levels were very low against the limit.
4. Margin value = Emission Level – Limit value
5. " * ": Fundamental frequency.
6. " # ": The radiated frequency is out of the restricted band.

CHANNEL	TX Channel 155	DETECTOR FUNCTION	Peak (PK)
FREQUENCY RANGE	1GHz ~ 40GHz		Average (AV)

ANTENNA POLARITY & TEST DISTANCE: HORIZONTAL AT 3 M

NO.	FREQ. (MHz)	EMISSION LEVEL (dBuV/m)	LIMIT (dBuV/m)	MARGIN (dB)	ANTENNA HEIGHT (m)	TABLE ANGLE (Degree)	RAW VALUE (dBuV)	CORRECTION FACTOR (dB/m)
1	#5641.72	61.9 PK	68.2	-6.3	3.10 H	150	57.5	4.4
2	*5775.00	102.6 PK			3.10 H	150	98.2	4.4
3	*5775.00	95.5 AV			3.10 H	150	91.1	4.4
4	#5930.58	62.3 PK	68.2	-5.9	3.10 H	150	57.6	4.7
5	11550.00	48.4 PK	74.0	-25.6	1.57 H	142	34.9	13.5
6	11550.00	34.6 AV	54.0	-19.4	1.57 H	142	21.1	13.5
7	#17325.00	55.9 PK	74.0	-18.1	1.85 H	184	38.1	17.8
8	#17325.00	43.7 AV	54.0	-10.3	1.85 H	184	25.9	17.8

ANTENNA POLARITY & TEST DISTANCE: VERTICAL AT 3 M

NO.	FREQ. (MHz)	EMISSION LEVEL (dBuV/m)	LIMIT (dBuV/m)	MARGIN (dB)	ANTENNA HEIGHT (m)	TABLE ANGLE (Degree)	RAW VALUE (dBuV)	CORRECTION FACTOR (dB/m)
1	#5641.81	66.9 PK	68.2	-1.3	2.03 V	92	62.5	4.4
2	*5775.00	107.7 PK			2.03 V	92	103.3	4.4
3	*5775.00	98.8 AV			2.03 V	92	94.4	4.4
4	#5927.34	65.7 PK	68.2	-2.5	2.03 V	92	61.0	4.7
5	11550.00	48.5 PK	74.0	-25.5	1.33 V	309	35.0	13.5
6	11550.00	37.3 AV	54.0	-16.7	1.33 V	309	23.8	13.5
7	#17325.00	54.9 PK	74.0	-19.1	1.83 V	155	37.1	17.8
8	#17325.00	42.8 AV	54.0	-11.2	1.83 V	155	25.0	17.8

REMARKS:

1. Emission Level(dBuV/m) = Raw Value(dBuV) + Correction Factor(dB/m)
2. Correction Factor(dB/m) = Antenna Factor(dB/m) + Cable Factor(dB) – Pre-Amplifier Factor(dB)
3. The other emission levels were very low against the limit.
4. Margin value = Emission Level – Limit value
5. " * ": Fundamental frequency.
6. " # ": The radiated frequency is out of the restricted band.

Below 1GHz Data:

802.11a

CHANNEL	TX Channel 149	DETECTOR FUNCTION	Quasi-Peak (QP)
FREQUENCY RANGE	9kHz ~ 1GHz		

ANTENNA POLARITY & TEST DISTANCE: HORIZONTAL AT 3 M

NO.	FREQ. (MHz)	EMISSION LEVEL (dBuV/m)	LIMIT (dBuV/m)	MARGIN (dB)	ANTENNA HEIGHT (m)	TABLE ANGLE (Degree)	RAW VALUE (dBuV)	CORRECTION FACTOR (dB/m)
1	51.58	21.7 QP	40.0	-18.3	1.50 H	262	30.0	-8.3
2	159.33	21.6 QP	43.5	-21.9	2.00 H	300	29.8	-8.2
3	196.11	21.2 QP	43.5	-22.3	1.00 H	70	32.4	-11.2
4	230.33	20.6 QP	46.0	-25.4	2.00 H	116	31.2	-10.6
5	559.77	27.1 QP	46.0	-18.9	1.00 H	211	29.0	-1.9
6	868.13	31.6 QP	46.0	-14.4	1.50 H	192	29.1	2.5

ANTENNA POLARITY & TEST DISTANCE: VERTICAL AT 3 M

NO.	FREQ. (MHz)	EMISSION LEVEL (dBuV/m)	LIMIT (dBuV/m)	MARGIN (dB)	ANTENNA HEIGHT (m)	TABLE ANGLE (Degree)	RAW VALUE (dBuV)	CORRECTION FACTOR (dB/m)
1	86.53	36.9 QP	40.0	-3.1	1.50 V	276	50.9	-14.0
2	131.56	30.8 QP	43.5	-12.7	1.50 V	278	40.3	-9.5
3	247.62	26.6 QP	46.0	-19.4	1.00 V	360	36.3	-9.7
4	346.32	28.8 QP	46.0	-17.2	1.00 V	360	35.3	-6.5
5	787.69	32.3 QP	46.0	-13.7	2.00 V	358	30.3	2.0
6	909.45	33.2 QP	46.0	-12.8	2.00 V	95	29.9	3.3

REMARKS:

1. Emission Level(dBuV/m) = Raw Value(dBuV) + Correction Factor(dB/m)
2. Correction Factor(dB/m) = Antenna Factor(dB/m) + Cable Factor(dB) – Pre-Amplifier Factor(dB)
3. The other emission levels were very low against the limit.
4. Margin value = Emission Level – Limit value

4.2 Conducted Emission Measurement

4.2.1 Limits of Conducted Emission Measurement

Frequency (MHz)	Conducted Limit (dBuV)	
	Quasi-peak	Average
0.15 - 0.5	66 - 56	56 - 46
0.50 - 5.0	56	46
5.0 - 30.0	60	50

Note: 1. The lower limit shall apply at the transition frequencies.

2. The limit decreases in line with the logarithm of the frequency in the range of 0.15 to 0.50MHz.

4.2.2 Test Instruments

DESCRIPTION & MANUFACTURER	MODEL NO.	SERIAL NO.	CALIBRATED DATE	CALIBRATED UNTIL
Test Receiver R&S	ESCS 30	847124/029	Oct. 24, 2016	Oct. 23, 2017
Line-Impedance Stabilization Network (for EUT) R&S	ESH3-Z5	848773/004	Oct. 26, 2016	Oct. 25, 2017
Line-Impedance Stabilization Network (for Peripheral) R&S	ENV216	100072	June 03, 2017	June 02, 2018
50 ohms Terminator	N/A	EMC-02	Sep. 22, 2017	Sep. 21, 2018
RF Cable	5D-FB	COCCAB-001	Sep. 29, 2017	Sep. 28, 2018
10 dB PAD Mini-Circuits	HAT-10+	CONATT-004	June 18, 2017	June 17, 2018
Software BVADT	BVADT_Cond_ V7.3.7.4	NA	NA	NA

Note:

1. The calibration interval of the above test instruments are 12 months and the calibrations are traceable to NML/ROC and NIST/USA.
2. The test was performed in Shielded Room No. 1.
3. Tested Date: Oct. 04, 2017

4.2.3 Test Procedure

- The EUT was placed 0.4 meters from the conducting wall of the shielded room with EUT being connected to the power mains through a line impedance stabilization network (LISN). Other support units were connected to the power mains through another LISN. The two LISNs provide 50 ohm/ 50uH of coupling impedance for the measuring instrument.
- Both lines of the power mains connected to the EUT were checked for maximum conducted interference.
- The frequency range from 150kHz to 30MHz was searched. Emission levels under (Limit - 20dB) was not recorded.

NOTE: All modes of operation were investigated and the worst-case emissions are reported.

4.2.4 Deviation from Test Standard

No deviation.

4.2.5 Test Setup

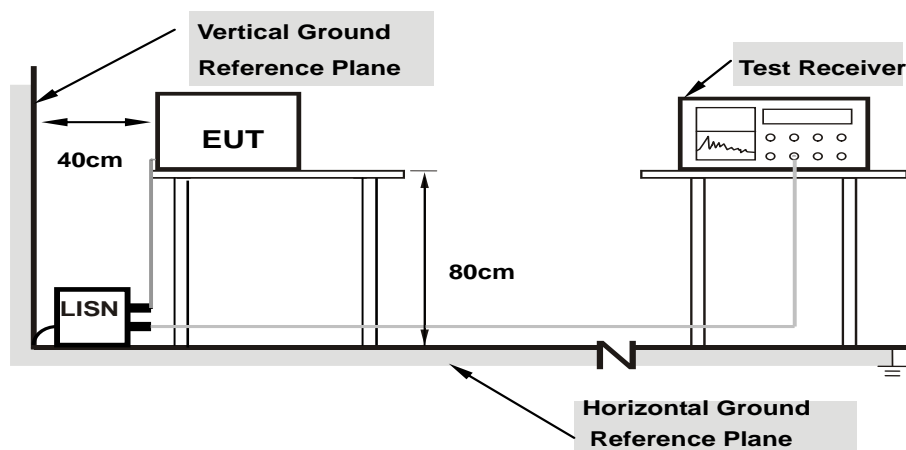

Note: 1.Support units were connected to second LISN.

For the actual test configuration, please refer to the attached file (Test Setup Photo).

4.2.6 EUT Operating Condition

Same as 4.1.6.

4.2.7 Test Results

Phase	Line (L)	Detector Function	Quasi-Peak (QP) / Average (AV)
-------	----------	-------------------	--------------------------------

No	Freq. [MHz]	Corr.	Reading Value		Emission Level		Limit		Margin	
		Factor (dB)	[dB (uV)]		[dB (uV)]		[dB (uV)]		(dB)	
			Q.P.	AV.	Q.P.	AV.	Q.P.	AV.	Q.P.	AV.
1	0.15000	10.07	19.34	10.60	29.41	20.67	66.00	56.00	-36.59	-35.33
2	0.20078	10.06	14.31	6.40	24.37	16.46	63.58	53.58	-39.21	-37.12
3	0.57578	10.12	16.19	11.32	26.31	21.44	56.00	46.00	-29.69	-24.56
4	16.46484	11.06	29.58	29.31	40.64	40.37	60.00	50.00	-19.36	-9.63
5	21.16797	11.30	27.64	26.61	38.94	37.91	60.00	50.00	-21.06	-12.09
6	25.87500	11.33	27.59	27.58	38.92	38.91	60.00	50.00	-21.08	-11.09

REMARKS:

1. Q.P. and AV. are abbreviations of quasi-peak and average individually.
2. The emission levels of other frequencies were very low against the limit.
3. Margin value = Emission level - Limit value
4. Correction factor = Insertion loss + Cable loss
5. Emission Level = Correction Factor + Reading Value.

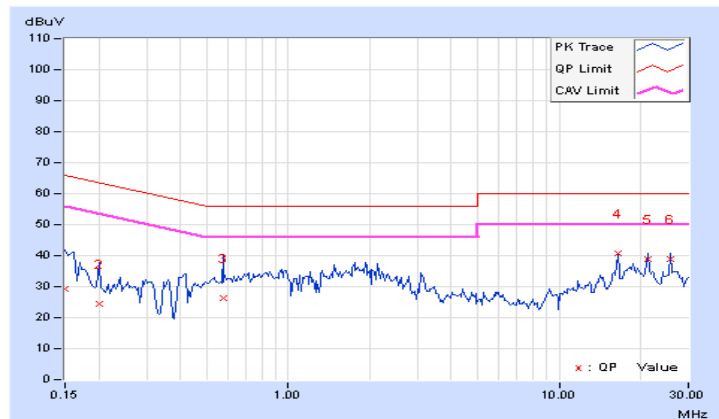

Phase	Neutral (N)	Detector Function	Quasi-Peak (QP) / Average (AV)
-------	-------------	-------------------	--------------------------------

No	Freq.	Corr.	Reading Value		Emission Level		Limit		Margin	
	[MHz]	Factor	[dB (uV)]		[dB (uV)]		[dB (uV)]		(dB)	
		(dB)	Q.P.	AV.	Q.P.	AV.	Q.P.	AV.	Q.P.	AV.
1	0.15391	10.06	19.46	16.26	29.52	26.32	65.79	55.79	-36.27	-29.47
2	0.48594	10.10	21.77	13.22	31.87	23.32	56.24	46.24	-24.37	-22.92
3	16.46484	10.85	30.31	30.20	41.16	41.05	60.00	50.00	-18.84	-8.95
4	21.16797	11.00	28.54	27.89	39.54	38.89	60.00	50.00	-20.46	-11.11
5	25.87109	10.97	28.87	28.52	39.84	39.49	60.00	50.00	-20.16	-10.51
6	28.07031	10.97	17.08	2.99	28.05	13.96	60.00	50.00	-31.95	-36.04

REMARKS:

1. Q.P. and AV. are abbreviations of quasi-peak and average individually.
2. The emission levels of other frequencies were very low against the limit.
3. Margin value = Emission level - Limit value
4. Correction factor = Insertion loss + Cable loss
5. Emission Level = Correction Factor + Reading Value.

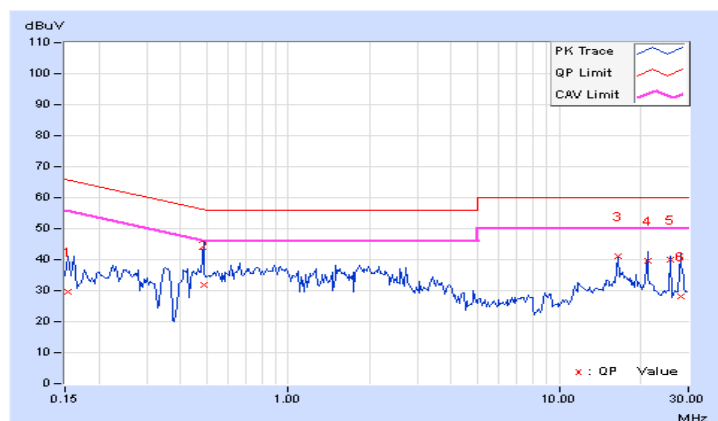

4.3 Transmit Power Measurement

4.3.1 Limits of Transmit Power Measurement

Operation Band	EUT Category		Limit
U-NII-1		Outdoor Access Point	1 Watt (30 dBm) (Max. e.i.r.p \leq 125mW(21 dBm) at any elevation angle above 30 degrees as measured from the horizon)
		Fixed point-to-point Access Point	1 Watt (30 dBm)
		Indoor Access Point	1 Watt (30 dBm)
	√	Mobile and Portable client device	250mW (24 dBm)
U-NII-2A		√	250mW (24 dBm) or 11 dBm+10 log B*
U-NII-2C		√	250mW (24 dBm) or 11 dBm+10 log B*
U-NII-3		√	1 Watt (30 dBm)

*B is the 26 dB emission bandwidth in megahertz

4.3.2 Test Setup

FOR POWER OUTPUT MEASUREMENT

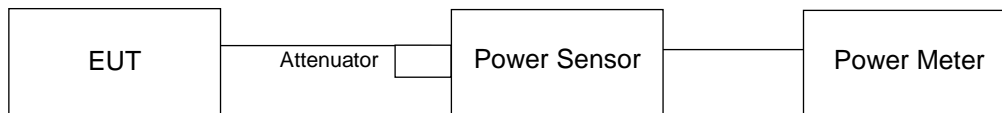

FOR 26dB OCCUPIED BANDWIDTH

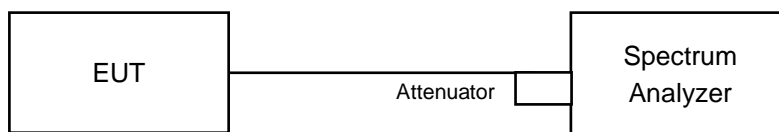

4.3.3 Test Instruments

Refer to section 4.1.2 to get information of above instrument.

4.3.4 Test Procedure

For Average Power Measurement

Method PM is used to perform output power measurement, trigger and gating function of wide band power meter is enabled to measure max output power of TX on burst. Duty factor is not added to measured value.

FOR 26dB OCCUPIED BANDWIDTH

1. Set RBW = approximately 1% of the emission bandwidth.
2. Set the VBW > RBW.
3. Detector = Peak.
4. Trace mode = max hold.
5. Measure the maximum width of the emission that is 26 dB down from the peak of the emission. Compare this with the RBW setting of the analyzer. Readjust RBW and repeat measurement as needed until the RBW/EBW ratio is approximately 1%.

4.3.5 Deviation from Test Standard

No deviation.

4.3.6 EUT Operating Condition

The software provided by client to enable the EUT under transmission condition continuously at lowest, middle and highest channel frequencies individually.

4.3.7 Test Result

802.11a

Power Output:

Channel	Channel Frequency (MHz)	Maximum Conducted Power (mW)	Maximum Conducted Power (dBm)	Power Limit (dBm)	Pass/Fail
36	5180	76.033	18.81	24.00	Pass
40	5200	100	20.00	24.00	Pass
48	5240	80.353	19.05	24.00	Pass
52	5260	97.949	19.91	24.00	Pass
60	5300	95.719	19.81	24.00	Pass
64	5320	72.611	18.61	24.00	Pass
100	5500	70.958	18.51	23.74	Pass
116	5580	81.47	19.11	23.74	Pass
140	5700	41.495	16.18	23.74	Pass
149	5745	120.504	20.81	28.88	Pass
157	5785	116.95	20.68	28.88	Pass
165	5825	91.622	19.62	28.88	Pass

- Note:**
1. UNII-2C: Ant gain = 6.26dBi > 6dBi, therefore the limit needs to reduce, so the power limit shall be reduced to "Determined Conducted Limit-(6.26-6)"
 2. UNII-3: Ant gain = 7.12Bi > 6dBi, therefore the limit needs to reduce, so the power limit shall be reduced to 30-(7.12-6) = 28.88dBm.

26dB OCCUPIED BANDWIDTH

Channel	Frequency (MHz)	26dBc Bandwidth (MHz)
52	5260	35.21
60	5300	35.13
64	5320	34.64
100	5500	31.49
116	5580	34.19
140	5700	26.79

Note: For U-NII-2A, U-NII-2C Band output power limitation is determined based on 26dBc bandwidth

Power Limit = 11dBm + 10logB < U-NII-2A, U-NII-2C >			
Channel Number	Freq.(MHz)	Min. B(MHz)	Determined Conducted Limit (dBm)
52	5260	35.21	26.46 > 24
60	5300	35.13	26.45 > 24
64	5320	34.64	26.39 > 24
100	5500	31.49	25.98 > 24
116	5580	34.19	26.33 > 24
140	5700	26.79	25.27 > 24

802.11ac (VHT20)

Power Output:

Channel	Channel Frequency (MHz)	Maximum Conducted Power (mW)	Maximum Conducted Power (dBm)	Power Limit (dBm)	Pass/Fail
36	5180	85.31	19.31	24.00	Pass
40	5200	102.802	20.12	24.00	Pass
48	5240	83.56	19.22	24.00	Pass
52	5260	91.411	19.61	24.00	Pass
60	5300	82.985	19.19	24.00	Pass
64	5320	70.632	18.49	24.00	Pass
100	5500	63.387	18.02	23.74	Pass
116	5580	79.983	19.03	23.74	Pass
140	5700	46.452	16.67	23.74	Pass
149	5745	109.901	20.41	28.88	Pass
157	5785	88.716	19.48	28.88	Pass
165	5825	87.498	19.42	28.88	Pass

- Note:**
1. UNII-2C: Ant gain = 6.26dBi > 6dBi, therefore the limit needs to reduce, so the power limit shall be reduced to "Determined Conducted Limit-(6.26-6)"
 2. UNII-3: Ant gain = 7.12Bi > 6dBi, therefore the limit needs to reduce, so the power limit shall be reduced to 30-(7.12-6) = 28.88dBm.

26dB OCCUPIED BANDWIDTH

Channel	Frequency (MHz)	26dBc Bandwidth (MHz)
52	5260	39.70
60	5300	39.90
64	5320	38.29
100	5500	30.31
116	5580	31.94
140	5700	26.73

Note: For U-NII-2A, U-NII-2C Band output power limitation is determined based on 26dBc bandwidth

Power Limit = 11dBm + 10logB < U-NII-2A, U-NII-2C >			
Channel Number	Freq.(MHz)	Min. B(MHz)	Determined Conducted Limit (dBm)
52	5260	39.70	26.98 > 24
60	5300	39.90	27 > 24
64	5320	38.29	26.83 > 24
100	5500	30.31	25.81 > 24
116	5580	31.94	26.04 > 24
140	5700	26.73	25.26 > 24

802.11ac (VHT40)

Power Output:

Channel	Channel Frequency (MHz)	Maximum Conducted Power (mW)	Maximum Conducted Power (dBm)	Power Limit (dBm)	Pass/Fail
38	5190	35.156	15.46	24.00	Pass
46	5230	74.645	18.73	24.00	Pass
54	5270	85.507	19.32	24.00	Pass
62	5310	26.73	14.27	24.00	Pass
102	5510	35.645	15.52	23.74	Pass
110	5550	92.683	19.67	23.74	Pass
134	5670	60.117	17.79	23.74	Pass
151	5755	108.643	20.36	28.88	Pass
159	5795	112.72	20.52	28.88	Pass

- Note:** 1. UNII-2C: Ant gain = 6.26dBi > 6dBi, therefore the limit needs to reduce, so the power limit shall be reduced to "Determined Conducted Limit-(6.26-6)"
 2. UNII-3: Ant gain = 7.12Bi > 6dBi, therefore the limit needs to reduce, so the power limit shall be reduced to 30-(7.12-6) = 28.88dBm.

26dB OCCUPIED BANDWIDTH

Channel	Frequency (MHz)	26dBc Bandwidth (MHz)
54	5270	78.01
62	5310	43.73
102	5510	44.91
110	5550	73.98
134	5670	70.00

Note: For U-NII-2A, U-NII-2C Band output power limitation is determined based on 26dBc bandwidth

Power Limit = 11dBm + 10logB < U-NII-2A, U-NII-2C >			
Channel Number	Freq.(MHz)	Min. B(MHz)	Determined Conducted Limit (dBm)
54	5270	78.01	29.92 > 24
62	5310	43.73	27.4 > 24
102	5510	44.91	27.52 > 24
110	5550	73.98	29.69 > 24
134	5670	70.00	29.45 > 24

802.11ac (VHT80)

Power Output:

Channel	Channel Frequency (MHz)	Maximum Conducted Power (mW)	Maximum Conducted Power (dBm)	Power Limit (dBm)	Pass/Fail
42	5210	19.634	12.93	24.00	Pass
58	5290	15.56	11.92	24.00	Pass
106	5530	30.061	14.78	23.74	Pass
122	5610	60.395	17.81	23.74	Pass
155	5775	76.736	18.85	28.88	Pass

- Note:**
- UNII-2C: Ant gain = 6.26dBi > 6dBi, therefore the limit needs to reduce, so the power limit shall be reduced to "Determined Conducted Limit-(6.26-6)"
 - UNII-3: Ant gain = 7.12Bi > 6dBi, therefore the limit needs to reduce, so the power limit shall be reduced to 30-(7.12-6) = 28.88dBm.

26dB OCCUPIED BANDWIDTH

Channel	Frequency (MHz)	26dBc Bandwidth (MHz)
58	5290	81.74
106	5530	82.15
122	5610	128.29

Note: For U-NII-2A, U-NII-2C Band output power limitation is determined based on 26dBc bandwidth

Power Limit = 11dBm + 10logB < U-NII-2A, U-NII-2C >			
Channel Number	Freq.(MHz)	Min. B(MHz)	Determined Conducted Limit (dBm)
58	5290	81.74	30.12 > 24
106	5530	82.15	30.14 > 24
122	5610	128.29	32.08 > 24

Spectrum Plot of Worst Value

802.11a / CH140

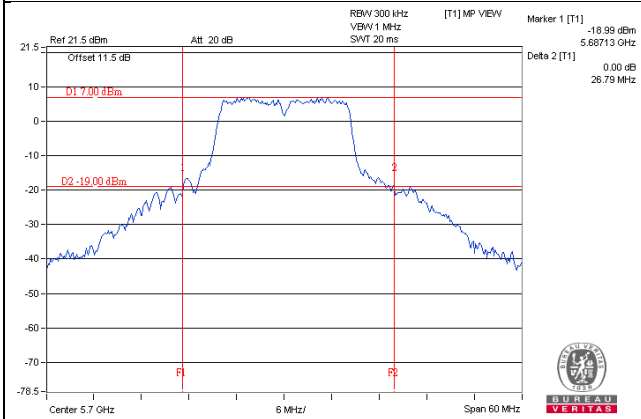

802.11ac (VHT20) / CH140

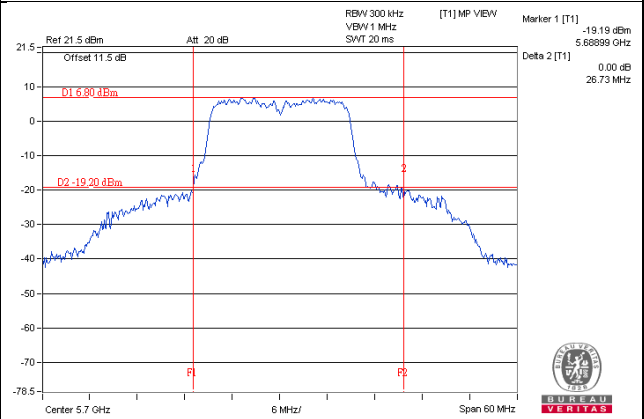

802.11ac (VHT40) / CH62

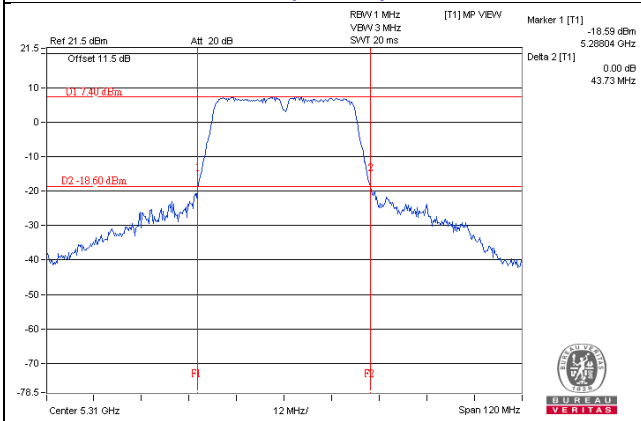

802.11ac (VHT80) / CH58

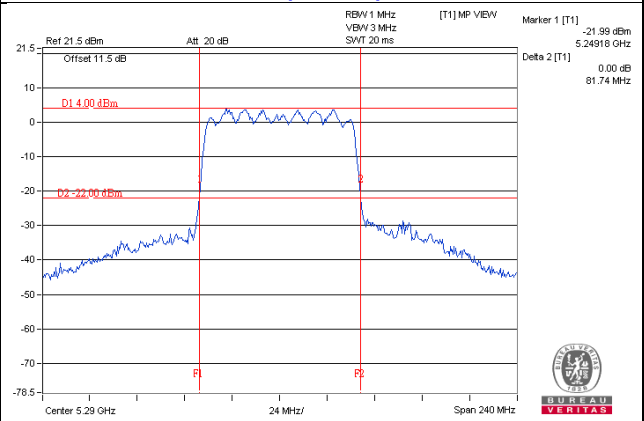

4.4 Occupied Bandwidth Measurement

4.4.1 Test Setup

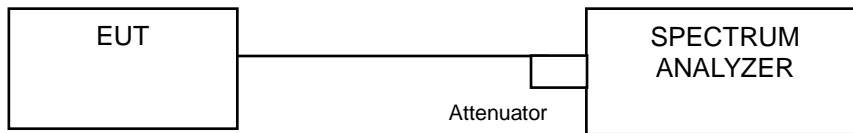

4.4.2 Test Instruments

Refer to section 4.1.2 to get information of above instrument.

4.4.3 Test Procedure

The transmitter output was connected to the spectrum analyzer through an attenuator. The bandwidth of the fundamental frequency was measured by spectrum analyzer with resolution bandwidth in the range of 1% to 5% of the anticipated emission bandwidth, and a video bandwidth at least 3x the resolution bandwidth and set the detector to SAMPLE. The width of a frequency band such that, below the lower and above the upper frequency limits, the mean powers emitted are each equal to a specified percentage 0.5 %of the total mean power of a given emission.

4.4.4 Test Results

802.11a

Channel	Channel Frequency (MHz)	Occupied Bandwidth (MHz)
36	5180	17.28
40	5200	21.36
48	5240	18.24
52	5260	18.36
60	5300	18.72
64	5320	17.40
100	5500	17.04
116	5580	17.04
140	5700	16.92
149	5745	26.52
157	5785	24.24
165	5825	22.92

802.11ac (VHT20)

Channel	Channel Frequency (MHz)	Occupied Bandwidth (MHz)
36	5180	18.48
40	5200	21.72
48	5240	18.48
52	5260	18.48
60	5300	18.36
64	5320	18.00
100	5500	17.88
116	5580	17.88
140	5700	17.88
149	5745	22.08
157	5785	25.32
165	5825	20.76

802.11ac (VHT40)

Channel	Channel Frequency (MHz)	Occupied Bandwidth (MHz)
38	5190	36.96
46	5230	36.96
54	5270	37.44
62	5310	36.48
102	5510	36.48
110	5550	36.96
134	5670	36.72
151	5755	48.24
159	5795	49.20

802.11ac (VHT80)

Channel	Channel Frequency (MHz)	Occupied Bandwidth (MHz)
42	5210	74.88
58	5290	75.36
106	5530	75.36
122	5610	75.84
155	5775	77.28

Spectrum Plot of Worst Value

802.11a / CH149

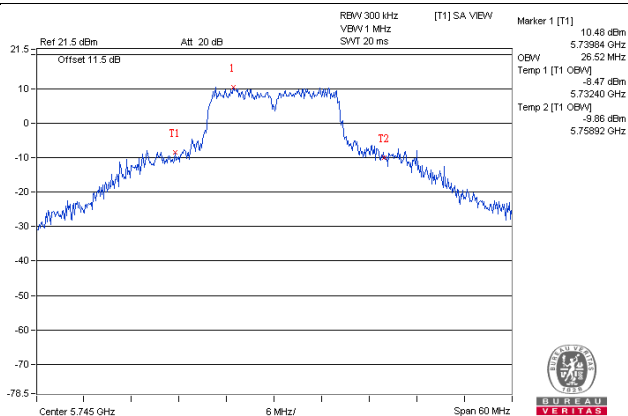

802.11ac (VHT20) / CH157

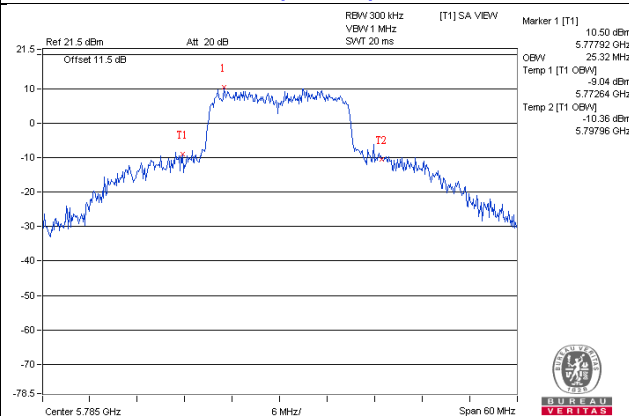

802.11ac (VHT40) / CH159

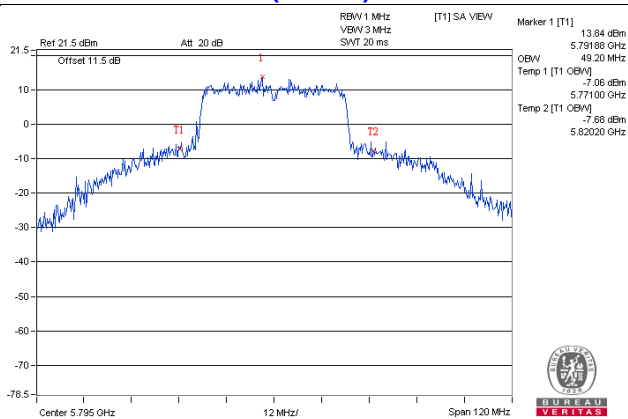

802.11ac (VHT80) / CH155

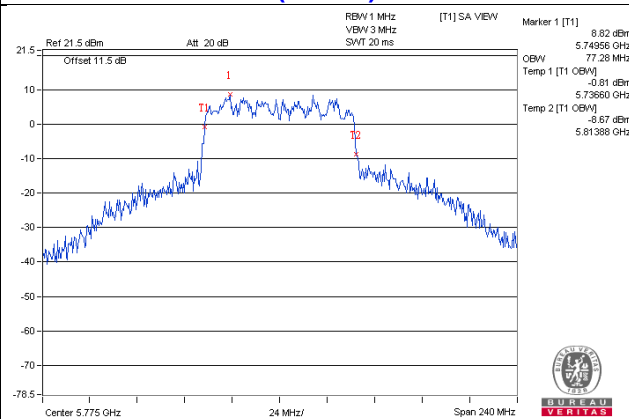

**Spectrum Plot for near by DFS band
(DFS is required, if 99% OCP straddle into U-NII-2A band)**

802.11a / CH48

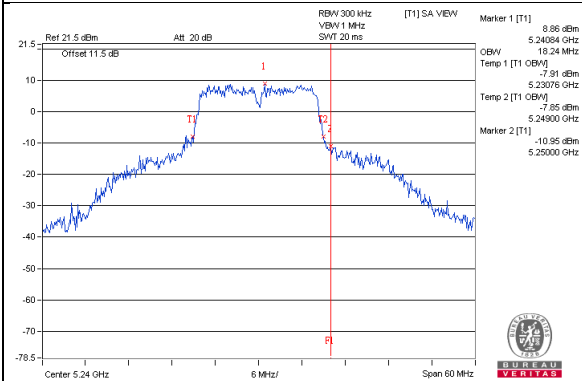

802.11ac(VHT20) / CH48

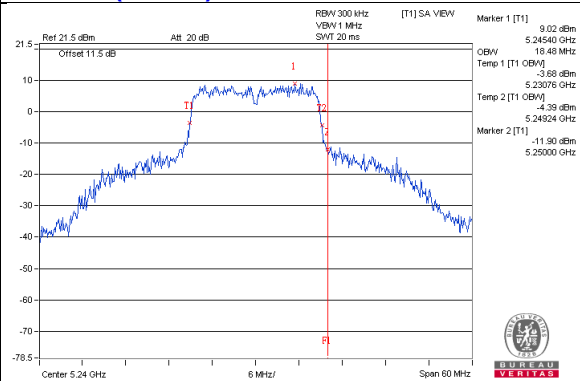

802.11ac (VHT40) : CH46

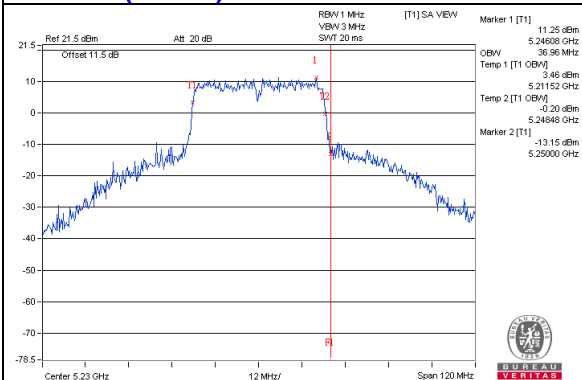

802.11ac (VHT80) : CH42

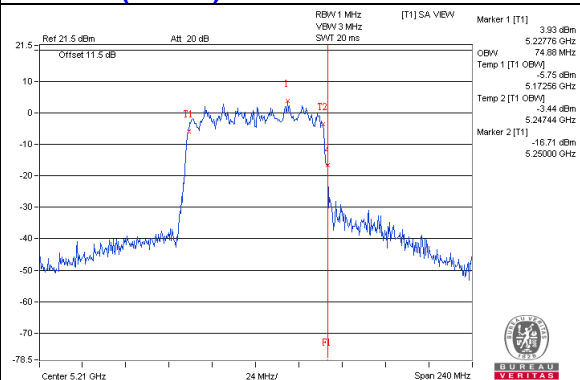

Spectrum Plot for near by DFS band (DFS is required, if 99% OCP straddle into U-NII-2C band)

802.11a : CH149

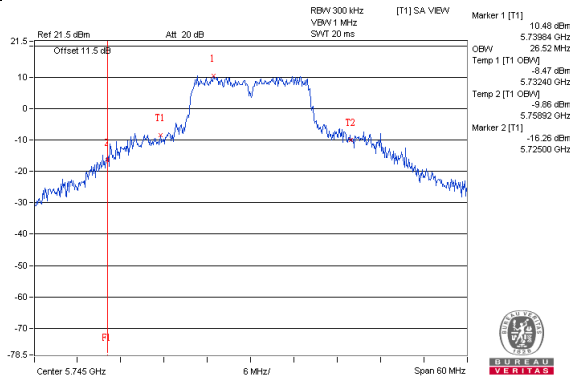

802.11a (VHT20) : CH149

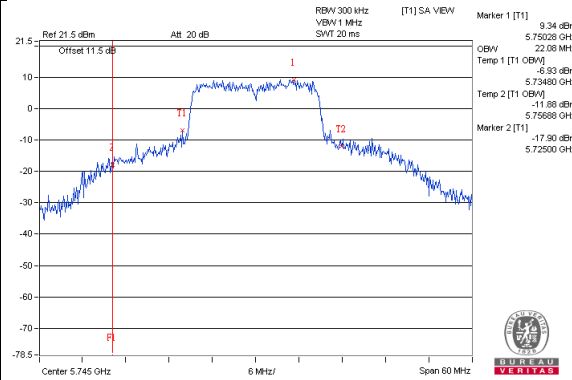

802.11ac (VHT40) : CH151

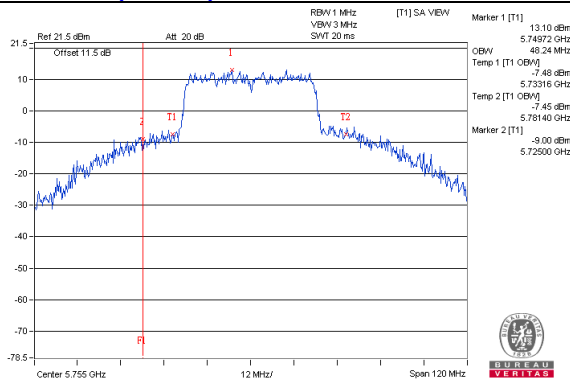

802.11ac (VHT80) : CH155

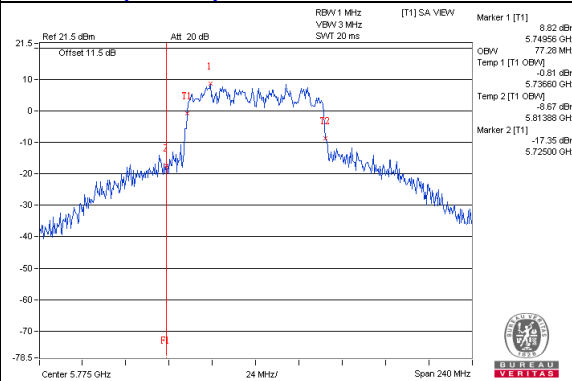

4.5 Peak Power Spectral Density Measurement

4.5.1 Limits of Peak Power Spectral Density Measurement

Operation Band	EUT Category		Limit
U-NII-1		Outdoor Access Point	17dBm/ MHz
		Fixed point-to-point Access Point	
		Indoor Access Point	
	√	Mobile and Portable client device	11dBm/ MHz
U-NII-2A		√	11dBm/ MHz
U-NII-2C		√	11dBm/ MHz
U-NII-3		√	30dBm/ 500kHz

4.5.2 Test Setup



4.5.3 Test Instruments

Refer to section 4.1.2 to get information of above instrument.

4.5.4 Test Procedure

For U-NII-1, U-NII-2A, U-NII-2C:

Using method SA-1

1. Set span to encompass the entire emission bandwidth (EBW) of the signal.
2. Set RBW = 1 MHz, Set VBW \geq 3 MHz, Detector = RMS
3. Sweep time = auto, trigger set to "free run".
4. Trace average at least 100 traces in power averaging mode.
5. Record the max value

For U-NII-3:

1. Set span to encompass the entire emission bandwidth (EBW) of the signal.
2. Set RBW = 300 kHz, Set VBW \geq 1 MHz, Detector = RMS
3. Use the peak marker function to determine the maximum power level in any 300 kHz band segment within the fundamental EBW.
4. Scale the observed power level to an equivalent value in 500 kHz by adjusting (reducing) the measured power by a bandwidth correction factor (BWCF) where $BWCF = 10\log(500\text{ kHz}/300\text{ kHz})$
5. Sweep time = auto, trigger set to "free run".
6. Trace average at least 100 traces in power averaging mode.
7. Record the max value

4.5.5 Deviation from Test Standard

No deviation.

4.5.6 EUT Operating Condition

Same as Item 4.3.6.

4.5.7 Test Results

802.11a

Chan.	Chan. Freq. (MHz)	PSD (dBm/MHz)	MAX. Limit (dBm/MHz)	Pass / Fail
36	5180	4.63	11.00	Pass
40	5200	6.21	11.00	Pass
48	5240	5.28	11.00	Pass
52	5260	5.52	11.00	Pass
60	5300	5.29	11.00	Pass
64	5320	4.74	11.00	Pass
100	5500	4.86	10.74	Pass
116	5580	5.45	10.74	Pass
140	5700	2.43	10.74	Pass

Note: 1. UNII-2C: Ant gain = 6.26dBi > 6dBi, therefore the limit needs to reduce, so the power limit shall be reduced to $11-(6.26-6) = 10.74\text{dBm}$

802.11ac (VHT20)

Chan.	Chan. Freq. (MHz)	PSD (dBm/MHz)	MAX. Limit (dBm/MHz)	Pass / Fail
36	5180	5.24	11.00	Pass
40	5200	6.21	11.00	Pass
48	5240	5.06	11.00	Pass
52	5260	5.42	11.00	Pass
60	5300	4.89	11.00	Pass
64	5320	4.29	11.00	Pass
100	5500	4.51	10.74	Pass
116	5580	4.87	10.74	Pass
140	5700	2.19	10.74	Pass

Note: 1. UNII-2C: Ant gain = 6.26dBi > 6dBi, therefore the limit needs to reduce, so the power limit shall be reduced to $11-(6.26-6) = 10.74\text{dBm}$

802.11ac (VHT40)

Chan.	Chan. Freq. (MHz)	PSD (dBm/MHz)	MAX. Limit (dBm/MHz)	Pass / Fail
38	5190	-1.72	11.00	Pass
46	5230	1.75	11.00	Pass
54	5270	1.85	11.00	Pass
62	5310	-2.93	11.00	Pass
102	5510	-1.42	10.74	Pass
110	5550	2.32	10.74	Pass
134	5670	0.29	10.74	Pass

Note: 1. UNII-2C: Ant gain = 6.26dBi > 6dBi, therefore the limit needs to reduce, so the power limit shall be reduced to $11-(6.26-6) = 10.74\text{dBm}$

802.11ac (VHT80)

Chan.	Chan. Freq. (MHz)	PSD (dBm/MHz)	MAX. Limit (dBm/MHz)	Pass / Fail
42	5210	-5.66	11.00	Pass
58	5290	-6.54	11.00	Pass
106	5530	-3.20	10.74	Pass
122	5610	-0.77	10.74	Pass

Note: 1. UNII-2C: Ant gain = 6.26dBi > 6dBi, therefore the limit needs to reduce, so the power limit shall be reduced to $11-(6.26-6) = 10.74\text{dBm}$

Spectrum Plot of Worst Value

802.11a / CH40

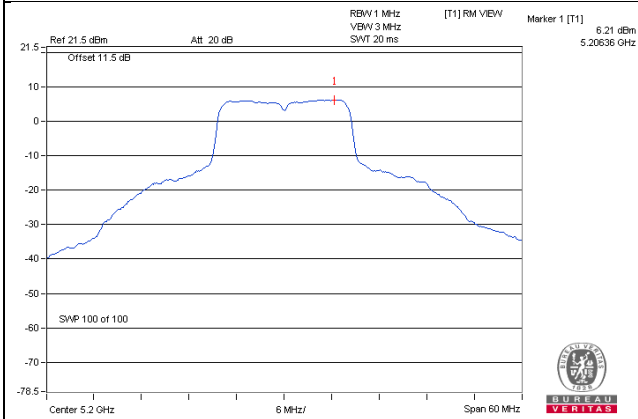

802.11ac (VHT20) / CH40

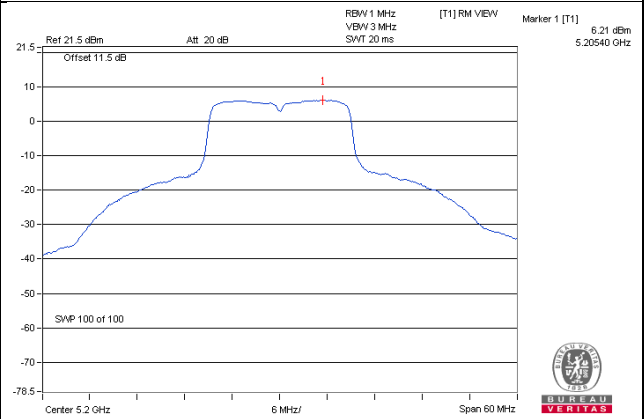

802.11ac (VHT40) / CH110

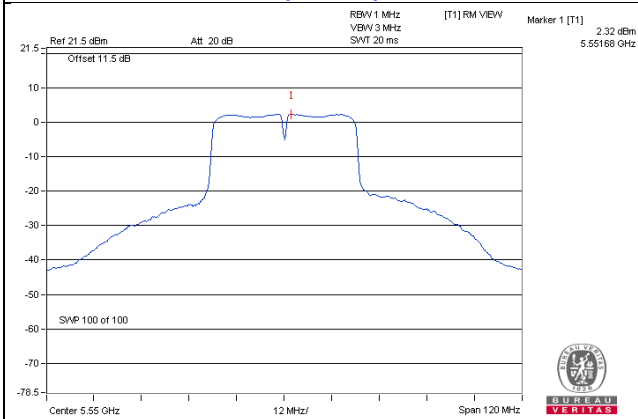

802.11ac (VHT80) / CH122

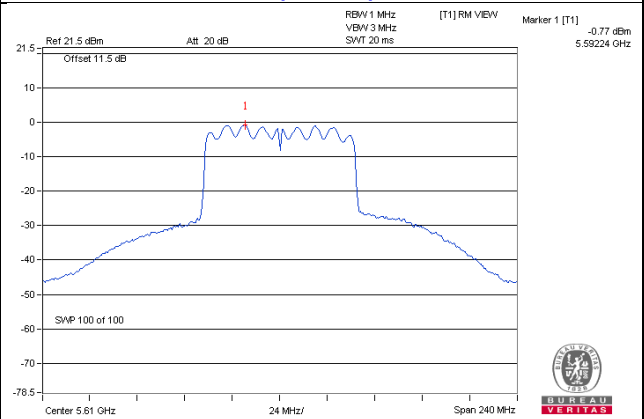

For U-NII-3:
802.11a

Chan.	Chan. Freq. (MHz)	PSD (dBm/300kHz)	PSD (dBm/500kHz)	Limit (dBm/500kHz)	Pass /Fail
149	5745	-1.37	0.85	28.88	Pass
157	5785	-1.66	0.56	28.88	Pass
165	5825	-2.09	0.13	28.88	Pass

Note: 1. UNII-3: Ant gain = 7.12Bi > 6dBi, therefore the limit needs to reduce, so the power limit shall be reduced to $30-(7.12-6) = 28.88\text{dBm}$.

802.11ac (VHT20)

Chan.	Chan. Freq. (MHz)	PSD (dBm/300kHz)	PSD (dBm/500kHz)	Limit (dBm/500kHz)	Pass /Fail
149	5745	-2.53	-0.31	28.88	Pass
157	5785	-2.11	0.11	28.88	Pass
165	5825	-2.91	-0.69	28.88	Pass

Note: 1. UNII-3: Ant gain = 7.12Bi > 6dBi, therefore the limit needs to reduce, so the power limit shall be reduced to $30-(7.12-6) = 28.88\text{dBm}$.

802.11ac (VHT40)

Chan.	Chan. Freq. (MHz)	PSD (dBm/300kHz)	PSD (dBm/500kHz)	Limit (dBm/500kHz)	Pass /Fail
151	5755	-5.13	-2.91	28.88	Pass
159	5795	-5.20	-2.98	28.88	Pass

Note: 1. UNII-3: Ant gain = 7.12Bi > 6dBi, therefore the limit needs to reduce, so the power limit shall be reduced to $30-(7.12-6) = 28.88\text{dBm}$.

802.11ac (VHT80)

Chan.	Chan. Freq. (MHz)	PSD (dBm/300kHz)	PSD (dBm/500kHz)	Limit (dBm/500kHz)	Pass /Fail
155	5745	-8.78	-6.56	28.88	Pass

Note: 1. UNII-3: Ant gain = 7.12Bi > 6dBi, therefore the limit needs to reduce, so the power limit shall be reduced to $30-(7.12-6) = 28.88\text{dBm}$.

Spectrum Plot of Worst Value

802.11a / CH149

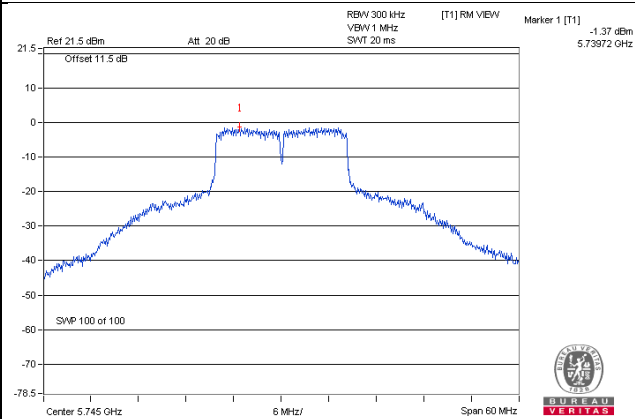

802.11ac (VHT20) / CH157

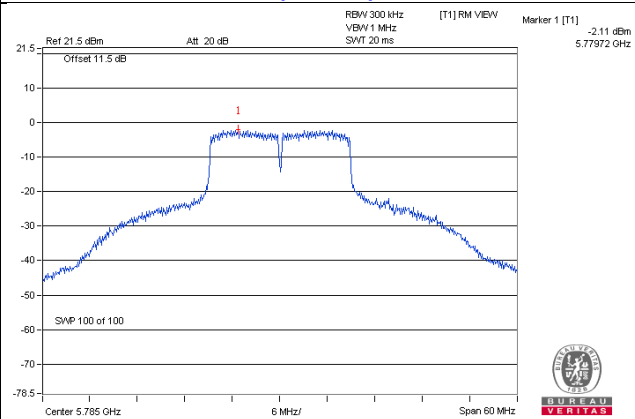

802.11ac (VHT40) / CH151

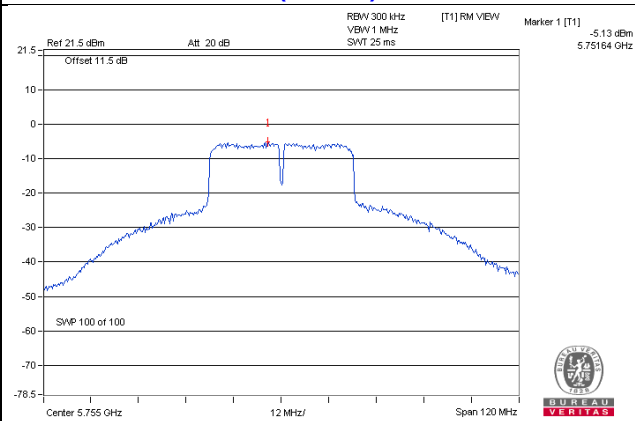

802.11ac (VHT80) / CH155

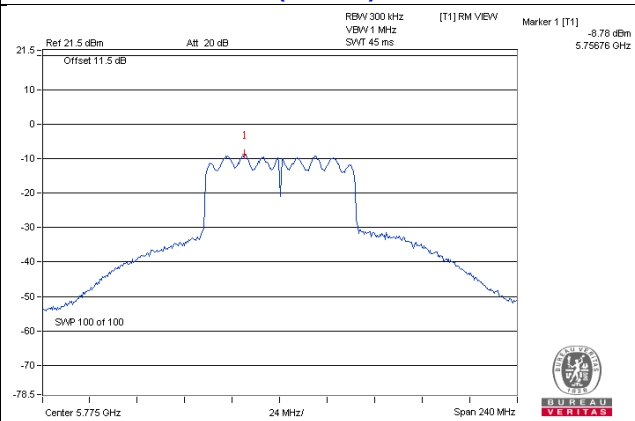

4.6 Frequency Stability Measurement

4.6.1 Limits of Frequency Stability Measurement

The frequency of the carrier signal shall be maintained within band of operation

4.6.2 Test Setup

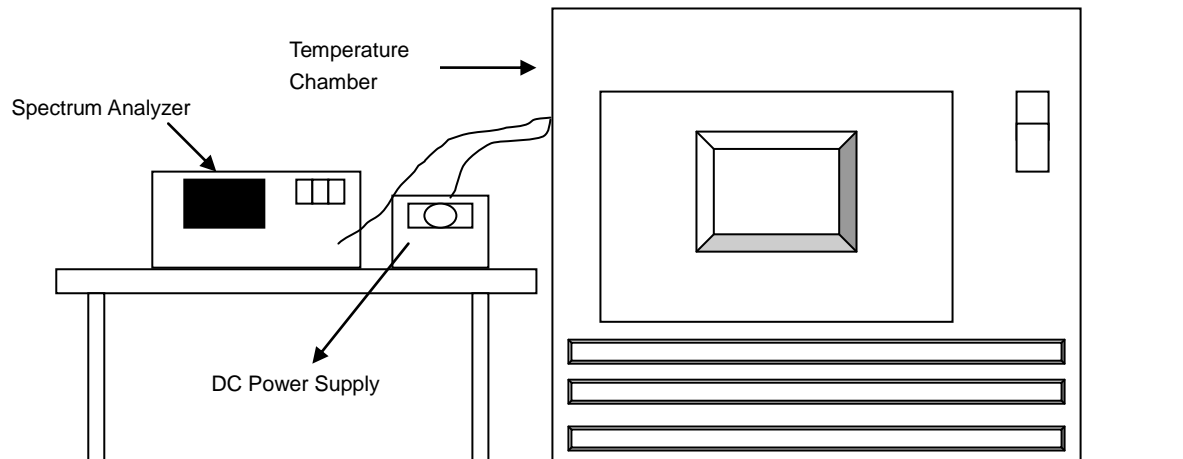

4.6.3 Test Instruments

Refer to section 4.1.2 to get information of above instrument.

4.6.4 Test Procedure

- The EUT was placed inside the environmental test chamber and powered by nominal DC voltage.
- Turn the EUT on and couple its output to a spectrum analyzer.
- Turn the EUT off and set the chamber to the highest temperature specified.
- Allow sufficient time (approximately 30 min) for the temperature of the chamber to stabilize, turn the EUT on and measure the operating frequency after 2, 5, and 10 Minutes.
- Repeat step 2 and 3 with the temperature chamber set to the lowest temperature.
- The test chamber was allowed to stabilize at +20 degree C for a minimum of 30 Minutes. The supply voltage was then adjusted on the EUT from 85% to 115% and the frequency record.

4.6.5 Deviation from Test Standard

No deviation.

4.6.6 EUT Operating Condition

Set the EUT transmit at un-modulation mode to test frequency stability.

4.6.7 Test Results

Frequency Stability Versus Temp.									
Operating Frequency: 5180 MHz									
TEMP. (°C)	Power Supply (Vdc)	0 Minute		2 Minutes		5 Minutes		10 Minutes	
		Measured Frequency (MHz)	Pass/Fail	Measured Frequency (MHz)	Pass/Fail	Measured Frequency (MHz)	Pass/Fail	Measured Frequency (MHz)	Pass/Fail
50	3.3	5179.9993	PASS	5179.9959	PASS	5179.9984	PASS	5179.9967	PASS
40	3.3	5179.9806	PASS	5179.9808	PASS	5179.9815	PASS	5179.9807	PASS
30	3.3	5179.9805	PASS	5179.9785	PASS	5179.9816	PASS	5179.9817	PASS
20	3.3	5180.0067	PASS	5180.0083	PASS	5180.0081	PASS	5180.0077	PASS
10	3.3	5180.0238	PASS	5180.0265	PASS	5180.024	PASS	5180.0233	PASS
0	3.3	5179.9868	PASS	5179.9898	PASS	5179.9892	PASS	5179.9861	PASS
-10	3.3	5180.0262	PASS	5180.0248	PASS	5180.0232	PASS	5180.0257	PASS
-20	3.3	5179.9841	PASS	5179.9839	PASS	5179.9822	PASS	5179.986	PASS
-30	3.3	5179.9764	PASS	5179.9777	PASS	5179.9792	PASS	5179.9775	PASS

Frequency Stability Versus Voltage									
Operating Frequency: 5180 MHz									
TEMP. (°C)	Power Supply (Vdc)	0 Minute		2 Minutes		5 Minutes		10 Minutes	
		Measured Frequency (MHz)	Pass/Fail	Measured Frequency (MHz)	Pass/Fail	Measured Frequency (MHz)	Pass/Fail	Measured Frequency (MHz)	Pass/Fail
20	3.795	5180.0074	PASS	5180.0086	PASS	5180.0073	PASS	5180.0078	PASS
	3.3	5180.0067	PASS	5180.0083	PASS	5180.0081	PASS	5180.0077	PASS
	2.805	5180.007	PASS	5180.0076	PASS	5180.0074	PASS	5180.0077	PASS

4.7 6dB Bandwidth Measurement

4.7.1 Limits of 6dB Bandwidth Measurement

The minimum of 6dB Bandwidth Measurement is 0.5MHz.

4.7.2 Test Setup

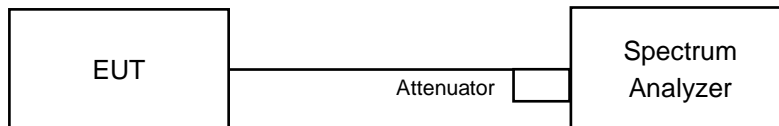

4.7.3 Test Instruments

Refer to section 4.1.2 to get information of above instrument.

4.7.4 Test Procedure

MEASUREMENT PROCEDURE REF

- Set resolution bandwidth (RBW) = 100kHz
- Set the video bandwidth (VBW) $\geq 3 \times$ RBW, Detector = Peak.
- Trace mode = max hold.
- Sweep = auto couple.
- Measure the maximum width of the emission that is constrained by the frequencies associated with the two amplitude points (upper and lower) that are attenuated by 6 dB relative to the maximum level measured in the fundamental emission

4.7.5 Deviation from Test Standard

No deviation.

4.7.6 EUT Operating Condition

The software provided by client to enable the EUT under transmission condition continuously at lowest, middle and highest channel frequencies individually.

4.7.7 Test Results

802.11a

Channel	Frequency (MHz)	6dB Bandwidth (MHz)	Minimum Limit (MHz)	Pass / Fail
149	5745	16.51	0.5	PASS
157	5785	16.53	0.5	PASS
165	5825	16.52	0.5	PASS

802.11ac (VHT20)

Channel	Frequency (MHz)	6dB Bandwidth (MHz)	Minimum Limit (MHz)	Pass / Fail
149	5745	17.74	0.5	PASS
157	5785	17.76	0.5	PASS
165	5825	17.69	0.5	PASS

802.11ac (VHT40)

Channel	Frequency (MHz)	6dB Bandwidth (MHz)	Minimum Limit (MHz)	Pass / Fail
151	5755	36.54	0.5	PASS
159	5795	36.55	0.5	PASS

802.11ac (VHT80)

Channel	Frequency (MHz)	6dB Bandwidth (MHz)	Minimum Limit (MHz)	Pass / Fail
155	5775	75.71	0.5	PASS

Spectrum Plot of Worst Value

802.11a / CH149

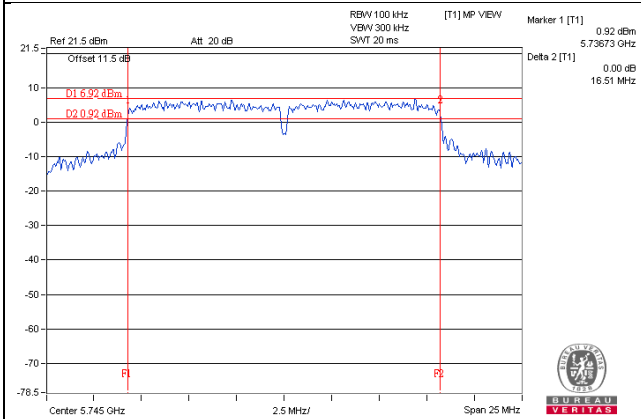

802.11ac (VHT20) / CH165

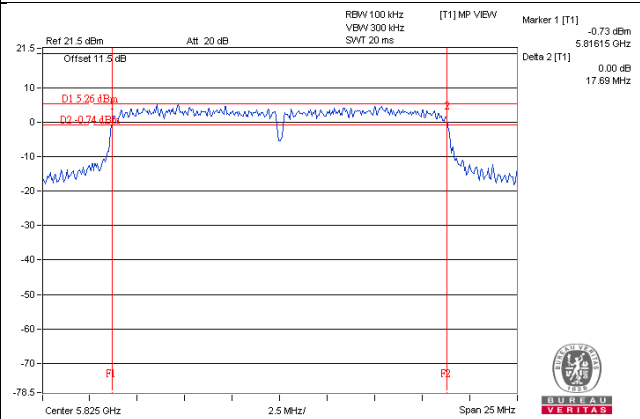

802.11ac (VHT40) / CH151

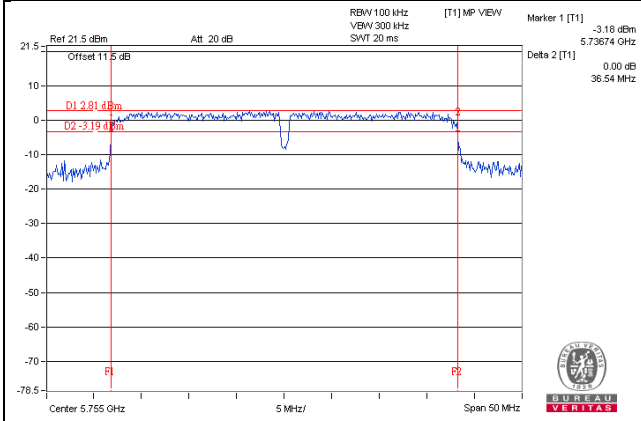

802.11ac (VHT80) / CH155

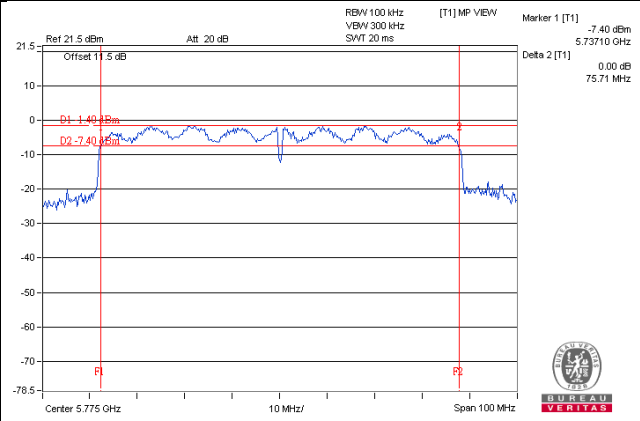

5 Pictures of Test Arrangements

Please refer to the attached file (Test Setup Photo).

Annex A- Radiated Out of Band Emission (OOBE) Measurement (For U-NII-3 band)

802.11a

CH 149 5745 MHz

Horizontal

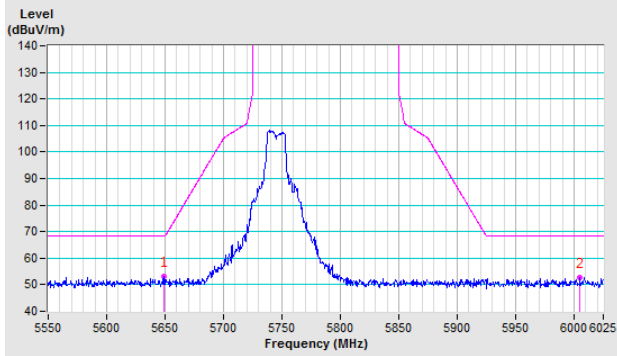

Vertical

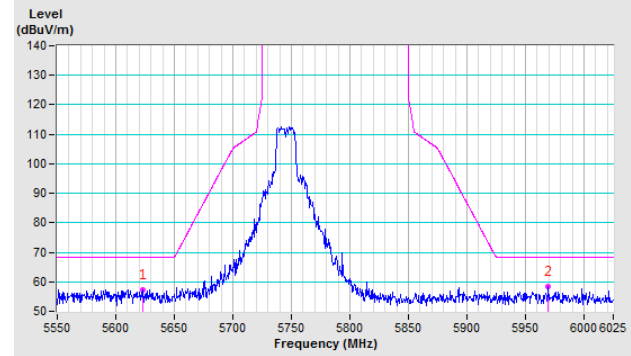

CH 157 5785 MHz

Horizontal

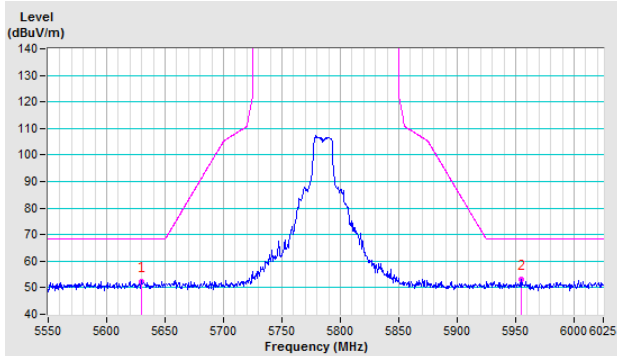

Vertical

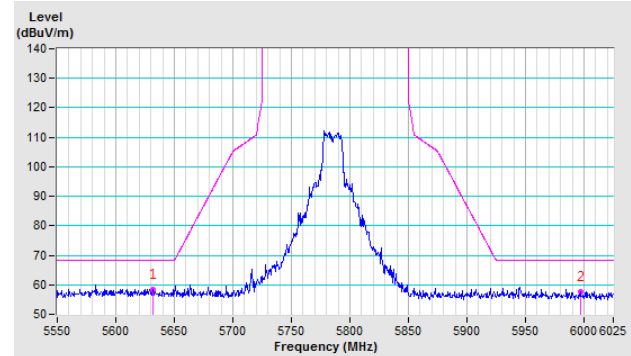

CH 165 5825 MHz

Horizontal

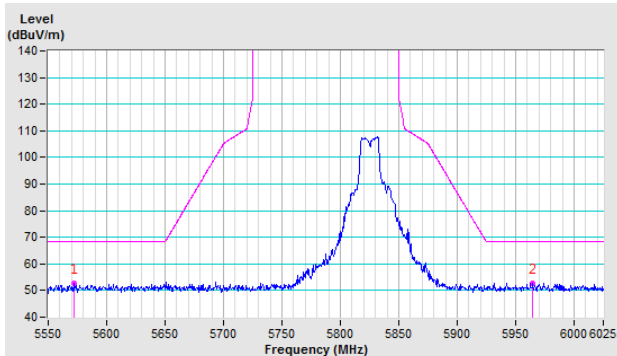

Vertical

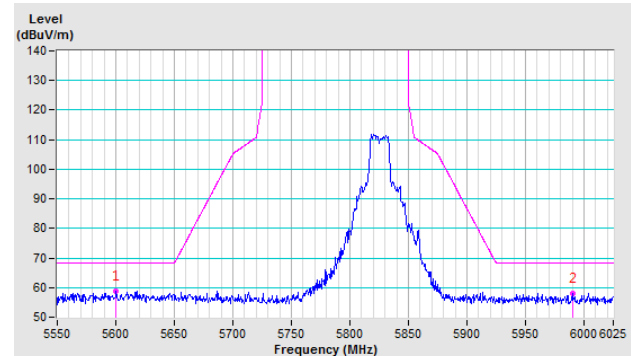

802.11ac (VHT20)

CH 149 5745 MHz

Horizontal

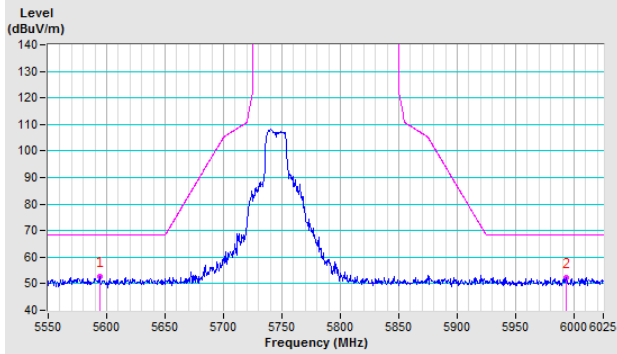

Vertical

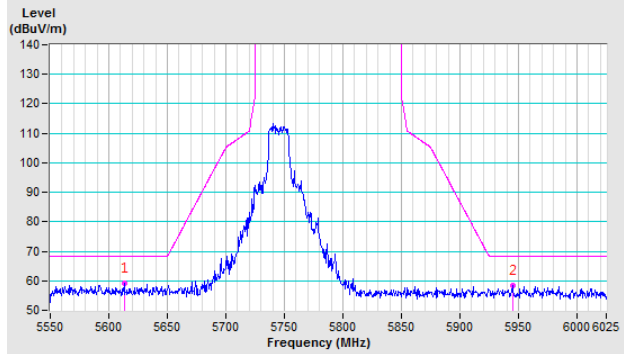

CH 157 5785 MHz

Horizontal

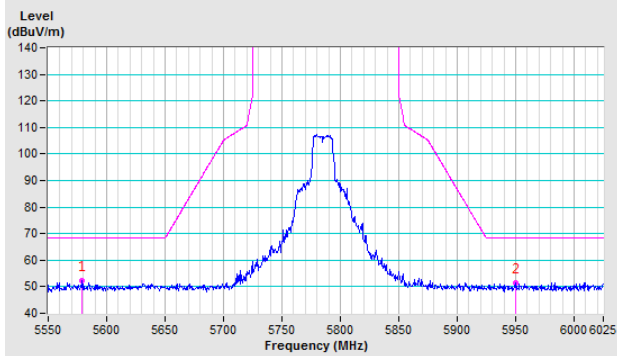

Vertical

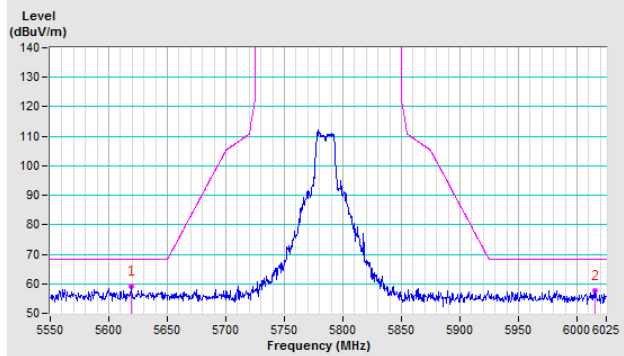

CH 165 5825 MHz

Horizontal

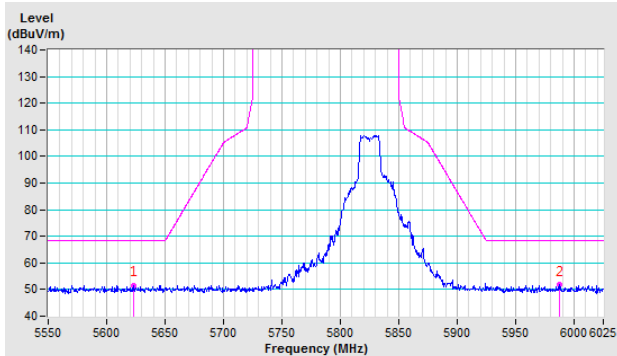

Vertical

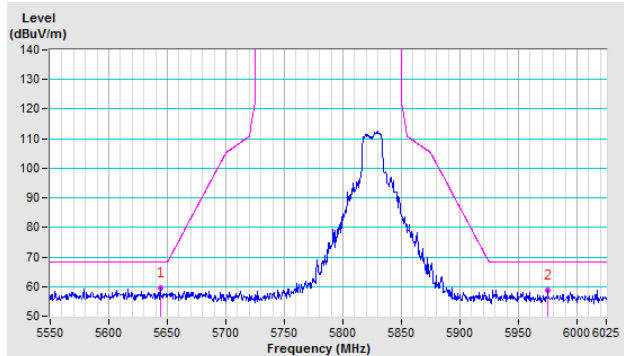

802.11ac (VHT40)

CH 151 5755 MHz

Horizontal

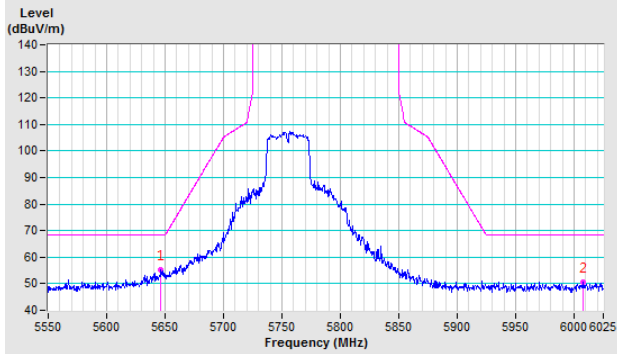

Vertical

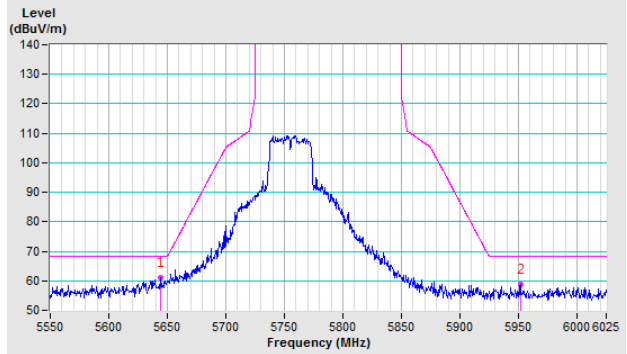

CH 159 5795 MHz

Horizontal

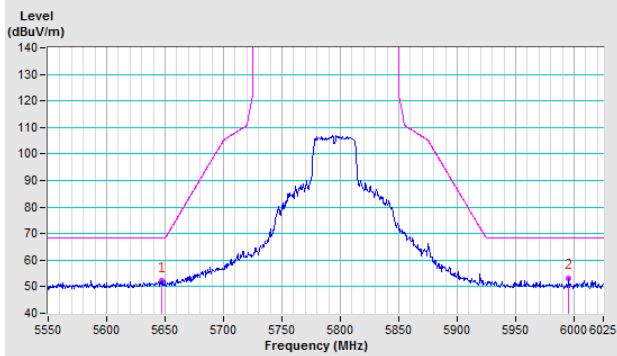

Vertical

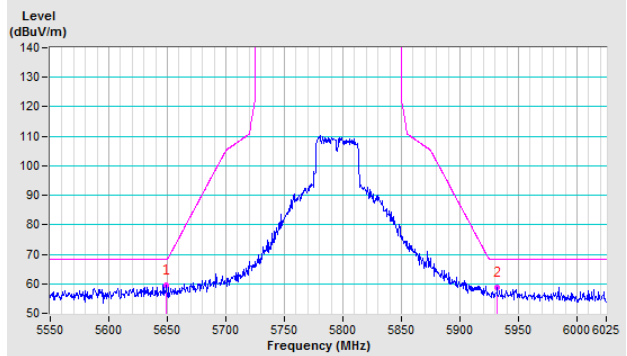

802.11ac (VHT80)

CH 155 5775 MHz

Horizontal

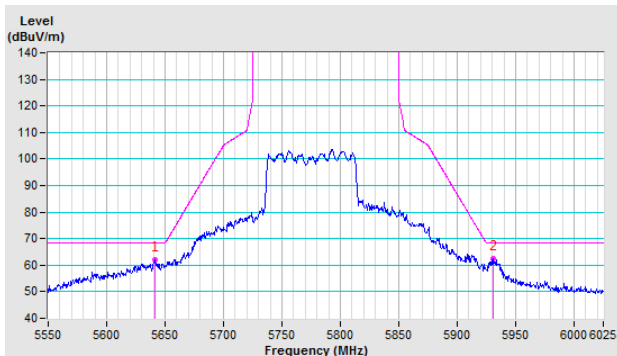

Vertical

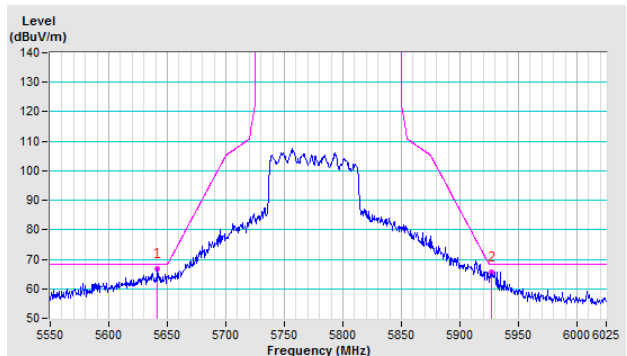

Appendix – Information on the Testing Laboratories

We, Bureau Veritas Consumer Products Services (H.K.) Ltd., Taoyuan Branch, were founded in 1988 to provide our best service in EMC, Radio, Telecom and Safety consultation. Our laboratories are FCC recognized accredited test firms and accredited according to ISO/IEC 17025.

If you have any comments, please feel free to contact us at the following:

Linko EMC/RF Lab

Tel: 886-2-26052180

Fax: 886-2-26051924

Hsin Chu EMC/RF/Telecom Lab

Tel: 886-3-6668565

Fax: 886-3-6668323

Hwa Ya EMC/RF/Safety Lab

Tel: 886-3-3183232

Fax: 886-3-3270892

Email: service.adt@tw.bureauveritas.com

Web Site: www.bureauveritas-adt.com

The address and road map of all our labs can be found in our web site also.

--- END ---