

# User's Manual

# Introduction







Thank you very much for purchasing this WristableGPS.

To use the device correctly, read this User's Manual.

The illustrations and screens shown in the User's Manual are for the SS-700.

By using a built-in GPS sensor and stride sensor, this device can measure running distance and pace. You can also upload recorded data to a dedicated Web site allowing you to look back over previous workouts. You can then make more effective plans and gain more enjoyment from your running.

## About descriptions in this User's Manual

	Indicates related information and helpful hints.
	Indicates operations that must be performed when using the device.
	Indicates menu items displayed on the screen of the device. Example: [MENU] - [Settings] - [Scrn.Settings]
	Indicates the device buttons.
	Indicates that the current explanation continues on the next page (displayed at the bottom right of the page).
	Indicates reference pages that contain related information and more detailed explanations. Click the page number to jump to the target page.

### Trademarks

EPSON and EXCEED YOUR VISION are registered trademarks of the Seiko Epson Corporation.

The official name for Windows® is the Microsoft® Windows® Operating System.

Windows® 7 is a product name of the Microsoft Corporation in the United States of America.

Windows is a registered trademark of the Microsoft Corporation in the United States of America and other countries.

Other product names are the trademarks or registered trademarks of their respective companies.

### Caution:

- Unapproved copying of part or all of this guide is strictly forbidden.
- The content of this guide may be changed without prior notice.

# Measuring Using this Device

## Three measurement functions

This device has three types of measurement function; chronograph, exercise, and interval.

### ◆ Chronograph (→ [P. 27](#))



This function allows you to measure running data such as distance and time.

You can measure split\*<sup>1</sup> and lap times\*<sup>2</sup>, as well as using the GPS signal to measure distance and pace (→ [P. 21](#)).

\*1 Split time : Progress time from start to specific point

\*2 Lap time : Time for each lap

You can use [Recall] to check recorded measurement data (→ [P. 55](#)).



### ◆ Exercise (→ [P. 35](#))



This function allows you to set a target pace and check how close you are to your target while exercising.

This is useful when you want to maintain a steady target pace.

When you exceed your target pace, the icon "😊 GOOD" is displayed.



### ◆ Interval (→ [P. 43](#))

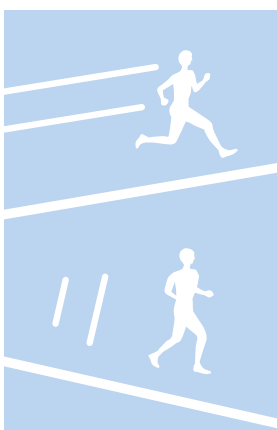

This function allows you to perform interval training\*<sup>3</sup>.

\*3 Interval training:

Allows you to repeat sets of light and hard exercise to increase your athletic ability.

An exercise menu is created using combinations of hard (sprint) and light (rest) exercise.

An alarm sounds when it is time to change between sprinting and resting.



# Contents

Introduction.....	2
Measuring Using this Device .....	3
Using this Device Safely.....	7

## Chapter 1

<b>Getting Ready .....</b>	<b>12</b>
1-1 Checking the supplied items .....	13
1-2 Charging .....	14
1-3 Basic operations.....	18
1-4 Measurable items .....	21
1-5 Measuring function for the device.....	23
1-6 Setting GPS (GPS search) .....	24

## Chapter 2

<b>Using the Chronograph Function .....</b>	<b>26</b>
2-1 About the chronograph function.....	27
2-2 Using the chronograph screen.....	28
2-3 Measuring .....	30

## Chapter 3

<b>Using the Exercise Function .....</b>	<b>34</b>
3-1 About the exercise function.....	35
3-2 Setting the target pace .....	36
3-3 Using the exercise screen.....	38
3-4 Starting the exercise function .....	39

## Chapter 4

<b>Using the Interval Function .....</b>	<b>42</b>
4-1 About the interval function.....	43
4-2 Setting interval conditions .....	44
4-3 Using the interval screen.....	47
4-4 Starting interval exercises .....	49

## Chapter 5

<b>Checking Measurement Data Using the Recall Function .....</b>	<b>54</b>
5-1 Measurement data that can be checked in recall.....	55
5-2 Checking measurement data.....	56

Chapter 6

**Measuring Distance and Pace with the Stride Sensor (SS-700/SS-500 Only) ... 58**

- 6-1 About the stride sensor.....59
- 6-2 Enabling the stride sensor .....60

Chapter 7

**Measuring Heart Rate (SS-700/SS-500 Only)..... 62**

- 7-1 About heart rate measurements .....63
- 7-2 Wearing the HR sensor set .....64
- 7-3 Pairing.....65
- 7-4 Enabling the HR sensor .....67
- 7-5 Replacing the battery for the HR sensor .....70

Chapter 8

**About Settings ..... 72**

- 8-1 About the settings function .....73
- 8-2 Screen settings.....75
- 8-3 Auto lap.....79
- 8-4 Auto light .....81
- 8-5 Auto pause.....83
- 8-6 Alarm .....85
- 8-7 System settings.....95
- 8-8 Clear history .....98
- 8-9 User settings..... 101

Chapter 9

**Usage Guide (Screen Settings According to Your Needs)..... 106**

- 9-1 Settings on the chronograph screen ..... 107
- 9-2 Noting distance and pace while running ..... 108
- 9-3 Noting pitch and stride while running (SS-700/SS-500 only) ..... 110
- 9-4 Noting targets while running ..... 111
- 9-5 Noting heart rate while running (SS-700/SS-500 only) ..... 113

Chapter 10

**Data Management Using the Web Application ..... 115**

- 10-1 Installing the NR Uploader ..... 116
- 10-2 Connecting the device to a computer and using NeoRun ..... 119
- 10-3 Updating the driver software ..... 121

Chapter 11

**Maintenance ..... 125**

11-1 Performing maintenance..... 126

11-2 Replacing the battery..... 127

11-3 Product specifications..... 128

Chapter 12

**Troubleshooting ..... 130**

12-1 Dealing with problems ..... 131

12-2 Resetting the system ..... 135

12-3 Contacting us about this product..... 136

12-4 After service ..... 137

12-5 Certification information..... 138

Chapter 13

**Index ..... 139**

# Using this Device Safely

To use this device safely, make sure you read the User's Manual before use. If you do not follow the content of the User's Manual, a problem or accident could occur.

- When using this device abroad, check conditions such as laws and regulations for the country/region.
- This is not a medical device. Use for exercising only.



## VCCI Class B Information Technology Device





This device is a class B information technology device. This device is designed for home use, but interference could occur when using in close proximity to radios or television antennas.



## Symbols in this Manual

This User's Manual uses the following symbols to prevent injury to the user or to others, or damage to property when using this device, as well as preventing dangerous usage.

Read the guide after understanding these symbols.

 <b>Warning</b>	Ignoring these instructions or mishandling this device could cause serious injury or death.
 <b>Caution</b>	Ignoring these instructions or mishandling this device could cause injury or damage to property.
	This symbol indicates operations (instructions and actions) you must perform.
	This symbol indicates actions (forbidden actions) that must not be performed.

# Notes on Usage

## About the Device and Accessories

### **Warning**



Exercise according to your own physical condition. It is dangerous to exercise suddenly or excessively. If you feel nauseous or if your physical condition alters while exercising, stop exercising and contact a doctor.

Do not watch the device too closely while exercising. Otherwise you could fall or cause a traffic accident. Pay close attention to your surroundings while using the device.

Do not use while scuba diving.



This device is made using precision parts and electronic components. Do not use or store in the following locations. Otherwise an electric shock, fire, problem, or malfunction could occur.

- Locations subject to high temperatures or humidity
- Volatile locations
- Locations subject to smoke and dust
- Locations near fire
- Locations close to magnetic fields (near speakers and so on)

Do not disassemble or perform repairs yourself. Otherwise an electric shock or an accident could occur.

Do not leave this device in reach of children.

### **Caution**



If you suffer from any allergies or rashes when wearing the device, stop using it immediately and contact a medical specialist such as a dermatologist.

The device has enhanced (practical) waterproofing. Although you can use the device in water, such as when swimming, do not perform button operations when it is wet. This may effect the quality of the waterproofing.



Do not hold the device directly under high pressure water from a faucet. Water pressure from a faucet is high and could effect the quality of the waterproofing.

Do not use in the bath or in a sauna. Steam and materials in soap and in hot springs could effect the quality of the waterproofing or cause rust.



# Notes on Usage

## About the Cradle and the AC Adapter

### **Warning**



Make sure the plug is fully inserted. Otherwise an electric shock or fire could occur.

When you are not using the AC adapter, unplug it from the electrical outlet. Also, make sure you clean the plug periodically.

If you hear thunder, unplug it from the electrical outlet immediately. Otherwise an electric shock could occur.

Note the following points when handling the AC adapter. Otherwise an electric shock or fire could occur.

- Do not use it in locations subject to rain or water
- Do not cover it with bedding and so on



Do not touch the power plug with wet hands. Otherwise an electric shock could occur.

Do not plug the AC adapter into an outlet that is being used by many other devices.

Do not use the AC adapter or USB cable if they are damaged. Otherwise a problem or fire could occur. If they are damaged, contact a repair center.

Do not use them if you notice any abnormalities such as smoke, strange odors or noises. Otherwise a fire could occur. If any abnormalities occur, unplug from the electrical outlet immediately, and contact a repair center.

Do not use if any foreign substances or liquids such as water get inside any of the devices. Otherwise an electric shock or fire could occur. Unplug from the electrical outlet immediately, and contact a repair center.

Do not use the USB cable if any foreign substances such as dust are stuck to the connector. Otherwise a fire could occur.

Do not use the AC adapter and cradle to charge any other devices. Also, do not charge the device with any thing except for the AC adapter and cradle. Otherwise problems, an electric shock, or fire could occur.

# Notes on Usage

## About the HR Sensor (SS-700/SS-500 Only)

### Read when using the HR (heart rate) sensor function.

This device contains a wireless function. When using the HR sensor, this function wirelessly sends and receives heart rate measurement data to the device.

This device has been classified as a small electronic data communication system based on Radio Law. Therefore, this device does not require a radio station license. The following acts may be punishable by law.

- Disassembling or remodeling the device
- Removing the verification or certification number for the device

\* When using this device abroad, check conditions such as laws and regulations for the country/region.

### Frequency

This device uses frequency 2.457 GHz in the 2.4 GHz band.

Wireless devices may use the same frequency.

Note the following points to avoid wireless interference with other wireless devices.

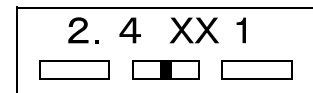

### Precautions when performing wireless communication

This device operates on the 2.4 GHz band. This device operates in the same frequency bandwidth as industrial, scientific, and medical devices such as microwave ovens and mobile object identification (RF-ID) systems (licensed premises radio stations, amateur, and unlicensed specified low-power radio stations (hereafter "other radio stations")) used in factory production lines.

1. Before using this device, make sure there are no "other radio stations" being used in the vicinity.
2. If this device causes RF interference between the device and "other radio stations", promptly move to a different location, stop using the device.
3. If you have any questions, or if other problems occur, contact our information center.

## Warning



If you notice any abnormalities on your skin and so on, stop using the device immediately and contact a specialist.

In areas in which usage is restricted, such as on airplanes and in hospitals, follow the rules and regulations provided (such as in-flight announcements).



Do not use the device if you have a surgically implanted pacemaker.

Do not bring the device into an operating room, intensive care unit, and so on, and do not use the device near medical equipment. Radio waves from the device may interfere with electronic medical equipment causing the equipment to malfunction and cause an accident.

## Notes on Usage

### About the HR Sensor Battery

Note the following points regarding the HR sensor battery.

#### **Warning**



If the battery is accidentally swallowed, contact your doctor immediately.

#### **Caution**



Be careful not to injure yourself when replacing the battery.

When disposing of the battery, follow your local laws and regulations.



When replacing the battery, only use the type of battery specified. Also, make sure the polarities (+ and -) are correct.

Do not place the battery or the HR sensor with a battery installed into a fire.

## Notes on Storage

#### **Caution**



Do not place in a location subject to magnetic fields or electromagnetic waves. Otherwise, data may be corrupted or lost.

Do not leave the device unattended in locations where it could come into contact with chemicals, or in locations where chemical substances are emitted. If any spray-on liquid such as gasoline, nail varnish, or cosmetics, as well as cleaning liquid, toilet detergent, adhesives, and so on, come into contact with the device or the strap, they could cause discoloring or damage.

# Getting Ready

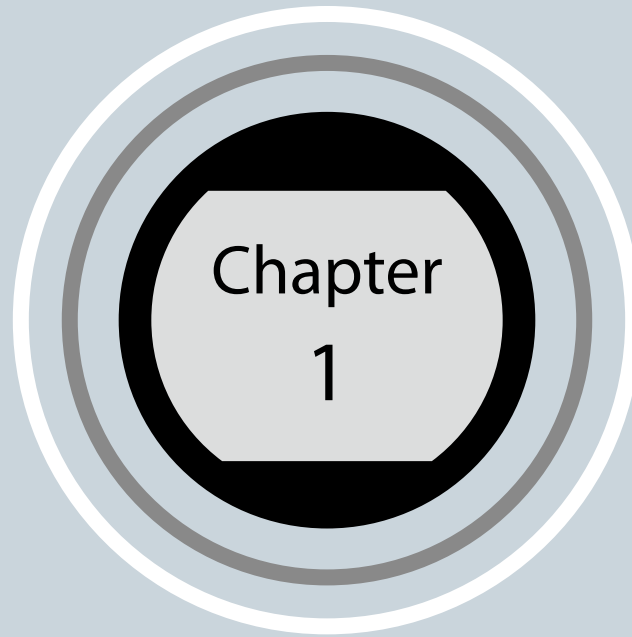

- 
- 1-1 Checking the supplied items
  - 1-2 Charging
  - 1-3 Basic operations
  - 1-4 Measurable items
  - 1-5 Measuring function for the device
  - 1-6 Setting GPS (GPS search)
-

## 1-1 Checking the supplied items

Make sure you check that all of the following items have been supplied with this product. If there is anything missing, contact your local dealer.

### Main device

(One of the models that you purchased.)

SS-700

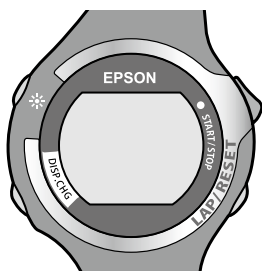

SS-500



SS-300



### Cradle

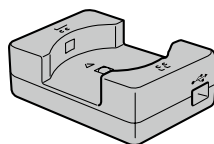

### AC adapter

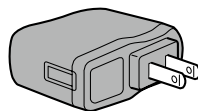

### USB cable

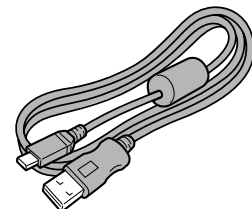

**HR sensor set**  
(HR belt and HR sensor)  
Only with the SS-700

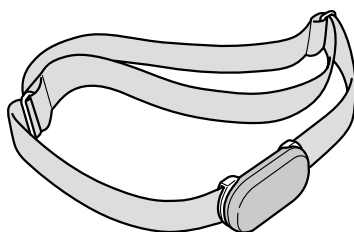

**Paper manual (Japanese only)**  
(warranty)

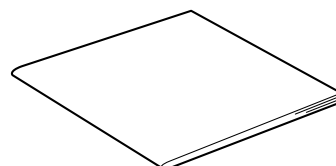

\* The warranty is on the back cover.

## 1-2 Charging

### ■ During use

**Do not place the device in the cradle if it is wet from water or sweat.**

Otherwise the contact points on the cradle and the device could corrode and cause a malfunction.

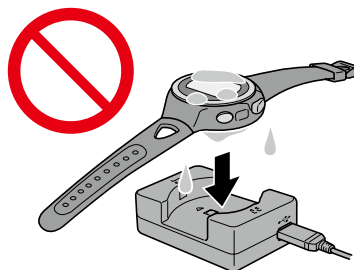

If the device is dirty from water or sweat, use low pressure water from a faucet to wash the contact points, wipe away most of the water with a towel and so on, and then let it dry naturally before placing it in the cradle.

For more details about daily maintenance, see “Maintenance” (→ [P. 125](#)).

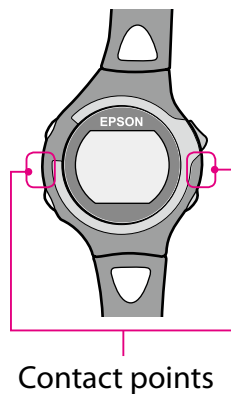

Contact points

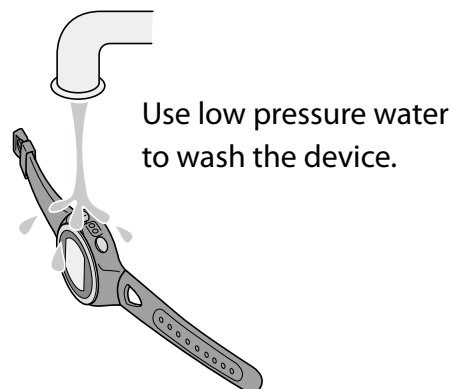

## ■ Charging

---

Charge this device when using it for the first time.

- 1 Connect the cradle and the AC adapter with the USB cable.

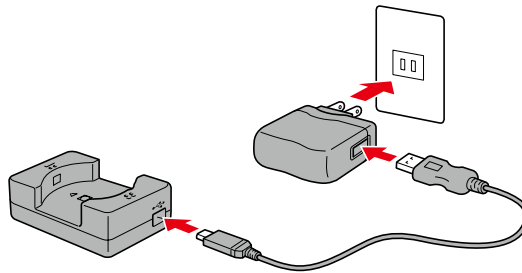

- 2 Place the product into the cradle.

Check that the direction of the EPSON logo on the device matches the EPSON logo on the cradle, and then press until it is fixed in place.

Carefully press the device straight down.

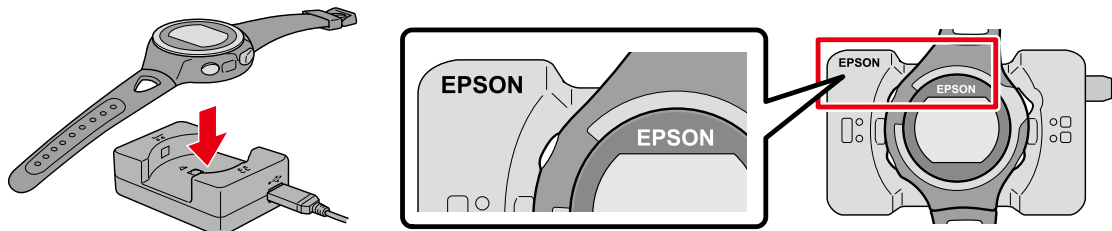

The device cannot be placed in the opposite direction.

The cradle may be damaged if the device is forced into it.

When the device is placed in the correct direction, [Charging] is displayed.



**3** When charging is complete, remove the device from the cradle.

When charging is complete, the display changes from [Charging] to [Charged].

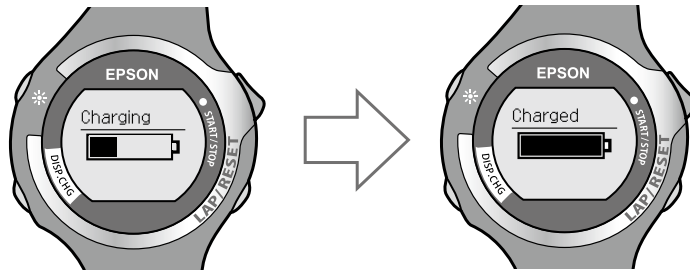

Although the standard charge time from completely empty to fully charged is 2.5 to 3.5 hours, this may change depending on the usage situation and environment.

Hold the cradle firmly when you remove the device.

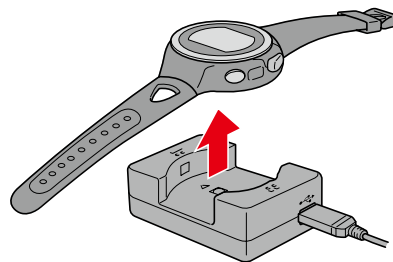

You can check how much charge remains from the icon at the top right of the time display.

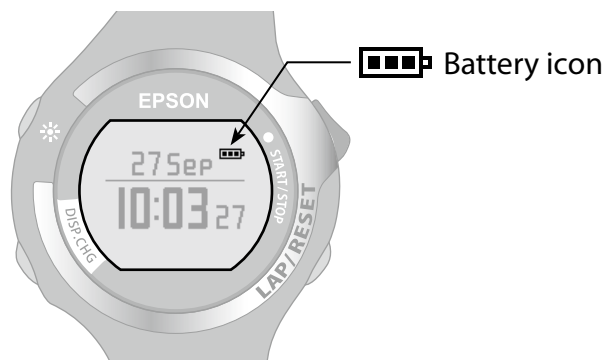

Battery icon					
Hours remaining*	GPS On, HR sensor Off	10 to 14 hours	5 to 10 hours	2 to 5 hours	0 to 2 hours
	GPS On, HR sensor On	7 to 10 hours	3 to 7 hours	1.5 to 3 hours	0 to 1.5 hours

\* Standard times in which the Chronograph, Exercise, and Interval functions can be used while receiving a GPS signal.

The usage time differs depending on the status of the HR sensor.

There is no difference in usage time if the stride sensor is on or off.

Using the light frequently makes the battery run low.

Continued



#### Tips

- When the battery is running low, the time display screen is displayed even when the measurement screen or [Menu] screen are selected, and the buttons do not function. Nothing is displayed when the battery runs out. Charge the battery right away.
- Even if the battery runs out, measurement data is stored in the main memory.
- Once charging is complete, an over-charge function is activated to prevent the battery from being over charged. The device will not be damaged even if you continue to charge the battery.
- Charge in an environment with a room temperature of 0 to 35°C. In any other environment [Charge Err.] is displayed, and charging stops. When the internal temperature returns to a suitable temperature, charging restarts.
- Even if you are not using the device, make sure you charge it once every six months. If the device is not used for extended periods of time, the performance of the rechargeable battery may decrease.



Charge err Screen

## 1-3 Basic operations

To change the display to English, set [Menu] - [Settings] - [Sys. Settings] - [Language] to [English].

### ■ Button names and basic operations

You can select the measurement screen and the settings screen from the [Menu]. This section explains the button names and operations when each screen is selected. The function for each button changes depending on which screen is displayed.

#### Basic operations

Press **A** to change the screen display.

If you hold down **A** for at least two seconds, the previous screen is displayed.

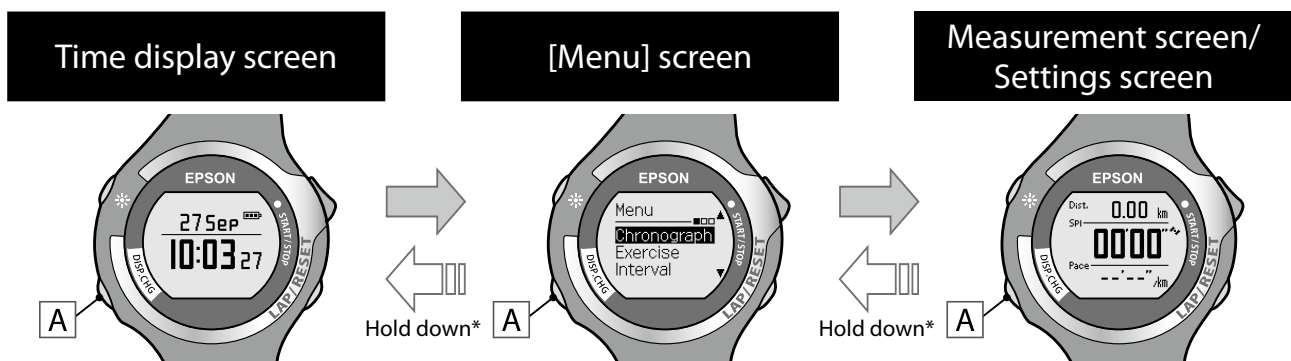

\* Hold down: Press **A** for at least two seconds to change the screen.

#### Time display screen

Displays the date and time.  
Press **A** to change to the [Menu] screen.  
Press **B** to turn on the light. The light turns on for approximately 10 seconds.

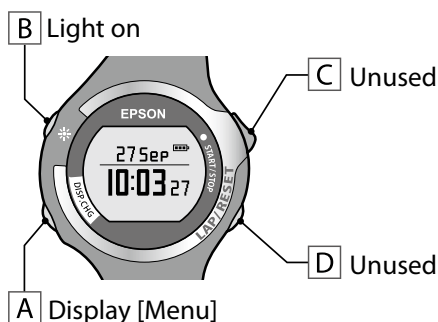

**[Menu] screen**

Displays the [Menu] list.  
Use [C] / [D] to highlight the target function,  
and then press [A].

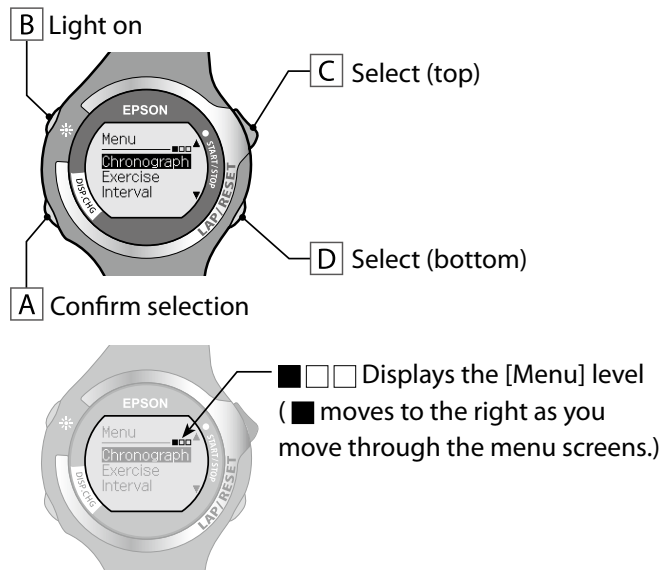

**Measurement screen/Settings screen**

Displays each function screen.  
As well as the [Chronograph] example screen, there are also measurement and settings screens for [Exercise], [Interval], [Recall], and [Settings].

Example screen:

**Chronograph** (→ P. 27)

Measure split times and lap times.

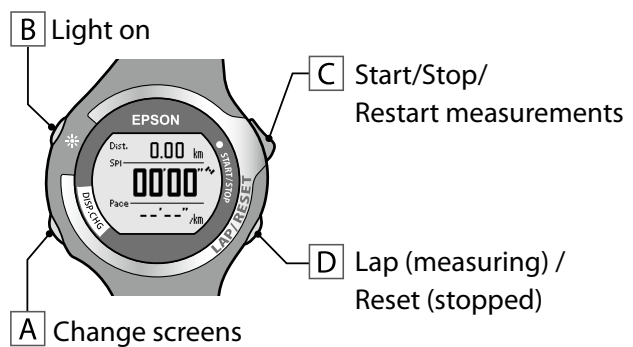

**Exercise** (→ P. 35)

Exercise while checking the target pace.

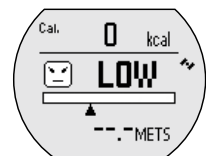

**Interval** (→ P. 43)

Repeat exercise for hard and light workouts.



**Recall** (→ P. 55)

Check measurement results.



**Settings** (→ P. 73)

Change settings.

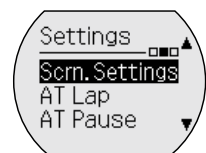

## ■ Icons on the measurement screen

Icons for each type of measurement, such as chronograph, exercise, and interval, are displayed at the left and right edges of the screen, as well as the signal status for the GPS and sensors.

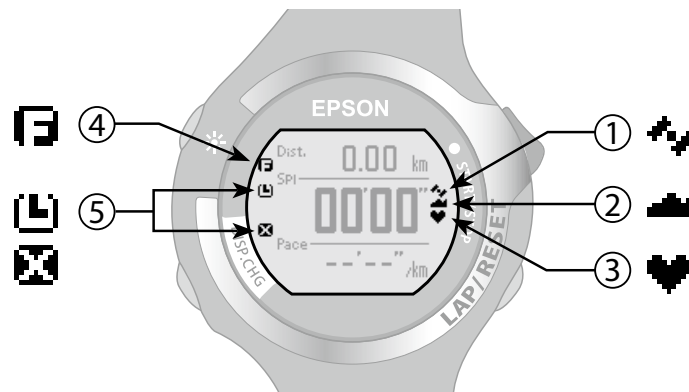

	Icon	Name	Summary
①		GPS signal status	Displays the status of the signal from the GPS. On : The signal is being received from the GPS. Flashing: Cannot receive signal from the GPS, or performing a GPS search.
②		Stride sensor status	Displays the setting status for the stride sensor (→ P. 60). On : The stride sensor is enabled.
③		HR sensor status	Displays the communication status with the HR sensor (→ P. 67). On : Communicating with the HR sensor. Flashing: Cannot communicate with the HR sensor.
④		Memory status	The icon is displayed if the free space for the memory in the device is running low. · If there is no free space for the memory, the oldest data is overwritten. · You can also delete all data from [Menu] - [Settings] - [Sys. Settings] - [Clear History]. · Upload the measurement data that you want to store to the Web application (→ P. 119).
⑤		Measurement status	Displays the measurement status ( and  are not displayed at the same time). Flashing: Measuring On : Measuring is paused

## 1-4 Measurable items

Items that can be measured by each measurement function for chronograph, exercise, and interval change according to the settings for the GPS signal (GPS on/off), stride sensor, and the HR sensor.

### Measurable items

Stride sensor status		SS-700/SS-500 only		SS-700/SS-500/ SS-300	
		ON		OFF	
GPS on/off status		GPS on	GPS off	GPS on	GPS off
Measurement item (Display name)	Distance (Dist.)	○	●	○	-
	Pace	○	●	○	-
	Lap pace (PaceLa)	○	●	○	-
	Average pace (PaceAv)	○	●	○	-
	Speed	○	●	○	-
	Split time (Spl)	○	○	○	○
	Lap time (Lap)	○	○	○	○
	Pitch	●	●	-	-
	Stride	●	●	-	-
	Time	○	○	○	○
	Calories burnt (Cal.)	○	●	○	-
	Altitude (Alti.)	○	-	○	-
	HR	See the following table for items measurable by the HR sensor settings			
	Lap HR (HR Lap)				
	Average HR (HR Avg.)				
Guide time (Guide: Time display)	○	●	○	-	
Guide dist. (Guide: Distance display)	○	●	○	-	

○: Measurable ●: Stride sensor measurement possible -: Cannot measure

## Chapter 1

### Getting Ready

---

#### Items measurable by the HR sensor settings (SS-700 and SS-500 only)

HR sensor status		ON	OFF
Measurement item (Display name)	HR	<input type="radio"/>	-
	Lap HR (HR Lap)	<input type="radio"/>	-
	Average HR (HR Avg)	<input type="radio"/>	-

You can purchase the HR sensor set for the SS-500 as an optional item.

## 1-5 Measuring function for the device

This device receives a signal from the GPS, and measures distance and pace.

To make sure measurements are performed accurately, try to use the device under the following conditions which allow for easy reception of GPS signals.

- **Outside with no obstructions overhead**
- **The device is on the outside of your wrist**

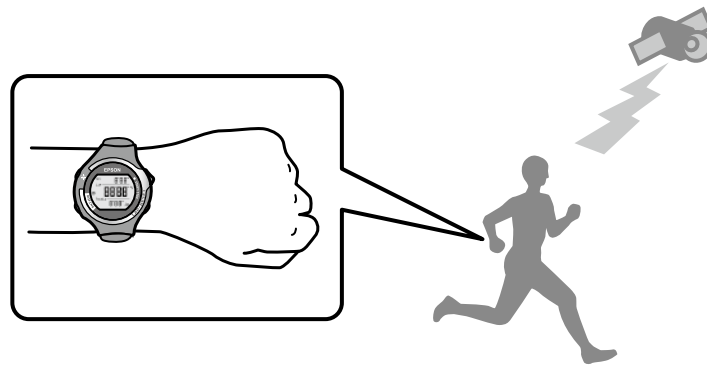



You cannot receive a signal from the GPS in the following environments.

### Obstructed environments

 <p>Inside rooms or buildings, or underground</p>	 <p>In tunnels</p>	 <p>Under water</p>
--	---	--

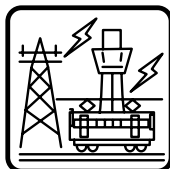
### Partially obstructed environments

 <p>Environments with high levels of electronic interference, such as constructions sites and heavy traffic</p>	 <p>Near high-voltage wires or television towers, overhead electric wires for trains, roads with skyscrapers</p>	 <p>On water</p>
--	---	---

## 1-6 Setting GPS (GPS search)

When changing to each measurement function for chronograph, exercise, and interval, the device receives a signal from the GPS and assigns a GPS to be used for measurements (GPS search).

While performing a GPS search, make sure you are outside with no obstructions overhead, and try to keep the device as still as possible.

This section explains how to perform a GPS search using the chronograph function as an example.

**1** Press **A** to display the [Menu].

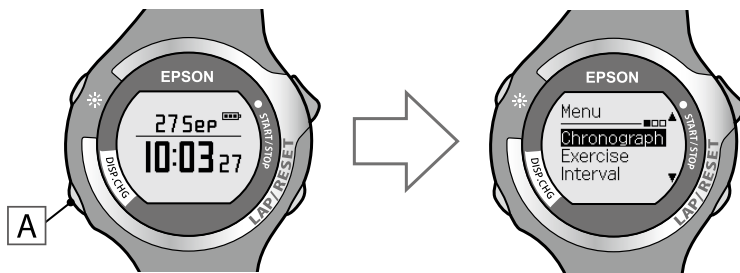

**2** Use **C** / **D** to highlight [Chronograph], and then press **A**.

The [Searching] screen is displayed. When the GPS search is complete, the chronograph screen is displayed.



For a more accurate measurement the first time you use the device, display the chronograph screen while you are outside for at least 15 minutes with no obstructions overhead before performing a GPS search.

You do not need to make these preparations from the second time. You need to make these settings again if the system is reset.



#### Tips

- It usually takes within two minutes to complete a GPS search. If the GPS search does not finish after three minutes or more, you may be in an environment where GPS signals cannot be received. Select [Cancel] to stop the search, and then try again in another location.
  - If the GPS search does not finish after 10 minutes, the search is stopped and the [Menu] screen is displayed.
  - With the chronograph and interval functions, you can also select [GPS off] and perform measurements. However, measurement items are limited at this time (→ [P. 21](#)).
  - When the GPS search is complete, the correct time is displayed.
-



## 2-1 About the chronograph function

### ■ What is the chronograph function?

This function allows you to measure split times and lap times simultaneously.

**Split time** : Progress time from start to a specific point

**Lap time** : Time for each lap

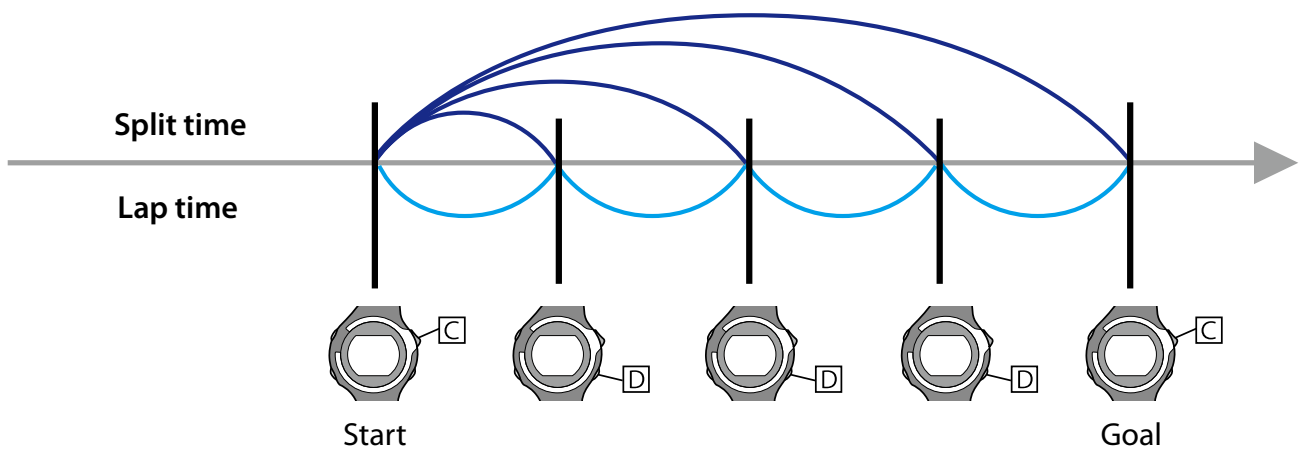

This device measures laps by pressing **D** during chronograph measurements, or using the auto lap function (→ [P. 79](#)).

## 2-2 Using the chronograph screen

When you change to the chronograph screen, the device performs a GPS search (→ [P. 24](#)). Make sure you perform the search outside with no obstructions overhead.

**1** Press **A** to display the [Menu].

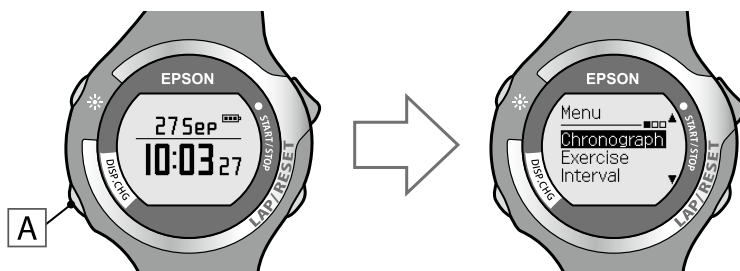

**2** Use **C** / **D** to highlight [Chronograph], and then press **A**.

When the GPS search is complete, the chronograph screen is displayed.



### Tips

- It usually takes within two minutes to complete a GPS search. If the GPS search does not finish after three minutes or more, you may be in an environment where GPS signals cannot be received. Select [Cancel] to stop the search, and then try again in another location.
- If the GPS search does not finish after 10 minutes, the search is stopped and the [Menu] screen is displayed.
- If you select [GPS off] on the [Searching] screen, the GPS sensor turns off which allows you to use the chronograph function. However, measurement items are limited at this time (→ P. 21).
- See "Setting GPS (GPS search)" (→ P. 24) for more details on making a GPS search.
- If 60 minutes pass without any measurements being made (if the device is stopped or before measuring), the [Menu] screen is displayed.

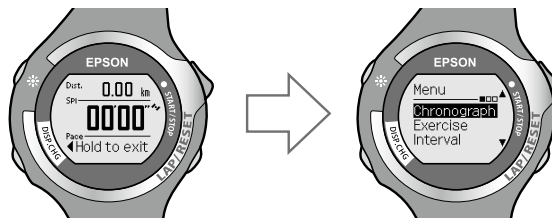

## 2-3 Measuring

### ■ Measure

**1** Press **[C]** to start measuring.

**[L]** is displayed on the measurement screen.

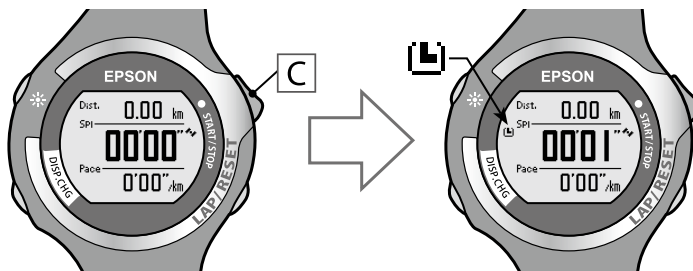

**2** Press **[D]** to measure the lap time.

The lap screen is displayed for 20 seconds, and then the measurement screen is displayed.

Measurement screen  
(Chronograph)

Lap screen

Measurement screen  
(Chronograph)



Measurement data displayed on the lap screen includes lap number, lap time, lap distance, and lap pace.

**Display screen view**

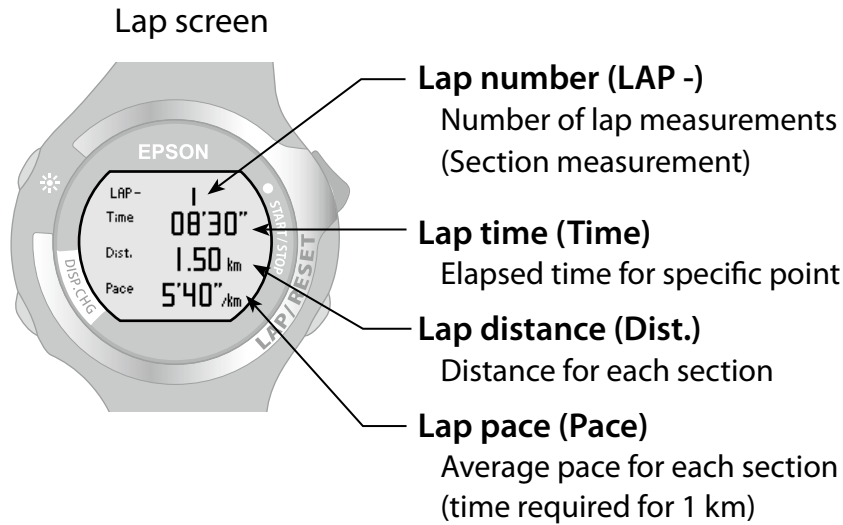

**3** Press **[C]** while measuring to stop measuring.

is displayed on the measurement screen.

Press **[C]** to start measuring again.

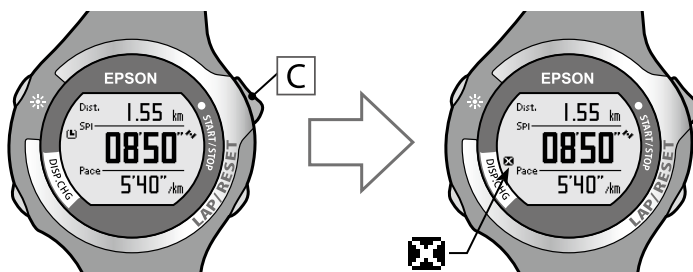

**4** Press **[D]** while measuring has been stopped to reset the measurement display.

When you reset the display, the values return to zero allowing you to start the next measurement.

Data that has been measured up to that point is stored in the device's memory.

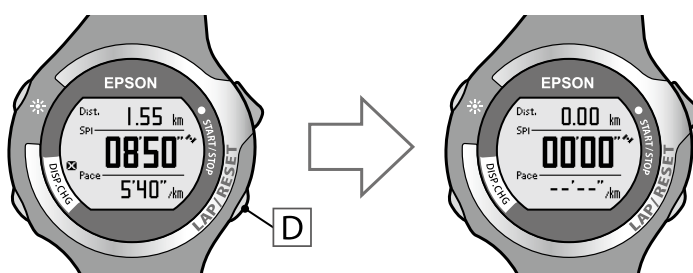

## Chapter 2

# Using the Chronograph Function

---

### Tips

- After resetting, hold down [A] for a few seconds to update GPS data and return to the [Menu] screen. By updating the GPS data, the GPS measurement data is recorded. The recorded data is used to increase the measurement accuracy for distance and pace.



- If 60 minutes pass without any measurements being made (if the device is stopped or before measuring), the [Menu] screen is displayed.
  - You can use [Recall] to check the stored measurement data (→ [P. 55](#)).
-



## ■ Changing the chronograph screen

During chronograph measurement, three items are displayed on one screen.

There are three measurement screens available. You can change screens by pressing **A**.

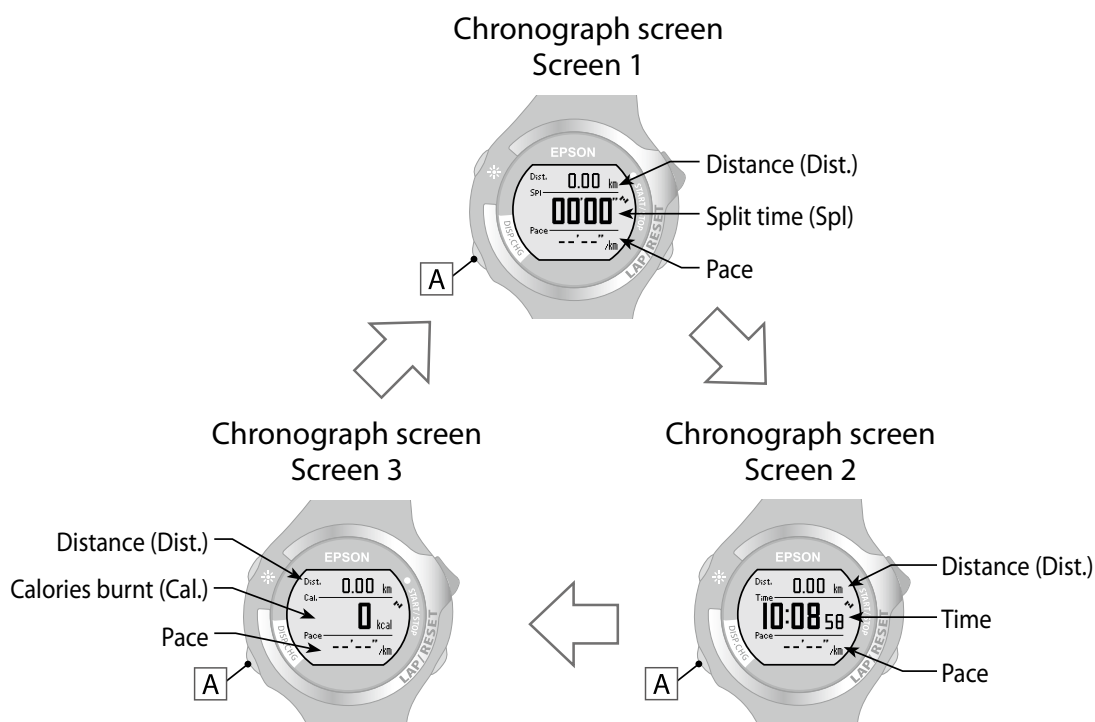

You can change the measurement item displayed on each screen (screens 1, 2, and 3) from [Menu] - [Settings] - [Scrn. Settings] (➔ [P. 75](#)). Change to the item you want to check. The following measurement items are displayed by default.

Default settings	Screen 1	Screen 2	Screen 3
Top row	Distance (Dist.)	Distance (Dist.)	Distance (Dist.)
Middle row	Split time (Spl)	Time	Calories burnt (Cal.)
Bottom row	Pace	Pace	Pace

# Using the Exercise Function

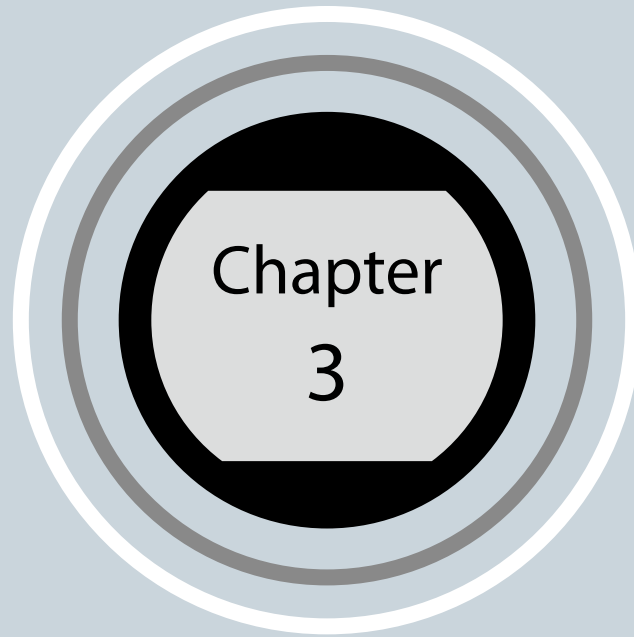

---

3-1 About the exercise function

3-2 Setting the target pace

3-3 Using the exercise screen

3-4 Starting the exercise function

---

## 3-1 About the exercise function

### ■ What is the exercise function?

This function allows you to exercise and check how close you are to your target pace.

By setting a target pace in advance, the device indicates if you are exceeding your target while exercising. It also indicates how close you are to your target.

This is useful when you want to be aware of your running pace.

You can measure split and lap times in the same way as the chronograph.

#### Display screen view

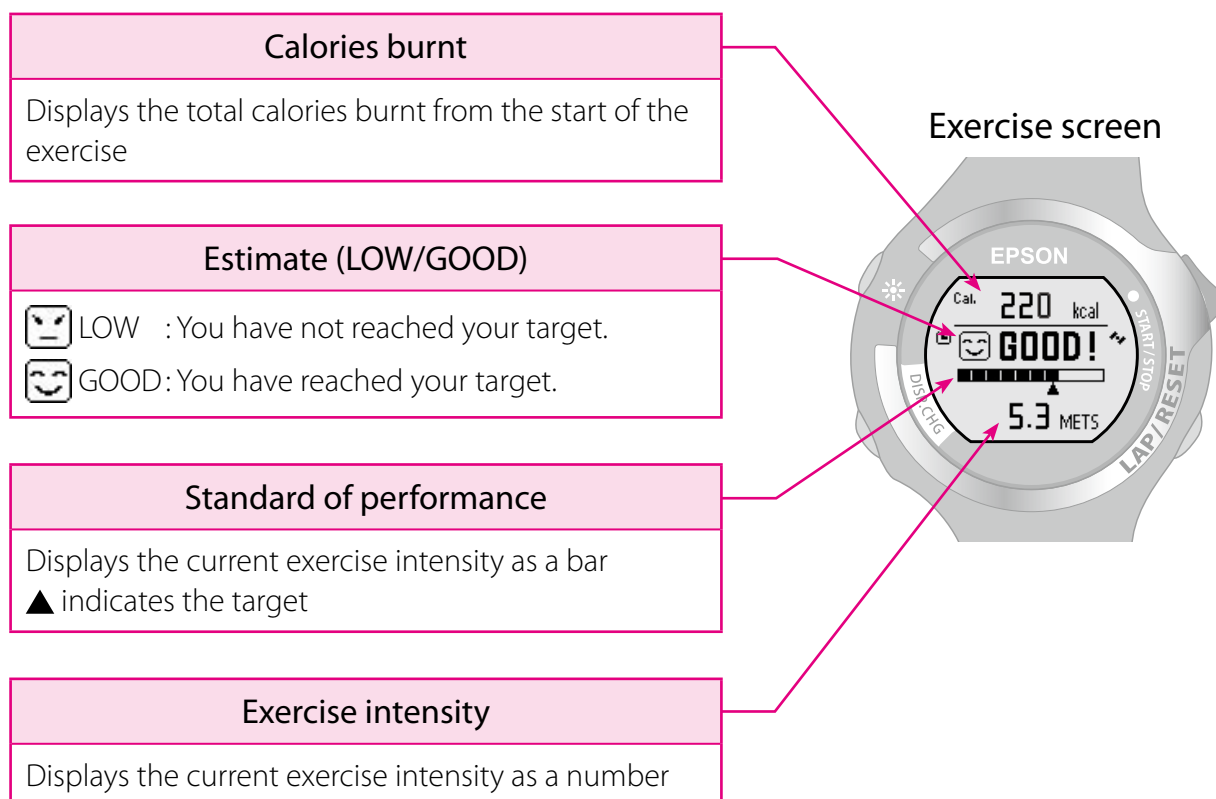

#### Tips

METS is a unit that shows the strength of physical activity. We can express the strength of physical activity by assuming that one METS is the equivalent of sitting down and relaxing. A walk is usually the equivalent of three METS. Therefore, this type of physical activity is approximately three times as strong as sitting down and relaxing.

## 3-2 Setting the target pace

Set the target time for your running exercise per kilometer in [Target Pace] from [Settings].

- 1 Press **A** to display the [Menu].

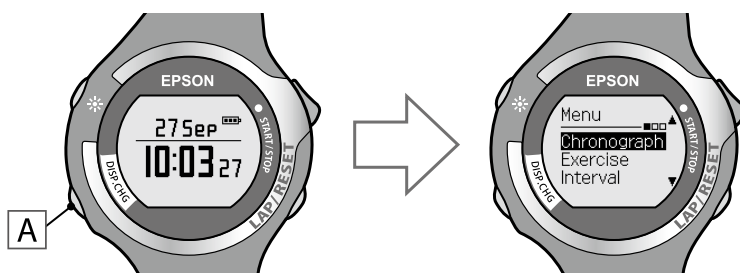

- 2 Use **C** / **D** to highlight [Settings], and then press **A**.

The [Settings] function selection screen is displayed.

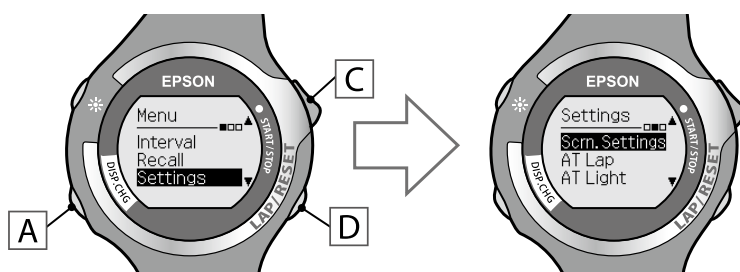

- 3 Use **C** / **D** to highlight [Target Pace], and then press **A**.

The [Target Pace] settings screen is displayed.

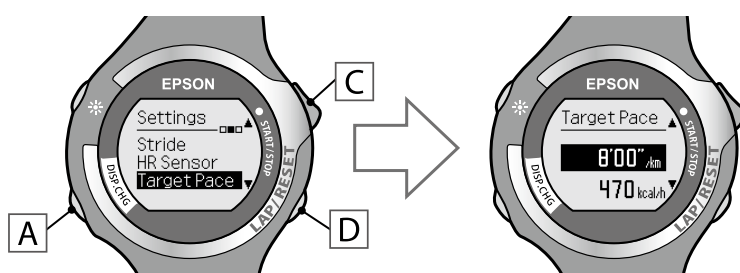

#### 4 Use [C] / [D] to set the target pace, and then press [A].

Set the target pace for your exercise shown on the top row of the screen. You can set the target pace in increments of 0'01"/km within a range of 1'00" to 15'00"/km. Hold down [C] / [D] to speed through the numbers.

The target for the amount of calories burnt in one hour calculated based on the target pace is displayed at the bottom of the screen.

After confirming the selection, the [Settings] screen is displayed.

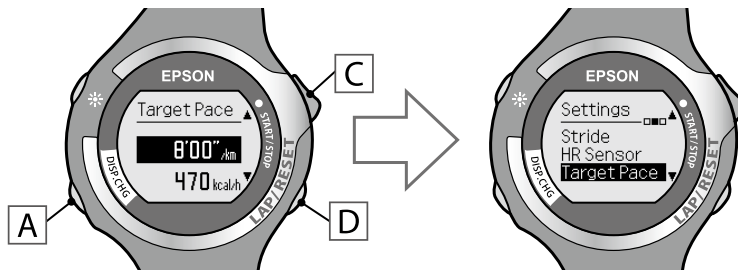

#### Tips

See the user settings data for measurements of calories burnt. Set the user data in user settings to accurately measure how many calories you have burnt (➔ [P. 101](#)).

---

#### 5 Hold down [A] for at least two seconds to return to the [Menu] screen.

## 3-3 Using the exercise screen

When you change to the exercise screen, the device performs a GPS search (➔ [P. 24](#)). Make sure you perform the search outside with no obstructions overhead.

**1** Press **A** to display the [Menu].

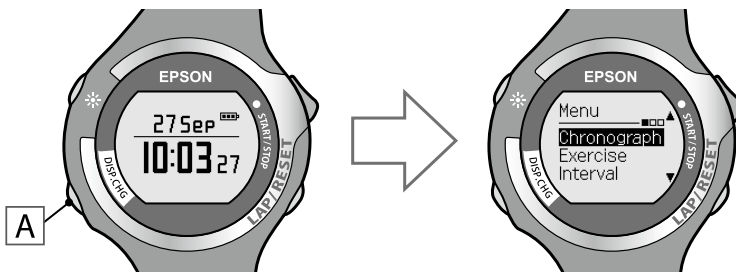

**2** Use **C** / **D** to highlight [Exercise], and then press **A**.

When the GPS search is complete, the exercise screen is displayed.

If the GPS search has not been completed, the exercise screen is not displayed.

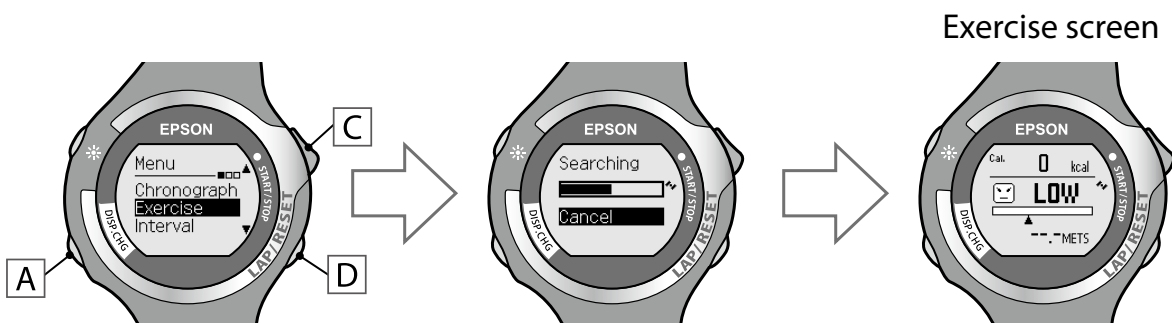

### Tips

- It usually takes within two minutes to complete a GPS search. If the GPS search does not finish after three minutes or more, you may be in an environment where GPS signals cannot be received. Select [Cancel] to stop the search, and then try again in another location.
- If the GPS search does not finish after 10 minutes, the search is stopped and the [Menu] screen is displayed.
- See "Setting GPS (GPS search)" (➔ [P. 24](#)) for more details on making a GPS search.
- If 60 minutes pass without any measurements being made (if the device is stopped or before measuring), the [Menu] screen is displayed.

## 3-4 Starting the exercise function

### ■ Measure

**1** Press **C** to start exercise measurements.

**L** is displayed on the measurement screen.

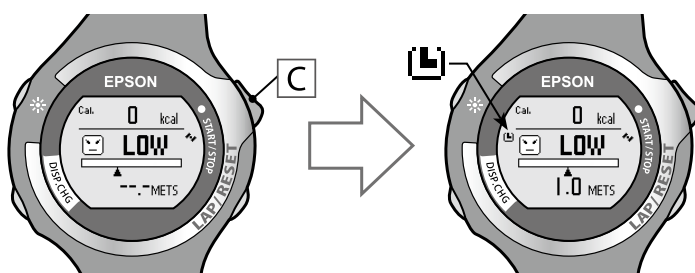

When you start exercising, values, the current evaluation, and a bar are displayed, and they change as you exercise.

**2** Press **C** while measuring to stop measuring.

**X** is displayed on the measurement screen.

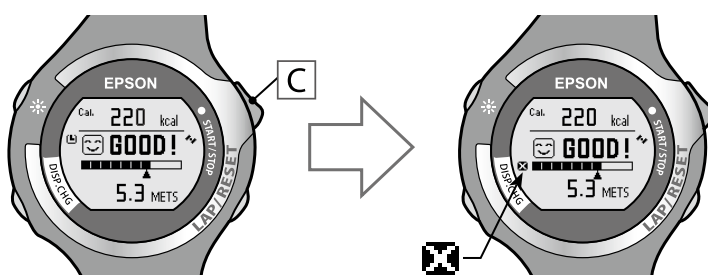

Press **C** to start measuring again.

### 3 Press [D] while measuring has been stopped to reset the measurement display.

When you reset the display, the values return to zero allowing you to start the next measurement.

Data that has been measured up to that point is stored in the device's memory.

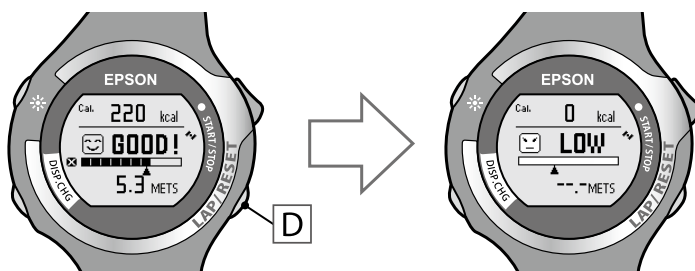

#### Tips

- After resetting, hold down [A] for a few seconds to update GPS data and return to the [Menu] screen. By updating the GPS data, the GPS measurement data is recorded. The recorded data is used to increase the measurement accuracy for distance and pace.



- If 60 minutes pass without any measurements being made (if the device is stopped or before measuring), the [Menu] screen is displayed.
- You can use [Recall] to check the stored measurement data (➔ [P. 55](#)).



## ■ Changing the exercise screen

---

Press **A** to change to the chronograph screen while measuring exercise.

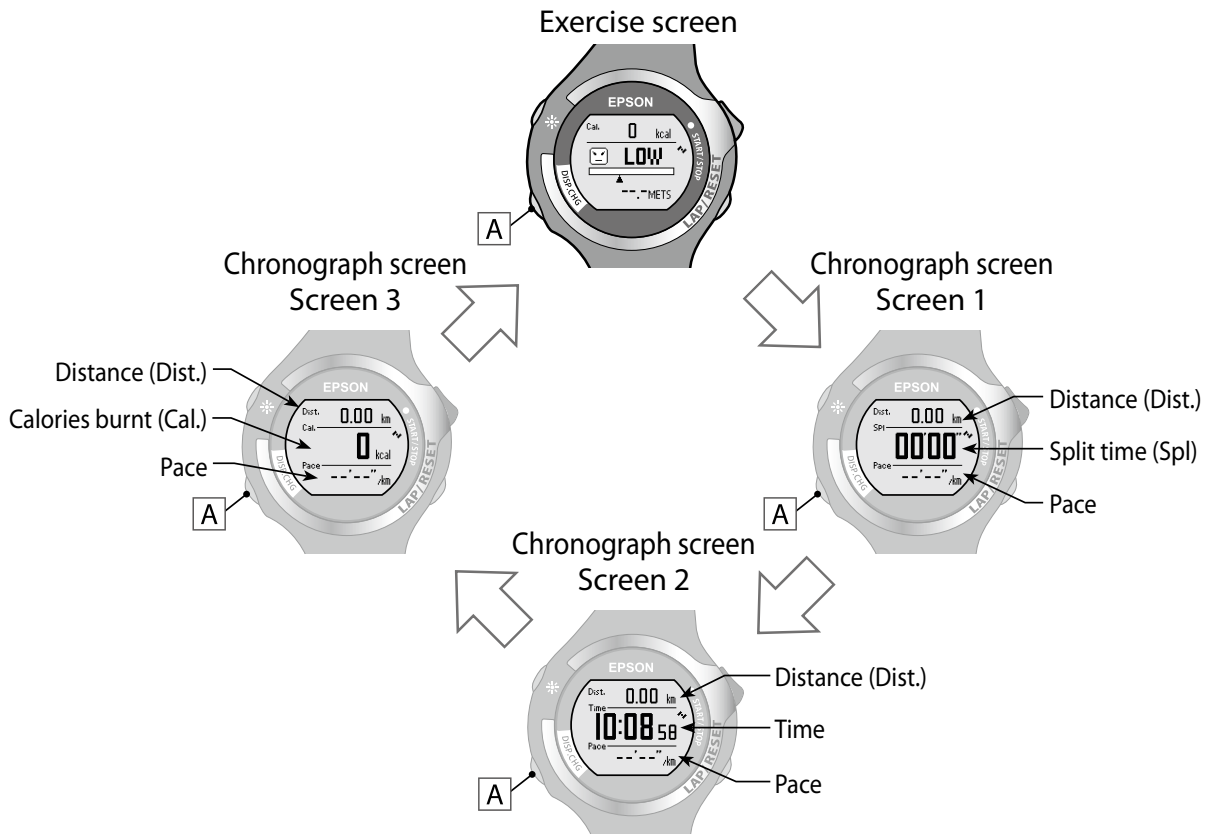

---

### Tips

For more details about the chronograph screen, see the "Changing the chronograph screen" ([→ P. 33](#)).

---

# Using the Interval Function

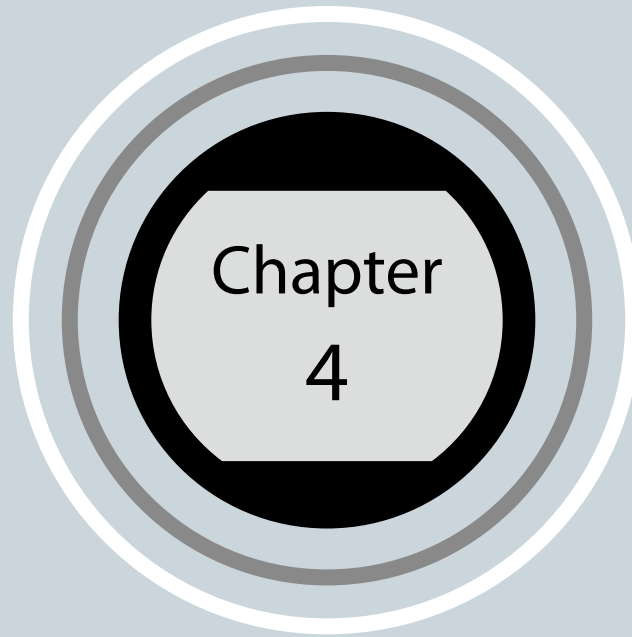

- 
- 4-1 About the interval function
  - 4-2 Setting interval conditions
  - 4-3 Using the interval screen
  - 4-4 Starting interval exercises
-

## 4-1 About the interval function

### ■ What is the interval function?

This function allows you to perform sets of hard (sprint) and light (rest) exercise.

You can set the distance and time, and create an exercise menu.

An alarm notifies you of a change between sprint and rest times.

**Sprint** : Hard exercise

**Rest** : Light exercise

**Repeat no.** : Number of times to repeat one set of sprinting and resting

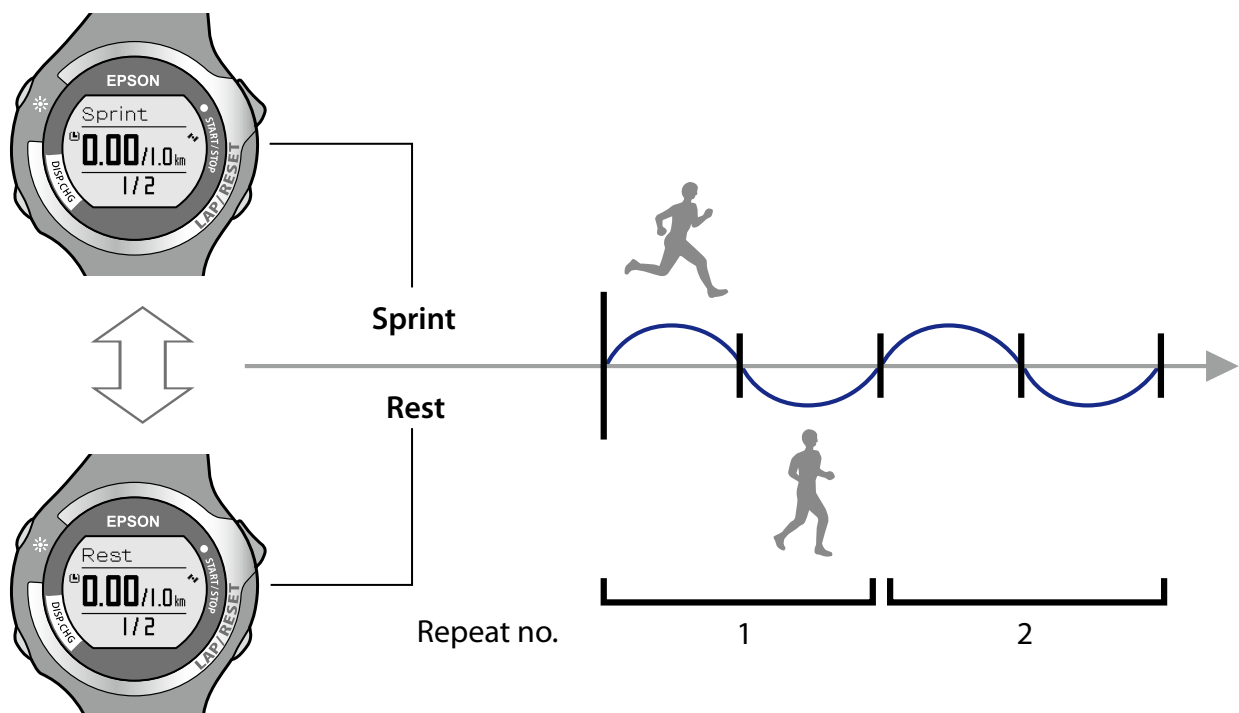

## 4-2 Setting interval conditions

You can set the length and a number of times to repeat a set of sprints and rests from [Interval] in [Settings].

- 1 Press **A** to display the [Menu].

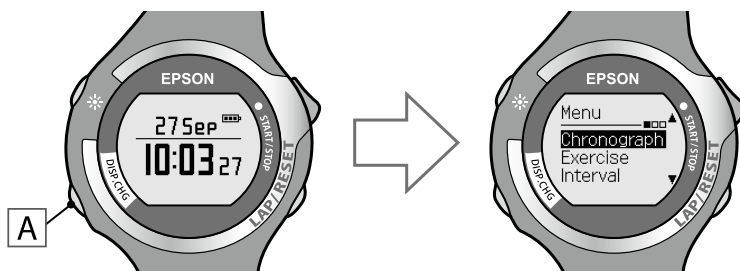

- 2 Use **C** / **D** to highlight [Settings], and then press **A**.

The [Settings] function selection screen is displayed.

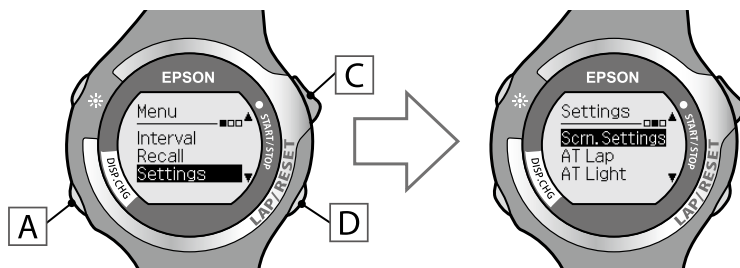

- 3 Use **C** / **D** to highlight [Interval], and then press **A**.

The [Sprint Setting] screen is displayed.

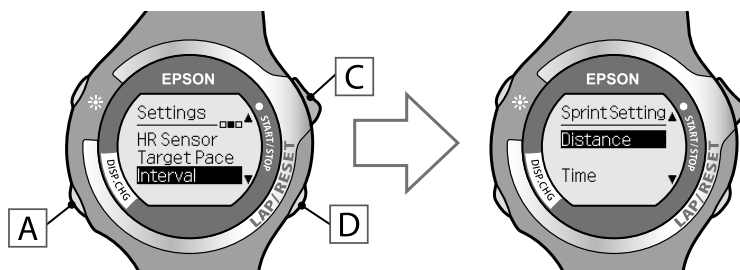

**4** Use **[C]** / **[D]** to highlight **[Distance]** or **[Time]**, and then press **[A]**.

Select whether to set the distance or time for the sprint. After pressing **[A]**, the screen for setting the length for the sprint is displayed.

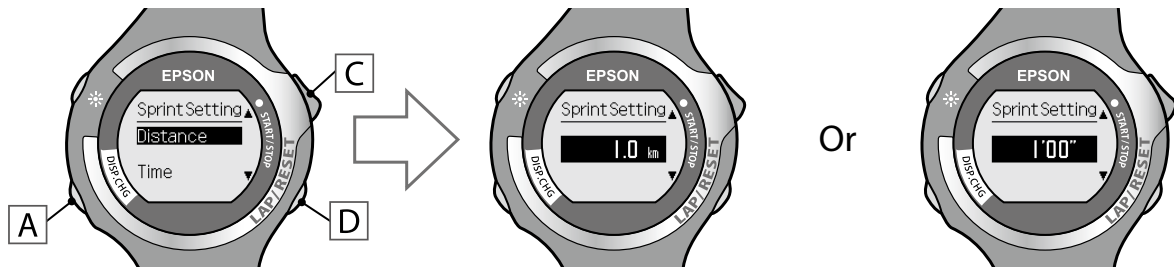

**5** Use **[C]** / **[D]** to set the length for the sprint, and then press **[A]**.

You can set the kilometers in increments of 0.1 km within a range of 0.1 to 5.0 km, and you can set the time in increments of one minute within a range of 1'00" to 60'00". Hold down **[C]** / **[D]** to speed through the numbers.

The **[Rest Settings]** screen is displayed.

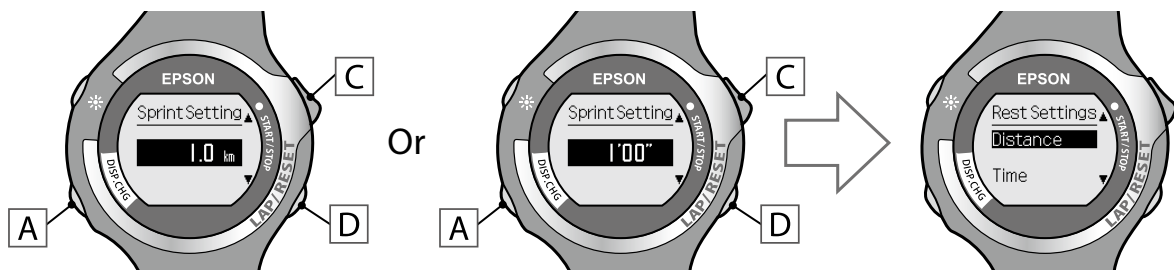

**6** Use **[C]** / **[D]** to highlight **[Distance]** or **[Time]**, and then press **[A]**.

Select whether to set the distance or time for the rest. After pressing **[A]**, the screen for setting the length for the rest is displayed.

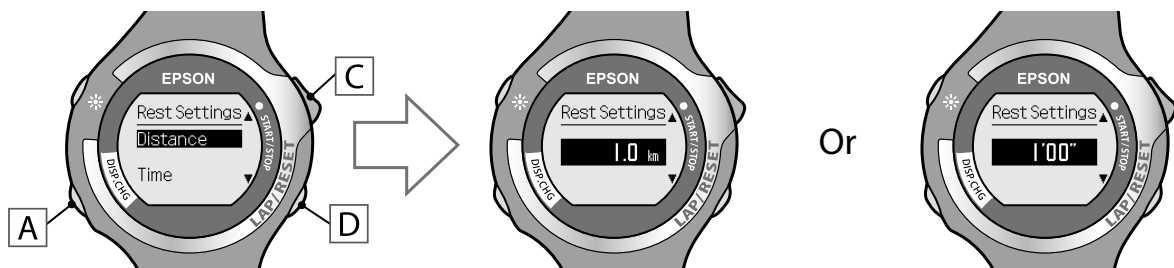

**7** Use [C] / [D] to set the length for the rest, and then press [A].

You can set the kilometers in increments of 0.1 km within a range of 0.1 to 5.0 km, and you can set the time in increments of one minute within a range of 1'00" to 60'00". Hold down [C] / [D] to speed through the numbers.

After pressing [A], the [Repeat No.] screen is displayed.

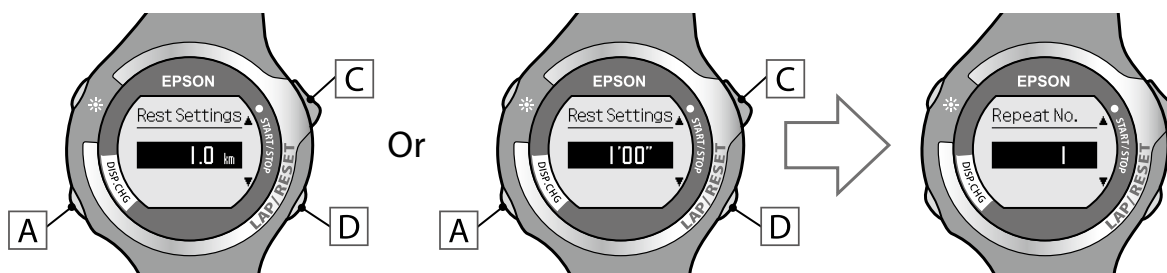

**8** Use [C] / [D] to set the repeat no. (the number of times to repeat one set of sprinting and resting), and then press [A].

You can set the number of repeats from 1 to 99. Hold down [C] / [D] to speed through the numbers.

After pressing [A], the [Settings] screen is displayed.

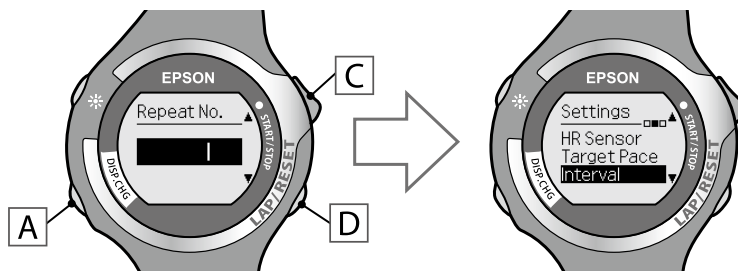

**9** Hold down [A] for at least two seconds to return to the [Menu] screen.

## 4-3 Using the interval screen

When you change to the interval screen, the device performs a GPS search (→ [P. 24](#)). Make sure you perform the search outside with no obstructions overhead.

**1** Press **A** to display the [Menu].

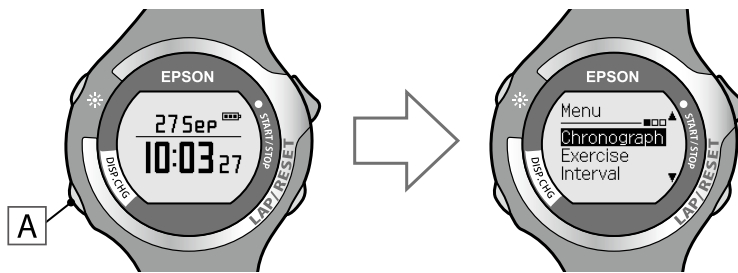

**2** Use **C** / **D** to highlight [Interval], and then press **A**.

When the GPS search is complete, the interval screen is displayed.

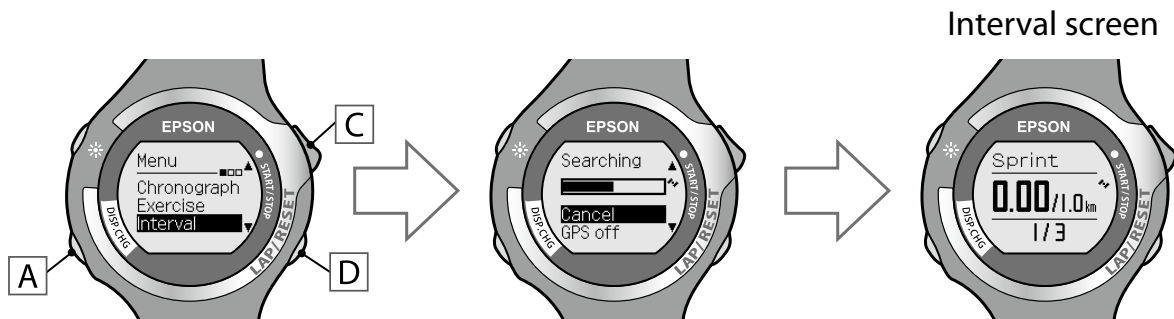

### Tips

- It usually takes within two minutes to complete a GPS search. If the GPS search does not finish after three minutes or more, you may be in an environment where GPS signals cannot be received. Select [Cancel] to stop the search, and then try again in another location.
- If the GPS search does not finish after 10 minutes, the search is stopped and the [Menu] screen is displayed.
- If you select [GPS off] on the [Searching] screen, the GPS sensor turns off which allows you to use the interval function. However, measurement items are limited at this time (→ [P. 21](#)). When [GPS off] is selected, distance is not measured. Set the length of time for sprint/rest (→ [P. 44](#)). For SS-700/SS-500, when the stride sensor is enabled (→ [P. 59](#)), you can set the sprint/rest length for Distance.
- See "Setting GPS (GPS search)" (→ [P. 24](#)) for more details on making a GPS search.
- If 60 minutes pass without any measurements being made (if the device is stopped or before measuring), the [Menu] screen is displayed.

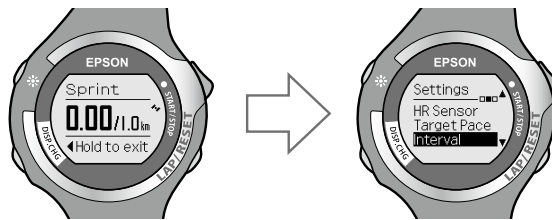



## 4-4 Starting interval exercises

### Interval measurement screen

#### Available buttons

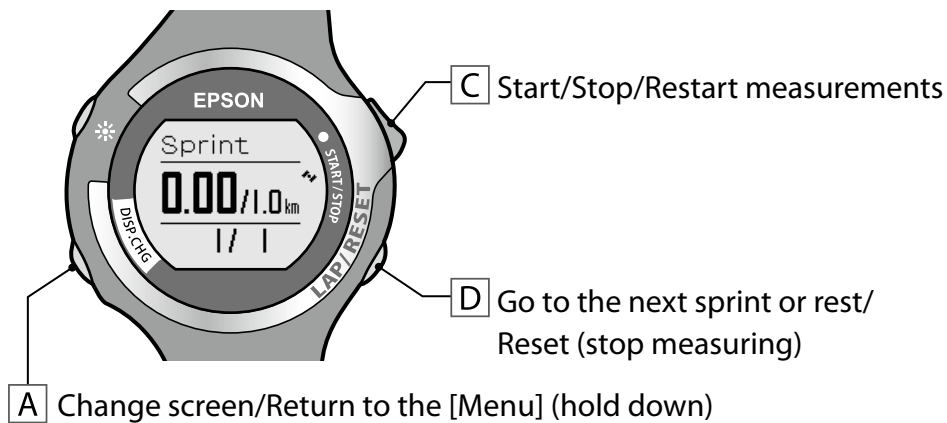

#### Display screen view

##### Sprint screen

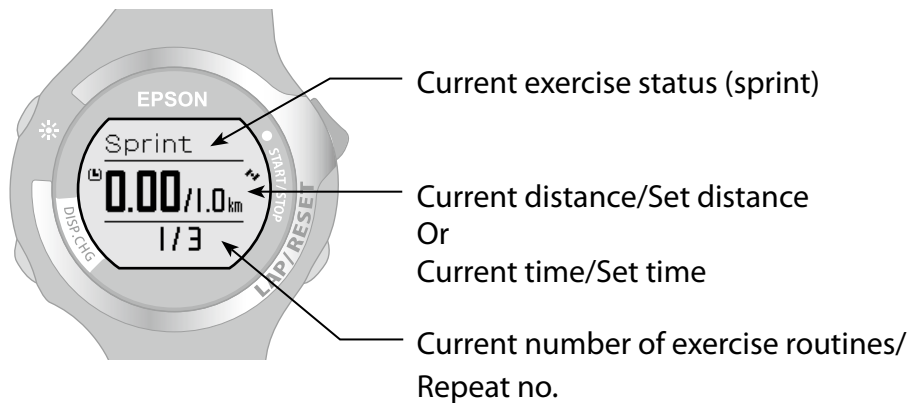

##### Rest screen

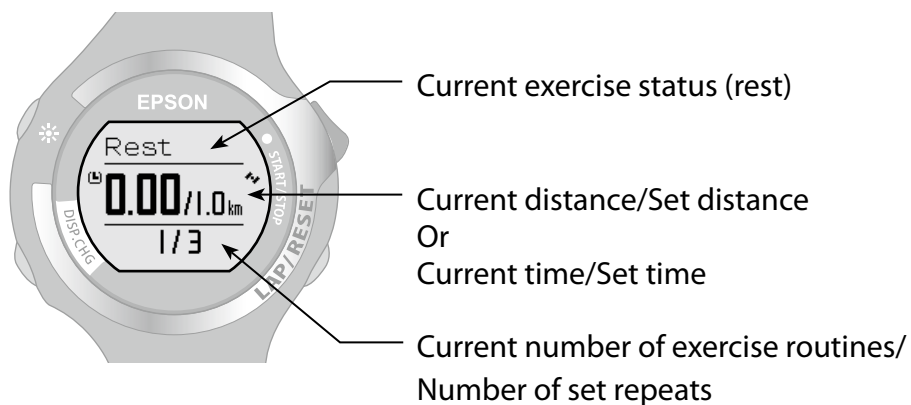

## ■ Measure

1 Press **C** to start interval measurements.

 is displayed on the measurement screen.

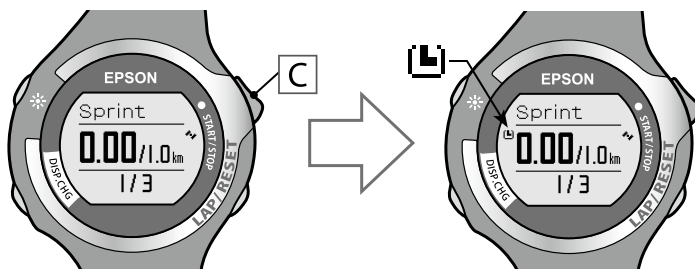

When the sprint distance (or sprint time) has passed, an alarm sounds and the rest screen is automatically displayed.





Also, when the rest distance (or rest time) has passed, an alarm sounds and the sprint screen is displayed.

The number of exercise routines increases by one.



### Tips

- If you press **D** while measuring, you can change from sprint to rest, and then back to sprint again. This also increases the number of exercise routines.
- If no GPS signal is being received (when the  is flashing), there may not be a change between sprinting and resting even if you reach the set time. Make sure you are in an environment where the GPS signal can be easily received without any obstructions overhead, and check that the GPS signal is being received (the  changes from flashing to on).
- When the stride sensor is enabled for the SS-700/SS-500 ([➔ P. 59](#)), although the stride sensor can perform measurement, if the exercise distance is short, there is no change between sprinting and resting even if you reach the set time. Keep exercising, and increase the exercise distance.

**2** Press **C** while measuring to stop measuring.

 is displayed on the measurement screen.

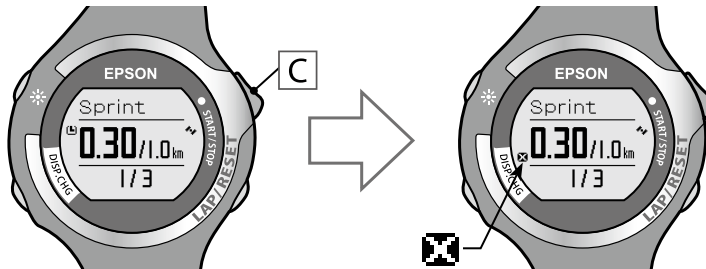

Press **C** to start measuring again.

**3** Finishes measuring.

Exercise the set number of repeats. Once you have exercised for the set number of repeats, [Finish] is displayed on the screen.



If you want to finish while exercising, press **C** to stop measuring.

 is displayed on the measurement screen.

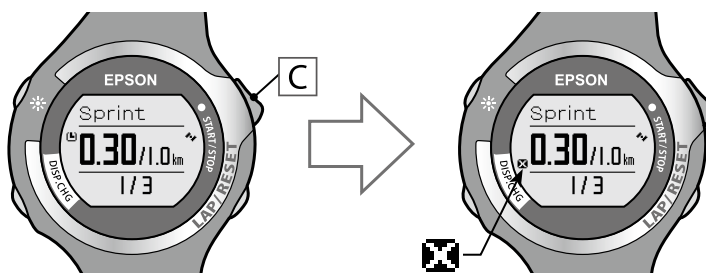

**4** Press **[D]** while measuring has been stopped to reset the measurement display.

When you reset the display, values, such as the number of exercise routines, return to zero allowing you to start the next measurement.

Data that has been measured up to that point is stored in the device's memory.

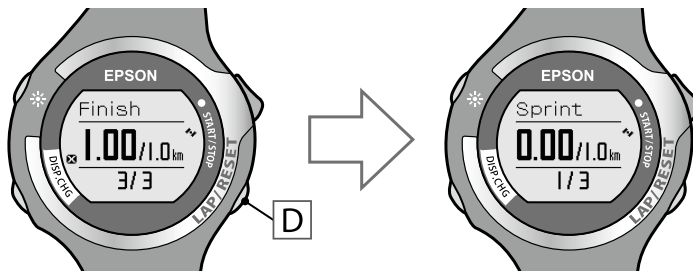

**Tips**

- After resetting, hold down **[A]** for a few seconds to update GPS data and return to the [Menu] screen. By updating the GPS data, the GPS measurement data is recorded. The recorded data is used to increase the measurement accuracy for distance and pace.



- If 60 minutes pass without any measurements being made (if the device is stopped or before measuring), the [Menu] screen is displayed.
- You can use [Recall] to check the stored measurement data (➔ [P. 55](#)).

## ■ Changing the interval screen

If you press **A** during interval measurements, the chronograph screen is displayed.

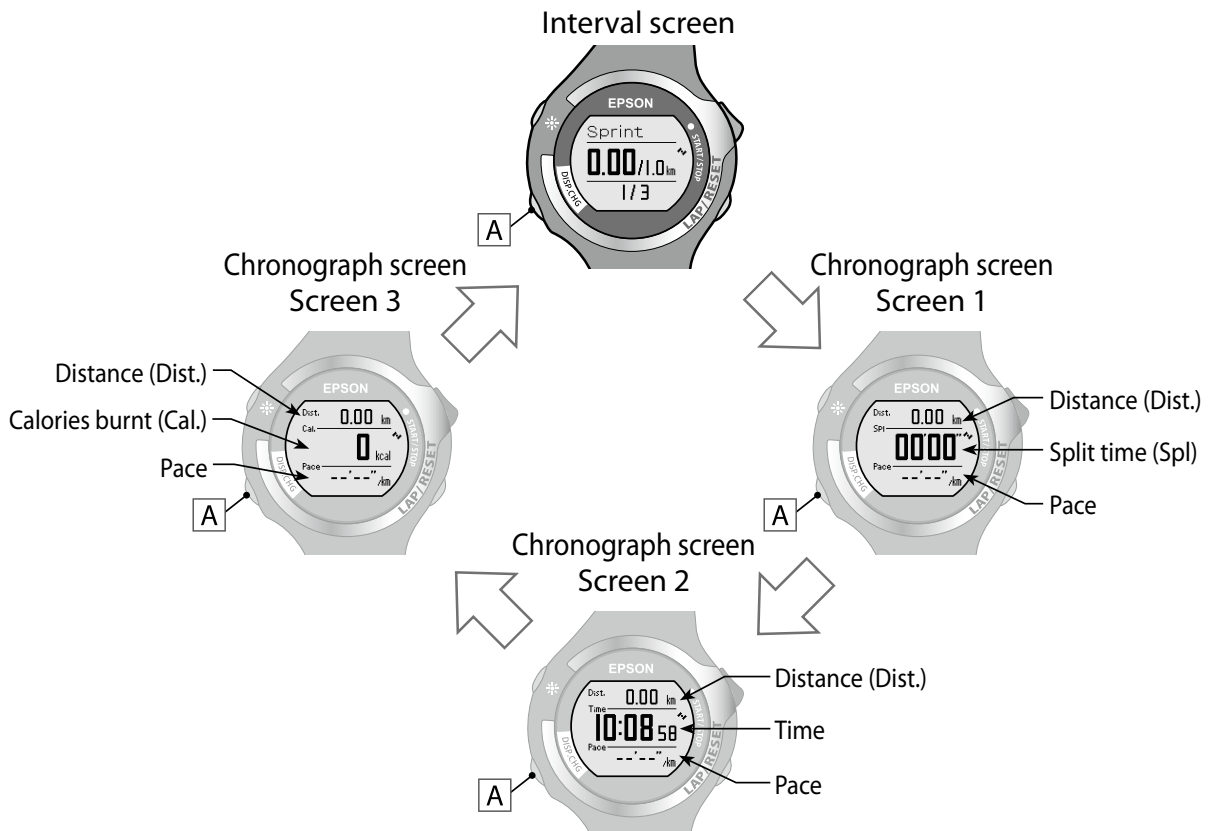

### Tips

For more details about the chronograph screen, see the "Changing the chronograph screen" ([➔ P. 33](#)).



# 5-1 Measurement data that can be checked in recall

You can check measured data by using the [Recall] function.

The measurement data displayed includes the split time screen and each lap time screen.

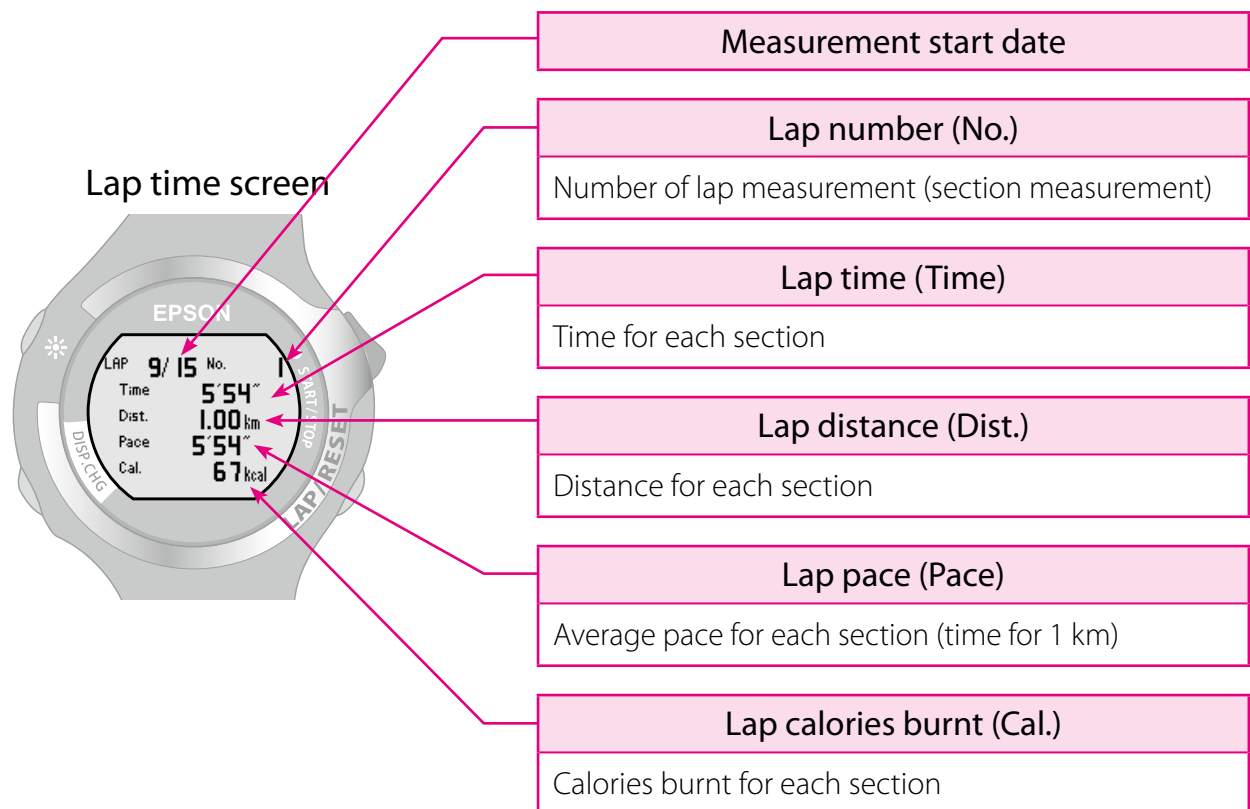
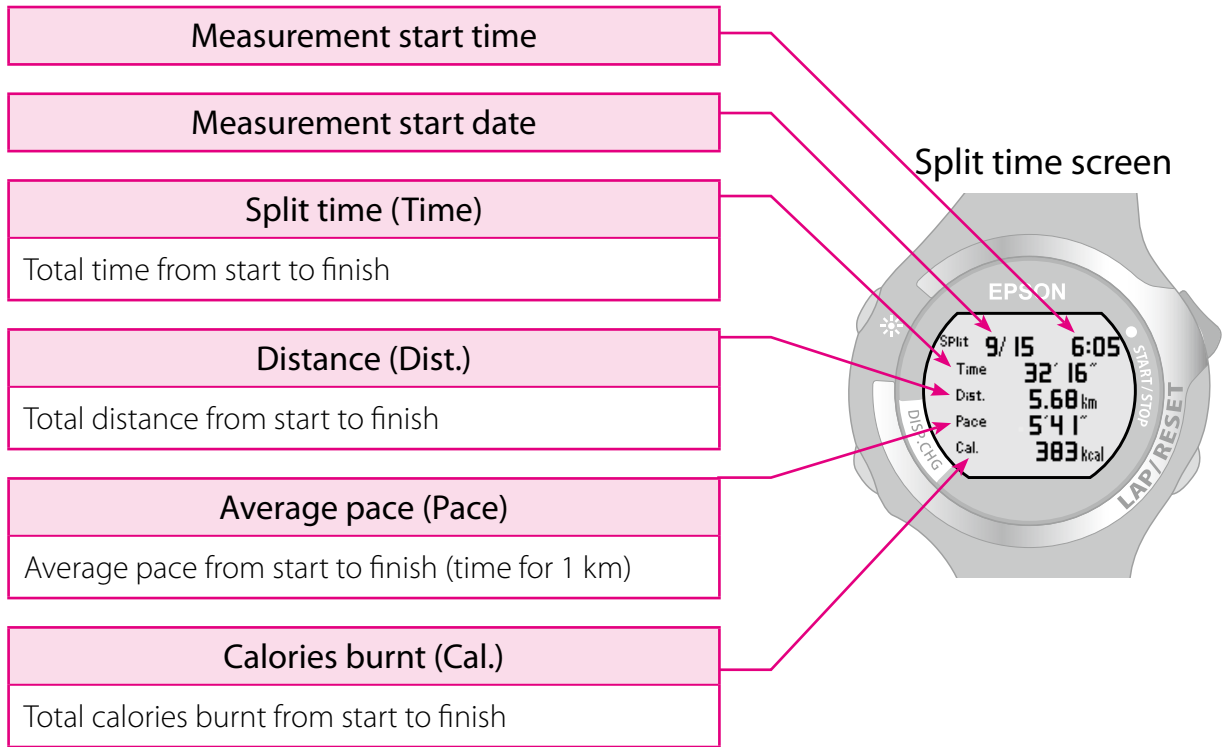

## 5-2 Checking measurement data

- 1** Press **A** to display the [Menu].

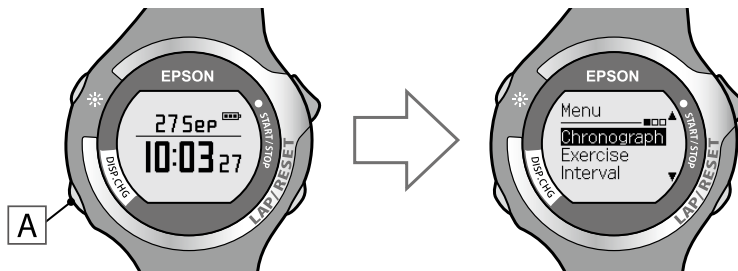

- 2** Use **C** / **D** to highlight [Recall], and then press **A**.

The data list screen is displayed.

The data list screen displays the date and measured distances.

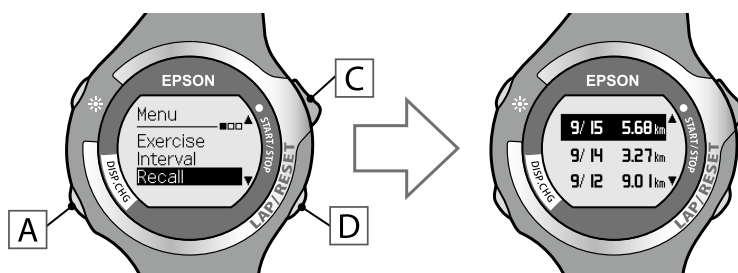

- 3** Use **C** / **D** to highlight the data you want to check, and then press **A**.

The confirmation screen for the selected date is displayed.

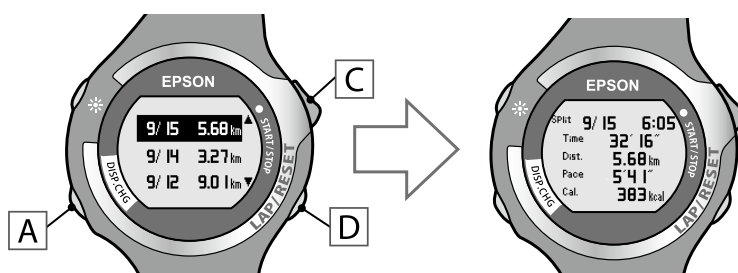



**4** Use **[C]** / **[D]** to check the data.

Screen 1 displays the split time, and screen 2 displays the lap time.

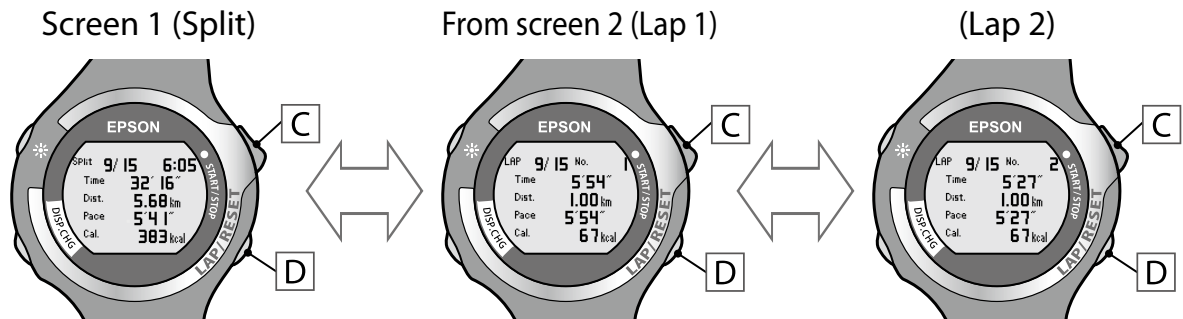

**5** After checking the data, press **[A]** to return to the data list screen.

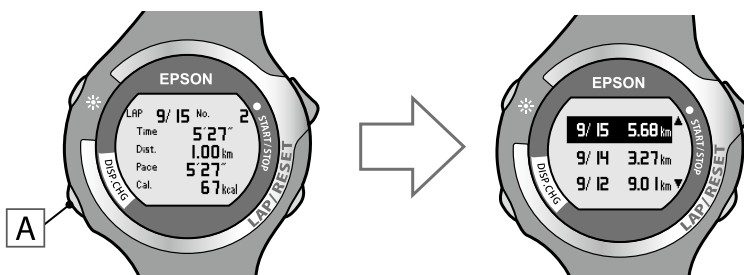

**6** Hold down **[A]** for at least two seconds to return to the [Menu] screen.

# Measuring Distance and Pace with the Stride Sensor (SS-700/SS-500 Only)

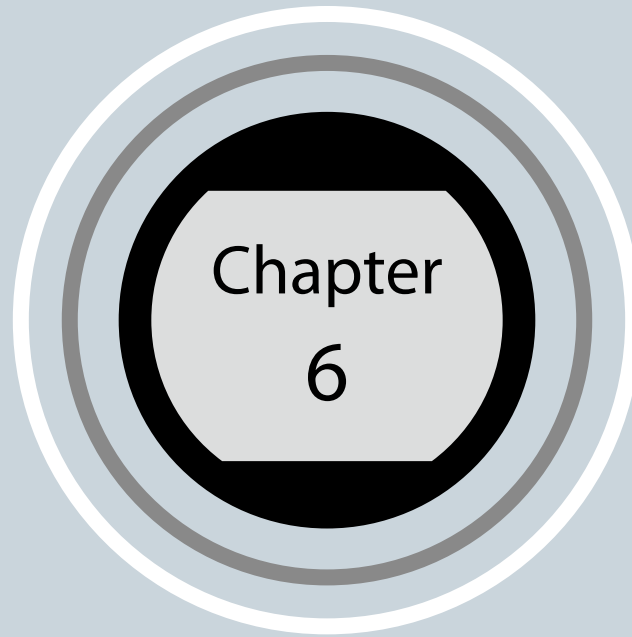

---

6-1 About the stride sensor

6-2 Enabling the stride sensor

---

## 6-1 About the stride sensor

### ■ Measuring with the stride sensor

By using the built-in stride sensor, you can measure distance and pace even in locations that cannot receive GPS signals, such as tunnels or buildings.

Stride sensor measurements are only available for the SS-700/SS-500.

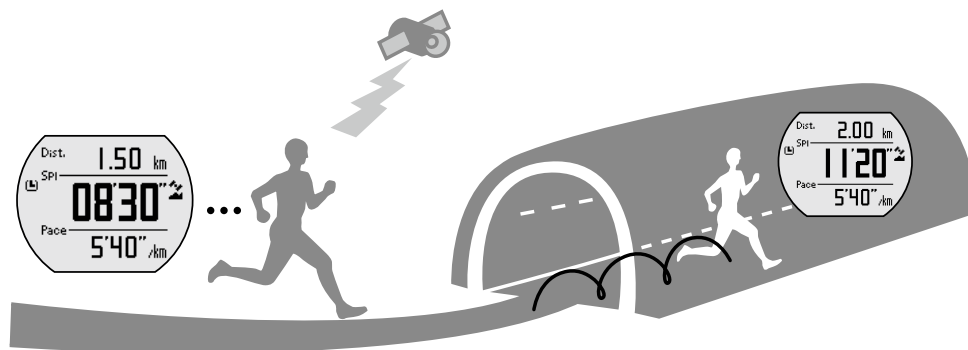

#### Tips

- The stride sensor measures distance and pace using the latest running pitch information received from the GPS.  
If your running pace differs greatly from the latest running pace received from the GPS, there may be a large difference between the distance and pace measured with the stride sensor.
- The device's stride sensor is used for running. This is not available for cycling, skiing, or canoeing. Also, when walking, a large measurement error may occur.

**You need to make the following preparations when using this product for the first time.**

To measure distance and pace using the stride sensor, you need to run at least 400 meters first with [Stride] set to [ON] and GPS on.

You can then use the stride sensor. You do not need to make these preparations from the second time.

## 6-2 Enabling the stride sensor

Enable the stride sensor from [Stride] in [Settings].

- 1 Press **A** to display the [Menu].

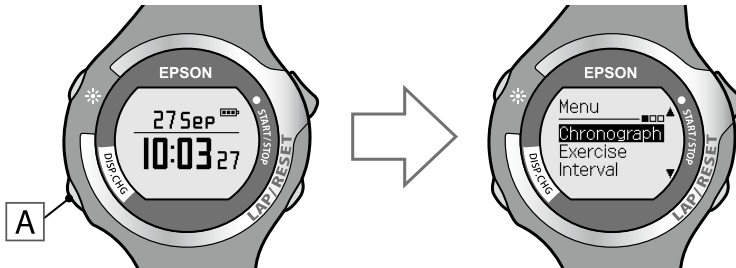

- 2 Use **C** / **D** to highlight [Settings], and then press **A**.

The [Settings] function selection screen is displayed.

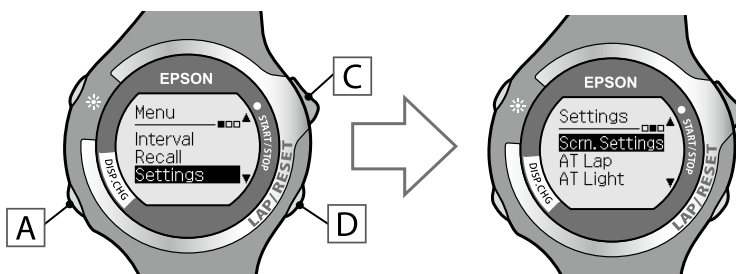

- 3 Use **C** / **D** to highlight [Stride], and then press **A**.

The [Stride] settings screen is displayed.

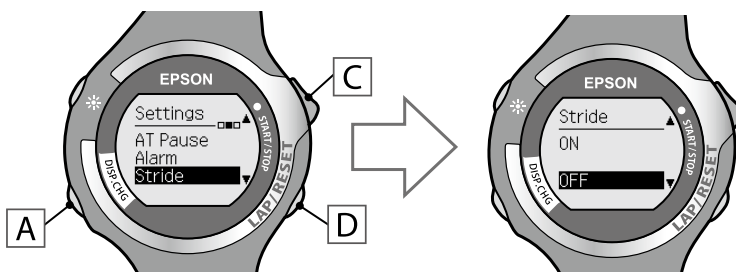

- 4** Use **[C]** / **[D]** to highlight **[ON]**, and then press **[A]**.

After confirming the selection, the [Settings] screen is displayed.

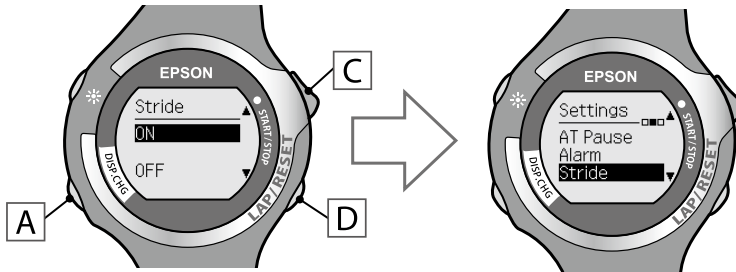

When [Stride] is set to [ON],  is displayed on the chronograph, exercise, and interval measurement screen.

- 5** Hold down **[A]** for at least two seconds to return to the [Menu] screen.

#### Tips

To turn this function off, select [OFF] in step **4**.

---

If a GPS signal is not received while using the chronograph, exercise, or interval functions, you can perform distance and pace measurement with the stride sensor. You can check that the stride sensor is enabled by the measurement icon on the screen.

#### Measurement screen: Chronograph

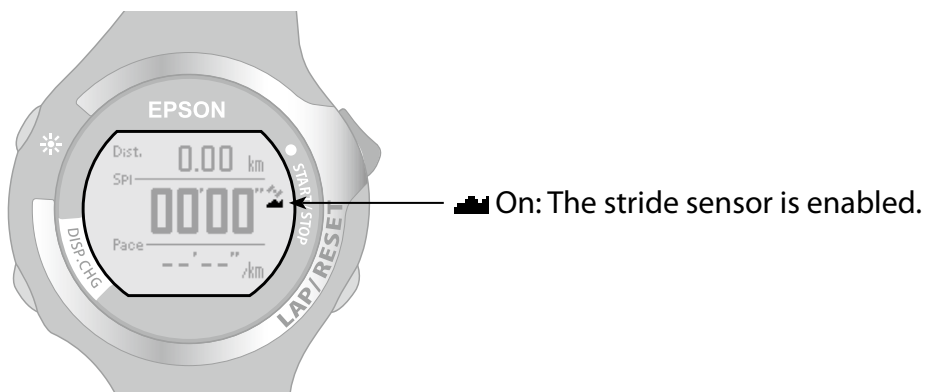

# Measuring Heart Rate (SS-700/SS-500 Only)

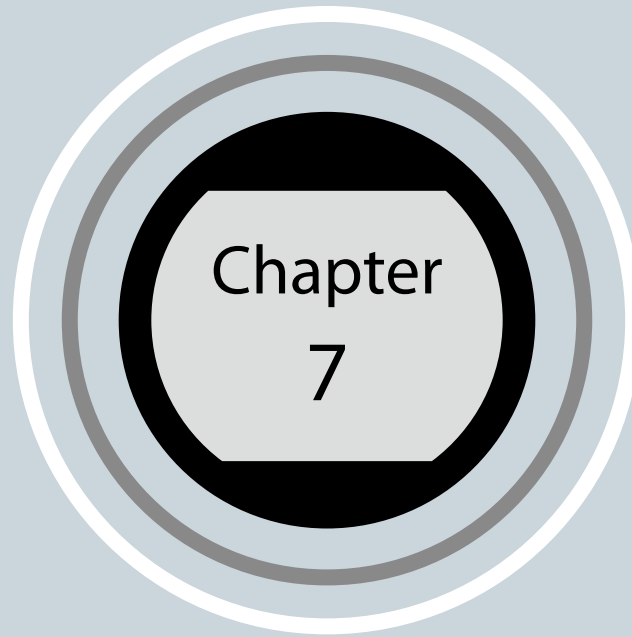

- 
- 7-1 About heart rate measurements
  - 7-2 Wearing the HR sensor set
  - 7-3 Pairing
  - 7-4 Enabling the HR sensor
  - 7-5 Replacing the battery for the HR sensor
-

## 7-1 About heart rate measurements

You can measure your heart rate by wearing the HR sensor set.

HR sensor measurements are only available for the SS-700/SS-500.

For the SS-700, use the set provided. For the SS-500, purchase the set as an optional item (SSHRKIT01).

### ■ HR sensor set

---

The HR sensor set is made up of the HR belt and the HR sensor.

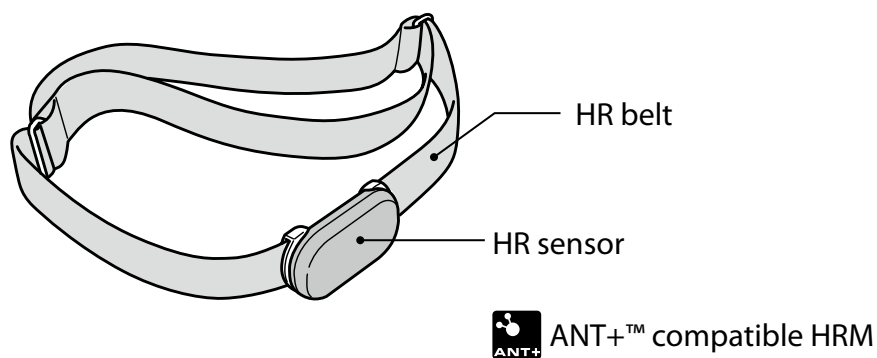

**Make sure you perform pairing when using the HR sensor set for the first time (→ [P. 65](#)).**

When using the HR sensor set for the first time, perform pairing while wearing the HR sensor set.

## 7-2 Wearing the HR sensor set

Wear the HR belt so that the electrode section of the HR belt is pressed against your chest.

Adjust the HR belt so that it is not too tight.

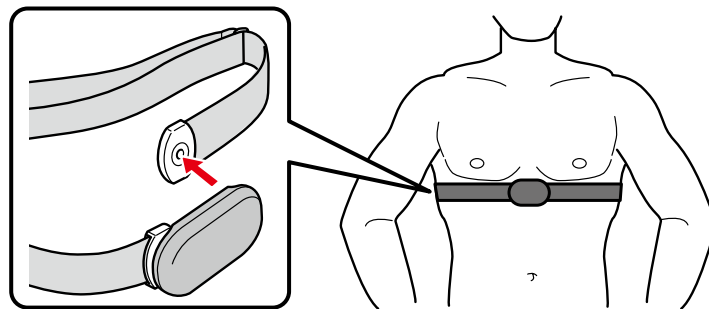

### Tips

- You can perform stable measurements when the electrode section of the HR belt is a little wet.

#### HR sensor set - rear

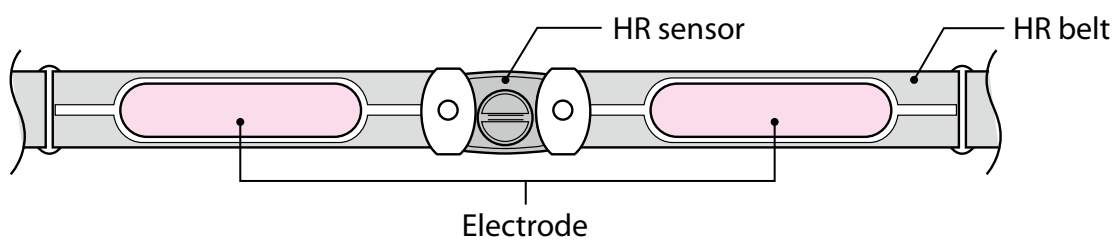

- You need to perform pairing in advance when using the HR sensor set for the first time (→ [P. 65](#)).
  - When you are wearing the HR sensor set, turn on the [HR Sensor] (→ [P. 67](#)).
-



## 7-3 Pairing

When using the HR sensor set for the first time, perform pairing while wearing the HR sensor set.

- 1 Check that there are no other HR sensors close by, and then wear the HR sensor set that you want to pair (→ [P. 64](#)).
- 2 Press **A** to display the [Menu].

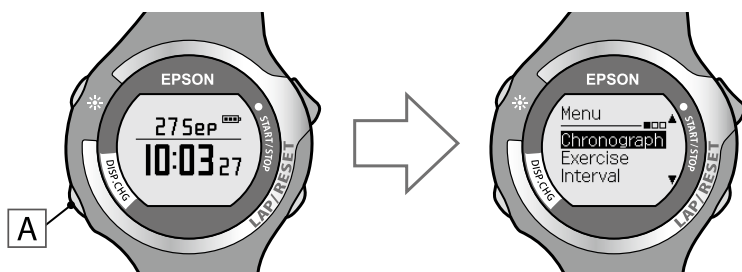

- 3 Use **C** / **D** to highlight [Settings], and then press **A**.  
The [Settings] function selection screen is displayed.

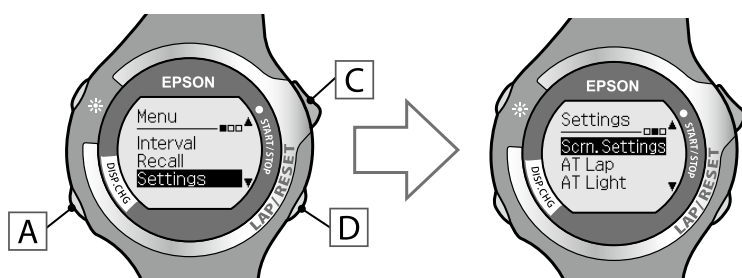

- 4** Use [C] / [D] to highlight [HR Sensor], and then press [A].

The [HR Sensor] settings screen is displayed.

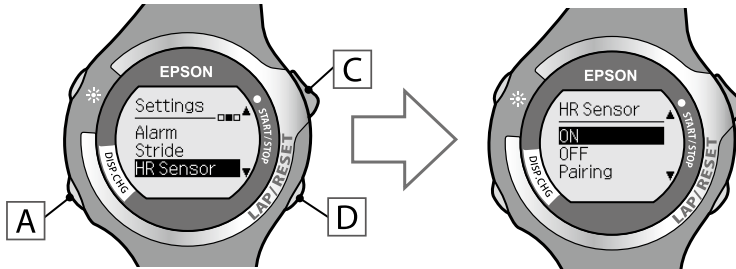

- 5** Use [C] / [D] to highlight [Pairing], and then press [A].

When pairing is completed successfully, [Pairing Finish] is displayed.

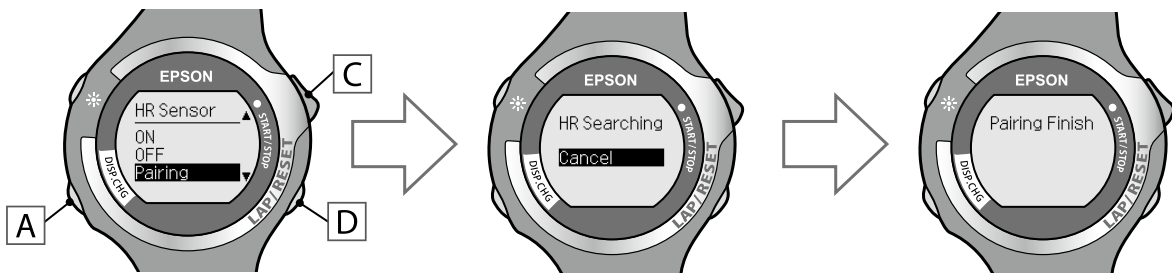

- 6** Press [A] to return to the [Menu] screen.

## 7-4 Enabling the HR sensor

When using the HR sensor set, set [HR Sensor] to [ON].

- 1 Press **A** to display the [Menu].

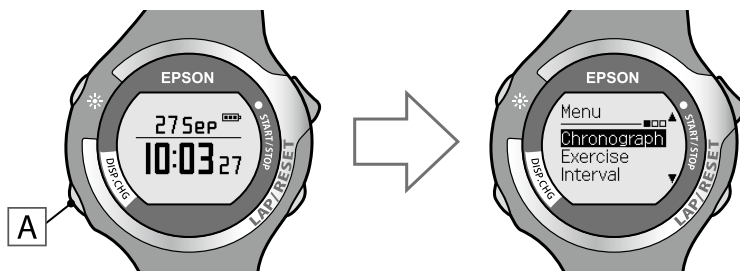

- 2 Use **C** / **D** to highlight [Settings], and then press **A**.

The [Settings] function selection screen is displayed.

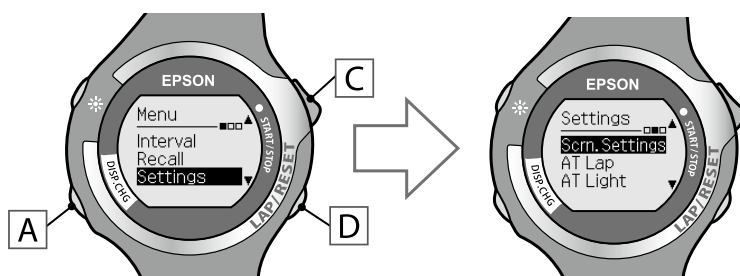

- 3 Use **C** / **D** to highlight [HR Sensor], and then press **A**.

The [HR Sensor] settings screen is displayed.

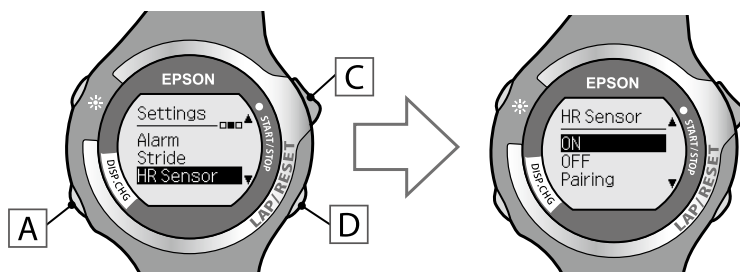

**4** Use **[C]** / **[D]** to highlight **[ON]**, and then press **[A]**.

After confirming the selection, the **[Settings]** screen is displayed.

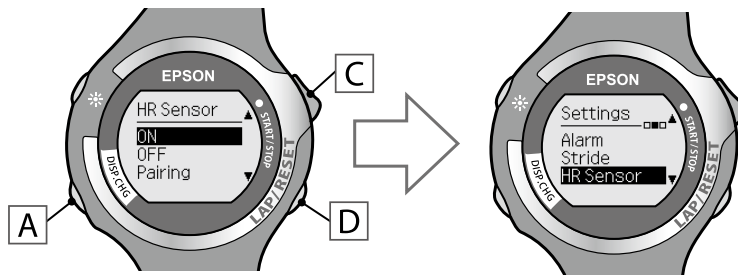

When **[HR Sensor]** is set to **[ON]**, is displayed on the chronograph, exercise, and interval measurement screen.

**5** Hold down **[A]** for at least two seconds to return to the **[Menu]** screen.

When the HR sensor is set to **[ON]**, the battery life for the device is reduced (→ P. 16).  
When you are not using the HR sensor, set **[HR Sensor]** to **[Off]**.

**Tips**

To turn this function off, select **[OFF]** in step **4**.

When the **[HR Sensor]** is set to **[ON]**, you can measure your heart rate while using the chronograph, exercise, or interval functions.

You can check the status of the HR sensor from the measurement icon on the screen.

**Measurement screen: Chronograph**

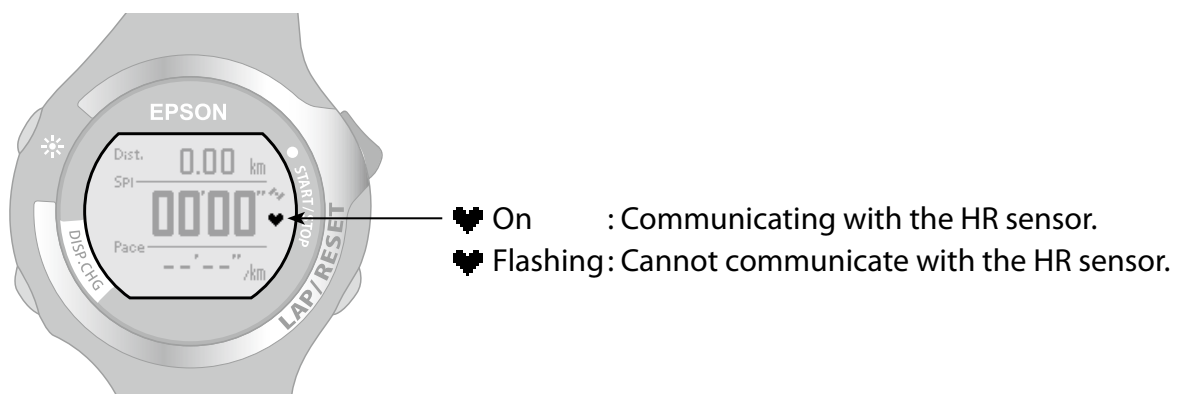

## Chapter 7

### Measuring Heart Rate (SS-700/SS-500 Only)

---

#### Tips

- If  is flashing, check that you are wearing the HR sensor set correctly (→ [P. 64](#)).
  - The examples used while checking the HR (heart rate) are shown in “Noting heart rate while running (SS-700/SS-500 only)” (→ [P. 113](#)).
-

## 7-5 Replacing the battery for the HR sensor

If you cannot measure your heart rate, the battery may have run out. Replace the battery. Install a CR2032 battery in the HR sensor.

- 1** Use something flat, such as a coin, to remove the battery cover.

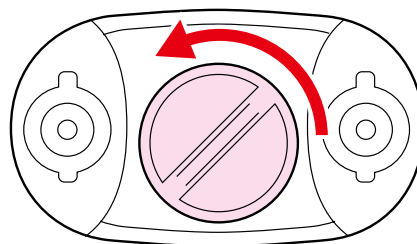

- 2** Remove the battery, and reset the HR sensor.

Turn the battery over and replace it, wait for at least three seconds, and then remove it.

Make sure - is facing up.

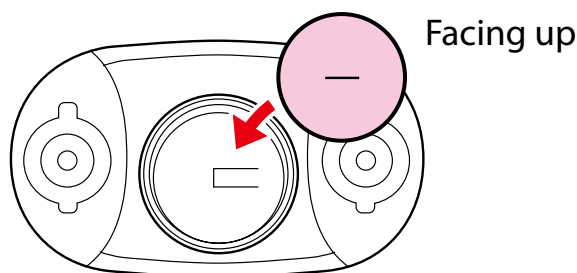

### Tips

#### Why reset the HR sensor?

Any remaining charge in the HR sensor circuitry is dispersed by removing the battery, reinserting it with the negative side facing up, and waiting for at least three seconds. If the HR sensor temporarily freezes, you can restore operation by using this method.

**3** Insert a new battery.

Make sure + is facing up.

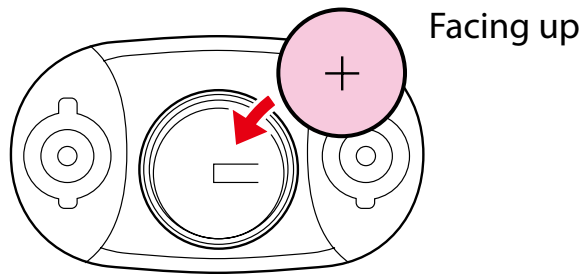

**4** Replace the battery cover.

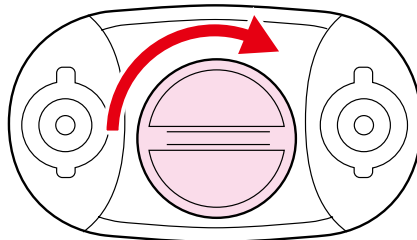

---

**Tips**

If the internal packing has come out, close the cover after putting it back in its original position.

---





## 8-1 About the settings function

In [Settings], you can change various settings for the device including the measurement values displayed on the chronograph screen, turn the stride sensor/HR sensor on or off, and set targets and intervals for exercising.

Make settings to suit the way you use the device.

### ■ Settings list

Function items		Summary	Default settings	More information
Scrn. Settings	Screen 1 Screen 2 Screen 3	Select values displayed on the chronograph screen from the following items. <b>Selection items:</b> <b>Distance, Pace, Lap Pace, Average Pace, Speed, Split Time, Lap Time, Pitch*, Stride*, Time, Calories Burnt, Altitude, HR*, Lap HR*, Average HR*, Guide Time, Guide Distance</b>	Screen 1 Top: Distance (Dist.) Middle: Split time (Spl) Bottom: Pace (Pace) Screen 2 Top: Distance (Dist.) Middle: Time (Time) Bottom: Pace (Pace) Screen 3 Top: Distance (Dist.) Middle: Calories burnt (Cal.) Bottom: Pace (Pace)	→ <a href="#">P. 75</a>
AT Lap		Turns the auto lap function on and off. This automatically measures laps over a fixed running distance. Sets the lap distance when set to On.	OFF	→ <a href="#">P. 79</a>
AT Light		When measuring laps, the light turns on or off automatically when measuring starts, stops, or restarts, and when changing between sprint and rest when the alarm is triggered.	OFF	→ <a href="#">P. 81</a>
AT Pause		Turns the auto pause function on or off. This automatically stops measuring when you stop running, and resumes when you continue running.	OFF	→ <a href="#">P. 83</a>

\* Only displayed for the SS-700/SS-500.

## Chapter 8

### About Settings











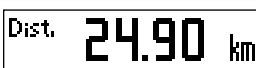



Function items	Summary	Default settings	More information
Alarm	Set the alarm conditions for distance, pace, and HR* (heart rate).	OFF	➔ <a href="#">P. 85</a>
Stride*	Turns the stride sensor measurement function on or off.	OFF	➔ <a href="#">P. 60</a>
HR Sensor*	Turns communication with the HR sensor on or off.	OFF	➔ <a href="#">P. 67</a>
Target Pace	Sets the standard target pace. You can also display the guide time/guide distance.	8'00"/km	➔ <a href="#">P. 36</a>
Interval	Sets the interval (for sprint/rest) for distance or time.	Sprint Setting: Distance/1.0 km Rest Settings: Distance/1.0 km Repeat No.: 1	➔ <a href="#">P. 44</a>
Sys.Settings	Sets basic items such as distance units and language. <b>Setting items:</b> <b>Contrast, Distance Units, Time Zone, Summer Time, Clock, Language, Clear History</b>	Contrast: 4 Distance Units: km Time Zone: +9 Summer Time: OFF Clock: 12 Hour Language: English Clear History: NO	➔ <a href="#">P. 95</a>
User Settings	Set the user data. <b>Setting items:</b> <b>Height, Weight, DOB, Gender</b>	Height: 170 cm Weight: 65 kg DOB: 1975/1/1 Gender: Male	➔ <a href="#">P. 101</a>

\* Only displayed for the SS-700/SS-500.

## 8-2 Screen settings

You can change the measurement items displayed on each level of the chronograph screen.

### ■ Display items

Display item	Display name	Display example*1	More information
Distance	Dist.		Total distance from start of measurements
Pace	Pace		Current pace
Lap pace	PaceLa		Average pace for each section
Average pace	PaceAv		Average pace from start of measurements
Speed	Speed		Current speed
Split time	Spl		Total time from start of measurements
Lap time	Lap		Time for each section
Pitch*2	Pitch		Current pitch
Stride*2	Stride		Current stride
Time	Time		Current time
Calories burnt	Cal.		Current calories burnt through exercise
Altitude*3	Alti.		Current altitude
HR *2	HR		Current heart rate
HR lap*2	HR Lap		Average heart rate for current lap
Average HR*2	HR Avg.		Average heart rate from start of measurements
Guide time*4	Guide		Progress time towards target pace (reaching target or falling behind)
Guide distance*4	Guide		Progress distance towards target pace (reaching target or falling behind)

\*1: Display example when [Settings] - [Sys.Settings] - [Distance Units] is set to "km".

\*2: Only displayed for the SS-700/SS-500.

\*3: Altitude measurements are taken using the GPS signal. There may be a large error in altitude measurements depending on the GPS reception environment and so on.

\*4: Although the display name is always the same, "Guide", the guide time and distance are differentiated by numbers or units.

## ■ Screen settings

Regarding the settings screen, examples of display item combinations are provided in "Usage Guide (Screen Settings According to Your Needs)" (➔ P. 106).

**1** Press **[A]** to display the [Menu].

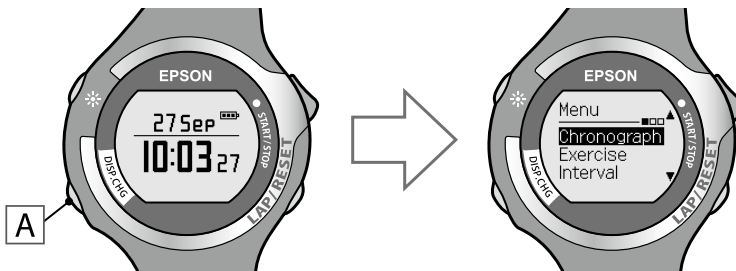

**2** Use **[C]** / **[D]** to highlight [Settings], and then press **[A]**.

The [Settings] function selection screen is displayed.

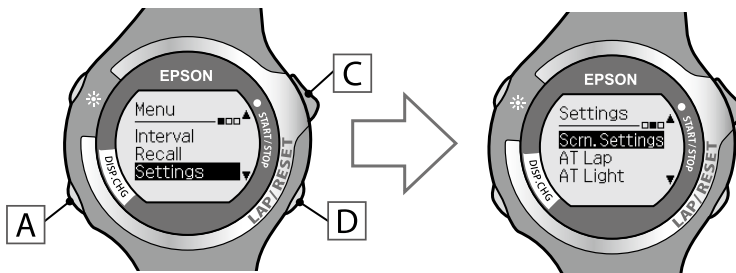

**3** Use **[C]** / **[D]** to highlight [Scrn.Settings], and then press **[A]**.

The [Select Screen] is displayed.

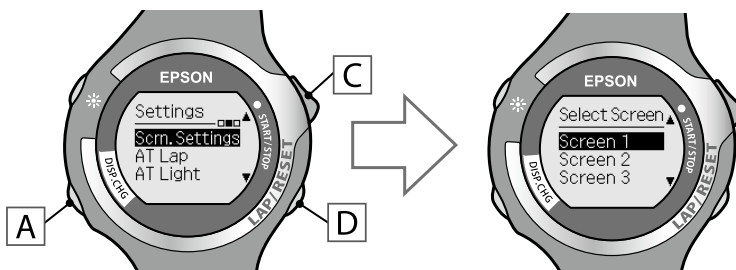

- 4** Use **[C]** / **[D]** to highlight the settings screen you want, and then press **[A]**.

The screen allowing you to select which part of the screen (top, middle, or bottom) is displayed.

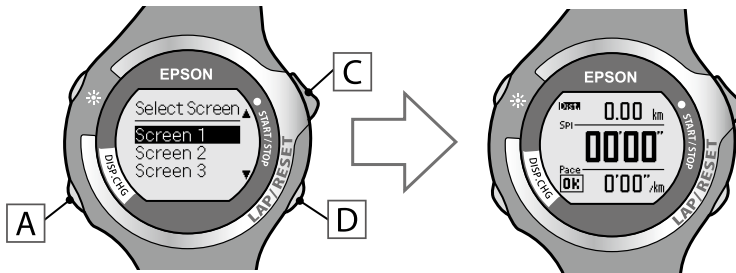

- 5** Use **[C]** / **[D]** to highlight the area (top, middle, or bottom) of the screen you want to select, and then press **[A]**.

The measurement value selection screen is displayed.

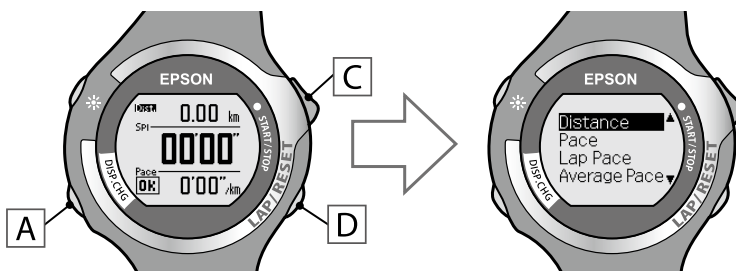

- 6** Use **[C]** / **[D]** to highlight the setting you want, and then press **[A]**.

The displayed values change.

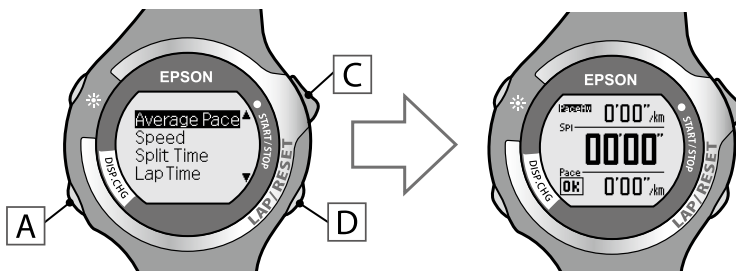

- 7** After setting the target section, use **C** / **D** to highlight [OK], and then press **A**.

Select [OK] to confirm the changed display item.

After confirming the selection, the select screen is displayed.

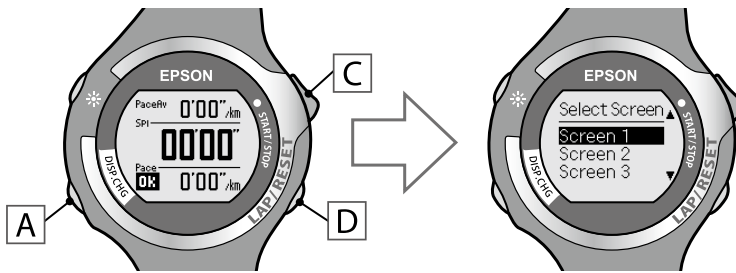

- 8** Hold down **A** for at least two seconds to return to the [Settings] screen.
- 9** Hold down **A** for at least two seconds to return to the [Menu] screen.

## 8-3 Auto lap

Automatically measures laps when running a fixed distance.  
You can turn this function on or off, and set the lap distance.

**1** Press **A** to display the [Menu].

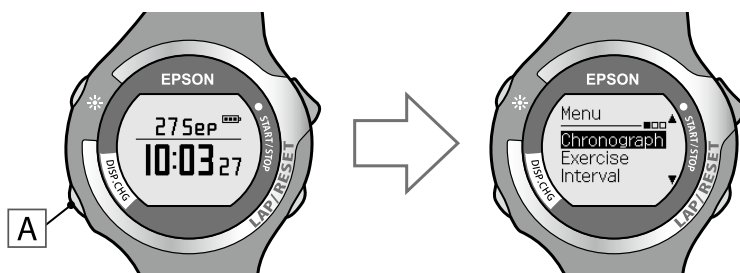

**2** Use **C** / **D** to highlight [Settings], and then press **A**.  
The [Settings] function selection screen is displayed.

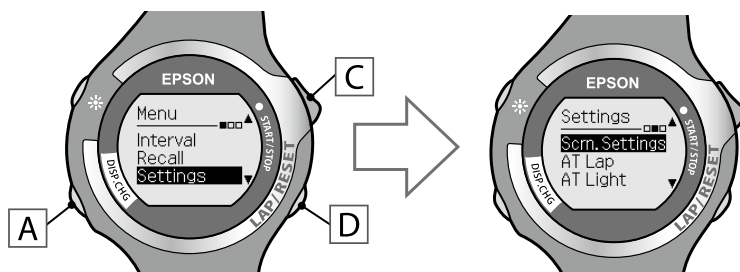

**3** Use **C** / **D** to highlight [AT Lap], and then press **A**.  
The [AT Lap] settings screen is displayed.

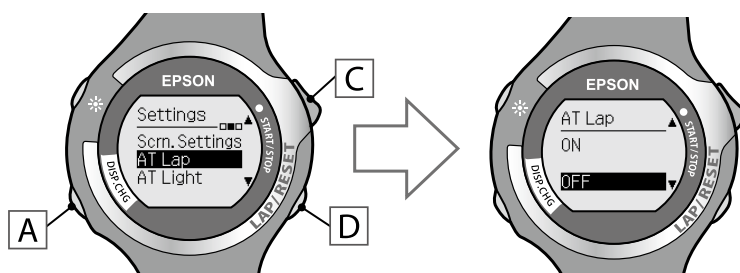

#### 4 Use **[C]** / **[D]** to highlight **[ON]**, and then press **[A]**.

The [Lap Distance] settings screen is displayed.

When [OFF] is selected, the [Settings] screen is displayed (➔ go to step 6).

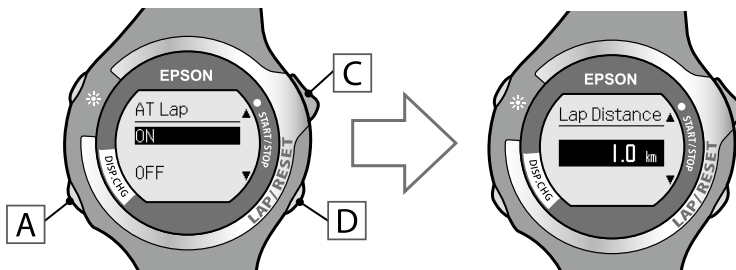

#### 5 Use **[C]** / **[D]** to set the lap distance, and then press **[A]**.

You can set the distance in increments of 0.1 kilometers from 0.1 to 10.0 km.

Hold down **[C]** / **[D]** to speed through the numbers.

After confirming the selection, the [Settings] screen is displayed.

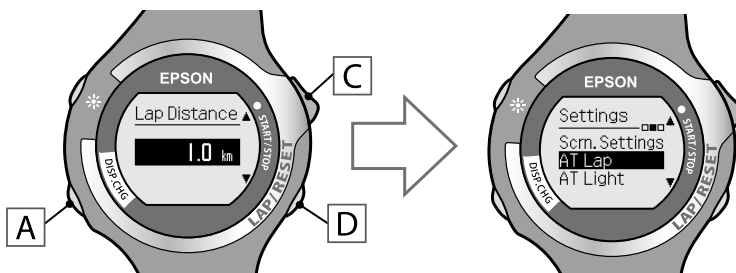

#### 6 Hold down **[A]** for at least two seconds to return to the [Menu] screen.

#### Tips

To turn this function off, select [OFF] in step 4.



## 8-4 Auto light

This function automatically turns on the light.  
You can turn this function on or off.

The light automatically turns on under the following conditions.

- When measuring laps using the auto lap function.
- When stopping or starting using auto pause.
- When changing between interval and rest using the Interval function, and when closing the function.
- When an alarm is triggered (distance alarm, pace alarm, or HR alarm).
- When measuring **[C]** (Start/Stop) or **[D]** (Lap) is pressed.

**1** Press **[A]** to display the [Menu].

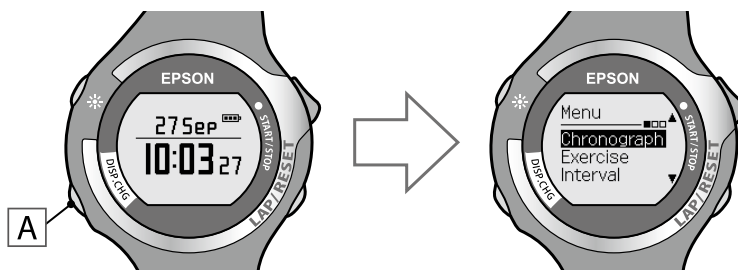

**2** Use **[C]** / **[D]** to highlight [Settings], and then press **[A]**.

The [Settings] function selection screen is displayed.

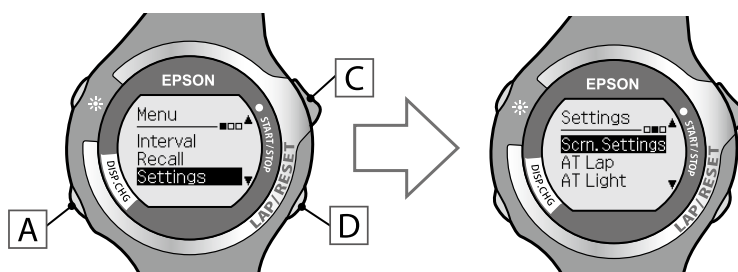

- 3** Use **C** / **D** to highlight **[AT Light]**, and then press **A**.

The **[AT Light]** settings screen is displayed.

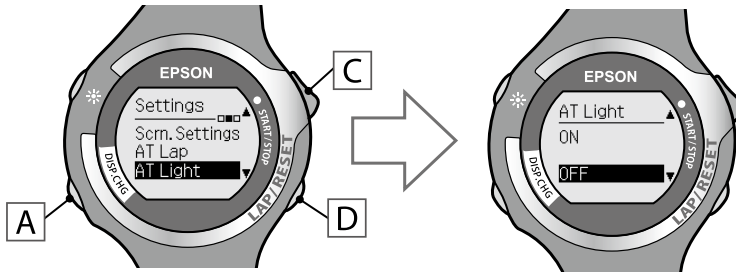

- 4** Use **C** / **D** to highlight **[ON]**, and then press **A**.

After confirming the selection, the **[Settings]** screen is displayed.

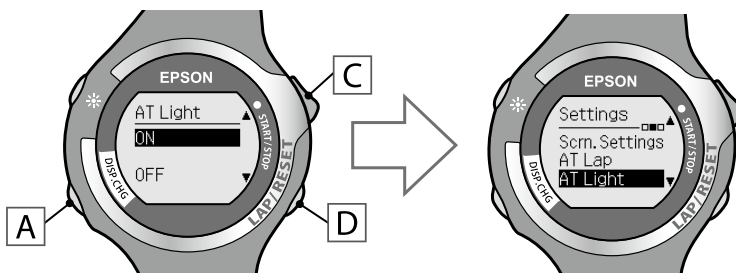

- 5** Hold down **A** for at least two seconds to return to the **[Menu]** screen.

---

**Tips**

To turn this function off, select **[OFF]** in step **4**.

---

## 8-5 Auto pause

Turns the auto pause function on or off. This automatically stops measuring when you stop running, and resumes when you continue running.

- 1 Press **A** to display the [Menu].

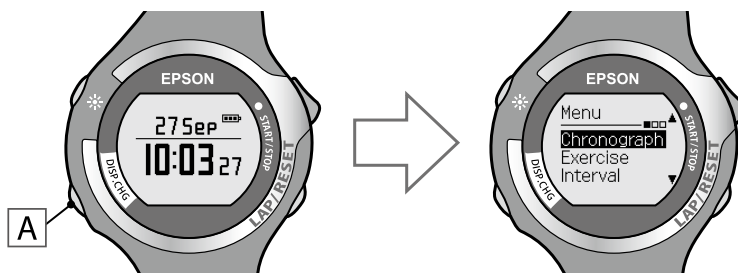

- 2 Use **C** / **D** to highlight [Settings], and then press **A**.

The [Settings] function selection screen is displayed.

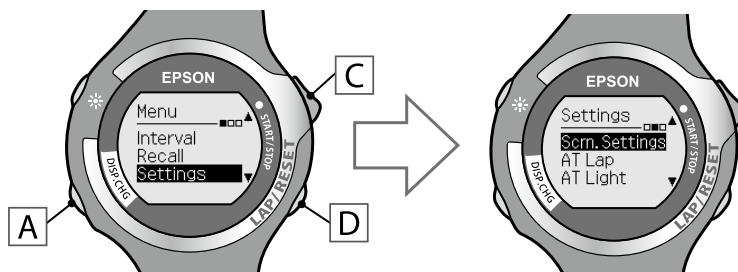

- 3 Use **C** / **D** to highlight [AT Pause], and then press **A**.

The [AT Pause] settings screen is displayed.

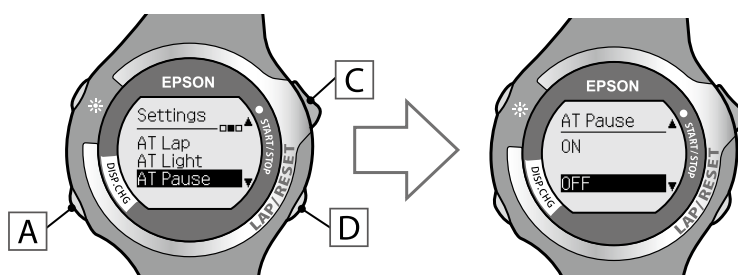

- 4** Use **C** / **D** to highlight **[ON]**, and then press **A**.

After confirming the selection, the **[Settings]** screen is displayed.

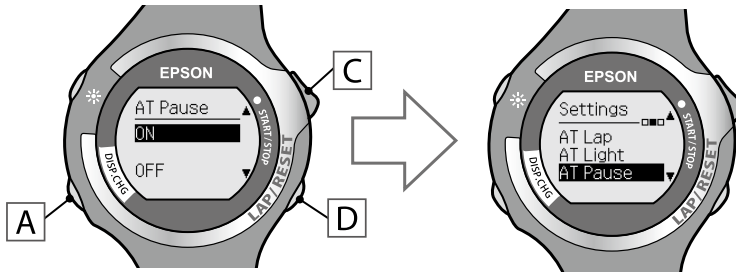

- 5** Hold down **A** for at least two seconds to return to the **[Menu]** screen.

#### Tips

---

To turn this function off, select **[OFF]** in step **4**.

---

## 8-6 Alarm

This sounds an alarm when you reach the distance, pace, or heart rate that you set. The alarm function allows you to select the type of alarm and the conditions under which the alarm sounds.

### ■ Selecting an alarm

- 1 Press **A** to display the [Menu].

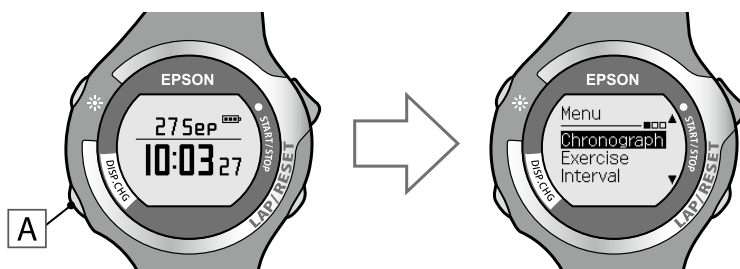

- 2 Use **C** / **D** to highlight [Settings], and then press **A**.  
The [Settings] function selection screen is displayed.

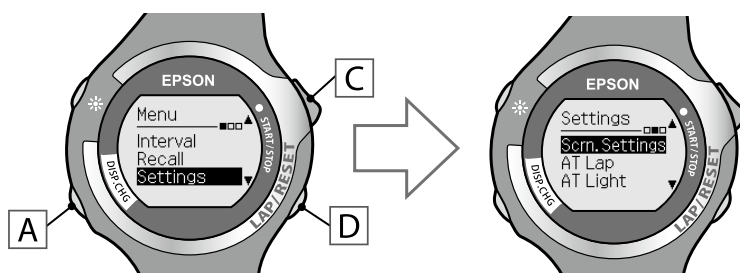

- 3 Use **C** / **D** to highlight [Alarm], and then press **A**.  
The [Alarm] function selection screen is displayed.

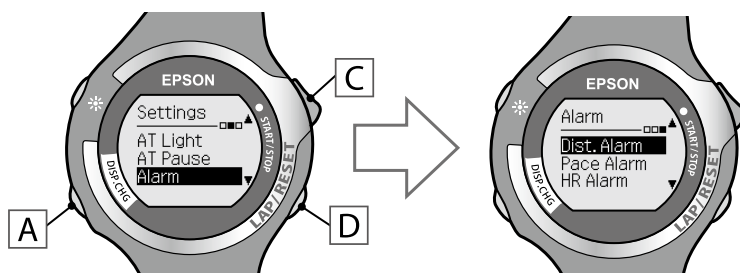

#### 4 Use [C] / [D] to highlight the target alarm, and then press [A].

The setting screen for the selected alarm is displayed. See the following pages for each alarm.

- Distance alarm → [P. 87](#)
- Pace alarm → [P. 89](#)
- HR alarm → [P. 92](#)

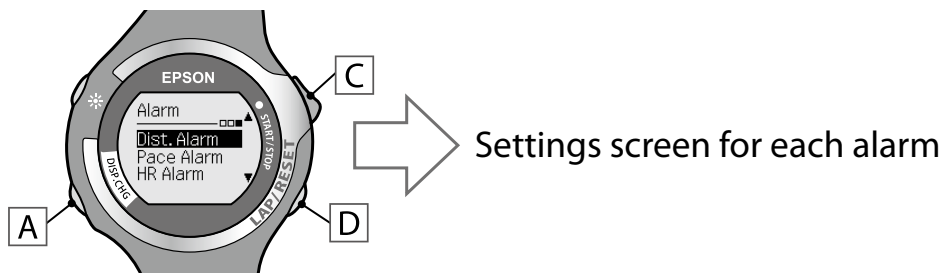

## ■ Setting the distance alarm

The distance alarm function notifies you when you have reached the target distance from the start of measurements.

You can set the distance at which the alarm sounds.

- 1 Select [Dist. Alarm] from [Menu] - [Settings] - [Alarm], and then press **A**.

The [Dist. Alarm] settings screen is displayed.

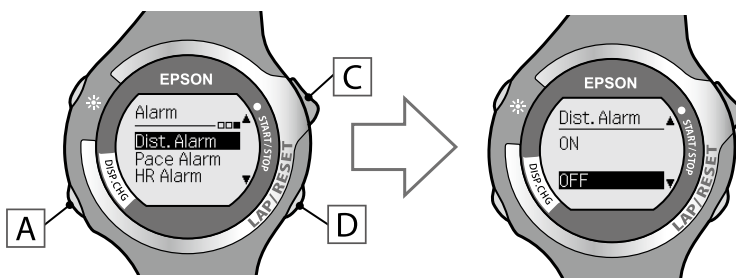

- 2 Use **C** / **D** to highlight [ON], and then press **A**.

Displays the setting screen for [Distance].

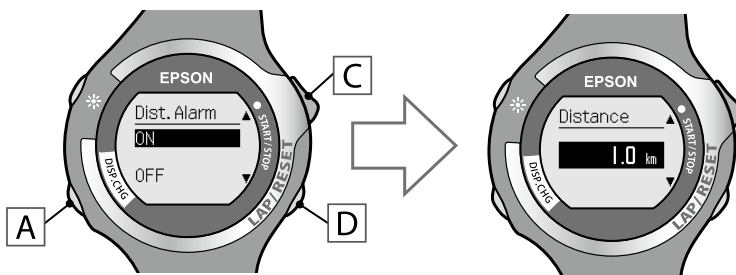

- 3** Use **[C]** / **[D]** to set the distance at which the alarm sounds, and then press **[A]**.

You can set the distance in increments of 0.1 kilometers from 0.1 to 100.0 km. Hold down **[C]** / **[D]** to speed through the numbers. After confirming the selection, the [Alarm] function selection screen is displayed.

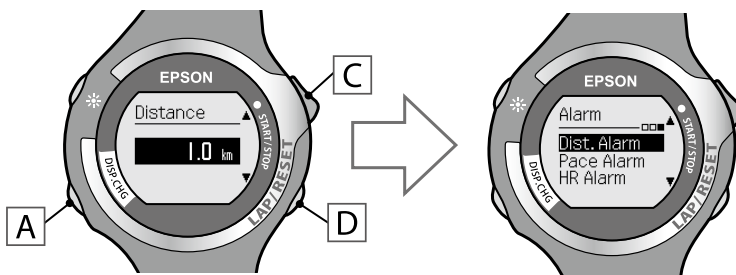

- 4** Hold down **[A]** for at least two seconds to return to the [Settings] screen.
- 5** Hold down **[A]** for at least two seconds to return to the [Menu] screen.

---

**Tips**

To turn this function off, select [OFF] in step **2**.

---



## ■ Setting the pace alarm

The pace alarm notifies you when you have reached the target pace that you set. You can set the maximum and minimum pace at which the alarm sounds.

- 1 Select [Pace Alarm] from [Menu] - [Settings] - [Alarm], and then press **A**.

The [Max. Pace] settings screen is displayed.

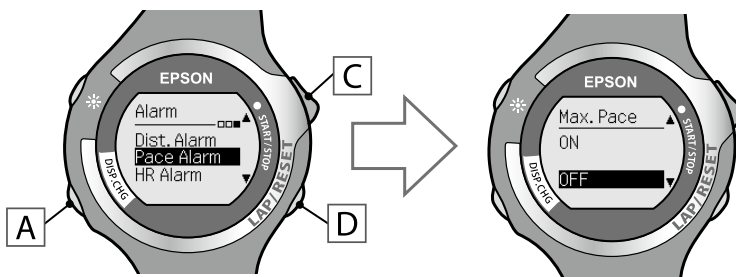

- 2 Use **C** / **D** to highlight [ON] or [OFF], and then press **A**.

Select [ON] to set the maximum pace limit (→ go to step 3).

Select [OFF] to set the minimum pace without setting the maximum pace (→ go to step 4).

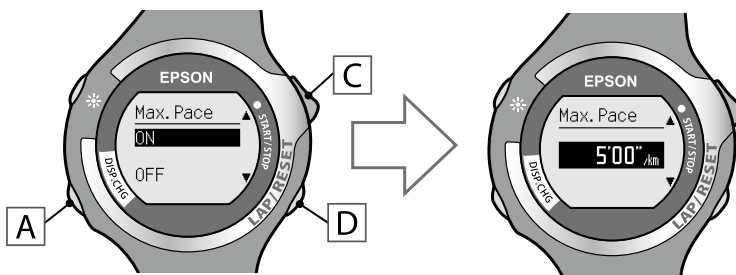

- 3** Use **[C]** / **[D]** to set the maximum pace at which the alarm sounds, and then press **[A]**.

You can set the pace in increments of 0'01" km within a range of 1'00" to 15'00" km.

Hold down **[C]** / **[D]** to speed through the numbers.

After confirming the selection, the [Min. Pace] screen is displayed.

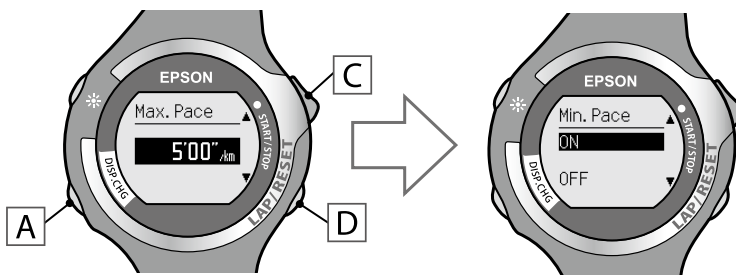

- 4** Use **[C]** / **[D]** to highlight **[ON]** or **[OFF]**, and then press **[A]**.

Select **[ON]** to set the minimum pace limit (→ go to step **5**).

Select **[OFF]** when settings are complete without setting a minimum pace (→ go to step **6**).

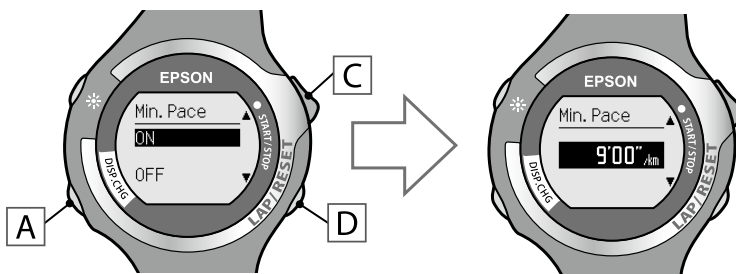

- 5** Use **[C]** / **[D]** to set the minimum pace at which the alarm sounds, and then press **[A]**.

You can set the pace in increments of 0'01" km within a range of 1'00" to 15'00" km.

Hold down **[C]** / **[D]** to speed through the numbers.

After confirming the selection, the [Alarm] function selection screen is displayed.

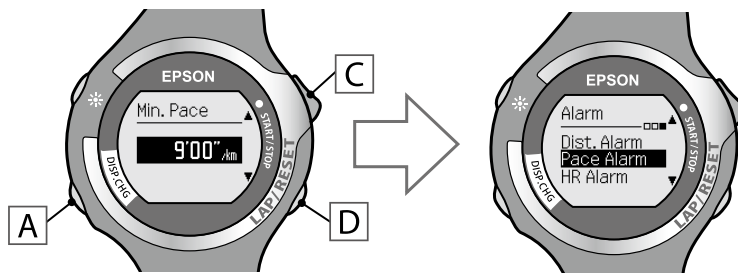

- 6** Hold down **[A]** for at least two seconds to return to the [Settings] screen.

- 7** Hold down **[A]** for at least two seconds to return to the [Menu] screen.

---

**Tips**

To turn this function off, select [OFF] in step **2** and step **4**.

---

## ■ Setting the HR alarm (SS-700/SS-500 only)

The HR alarm notifies you when you have reached the target heart rate that you set. You can set the maximum and minimum heart rate at which the alarm sounds.

You need the HR sensor set to use the HR alarm (→ [P. 63](#)).

- 1 Select [HR Alarm] from [Menu] - [Settings] - [Alarm], and then press **A**.

The [Max. HR] settings screen is displayed.

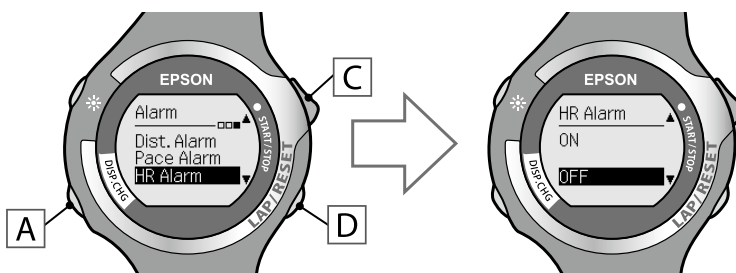

- 2 Use **C** / **D** to highlight [ON] or [OFF], and then press **A**.

Select [ON] to set the maximum heart rate limit (→ go to step **3**).

Select [OFF] to set the minimum heart rate without setting the maximum heart rate (→ go to step **4**).

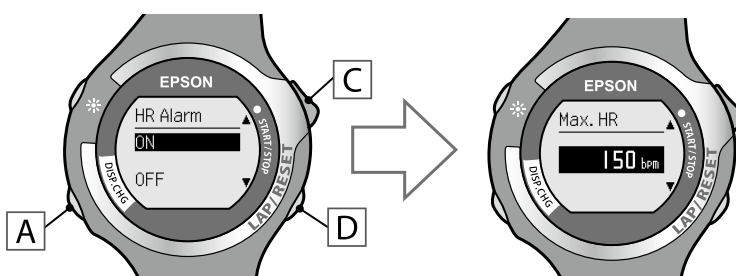

- 3** Use **[C]** / **[D]** to set the maximum heart rate at which the alarm sounds, and then press **[A]**.

You can set the HR (heart rate) in increments of 1 bpm within a range of 30 to 240 bpm.

Hold down **[C]** / **[D]** to speed through the numbers.

After confirming the selection, the [Min. HR] screen is displayed.

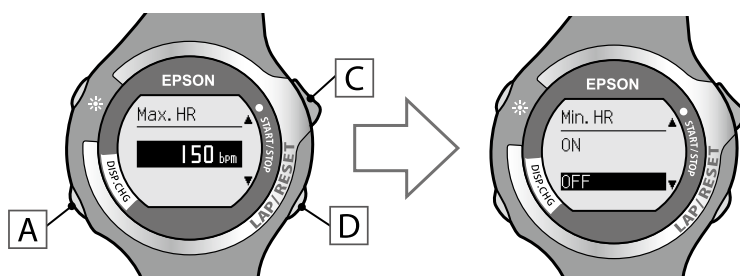

- 4** Use **[C]** / **[D]** to highlight **[ON]** or **[OFF]**, and then press **[A]**.

Select **[ON]** to set the minimum heart rate limit (→ go to step **5**).

Select **[OFF]** when settings are complete without setting a minimum heart rate (→ go to step **6**).

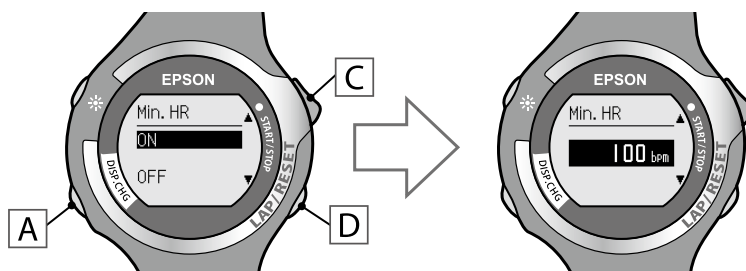

- 5** Use **[C]** / **[D]** to set the minimum heart rate at which the alarm sounds, and then press **[A]**.

You can set the HR (heart rate) in increments of 1 bpm within a range of 30 to 240 bpm.

Hold down **[C]** / **[D]** to speed through the numbers.

After confirming the selection, the [Alarm] function selection screen is displayed.

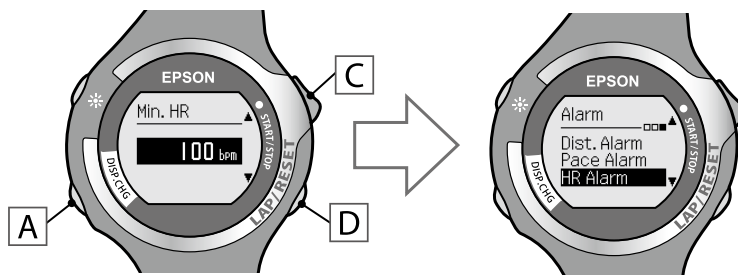

- 6** Hold down **[A]** for at least two seconds to return to the [Settings] screen.
- 7** Hold down **[A]** for at least two seconds to return to the [Menu] screen.

---

**Tips**

To turn this function off, select [OFF] in step **2** and step **4**.

---

## 8-7 System settings

You can set the following functions in system settings.

Function	Setting items	Summary
Contrast	1 to 7	Adjusts the screen contrast
Distance Units	· km · miles	Sets distance units.
Time Zone	+14 to -12	Sets the time zone for your location.
Summer time	· ON · OFF	Sets summer time to on or off.
Clock	· 12 Hour · 24 Hour	Sets the display time for the device using the 12 or 24 hour clock.
Language	· 日本語 (Japanese) · English	Sets the display language as Japanese or English.
Clear History	· NO · YES	Clears all measurement data (➔ P. 98).

**1** Press **[A]** to display the [Menu].

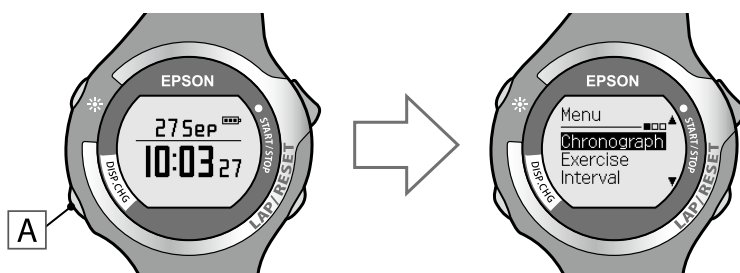

**2** Use **[C]** / **[D]** to highlight [Settings], and then press **[A]**.

The [Settings] function selection screen is displayed.

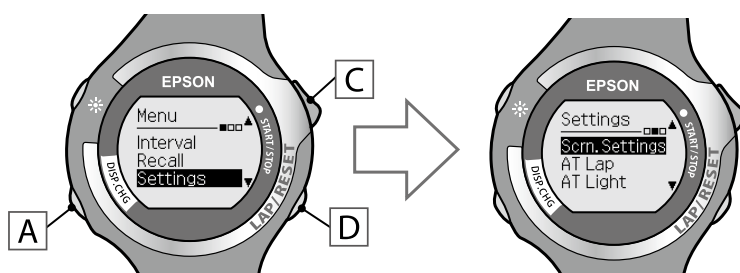

Continued ▶▶▶

**3** Use **C** / **D** to highlight [Sys. Settings], and then press **A**.

Allows you to select settings for [Sys. Settings].

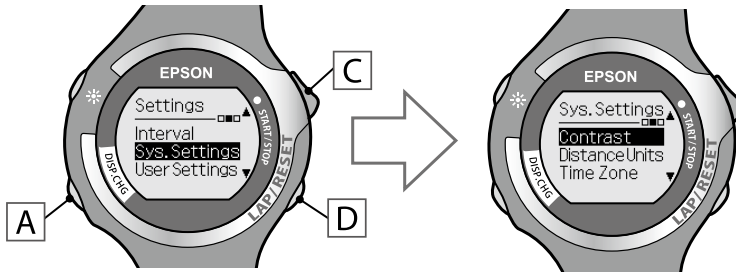

**4** Use **C** / **D** to highlight the function you want to set, and then press **A**.

Displays the setting screen for each function.

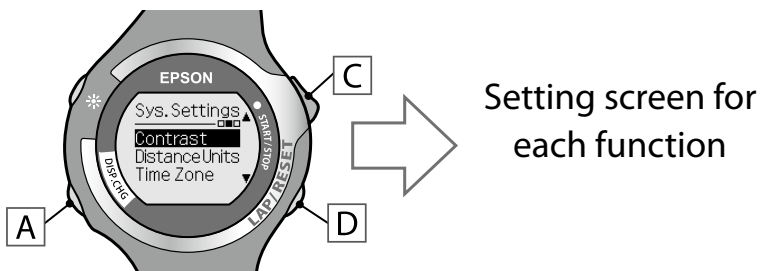

**5** Use **C** / **D** to highlight the value, and then press **A**.

After confirming the selection, the [Sys. Settings] screen is displayed.

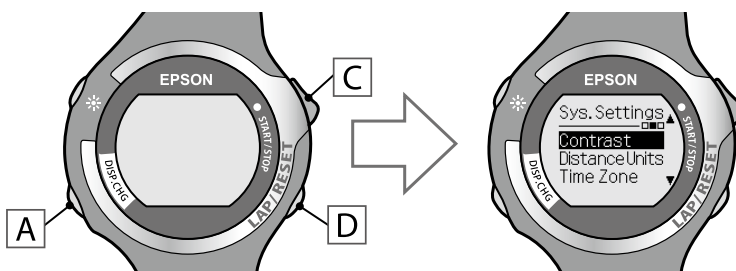

Setting screen for  
each function





- 6 Hold down **A** for at least two seconds to return to the [Settings] screen.
- 7 Hold down **A** for at least two seconds to return to the [Menu] screen.

## 8-8 Clear history

If the free space for the memory in the device is running low, the  icon is displayed. You can clear the management data by performing [Clear History]. When the data has been cleared, the  icon turns off.

Measurement screen: Chronograph

 On: Free space in the memory is running low



### Tips

Upload the measurement data that you want to store in the Web application (➔ [P. 119](#)).

**1** Press **A** to display the [Menu].

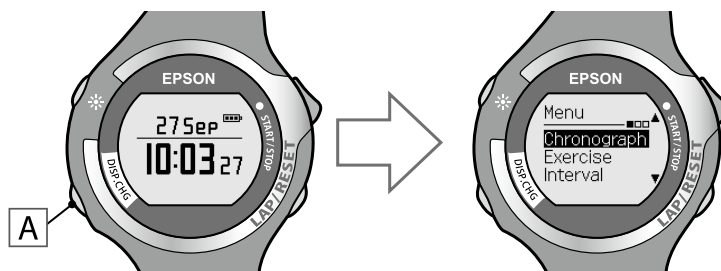

- 2** Use **[C]** / **[D]** to highlight **[Settings]**, and then press **[A]**.

The **[Settings]** function selection screen is displayed.

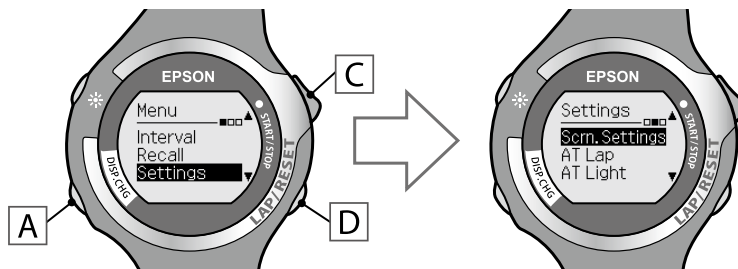

- 3** Use **[C]** / **[D]** to highlight **[Sys. Settings]**, and then press **[A]**.

Allows you to select settings for **[Sys. Settings]**.

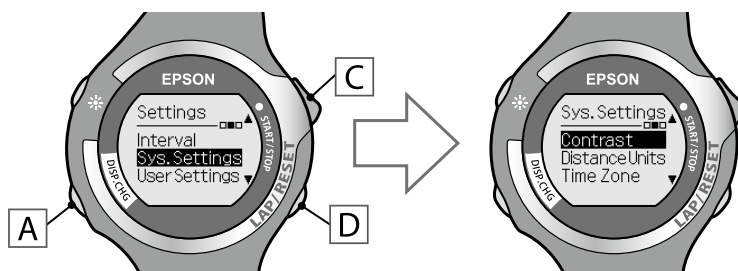

- 4** Use **[C]** / **[D]** to highlight **[Clear History]**, and then press **[A]**.

The **[Clear History]** settings screen is displayed.

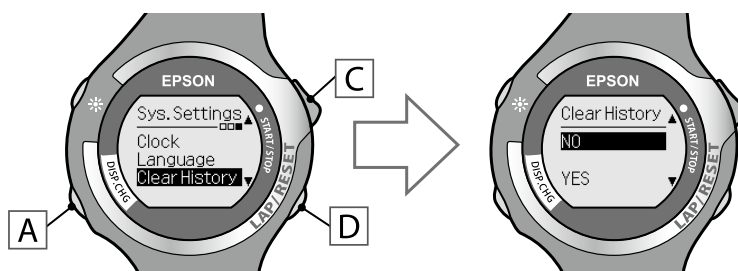

- 5** Use **C** / **D** to highlight **[YES]**, and then press **A**.

The "Complete" screen is displayed.

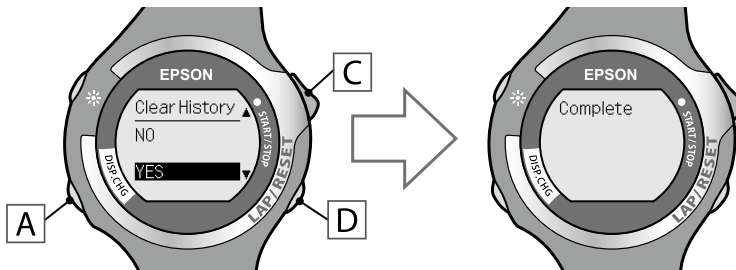

- 6** Press **A** to return to the **[Sys.Settings]** screen.
- 7** Hold down **A** for at least two seconds to return to the **[Settings]** screen.
- 8** Hold down **A** for at least two seconds to return to the **[Menu]** screen.

## 8-9 User settings

Sets the user's information (height, weight, date of birth, gender).  
This is used to calculate calories burnt.

**1** Press **A** to display the [Menu].

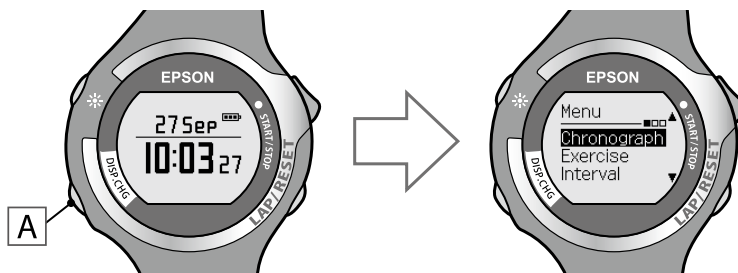

**2** Use **C** / **D** to highlight [Settings], and then press **A**.  
The [Settings] function selection screen is displayed.

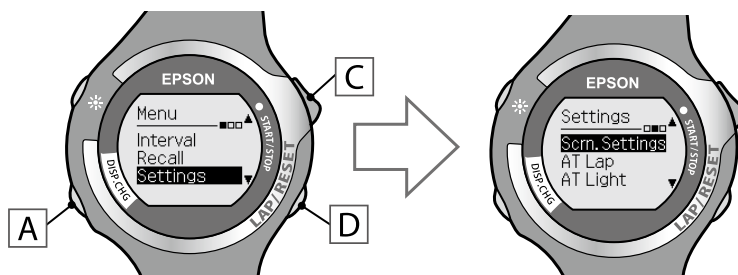

**3** Use **C** / **D** to highlight [User Settings], and then press **A**.  
Allows you to select settings for [User Settings].

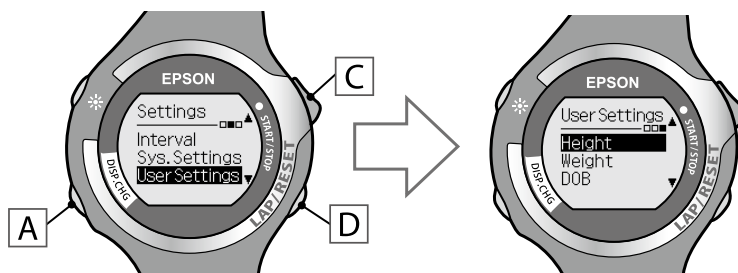

**4** Use **[C]** / **[D]** to highlight **[Height]**, and then press **[A]**.

Displays the setting screen for **[Height]**.

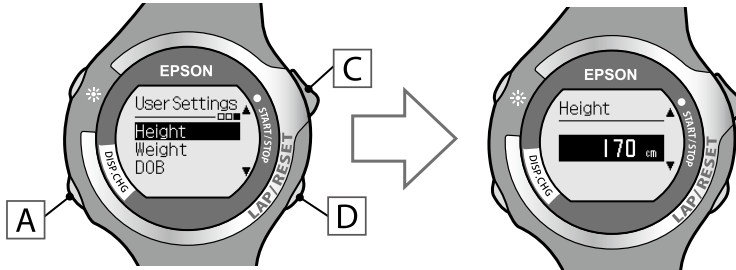

**5** Press **[C]** / **[D]** to enter the user's height, and then press **[A]**.

You can set the height in increments of one centimeter from 0 to 220 cm.

Hold down **[C]** / **[D]** to speed through the numbers.

After confirming the selection, the **[User Settings]** screen is displayed.

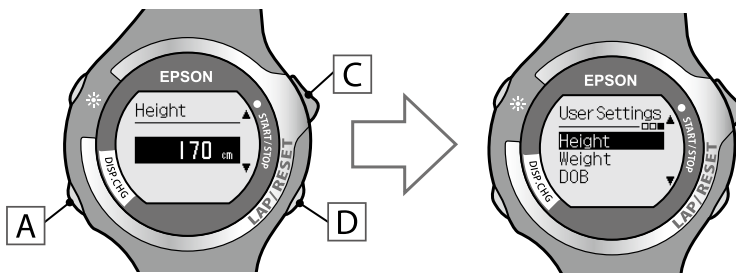

**6** Use **[C]** / **[D]** to highlight **[Weight]**, and then press **[A]**.

Displays the setting screen for **[Weight]**.

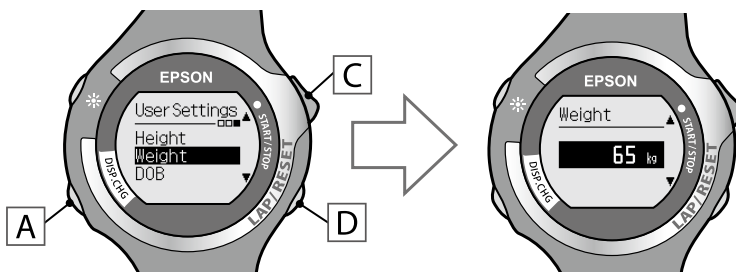

**7** Press **[C]** / **[D]** to enter the user's weight, and then press **[A]**.

You can set the weight in increments of one kilogram from 0 to 200 kg.  
Hold down **[C]** / **[D]** to speed through the numbers.  
After confirming the selection, the [User Settings] screen is displayed.

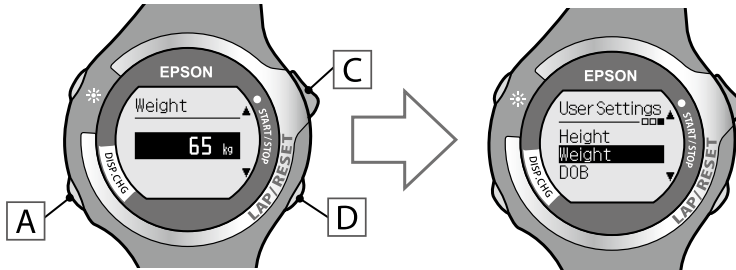

**8** Use **[C]** / **[D]** to highlight [DOB], and then press **[A]**.

Displays the setting screen for [DOB Year].

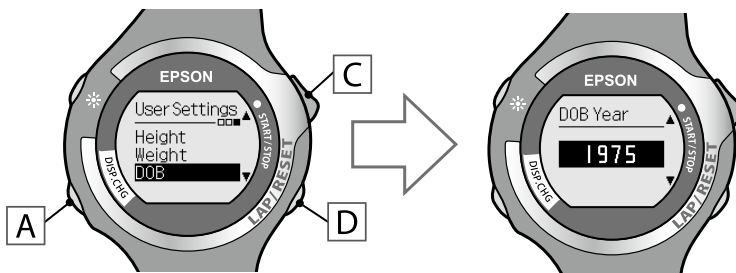

**9** Press **[C]** / **[D]** to enter the user's year of birth, and then press **[A]**.

You can set the year from 1910 to 2020.  
Hold down **[C]** / **[D]** to speed through the numbers.  
After confirming the selection, the [DOB Month] settings screen is displayed.

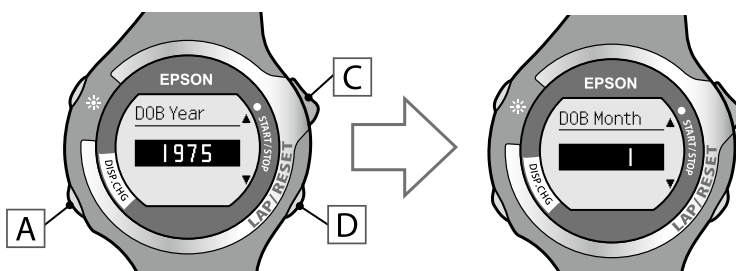

- 10** Press **[C]** / **[D]** to enter the user's month of birth, and then press **[A]**.

You can set the month from 1 to 12.

Hold down **[C]** / **[D]** to speed through the numbers.

After confirming the selection, the [DOB Day] settings screen is displayed.

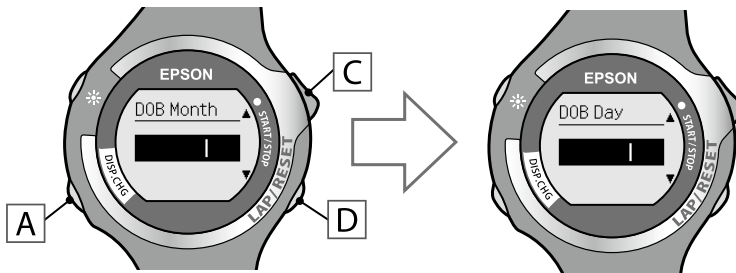

- 11** Press **[C]** / **[D]** to enter the user's day of birth, and then press **[A]**.

You can set the day from 1 to 31.

Hold down **[C]** / **[D]** to speed through the numbers.

After confirming the selection, the [User Settings] screen is displayed.

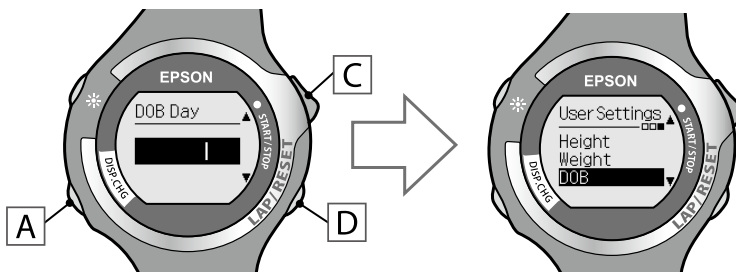

- 12** Use **[C]** / **[D]** to highlight [Gender], and then press **[A]**.

Displays the setting screen for [Gender].

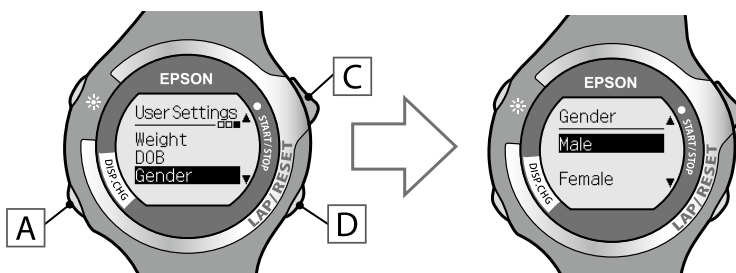



- 13** Press **C** / **D** to highlight the user's gender, and then press **A**.

After confirming the selection, the [User Settings] screen is displayed.

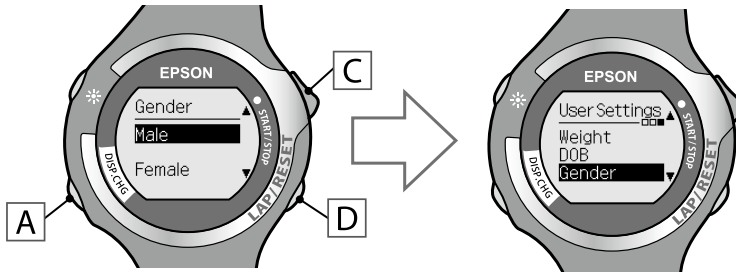

- 14** Hold down **A** for at least two seconds to return to the [Settings] screen.
- 15** Hold down **A** for at least two seconds to return to the [Menu] screen.



## 9-1 Settings on the chronograph screen

You can display chronograph items on the screen according to your needs and purposes (→ [P. 75](#)).

This section explains how to change the display items to suit your needs.

### Default screen settings

All three items are displayed on one screen during chronograph measurement.

There are three measurement screens available. You can change screens by pressing **A**.

The following items are displayed by default.

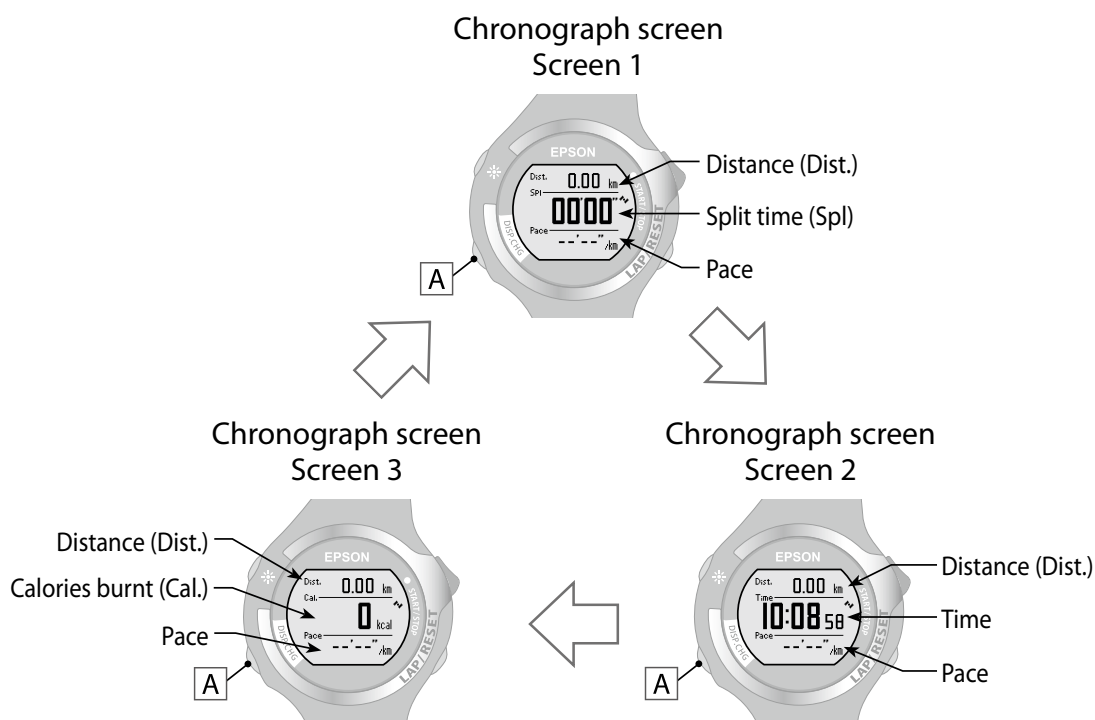

These sections explain how to change the display items for the following purposes.

- Noting distance and pace while running → [P. 108](#)
- Noting pitch and stride while running → [P. 110](#)
- Noting targets while running → [P. 111](#)
- Noting heart rate while running → [P. 113](#)

## 9-2 Noting distance and pace while running

The default screen settings when the device is purchased allow you to check distance and current pace while running. This is suitable for exercising and for competitions.

### Screen settings (default settings)

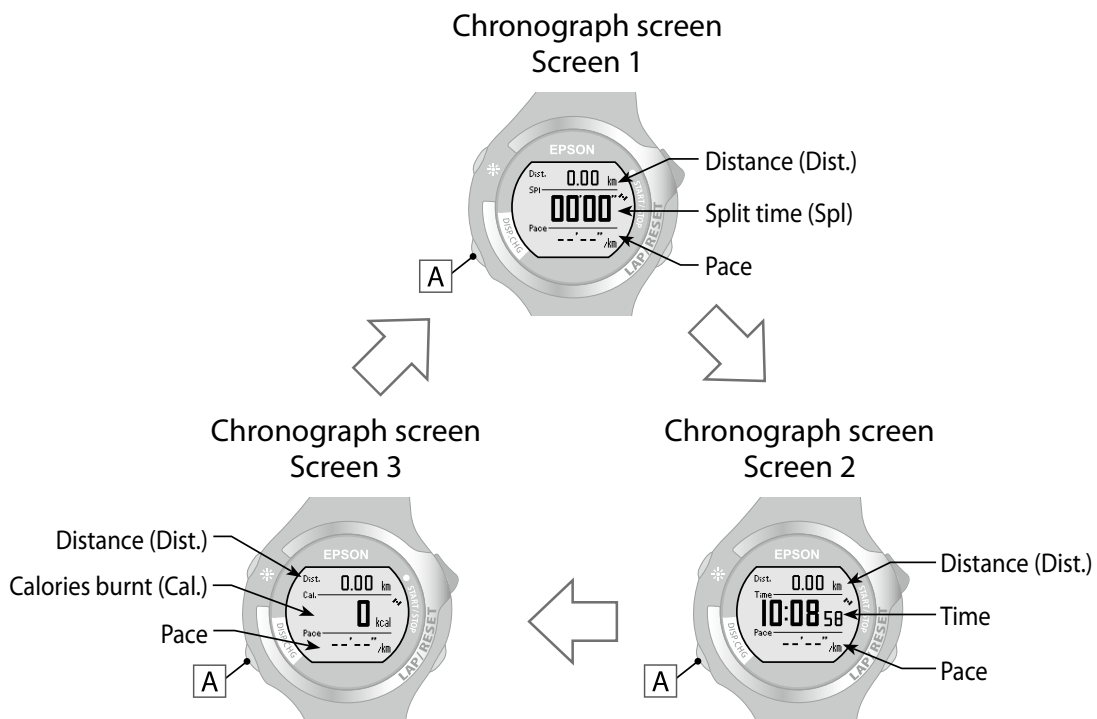

	Screen 1	Screen 2	Screen 3
Top row	Distance (Dist.)	Distance (Dist.)	Distance (Dist.)
Middle row	Split time (Spl)	Time	Calories burnt (Cal.)
Bottom row	Pace	Pace	Pace

#### Tips

- Split Time (Spl) displays the overall time that has lapsed.
- Pace displays the current pace (time taken to run one kilometer).

#### Checking the measurement screen

Screen 1 is the main screen to check while running.

Gives you a basic glimpse of your pace while running.

Maintain an even pace from start to finish while running. You can check the distance from when you started running, the elapsed time (split time), and if you are maintaining your target pace.

Press **[A]** to change to screen 2 and check the time. The time is displayed in the middle of screen 2.

#### Screen settings (changing from the default settings)

##### ● Changing the pace display

The following three types of pace can be displayed on the device.

When you need to check your pace for each section, such as when running in a competition, we recommend displaying the lap pace (PaceLa).

Pace	Displays the current pace. (The extent of display fluctuation differs depending on the GPS reception conditions and so on.)
Lap pace (PaceLa)	Displays the average pace for the current lap.
Average pace (PaceAv)	Displays the average pace from measurement start to finish.

##### ● Using the auto lap function

When using in a location in which you do not know the distance, we recommend using auto lap (→ [P. 79](#)). When [AT Lap] is set to [ON], laps are automatically measured for the set distance. The default setting is [OFF].

---

#### Tips

Although auto lap is a useful function, the gap between the actual distance may increase during competitions in urban areas where GPS reception may be weak. If you are concerned about the gap between the actual display distance, set [AT Lap] to [OFF], and perform manual lap measurements (by pressing **[D]**).

---

## 9-3 Noting pitch and stride while running (SS-700/SS-500 only)

When running fast, there are two points to consider; the number of strides you take (Pitch) and the length of your stride (Stride). If you want to note your pitch and stride while running, we recommend using the following screen.

### Screen settings (changing from the default settings)

Change the middle and bottom sections of screen 3 from their default settings.

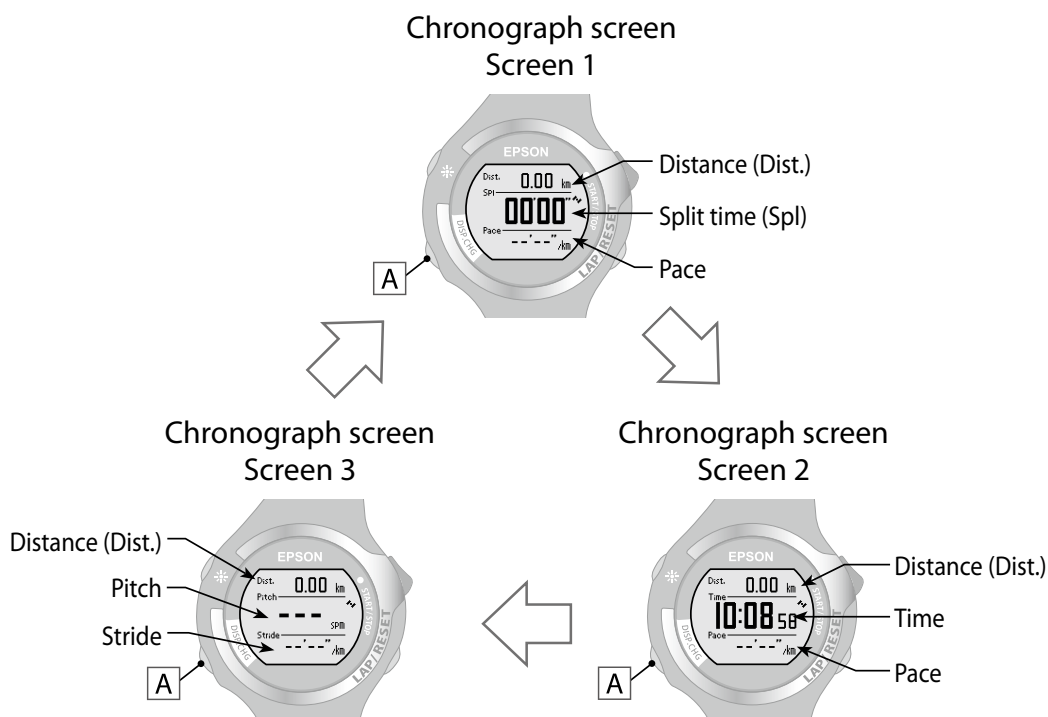

	Screen 1	Screen 2	Screen 3
Top row	Distance (Dist.)	Distance (Dist.)	Distance (Dist.)
Middle row	Split time (Spl)	Time	Pitch
Bottom row	Pace	Pace	Stride

 : Change from default setting

#### Tips

To measure pitch and stride, set [Stride] to [ON] (→ [P. 60](#)).

### Checking the measurement screen

Press **[A]** to change to screen 3 and then run. You can check the pitch and stride while running.

## 9-4 Noting targets while running

If you want to note how close or far you are from your target pace, we recommend using the following screen.

### Screen settings (changing from the default settings)

Change the middle and bottom sections of screen 2 from their default settings.

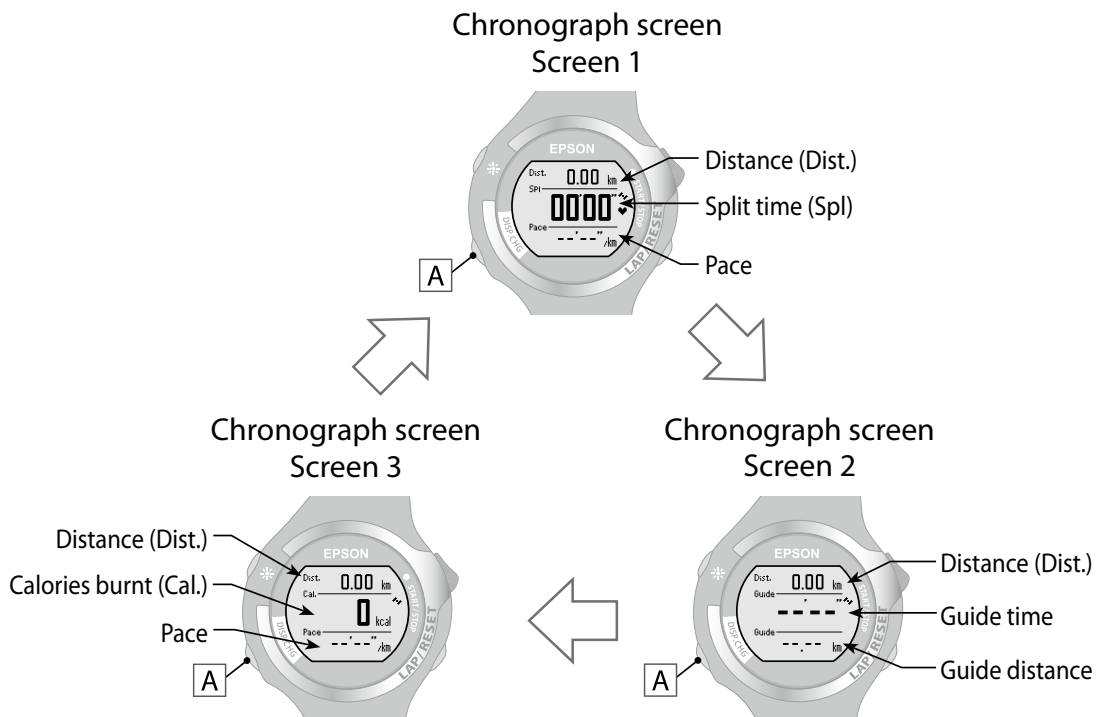

	Screen 1	Screen 2	Screen 3
Top row	Distance (Dist.)	Distance (Dist.)	Distance (Dist.)
Middle row	Split time (Spl)	Guide time (Guide)	Calories burnt (Cal.)
Bottom row	Pace	Guide distance (Guide)	Pace

 : Change from default setting

### Checking the measurement screen

Press **[A]** to change to screen 2 and then run.

You can check the time difference between your current time and target time in guide time, and the difference between your current distance and target distance in guide distance.

When displaying the guide time and distance, an arrow indicating if you are behind your target or if you have exceeded your target is shown on the left. This allows you to note how close you are to exceeding your target while running.

 (Pointing down): Slower than target pace

 (Pointing up) : Faster than target pace

#### Guide time display example



#### Guide distance display example

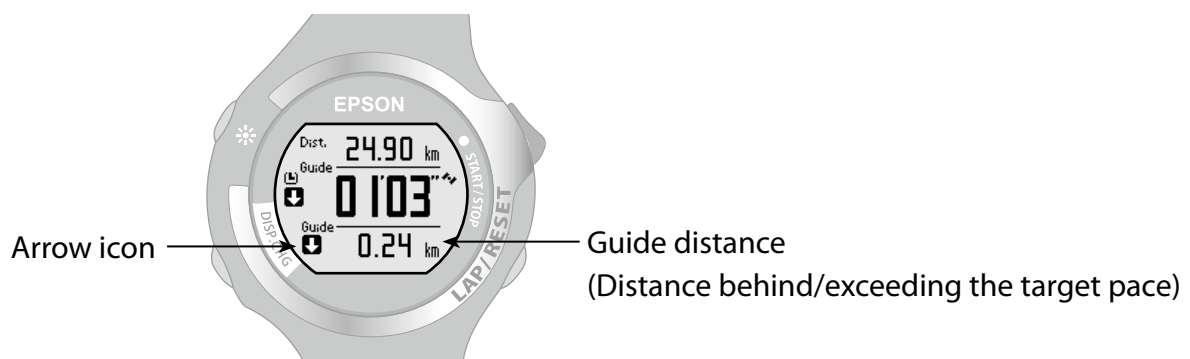

---

#### Tips

- The displayed guide time and guide distance are calculated using the [Target Pace] settings. Set the [Target Pace] before starting measurements (➔ [P. 36](#)).
  - Although the display name is always the same, "Guide", the guide time and distance are differentiated by numbers or units.
-



## 9-5 Noting heart rate while running (SS-700/SS-500 only)

These are the recommended settings when you want to note your heart rate while running. Your heart rate increases as you increase the strength of your exercise, such as when speeding up your or running up hill. By noting your heart rate while running, you can adjust the strength of your exercise, or make sure that you are not running too fast.

### Tips

- Heart rate (HR) measurements are only available for the SS-700/SS-500. You need the HR sensor set to perform measurements (➔ [P. 63](#)).
- When using the HR sensor, perform pairing with the HR sensor (➔ [P. 65](#)), and then set [HR Sensor] to [ON] (➔ [P. 67](#)).

### Screen settings

Change the middle of screen 2 and the middle and lower sections of screen 3 from their default settings.

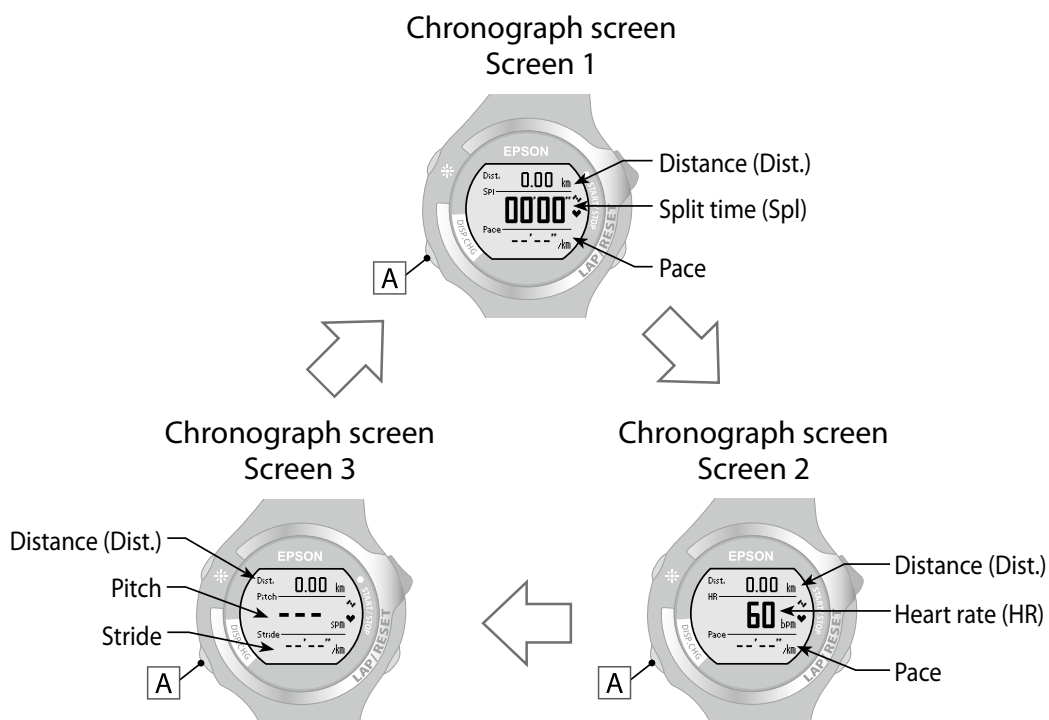

	Screen 1	Screen 2	Screen 3
Top row	Distance (Dist.)	Distance (Dist.)	Distance (Dist.)
Middle row	Split time (Spl)	Heart rate (HR)	Pitch
Bottom row	Pace	Pace	Stride

 : Change from default setting

Continued ▶▶▶

#### **Checking the measurement screen**

Press **[A]** to change to screen 2 and then run. You can check your heart rate while running.

Press **[A]** to change to screen 3 and check the pitch and stride.



## 10-1 Installing the NR Uploader

You can connect the device to a computer and then manage your measurement data with a dedicated Web application (NeoRun).

You need NR Uploader to upload measurement data to the Web application (NeoRun). Follow the steps below to install NR Uploader.

**Install NR Uploader before connecting the device to a computer.**

- 1 Access the following Web site and download NR Uploader.

<http://www.epson.jp/download/>

To upload measurement data, install the application on a computer that can connect to the Internet.

- 2 Run the downloaded file.

The Setup screen is displayed.

- 3 Select [accept the terms in the License Agreement], and then click [Install].

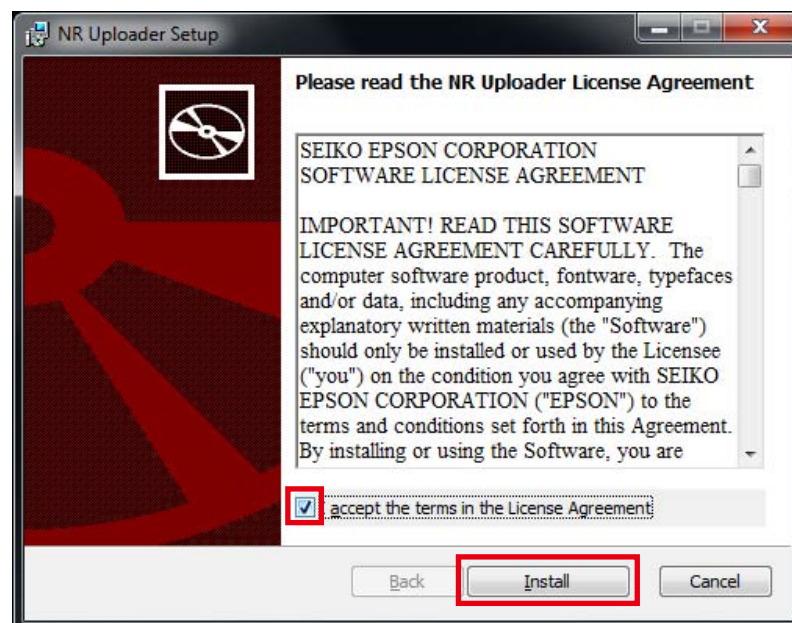

Installation starts.

Follow the on-screen instructions until the installation complete screen is displayed.

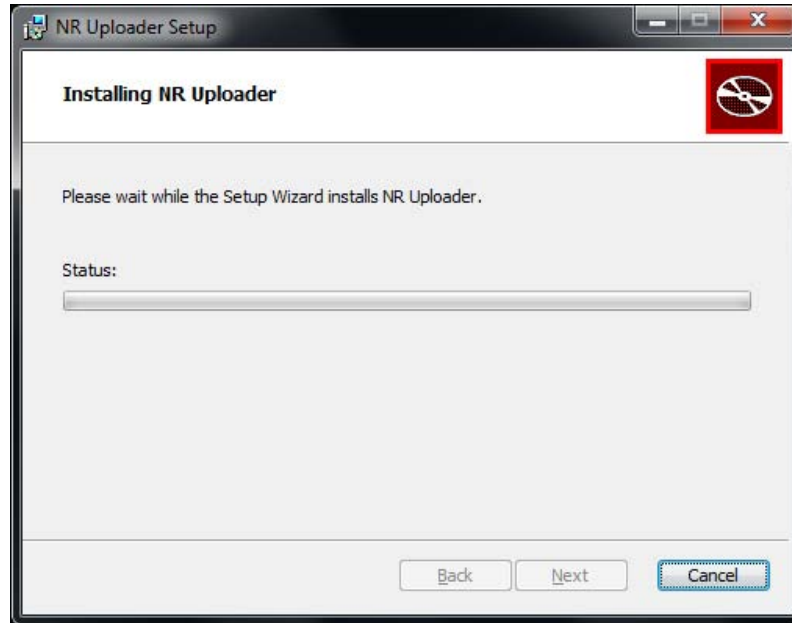

**4** When the completion screen is displayed, click [Finish].

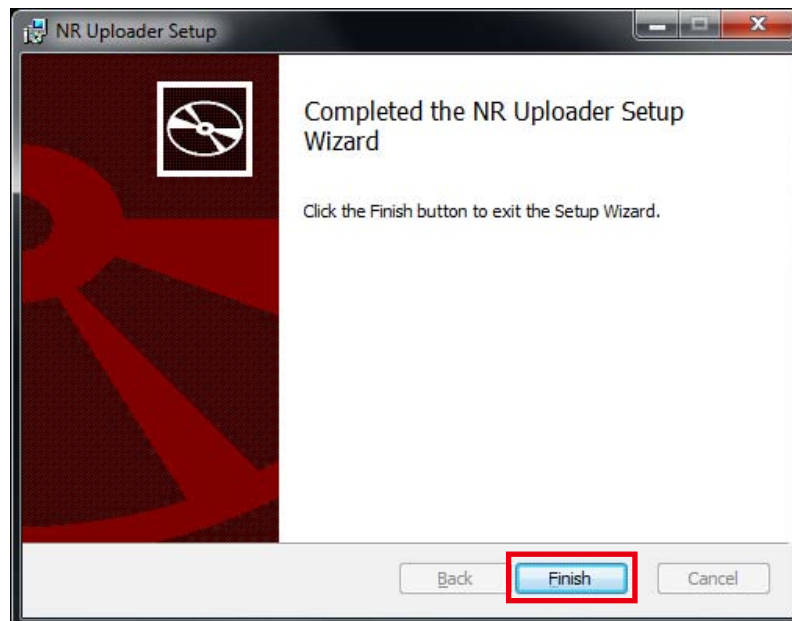

- 5 When a screen is displayed asking you to reboot your computer, click [Yes] to reboot.

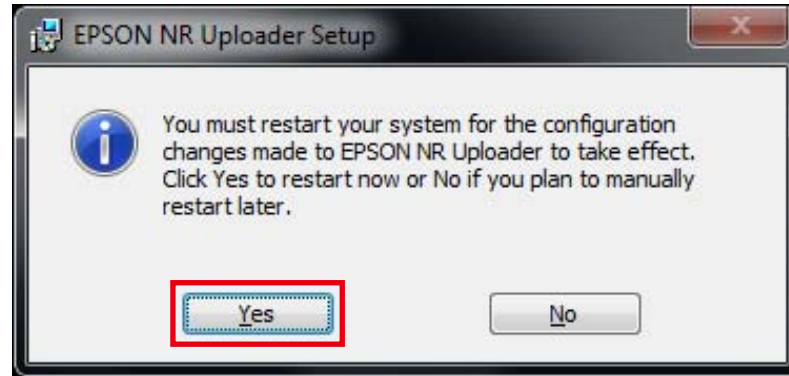

Installation is complete.

## 10-2 Connecting the device to a computer and using NeoRun

Connect the device to the computer on which NR Uploader is installed.

- 1 Connect the USB cable to the computer on which NR Uploader is installed and to the cradle.

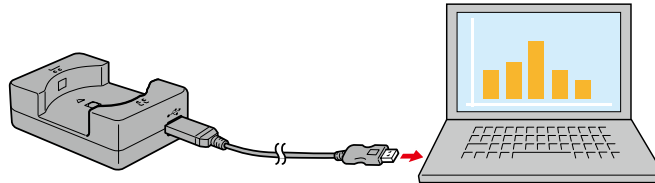

- 2 Place the product into the cradle.

**Do not place the device in the cradle if it is wet from water or sweat.**

Match the direction of the EPSON logo on the product with the EPSON logo on the cradle, and then press until it is fixed in place.

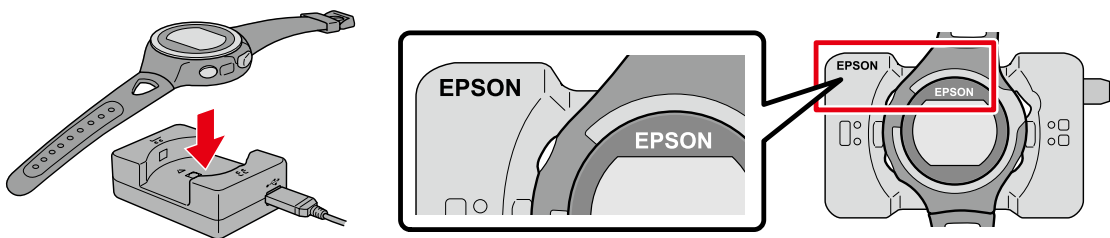

### Caution



Make sure the device is placed in the correct direction. A problem could occur if it is forced into the cradle in the wrong direction.

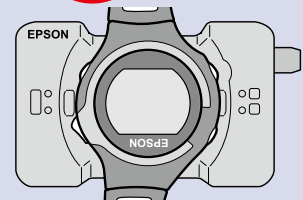

NR Uploader starts.

### Tips

If NR Uploader does not start, the device has not been recognized by the computer. Update the driver software (→ [P. 121](#)).

**3** Enter the login ID and password, and then click [Upload].

Data is uploaded to the Web application (NeoRun).

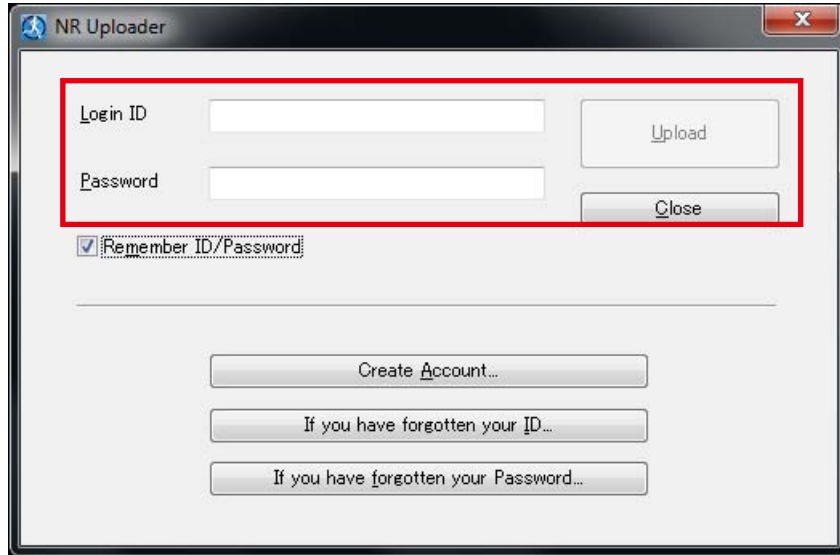

**Tips**

- You need an account (login ID and password) to use the Web application (NeoRun). When using the application for the first time, click [Create Account] to create a new account.

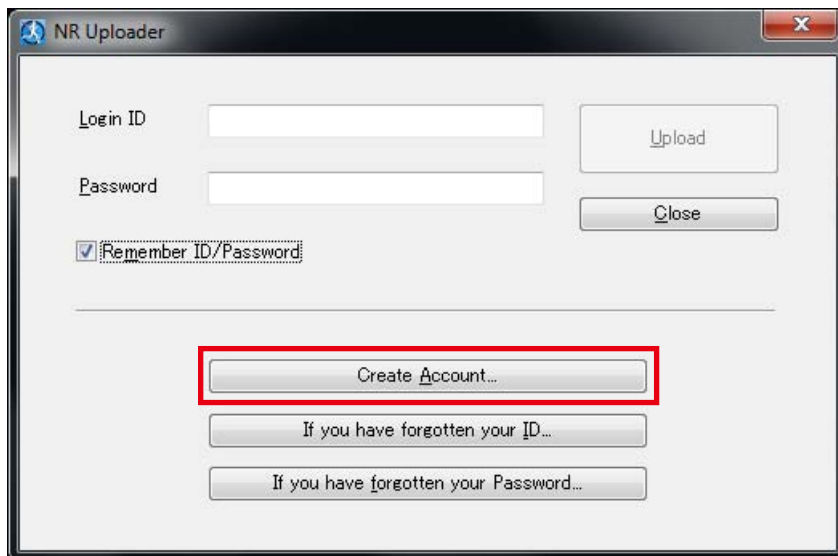

- For details on using the Web application (NeoRun), see the NeoRun Help.
-



## 10-3 Updating the driver software

If you connect the device before installing NR Uploader, the computer may not recognize the device even after you have installed NR Uploader.

If this does happen, follow the steps below to update the driver software.

### 1 Connect the device to the computer.

Check that NR Uploader is not running.

### 2 Open the Control Panel.

Click [Start], and then select [Control Panel].

The following explanation uses screen shots from Windows 7.

### 3 Click [System and Security].

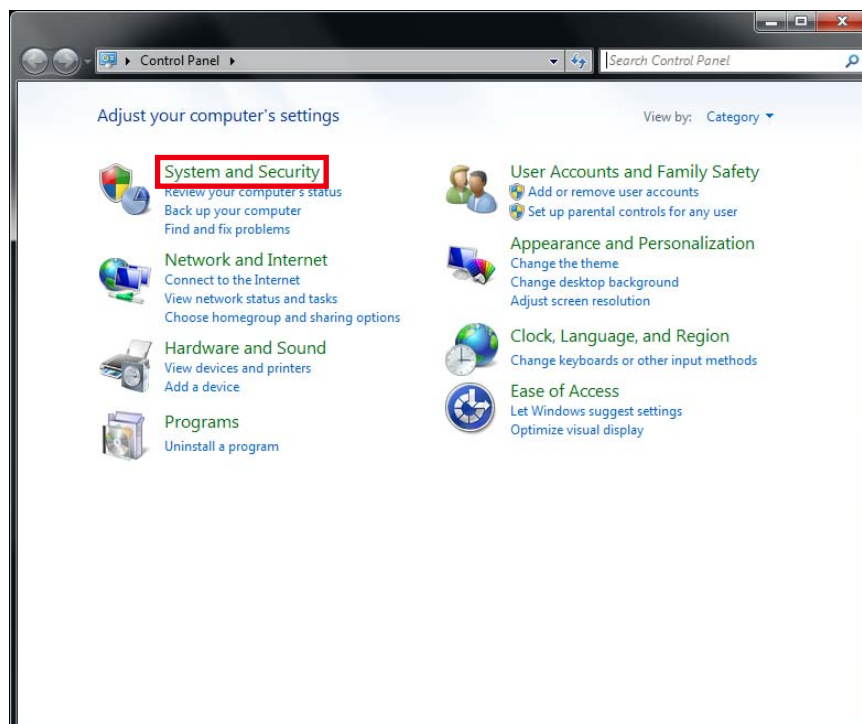

**4** Click [Device Manager] from [System].

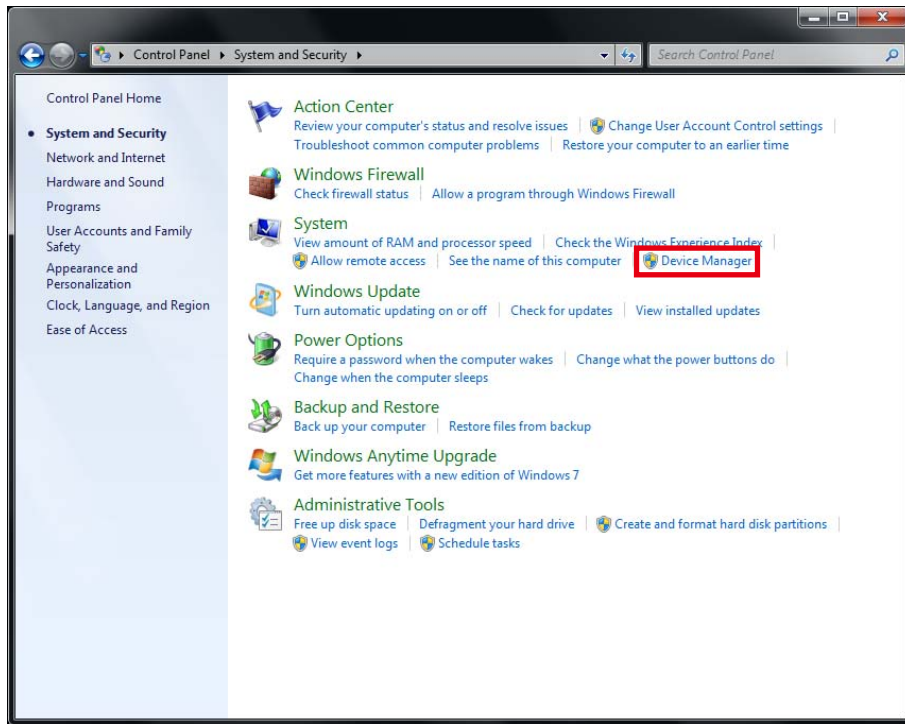

**5** Right-click the name of this device in [Other devices], and then click [Update Driver Software].

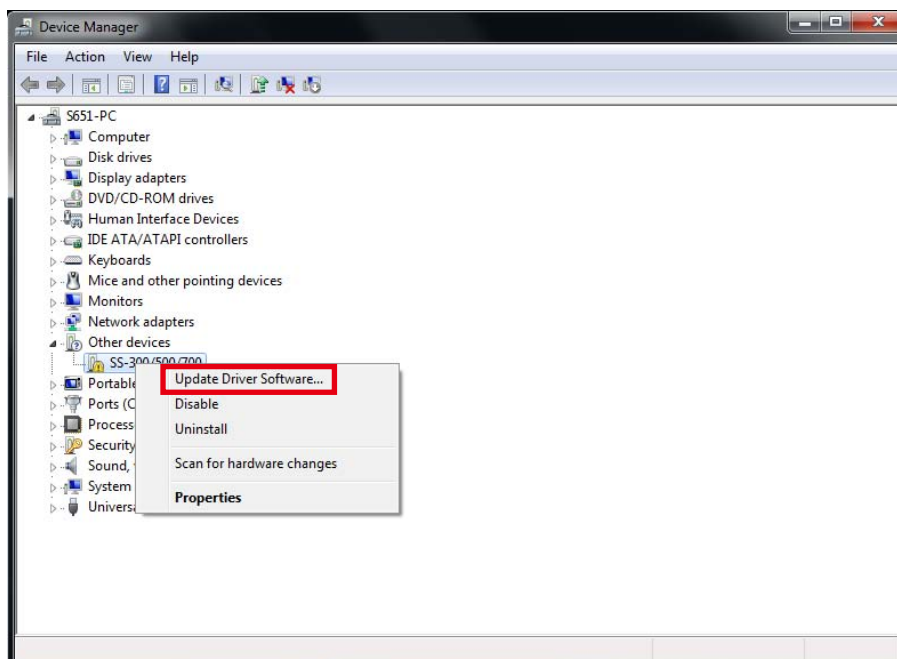

**6** Click [Search automatically for updated driver software].

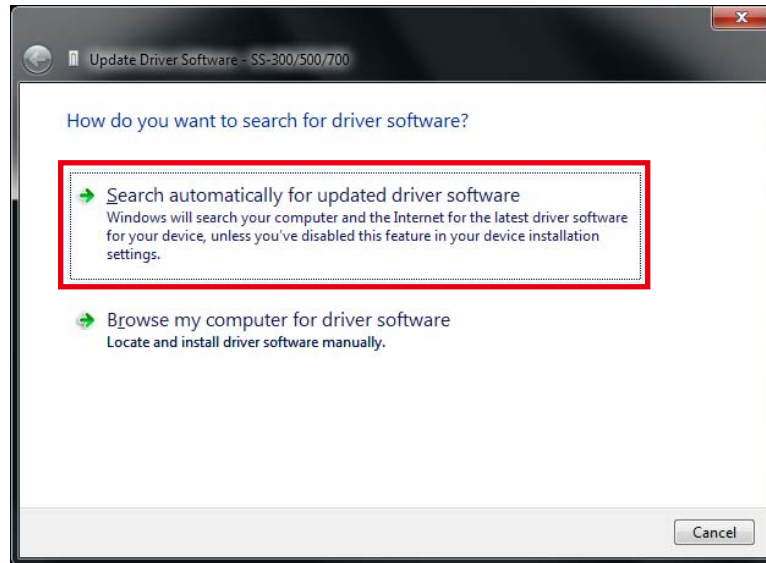

**7** If a Windows security screen is displayed, click [Install this driver software anyway].



**8** When installation is complete, click [Close].

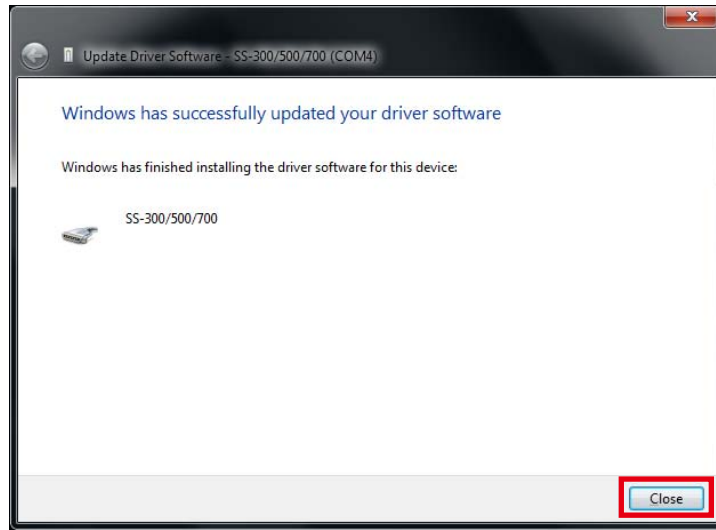

Driver software update is complete.

# Maintenance

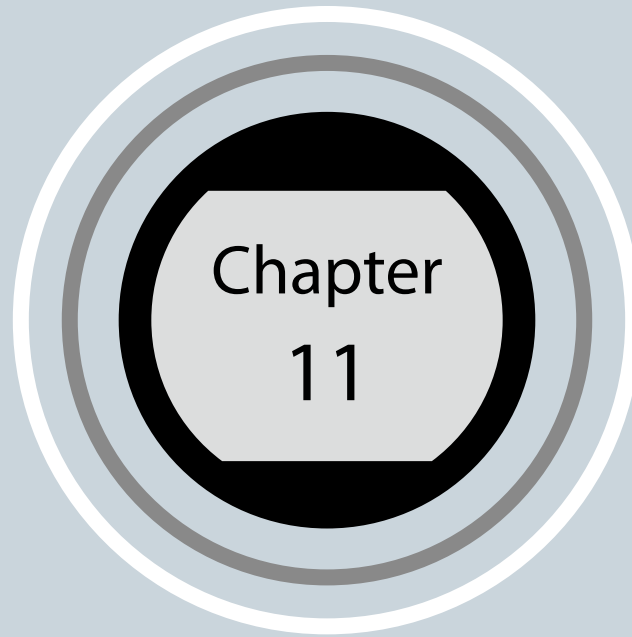

- 
- 11-1 Performing maintenance
  - 11-2 Replacing the battery
  - 11-3 Product specifications
-

## 11-1 Performing maintenance

### Performing after care

**Do not leave any water, sweat, or dirt on the device.**

After using the device, use low pressure water from a faucet to wash the contact points, wipe away most of the water with a towel and so on, and then let it dry naturally.

Water, sweat, or dirt could cause the device to malfunction.

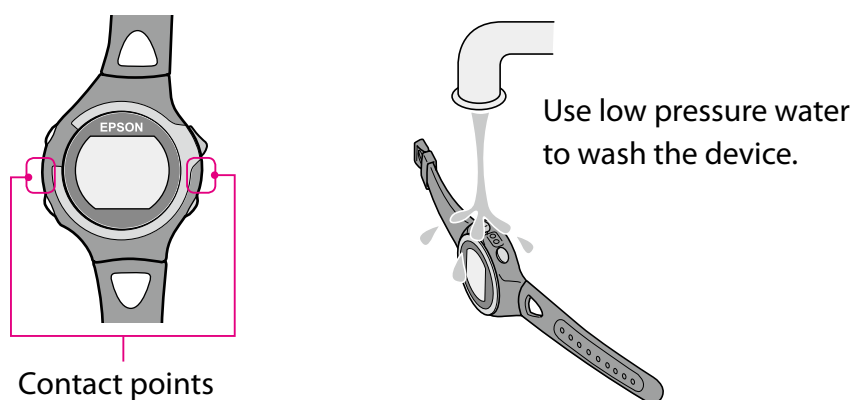

If the device is placed in the cradle when it is covered in water, sweat, or dirt, the contact points could corrode and cause a malfunction.

If charging or communicating becomes unstable, clean the contact points on the device and the cradle with a damp cotton swab.

Do not clean using organic solvents such as benzene, thinner, alcohol, or detergent. This could cause the product to degrade.

### About the strap

If the strap gets soiled, wash it with water and wipe thoroughly with a dry cloth. This strap is made from polyurethane and after years of use the color may fade or it may lose its elasticity.

### HR sensor maintenance

- After exercise, take off the HR sensor and HR belt, dip them in water and wash.
- Also make sure that you wash the button sections and wipe off all moisture.
- Although you can wash the HR belt in a washing machine, make sure you place the belt in a net, and do not use a drier.
- Do not iron, dry clean, or use a chlorine-based detergent on the HR belt.
- Wash the HR sensor carefully with water. Do not use a washing machine or a drier.
- Dry the HR sensor and HR belt completely and store them separately.

## 11-2 Replacing the battery

### **About the device's rechargeable battery**

You cannot replace the built-in rechargeable battery yourself.

After prolonged use, the battery may not retain its charge for as long as it used to. In this situation, contact your local dealer or our repair center to replace the battery. You will need to pay for the battery to be replaced.

The average service life for the battery is five years, although this may change depending on the operating conditions.

### **About the HR sensor battery**

Be careful not to injure yourself when replacing the battery (CR2032) (→ [P. 70](#)). The average service life for the battery when using the HR sensor for one hour every day is three years.

## 11-3 Product specifications

Check each item.

### Device specifications

Specifications		SS-700	SS-500	SS-300
Size (thickness)		15.7 mm	13.0mm	14.7mm
Weight		61 g	49g	59g
Waterproofing function		10 atm	5 atm	
Operating time	GPS-on, Stride ON/OFF, HR-OFF	14 hours		
	GPS-on, Stride ON/OFF, HR-ON	10 hours	-	
	Time display	Five weeks		
Operating temperature		-5 to 50°C		
Possible memory time		100 hours		
Maximum number of laps		1000		
Heart rate measurement (using the HR sensor)		○	○*1	-
Pitch/stride measurement		○	○	-
Measuring distance/pace with the stride sensor		○	○	-
Display range	Distance	0.00 to 999.99 km / 0.00 to 999.99 mi		
	Pace/Lap pace/Average pace	0'00" to 30'00"/km / 0'00" to 45'00"/mi		
	Speed	0.0 to 999.9 km/h / 0.0 to 999.9 mi/h		
	Split/Lap time	00'00" to 99:59'59"		
	Pitch	0 to 255 spm	-	
	Stride	0 to 200 cm / 0 to 99 inch	-	
	Calories burnt	0 to 9999 kcal		
	Altitude*2	-500 to 9999 m / -1500 to 29999 ft		
	HR/Lap HR/Average HR	30 to 240 bpm	-	
	Guide time	-9:59'59" to 9:59'59"		
	Guide distance	-99.99 to 99.99 km / -99.99 to 99.99 mi		
	Exercise intensity	1.0 to 18.0 METS		

\*1: You can purchase the HR sensor set for the SS-500 as an optional item.

\*2: The altitude is measured using the GPS signal. There may be large errors in altitude measurement values depending on the GPS environment.



### **Cradle specifications**

Specifications	SS-700	SS-500	SS-300
Operating temperature range	5 to 35°C		

### **AC adapter specifications**

Specifications	SS-700	SS-500	SS-300
Power	100 V AC		

### **HR sensor specifications**

Specifications	HR sensor
Waterproofing function	Water resistant



## 12-1 Dealing with problems

### **Caution**

\* After using the device, use low pressure water from a faucet to wash the contact points on the device, wipe away most of the water with a towel and so on, and then let it dry naturally.

If the device is placed in the cradle when it is dirty, the contact points on the device could corrode and cause a malfunction.

If charging or communicating becomes unstable, clean the contact points on the device and the cradle with a damp cotton swab.

\* If device operations become unstable or if some functions do not work normally, try resetting the system (hold down all four buttons at the same time).

\* If the HR sensor operations become unstable or if it does not work normally, remove the HR sensor battery, turn it over so that the negative side is facing up, hold it in place for three seconds (to reset), and then turn it back over.

## Chapter 12

### Troubleshooting

Check each item.

Problem		Solution
Basic actions	The screen is not displayed.	Operation stops immediately after purchase. Charge before use (→ <a href="#">P. 14</a> ). Nothing is displayed if the battery runs out. Charge the battery (→ <a href="#">P. 14</a> ).
	The device does not react even after performing an operation.	Is the battery running low? Charge the battery (→ <a href="#">P. 14</a> ). If the device does not operate after charging, try resetting the system (→ <a href="#">P. 135</a> ).
	The [Menu] screen or other screens are not displayed. Only the clock is displayed.	Is the battery running low? Charge the battery (→ <a href="#">P. 14</a> ).
	The time is not set correctly.	Set the time by receiving a GPS signal. Change to the chronograph function to receive a GPS signal (→ <a href="#">P. 24</a> ). If the hour is different, check the time zone and summer time settings.
Chronograph actions	The device cannot receive a GPS signal.	Check that there are no obstructions overhead, and that you can see the sky. Signals from the GPS cannot be received while indoors. Also, if there are any obstacles partially blocking the sky, such as tall buildings and mountain sides, reception may be interrupted causing a lack of precision.
	Signals from the GPS are hard to receive or are interrupted.	Even when a signal is being received, it may be interrupted depending on the running environment.

Problem		Solution
Charging	The device does not charge even when it is placed in the cradle.	<p>Check the connection for the AC adapter and the USB cable.</p> <p>Clean the contact points on the device and the cradle (→ <a href="#">P. 125</a>).</p> <p>A malfunction may have occurred if you cannot charge the device even after checking the points above.</p> <p>Stop charging the device, and contact our information center.</p>
	The device and the cradle become hot while charging.	There may be a malfunction. Stop using the device, and contact our information center.
	[Charge Err.] is displayed when you place the device in the cradle.	Charge in an environment with a room temperature of 0 to 35°C.
Waterproofing function	Can I use the device when swimming?	<p>This device has been waterproofed and can be used when swimming.</p> <p>However, a GPS signal cannot be received when in water.</p>
	Inside the glass becomes cloudy.	<p>Condensation may occur in the device due to differences in temperature between the device and the open air. Temporary condensation does not have any effect on the device. You can continue to use the device in this condition. If the condensation remains for a long time, water may have got inside the device.</p> <p>Contact our information center.</p>
Accessories	I need another cradle set.	You can purchase cradle sets, HR sensor sets, HR belts, and straps for the device as optional extras. Contact your local dealer or our information center.

Problem		Solution
HR sensor	The HR sensor is not working correctly.	<p>Check that you are wearing the HR belt correctly (➔ <a href="#">P. 64</a>).</p> <p>Check that the [HR Sensor] is set to On (➔ <a href="#">P. 67</a>).</p> <p>Perform pairing with the device (➔ <a href="#">P. 65</a>).</p> <p>If you cannot pair the device, replace the battery after resetting the HR sensor. To reset the HR sensor, turn the battery over so that the negative side is facing up and hold it in place for three seconds (➔ <a href="#">P. 70</a>).</p> <p>Perform a system reset for the device (➔ <a href="#">P. 135</a>).</p> <p>Check if the battery has run out. Replace the battery if it has run out (➔ <a href="#">P. 127</a>).</p>
Communication	The device is not recognized correctly when it is connected to a computer.	<p>Check the connection for the computer and the USB cable.</p> <p>Clean the contact points on the device and the cradle (➔ <a href="#">P. 126</a>).</p> <p>Perform a system reset (➔ <a href="#">P. 135</a>).</p>
Web application	When communicating with a computer, an error screen is displayed and communication stops.	<p>Do not move the device or the cradle during communication.</p> <p>Also, avoid communicating data under environments where static electricity has been generated.</p> <p>If an error occurs, reconnect the cradle to start communication again.</p>
	NR Uploader does not start even if the device is connected to the computer.	<p>If you connect the device before installing NR Uploader, the computer may not recognize the device even after you have installed NR Uploader. If NR Uploader does not start, update the driver software (➔ <a href="#">P. 121</a>).</p>

\* If you cannot solve the problem even after trying the points above, contact our information center.

## 12-2 Resetting the system

If operations are unstable, try resetting the system.

Hold down all of the buttons (A, B, C, and D) for at least two seconds until the display turns off.

The screen is reset and the time/setting content is cleared.

Measurement data is not cleared.

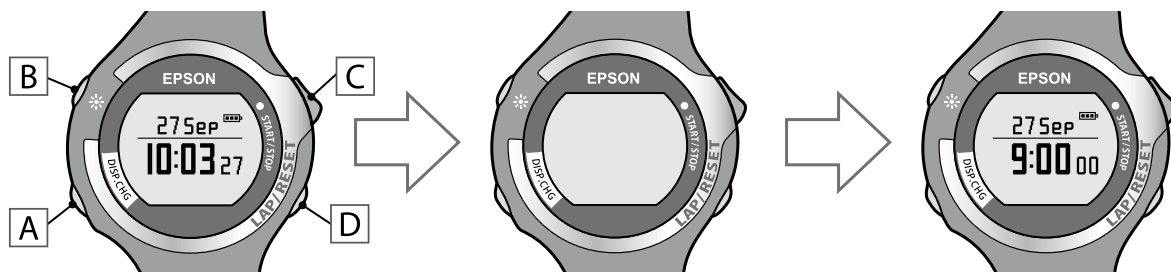

- After resetting to synchronize the time, perform a GPS search (→ [P. 24](#)).
- After resetting, the display language is English.
- Stride sensor information is reset after performing a reset. Make the same preparations as when using the device for the first time (→ [P. 59](#)).
- Pairing information for the HR sensor is reset after performing a reset. Perform pairing for the device in the same way as when using the device for the first time (→ [P. 65](#)).

## 12-3 Contacting us about this product

- **Information center:** Call if you have questions or need to consult about the device.  
Support from the Information Center is only available in Japanese. Also, the manual that is provided with the product is only available in Japanese.  
**Tel: 050-3155-8280**  
Working hours: Monday to Friday 9:00 to 20:00 (except for public holidays and company holidays)  
© If the above telephone number is unavailable, try 042-585-8590.
- **Sending or bringing for repair:**  
Bring the product to your local dealer, or send it to the following repair center.  
**Matsumoto repair center**  
Address: Epson Service Center, Kanbayashi 1563, Matsumoto City, 390-1243  
**Tel: 050-3155-7110**  
Working hours: Monday to Friday 9:00 to 17:30 (except for public holidays and company holidays)  
\* Please note that the address or contact information may change without prior notice.  
\* Check the Epson Web site for more detailed information on repairs. <http://www.epson.jp/support/>  
© If the above telephone number is unavailable, try the following numbers.  
Matsumoto repair center: 0263-86-7660
- **Inquiries about door-to-door repair service**  
Door-to-door service is a specialized repair service whereby a designated contractor will come to the address you specify and pick up your product for repair. Once repairs are complete, we will send the product back to you. Please note that this is not a free service. The product will be packed by the contractor.  
**Tel: 050-3155-7150**  
Working hours: Monday to Friday 9:00 to 5:30 PM (except for public holidays and company holidays)  
© If the above telephone number is unavailable, try 0263-86-9995.  
\* Check the Epson Web site for more detailed information on the door-to-door service. <http://www.epson.jp/support/>  
\* From 17:30 to 20:00 on weekdays (including company holidays), as well as 09:00 to 18:00 on weekends and national holidays, you can call 0263-86-9995 (year-round service)  
The contractor is Nippon Express.  
\* New year holidays (12/30 to 1/3) are treated like weekends and public holidays.
- **Showroom** \* See the following Web site for more details. <http://www.epson.jp/showroom/>  
Epson Square Shinjuku: Shinjuku-ku, Nishi-Shinjuku 6-24-1, Tokyo, 160-8324 Nishi Shinjuku Mitsui Bldg. 1F  
[Working hours] Monday to Friday 9:30 AM to 17:30 (except for public holidays and company holidays)
- **Optional items and consumables**  
You can buy these items from your local Epson retailer or from Epson Direct:  
Web site <http://www.epson.jp/shop/> or free-phone 0120-545-101 (As of May, 2012)
- **Epson Web site** <http://www.epson.jp>  
The Epson Web site provides a variety of information such as special offers, product and driver information, support, and so on.  
 Epson offers you full after service support. You can check the most common queries in the FAQ provided on the Web site. Please check this before contacting us.  
<http://www.epson.jp/faq/>
- **MyEPSON**  
Epson offers a membership service to Epson customers and non-customers alike. We can send you the latest information tailored to suit your needs, and help you get more from your printer. You can easily register your user information after purchasing a product.  
Sign-up right away!

Connect to the internet

<http://myepson.jp/>

► Fill in the easy questions to set up your registration information.



## 12-4 After service

- For repair and maintenance for this product, contact your local dealer or our repair center.
- After prolonged use, the battery may not retain its charge for as long as it used to. In this situation, contact your local dealer or our repair center to replace the battery. You will need to pay for the battery to be replaced.
- The strap for the device, the battery for the HR sensor, the HR belt, and the USB cable are not covered by the guarantee. If you need to purchase any of these items, contact your local dealer or our information center.
- Spare parts for repairing this product will be available for six years after the device has stopped being manufactured.
- In the event of product failure, we do not guarantee that data recorded on the device can be recovered.
- A sticker displaying the serial number for this product is stuck to the guarantee. If there is no sticker, the guarantee is void.

## 12-5 Certification information

### JAPAN

 R007-AA0129

 R007-AB0049

\* except model SS-300

\* Two kinds of the license number explanation.

The explanation for two kinds of license number the license number difference is a thing by minor change. It does not influence the use of the radio function



Model: SS-300/SS-500/SS-700

### USA

FCC ID: BKMAP001

FCC ID: BKMAP002

\* except model SS-300



WristableGPS

Model: SS-300/SS-500/SS-700

### FCC NOTICE

This device complies with Part 15 of the FCC Rules. Operation is subject to the following two conditions: (1) This device may not cause harmful interference, and (2) this device must accept any interference received, including interference that may cause undesired operation.

Caution: Changes or modifications not expressly approved by the party responsible for compliance could void the user's authority to operate this equipment.

Properly shielded and grounded cables and connectors must be used for connection to host computers and / or peripherals in order to meet FCC emission limits.  
Use the genuine USB cable with a ferrite core.

This equipment has been tested and found to comply with the limits for a Class B digital device, pursuant to Part 15 of the FCC Rules. These limits are designed to provide reasonable protection against harmful interference in a residential installation. This equipment generates, uses and can radiate radio frequency energy and, if not installed and used in accordance with the instructions, may cause harmful interference to radio communications. However, there is no guarantee that interference will not occur in a particular installation. If this equipment does cause harmful interference to radio or television reception, which can be determined by turning the equipment off and on, the user is encouraged to try to correct the interference by one of the following measures:

- Reorient or relocate the receiving antenna.
- Increase the separation between the equipment and receiver.
- Connect the equipment into an outlet on a circuit different from that to which the receiver is connected.
- Consult the dealer or an experienced radio/TV technician for help.

This transmitter must not be co-located or operating in conjunction with any other antenna or transmitter.

This equipment complies with FCC radiation exposure limits set forth for an uncontrolled equipment and meets the FCC radio frequency (RF) Exposure Guidelines in Supplement C to OET65. This equipment has very low levels of RF energy that are deemed to comply without testing of specific absorption ratio (SAR).



All EPSON products with the ANT+ logo have been certified as interoperable by ANT+. For more information, visit [www.thisisant.com/directory](http://www.thisisant.com/directory)

In case you purchases further HR sensors, option products of EPSON are recommended.

# Index

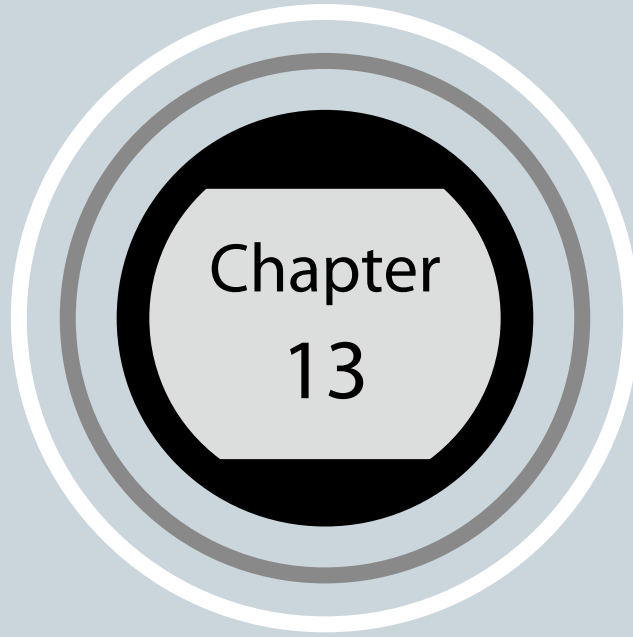

<b>A</b>		<b>I</b>	
AC adapter .....	<a href="#">13, 14</a>	Icon .....	<a href="#">20</a>
After service .....	<a href="#">137</a>	Interval .....	<a href="#">43</a>
Alarm .....	<a href="#">85</a>	Interval settings .....	<a href="#">44</a>
Altitude .....	<a href="#">21, 75</a>	Items supplied .....	<a href="#">13</a>
Auto lap .....	<a href="#">79</a>	<b>L</b>	
Auto light .....	<a href="#">81</a>	Language .....	<a href="#">95</a>
Auto pause .....	<a href="#">83</a>	Lap HR .....	<a href="#">21, 75</a>
Average HR .....	<a href="#">21, 72</a>	Lap pace .....	<a href="#">21, 75</a>
Average pace .....	<a href="#">21, 72</a>	Lap time .....	<a href="#">21, 27, 75</a>
<b>C</b>		<b>M</b>	
Calories burnt .....	<a href="#">21, 72</a>	Maintenance .....	<a href="#">125</a>
Caring for the product .....	<a href="#">126</a>	Measure .....	<a href="#">3, 30</a>
Certification information .....	<a href="#">138</a>	Measurement items .....	<a href="#">21</a>
Changing the screen.....	<a href="#">33, 41, 53</a>	Measurement methods .....	<a href="#">23</a>
Charging .....	<a href="#">14</a>	<b>N</b>	
Chronograph .....	<a href="#">27</a>	NeoRun .....	<a href="#">119</a>
Clear history .....	<a href="#">95, 98</a>	NR Uploader .....	<a href="#">116</a>
Clock settings .....	<a href="#">95</a>	<b>P</b>	
Contact us .....	<a href="#">136</a>	Pace .....	<a href="#">21, 75, 108</a>
Contrast .....	<a href="#">95</a>	Pace alarm .....	<a href="#">89</a>
Cradle .....	<a href="#">13, 14</a>	Pairing .....	<a href="#">65</a>
<b>D</b>		Pitch .....	<a href="#">21, 75, 110</a>
Dealing with problems .....	<a href="#">131</a>	Product specifications .....	<a href="#">128</a>
Distance .....	<a href="#">21, 75, 108</a>	<b>R</b>	
Distance alarm .....	<a href="#">87</a>	Recall .....	<a href="#">55</a>
Distance units .....	<a href="#">95</a>	Repeat no.....	<a href="#">43, 49</a>
<b>E</b>		Replacing the battery .....	<a href="#">73, 130</a>
Exercise .....	<a href="#">35</a>	Rest .....	<a href="#">44</a>
<b>G</b>		<b>S</b>	
GPS search .....	<a href="#">24</a>	Screen settings .....	<a href="#">78, 110</a>
Guide distance .....	<a href="#">21, 75, 111</a>	Settings .....	<a href="#">73</a>
Guide time .....	<a href="#">21, 75, 111</a>	Specifications .....	<a href="#">128, 129</a>
<b>H</b>		Speed .....	<a href="#">21, 75</a>
Heart rate .....	<a href="#">63, 113</a>	Split time .....	<a href="#">21, 27, 75</a>
HR .....	<a href="#">21, 75</a>	Sprint .....	<a href="#">43</a>
HR alarm .....	<a href="#">92</a>	Stride .....	<a href="#">21, 75, 110</a>
HR belt .....	<a href="#">63</a>	Stride sensor .....	<a href="#">59</a>
HR sensor .....	<a href="#">63, 67</a>	Summer time .....	<a href="#">95</a>
HR sensor set .....	<a href="#">13, 63</a>	System reset .....	<a href="#">134</a>
		System settings .....	<a href="#">95</a>

## T

- Target pace ..... [36](#), [111](#)
- Time ..... [21](#), [75](#)
- Time zone ..... [95](#)
- Troubleshooting ..... [130](#)

## U

- Updating the driver software ..... [121](#)
- Usage guide ..... [106](#)
- USB cable ..... [13](#), [14](#)
- User settings ..... [101](#)

## W

- Web application ..... [115](#)

