

# MEASUREMENT REPORT

## FCC PART 15 Subpart C Bluetooth-LE

---

**FCC ID:** BKMAE-WH5674

**APPLICANT:** SEIKO EPSON CORPORATION

**Application Type:** Certification

**Product:** REMOTE CONTROLLER

**Model No.:** WH-5674

**Brand Name:** EPSON

**FCC Classification:** Digital Transmission System (DTS)

**FCC Rule Part(s):** Part15 Subpart C (Section 15.247)

**Test Procedure(s):** ANSI C63.10-2013, KDB 558074 D01v05r02

**Test Date:** June 21~ July 18, 2019

Reviewed By:

*Paddy Chen*

( Paddy Chen )

Approved By:

*Chenz Ker*

(Chenz Ker)



Testing Laboratory  
3261

The test results relate only to the samples tested.

This equipment has been shown to be capable of compliance with the applicable technical standards as indicated in the measurement report and was tested in accordance with the measurement procedures specified in ANSI C63.10-2013. Test results reported herein relate only to the item(s) tested.

The test report shall not be reproduced except in full without the written approval of MRT Technology (Taiwan) Co., Ltd.

### Revision History

Report No.	Version	Description	Issue Date	Note
1907TW0103-U1	Rev. 01	Initial report	07-19-2019	Valid

---

## CONTENTS

Description	Page
<b>§2.1033 General Information</b> .....	<b>5</b>
<b>1. INTRODUCTION</b> .....	<b>6</b>
1.1. Scope.....	6
1.2. MRT Test Location.....	6
<b>2. PRODUCT INFORMATION</b> .....	<b>7</b>
2.1. Feature of Equipment under Test.....	7
2.2. Product Specification Subjective to this Report.....	7
2.3. Working Frequencies for this report.....	8
2.4. Test Mode.....	8
2.5. Description of Test Software.....	8
2.6. Device Capabilities.....	9
2.7. Test Configuration.....	10
2.8. EMI Suppression Device(s)/Modifications.....	10
2.9. Labeling Requirements.....	10
<b>3. DESCRIPTION of TEST</b> .....	<b>11</b>
3.1. Evaluation Procedure.....	11
3.2. AC Line Conducted Emissions.....	11
3.3. Radiated Emissions.....	12
<b>4. ANTENNA REQUIREMENTS</b> .....	<b>13</b>
<b>5. TEST EQUIPMENT CALIBRATION DATE</b> .....	<b>14</b>
<b>6. MEASUREMENT UNCERTAINTY</b> .....	<b>15</b>
<b>7. TEST RESULT</b> .....	<b>16</b>
7.1. Summary.....	16
7.2. 6dB Bandwidth Measurement.....	17
7.2.1. Test Limit.....	17
7.2.2. Test Procedure used.....	17
7.2.3. Test Setting.....	17
7.2.4. Test Setup.....	17
7.2.5. Test Result.....	18
7.3. Output Power Measurement.....	19
7.3.1. Test Limit.....	19
7.3.2. Test Procedure Used.....	19
7.3.3. Test Setting.....	19

---

7.3.4.	Test Setup .....	20
7.3.5.	Test Result.....	21
7.4.	Power Spectral Density Measurement.....	22
7.4.1.	Test Limit .....	22
7.4.2.	Test Procedure Used .....	22
7.4.3.	Test Setting.....	22
7.4.4.	Test Setup .....	22
7.4.5.	Test Result.....	23
7.5.	Conducted Band Edge and Out-of-Band Emissions .....	24
7.5.1.	Test Limit .....	24
7.5.2.	Test Procedure Used .....	24
7.5.3.	Test Setting.....	24
7.5.4.	Test Setup .....	25
7.5.5.	Test Result.....	26
7.6.	Radiated Spurious Emission Measurement .....	28
7.6.1.	Test Limit .....	28
7.6.2.	Test Procedure Used .....	28
7.6.3.	Test Setting.....	29
7.6.4.	Test Setup .....	31
7.6.5.	Test Result.....	32
7.7.	Radiated Restricted Band Edge Measurement.....	40
7.7.1.	Test Limit .....	40
7.7.2.	Test Procedure Used .....	41
7.7.3.	Test Setting.....	41
7.7.4.	Test Setup .....	42
7.7.5.	Test Result.....	43
7.8.	AC Conducted Emissions Measurement .....	51
7.8.1.	Test Limit .....	51
7.8.2.	Test Setup .....	51
7.8.3.	Test Result.....	51
<b>8.</b>	<b>CONCLUSION .....</b>	<b>52</b>
	<b>Appendix A - Test Setup Photograph.....</b>	<b>53</b>
	<b>Appendix B - EUT Photograph.....</b>	<b>54</b>

## §2.1033 General Information

<b>Applicant:</b>	SEIKO EPSON CORPORATION
<b>Applicant Address:</b>	3-5, Owa 3-chome, Suwa-shi, Nagano-ken 392-8502 Japan
<b>Manufacturer:</b>	SEIKO EPSON CORPORATION
<b>Manufacturer Address:</b>	3-5, Owa 3-chome, Suwa-shi, Nagano-ken 392-8502 Japan
<b>Test Site:</b>	MRT Technology (Taiwan) Co., Ltd
<b>Test Site Address:</b>	No. 38, Fuxing Second Rd., Guishan Dist., Taoyuan City 333, Taiwan (R.O.C)
<b>Test Device Serial No.:</b>	N/A <input type="checkbox"/> Production <input checked="" type="checkbox"/> Pre-Production <input type="checkbox"/> Engineering

### Test Facility / Accreditations

Measurements were performed at MRT Laboratory located in Fuxing Rd., Taoyuan, Taiwan ( R.O.C )

- MRT facility is a FCC registered (Reg. No. 153292 and 291082) test facility with the site description report on file and is designated by the FCC as an Accredited Test Firm.
- MRT facility is an IC registered (MRT Reg. No. 21723-1) test laboratory with the site description on file at Industry Canada.
- MRT Lab is accredited to ISO 17025 by the American Association for Laboratory Accreditation (TAF) under the American Association for Laboratory Accreditation Program (TAF Cert. No. 3261) in EMC, Telecommunications and Radio testing for FCC, Industry Taiwan, EU and TELEC Rules.

## 1. INTRODUCTION

### 1.1. Scope

Measurement and determination of electromagnetic emissions (EMC) of radio frequency devices including intentional and/or unintentional radiators for compliance with the technical rules and regulations of the Federal Communications Commission and the Industry Canada Certification and Engineering Bureau.

### 1.2. MRT Test Location

The map below shows the location of the MRT LABORATORY, its proximity to the Taoyuan City. These measurement tests were conducted at the MRT Technology (Taiwan) Co., Ltd. Facility located at No.38, Fuxing 2nd Rd., Guishan Dist., Taoyuan City 33377, Taiwan (R.O.C).

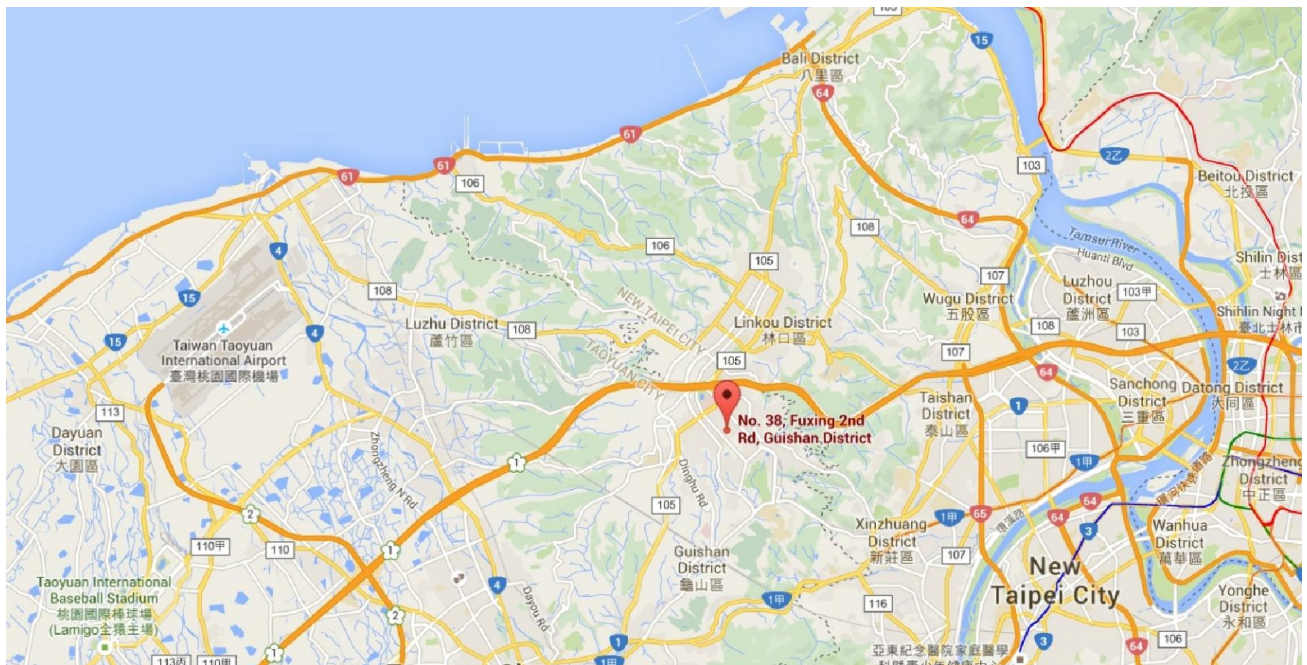

## 2. PRODUCT INFORMATION

### 2.1. Feature of Equipment under Test

Product Name:	REMOTE CONTROLLER
Model No.:	WH-5674
Brand Name:	EPSON
Bluetooth Specification:	v4.2 Single mode (BLE Only)

### 2.2. Product Specification Subjective to this Report

Frequency Range:	2402~2480MHz
Channel Number:	40
Type of Modulation:	GFSK
Data Rate:	1Mbps
Antenna Type:	PIFA Antenna
Antenna Gain:	2.73dBi

Note: For other features of this EUT, test report will be issued separately.

### 2.3. Working Frequencies for this report

Channel	Frequency	Channel	Frequency	Channel	Frequency
00	2402 MHz	01	2404 MHz	02	2406 MHz
03	2408 MHz	04	2410 MHz	05	2412 MHz
06	2414 MHz	07	2416 MHz	08	2418 MHz
09	2420 MHz	10	2422 MHz	11	2424 MHz
12	2426 MHz	13	2428 MHz	14	2430 MHz
15	2432 MHz	16	2434 MHz	17	2436 MHz
18	2438 MHz	19	2440 MHz	20	2442 MHz
21	2444 MHz	22	2446 MHz	23	2448 MHz
24	2450 MHz	25	2452 MHz	26	2454 MHz
27	2456 MHz	28	2458 MHz	29	2460 MHz
30	2462 MHz	31	2464 MHz	32	2466 MHz
33	2468 MHz	34	2470 MHz	35	2472 MHz
36	2474 MHz	37	2476 MHz	38	2478 MHz
39	2480 MHz	--	--	--	--

### 2.4. Test Mode

Test Mode	Mode 1: Transmit by BLE
-----------	-------------------------

### 2.5. Description of Test Software

The commands used for testing are provided by the customer.



## 2.6. Device Capabilities

This device contains the following capabilities:

Bluetooth-LE (DTS)

**Note:** Bluetooth-LE (DTS) operation is possible in 20MHz channel bandwidths. The maximum achievable duty cycles for all modes were determined based on measurements performed on a spectrum analyzer in zero-span mode with RBW = 8MHz, VBW = 50MHz. The RBW and VBW were both greater than 50/T, where T is the minimum transmission duration, and the number of sweep points across T was greater than 100. The duty cycles are as follows:

Model No.	Test Mode	Duty Cycle
WH-5674	BLE	100%

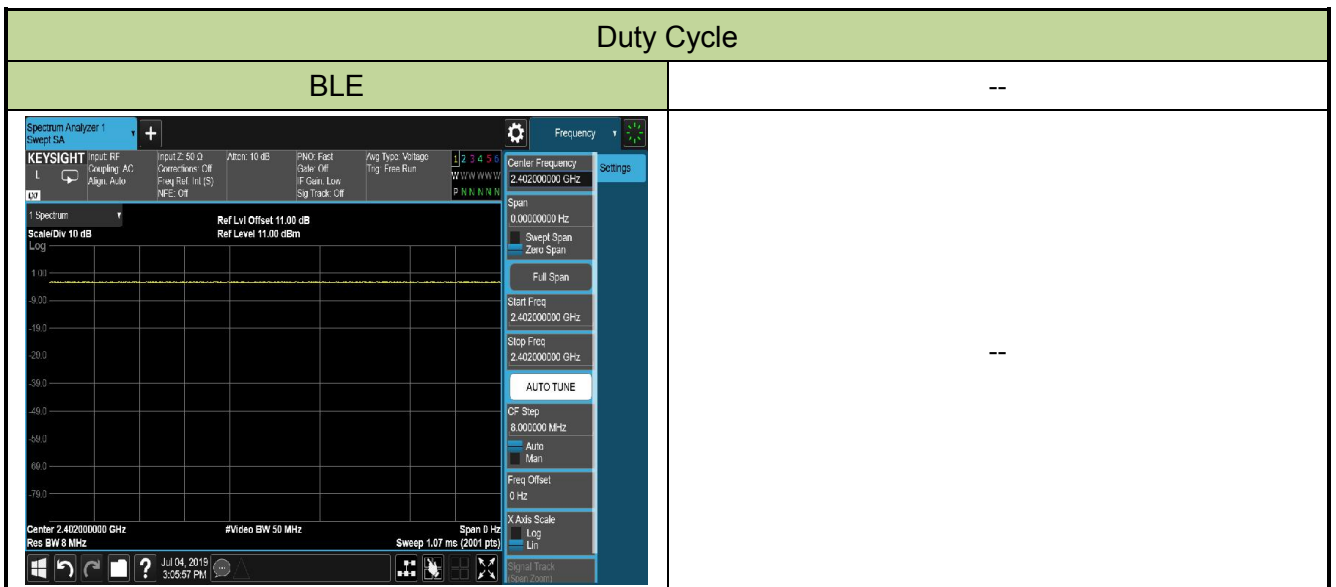

## **2.7. Test Configuration**

The device was tested per the guidance of ANSI C63.10-2013. ANSI C63.10-2013 was used to reference the appropriate EUT setup for radiated spurious emissions testing and AC line conducted testing.

## **2.8. EMI Suppression Device(s)/Modifications**

No EMI suppression device(s) were added and/or no modifications were made during testing.

## **2.9. Labeling Requirements**

Per 2.1074 & 15.19; Docket 95-19

The label shall be permanently affixed at a conspicuous location on the device; instruction manual or pamphlet supplied to the user and be readily visible to the purchaser at the time of purchase. However, when the device is so small wherein placement of the label with specified statement is not practical, only the FCC ID must be displayed on the device per Section 15.19(a)(5). Please see attachment for FCC ID label and label location.

### 3. DESCRIPTION of TEST

#### 3.1. Evaluation Procedure

The measurement procedures described in the American National Standard for Testing Unlicensed Wireless Devices (ANSI C63.10-2013), and the guidance was used in the measurement.

**Deviation from measurement procedure.....None**

#### 3.2. AC Line Conducted Emissions

The line-conducted facility is located inside an 8'x4'x4' shielded enclosure. A 1m x 2m wooden table 80cm high is placed 40cm away from the vertical wall and 80cm away from the sidewall of the shielded room. Two 10kHz-30MHz, 50Ω/50uH Line-Impedance Stabilization Networks (LISNs) are bonded to the shielded room floor. Power to the LISNs is filtered by external high-current high-insertion loss power line filters. These filters attenuate ambient signal noise from entering the measurement lines. These filters are also bonded to the shielded enclosure.

The EUT is powered from one LISN and the support equipment is powered from the second LISN. All interconnecting cables more than 1 meter were shortened to a 1 meter length by non-inductive bundling (serpentine fashion) and draped over the back edge of the test table. All cables were at least 40cm above the horizontal reference ground-plane. Power cables for support equipment were routed down to the second LISN while ensuring that that cables were not draped over the second LISN.

Sufficient time for the EUT, support equipment, and test equipment was allowed in order for them to warm up to their normal operating condition. The RF output of the LISN was connected to the receiver and exploratory measurements were made to determine the frequencies producing the maximum emission from the EUT. The receiver was scanned from 150kHz to 30MHz. The detector function was set to peak mode for exploratory measurements while the bandwidth of the analyzer was set to 9kHz. The EUT, support equipment, and interconnecting cables were arranged and manipulated to maximize each emission. Each emission was also maximized by varying: power lines, the mode of operation or data exchange speed, or support equipment whichever determined the worst-case emission. Once the worst case emissions have been identified, the one EUT cable configuration/arrangement and mode of operation that produced these emissions are used for final measurements on the same test site. The analyzer is set to CISPR quasi-peak and average detectors with a 9kHz resolution bandwidth for final measurements.

An extension cord was used to connect to a single LISN which powered by EUT. The extension cord was calibrated with LISN, the impedance and insertion loss are compliance with the requirements as stated in ANSI C63.10-2013.

### 3.3. Radiated Emissions

The radiated test facilities consisted of an indoor 3 meter semi-anechoic chamber used for final measurements and exploratory measurements, when necessary. The measurement area is contained within the semi-anechoic chamber which is shielded from any ambient interference. For measurements above 1GHz absorbers are arranged on the floor between the turn table and the antenna mast in such a way so as to maximize the reduction of reflections. For measurements below 1GHz, the absorbers are removed. A MF Model 210SS turntable is used for radiated measurement. It is a continuously rotatable, remote controlled, metallic turntable and 2 meters (6.56 ft.) in diameter. The turn table is flush with the raised floor of the chamber in order to maintain its function as a ground plane. An 80cm high PVC support structure is placed on top of the turntable.

For all measurements, the spectrum was scanned through all EUT azimuths and from 1 to 4 meter receive antenna height using a broadband antenna from 30MHz up to the upper frequency shown in 15.33(b)(1) depending on the highest frequency generated or used in the device or on which the device operates or tunes. For frequencies above 1GHz, linearly polarized double ridge horn antennas were used. For frequencies below 30MHz, a calibrated loop antenna was used. When exploratory measurements were necessary, they were performed at 1 meter test distance inside the semi-anechoic chamber using broadband antennas, broadband amplifiers, and spectrum analyzers to determine the frequencies and modes producing the maximum emissions. Sufficient time for the EUT, support equipment, and test equipment was allowed in order for them to warm up to their normal operating condition. The test set-up for frequencies below 1GHz was placed on top of the 0.8 meter high, 1 x 1.5 meter table; and test set-up for frequencies 1-40GHz was placed on top of the 1.5 meter high, 1 x 1.5 meter table. The EUT, support equipment, and interconnecting cables were arranged and manipulated to maximize each emission. Appropriate precaution was taken to ensure that all emissions from the EUT were maximized and investigated. The system configuration, clock speed, mode of operation or video resolution, if applicable, turntable azimuth, and receive antenna height was noted for each frequency found.

Final measurements were made in the semi-anechoic chamber using calibrated, linearly polarized broadband and horn antennas. The test setup was configured to the setup that produced the worst case emissions. The spectrum analyzer was set to investigate all frequencies required for testing to compare the highest radiated disturbances with respect to the specified limits. The turntable containing the EUT was rotated through 360 degrees and the height of the receive antenna was varied 1 to 4 meters and stopped at the azimuth and height producing the maximum emission. Each emission was maximized by changing the orientation of the EUT through three orthogonal planes and changing the polarity of the receive antenna, whichever produced the worst-case emissions. According to 3dB Beam-Width of horn antenna, the horn antenna should be always directed to the EUT when rising height.

## 4. ANTENNA REQUIREMENTS

### **Excerpt from §15.203 of the FCC Rules/Regulations:**

“An intentional radiator antenna shall be designed to ensure that no antenna other than that furnished by the responsible party can be used with the device. The use of a permanently attached antenna or of an antenna that uses a unique coupling to the intentional radiator shall be considered sufficient to comply with the provisions of this section.”

- The antenna of the device is **permanently attached**.
- There are no provisions for connection to an external antenna.

### **Conclusion:**

The unit complies with the requirement of §15.203.

## 5. TEST EQUIPMENT CALIBRATION DATE

### Conducted Emissions

Instrument	Manufacturer	Type No.	Asset No.	Cali. Interval	Cali. Due Date
Two-Line V-Network	R&S	ENV216	MRTTWA00019	1 year	2020/03/25
Two-Line V-Network	R&S	ENV216	MRTTWA00020	1 year	2020/04/25
8-Wire ISN (T8)	R&S	ENY81	MRTTWA00018	1 year	2020/04/23
EMI Test Receiver	R&S	ESR3	MRTTWA00009	1 year	2020/03/25
Temperature/Humidity Meter	TFA	35.1078.10.IT	MRTTWA00033	1 year	2020/05/20

### Radiated Emissions

Instrument	Manufacturer	Type No.	Asset No.	Cali. Interval	Cali. Due Date
Active Loop Antenna	SCHWARZBECK	FMZB 1519B	MRTTWA00002	1 year	2020/04/29
Broadband TRILOG Antenna	SCHWARZBECK	VULB 9162	MRTTWA00001	1 year	2020/05/22
Broadband Hornantenna	SCHWARZBECK	BBHA 9120D	MRTTWA00003	1 year	2020/04/22
Breitband Hornantenna	SCHWARZBECK	BBHA 9170	MRTTWA00004	1 year	2020/04/23
Broadband Preamplifier	SCHWARZBECK	BBV 9718	MRTTWA00005	1 year	2020/04/24
Broadband Amplifier	SCHWARZBECK	BBV 9721	MRTTWA00006	1 year	2020/04/24
Signal Analyzer	R&S	FSV40	MRTTWA00007	1 year	2020/03/26
EMI Test Receiver	R&S	ESR3	MRTTWA00009	1 year	2020/03/25
EXA Signal Analyzer	KEYSIGHT	N9010A	MRTTWA00012	1 year	2019/07/30
Antenna Cable	HUBERSUHNER	SF106	MRTTWE00010	1 year	2020/06/18
Temperature/Humidity Meter	TFA	35.1078.10.IT	MRTTWA00032	1 year	2020/05/20

### Conducted Test Equipment

Instrument	Manufacturer	Type No.	Asset No.	Cali. Interval	Cali. Due Date
X-Series USB Peak and Average Power Sensor	KEYSIGHT	U2021XA	MRTTWA00014	1 year	2020/04/22
Wideband Radio Communication Taster	R&S	CMW 500	MRTTWA00041	1 year	2020/01/28
EXA Signal Analyzer	KEYSIGHT	N9010A	MRTTWA00012	1 year	2019/07/30
EXA Signal Analyzer	KEYSIGHT	N9010B	MRTSUE06457	1 year	2019/07/19
Signal Analyzer	R&S	FSV40	MRTTWA00007	1 year	2020/03/26
Temperature/Humidity Meter	TFA	35.1078.10.IT	MRTTWA00033	1 year	2020/05/20

Software	Version	Function
e3	9.160520a	EMI Test Software

## 6. MEASUREMENT UNCERTAINTY

Where relevant, the following test uncertainty levels have been estimated for tests performed on the EUT as specified in CISPR 16-4-2. This uncertainty represents an expanded uncertainty expressed at approximately the 95% confidence level using a coverage factor of  $k = 2$ .

<b>AC Conducted Emission Measurement - SR2</b>
Measuring Uncertainty for a Level of Confidence of 95% ( $U=2Uc(y)$ ): 150kHz~30MHz: 2.53dB
<b>Radiated Emission Measurement - AC1</b>
Measuring Uncertainty for a Level of Confidence of 95% ( $U=2Uc(y)$ ): 9kHz ~ 1GHz: 4.25dB 1GHz ~ 25GHz: 4.45dB

## 7. TEST RESULT

### 7.1. Summary

FCC Section(s)	Test Description	Test Limit	Test Condition	Test Result	Reference
15.247(a)(2)	6dB Bandwidth	$\geq 500\text{kHz}$	Conducted	Pass	Section 7.2
15.247(b)(3)	Output Power	$\leq 30\text{dBm}$		Pass	Section 7.3
15.247(e)	Power Spectral Density	$\leq 8\text{dBm}/3\text{kHz}$		Pass	Section 7.4
15.247(d)	Band Edge / Out-of-Band Emissions	$\leq 20\text{dBc(Peak)}$		Pass	Section 7.5
15.205 15.209	General Field Strength Limits (Restricted Bands and Radiated Emission Limits)	Emissions in restricted bands must meet the radiated limits detailed in 15.209	Radiated	Pass	Section 7.6 & 7.7
15.207	AC Conducted Emissions 150kHz - 30MHz	< FCC 15.207 limits	Line Conducted	N/A	Section 7.8

#### Notes:

- 1) The analyzer plots shown in this section were all taken with a correction table loaded into the analyzer. The correction table was used to account for the losses of the cables and attenuators used as part of the system to connect the EUT to the analyzer at all frequencies of interest.
- 2) All modes of operation and data rates were investigated. For radiated emission test, every axis (X, Y, Z) was also verified. The test results shown in the following sections represent the worst case emissions.
- 3) "N/A" means that this item is not applicable, and the detail information refers to relevant section.



## 7.2. 6dB Bandwidth Measurement

### 7.2.1. Test Limit

The minimum 6dB bandwidth shall be at least 500 kHz.

### 7.2.2. Test Procedure used

ANSI C63.10 Section 11.8.2 Option 2

### 7.2.3. Test Setting

1. The Spectrum's automatic bandwidth measurement capability was used to perform the 6dB bandwidth measurement. The "X" dB bandwidth parameter was set to  $X = 6$ . The bandwidth measurement was not influenced by any intermediate power nulls in the fundamental emission.
2. Set RBW = 100 kHz
3.  $VBW \geq 3 \times RBW$
4. Detector = Peak
5. Trace mode = max hold
6. Sweep = auto couple
7. Allow the trace was allowed to stabilize

### 7.2.4. Test Setup

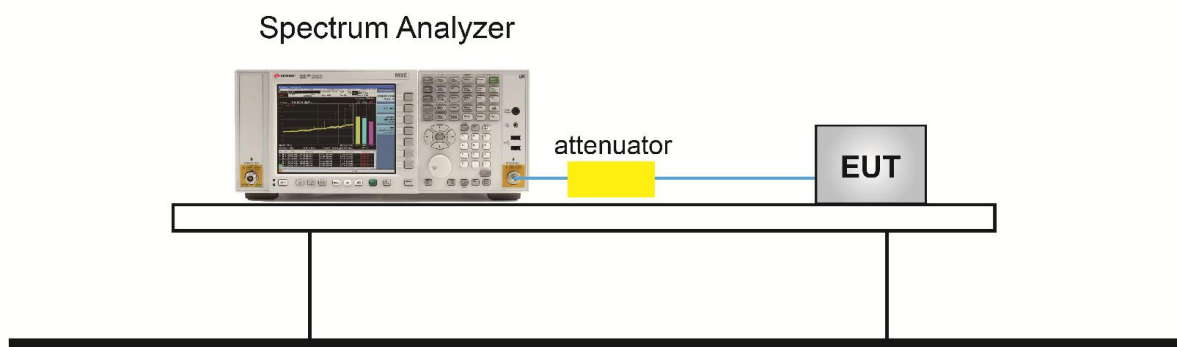

### 7.2.5. Test Result

Product	REMOTE CONTROLLER	Temperature	23°C
Test Engineer	Kevin Ker	Relative Humidity	54%
Test Site	SR1	Test Date	2019/07/04

Test Mode	Data Rate / Mbps	Channel No.	Frequency (MHz)	6dB Bandwidth (MHz)	Limit (MHz)	Result
BLE	1	00	2402	0.92	≥ 0.5	Pass
BLE	1	20	2442	0.96	≥ 0.5	Pass
BLE	1	39	2480	0.99	≥ 0.5	Pass

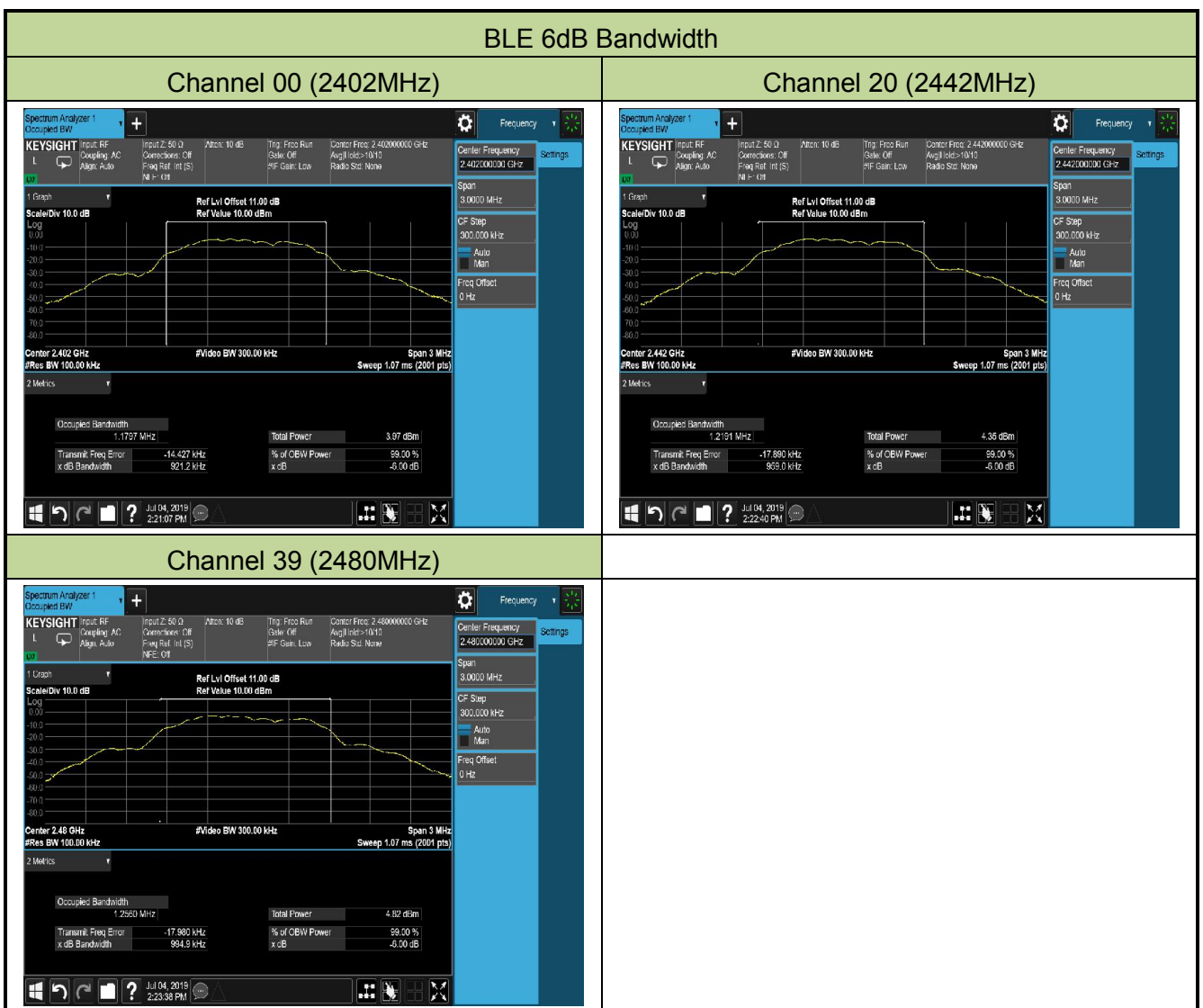

### **7.3. Output Power Measurement**

#### **7.3.1. Test Limit**

The maximum output power shall be less 1 Watt (30dBm).

The conducted output power limit specified in paragraph FCC Part 15.247(b) of this section is based on the use of antennas with directional gains that do not exceed 6 dBi. If transmitting antennas of directional gain greater than 6 dBi are used, the conducted output power from the intentional radiator shall be reduced below the stated values in paragraphs FCC Part 15.247(b)(3) of this section, as appropriate, by the amount in dB that the directional gain of the antenna exceeds 6 dBi.

#### **7.3.2. Test Procedure Used**

ANSI C63.10-2013 - Section 11.9.1.3 PKPM1 Peak-reading power meter method

ANSI C63.10-2013 - Section 11.9.2.3.2 Method AVGPM-G

#### **7.3.3. Test Setting**

##### **Method PKPM1 (Peak power measurement)**

Peak power measurements were performed only when the EUT was transmitting at its maximum power control level using a broadband power meter with a pulse sensor. The pulse sensor employs a VBW = 50MHz so this method was only used for signals whose DTS bandwidth was less than or equal to 50MHz.

##### **Method AVGPM-G (Measurement using a gated RF average-reading power meter)**

Measurements may be performed using a wideband gated RF power meter provided that the gate parameters are adjusted such that the power is measured only when the EUT is transmitting at its maximum power control level. Since this measurement is made only during the ON time of the transmitter, no duty cycle correction is required.

### 7.3.4. Test Setup

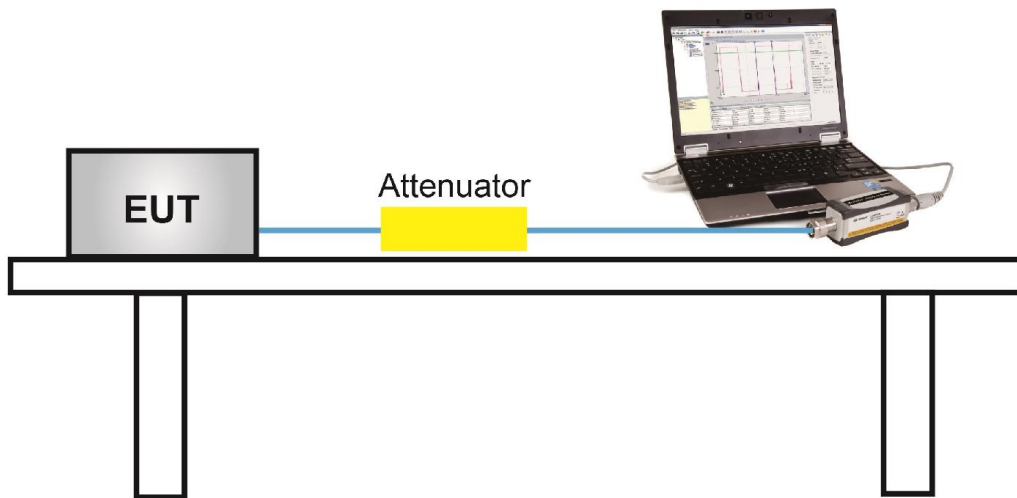

### 7.3.5. Test Result

Product	REMOTE CONTROLLER	Temperature	23°C
Test Engineer	Kevin Ker	Relative Humidity	54%
Test Site	SR1	Test Date	2019/07/04

### Test Result of Peak Output Power

Test Mode	Data Rate / Mbps	Channel No.	Freq. (MHz)	Peak Power (dBm)	Power Limit (dBm)	Result
BLE	1	00	2402	2.28	≤ 30.00	Pass
BLE	1	20	2442	2.61	≤ 30.00	Pass
BLE	1	39	2480	3.14	≤ 30.00	Pass

### Test Result of Average Output Power (Reporting Only)

Test Mode	Data Rate / Mbps	Channel No.	Freq. (MHz)	Average Power (dBm)	Power Limit (dBm)	Result
BLE	1	00	2402	2.05	≤ 30.00	Pass
BLE	1	20	2442	2.40	≤ 30.00	Pass
BLE	1	39	2480	2.96	≤ 30.00	Pass

## 7.4. Power Spectral Density Measurement

### 7.4.1. Test Limit

The maximum permissible power spectral density is 8dBm in any 3 kHz band.

The same method of determining the conducted output power shall be used to determine the power spectral density.

### 7.4.2. Test Procedure Used

ANSI C63.10-2013 - Section 11.10.2.

### 7.4.3. Test Setting

1. Analyzer was set to the center frequency of the DTS channel under investigation
2. Span = 1.5 times the DTS channel bandwidth
3. RBW = 3kHz
4. VBW = 10kHz
5. Detector = peak
6. Sweep time = auto couple
7. Trace mode = max hold
8. Trace was allowed to stabilize

### 7.4.4. Test Setup

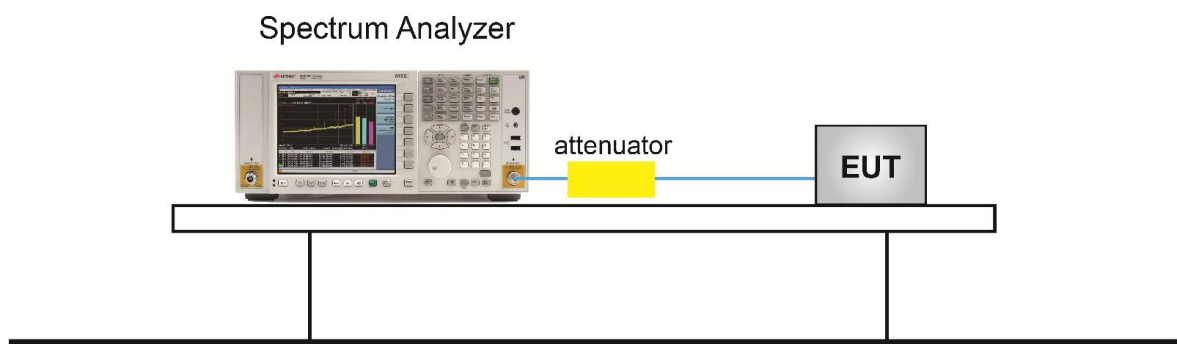

**7.4.5. Test Result**

Product	REMOTE CONTROLLER	Temperature	23°C
Test Engineer	Kevin Ker	Relative Humidity	54%
Test Site	SR1	Test Date	2019/07/04

Test Mode	Data Rate (Mbps)	Channel No.	Frequency (MHz)	PSD Result (dBm / 3kHz)	Limit (dBm / 3kHz)	Result
BLE	1	00	2402	-10.88	≤ 8.00	Pass
BLE	1	20	2442	-11.46	≤ 8.00	Pass
BLE	1	39	2480	-11.12	≤ 8.00	Pass

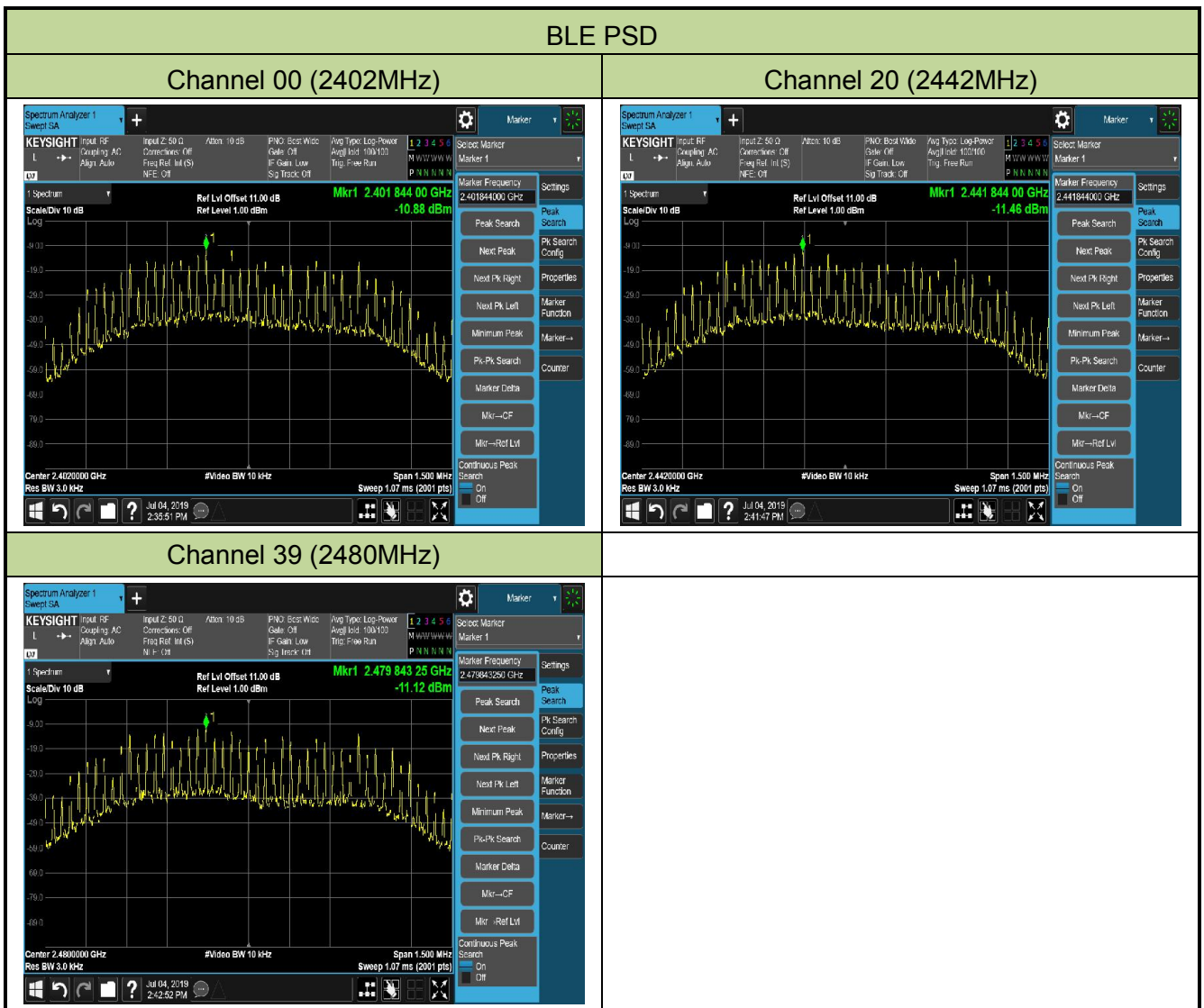

## **7.5. Conducted Band Edge and Out-of-Band Emissions**

### **7.5.1. Test Limit**

The limit for out-of-band spurious emissions at the band edge is 20dB below the fundamental emission level, as determined from the in-band power measurement of the DTS channel performed in a 100 kHz bandwidth per the PSD procedure.

### **7.5.2. Test Procedure Used**

ANSI C63.10-2013 - Section 11.11.2 & 11.11.3.

### **7.5.3. Test Setting**

#### **Reference level measurement**

1. Set instrument center frequency to DTS channel center frequency
2. Set the span to  $\geq 1.5$  times the DTS bandwidth
3. Set the RBW = 100 kHz
4. Set the VBW  $\geq 3 \times$  RBW
5. Detector = peak
6. Sweep time = auto couple
7. Trace mode = max hold
8. Allow trace to fully stabilize

#### **Emission level measurement**

1. Set the center frequency and span to encompass frequency range to be measured
2. RBW = 1.3MHz
3. VBW = 4MHz
4. Detector = Peak
5. Trace mode = max hold
6. Sweep time = auto couple
7. The trace was allowed to stabilize



### Test Notes

1. RBW was set to 1.3MHz rather than 100 kHz in order to increase the measurement speed.
2. The display line shown in the following plots denotes the limit at 20dB below the fundamental emission level measured in a 100 kHz bandwidth. However, since the traces in the following plots are measured with a 1.3MHz RBW, the display line may not necessarily appear to be 20dB below the level of the fundamental in a 1.3MHz bandwidth.
3. For plots showing conducted spurious emissions near the limit, the frequencies were investigated with a reduced RBW to ensure that no emissions were present.

### 7.5.4. Test Setup

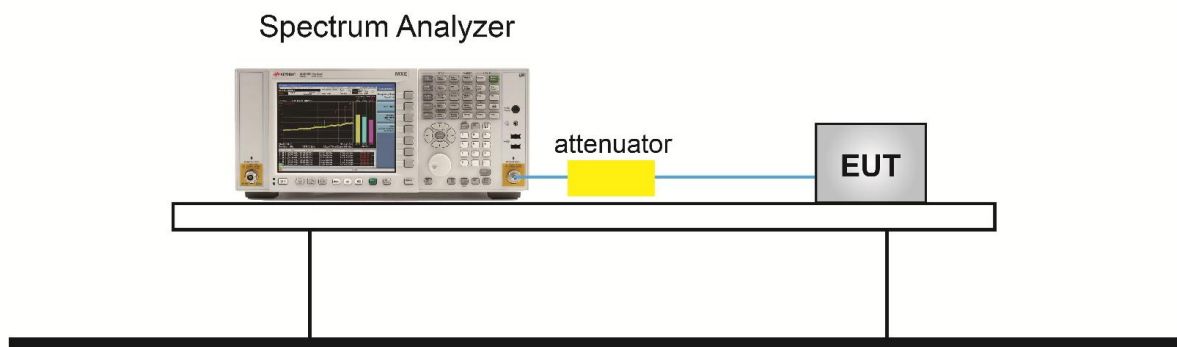

### 7.5.5. Test Result

Product	REMOTE CONTROLLER	Temperature	23°C
Test Engineer	Kevin Ker	Relative Humidity	54%
Test Site	SR1	Test Date	2019/07/04

Test Mode	Data Rate / Mbps	Channel No.	Frequency (MHz)	Limit (dBc)	Result
BLE	1	00	2402	20	Pass
BLE	1	20	2442	20	Pass
BLE	1	39	2480	20	Pass

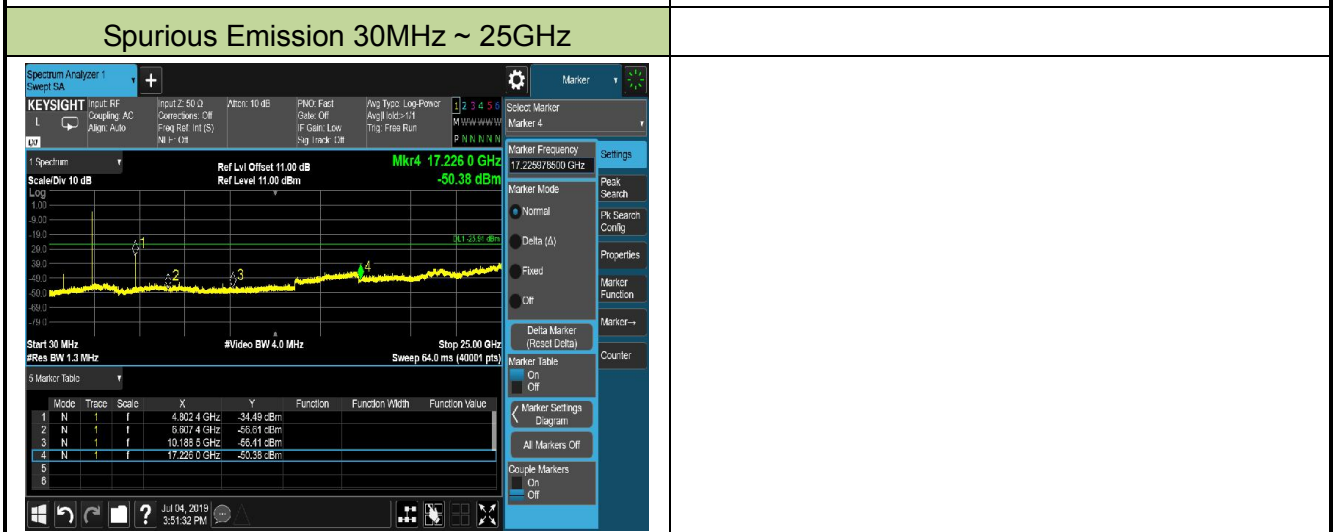
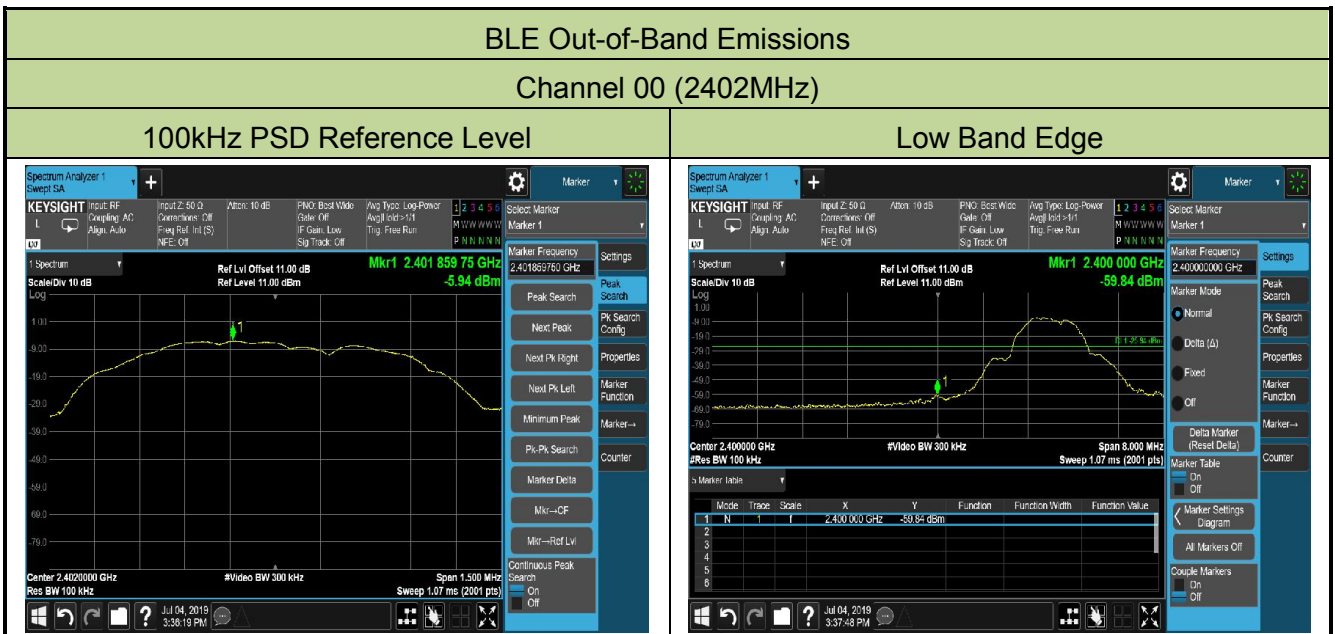

### Channel 20 (2442MHz)

#### 100kHz PSD Reference Level



#### Spurious Emission 30MHz ~ 25GHz



### Channel 39 (2480MHz)

#### 100kHz PSD Reference Level



#### High Band Edge



#### Spurious Emission 30MHz ~ 25GHz

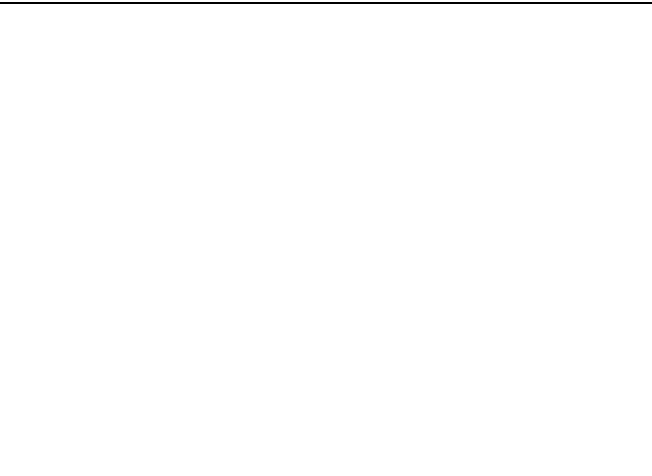

## 7.6. Radiated Spurious Emission Measurement

### 7.6.1. Test Limit

#### Transmitter Spurious Emission Limits

All out of band emissions appearing in a restricted band as specified in Section 15.205 of the Title 47CFR must not exceed the limits shown in Table per Section 15.209.

FCC Part 15 Subpart C Paragraph 15.209		
Frequency [MHz]	Field Strength [uV/m]	Measured Distance [Meters]
0.009 - 0.490	2400/F (kHz)	300
0.490 - 1.705	24000/F (kHz)	30
1.705 - 30	30	30
30 - 88	100	3
88 - 216	150	3
216 - 960	200	3
Above 960	500	3

#### Receiver Spurious Emission Limits

Spurious emissions from receivers shall not exceed the radiated emissions limits shown in below table.

FCC Part 15 Subpart B Paragraph 15.109	
Frequency [MHz]	Field Strength [uV/m at 3 meters]
30 - 88	100
88 - 216	150
216 - 960	200
Above 960	500

### 7.6.2. Test Procedure Used

ANSI C63.10 Section 6.3 (General Requirements)

ANSI C63.10 Section 6.4 (Standard test method below 30MHz)

ANSI C63.10 Section 6.5 (Standard test method above 30MHz to 1GHz)

ANSI C63.10 Section 6.6 (Standard test method above 1GHz)

### 7.6.3. Test Setting

**Table 1 - RBW as a function of frequency**

Frequency	RBW
9 ~ 150 kHz	200 ~ 300 Hz
0.15 ~ 30 MHz	9 ~ 10 kHz
30 ~ 1000 MHz	100 ~ 120 kHz
> 1000 MHz	1 MHz

#### **Quasi-Peak Measurements below 1GHz**

1. Analyzer center frequency was set to the frequency of the radiated spurious emission of interest
2. Span was set greater than 1MHz
3. RBW = as specified in Table 1
4. Detector = CISPR quasi-peak
5. Sweep time = auto couple
6. Trace was allowed to stabilize

#### **Peak Measurements above 1GHz**

1. Analyzer center frequency was set to the frequency of the radiated spurious emission of interest
2. RBW = 1MHz
3. VBW = 3MHz
4. Detector = peak
5. Sweep time = auto couple
6. Trace mode = max hold
7. Trace was allowed to stabilize

**Average Measurements above 1GHz (Method VB)**

1. Analyzer center frequency was set to the frequency of the radiated spurious emission of interest
2. RBW = 1MHz
3. VBW; If the EUT is configured to transmit with duty cycle  $\geq 98\%$ , set VBW = 10 Hz.  
If the EUT duty cycle is  $< 98\%$ , set VBW  $\geq 1/T$ . T is the minimum transmission duration.
4. Detector = Peak
5. Sweep time = auto
6. Trace mode = max hold
7. Trace was allowed to stabilize

### 7.6.4. Test Setup

#### Below 1GHz Test Setup:

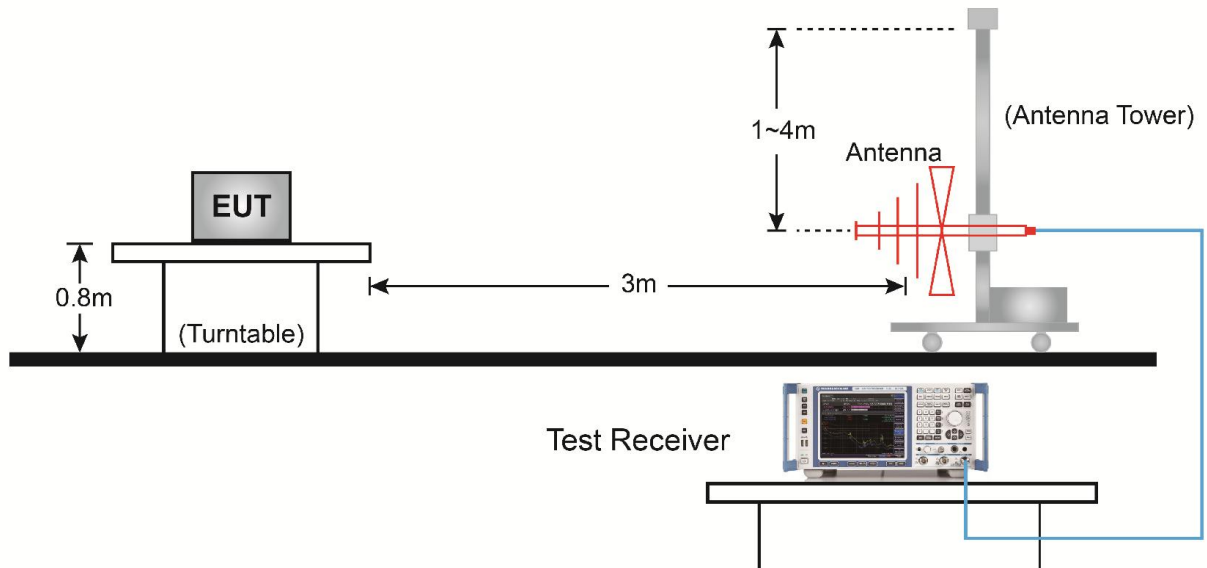

#### Above 1GHz Test Setup:

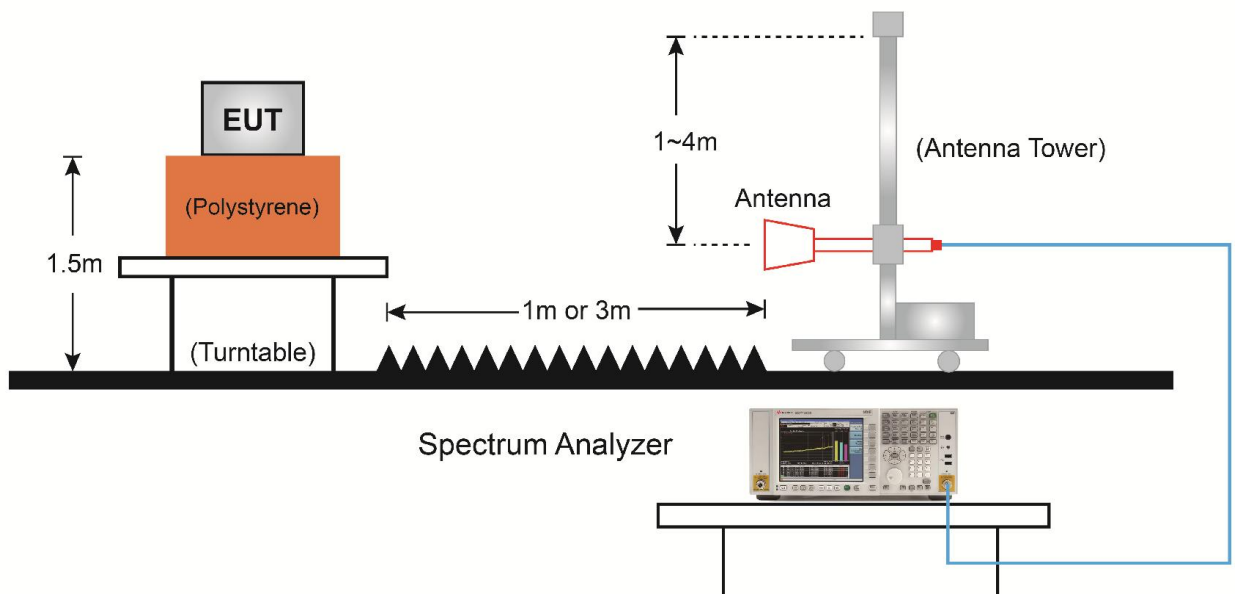

### 7.6.5. Test Result

#### Transmitter Spurious Emission

Product	REMOTE CONTROLLER	Temperature	25°C
Test Engineer	Kevin Ker	Relative Humidity	52%
Test Site	AC1	Test Date	2019/06/28
Test Mode	BLE	Test Channel	00
Note	1. Average measurement was not performed if peak level lower than average limit. 2. Other frequency was 20dB below limit line within 1-18GHz, there is not show in the report.		

Mark	Frequency (MHz)	Reading Level (dBμV)	Factor (dB)	Measure Level (dBμV/m)	Limit (dBμV/m)	Margin (dB)	Detector	Polarization
	4804.0	50.3	3.3	53.6	54.0	-0.4	Average	Horizontal
	4808.0	50.0	3.3	53.8	74.0	-20.2	Peak	Horizontal
*	6015.0	38.6	6.2	44.8	82.3	-37.5	Peak	Horizontal
	7570.5	35.0	12.7	47.7	74.0	-26.3	Peak	Horizontal
*	9610.5	37.7	14.9	52.6	82.3	-29.7	Peak	Horizontal
	4808.0	47.0	3.3	50.3	74.0	-23.7	Peak	Vertical
*	6329.5	37.2	7.7	44.9	82.3	-37.4	Peak	Vertical
	7579.0	33.5	12.8	46.3	74.0	-27.7	Peak	Vertical
*	9610.5	39.2	14.9	54.1	82.3	-28.2	Peak	Vertical

Note 1: "\*" is not in restricted band, its limit is 20dBc of the fundamental emission level (102.3 dBμV/m) or 15.209 which is higher.

Note 2: Measure Level (dBμV/m) = Reading Level (dBμV) + Factor (dB)

Factor (dB) = Cable Loss (dB) + Antenna Factor (dB/m) - Pre\_Amplifier Gain (dB)



Product	REMOTE CONTROLLER	Temperature	25°C
Test Engineer	Kevin Ker	Relative Humidity	52%
Test Site	AC1	Test Date	2019/06/28
Test Mode	BLE	Test Channel	20
Note	1. Average measurement was not performed if peak level lower than average limit. 2. Other frequency was 20dB below limit line within 1-18GHz, there is not show in the report.		

Mark	Frequency (MHz)	Reading Level (dBμV)	Factor (dB)	Measure Level (dBμV/m)	Limit (dBμV/m)	Margin (dB)	Detector	Polarization
	4884.0	49.6	3.5	53.1	54.0	-0.9	Average	Horizontal
	4884.5	50.6	3.5	54.1	74.0	-19.9	Peak	Horizontal
*	6261.5	37.0	7.3	44.3	81.7	-37.4	Peak	Horizontal
	7477.0	35.0	12.7	47.7	74.0	-26.3	Peak	Horizontal
*	9772.0	38.2	15.2	53.4	81.7	-28.3	Peak	Horizontal
	4884.5	47.8	3.5	51.3	74.0	-22.7	Peak	Vertical
*	6278.5	37.7	7.4	45.1	81.7	-36.6	Peak	Vertical
	7655.5	35.3	12.8	48.1	74.0	-25.9	Peak	Vertical
*	9772.0	37.7	15.2	52.9	81.7	-28.8	Peak	Vertical

Note 1: "\*" is not in restricted band, its limit is 20dBc of the fundamental emission level (101.7dBμV/m) or 15.209 which is higher.

Note 2: Measure Level (dBμV/m) = Reading Level (dBμV) + Factor (dB)

Factor (dB) = Cable Loss (dB) + Antenna Factor (dB/m) - Pre\_Amplifier Gain (dB)

Product	REMOTE CONTROLLER	Temperature	25°C
Test Engineer	Kevin Ker	Relative Humidity	52%
Test Site	AC1	Test Date	2019/06/28
Test Mode	BLE	Test Channel	39
Note	1. Average measurement was not performed if peak level lower than average limit. 2. Other frequency was 20dB below limit line within 1-18GHz, there is not show in the report.		

Mark	Frequency (MHz)	Reading Level (dBμV)	Factor (dB)	Measure Level (dBμV/m)	Limit (dBμV/m)	Margin (dB)	Detector	Polarization
	4960.0	50.0	3.7	53.7	54.0	-0.3	Average	Horizontal
	4961.0	50.1	3.7	53.8	74.0	-20.2	Peak	Horizontal
*	6338.0	35.9	7.7	43.6	81.3	-37.7	Peak	Horizontal
	7443.0	35.5	12.6	48.1	74.0	-25.9	Peak	Horizontal
*	9916.5	39.0	15.6	54.6	81.3	-26.7	Peak	Horizontal
	4961.0	46.2	3.7	49.9	74.0	-24.1	Peak	Vertical
*	6516.5	36.5	8.6	45.1	81.3	-36.2	Peak	Vertical
	8420.5	35.1	13.1	48.2	74.0	-25.8	Peak	Vertical
*	9916.5	35.8	15.6	51.4	81.3	-29.9	Peak	Vertical

Note 1: "\*" is not in restricted band, its limit is 20dBc of the fundamental emission level (101.3dBμV/m) or 15.209 which is higher.

Note 2: Measure Level (dBμV/m) = Reading Level (dBμV) + Factor (dB)

Factor (dB) = Cable Loss (dB) + Antenna Factor (dB/m) - Pre\_Amplifier Gain (dB)

**Receiver Spurious Emission**

Product	REMOTE CONTROLLER	Temperature	25°C
Test Engineer	Kevin Ker	Relative Humidity	52%
Test Site	AC1	Test Date	2019/07/18
Test Mode	BLE	Test Channel	00
Note	1. Average measurement was not performed if peak level lower than average limit. 2. Other frequency was 20dB below limit line within 1-18GHz, there is not show in the report.		

Frequency (MHz)	Reading Level (dBμV)	Factor (dB)	Measure Level (dBμV/m)	Limit (dBμV/m)	Margin (dB)	Detector	Polarization
4804.0	33.9	3.3	37.2	74.0	-36.8	Peak	Horizontal
5379.0	33.1	4.1	37.2	74.0	-36.8	Peak	Horizontal
8808.0	29.1	13.9	43.0	74.0	-31.0	Peak	Horizontal
9608.0	30.6	14.9	45.5	74.0	-28.5	Peak	Horizontal
4804.0	32.7	3.3	36.0	74.0	-38.0	Peak	Vertical
7539.0	30.2	12.7	42.9	74.0	-31.1	Peak	Vertical
8931.0	27.9	14.2	42.1	74.0	-31.9	Peak	Vertical
9608.0	29.6	14.9	44.5	74.0	-29.5	Peak	Vertical

Note: Measure Level (dBμV/m) = Reading Level (dBμV) + Factor (dB)

Factor (dB) = Cable Loss (dB) + Antenna Factor (dB/m) - Pre\_Amplifier Gain (dB)

Product	REMOTE CONTROLLER	Temperature	25°C
Test Engineer	Kevin Ker	Relative Humidity	52%
Test Site	AC1	Test Date	2019/07/18
Test Mode	BLE	Test Channel	20
Note	1. Average measurement was not performed if peak level lower than average limit. 2. Other frequency was 20dB below limit line within 1-18GHz, there is not show in the report.		

Frequency (MHz)	Reading Level (dBμV)	Factor (dB)	Measure Level (dBμV/m)	Limit (dBμV/m)	Margin (dB)	Detector	Polarization
4884.0	33.4	3.5	36.9	74.0	-37.1	Peak	Horizontal
5406.0	33.0	4.1	37.1	74.0	-36.9	Peak	Horizontal
8679.0	29.7	13.6	43.3	74.0	-30.7	Peak	Horizontal
9768.0	29.7	15.2	44.9	74.0	-29.1	Peak	Horizontal
4884.0	34.1	3.5	37.6	74.0	-36.4	Peak	Vertical
5417.0	33.8	4.1	37.9	74.0	-36.1	Peak	Vertical
8852.0	27.9	14.0	41.9	74.0	-32.1	Peak	Vertical
9768.0	30.1	15.2	45.3	74.0	-28.7	Peak	Vertical

Note: Measure Level (dBμV/m) = Reading Level (dBμV) + Factor (dB)

Factor (dB) = Cable Loss (dB) + Antenna Factor (dB/m) - Pre\_Amplifier Gain (dB)

Product	REMOTE CONTROLLER	Temperature	25°C
Test Engineer	Kevin Ker	Relative Humidity	52%
Test Site	AC1	Test Date	2019/07/18
Test Mode	BLE	Test Channel	39
Note	1. Average measurement was not performed if peak level lower than average limit. 2. Other frequency was 20dB below limit line within 1-18GHz, there is not show in the report.		

Frequency (MHz)	Reading Level (dBμV)	Factor (dB)	Measure Level (dBμV/m)	Limit (dBμV/m)	Margin (dB)	Detector	Polarization
4960.0	34.1	3.7	37.8	74.0	-36.2	Peak	Horizontal
5391.0	33.6	4.1	37.7	74.0	-36.3	Peak	Horizontal
8815.0	29.2	13.9	43.1	74.0	-30.9	Peak	Horizontal
9920.0	28.8	15.6	44.4	74.0	-29.6	Peak	Horizontal
4960.0	33.5	3.7	37.2	74.0	-36.8	Peak	Vertical
5402.0	34.0	4.1	38.1	74.0	-35.9	Peak	Vertical
8879.0	29.7	14.1	43.8	74.0	-30.2	Peak	Vertical
9920.0	29.5	15.6	45.1	74.0	-28.9	Peak	Vertical

Note: Measure Level (dBμV/m) = Reading Level (dBμV) + Factor (dB)

Factor (dB) = Cable Loss (dB) + Antenna Factor (dB/m) - Pre\_Amplifier Gain (dB)

**The Worst Case of Radiated Emission below 1GHz:**

Site: AC1	Time: 2019/06/24 - 16:59
Limit: FCC_Part15.209_RSE(3m)	Engineer: Kevin Ker
Probe: VULB 9162 30MHz-8GHz	Polarity: Horizontal
EUT: REMOTE CONTROLLER	Power: By Battery
<b>Worst Case Mode: There is the worst case within frequency range 30MHz~1GHz.</b>	

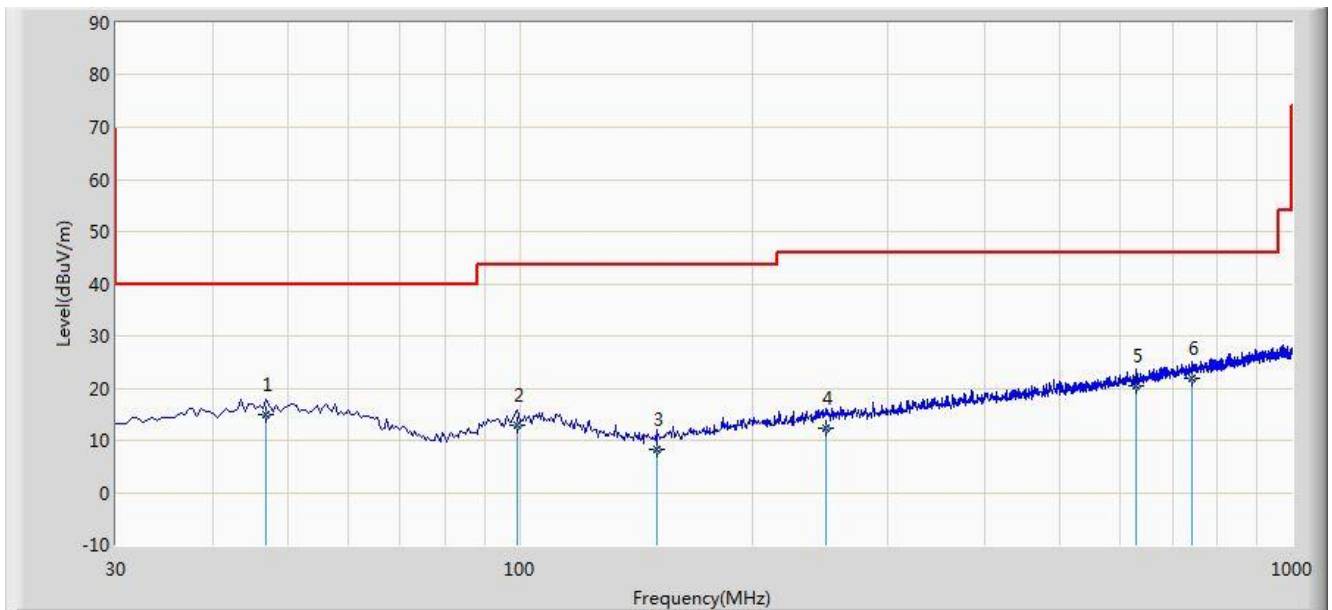

No	Flag	Mark	Frequency (MHz)	Measure Level (dBuV/m)	Reading Level (dBuV)	Margin (dB)	Limit (dBuV/m)	Factor (dB)	Type
1			46.948	15.047	-6.709	-24.953	40.000	21.756	QP
2			99.326	12.866	-6.141	-30.634	43.500	19.007	QP
3			150.290	8.172	-7.515	-35.328	43.500	15.686	QP
4			249.126	12.284	-8.016	-33.716	46.000	20.300	QP
5			627.265	20.326	-7.715	-25.674	46.000	28.042	QP
6		*	743.423	21.913	-7.906	-24.087	46.000	29.819	QP

Note 1: Measure Level (dBμV/m) = Reading Level (dBμV) + Factor (dB)

Factor (dB) = Cable Loss (dB) + Antenna Factor (dB/m)

Note 2: The test trace is same as the ambient noise and the amplitude of the emissions are attenuated more than 20dB below the permissible (the test frequency range: 9kHz ~ 30MHz, 18GHz ~ 25GHz), therefore no data appear in the report.

Site: AC1	Time: 2019/06/24 - 17:01
Limit: FCC_Part15.209_RSE(3m)	Engineer: Kevin Ker
Probe: VULB 9162 30MHz-8GHz	Polarity: Vertical
EUT: REMOTE CONTROLLER	Power: By Battery
<b>Worst Case Mode: There is the worst case within frequency range 30MHz~1GHz.</b>	

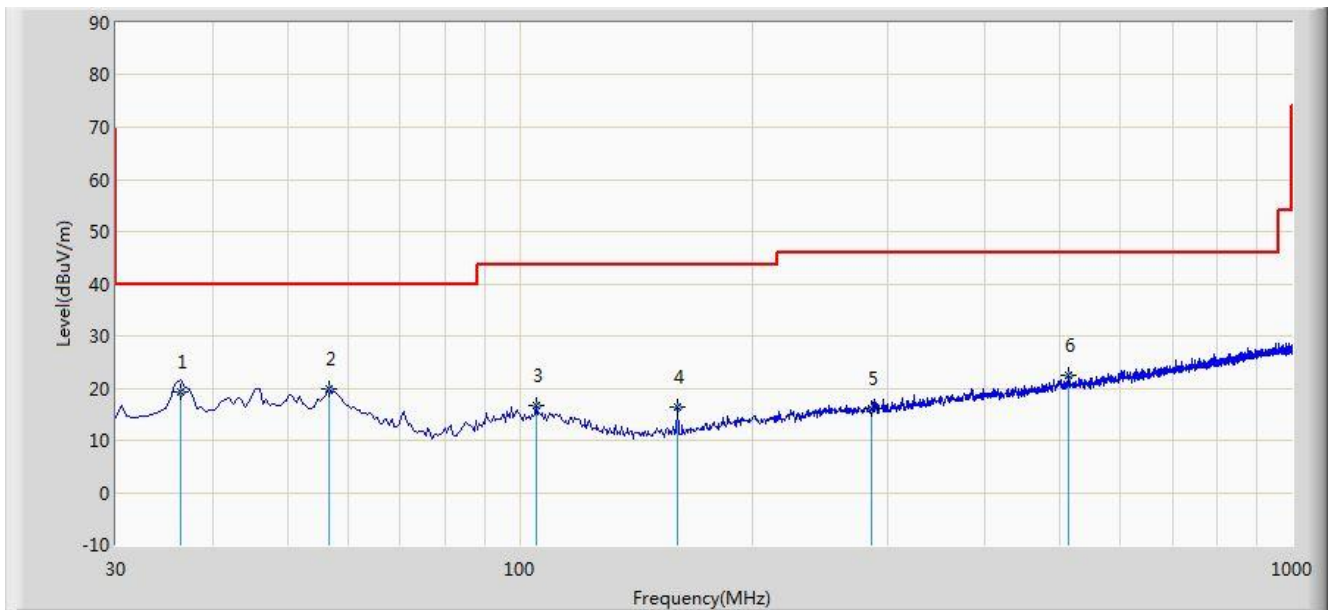

No	Flag	Mark	Frequency (MHz)	Measure Level (dBuV/m)	Reading Level (dBuV)	Margin (dB)	Limit (dBuV/m)	Factor (dB)	Type
1			36.305	19.267	-0.133	-20.733	40.000	19.400	QP
2		*	56.675	19.843	-0.846	-20.157	40.000	20.689	QP
3			105.175	16.588	-2.598	-26.912	43.500	19.186	QP
4			159.980	16.416	0.300	-27.084	43.500	16.116	QP
5			286.080	16.175	-4.903	-29.825	46.000	21.078	QP
6			512.575	22.558	-3.585	-23.442	46.000	26.143	QP

Note 1: Measure Level (dBuV/m) = Reading Level (dBuV) + Factor (dB)

Factor (dB) = Cable Loss (dB) + Antenna Factor (dB/m)

Note 2: The test trace is same as the ambient noise and the amplitude of the emissions are attenuated more than 20dB below the permissible (the test frequency range: 9kHz ~ 30MHz, 18GHz ~ 25GHz), therefore no data appear in the report.

## 7.7. Radiated Restricted Band Edge Measurement

### 7.7.1. Test Limit

#### **For 15.205 requirement:**

Radiated emissions which fall in the restricted bands, as defined in Section 15.205(a) of FCC part 15, must also comply with the radiated emission limits specified in Section 15.209(a).

Frequency (MHz)	Frequency (MHz)	Frequency (MHz)	Frequency (GHz)
0.090 - 0.110	16.42 - 16.423	399.9 - 410	4.5 - 5.15
<sup>1</sup> 0.495 - 0.505	16.69475 - 16.69525	608 - 614	5.35 - 5.46
2.1735 - 2.1905	16.80425 - 16.80475	960 - 1240	7.25 - 7.75
4.125 - 4.128	25.5 - 25.67	1300 - 1427	8.025 - 8.5
4.17725 - 4.17775	37.5 - 38.25	1435 - 1626.5	9.0 - 9.2
4.20725 - 4.20775	73 - 74.6	1645.5 - 1646.5	9.3 - 9.5
6.215 - 6.218	74.8 - 75.2	1660 - 1710	10.6 - 12.7
6.26775 - 6.26825	108 - 121.94	1718.8 - 1722.2	13.25 - 13.4
6.31175 - 6.31225	123 - 138	2200 - 2300	14.47 - 14.5
8.291 - 8.294	149.9 - 150.05	2310 - 2390	15.35 - 16.2
8.362 - 8.366	156.52475 - 156.52525	2483.5 - 2500	17.7 - 21.4
8.37625 - 8.38675	156.7 - 156.9	2690 - 2900	22.01 - 23.12
8.41425 - 8.41475	162.0125 - 167.17	3260 - 3267	23.6 - 24.0
12.29 - 12.293	167.72 - 173.2	3332 - 3339	31.2 - 31.8
12.51975 - 12.52025	240 - 285	3345.8 - 3358	36.43 - 36.5
12.57675 - 12.57725	322 - 335.4	3600 - 4400	( <sup>2</sup> )
13.36 - 13.41	--	--	--



All out of band emissions appearing in a restricted band as specified in Section 15.205 of the Title 47CFR must not exceed the limits shown in Table per Section 15.209.

FCC Part 15 Subpart C Paragraph 15.209 Limits		
Frequency [MHz]	Field Strength [uV/m]	Measured Distance [Meters]
0.009 - 0.490	2400/F (kHz)	300
0.490 - 1.705	24000/F (kHz)	30
1.705 - 30	30	30
30 - 88	100	3
88 - 216	150	3
216 - 960	200	3
Above 960	500	3

### 7.7.2. Test Procedure Used

ANSI C63.10 Section 6.3 (General Requirements)

ANSI C63.10 Section 6.6 (Standard test method above 1GHz)

### 7.7.3. Test Setting

#### Peak Field Strength Measurements

1. Analyzer center frequency was set to the frequency of the radiated spurious emission of interest
2. RBW = 1MHz
3. VBW = 3MHz
4. Detector = peak
5. Sweep time = auto couple
6. Trace mode = max hold
7. Trace was allowed to stabilize

### Average Measurements above 1GHz (Method VB)

1. Analyzer center frequency was set to the frequency of the radiated spurious emission of interest
2. RBW = 1MHz
3. VBW; If the EUT is configured to transmit with duty cycle  $\geq 98\%$ , set VBW = 10 Hz.  
If the EUT duty cycle is  $< 98\%$ , set VBW  $\geq 1/T$ . T is the minimum transmission duration.

4. Detector = Peak
5. Sweep time = auto
6. Trace mode = max hold
7. Trace was allowed to stabilize

#### 7.7.4. Test Setup

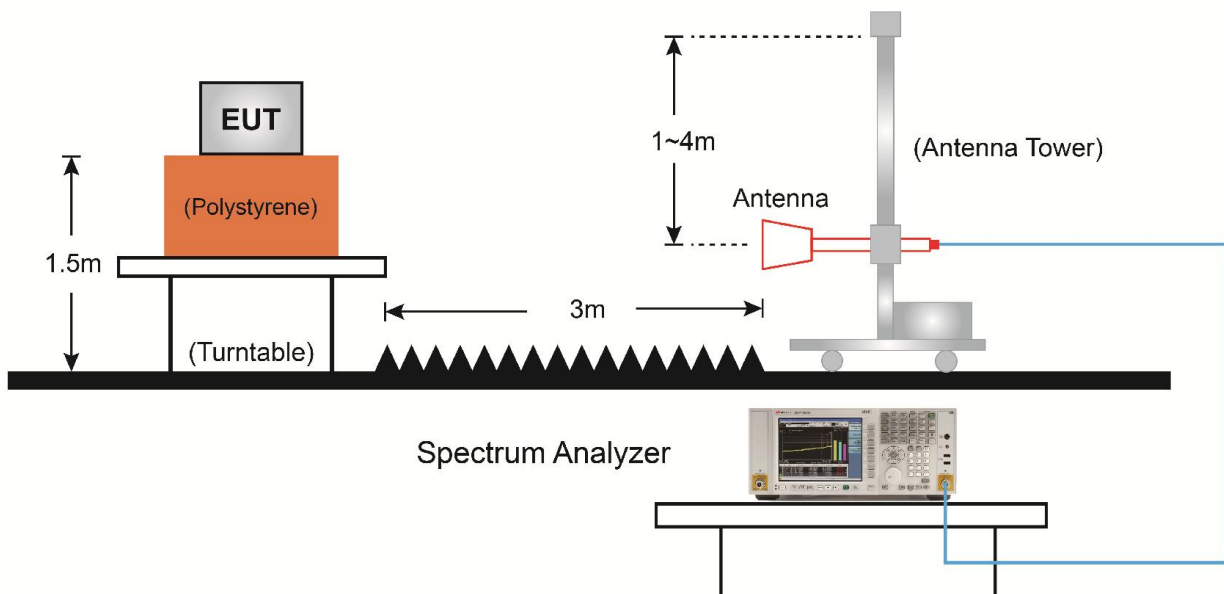

### 7.7.5.Test Result

Site: AC1	Time: 2019/06/26 - 13:25
Limit: FCC_Part15.209_RSE(3m)	Engineer: Kevin Ker
Probe: BBHA 9120D_1-18GHz	Polarity: Horizontal
EUT: REMOTE CONTROLLER	Power: By Battery
Note: Transmit by BLE at channel 2402MHz	

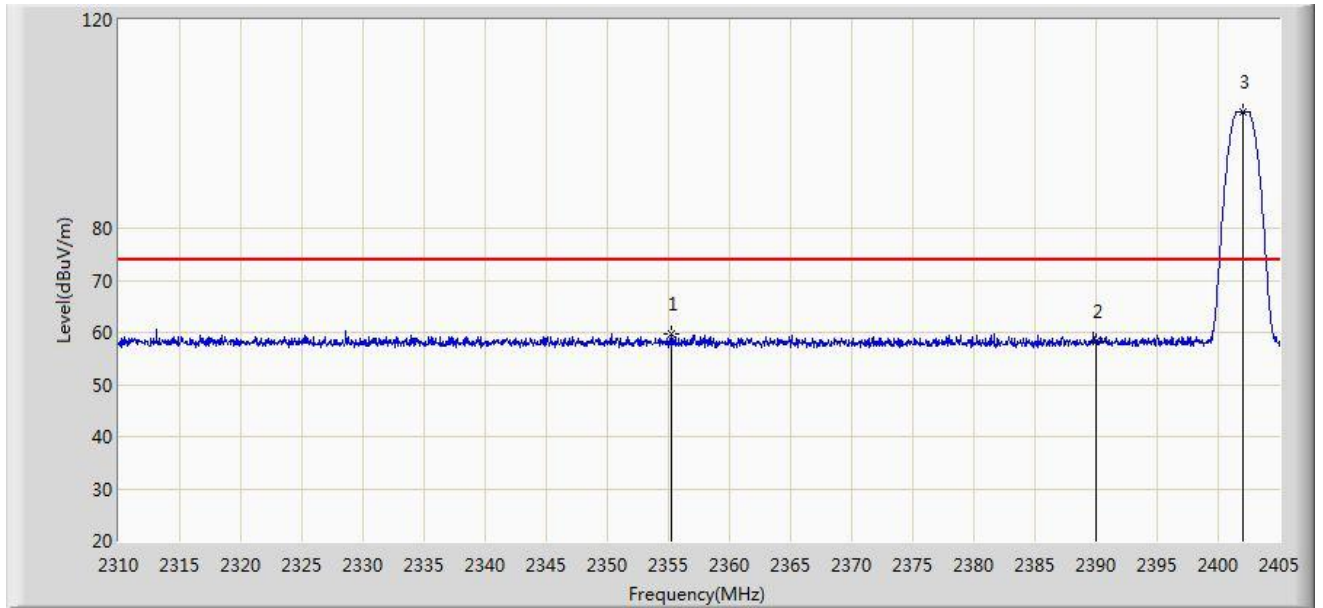

No	Mark	Frequency (MHz)	Measure Level (dBuV/m)	Reading Level (dBuV)	Over Limit (dB)	Limit (dBuV/m)	Factor (dB)	Type
1		2355.220	59.763	27.391	-14.237	74.000	32.373	PK
2		2390.000	58.343	25.825	-15.657	74.000	32.518	PK
3	*	2402.008	102.265	69.697	N/A	N/A	32.568	PK

Note: Measure Level (dBμV/m) = Reading Level (dBμV) + Factor (dB)

Factor (dB) = Cable Loss (dB) + Antenna Factor (dB/m)

Site: AC1	Time: 2019/06/26 - 13:27
Limit: FCC_Part15.209_RSE(3m)	Engineer: Kevin Ker
Probe: BBHA 9120D_1-18GHz	Polarity: Horizontal
EUT: REMOTE CONTROLLER	Power: By Battery
Note: Transmit by BLE at channel 2402MHz	

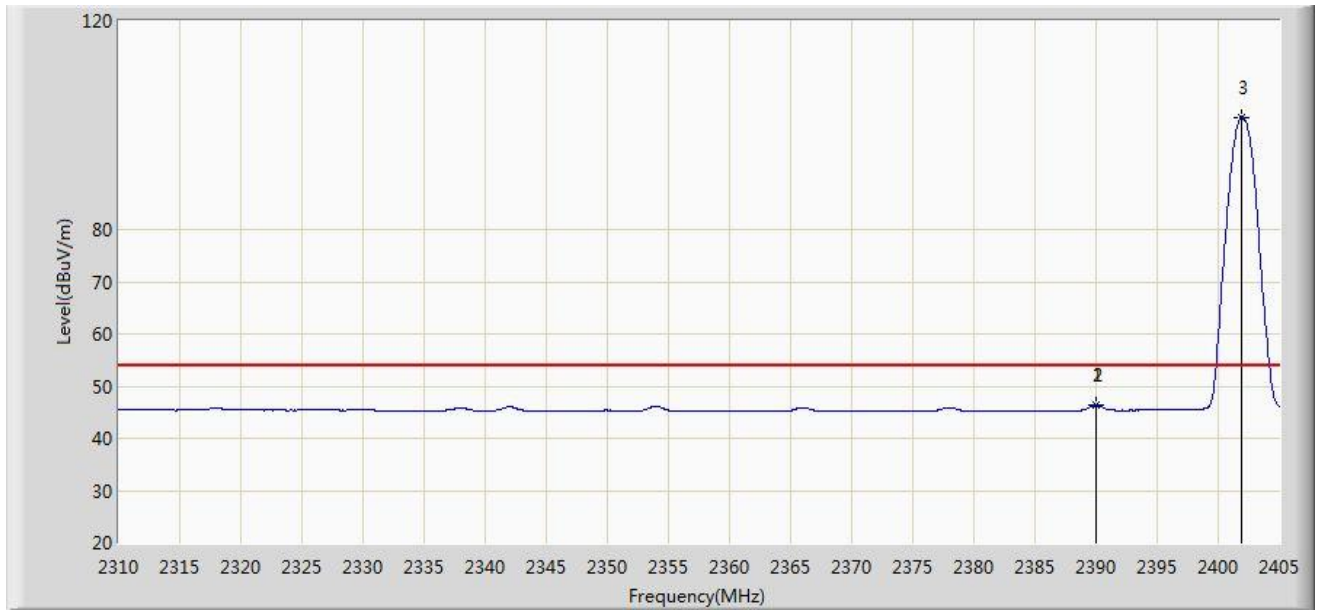

No	Mark	Frequency (MHz)	Measure Level (dBuV/m)	Reading Level (dBuV)	Over Limit (dB)	Limit (dBuV/m)	Factor (dB)	Type
1		2389.942	46.328	13.810	-7.672	54.000	32.518	AV
2		2390.000	46.322	13.804	-7.678	54.000	32.518	AV
3	*	2401.913	101.571	69.003	N/A	N/A	32.568	AV

Note: Measure Level (dB $\mu$ V/m) = Reading Level (dB $\mu$ V) + Factor (dB)

Factor (dB) = Cable Loss (dB) + Antenna Factor (dB/m)

Site: AC1	Time: 2019/06/26 - 13:28
Limit: FCC_Part15.209_RSE(3m)	Engineer: Kevin Ker
Probe: BBHA 9120D_1-18GHz	Polarity: Vertical
EUT: REMOTE CONTROLLER	Power: By Battery
Note: Transmit by BLE at channel 2402MHz	

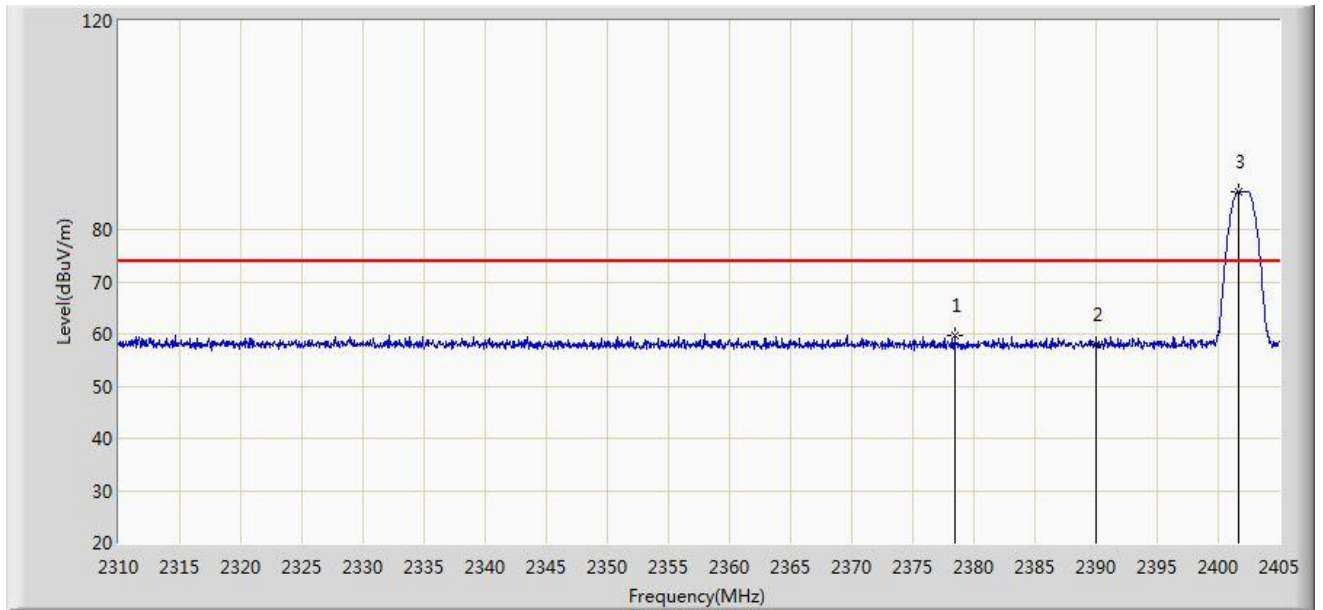

No	Mark	Frequency (MHz)	Measure Level (dBuV/m)	Reading Level (dBuV)	Over Limit (dB)	Limit (dBuV/m)	Factor (dB)	Type
1		2378.400	59.620	27.151	-14.380	74.000	32.469	PK
2		2390.000	57.962	25.444	-16.038	74.000	32.518	PK
3	*	2401.722	87.311	54.744	N/A	N/A	32.567	PK

Note: Measure Level (dB $\mu$ V/m) = Reading Level (dB $\mu$ V) + Factor (dB)

Factor (dB) = Cable Loss (dB) + Antenna Factor (dB/m)

Site: AC1	Time: 2019/06/26 - 13:32
Limit: FCC_Part15.209_RSE(3m)	Engineer: Kevin Ker
Probe: BBHA 9120D_1-18GHz	Polarity: Vertical
EUT: REMOTE CONTROLLER	Power: By Battery
Note: Transmit by BLE at channel 2402MHz	

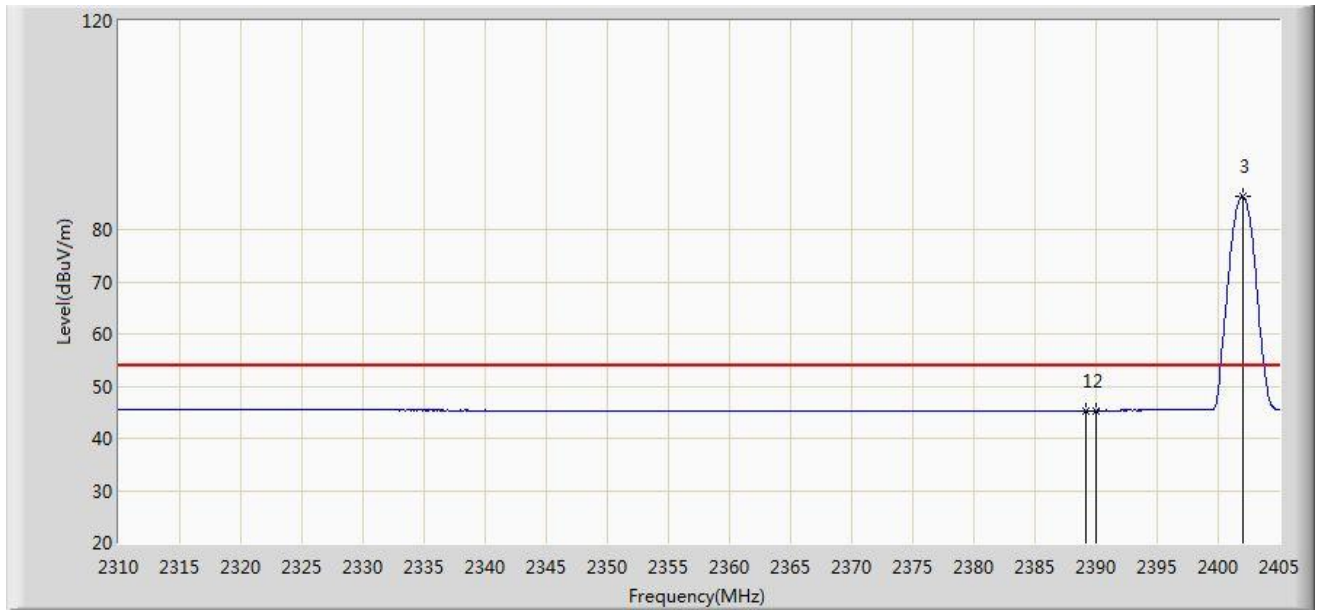

No	Mark	Frequency (MHz)	Measure Level (dBuV/m)	Reading Level (dBuV)	Over Limit (dB)	Limit (dBuV/m)	Factor (dB)	Type
1		2389.135	45.356	12.842	-8.644	54.000	32.514	AV
2		2390.000	45.348	12.830	-8.652	54.000	32.518	AV
3	*	2402.008	86.237	53.669	N/A	N/A	32.568	AV

Note: Measure Level (dBuV/m) = Reading Level (dBuV) + Factor (dB)

Factor (dB) = Cable Loss (dB) + Antenna Factor (dB/m)

Site: AC1	Time: 2019/06/26 - 13:38
Limit: FCC_Part15.209_RSE(3m)	Engineer: Kevin Ker
Probe: BBHA 9120D_1-18GHz	Polarity: Horizontal
EUT: REMOTE CONTROLLER	Power: By Battery
Note: Transmit by BLE at channel 2480MHz	

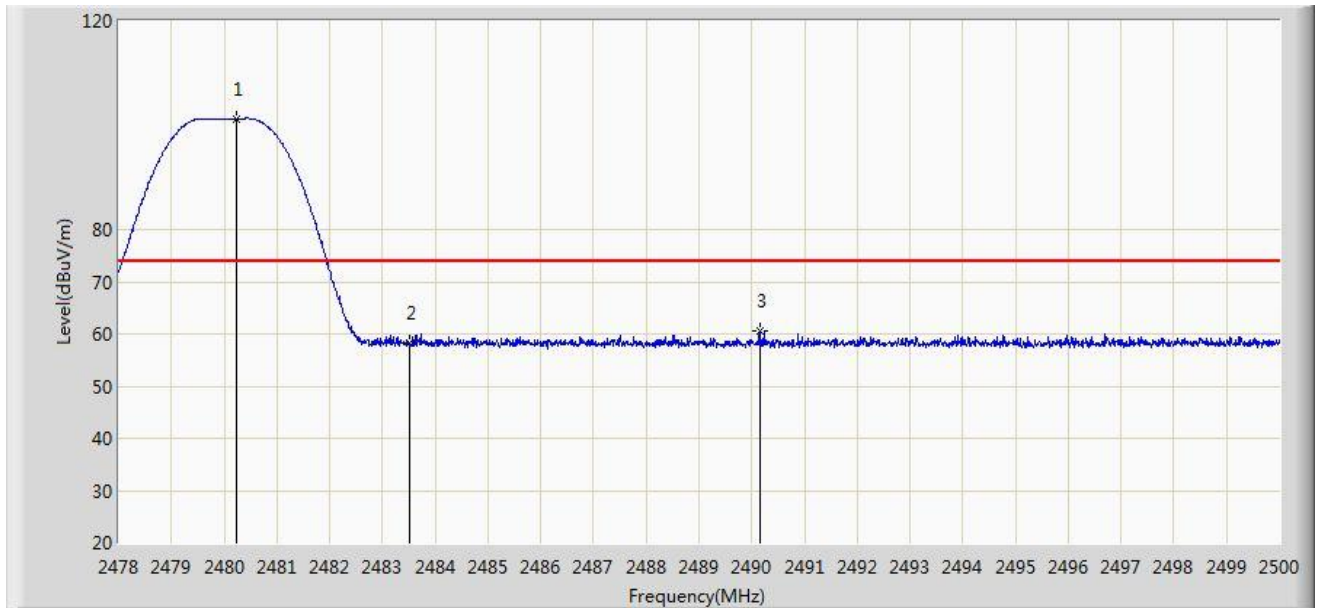

No	Mark	Frequency (MHz)	Measure Level (dBuV/m)	Reading Level (dBuV)	Over Limit (dB)	Limit (dBuV/m)	Factor (dB)	Type
1	*	2480.244	101.292	68.395	N/A	N/A	32.897	PK
2		2483.500	58.168	25.257	-15.832	74.000	32.911	PK
3		2490.155	60.584	27.645	-13.416	74.000	32.938	PK

Note: Measure Level (dB $\mu$ V/m) = Reading Level (dB $\mu$ V) + Factor (dB)

Factor (dB) = Cable Loss (dB) + Antenna Factor (dB/m)

Site: AC1	Time: 2019/06/26 - 13:41
Limit: FCC_Part15.209_RSE(3m)	Engineer: Kevin Ker
Probe: BBHA 9120D_1-18GHz	Polarity: Horizontal
EUT: REMOTE CONTROLLER	Power: By Battery
Note: Transmit by BLE at channel 2480MHz	

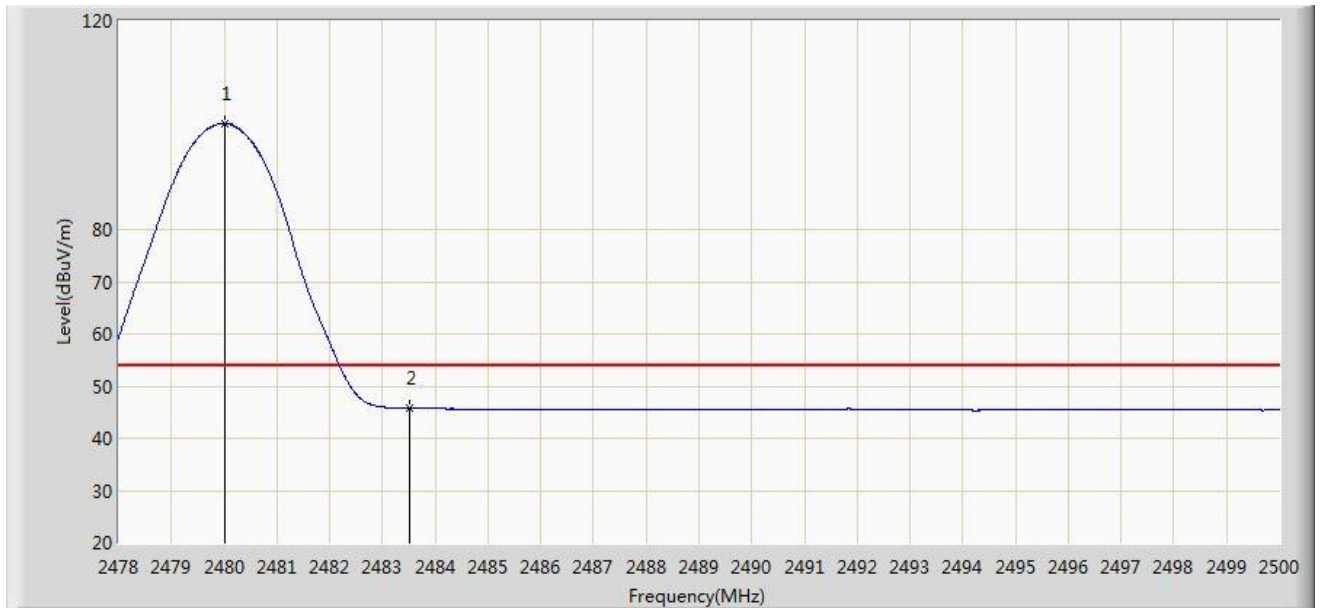

No	Mark	Frequency (MHz)	Measure Level (dBuV/m)	Reading Level (dBuV)	Over Limit (dB)	Limit (dBuV/m)	Factor (dB)	Type
1	*	2480.002	100.310	67.414	N/A	N/A	32.896	AV
2		2483.500	45.740	12.829	-8.260	54.000	32.911	AV

Note: Measure Level (dB $\mu$ V/m) = Reading Level (dB $\mu$ V) + Factor (dB)

Factor (dB) = Cable Loss (dB) + Antenna Factor (dB/m)



Site: AC1	Time: 2019/06/26 - 13:43
Limit: FCC_Part15.209_RSE(3m)	Engineer: Kevin Ker
Probe: BBHA 9120D_1-18GHz	Polarity: Vertical
EUT: REMOTE CONTROLLER	Power: By Battery
Note: Transmit by BLE at channel 2480MHz	

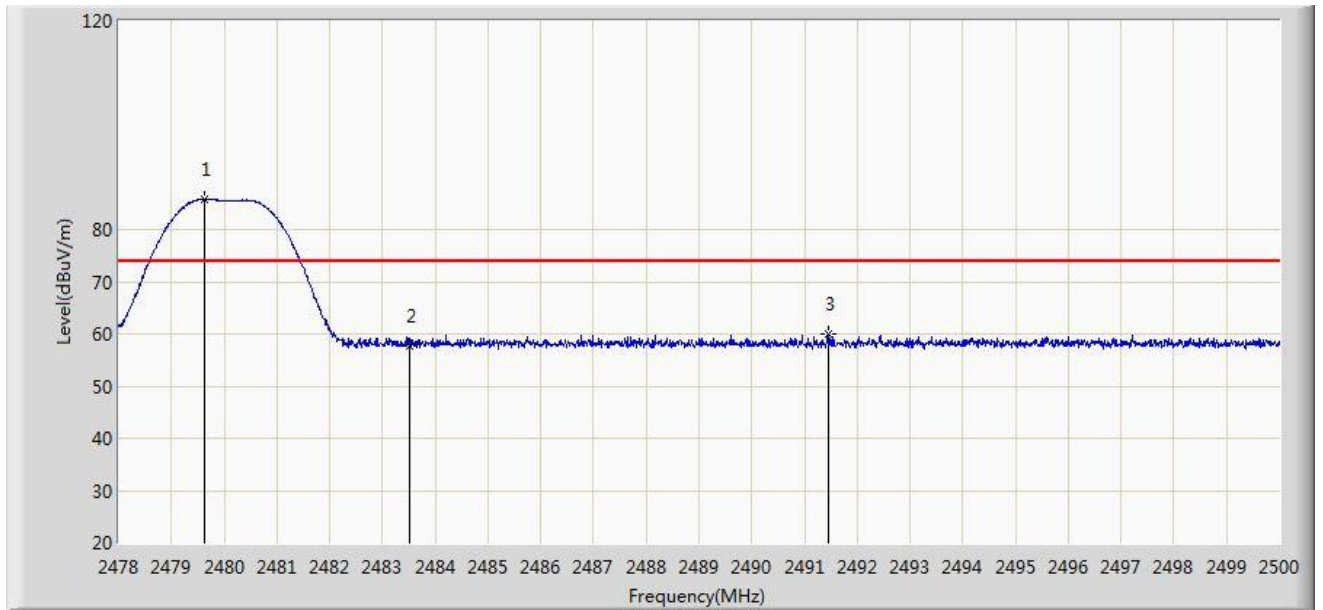

No	Mark	Frequency (MHz)	Measure Level (dBuV/m)	Reading Level (dBuV)	Over Limit (dB)	Limit (dBuV/m)	Factor (dB)	Type
1	*	2479.628	85.789	52.894	N/A	N/A	32.895	PK
2		2483.500	57.772	24.861	-16.228	74.000	32.911	PK
3		2491.453	60.007	27.063	-13.993	74.000	32.944	PK

Note: Measure Level (dB $\mu$ V/m) = Reading Level (dB $\mu$ V) + Factor (dB)

Factor (dB) = Cable Loss (dB) + Antenna Factor (dB/m)

Site: AC1	Time: 2019/06/26 - 13:44
Limit: FCC_Part15.209_RSE(3m)	Engineer: Kevin Ker
Probe: BBHA 9120D_1-18GHz	Polarity: Vertical
EUT: REMOTE CONTROLLER	Power: By Battery
Note: Transmit by BLE at channel 2480MHz	

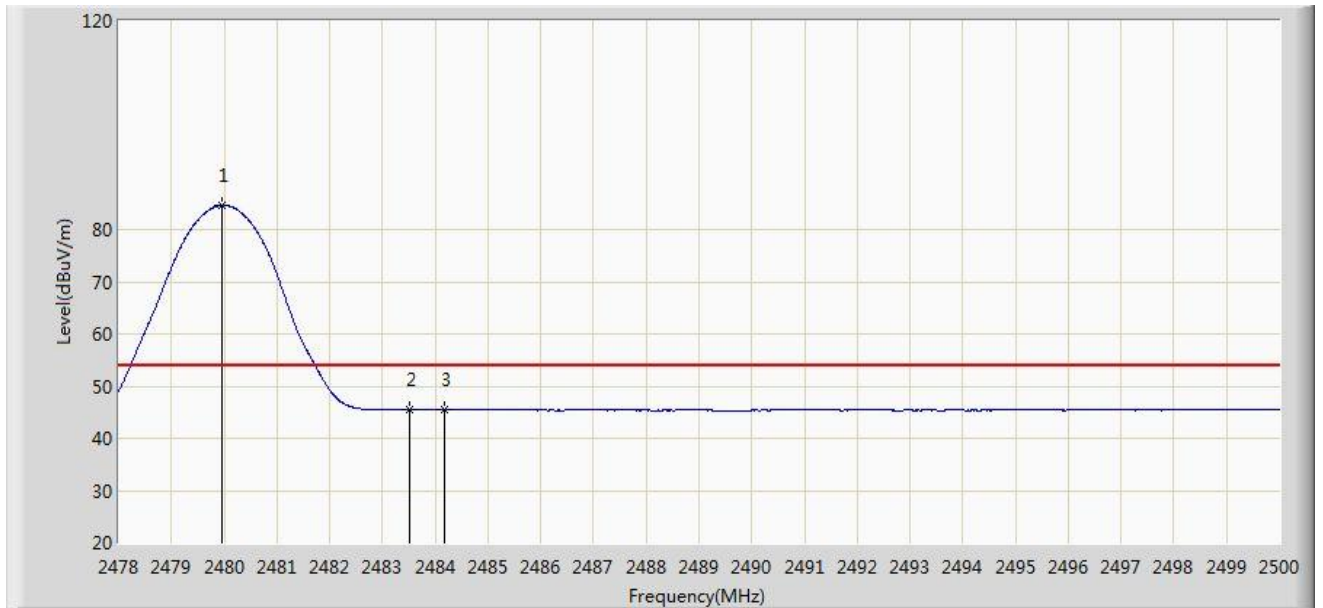

No	Mark	Frequency (MHz)	Measure Level (dBuV/m)	Reading Level (dBuV)	Over Limit (dB)	Limit (dBuV/m)	Factor (dB)	Type
1	*	2479.969	84.597	51.701	N/A	N/A	32.896	AV
2		2483.500	45.411	12.500	-8.589	54.000	32.911	AV
3		2484.171	45.433	12.519	-8.567	54.000	32.914	AV

Note: Measure Level (dB $\mu$ V/m) = Reading Level (dB $\mu$ V) + Factor (dB)

Factor (dB) = Cable Loss (dB) + Antenna Factor (dB/m)

## 7.8. AC Conducted Emissions Measurement

### 7.8.1. Test Limit

FCC Part 15 Subpart C Paragraph 15.207 Limits		
Frequency (MHz)	QP (dBuV)	AV (dBuV)
0.15 - 0.50	66 - 56	56 - 46
0.50 - 5.0	56	46
5.0 - 30	60	50

Note 1: The lower limit shall apply at the transition frequencies.

Note 2: The limit decreases linearly with the logarithm of the frequency in the range 0.15MHz to 0.5MHz.

### 7.8.2. Test Setup

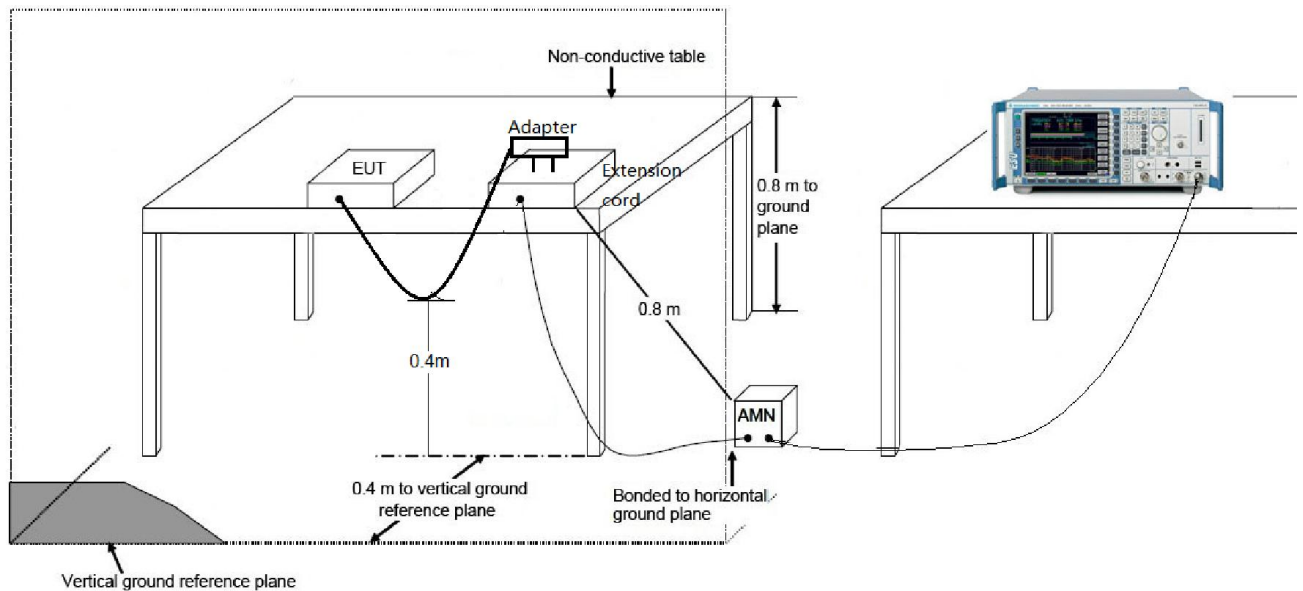

### 7.8.3. Test Result

EUT is powered by battery (AAA\*2), so this item is not applied.

## 8. CONCLUSION

The data collected relate only the item(s) tested and show that the **REMOTE CONTROLLER** is in compliance with Part 15C of the FCC Rules.

————— The End —————

## **Appendix A - Test Setup Photograph**

Refer to "1907TW0103-UT" file.

## **Appendix B - EUT Photograph**

Refer to “ 1907TW0103-UE” file.