

FCC Test Report

FCC ID : BKMAE-STI6200
Equipment : WLAN/BT Module
Brand Name : EPSON
Model Name : STI6200-D101
Applicant : SEIKO EPSON CORPORATION
3-3-5 Owa Suwa-shi Nagano-ken
392-8502 Japan
Manufacturer : SEIKO EPSON CORPORATION
6925 Tazawa, Toyoshina Azumino-shi,
Nagano 399-8285 Japan
Standard : 47 CFR FCC Part 15.247

The product was received on Jun. 30, 2020, and testing was started from Jul. 06, 2020 and completed on Jul. 15, 2020. We, SPORTON INTERNATIONAL INC. EMC & Wireless Communications Laboratory, would like to declare that the tested sample has been evaluated in accordance with the procedures given in ANSI C63.10-2013 and shown compliance with the applicable technical standards.

The report must not be used by the client to claim product certification, approval, or endorsement by TAF or any agency of government.

The test results in this report apply exclusively to the tested model / sample. Without written approval of SPORTON INTERNATIONAL INC. EMC & Wireless Communications Laboratory, the test report shall not be reproduced except in full.



Approved by: Allen Lin

SPORTON INTERNATIONAL INC. EMC & Wireless Communications Laboratory

No. 52, Huaya 1st Rd., Guishan Dist., Taoyuan City, Taiwan (R.O.C.)



Table of Contents

HISTORY OF THIS TEST REPORT3

SUMMARY OF TEST RESULT4

1 GENERAL DESCRIPTION5

1.1 Information.....5

1.2 Testing Applied Standards7

1.3 Testing Location Information7

1.4 Measurement Uncertainty7

2 TEST CONFIGURATION OF EUT.....8

2.1 Test Condition8

2.2 Test Channel Mode8

2.3 The Worst Case Measurement Configuration.....9

2.4 Accessories10

2.5 Support Equipment.....10

2.6 Test Setup Diagram11

3 TRANSMITTER TEST RESULT13

3.1 AC Power-line Conducted Emissions13

3.2 DTS Bandwidth.....15

3.3 Maximum Conducted Output Power16

3.4 Power Spectral Density18

3.5 Emissions in Non-restricted Frequency Bands19

3.6 Emissions in Restricted Frequency Bands.....20

4 TEST EQUIPMENT AND CALIBRATION DATA.....24

APPENDIX A. TEST RESULTS OF AC POWER-LINE CONDUCTED EMISSIONS

APPENDIX B. TEST RESULTS OF DTS BANDWIDTH

APPENDIX C. TEST RESULTS OF MAXIMUM CONDUCTED OUTPUT POWER

APPENDIX D. TEST RESULTS OF POWER SPECTRAL DENSITY

APPENDIX E. TEST RESULTS OF EMISSIONS IN NON-RESTRICTED FREQUENCY BANDS

APPENDIX F. TEST RESULTS OF EMISSIONS IN RESTRICTED FREQUENCY BANDS

APPENDIX G. TEST PHOTOS

PHOTOGRAPHS OF EUT V01



Summary of Test Result

Report Clause	Ref.Std. Clause	Test Items	Result (PASS/FAIL)	Remark
1.1.2	15.203	Antenna Requirement	PASS	-
3.1	15.207	AC Power-line Conducted Emissions	PASS	-
3.2	15.247(a)	DTS Bandwidth	PASS	-
3.3	15.247(b)	Maximum Conducted Output Power	PASS	-
3.4	15.247(e)	Power Spectral Density	PASS	-
3.5	15.247(d)	Emissions in Non-restricted Frequency Bands	PASS	-
3.6	15.247(d)	Emissions in Restricted Frequency Bands	PASS	-

Declaration of Conformity:
The test results with all measurement uncertainty excluded are presented in accordance with the regulation limits or requirements declared by manufacturers.
Comments and explanations:
None

Reviewed by: Sam Tsai

Report Producer: Ann Hou

1 General Description

1.1 Information

1.1.1 RF General Information

Frequency Range (MHz)	Bluetooth Mode	Ch. Frequency (MHz)	Channel Number
2400-2483.5	LE	2402-2480	0-39 [40]

Band	Mode	BWch (MHz)	Nant
2.4-2.4835GHz	BT-LE(1Mbps)	1.0	1TX
2.4-2.4835GHz	BT-LE(2Mbps)	2.0	1TX

Note:

- ♦ Bluetooth LE uses a GFSK (1Mbps/2Mbps) modulation.
- ♦ BWch is the nominal channel bandwidth.

1.1.2 Antenna Information

Ant.	Brand	Model Name	Antenna Type	Connector
1	HONGBO	290-40488	PIFA	I-PEX
2	HONGBO	290-40488	PIFA	I-PEX

Ant.	Port	Gain (dBi)		
		2.4G	5G	BT
1	2	2.34	3.58	-
2	1	2.74	3.39	2.74

Note 1: The EUT has two antennas.

For 2.4GHz function:

For IEEE 802.11 b mode (1TX/2RX)

Only Ant. 2 (port 1) could transmit.

Ant. 1 (port 2) and Ant. 2 (port 1) could receive simultaneously.

For IEEE 802.11 g/n mode (2TX/2RX)

Ant. 1 (port 2) and Ant. 2 (port 1) could transmit/receive simultaneously.

For BT function:

For IEEE 802.15.1 Bluetooth mode (1TX/1RX)

Ant. 2 (port 1) could transmit/receive.

For 5GHz function:

For IEEE 802.11 a/n/ac mode (2TX/2RX)

Ant. 1 (port 2) and Ant. 2 (port 1) could transmit/receive simultaneously.



1.1.3 EUT Information

Operational Condition	
EUT Power Type	From AC Adapter
EUT Function	<input checked="" type="checkbox"/> Point-to-multipoint <input type="checkbox"/> Point-to-point
Type of EUT	
<input checked="" type="checkbox"/> Stand-alone	
<input type="checkbox"/> Combined (EUT where the radio part is fully integrated within another device)	
	Combined Equipment - Brand Name / Model No.: ...
<input type="checkbox"/> Plug-in radio (EUT intended for a variety of host systems)	
	Host System - Brand Name / Model No.: ...
<input type="checkbox"/> Other:	

1.1.4 Mode Test Duty Cycle

Mode	DC	DCF(dB)	T(s)	VBW(Hz) ≥ 1/T
BT-LE(1Mbps)	0.629	2.01	393.75u	3k
BT-LE(2Mbps)	0.362	4.41	228.125u	10k

Note. If DC < 0.98, the DCF was added while measuring Output power and PSD.

1.2 Testing Applied Standards

According to the specifications of the manufacturer, the EUT must comply with the requirements of the following standards:

- ◆ 47 CFR FCC Part 15
- ◆ ANSI C63.10-2013

The following reference test guidance is not within the scope of accreditation of TAF:

- ◆ KDB 558074 D01 v05r02
- ◆ KDB 414788 D01 v01r01

1.3 Testing Location Information

Testing Location				
<input checked="" type="checkbox"/>	HWA YA	ADD : No. 52, Huaya 1st Rd., Guishan Dist., Taoyuan City, Taiwan (R.O.C.)		
		TEL : 886-3-327-3456	FAX : 886-3-327-0973	
Test site Designation No. TW1190 with FCC.				
<input type="checkbox"/>	JHUBEI	ADD : No.8, Ln. 724, Bo'ai St., Zhubei City, Hsinchu County, Taiwan (R.O.C.)		
		TEL : 886-3-656-9065	FAX : 886-3-656-9085	
Test site Designation No. TW0006 with FCC.				
<input type="checkbox"/>	Wen Shan	ADD : No.14-1, Ln. 19, Wen 33rd St., Guishan Dist., Taoyuan City 333, Taiwan (R.O.C.)		
		TEL : 886-3-318-0787	FAX : 886-3-318-0287	
Test site Designation No. TW1097 with FCC.				

Test Condition	Test Site No.	Test Engineer	Test Environment	Test Date
AC Conduction	CO04-HY	Edward	23.5~24.1°C / 53~58%	15/Jul/2020
RF Conducted	TH06-HY	Raven	22.4~23.3°C / 54~60%	08/Jul/2020
Radiated	03CH02-HY	Daniel	21.2~27.3°C / 54~61%	06/Jul/2020~ 08/Jul/2020

1.4 Measurement Uncertainty

ISO/IEC 17025 requires that an estimate of the measurement uncertainties associated with the emissions test results be included in the report. The measurement uncertainties given below are based on a 95% confidence level (based on a coverage factor (k=2))

Test Items	Uncertainty	Remark
Conducted Emission (150kHz ~ 30MHz)	0.9 dB	Confidence levels of 95%
Radiated Emission (9kHz ~ 30MHz)	2.4 dB	Confidence levels of 95%
Radiated Emission (30MHz ~ 1,000MHz)	3.7 dB	Confidence levels of 95%
Radiated Emission (1GHz ~ 18GHz)	3.6 dB	Confidence levels of 95%
Radiated Emission (18GHz ~ 40GHz)	3.5 dB	Confidence levels of 95%
Conducted Emission	1.0 dB	Confidence levels of 95%
Temperature	0.41 °C	Confidence levels of 95%
Humidity	3.4 %	Confidence levels of 95%

2 Test Configuration of EUT

2.1 Test Condition

RF Conducted	Abbreviation	Remark
TnomVnom	Tnom	20°C
-	Vnom	120V

2.2 Test Channel Mode

Test Software	RFTesTool

Mode	Power Setting
BT-LE(1Mbps)	-
2402MHz	Default
2440MHz	Default
2480MHz	Default
BT-LE(2Mbps)	-
2402MHz	Default
2440MHz	Default
2480MHz	Default

2.3 The Worst Case Measurement Configuration

The Worst Case Mode for Following Conformance Tests	
Tests Item	AC power-line conducted emissions
Condition	AC power-line conducted measurement for line and neutral
Operating Mode	CTX
1	Adapter mode

The Worst Case Mode for Following Conformance Tests	
Tests Item	DTS Bandwidth Maximum Conducted Output Power Power Spectral Density Emissions in Non-restricted Frequency Bands
Test Condition	Conducted measurement at transmit chains

The Worst Case Mode for Following Conformance Tests	
Tests Item	Emissions in Restricted Frequency Bands
Test Condition	Radiated measurement If EUT consist of multiple antenna assembly (multiple antenna are used in EUT regardless of spatial multiplexing MIMO configuration), the radiated test should be performed with highest antenna gain of each antenna type.
Operating Mode < 1GHz	CTX
1	Adapter mode
Operating Mode > 1GHz	CTX
Orthogonal Planes of EUT	Z Plane
	

The Worst Case Mode for Following Conformance Tests	
Tests Item	Simultaneous Transmission Analysis
Operating Mode	CTX
1	2.4GHz WLAN + Bluetooth
2	5GHz WLAN + Bluetooth

Refer to Sporton Test Report No.: FA070125 for Co-location RF Exposure Evaluation.

2.4 Accessories

Accessories				
DB1 Antenna	Brand Name	HONGBO	Model Name	290-40488
DB2 Antenna	Brand Name	HONGBO	Model Name	290-40488

Reminder: Regarding to more detail and other information, please refer to user manual.

2.5 Support Equipment

Support Equipment – AC Conduction					
No.	Equipment	Brand Name	Model Name	FCC ID	Remark
1	Adapter	APD	WB-18D12FU	-	Customer Provide
2	Fixture	Askey	STI6200-D101-Ro HS-EVB REV 1	-	Customer Provide

Support Equipment – Conducted					
No.	Equipment	Brand Name	Model Name	FCC ID	Remark
1	Notebook	DELL	E5410	-	-
2	Adapter for Notebook	DELL	HA65NM130	-	-
3	Fixture	Askey	STI6200-D101-Ro HS-EVB REV 1	-	Customer Provide
4	Adapter	APD	WB-18D12FU	-	Customer Provide

Support Equipment – Radiated					
No.	Equipment	Brand Name	Model Name	FCC ID	Remark
1	Adapter	APD	WB-18D12FU	-	Customer Provide
2	Fixture	Askey	STI6200-D101-Ro HS-EVB REV 1	-	Customer Provide

2.6 Test Setup Diagram

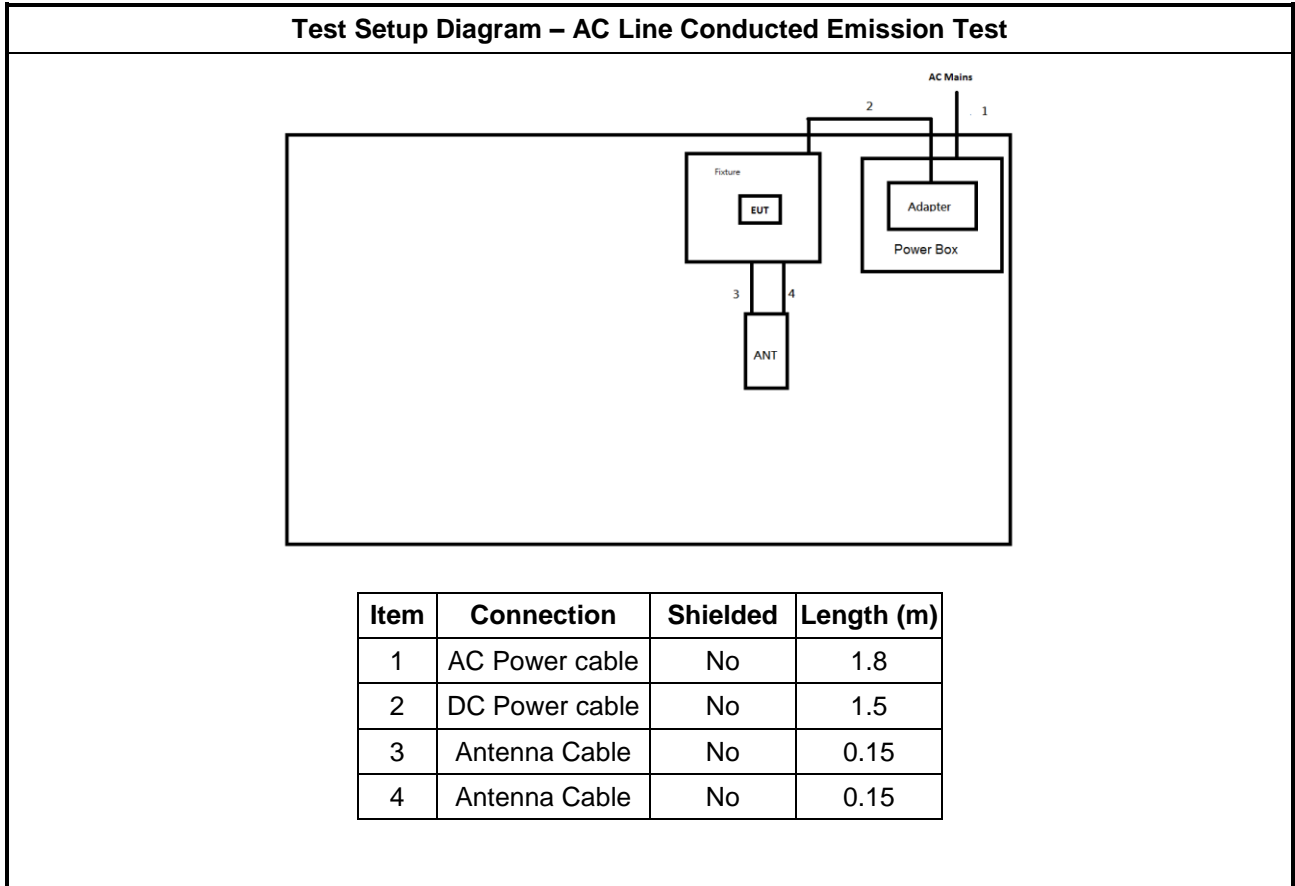

Test Setup Diagram - Radiated Test

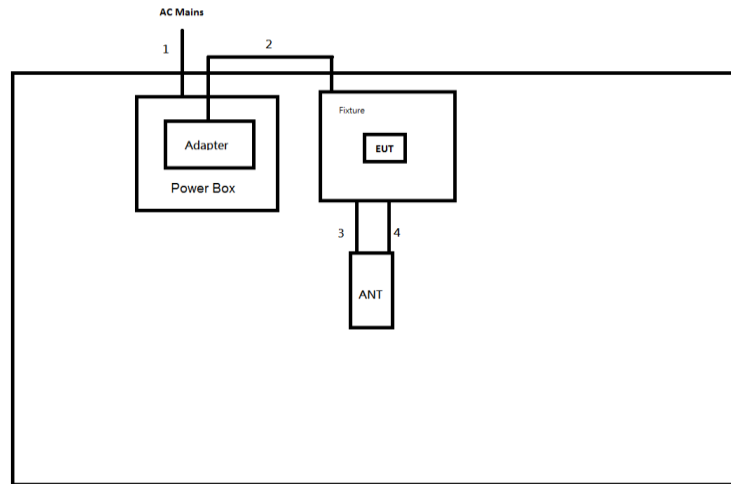

Item	Connection	Shielded	Length (m)
1	AC Power cable	No	1.8
2	DC Power cable	No	1.5
3	Antenna Cable	No	0.15
4	Antenna Cable	No	0.15

3 Transmitter Test Result

3.1 AC Power-line Conducted Emissions

3.1.1 AC Power-line Conducted Emissions Limit

AC Power-line Conducted Emissions Limit		
Frequency Emission (MHz)	Quasi-Peak	Average
0.15-0.5	66 - 56 *	56 - 46 *
0.5-5	56	46
5-30	60	50

Note 1: * Decreases with the logarithm of the frequency.

3.1.2 Measuring Instruments

Refer a test equipment and calibration data table in this test report.

3.1.3 Test Procedures

Test Method
<ul style="list-style-type: none"> Refer as ANSI C63.10-2013, clause 6.2 foray power-line conducted emissions.

3.2 DTS Bandwidth

3.2.1 6dB Bandwidth Limit

6dB Bandwidth Limit
Systems using digital modulation techniques:
<ul style="list-style-type: none"> ▪ 6 dB bandwidth \geq 500 kHz.

3.2.2 Measuring Instruments

Refer a test equipment and calibration data table in this test report.

3.2.3 Test Procedures

Test Method
<ul style="list-style-type: none"> ▪ For the emission bandwidth shall be measured using one of the options below:
<input checked="" type="checkbox"/> Refer as KDB 558074, clause 8.2 (11.8 of ANSI C63.10) DTS bandwidth measurement.
<input type="checkbox"/> Refer as RSS-Gen, clause 6.7 for for occupied bandwidth testing.
<input type="checkbox"/> Refer as ANSI C63.10, clause 6.9.3 for occupied bandwidth testing.

3.2.4 Test Setup

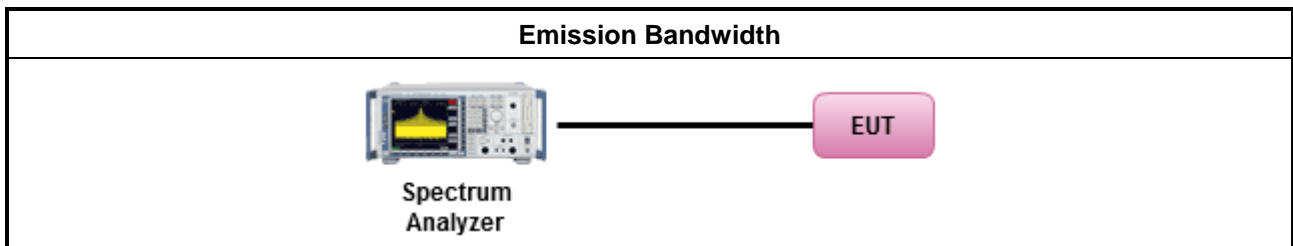

3.2.5 Test Result of Emission Bandwidth

Refer as Appendix B

3.3 Maximum Conducted Output Power

3.3.1 Maximum Conducted Output Power Limit

Maximum Conducted Output Power Limit	
	<ul style="list-style-type: none"> ▪ If $G_{TX} \leq 6$ dBi, then $P_{Out} \leq 30$ dBm (1 W)
	<ul style="list-style-type: none"> ▪ Point-to-multipoint systems (P2M): If $G_{TX} > 6$ dBi, then $P_{Out} = 30 - (G_{TX} - 6)$ dBm
	<ul style="list-style-type: none"> ▪ Point-to-point systems (P2P): If $G_{TX} > 6$ dBi, then $P_{Out} = 30 - (G_{TX} - 6)/3$ dBm
	<ul style="list-style-type: none"> ▪ Smart antenna system (SAS):
	<ul style="list-style-type: none"> - Single beam: If $G_{TX} > 6$ dBi, then $P_{Out} = 30 - (G_{TX} - 6)/3$ dBm
	<ul style="list-style-type: none"> - Overlap beam: If $G_{TX} > 6$ dBi, then $P_{Out} = 30 - (G_{TX} - 6)/3$ dBm
	<ul style="list-style-type: none"> - Aggregate power on all beams: If $G_{TX} > 6$ dBi, then $P_{Out} = 30 - (G_{TX} - 6)/3 + 8$ dB dBm
e.i.r.p. Power Limit:	
	<ul style="list-style-type: none"> ▪ 2400-2483.5 MHz Band
	<ul style="list-style-type: none"> ▪ Point-to-multipoint systems (P2M): $P_{eirp} \leq 36$ dBm (4 W)
	<ul style="list-style-type: none"> ▪ Point-to-point systems (P2P): $P_{eirp} \leq \text{MAX}(36, [P_{Out} + G_{TX}])$ dBm
	<ul style="list-style-type: none"> ▪ Smart antenna system (SAS)
	<ul style="list-style-type: none"> - Single beam: $P_{eirp} \leq \text{MAX}(36, P_{Out} + G_{TX})$ dBm
	<ul style="list-style-type: none"> - Overlap beam: $P_{eirp} \leq \text{MAX}(36, P_{Out} + G_{TX})$ dBm
	<ul style="list-style-type: none"> - Aggregate power on all beams: $P_{eirp} \leq \text{MAX}(36, [P_{Out} + G_{TX} + 8])$ dBm
P_{Out} = maximum peak conducted output power or maximum conducted output power in dBm, G_{TX} = the maximum transmitting antenna directional gain in dBi.	

3.3.2 Measuring Instruments

Refer a test equipment and calibration data table in this test report.

3.3.3 Test Procedures

Test Method	
<ul style="list-style-type: none"> ▪ Maximum Peak Conducted Output Power 	
<input type="checkbox"/>	Refer as KDB 558074, clause 8.3.1.1 (11.9.1.1 of ANSI C63.10) RBW ≥ EBW method.
<input type="checkbox"/>	Refer as KDB 558074, clause 8.3.1.2 (11.9.1.2 of ANSI C63.10) integrated band power method.
<input type="checkbox"/>	Refer as KDB 558074, clause 8.3.1.3 (11.9.1.3 of ANSI C63.10) peak power meter.
<ul style="list-style-type: none"> ▪ Maximum Average Conducted Output Power 	
<input type="checkbox"/>	Refer as KDB 558074, clause 8.3.2.2 (11.9.2.2 of ANSI C63.10) using a spectrum analyzer.
<input checked="" type="checkbox"/>	Refer as KDB 558074, clause 8.3.2.3 (11.9.2.3 of ANSI C63.10) using a power meter.
<ul style="list-style-type: none"> ▪ For conducted measurement. 	
<ul style="list-style-type: none"> ▪ If the EUT supports multiple transmit chains using options given below: Refer as KDB 662911, In-band power measurements. Using the measure-and-sum approach, measured all transmit ports individually. Sum the power (in linear power units e.g., mW) of all ports for each individual sample and save them. 	
<ul style="list-style-type: none"> ▪ If multiple transmit chains, EIRP calculation could be following as methods: $P_{total} = P_1 + P_2 + \dots + P_n$ (calculated in linear unit [mW] and transfer to log unit [dBm]) $EIRP_{total} = P_{total} + DG$ 	

3.3.4 Test Setup

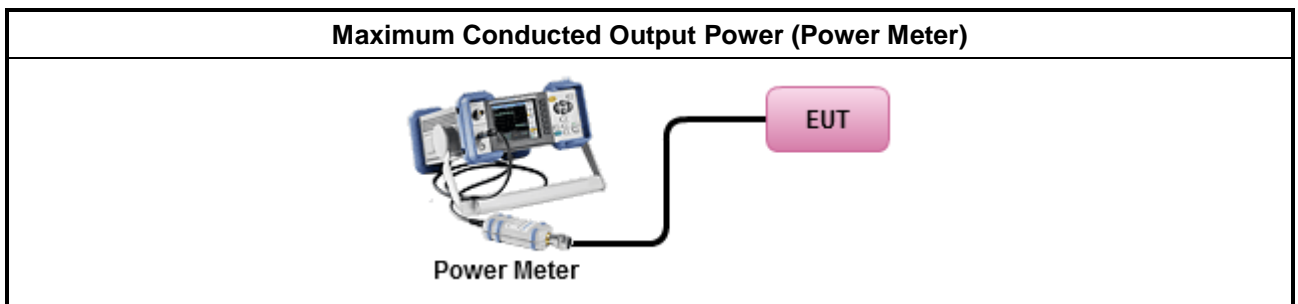

3.3.5 Test Result of Maximum Conducted Output Power

Refer as Appendix C

3.4 Power Spectral Density

3.4.1 Power Spectral Density Limit

Power Spectral Density Limit
<ul style="list-style-type: none"> ▪ Power Spectral Density (PSD) ≤ 8 dBm/3kHz

3.4.2 Measuring Instruments

Refer a test equipment and calibration data table in this test report.

3.4.3 Test Procedures

Test Method	
	<ul style="list-style-type: none"> ▪ Peak power spectral density procedures that the same method as used to determine the conducted output power. If maximum peak conducted output power was measured to demonstrate compliance to the output power limit, then the peak PSD procedure below (Method PKPSD) shall be used. If maximum conducted output power was measured to demonstrate compliance to the output power limit, then one of the average PSD procedures shall be used, as applicable based on the following criteria (the peak PSD procedure is also an acceptable option).
<input checked="" type="checkbox"/>	Refer as KDB 558074, clause 8.4 (11.10 of ANSI C63.10) Max. PSD.
	<ul style="list-style-type: none"> ▪ For conducted measurement.
	<ul style="list-style-type: none"> ▪ If The EUT supports multiple transmit chains using options given below:
	<ul style="list-style-type: none"> ▪ Measure and sum the spectra across the outputs. Refer as KDB 662911, In-band power spectral density (PSD). Sample all transmit ports simultaneously using a spectrum analyzer for each transmit port. Where the trace bin-by-bin of each transmit port summing can be performed. (i.e., in the first spectral bin of output 1 is summed with that in the first spectral bin of output 2 and that from the first spectral bin of output 3, and so on up to the NTX output to obtain the value for the first frequency bin of the summed spectrum.). Add up the amplitude (power) values for the different transmit chains and use this as the new data trace.

3.4.4 Test Setup

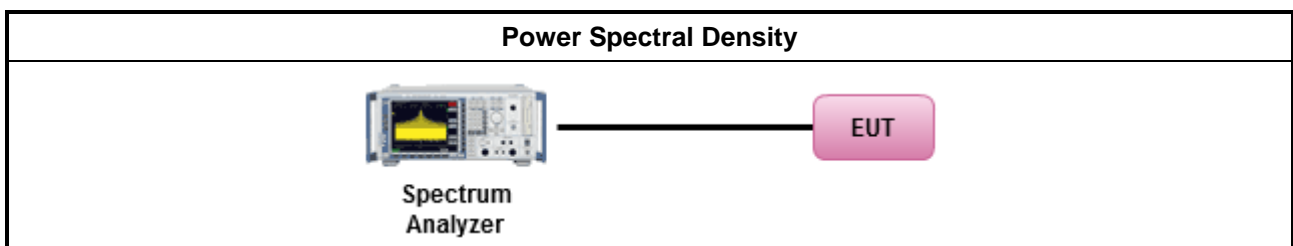

3.4.5 Test Result of Power Spectral Density

Refer as Appendix D

3.5 Emissions in Non-restricted Frequency Bands

3.5.1 Emissions in Non-restricted Frequency Bands Limit

Un-restricted Band Emissions Limit	
RF output power procedure	Limit (dB)
Peak output power procedure	20
Average output power procedure	30

Note 1: If the peak output power procedure is used to measure the fundamental emission power to demonstrate compliance to requirements, then the peak conducted output power measured within any 100 kHz outside the authorized frequency band shall be attenuated by at least 20 dB relative to the maximum measured in-band peak level.

Note 2: If the average output power procedure is used to measure the fundamental emission power to demonstrate compliance to requirements, then the power in any 100 kHz outside of the authorized frequency band shall be attenuated by at least 30 dB relative to the maximum measured in-band average level.

3.5.2 Measuring Instruments

Refer a test equipment and calibration data table in this test report.

3.5.3 Test Procedures

Test Method
<ul style="list-style-type: none"> Refer as KDB 558074, clause 8.5 (11.11 of ANSI C63.10) for non-restricted frequency bands.

3.5.4 Test Setup

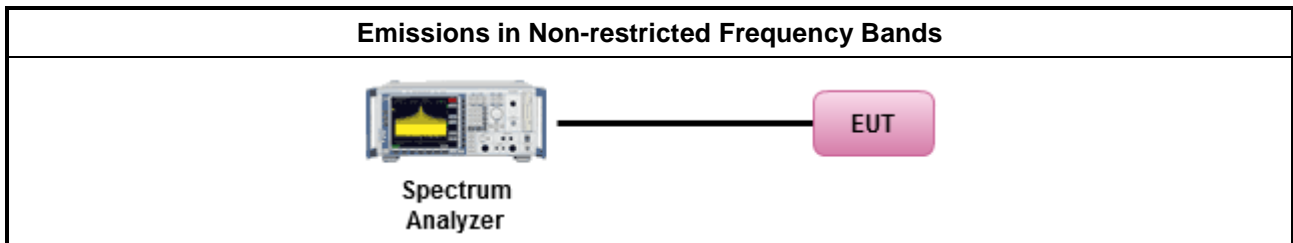

3.5.5 Test Result of Emissions in Non-restricted Frequency Bands

Refer as Appendix E

3.6 Emissions in Restricted Frequency Bands

3.6.1 Emissions in Restricted Frequency Bands Limit

Restricted Band Emissions Limit			
Frequency Range (MHz)	Field Strength (uV/m)	Field Strength (dBuV/m)	Measure Distance (m)
0.009~0.490	2400/F(kHz)	48.5 - 13.8	300
0.490~1.705	24000/F(kHz)	33.8 - 23	30
1.705~30.0	30	29	30
30~88	100	40	3
88~216	150	43.5	3
216~960	200	46	3
Above 960	500	54	3

Note 1: Test distance for frequencies at or above 30 MHz, measurements may be performed at a distance other than the limit distance provided they are not performed in the near field and the emissions to be measured can be detected by the measurement equipment. When performing measurements at a distance other than that specified, the results shall be extrapolated to the specified distance using an extrapolation factor of 20 dB/decade (inverse of linear distance for field-strength measurements, inverse of linear distance-squared for power-density measurements).

Note 2: Test distance for frequencies at below 30 MHz, measurements may be performed at a distance closer than the EUT limit distance; however, an attempt should be made to avoid making measurements in the near field. When performing measurements below 30 MHz at a closer distance than the limit distance, the results shall be extrapolated to the specified distance by either making measurements at a minimum of two or more distances on at least one radial to determine the proper extrapolation factor or by using the square of an inverse linear distance extrapolation factor (40 dB / decade). The test report shall specify the extrapolation method used to determine compliance of the EUT.

Note 3: Using the distance of 1m during the test for above 18 GHz, and the test value to correct for the distance factor at 3m.

3.6.2 Measuring Instruments

Refer a test equipment and calibration data table in this test report.

3.6.3 Test Procedures

Test Method	
	<ul style="list-style-type: none"> ▪ The average emission levels shall be measured in [duty cycle \geq 98 or duty factor].
	<ul style="list-style-type: none"> ▪ Refer as ANSI C63.10, clause 6.10.3 band-edge testing shall be performed at the lowest frequency channel and highest frequency channel within the allowed operating band.
	<ul style="list-style-type: none"> ▪ For the transmitter unwanted emissions shall be measured using following options below: <ul style="list-style-type: none"> ▪ Refer as KDB 558074, clause 8.6 (11.12 of ANSI C63.10) for restricted frequency bands.
	<ul style="list-style-type: none"> ▪ For the transmitter band-edge emissions shall be measured using following options below: <ul style="list-style-type: none"> ▪ Refer as KDB 558074 clause 8.7.1, When the performing peak or average radiated measurements, emissions within 2 MHz of the authorized band edge may be measured using the marker-delta method described below. ▪ Refer as KDB 558074, clause 8.7.2 (6.10.6 of ANSI C63.10) for marker-delta method for band-edge measurements. ▪ Refer as KDB 558074, clause 8.7.3 for narrower resolution bandwidth (100kHz) using the band power and summing the spectral levels.
	<ul style="list-style-type: none"> ▪ Use the following spectrum analyzer settings: <ul style="list-style-type: none"> ▪ Set RBW=100 kHz for $f < 1$ GHz; VBW=3 * RBW; Sweep = auto; Detector function = peak; Trace = max hold. ▪ Set RBW = 1 MHz, VBW= 3MHz for $f \geq 1$ GHz for peak measurement. For average measurement, refer as 1.1.4.
	<ul style="list-style-type: none"> ▪ KDB 414788 Open-Field Test Sites and Chamber Correlation Justification. <ul style="list-style-type: none"> ▪ Based on FCC 15.31 (f) (2): measurements may be performed at a distance closer than that specified in regulations; however, an attempt should be made to avoid making measurements in the near field. ▪ Open-field site and chamber correlation testing had been performed and chamber measured test result is the worst case test result.

3.6.4 Test Setup

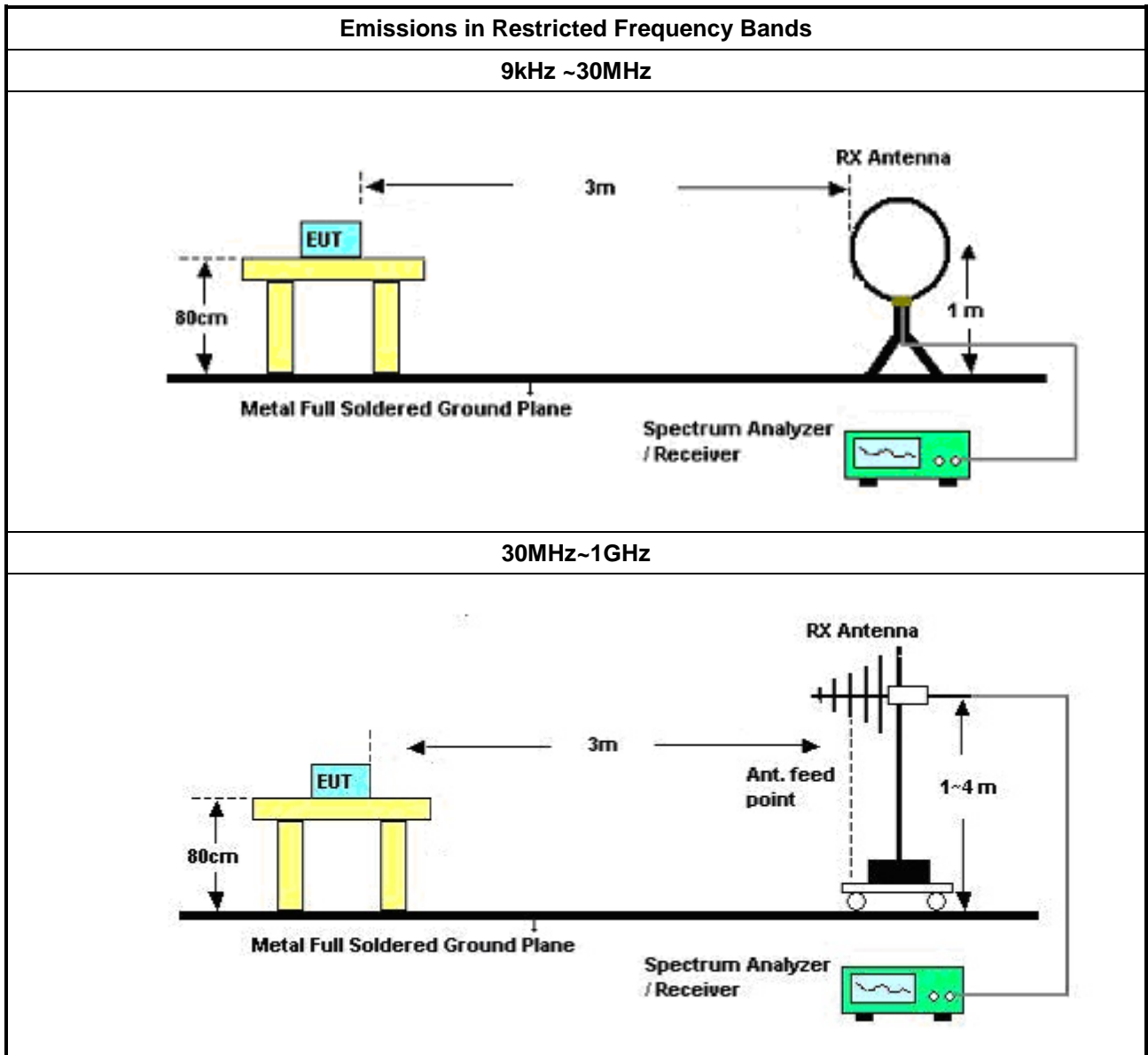

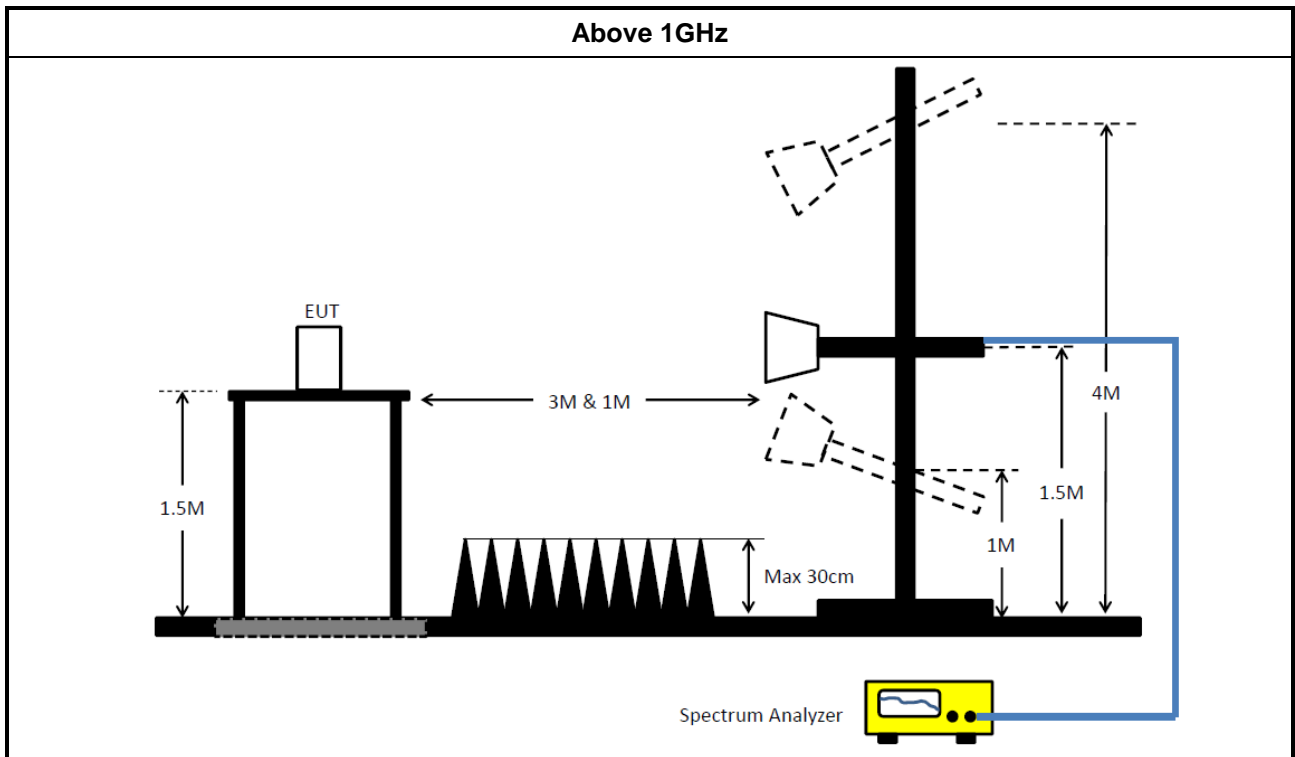

3.6.5 Test Result of Emissions in Restricted Frequency Bands (Below 30MHz)

The amplitude of spurious emissions which are attenuated by more than 20dB below the permissible value has no need to be reported.

3.6.6 Test Result of Emissions in Restricted Frequency Bands

Refer as Appendix F

4 Test Equipment and Calibration Data

Instrument for AC Conduction

Instrument	Manufacturer	Model No.	Serial No.	Spec.	Calibration Date	Calibration Due Date
EMI Test Receiver	R&S	ESR3	102051	9kHz ~ 3.6GHz	29/May/2020	28/May/2021
LISN	R&S	ENV216	101295	9kHz ~ 30MHz	05/Nov/2019	04/Nov/2020
LISN	SCHWARZBECK MESS-ELEKTRONIK	NSLK 8127	8127477	9kHz ~ 30MHz	17/Feb/2020	16/Feb/2021
RF Cable-CON	MTJ	RG142	CB002-CO	9kHz ~ 200MHz	23/Sep/2019	22/Sep/2020
Impuls Begrenzer Pulse Limiter	SCHWARZBECK	VTSD 9561-F	9561-F041	9kHz ~ 30MHz	24/Sep/2019	23/Sep/2020
Software	Sporton	SENSE-EMI	V5.10.7.3	-	NCR	NCR

NCR: Non-Calibration Require

Instrument for Conducted Test

Instrument	Manufacturer	Model No.	Serial No.	Spec.	Calibration Date	Calibration Due Date
Signal Analyzer	R&S	FSV 40	101029	10kHz ~ 40GHz	01/Oct/2019	30/Sep/2020
SMB100A Signal Generator	R&S	SMB100A03	181147	100kHz~40GHz	12/Nov/2018	11/Nov/2020
Pulse Sensor	Anritsu	MA2411B	1027452	300MHz~40GHz	18/Mar/2020	17/Mar/2021
Power Meter	Anritsu	ML2495A	1124009	300MHz~40GHz	18/Mar/2020	17/Mar/2021

Instrument for Radiated Test

Instrument	Manufacturer	Model No.	Serial No.	Spec.	Calibration Date	Calibration Due Date
3m Semi Anechoic Chamber	SIDT FRANKONIA	SAC-3M	03CH02-HY	30MHz~1GHz 3m	29/Aug/2019	28/Aug/2020
3m Semi Anechoic Chamber	SIDT FRANKONIA	SAC-3M	03CH02-HY	1GHz~18GHz 3m	29/Aug/2019	28/Aug/2020
Signal Analyzer	R&S	FSP40	100593	1GHz~26.5GHz	27/Feb/2020	26/Feb/2021
Amplifier	Agilent	8447D	2944A11149	100kHz~1.3GHz	30/Jun/2020	29/Jun/2021
Microwave Preamplifier	Agilent	8449B	3008A02373	1GHz~18GHz	16/Oct/2019	15/Oct/2020
Bilog Antenna & 5dB Attenuator	SCHAFFNER / MTJ	CBL 6112B / MTJ6102-05	2723 / 2	30MHz~1GHz	28/Feb/2020	27/Feb/2021
Double Ridged Guide Horn Antenna	SCHWARZBEC	BBHA 9120 D	BBHA 9120 D 01543	1GHz~18GHz	09/Jun/2020	08/Jun/2021
RF Cable-R03m	Jye Bao	RG142	CB017	30MHz~1GHz	25/Mar/2020	24/Mar/2021
RF Cable-R03m	HUBER+SUHNER	SUCOFLEX104	805193/4+80 5192/4	1GHz~40GHz	08/Apr/2020	07/Apr/2021
Broadband Horn Antenna	SCHWARZBECK	BBHA 9170	BBHA 9170221	18GHz~40GHz	13/Mar/2020	12/Mar/2021
Preamplifier	MITEQ	TTA1840-35-HG	1864481	18GHz~40GHz	10/Mar/2020	09/Mar/2021
Loop Antenna	TESEQ	HLA 6120	31244	9kHz~30MHz	16/Mar/2020	15/Mar/2021
EMI Test Receiver	R&S	ESR3	102051	9kHz~3.6GHz	29/May/2020	28/May/2021



Summary

Mode	Result	Type	Freq (Hz)	Level (dBuV)	Limit (dBuV)	Margin (dB)	Condition
Mode 1	Pass	AV	266.53k	41.36	51.22	-9.86	Neutral



Mode Configure

Mode	Result	Type	Freq (Hz)	Level (dBuV)	Limit (dBuV)	Margin (dB)	Condition	Comments
Mode 1	Pass	QP	265.468k	40.67	61.26	-20.59	Line	-
Mode 1	Pass	AV	265.468k	39.59	51.26	-11.67	Line	"Worst"
Mode 1	Pass	QP	421.816k	21.75	57.41	-35.66	Line	-
Mode 1	Pass	AV	421.816k	17.20	47.41	-30.21	Line	-
Mode 1	Pass	QP	667.575k	18.77	56.00	-37.23	Line	-
Mode 1	Pass	AV	667.575k	13.98	46.00	-32.02	Line	-
Mode 1	Pass	QP	3.701M	30.51	56.00	-25.49	Line	-
Mode 1	Pass	AV	3.701M	24.04	46.00	-21.96	Line	-
Mode 1	Pass	QP	10.701M	25.00	60.00	-35.00	Line	-
Mode 1	Pass	AV	10.701M	20.43	50.00	-29.57	Line	-
Mode 1	Pass	QP	14.845M	23.95	60.00	-36.05	Line	-
Mode 1	Pass	AV	14.845M	19.40	50.00	-30.60	Line	-
Mode 1	Pass	QP	266.53k	42.18	61.22	-19.04	Neutral	-
Mode 1	Pass	AV	266.53k	41.36	51.22	-9.86	Neutral	"Worst"
Mode 1	Pass	QP	375.703k	20.67	58.37	-37.70	Neutral	-
Mode 1	Pass	AV	375.703k	17.84	48.37	-30.53	Neutral	-
Mode 1	Pass	QP	911.443k	19.52	56.00	-36.48	Neutral	-
Mode 1	Pass	AV	911.443k	15.05	46.00	-30.95	Neutral	-
Mode 1	Pass	QP	3.701M	26.75	56.00	-29.25	Neutral	-
Mode 1	Pass	AV	3.701M	20.96	46.00	-25.04	Neutral	-
Mode 1	Pass	QP	10.701M	24.67	60.00	-35.33	Neutral	-
Mode 1	Pass	AV	10.701M	20.23	50.00	-29.77	Neutral	-
Mode 1	Pass	QP	29.147M	26.41	60.00	-33.59	Neutral	-
Mode 1	Pass	AV	29.147M	19.77	50.00	-30.23	Neutral	-

Conducted Emissions at Powerline_Mode 1

15/07/2020

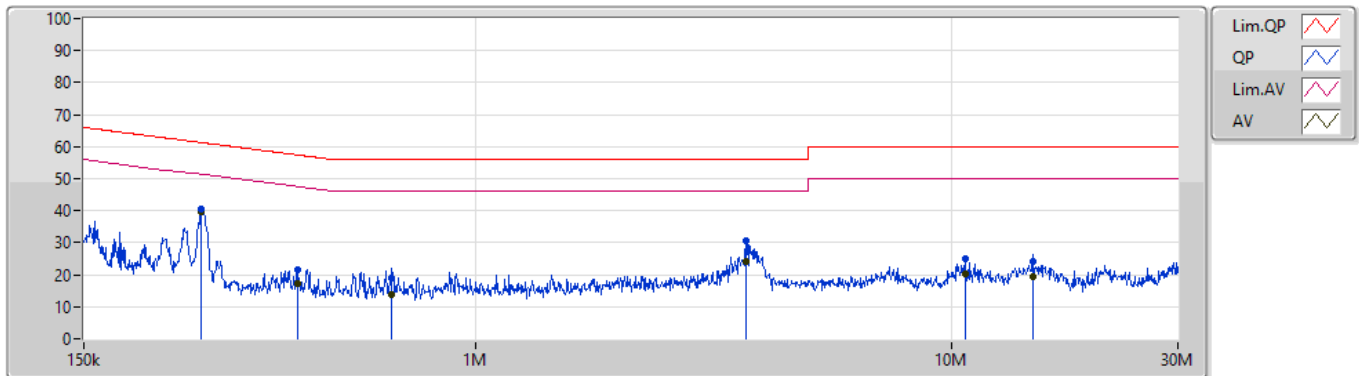

Type	Freq (Hz)	Level (dBuV)	Limit (dBuV)	Margin (dB)	Factor (dB)	Condition	Comment	Raw (dBuV)	LISN (dB)	CL (dB)	AT (dB)
QP	265.468k	40.67	61.26	-20.59	19.64	Line	-	21.03	9.65	0.12	9.87
AV	265.468k	39.59	51.26	-11.67	19.64	Line	"Worst"	19.95	9.65	0.12	9.87
QP	421.816k	21.75	57.41	-35.66	19.64	Line	-	2.11	9.64	0.13	9.87
AV	421.816k	17.20	47.41	-30.21	19.64	Line	-	-2.44	9.64	0.13	9.87
QP	667.575k	18.77	56.00	-37.23	19.63	Line	-	-0.86	9.64	0.12	9.87
AV	667.575k	13.98	46.00	-32.02	19.63	Line	-	-5.65	9.64	0.12	9.87
QP	3.701M	30.51	56.00	-25.49	19.72	Line	-	10.79	9.66	0.18	9.88
AV	3.701M	24.04	46.00	-21.96	19.72	Line	-	4.32	9.66	0.18	9.88
QP	10.701M	25.00	60.00	-35.00	19.85	Line	-	5.15	9.69	0.28	9.88
AV	10.701M	20.43	50.00	-29.57	19.85	Line	-	0.58	9.69	0.28	9.88
QP	14.845M	23.95	60.00	-36.05	19.85	Line	-	4.10	9.66	0.31	9.88
AV	14.845M	19.40	50.00	-30.60	19.85	Line	-	-0.45	9.66	0.31	9.88

Conducted Emissions at Powerline_Mode 1

15/07/2020

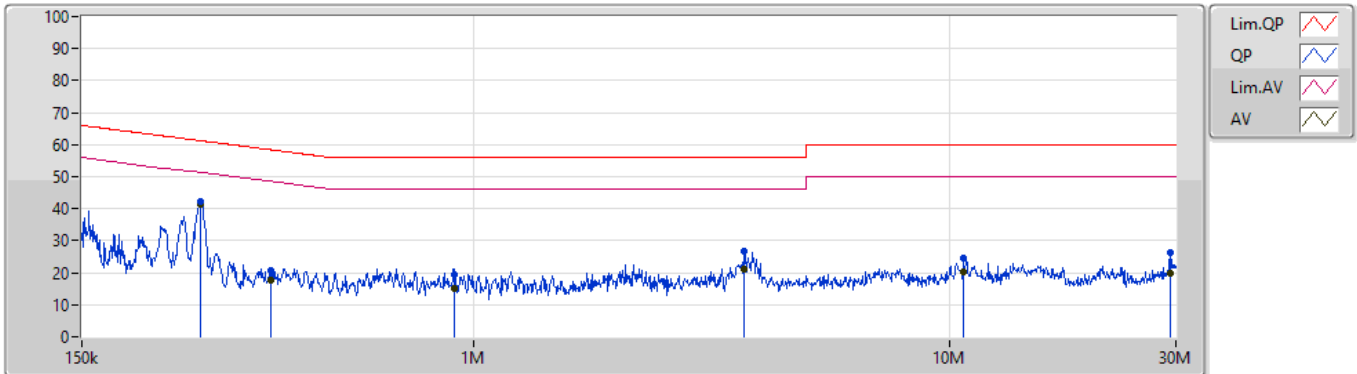

Type	Freq (Hz)	Level (dBuV)	Limit (dBuV)	Margin (dB)	Factor (dB)	Condition	Comment	Raw (dBuV)	LISN (dB)	CL (dB)	AT (dB)
QP	266.53k	42.18	61.22	-19.04	19.63	Neutral	-	22.55	9.64	0.12	9.87
AV	266.53k	41.36	51.22	-9.86	19.63	Neutral	"Worst"	21.73	9.64	0.12	9.87
QP	375.703k	20.67	58.37	-37.70	19.63	Neutral	-	1.04	9.63	0.13	9.87
AV	375.703k	17.84	48.37	-30.53	19.63	Neutral	-	-1.79	9.63	0.13	9.87
QP	911.443k	19.52	56.00	-36.48	19.62	Neutral	-	-0.10	9.63	0.11	9.88
AV	911.443k	15.05	46.00	-30.95	19.62	Neutral	-	-4.57	9.63	0.11	9.88
QP	3.701M	26.75	56.00	-29.25	19.72	Neutral	-	7.03	9.66	0.18	9.88
AV	3.701M	20.96	46.00	-25.04	19.72	Neutral	-	1.24	9.66	0.18	9.88
QP	10.701M	24.67	60.00	-35.33	19.86	Neutral	-	4.81	9.70	0.28	9.88
AV	10.701M	20.23	50.00	-29.77	19.86	Neutral	-	0.37	9.70	0.28	9.88
QP	29.147M	26.41	60.00	-33.59	19.98	Neutral	-	6.43	9.66	0.44	9.88
AV	29.147M	19.77	50.00	-30.23	19.98	Neutral	-	-0.21	9.66	0.44	9.88



Summary

Mode	Max-N dB (Hz)	Max-OBW (Hz)	ITU-Code	Min-N dB (Hz)	Min-OBW (Hz)
2.4-2.4835GHz	-	-	-	-	-
BT-LE(1Mbps)	718.75k	1.052M	1M05F1D	713.75k	1.051M
BT-LE(2Mbps)	1.22M	2.083M	2M08F1D	1.173M	2.079M

Max-N dB = Maximum 6dB down bandwidth; **Max-OBW** = Maximum 99% occupied bandwidth;
Min-N dB = Minimum 6dB down bandwidth; **Min-OBW** = Minimum 99% occupied bandwidth;



Result

Mode	Result	Limit (Hz)	Port 1-N dB (Hz)	Port 1-OBW (Hz)
BT-LE(1Mbps)	-	-	-	-
2402MHz	Pass	500k	715k	1.051M
2440MHz	Pass	500k	718.75k	1.052M
2480MHz	Pass	500k	713.75k	1.051M
BT-LE(2Mbps)	-	-	-	-
2402MHz	Pass	500k	1.173M	2.079M
2440MHz	Pass	500k	1.22M	2.079M
2480MHz	Pass	500k	1.175M	2.083M

Port X-N dB = Port X 6dB down bandwidth; Port X-OBW = Port X 99% occupied bandwidth;

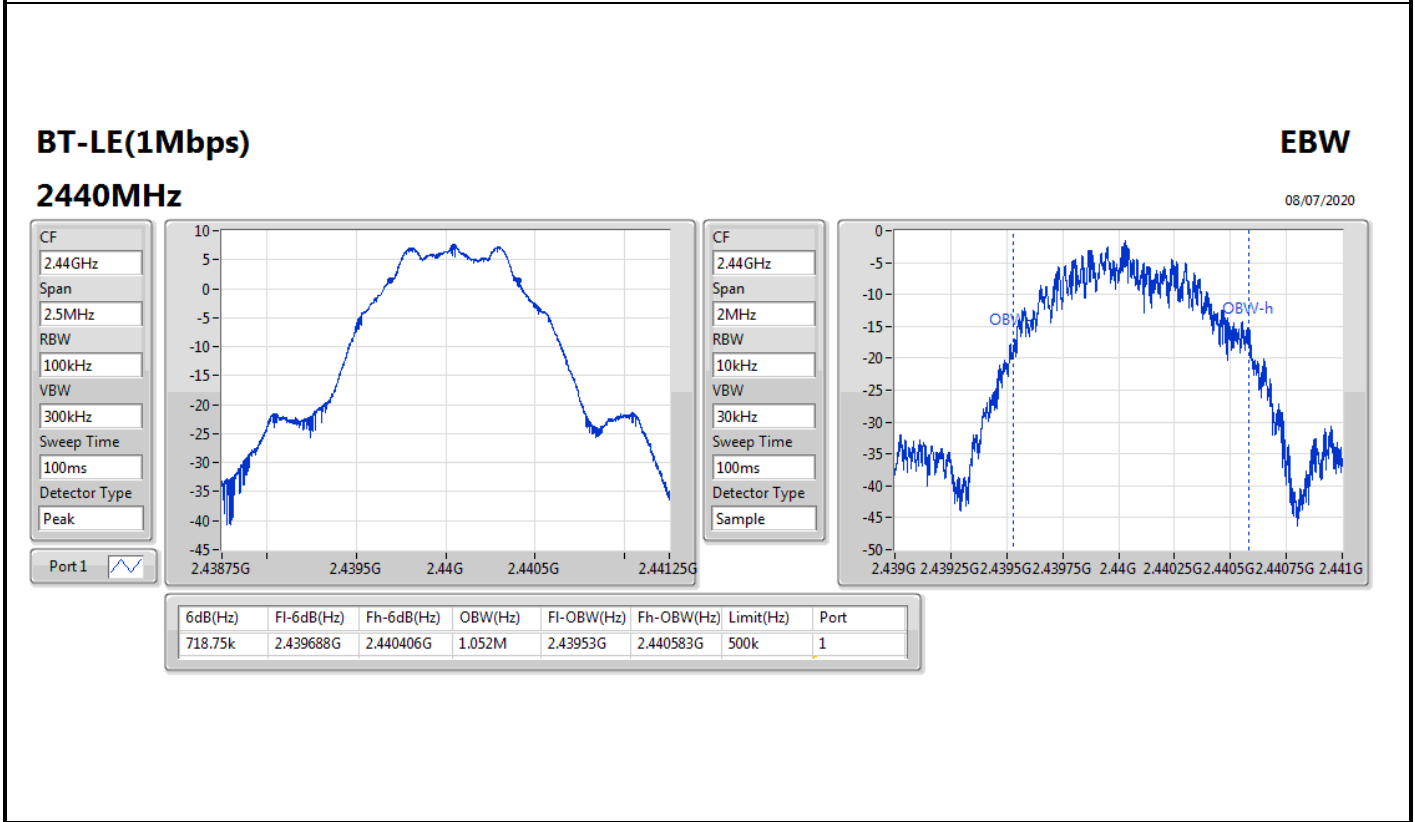
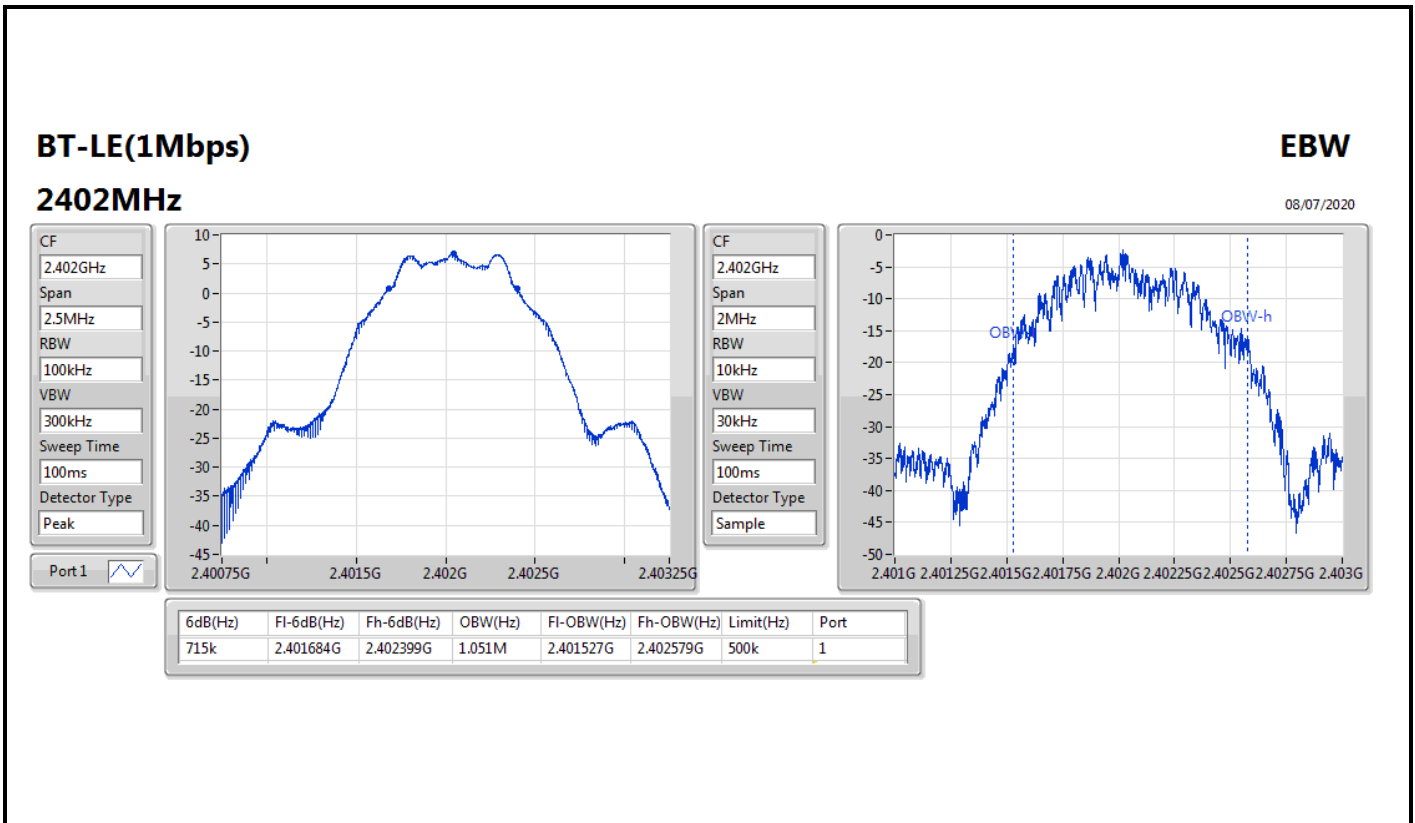

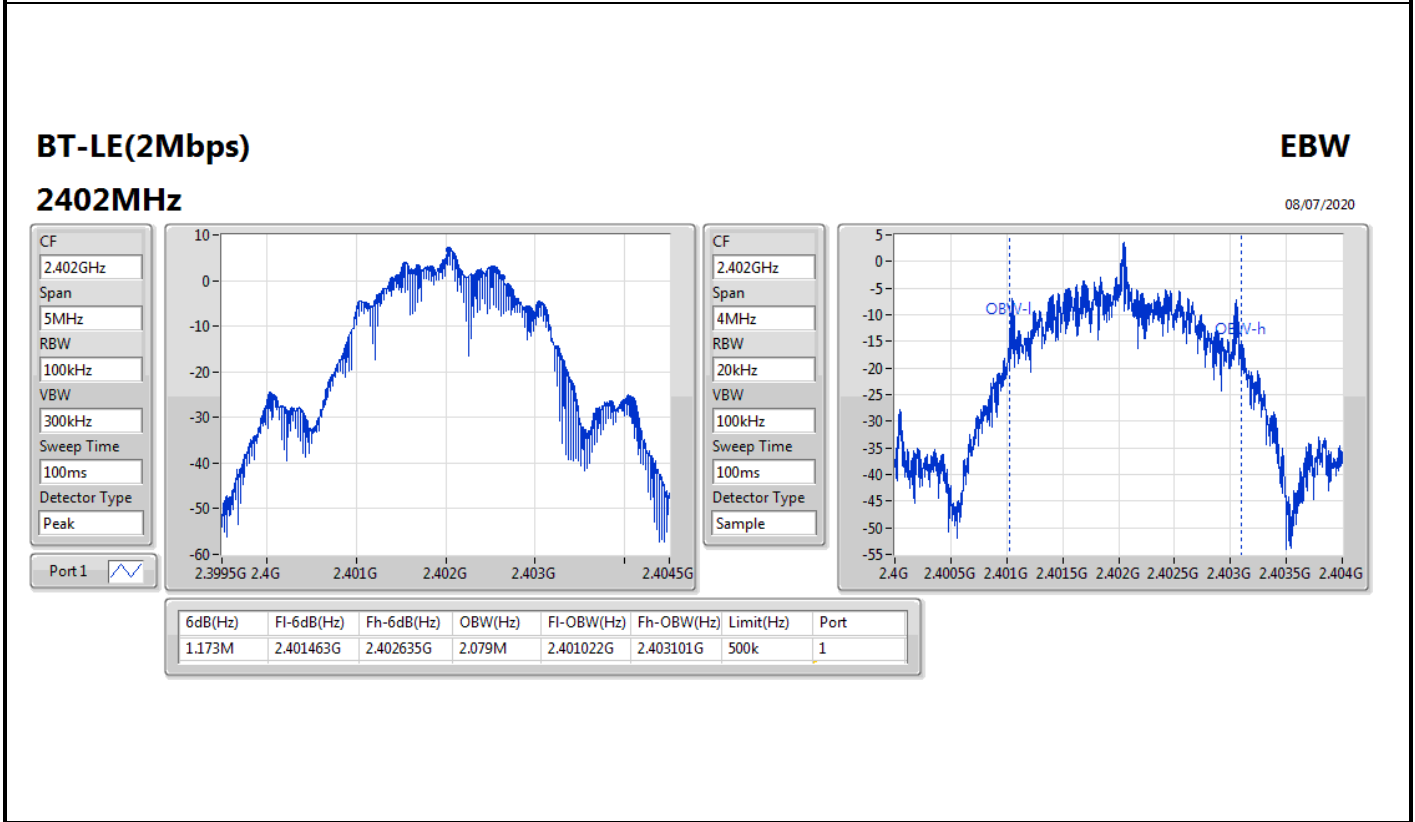
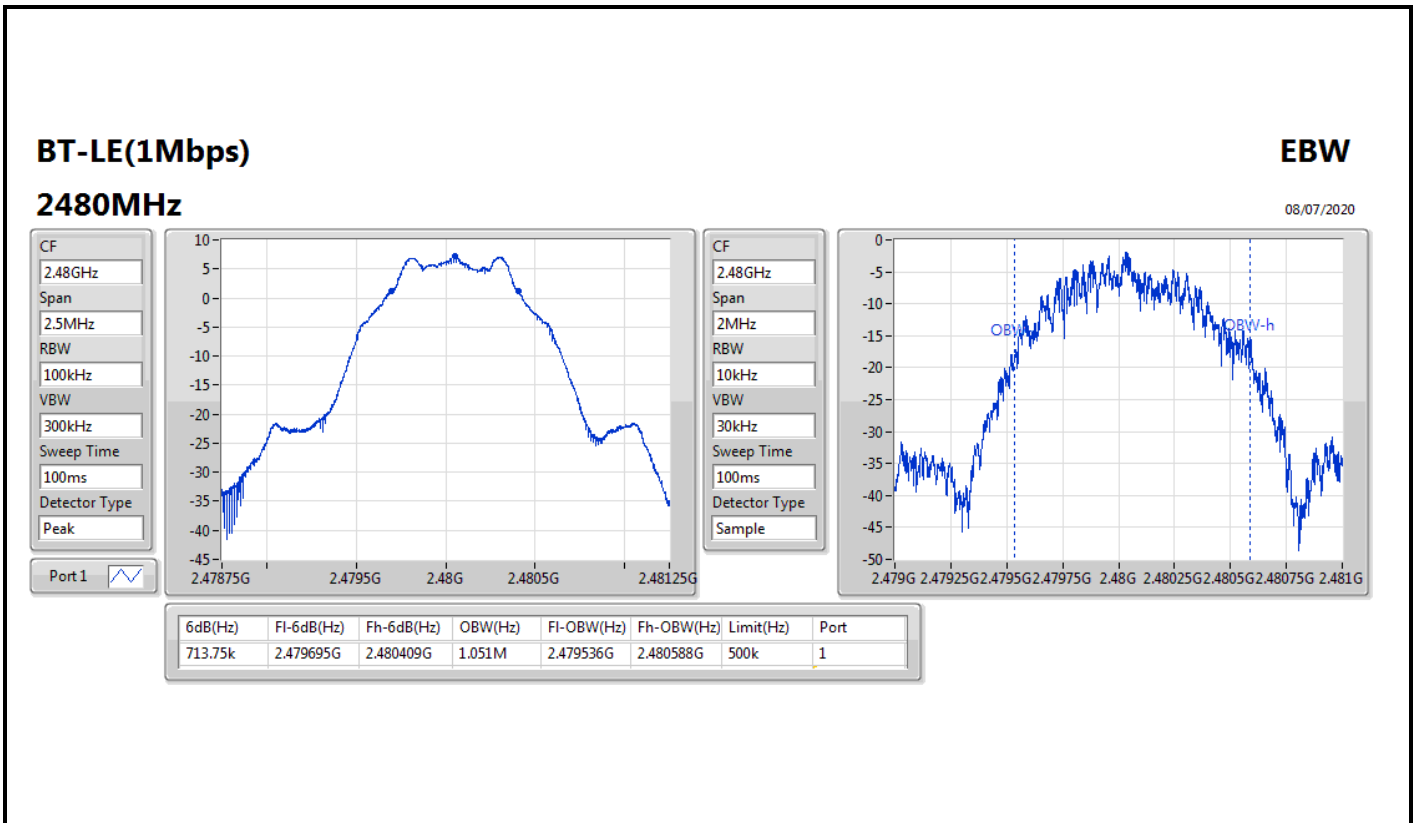

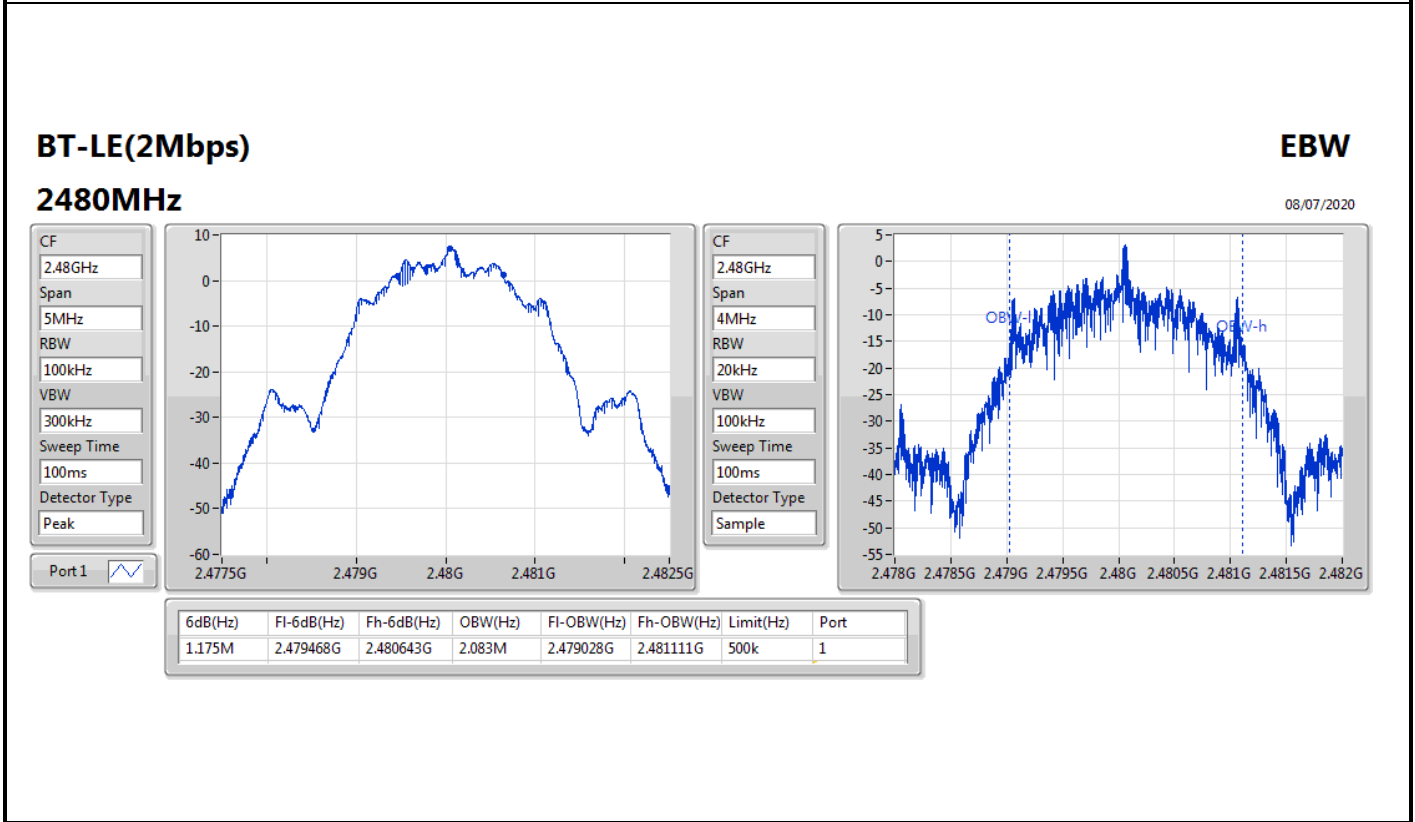
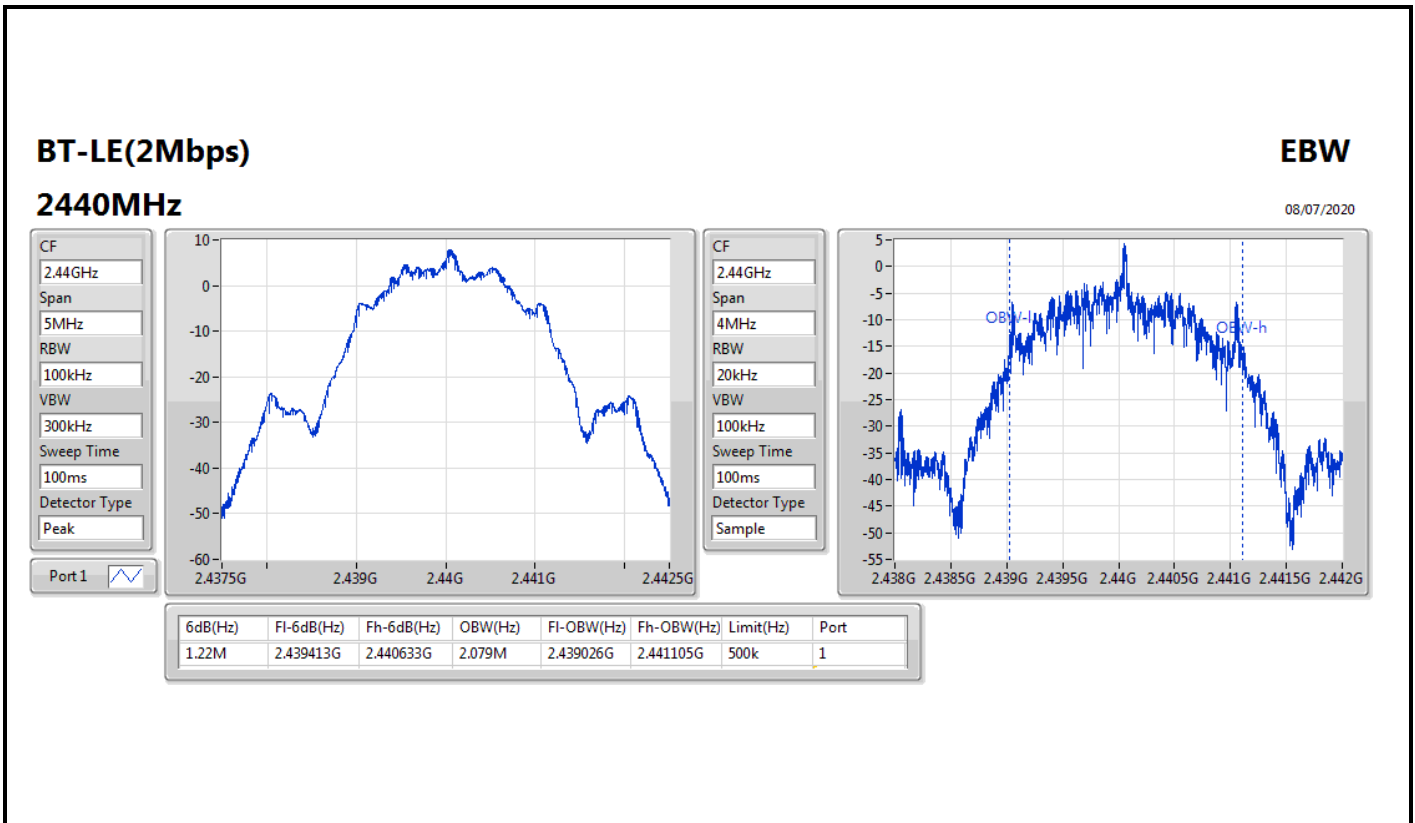



Summary

Mode	Power (dBm)	Power (W)
2.4-2.4835GHz	-	-
BT-LE(1Mbps)	7.79	0.00601
BT-LE(2Mbps)	7.71	0.00590



Result

Mode	Result	Gain (dBi)	Power (dBm)	Power Limit (dBm)
BT-LE(1Mbps)	-	-	-	-
2402MHz	Pass	2.74	7.24	30.00
2440MHz	Pass	2.74	7.79	30.00
2480MHz	Pass	2.74	7.61	30.00
BT-LE(2Mbps)	-	-	-	-
2402MHz	Pass	2.74	7.27	30.00
2440MHz	Pass	2.74	7.71	30.00
2480MHz	Pass	2.74	7.43	30.00

DG = Directional Gain; **Port X** = Port X output power



Summary

Mode	PD (dBm/RBW)
2.4-2.4835GHz	-
BT-LE(1Mbps)	-7.05
BT-LE(2Mbps)	-8.82

RBW=3 kHz.



Result

Mode	Result	Gain (dBi)	PD (dBm/RBW)	PD Limit (dBm/RBW)
BT-LE(1Mbps)	-	-	-	-
2402MHz	Pass	2.74	-7.21	8.00
2440MHz	Pass	2.74	-7.58	8.00
2480MHz	Pass	2.74	-7.05	8.00
BT-LE(2Mbps)	-	-	-	-
2402MHz	Pass	2.74	-9.09	8.00
2440MHz	Pass	2.74	-10.83	8.00
2480MHz	Pass	2.74	-8.82	8.00

DG = Directional Gain; RBW=3 kHz;

PD = trace bin-by-bin of each transmits port summing can be performed maximum power density; Port X = Port X power density;

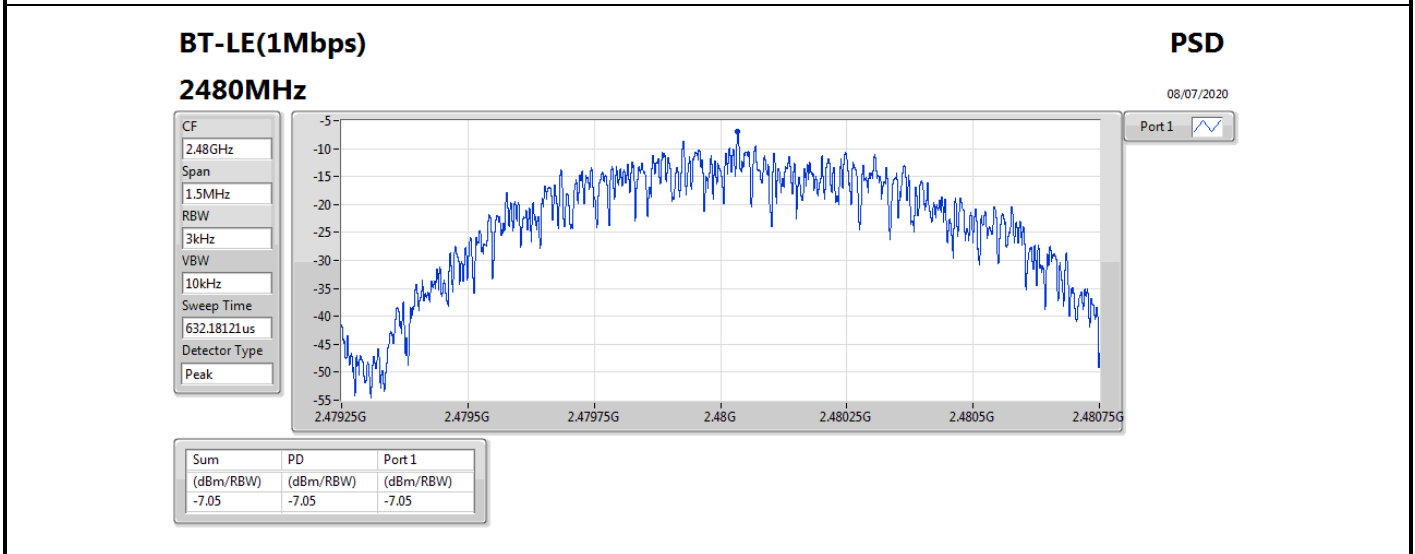
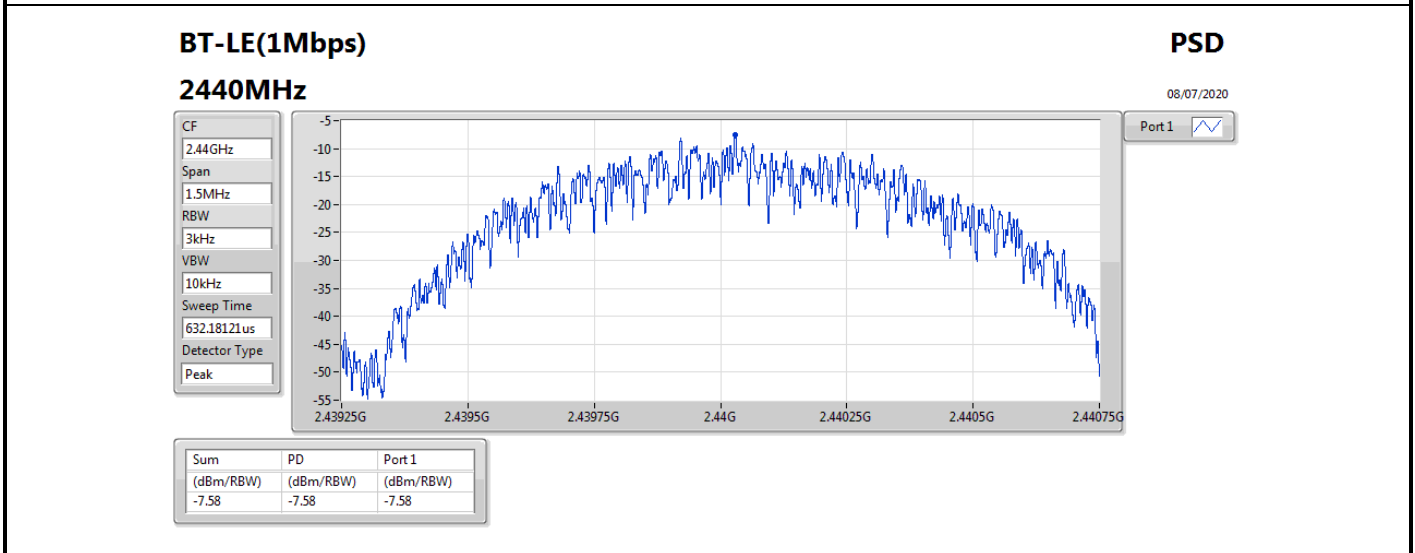
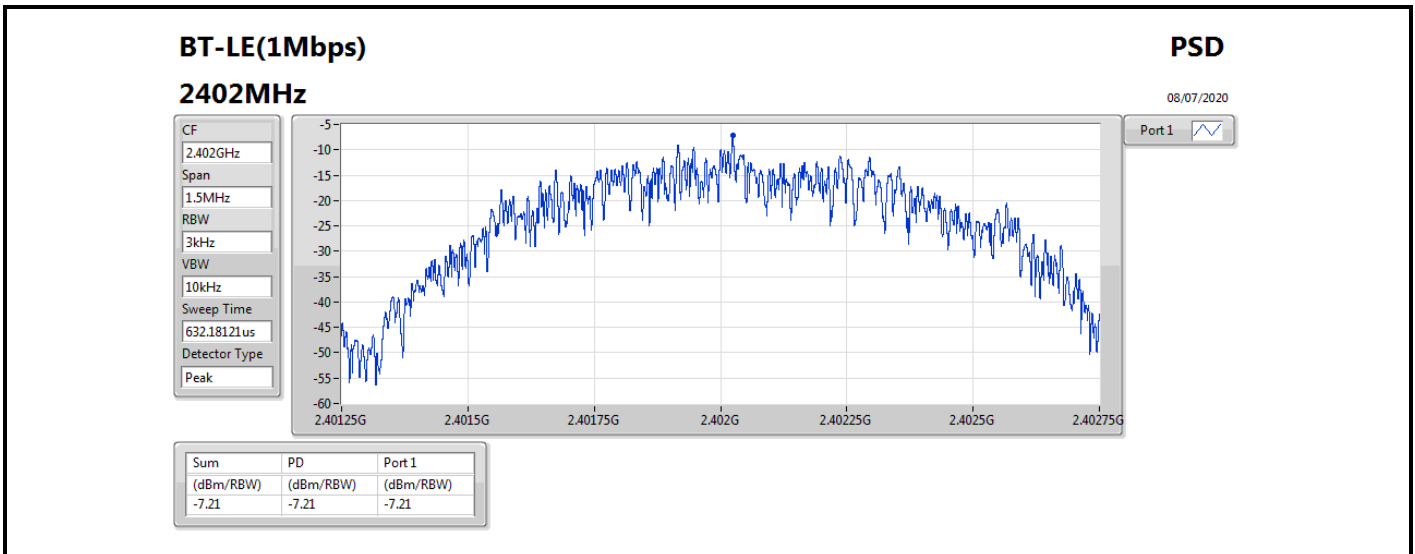

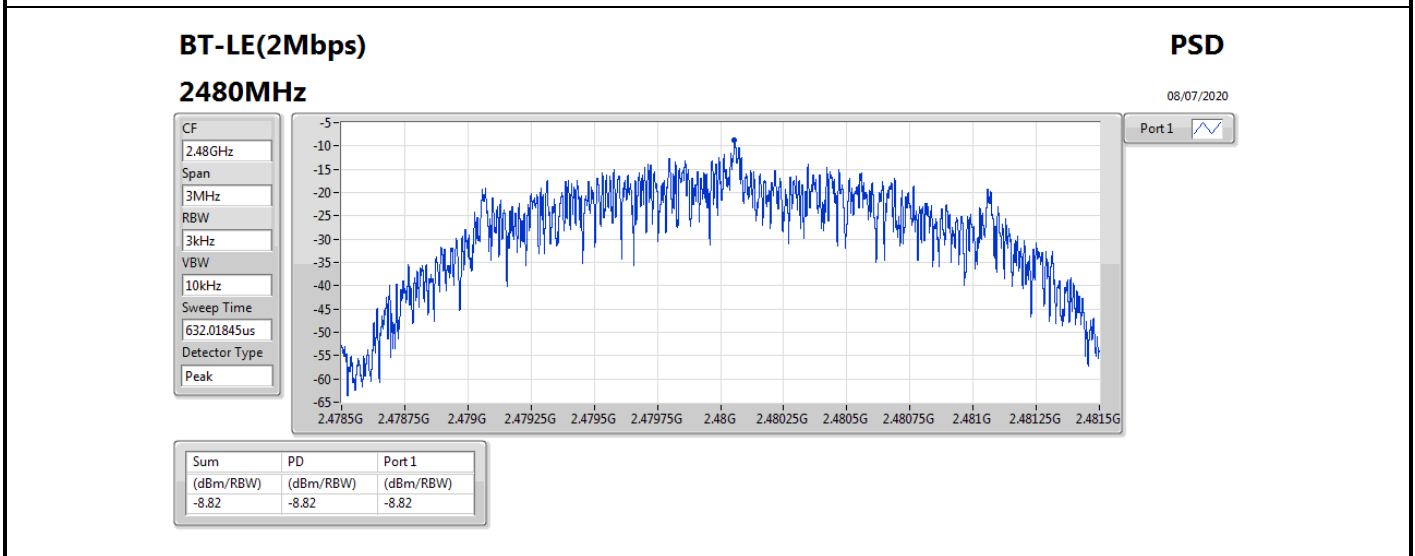
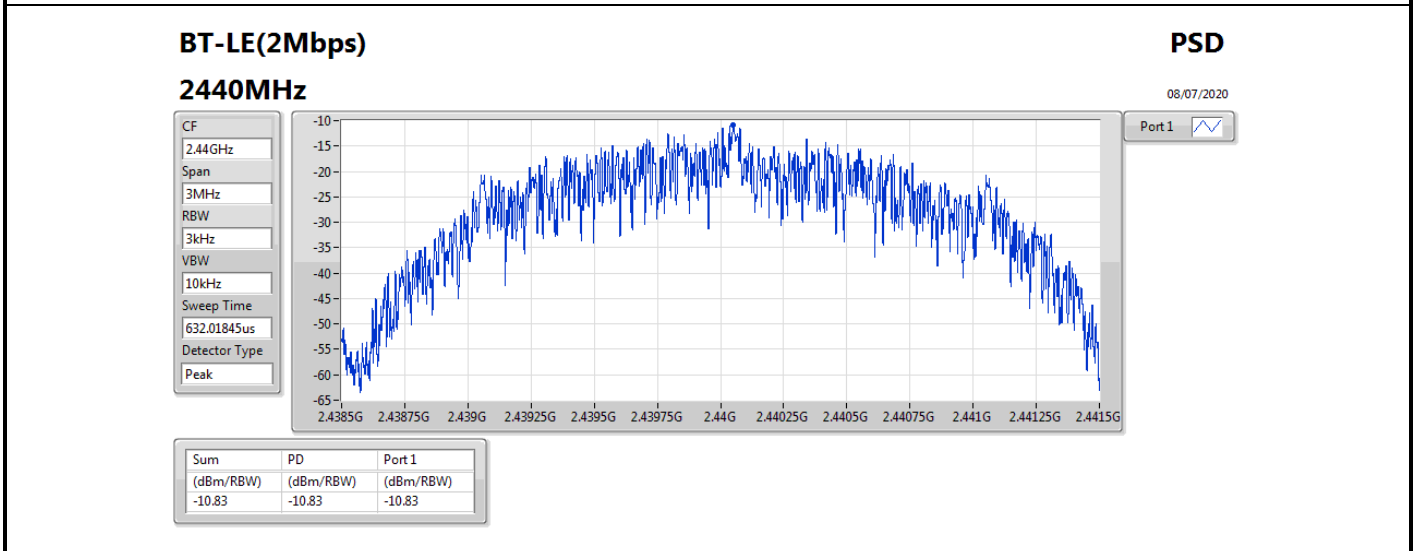
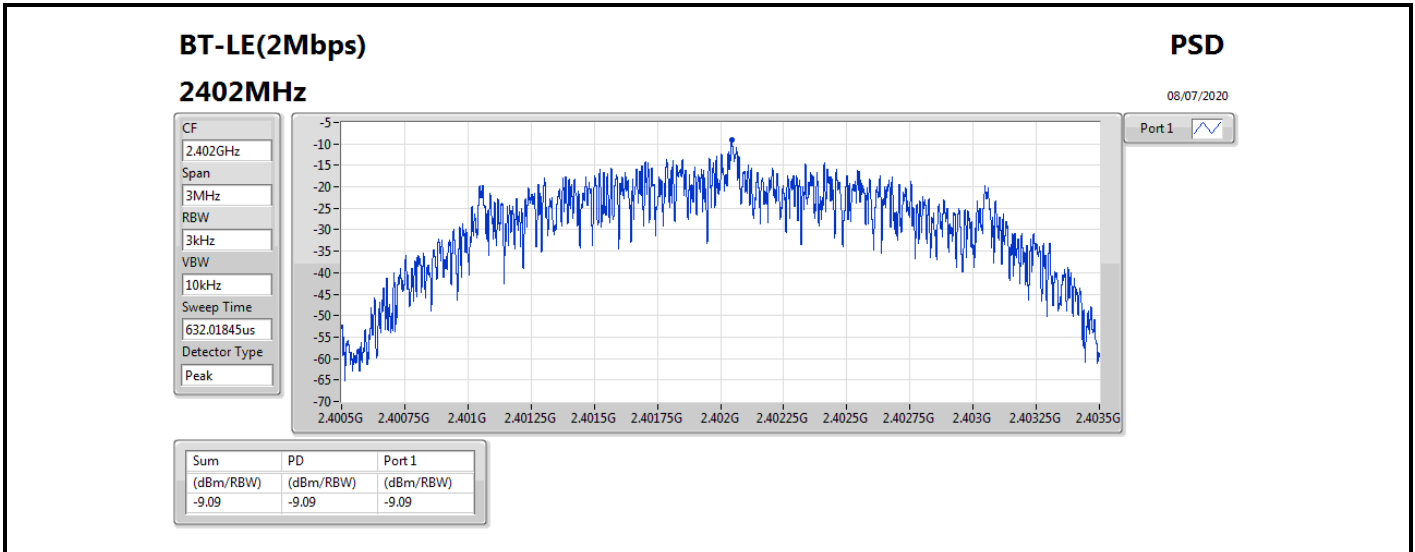



Summary

Mode	Result	Ref (Hz)	Ref (dBm)	Limit (dBm)	Freq (Hz)	Level (dBm)	Freq (Hz)	Level (dBm)	Freq (Hz)	Level (dBm)	Freq (Hz)	Level (dBm)	Freq (Hz)	Level (dBm)	Port
2.4-2.4835GHz	-	-	-	-	-	-	-	-	-	-	-	-	-	-	-
BT-LE(1Mbps)	Pass	2.44004G	7.25	-22.75	2.30539G	-54.68	2.39321G	-53.69	2.4835G	-56.02	2.49506G	-51.91	23.55741G	-41.52	1
BT-LE(2Mbps)	Pass	2.44004G	7.12	-22.88	1.98549G	-52.68	2.4G	-27.00	2.4G	-24.65	2.48366G	-52.56	17.60146G	-41.54	1



Result

Mode	Result	Ref (Hz)	Ref (dBm)	Limit (dBm)	Freq (Hz)	Level (dBm)	Freq (Hz)	Level (dBm)	Freq (Hz)	Level (dBm)	Freq (Hz)	Level (dBm)	Freq (Hz)	Level (dBm)	Port
BT-LE(1Mbps)	-	-	-	-	-	-	-	-	-	-	-	-	-	-	-
2402MHz	Pass	2.44004G	7.25	-22.75	1.88856G	-54.38	2.39992G	-52.09	2.4G	-51.99	2.49093G	-52.84	17.60146G	-41.34	1
2440MHz	Pass	2.44004G	7.25	-22.75	2.30539G	-54.68	2.39321G	-53.69	2.4835G	-56.02	2.49506G	-51.91	23.55741G	-41.52	1
2480MHz	Pass	2.44004G	7.25	-22.75	755.56M	-53.75	2.39982G	-53.36	2.4835G	-55.00	2.48766G	-52.29	24.87346G	-41.88	1
BT-LE(2Mbps)	-	-	-	-	-	-	-	-	-	-	-	-	-	-	-
2402MHz	Pass	2.44004G	7.12	-22.88	1.98549G	-52.68	2.4G	-27.00	2.4G	-24.65	2.48366G	-52.56	17.60146G	-41.54	1
2440MHz	Pass	2.44004G	7.12	-22.88	2.08096G	-54.48	2.39053G	-53.43	2.4835G	-56.33	2.5018G	-52.55	23.57428G	-41.39	1
2480MHz	Pass	2.44004G	7.12	-22.88	1.8489G	-55.12	2.39858G	-53.55	2.4835G	-56.16	2.49614G	-52.38	23.5546G	-41.70	1

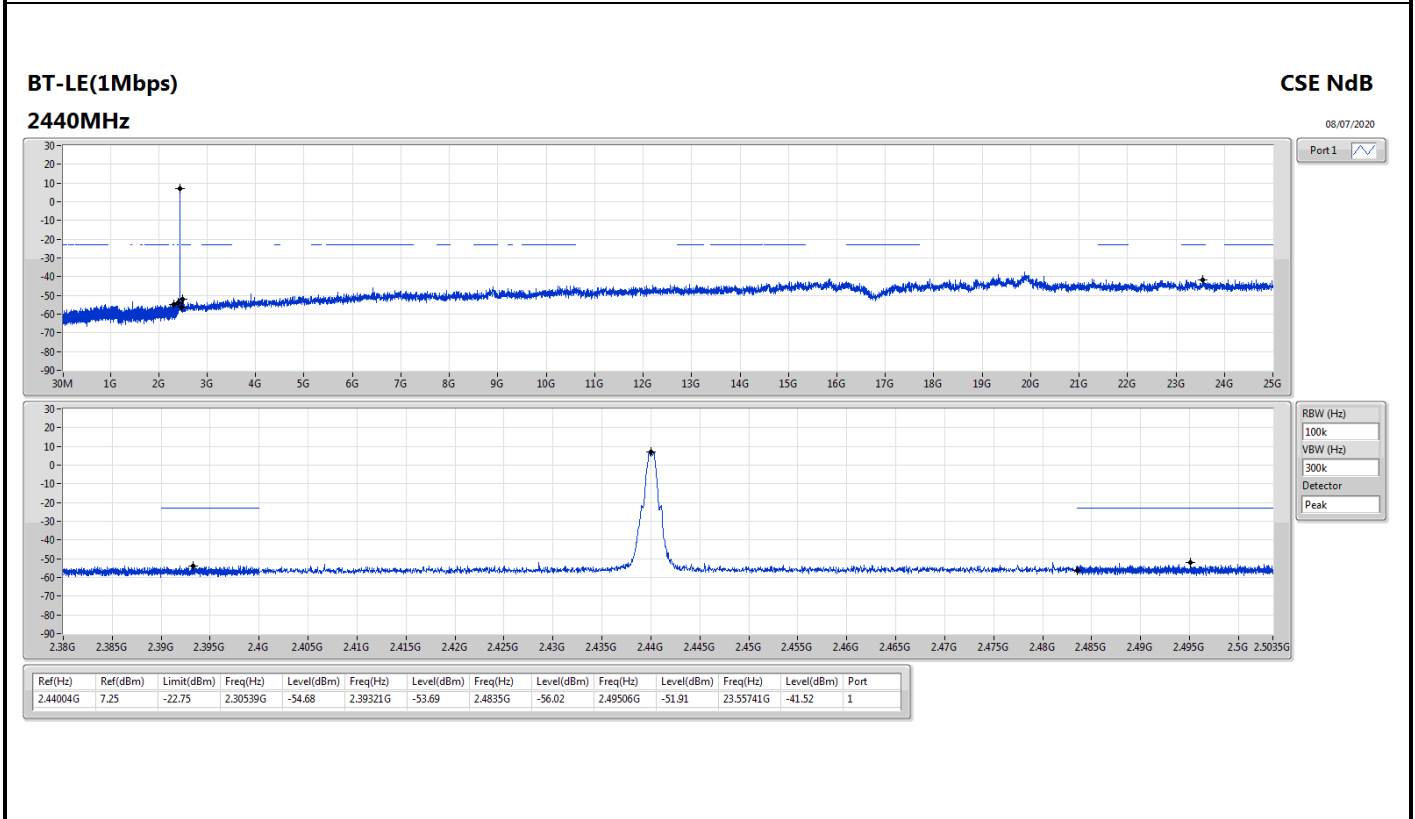
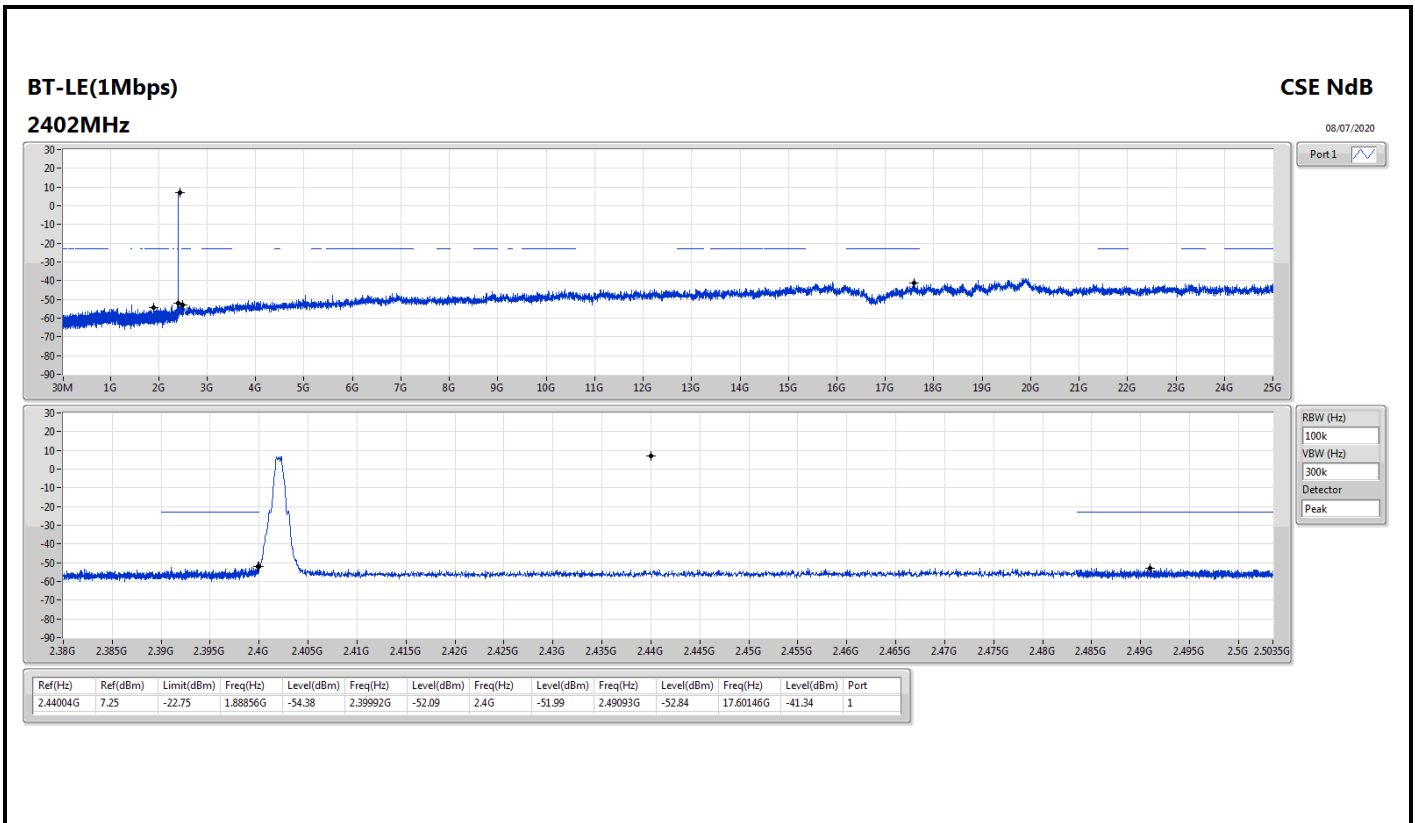

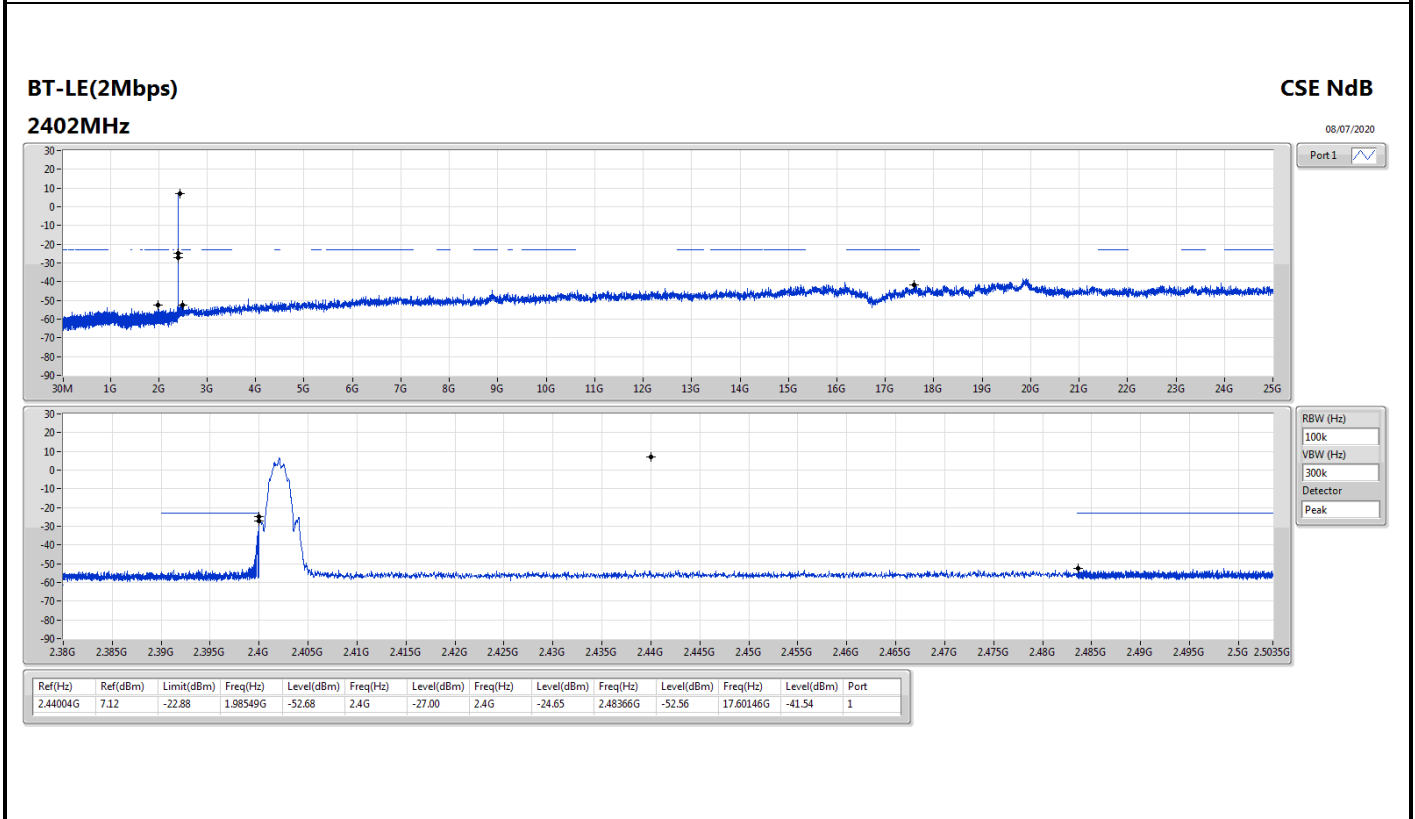
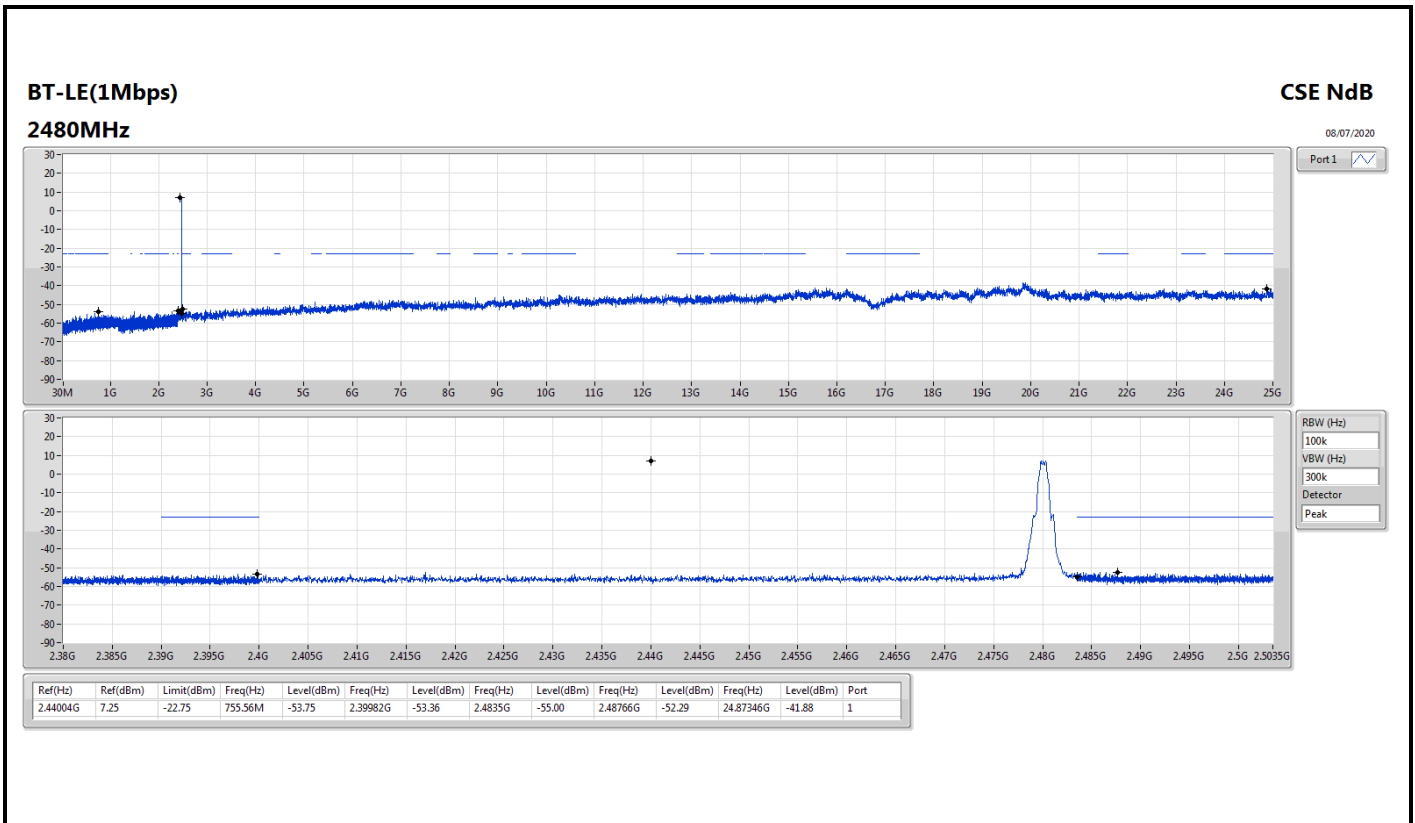

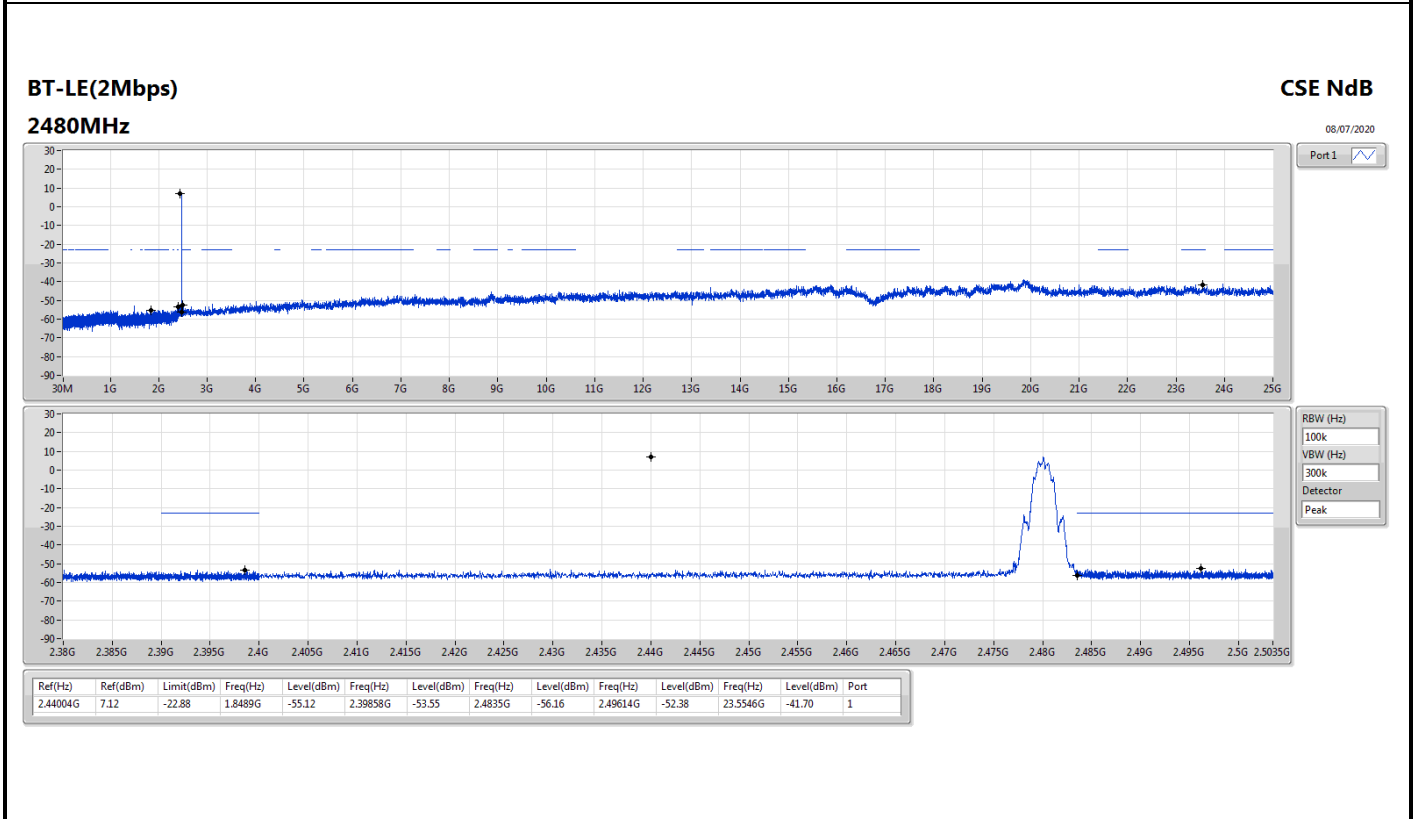
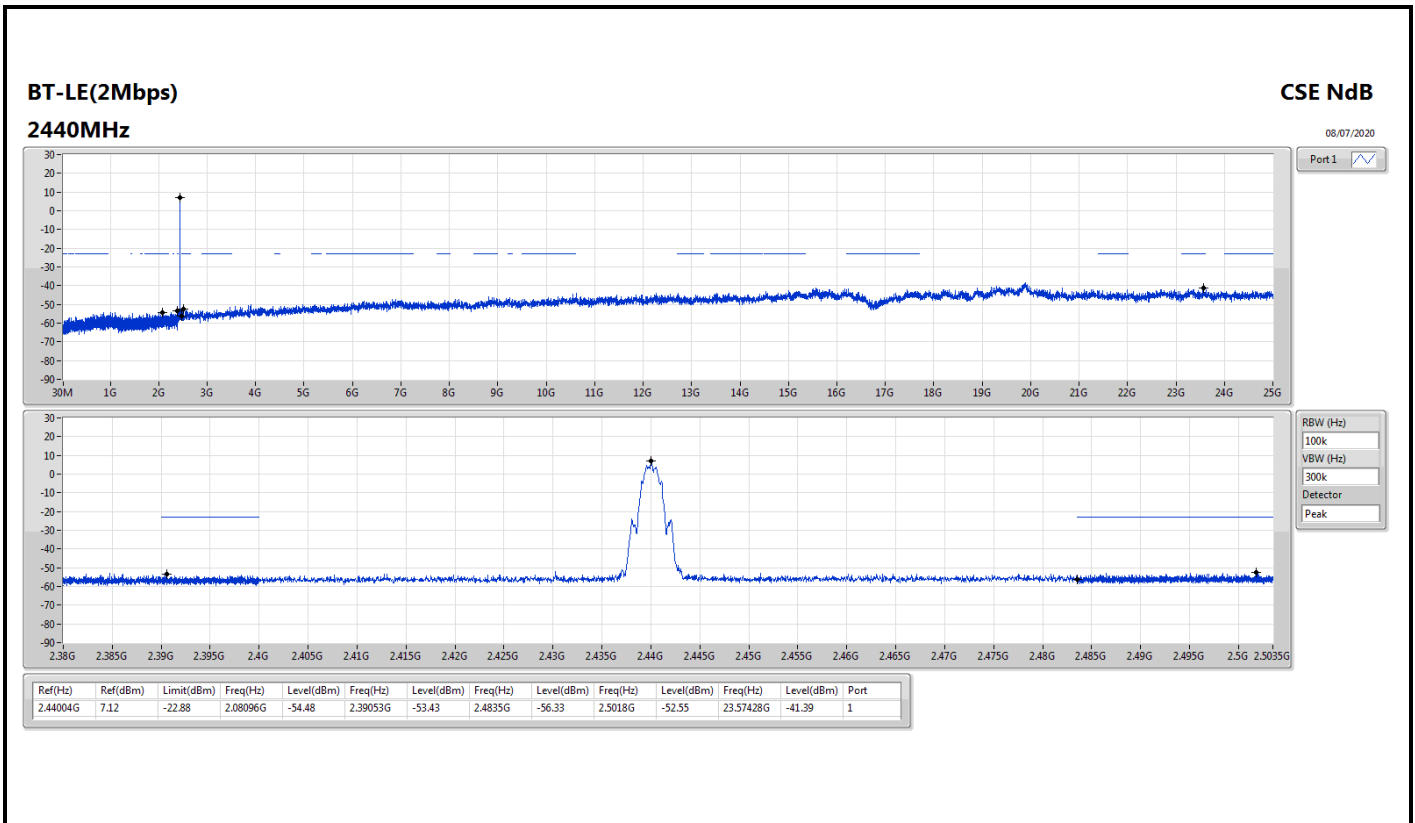



Summary

Mode	Result	Type	Freq (Hz)	Level (dBuV/m)	Limit (dBuV/m)	Margin (dB)	Dist (m)	Condition	Azimuth (°)	Height (m)	Comments
2.4-2.4835GHz	-	-	-	-	-	-	-	-	-	-	-
BT-LE(2Mbps)	Pass	PK	30M	33.67	40.00	-6.33	3	Vertical	360	1.00	-



Result

Mode	Result	Type	Freq (Hz)	Level (dBuV/m)	Limit (dBuV/m)	Margin (dB)	Dist (m)	Condition	Azimuth (°)	Height (m)	Comments
BT-LE(2Mbps)	-	-	-	-	-	-	-	-	-	-	-
2440MHz	Pass	PK	30M	33.67	40.00	-6.33	3	Vertical	360	1.00	-
2440MHz	Pass	PK	119.24M	29.98	43.50	-13.52	3	Vertical	360	1.00	-
2440MHz	Pass	PK	216.24M	25.46	46.00	-20.54	3	Vertical	360	1.00	-
2440MHz	Pass	PK	332.64M	27.80	46.00	-18.20	3	Vertical	360	1.00	-
2440MHz	Pass	PK	462.62M	30.47	46.00	-15.53	3	Vertical	360	1.00	-
2440MHz	Pass	PK	613.94M	31.88	46.00	-14.12	3	Vertical	360	1.00	-
2440MHz	Pass	PK	30M	29.74	40.00	-10.26	3	Horizontal	0	1.00	-
2440MHz	Pass	PK	127M	25.45	43.50	-18.05	3	Horizontal	0	1.00	-
2440MHz	Pass	PK	216.24M	30.61	46.00	-15.39	3	Horizontal	0	1.00	-
2440MHz	Pass	PK	317.12M	35.80	46.00	-10.20	3	Horizontal	0	1.00	-
2440MHz	Pass	PK	468.44M	30.74	46.00	-15.26	3	Horizontal	0	1.00	-
2440MHz	Pass	PK	666.32M	32.47	46.00	-13.53	3	Horizontal	0	1.00	-

BT-LE(2Mbps)

08/07/2020

2440MHz_Adapter

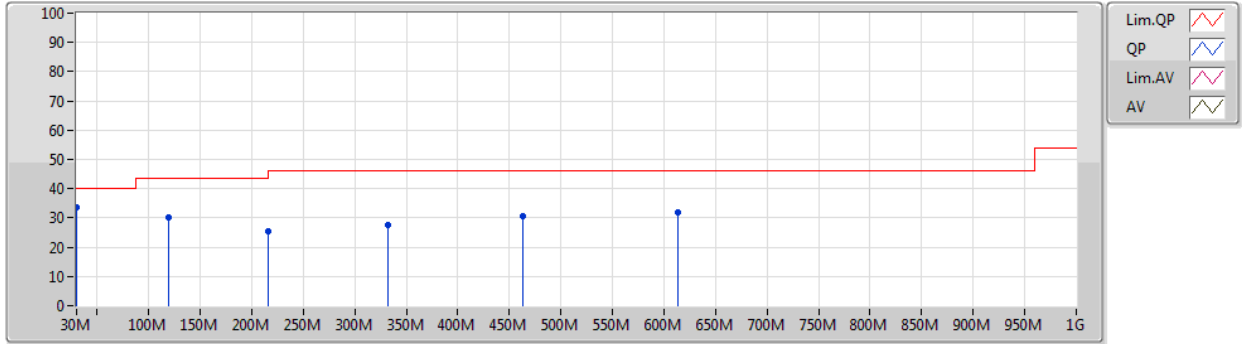

Type	Freq (Hz)	Level (dBuV/m)	Limit (dBuV/m)	Margin (dB)	Factor (dB)	Dist (m)	Condition	Azimuth (°)	Height (m)	Comment	Raw (dBuV)	AF (dB)	CL (dB)	PA (dB)
PK	30M	33.67	40.00	-6.33	-2.92	3	Vertical	360	1.00	-	36.59	23.48	0.81	27.21
PK	119.24M	29.98	43.50	-13.52	-8.81	3	Vertical	360	1.00	-	38.79	17.28	1.62	27.71
PK	216.24M	25.46	46.00	-20.54	-10.82	3	Vertical	360	1.00	-	36.28	14.17	2.22	27.21
PK	332.64M	27.80	46.00	-18.20	-5.58	3	Vertical	360	1.00	-	33.38	18.84	2.80	27.22
PK	462.62M	30.47	46.00	-15.53	-2.53	3	Vertical	360	1.00	-	33.00	22.25	3.34	28.12
PK	613.94M	31.88	46.00	-14.12	-0.34	3	Vertical	360	1.00	-	32.22	24.05	3.92	28.31



BT-LE(2Mbps)

08/07/2020

2440MHz_Adapter

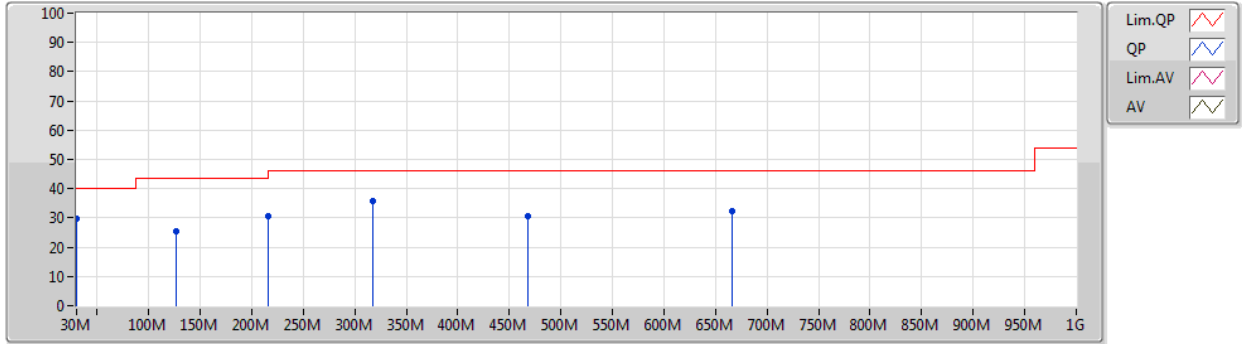

Type	Freq (Hz)	Level (dBuV/m)	Limit (dBuV/m)	Margin (dB)	Factor (dB)	Dist (m)	Condition	Azimuth (°)	Height (m)	Comment	Raw (dBuV)	AF (dB)	CL (dB)	PA (dB)
PK	30M	29.74	40.00	-10.26	-2.92	3	Horizontal	0	1.00	-	32.66	23.48	0.81	27.21
PK	127M	25.45	43.50	-18.05	-8.91	3	Horizontal	0	1.00	-	34.36	17.10	1.67	27.68
PK	216.24M	30.61	46.00	-15.39	-10.82	3	Horizontal	0	1.00	-	41.43	14.17	2.22	27.21
PK	317.12M	35.80	46.00	-10.20	-5.68	3	Horizontal	0	1.00	-	41.48	18.73	2.73	27.14
PK	468.44M	30.74	46.00	-15.26	-2.30	3	Horizontal	0	1.00	-	33.04	22.48	3.37	28.15
PK	666.32M	32.47	46.00	-13.53	-0.09	3	Horizontal	0	1.00	-	32.56	24.06	4.07	28.22



Summary

Mode	Result	Type	Freq (Hz)	Level (dBuV/m)	Limit (dBuV/m)	Margin (dB)	Dist (m)	Condition	Azimuth (°)	Height (m)	Comments
2.4-2.4835GHz	-	-	-	-	-	-	-	-	-	-	-
BT-LE(1Mbps)	Pass	AV	2.4835G	50.55	54.00	-3.45	3	Vertical	251	1.52	-
BT-LE(2Mbps)	Pass	AV	2.4835G	51.97	54.00	-2.03	3	Vertical	249	2.02	-



Result

Mode	Result	Type	Freq (Hz)	Level (dBuV/m)	Limit (dBuV/m)	Margin (dB)	Dist (m)	Condition	Azimuth (°)	Height (m)	Comments
BT-LE(1Mbps)	-	-	-	-	-	-	-	-	-	-	-
2402MHz	Pass	AV	2.354G	46.75	54.00	-7.25	3	Vertical	251	2.09	-
2402MHz	Pass	AV	2.402G	102.06	Inf	-Inf	3	Vertical	251	2.09	-
2402MHz	Pass	PK	2.359G	58.04	74.00	-15.96	3	Vertical	251	2.09	-
2402MHz	Pass	PK	2.4024G	103.56	Inf	-Inf	3	Vertical	251	2.09	-
2402MHz	Pass	AV	2.3548G	46.96	54.00	-7.04	3	Horizontal	101	1.11	-
2402MHz	Pass	AV	2.402G	100.74	Inf	-Inf	3	Horizontal	101	1.11	-
2402MHz	Pass	PK	2.3592G	58.08	74.00	-15.92	3	Horizontal	101	1.11	-
2402MHz	Pass	PK	2.4018G	102.23	Inf	-Inf	3	Horizontal	101	1.11	-
2402MHz	Pass	AV	4.80386G	31.79	54.00	-22.21	3	Vertical	206	2.62	-
2402MHz	Pass	PK	4.80732G	44.05	74.00	-29.95	3	Vertical	206	2.62	-
2402MHz	Pass	AV	4.80802G	31.72	54.00	-22.28	3	Horizontal	299	2.02	-
2402MHz	Pass	PK	4.80888G	44.09	74.00	-29.91	3	Horizontal	299	2.02	-
2440MHz	Pass	AV	2.3616G	46.84	54.00	-7.16	3	Vertical	252	1.79	-
2440MHz	Pass	AV	2.44G	101.78	Inf	-Inf	3	Vertical	252	1.79	-
2440MHz	Pass	AV	2.4996G	46.32	54.00	-7.68	3	Vertical	252	1.79	-
2440MHz	Pass	PK	2.3632G	57.42	74.00	-16.58	3	Vertical	252	1.79	-
2440MHz	Pass	PK	2.4396G	103.23	Inf	-Inf	3	Vertical	252	1.79	-
2440MHz	Pass	PK	2.4924G	57.70	74.00	-16.30	3	Vertical	252	1.79	-
2440MHz	Pass	AV	2.3428G	46.63	54.00	-7.37	3	Horizontal	92	1.00	-
2440MHz	Pass	AV	2.44G	102.09	Inf	-Inf	3	Horizontal	92	1.00	-
2440MHz	Pass	AV	2.5G	45.98	54.00	-8.02	3	Horizontal	92	1.00	-
2440MHz	Pass	PK	2.34G	57.56	74.00	-16.44	3	Horizontal	92	1.00	-
2440MHz	Pass	PK	2.4396G	103.54	Inf	-Inf	3	Horizontal	92	1.00	-
2440MHz	Pass	PK	2.486G	57.24	74.00	-16.76	3	Horizontal	92	1.00	-
2440MHz	Pass	AV	4.87712G	31.99	54.00	-22.01	3	Vertical	45	1.65	-
2440MHz	Pass	PK	4.8788G	44.32	74.00	-29.68	3	Vertical	45	1.65	-
2440MHz	Pass	AV	4.8797G	32.15	54.00	-21.85	3	Horizontal	243	1.49	-
2440MHz	Pass	PK	4.87938G	44.50	74.00	-29.50	3	Horizontal	243	1.49	-
2480MHz	Pass	AV	2.48G	102.49	Inf	-Inf	3	Vertical	251	1.52	-
2480MHz	Pass	AV	2.4835G	50.55	54.00	-3.45	3	Vertical	251	1.52	-
2480MHz	Pass	PK	2.4798G	103.97	Inf	-Inf	3	Vertical	251	1.52	-
2480MHz	Pass	PK	2.4928G	57.89	74.00	-16.11	3	Vertical	251	1.52	-
2480MHz	Pass	AV	2.48G	101.56	Inf	-Inf	3	Horizontal	109	2.87	-
2480MHz	Pass	AV	2.4835G	49.68	54.00	-4.32	3	Horizontal	109	2.87	-
2480MHz	Pass	PK	2.4798G	103.04	Inf	-Inf	3	Horizontal	109	2.87	-
2480MHz	Pass	PK	2.4835G	57.59	74.00	-16.41	3	Horizontal	109	2.87	-
2480MHz	Pass	AV	4.95944G	32.87	54.00	-21.13	3	Vertical	229	2.87	-
2480MHz	Pass	PK	4.9596G	44.49	74.00	-29.51	3	Vertical	229	2.87	-
2480MHz	Pass	AV	4.95924G	31.85	54.00	-22.15	3	Horizontal	130	1.49	-
2480MHz	Pass	PK	4.9594G	44.35	74.00	-29.65	3	Horizontal	130	1.49	-
BT-LE(2Mbps)	-	-	-	-	-	-	-	-	-	-	-
2402MHz	Pass	AV	2.3612G	47.50	54.00	-6.50	3	Vertical	257	2.11	-
2402MHz	Pass	AV	2.4022G	99.94	Inf	-Inf	3	Vertical	257	2.11	-
2402MHz	Pass	PK	2.3602G	57.67	74.00	-16.33	3	Vertical	257	2.11	-
2402MHz	Pass	PK	2.4026G	102.83	Inf	-Inf	3	Vertical	257	2.11	-
2402MHz	Pass	AV	2.3668G	47.81	54.00	-6.19	3	Horizontal	91	1.00	-
2402MHz	Pass	AV	2.402G	99.17	Inf	-Inf	3	Horizontal	91	1.00	-

Remark :

Level (dBuV/m) = Raw(Read Level) + AF(Antenna Factor) + CL(Cable Loss) - PA(Preamp Factor)



Mode	Result	Type	Freq (Hz)	Level (dBuV/m)	Limit (dBuV/m)	Margin (dB)	Dist (m)	Condition	Azimuth (°)	Height (m)	Comments
2402MHz	Pass	PK	2.3746G	57.63	74.00	-16.37	3	Horizontal	91	1.00	-
2402MHz	Pass	PK	2.4016G	102.15	Inf	-Inf	3	Horizontal	91	1.00	-
2402MHz	Pass	AV	4.80154G	33.14	54.00	-20.86	3	Vertical	0	2.74	-
2402MHz	Pass	PK	4.80436G	44.29	74.00	-29.71	3	Vertical	0	2.74	-
2402MHz	Pass	AV	4.80248G	33.05	54.00	-20.95	3	Horizontal	159	2.84	-
2402MHz	Pass	PK	4.80104G	43.66	74.00	-30.34	3	Horizontal	159	2.84	-
2440MHz	Pass	AV	2.3632G	47.89	54.00	-6.11	3	Vertical	252	1.81	-
2440MHz	Pass	AV	2.44G	100.44	Inf	-Inf	3	Vertical	252	1.81	-
2440MHz	Pass	AV	2.488G	47.36	54.00	-6.64	3	Vertical	252	1.81	-
2440MHz	Pass	PK	2.34G	57.95	74.00	-16.05	3	Vertical	252	1.81	-
2440MHz	Pass	PK	2.4404G	103.71	Inf	-Inf	3	Vertical	252	1.81	-
2440MHz	Pass	PK	2.4884G	57.31	74.00	-16.69	3	Vertical	252	1.81	-
2440MHz	Pass	AV	2.3576G	47.78	54.00	-6.22	3	Horizontal	99	2.41	-
2440MHz	Pass	AV	2.44G	100.98	Inf	-Inf	3	Horizontal	99	2.41	-
2440MHz	Pass	AV	2.4896G	47.48	54.00	-6.52	3	Horizontal	99	2.41	-
2440MHz	Pass	PK	2.386G	58.00	74.00	-16.00	3	Horizontal	99	2.41	-
2440MHz	Pass	PK	2.4396G	104.05	Inf	-Inf	3	Horizontal	99	2.41	-
2440MHz	Pass	PK	2.4888G	57.38	74.00	-16.62	3	Horizontal	99	2.41	-
2440MHz	Pass	AV	4.87718G	33.24	54.00	-20.76	3	Vertical	320	3.00	-
2440MHz	Pass	PK	4.87762G	45.06	74.00	-28.94	3	Vertical	320	3.00	-
2440MHz	Pass	AV	4.87762G	33.64	54.00	-20.36	3	Horizontal	183	1.48	-
2440MHz	Pass	PK	4.8773G	43.61	74.00	-30.39	3	Horizontal	183	1.48	-
2480MHz	Pass	AV	2.48G	100.18	Inf	-Inf	3	Vertical	249	2.02	-
2480MHz	Pass	AV	2.4835G	51.97	54.00	-2.03	3	Vertical	249	2.02	-
2480MHz	Pass	PK	2.4796G	103.16	Inf	-Inf	3	Vertical	249	2.02	-
2480MHz	Pass	PK	2.4835G	60.11	74.00	-13.89	3	Vertical	249	2.02	-
2480MHz	Pass	AV	2.48G	98.94	Inf	-Inf	3	Horizontal	101	2.87	-
2480MHz	Pass	AV	2.4835G	51.15	54.00	-2.85	3	Horizontal	101	2.87	-
2480MHz	Pass	PK	2.4796G	101.91	Inf	-Inf	3	Horizontal	101	2.87	-
2480MHz	Pass	PK	2.4835G	59.69	74.00	-14.31	3	Horizontal	101	2.87	-
2480MHz	Pass	AV	4.95928G	33.77	54.00	-20.23	3	Vertical	267	1.26	-
2480MHz	Pass	PK	4.95906G	44.83	74.00	-29.17	3	Vertical	267	1.26	-
2480MHz	Pass	AV	4.96076G	33.54	54.00	-20.46	3	Horizontal	51	1.48	-
2480MHz	Pass	PK	4.96248G	44.25	74.00	-29.75	3	Horizontal	51	1.48	-

BT-LE(1Mbps)

07/07/2020

2402MHz_TX

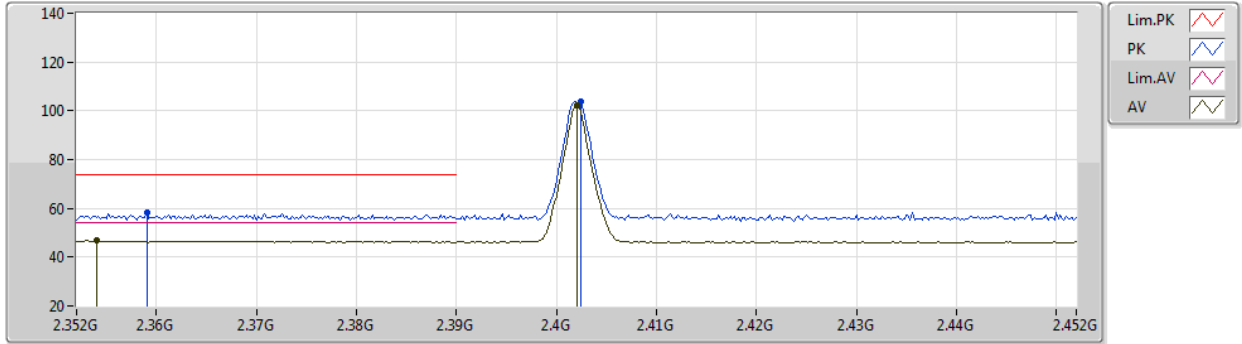

Type	Freq (Hz)	Level (dBuV/m)	Limit (dBuV/m)	Margin (dB)	Factor (dB)	Dist (m)	Condition	Azimuth (°)	Height (m)	Comment	Raw (dBuV)	AF (dB)	CL (dB)	PA (dB)
AV	2.354G	46.75	54.00	-7.25	33.62	3	Vertical	251	2.09	-	13.13	27.69	5.93	-
AV	2.402G	102.06	Inf	-Inf	33.55	3	Vertical	251	2.09	-	68.51	27.59	5.96	-
PK	2.359G	58.04	74.00	-15.96	33.61	3	Vertical	251	2.09	-	24.43	27.68	5.93	-
PK	2.4024G	103.56	Inf	-Inf	33.55	3	Vertical	251	2.09	-	70.01	27.59	5.96	-

BT-LE(1Mbps)

07/07/2020

2402MHz_TX

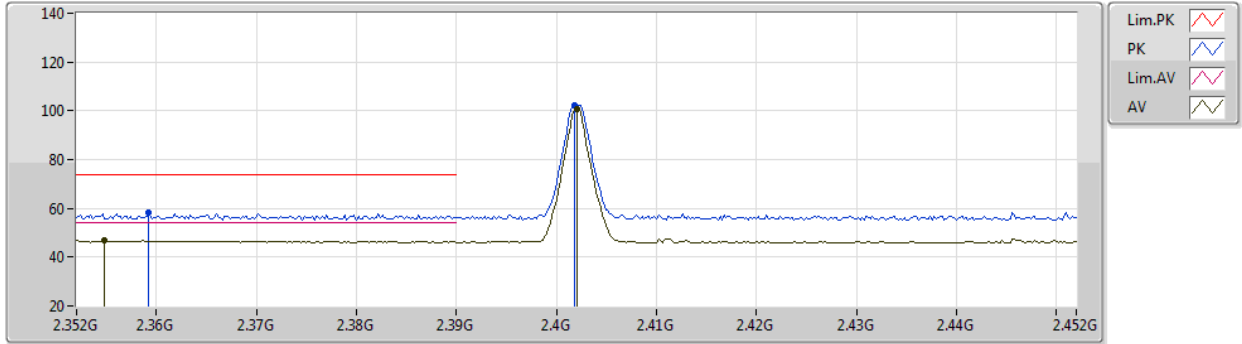

Type	Freq (Hz)	Level (dBuV/m)	Limit (dBuV/m)	Margin (dB)	Factor (dB)	Dist (m)	Condition	Azimuth (°)	Height (m)	Comment	Raw (dBuV)	AF (dB)	CL (dB)	PA (dB)
AV	2.3548G	46.96	54.00	-7.04	33.62	3	Horizontal	101	1.11	-	13.34	27.69	5.93	-
AV	2.402G	100.74	Inf	-Inf	33.55	3	Horizontal	101	1.11	-	67.19	27.59	5.96	-
PK	2.3592G	58.08	74.00	-15.92	33.61	3	Horizontal	101	1.11	-	24.47	27.68	5.93	-
PK	2.4018G	102.23	Inf	-Inf	33.55	3	Horizontal	101	1.11	-	68.68	27.59	5.96	-



BT-LE(1Mbps)

07/07/2020

2402MHz_TX

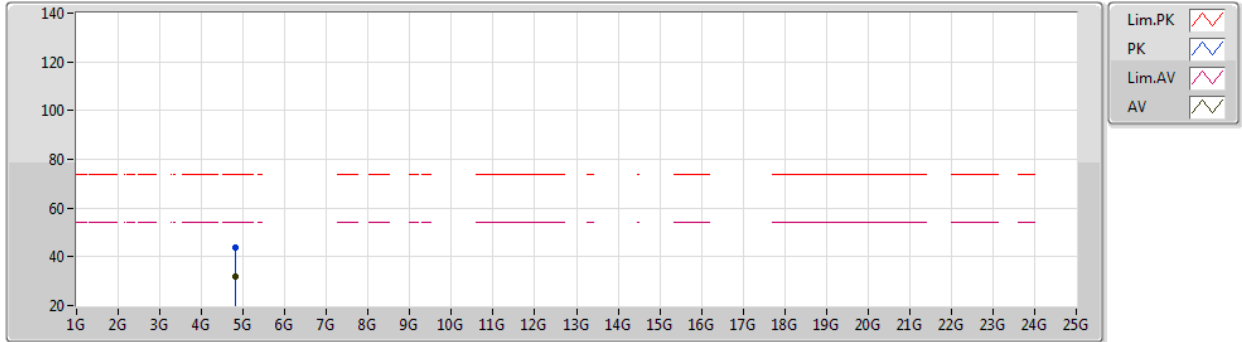

Type	Freq (Hz)	Level (dBuV/m)	Limit (dBuV/m)	Margin (dB)	Factor (dB)	Dist (m)	Condition	Azimuth (°)	Height (m)	Comment	Raw (dBuV)	AF (dB)	CL (dB)	PA (dB)
AV	4.80386G	31.79	54.00	-22.21	5.26	3	Vertical	206	2.62	-	26.53	30.92	8.25	33.91
PK	4.80732G	44.05	74.00	-29.95	5.27	3	Vertical	206	2.62	-	38.78	30.93	8.25	33.91



BT-LE(1Mbps)

07/07/2020

2402MHz_TX

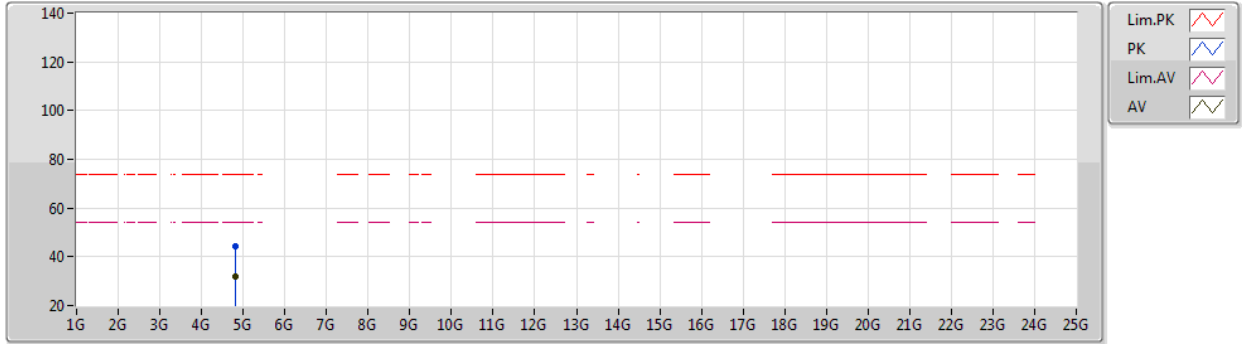

Type	Freq (Hz)	Level (dBuV/m)	Limit (dBuV/m)	Margin (dB)	Factor (dB)	Dist (m)	Condition	Azimuth (°)	Height (m)	Comment	Raw (dBuV)	AF (dB)	CL (dB)	PA (dB)
AV	4.80802G	31.72	54.00	-22.28	5.28	3	Horizontal	299	2.02	-	26.44	30.93	8.26	33.91
PK	4.80888G	44.09	74.00	-29.91	5.29	3	Horizontal	299	2.02	-	38.80	30.94	8.26	33.91

BT-LE(1Mbps)

07/07/2020

2440MHz_TX

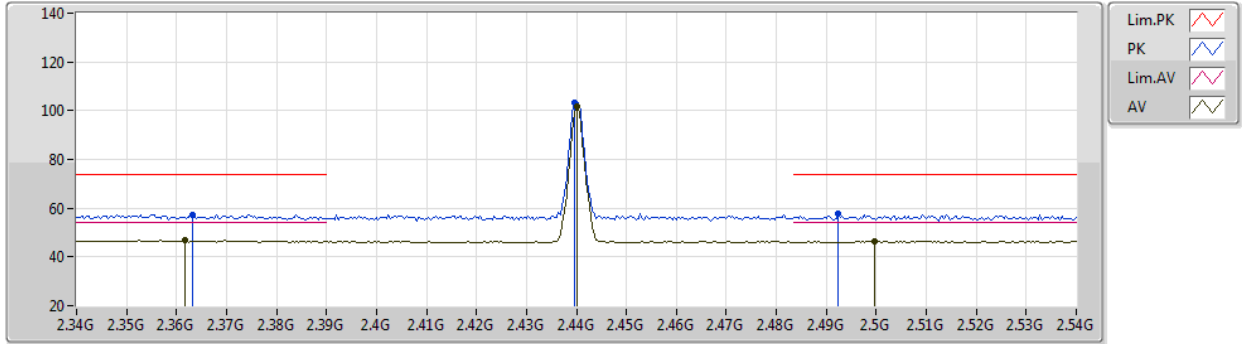

Type	Freq (Hz)	Level (dBuV/m)	Limit (dBuV/m)	Margin (dB)	Factor (dB)	Dist (m)	Condition	Azimuth (°)	Height (m)	Comment	Raw (dBuV)	AF (dB)	CL (dB)	PA (dB)
AV	2.3616G	46.84	54.00	-7.16	33.61	3	Vertical	252	1.79	-	13.23	27.68	5.93	-
AV	2.44G	101.78	Inf	-Inf	33.45	3	Vertical	252	1.79	-	68.33	27.44	6.01	-
AV	2.4996G	46.32	54.00	-7.68	33.48	3	Vertical	252	1.79	-	12.84	27.40	6.08	-
PK	2.3632G	57.42	74.00	-16.58	33.60	3	Vertical	252	1.79	-	23.82	27.67	5.93	-
PK	2.4396G	103.23	Inf	-Inf	33.45	3	Vertical	252	1.79	-	69.78	27.44	6.01	-
PK	2.4924G	57.70	74.00	-16.30	33.47	3	Vertical	252	1.79	-	24.23	27.40	6.07	-

BT-LE(1Mbps)

07/07/2020

2440MHz_TX

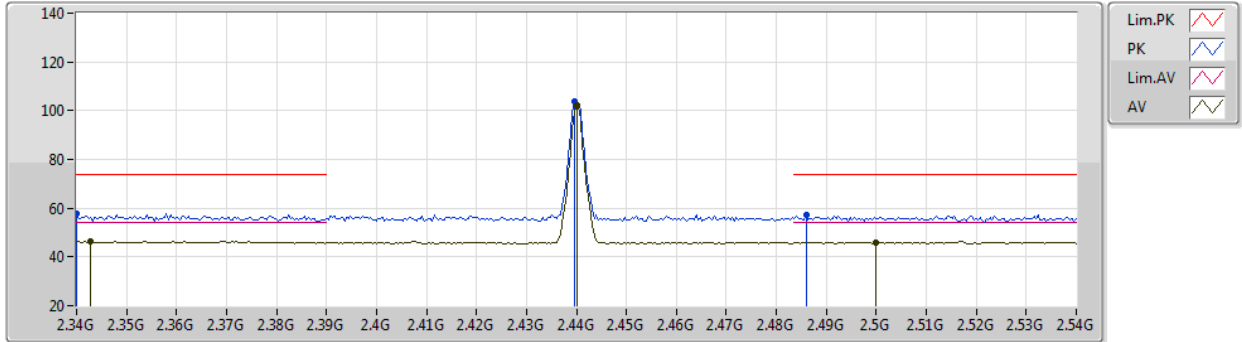

Type	Freq (Hz)	Level (dBuV/m)	Limit (dBuV/m)	Margin (dB)	Factor (dB)	Dist (m)	Condition	Azimuth (°)	Height (m)	Comment	Raw (dBuV)	AF (dB)	CL (dB)	PA (dB)
AV	2.3428G	46.63	54.00	-7.37	33.65	3	Horizontal	92	1.00	-	12.98	27.73	5.92	-
AV	2.44G	102.09	Inf	-Inf	33.45	3	Horizontal	92	1.00	-	68.64	27.44	6.01	-
AV	2.5G	45.98	54.00	-8.02	33.48	3	Horizontal	92	1.00	-	12.50	27.40	6.08	-
PK	2.34G	57.56	74.00	-16.44	33.66	3	Horizontal	92	1.00	-	23.90	27.74	5.92	-
PK	2.4396G	103.54	Inf	-Inf	33.45	3	Horizontal	92	1.00	-	70.09	27.44	6.01	-
PK	2.486G	57.24	74.00	-16.76	33.46	3	Horizontal	92	1.00	-	23.78	27.40	6.06	-



BT-LE(1Mbps)

07/07/2020

2440MHz_TX

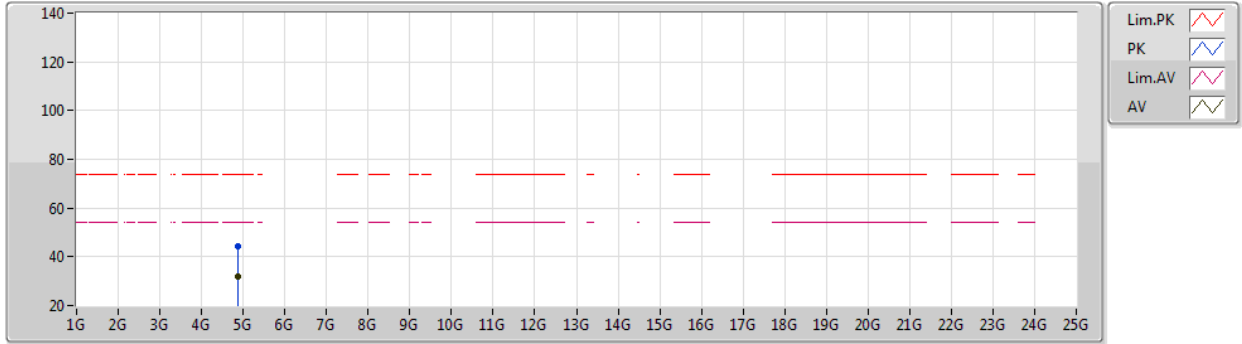

Type	Freq (Hz)	Level (dBuV/m)	Limit (dBuV/m)	Margin (dB)	Factor (dB)	Dist (m)	Condition	Azimuth (°)	Height (m)	Comment	Raw (dBuV)	AF (dB)	CL (dB)	PA (dB)
AV	4.87712G	31.99	54.00	-22.01	5.48	3	Vertical	45	1.65	-	26.51	31.05	8.30	33.87
PK	4.8788G	44.32	74.00	-29.68	5.47	3	Vertical	45	1.65	-	38.85	31.04	8.30	33.87



BT-LE(1Mbps)

07/07/2020

2440MHz_TX

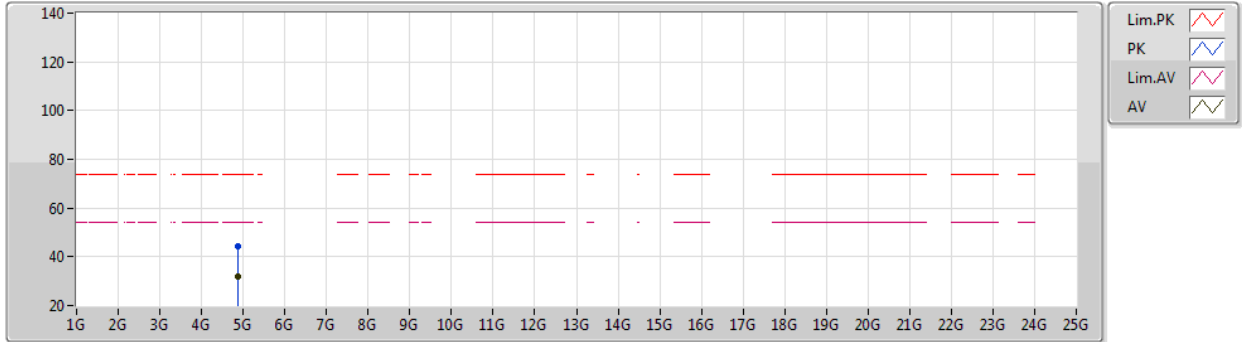

Type	Freq (Hz)	Level (dBuV/m)	Limit (dBuV/m)	Margin (dB)	Factor (dB)	Dist (m)	Condition	Azimuth (°)	Height (m)	Comment	Raw (dBuV)	AF (dB)	CL (dB)	PA (dB)
AV	4.8797G	32.15	54.00	-21.85	5.47	3	Horizontal	243	1.49	-	26.68	31.04	8.30	33.87
PK	4.87938G	44.50	74.00	-29.50	5.47	3	Horizontal	243	1.49	-	39.03	31.04	8.30	33.87

BT-LE(1Mbps)

07/07/2020

2480MHz_TX

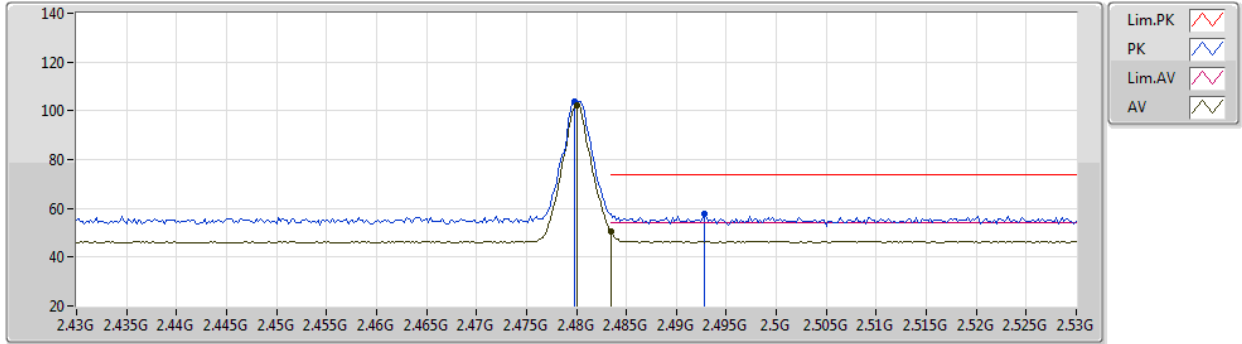

Type	Freq (Hz)	Level (dBuV/m)	Limit (dBuV/m)	Margin (dB)	Factor (dB)	Dist (m)	Condition	Azimuth (°)	Height (m)	Comment	Raw (dBuV)	AF (dB)	CL (dB)	PA (dB)
AV	2.48G	102.49	Inf	-Inf	33.46	3	Vertical	251	1.52	-	69.03	27.40	6.06	-
AV	2.4835G	50.55	54.00	-3.45	33.46	3	Vertical	251	1.52	-	17.09	27.40	6.06	-
PK	2.4798G	103.97	Inf	-Inf	33.46	3	Vertical	251	1.52	-	70.51	27.40	6.06	-
PK	2.4928G	57.89	74.00	-16.11	33.47	3	Vertical	251	1.52	-	24.42	27.40	6.07	-

BT-LE(1Mbps)

07/07/2020

2480MHz_TX

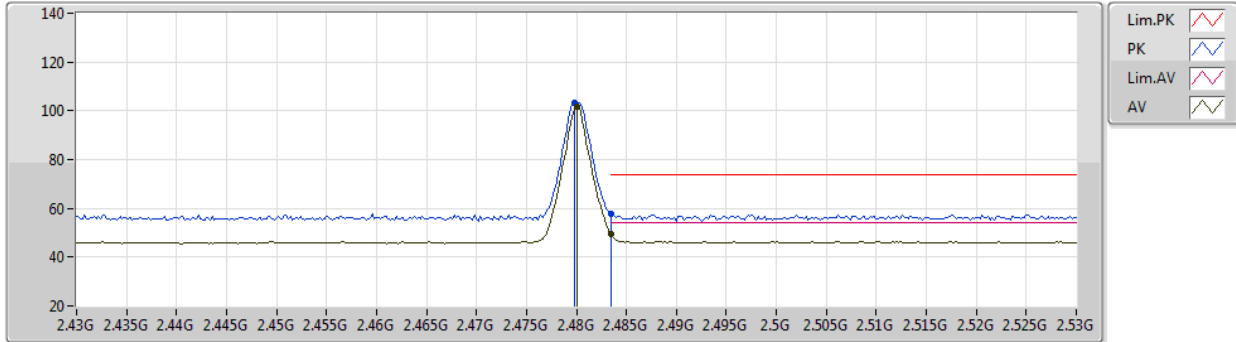

Type	Freq (Hz)	Level (dBuV/m)	Limit (dBuV/m)	Margin (dB)	Factor (dB)	Dist (m)	Condition	Azimuth (°)	Height (m)	Comment	Raw (dBuV)	AF (dB)	CL (dB)	PA (dB)
AV	2.48G	101.56	Inf	-Inf	33.46	3	Horizontal	109	2.87	-	68.10	27.40	6.06	-
AV	2.4835G	49.68	54.00	-4.32	33.46	3	Horizontal	109	2.87	-	16.22	27.40	6.06	-
PK	2.4798G	103.04	Inf	-Inf	33.46	3	Horizontal	109	2.87	-	69.58	27.40	6.06	-
PK	2.4835G	57.59	74.00	-16.41	33.46	3	Horizontal	109	2.87	-	24.13	27.40	6.06	-



BT-LE(1Mbps)

07/07/2020

2480MHz_TX

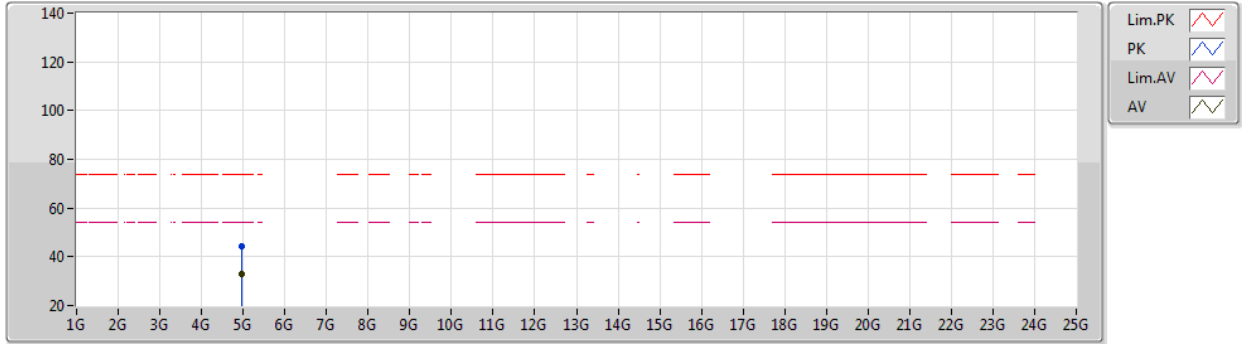

Type	Freq (Hz)	Level (dBuV/m)	Limit (dBuV/m)	Margin (dB)	Factor (dB)	Dist (m)	Condition	Azimuth (°)	Height (m)	Comment	Raw (dBuV)	AF (dB)	CL (dB)	PA (dB)
AV	4.95944G	32.87	54.00	-21.13	5.75	3	Vertical	229	2.87	-	27.12	31.22	8.35	33.82
PK	4.9596G	44.49	74.00	-29.51	5.75	3	Vertical	229	2.87	-	38.74	31.22	8.35	33.82



BT-LE(1Mbps)

07/07/2020

2480MHz_TX

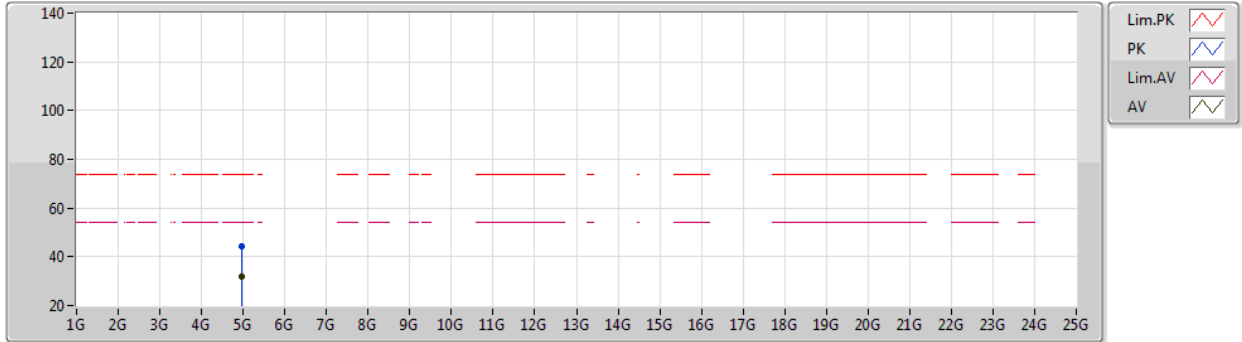

Type	Freq (Hz)	Level (dBuV/m)	Limit (dBuV/m)	Margin (dB)	Factor (dB)	Dist (m)	Condition	Azimuth (°)	Height (m)	Comment	Raw (dBuV)	AF (dB)	CL (dB)	PA (dB)
AV	4.95924G	31.85	54.00	-22.15	5.75	3	Horizontal	130	1.49	-	26.10	31.22	8.35	33.82
PK	4.9594G	44.35	74.00	-29.65	5.75	3	Horizontal	130	1.49	-	38.60	31.22	8.35	33.82

BT-LE(2Mbps)

07/07/2020

2402MHz_TX

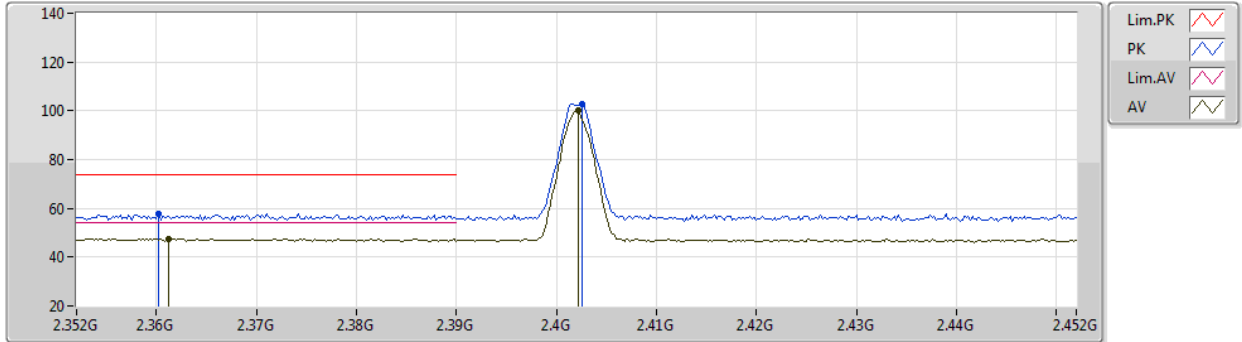

Type	Freq (Hz)	Level (dBuV/m)	Limit (dBuV/m)	Margin (dB)	Factor (dB)	Dist (m)	Condition	Azimuth (°)	Height (m)	Comment	Raw (dBuV)	AF (dB)	CL (dB)	PA (dB)
AV	2.3612G	47.50	54.00	-6.50	33.61	3	Vertical	257	2.11	-	13.89	27.68	5.93	-
AV	2.4022G	99.94	Inf	-Inf	33.55	3	Vertical	257	2.11	-	66.39	27.59	5.96	-
PK	2.3602G	57.67	74.00	-16.33	33.61	3	Vertical	257	2.11	-	24.06	27.68	5.93	-
PK	2.4026G	102.83	Inf	-Inf	33.55	3	Vertical	257	2.11	-	69.28	27.59	5.96	-

BT-LE(2Mbps)

07/07/2020

2402MHz_TX

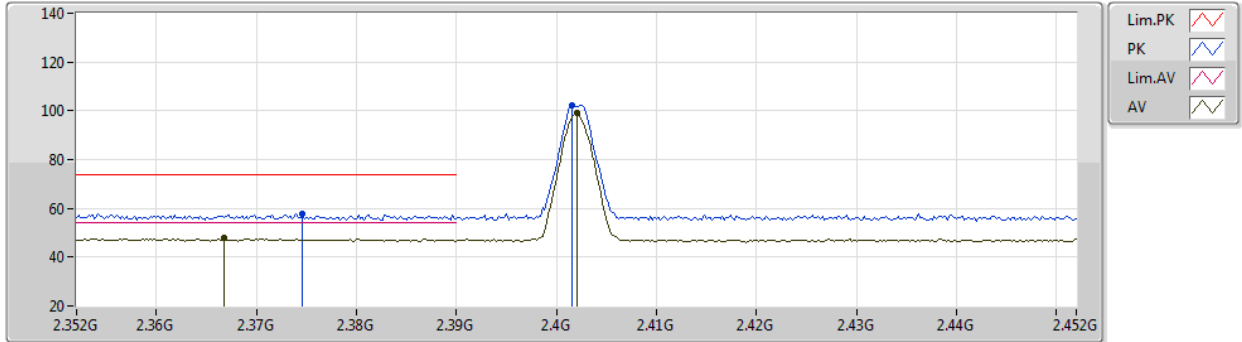

Type	Freq (Hz)	Level (dBuV/m)	Limit (dBuV/m)	Margin (dB)	Factor (dB)	Dist (m)	Condition	Azimuth (°)	Height (m)	Comment	Raw (dBuV)	AF (dB)	CL (dB)	PA (dB)
AV	2.3668G	47.81	54.00	-6.19	33.61	3	Horizontal	91	1.00	-	14.20	27.67	5.94	-
AV	2.402G	99.17	Inf	-Inf	33.55	3	Horizontal	91	1.00	-	65.62	27.59	5.96	-
PK	2.3746G	57.63	74.00	-16.37	33.59	3	Horizontal	91	1.00	-	24.04	27.65	5.94	-
PK	2.4016G	102.15	Inf	-Inf	33.55	3	Horizontal	91	1.00	-	68.60	27.59	5.96	-



BT-LE(2Mbps)

07/07/2020

2402MHz_TX

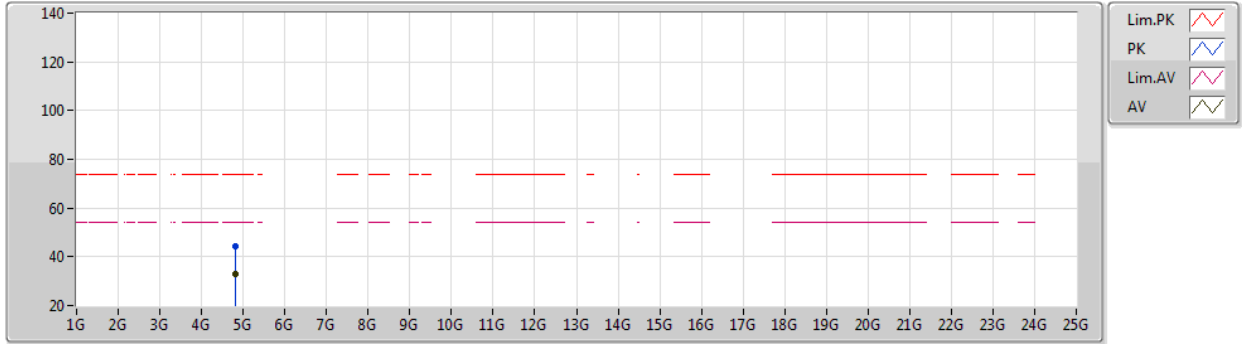

Type	Freq (Hz)	Level (dBuV/m)	Limit (dBuV/m)	Margin (dB)	Factor (dB)	Dist (m)	Condition	Azimuth (°)	Height (m)	Comment	Raw (dBuV)	AF (dB)	CL (dB)	PA (dB)
AV	4.80154G	33.14	54.00	-20.86	5.25	3	Vertical	0	2.74	-	27.89	30.91	8.25	33.91
PK	4.80436G	44.29	74.00	-29.71	5.26	3	Vertical	0	2.74	-	39.03	30.92	8.25	33.91



BT-LE(2Mbps)

07/07/2020

2402MHz_TX

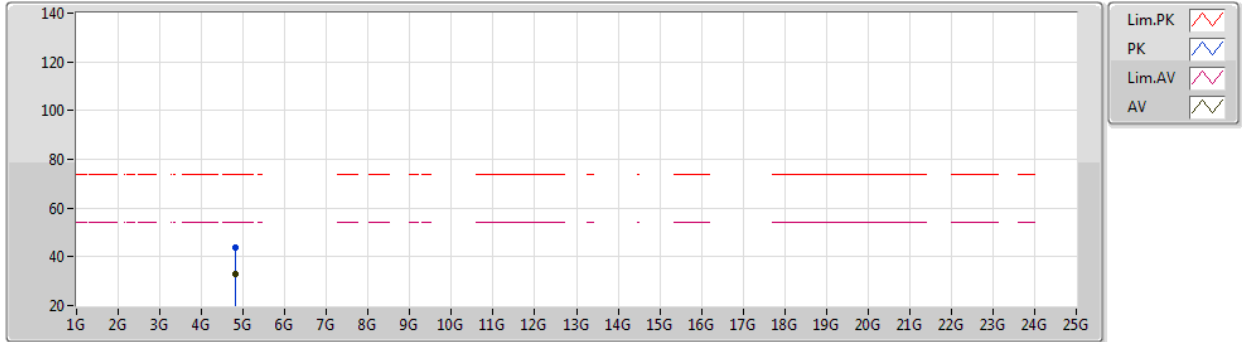

Type	Freq (Hz)	Level (dBuV/m)	Limit (dBuV/m)	Margin (dB)	Factor (dB)	Dist (m)	Condition	Azimuth (°)	Height (m)	Comment	Raw (dBuV)	AF (dB)	CL (dB)	PA (dB)
AV	4.80248G	33.05	54.00	-20.95	5.25	3	Horizontal	159	2.84	-	27.80	30.91	8.25	33.91
PK	4.80104G	43.66	74.00	-30.34	5.24	3	Horizontal	159	2.84	-	38.42	30.90	8.25	33.91

BT-LE(2Mbps)

07/07/2020

2440MHz_TX

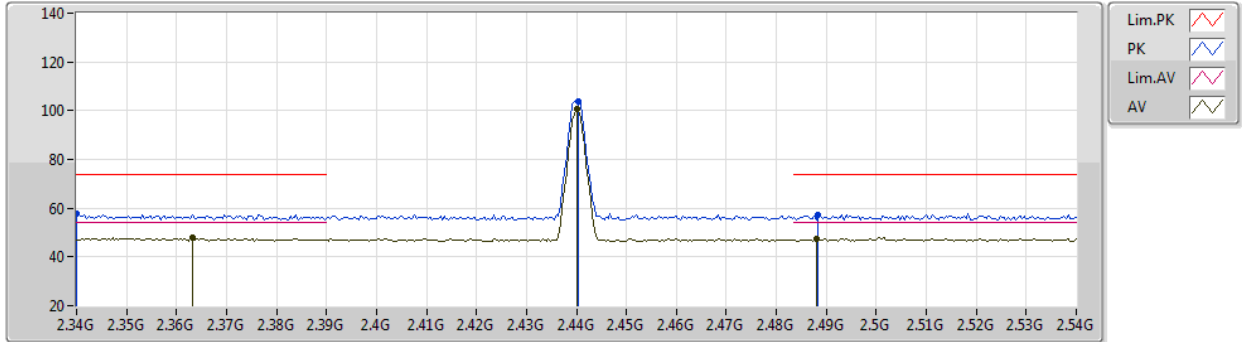

Type	Freq (Hz)	Level (dBuV/m)	Limit (dBuV/m)	Margin (dB)	Factor (dB)	Dist (m)	Condition	Azimuth (°)	Height (m)	Comment	Raw (dBuV)	AF (dB)	CL (dB)	PA (dB)
AV	2.3632G	47.89	54.00	-6.11	33.60	3	Vertical	252	1.81	-	14.29	27.67	5.93	-
AV	2.44G	100.44	Inf	-Inf	33.45	3	Vertical	252	1.81	-	66.99	27.44	6.01	-
AV	2.488G	47.36	54.00	-6.64	33.47	3	Vertical	252	1.81	-	13.89	27.40	6.07	-
PK	2.34G	57.95	74.00	-16.05	33.66	3	Vertical	252	1.81	-	24.29	27.74	5.92	-
PK	2.4404G	103.71	Inf	-Inf	33.45	3	Vertical	252	1.81	-	70.26	27.44	6.01	-
PK	2.4884G	57.31	74.00	-16.69	33.47	3	Vertical	252	1.81	-	23.84	27.40	6.07	-



BT-LE(2Mbps)

07/07/2020

2440MHz_TX

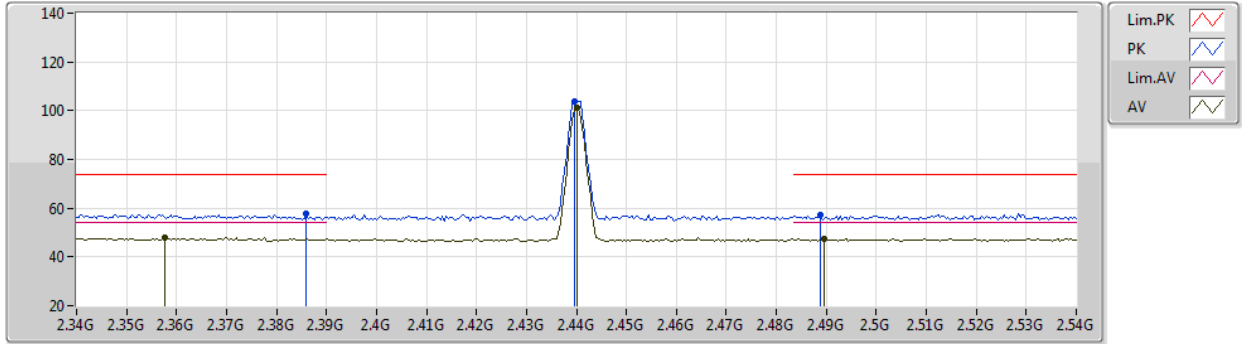

Type	Freq (Hz)	Level (dBuV/m)	Limit (dBuV/m)	Margin (dB)	Factor (dB)	Dist (m)	Condition	Azimuth (°)	Height (m)	Comment	Raw (dBuV)	AF (dB)	CL (dB)	PA (dB)
AV	2.3576G	47.78	54.00	-6.22	33.61	3	Horizontal	99	2.41	-	14.17	27.68	5.93	-
AV	2.44G	100.98	Inf	-Inf	33.45	3	Horizontal	99	2.41	-	67.53	27.44	6.01	-
AV	2.4896G	47.48	54.00	-6.52	33.47	3	Horizontal	99	2.41	-	14.01	27.40	6.07	-
PK	2.386G	58.00	74.00	-16.00	33.58	3	Horizontal	99	2.41	-	24.42	27.63	5.95	-
PK	2.4396G	104.05	Inf	-Inf	33.45	3	Horizontal	99	2.41	-	70.60	27.44	6.01	-
PK	2.4888G	57.38	74.00	-16.62	33.47	3	Horizontal	99	2.41	-	23.91	27.40	6.07	-



BT-LE(2Mbps)

07/07/2020

2440MHz_TX

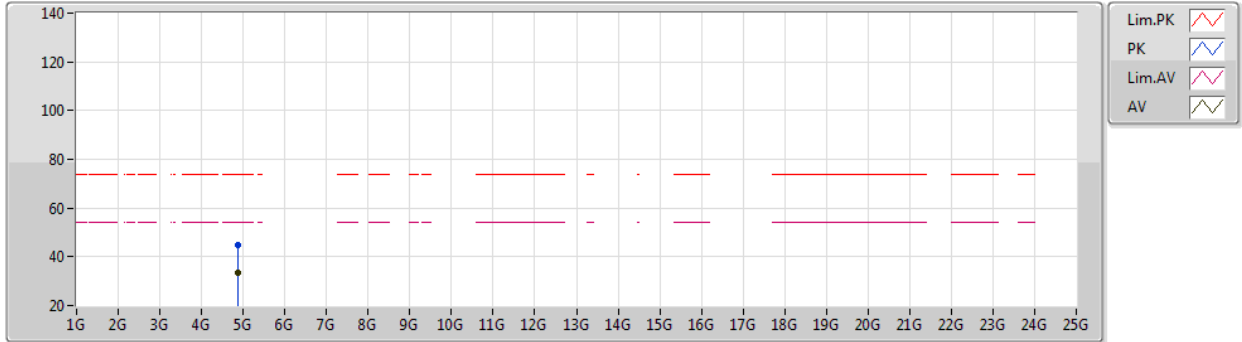

Type	Freq (Hz)	Level (dBuV/m)	Limit (dBuV/m)	Margin (dB)	Factor (dB)	Dist (m)	Condition	Azimuth (°)	Height (m)	Comment	Raw (dBuV)	AF (dB)	CL (dB)	PA (dB)
AV	4.87718G	33.24	54.00	-20.76	5.48	3	Vertical	320	3.00	-	27.76	31.05	8.30	33.87
PK	4.87762G	45.06	74.00	-28.94	5.47	3	Vertical	320	3.00	-	39.59	31.04	8.30	33.87



BT-LE(2Mbps)

07/07/2020

2440MHz_TX

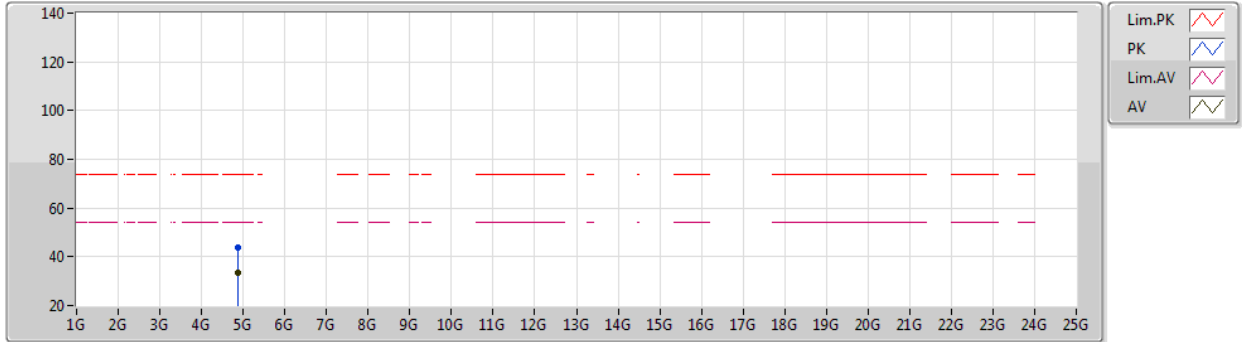

Type	Freq (Hz)	Level (dBuV/m)	Limit (dBuV/m)	Margin (dB)	Factor (dB)	Dist (m)	Condition	Azimuth (°)	Height (m)	Comment	Raw (dBuV)	AF (dB)	CL (dB)	PA (dB)
AV	4.87762G	33.64	54.00	-20.36	5.47	3	Horizontal	183	1.48	-	28.17	31.04	8.30	33.87
PK	4.8773G	43.61	74.00	-30.39	5.48	3	Horizontal	183	1.48	-	38.13	31.05	8.30	33.87

BT-LE(2Mbps)

07/07/2020

2480MHz_TX

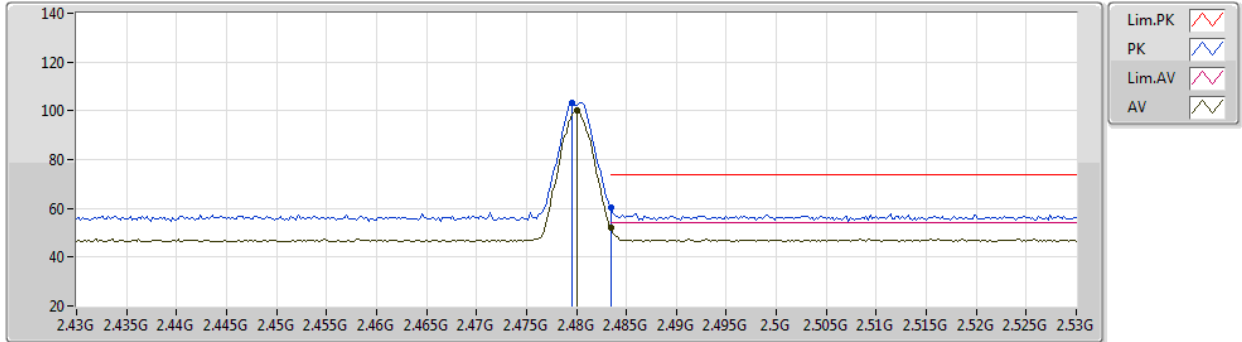

Type	Freq (Hz)	Level (dBuV/m)	Limit (dBuV/m)	Margin (dB)	Factor (dB)	Dist (m)	Condition	Azimuth (°)	Height (m)	Comment	Raw (dBuV)	AF (dB)	CL (dB)	PA (dB)
AV	2.48G	100.18	Inf	-Inf	33.46	3	Vertical	249	2.02	-	66.72	27.40	6.06	-
AV	2.4835G	51.97	54.00	-2.03	33.46	3	Vertical	249	2.02	-	18.51	27.40	6.06	-
PK	2.4796G	103.16	Inf	-Inf	33.46	3	Vertical	249	2.02	-	69.70	27.40	6.06	-
PK	2.4835G	60.11	74.00	-13.89	33.46	3	Vertical	249	2.02	-	26.65	27.40	6.06	-

BT-LE(2Mbps)

07/07/2020

2480MHz_TX

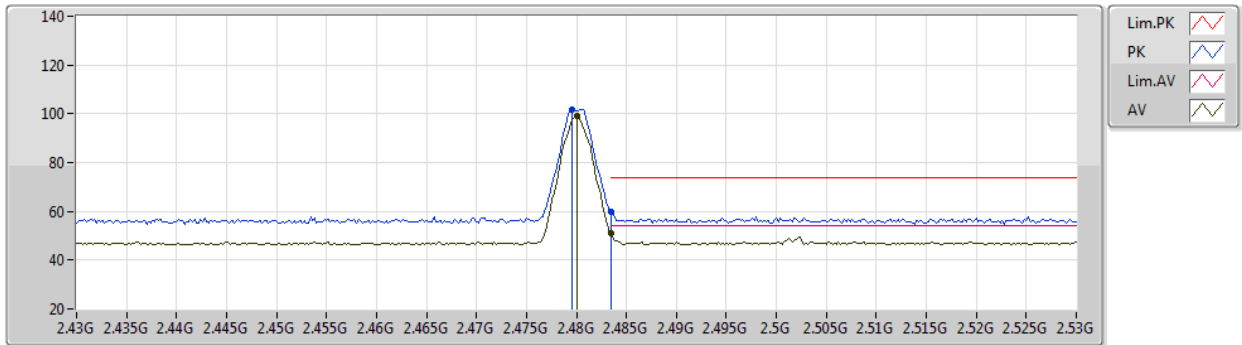

Type	Freq (Hz)	Level (dBuV/m)	Limit (dBuV/m)	Margin (dB)	Factor (dB)	Dist (m)	Condition	Azimuth (°)	Height (m)	Comment	Raw (dBuV)	AF (dB)	CL (dB)	PA (dB)
AV	2.48G	98.94	Inf	-Inf	33.46	3	Horizontal	101	2.87	-	65.48	27.40	6.06	-
AV	2.4835G	51.15	54.00	-2.85	33.46	3	Horizontal	101	2.87	-	17.69	27.40	6.06	-
PK	2.4796G	101.91	Inf	-Inf	33.46	3	Horizontal	101	2.87	-	68.45	27.40	6.06	-
PK	2.4835G	59.69	74.00	-14.31	33.46	3	Horizontal	101	2.87	-	26.23	27.40	6.06	-



BT-LE(2Mbps)

07/07/2020

2480MHz_TX

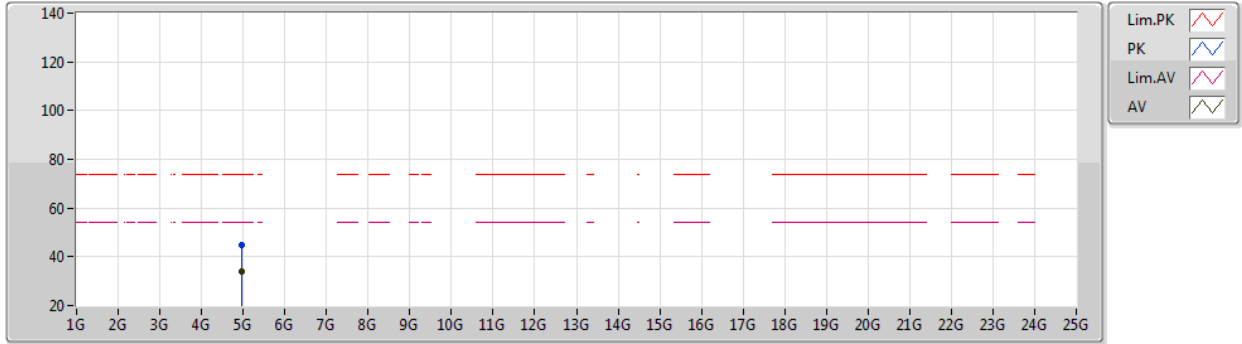

Type	Freq (Hz)	Level (dBuV/m)	Limit (dBuV/m)	Margin (dB)	Factor (dB)	Dist (m)	Condition	Azimuth (°)	Height (m)	Comment	Raw (dBuV)	AF (dB)	CL (dB)	PA (dB)
AV	4.95928G	33.77	54.00	-20.23	5.75	3	Vertical	267	1.26	-	28.02	31.22	8.35	33.82
PK	4.95906G	44.83	74.00	-29.17	5.75	3	Vertical	267	1.26	-	39.08	31.22	8.35	33.82



BT-LE(2Mbps)

07/07/2020

2480MHz_TX

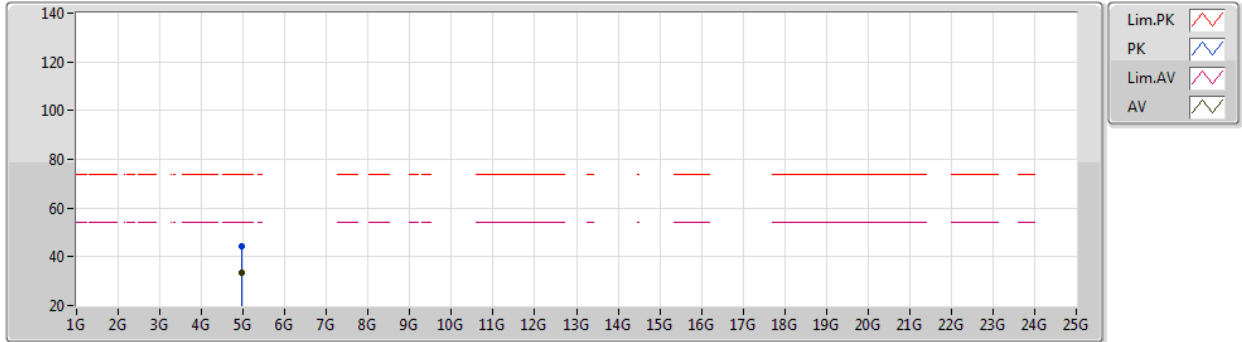

Type	Freq (Hz)	Level (dBuV/m)	Limit (dBuV/m)	Margin (dB)	Factor (dB)	Dist (m)	Condition	Azimuth (°)	Height (m)	Comment	Raw (dBuV)	AF (dB)	CL (dB)	PA (dB)
AV	4.96076G	33.54	54.00	-20.46	5.75	3	Horizontal	51	1.48	-	27.79	31.22	8.35	33.82
PK	4.96248G	44.25	74.00	-29.75	5.76	3	Horizontal	51	1.48	-	38.49	31.22	8.36	33.82