



FCC RADIO TEST REPORT

FCC ID : BKMAE-8111
Equipment : ELPAP11
Brand Name : EPSON
Model Name : WN8111BEP
Applicant : Seiko Epson Corporation
3-3-5 Owa Suwa-shi, Nagano-ken 392-8502 Japan
Manufacturer : Arcadyan Technology Corporation
No.8, Sec.2, Guangfu Rd., Hsinchu, 30071 Taiwan
Standard : 47 CFR FCC Part 15.247

The product was received on Apr. 25, 2019, and testing was started from May 07, 2019 and completed on May 31, 2019. We, SPORTON INTERNATIONAL INC. EMC & Wireless Communications Laboratory, would like to declare that the tested sample has been evaluated in accordance with the procedures given in ANSI C63.10-2013 and shown compliance with the applicable technical standards.

The report must not be used by the client to claim product certification, approval, or endorsement by TAF or any agency of government.

The test results in this report apply exclusively to the tested model / sample. Without written approval of SPORTON INTERNATIONAL INC. EMC & Wireless Communications Laboratory, the test report shall not be reproduced except in full.

Approved by: Cliff Chang

SPORTON INTERNATIONAL INC. EMC & Wireless Communications Laboratory
No. 52, Huaya 1st Rd., Guishan Dist., Taoyuan City, Taiwan (R.O.C.)



Table of Contents

History of this test report.....3

Summary of Test Result.....4

1 General Description5

1.1 Information.....5

1.2 Applicable Standards7

1.3 Testing Location Information.....7

1.4 Measurement Uncertainty7

2 Test Configuration of EUT8

2.1 Test Channel Mode8

2.2 The Worst Case Measurement Configuration.....9

2.3 EUT Operation during Test10

2.4 Accessories10

2.5 Support Equipment.....11

2.6 Test Setup Diagram12

3 Transmitter Test Result15

3.1 AC Power-line Conducted Emissions15

3.2 DTS Bandwidth17

3.3 Maximum Conducted Output Power18

3.4 Power Spectral Density21

3.5 Emissions in Non-restricted Frequency Bands23

3.6 Emissions in Restricted Frequency Bands.....24

4 Test Equipment and Calibration Data28

Appendix A. Test Results of AC Power-line Conducted Emissions

Appendix B. Test Results of DTS Bandwidth

Appendix C. Test Results of Maximum Conducted Output Power

Appendix D. Test Results of Power Spectral Density

Appendix E. Test Results of Emissions in Non-restricted Frequency Bands

Appendix F. Test Results of Emissions in Restricted Frequency Bands

Appendix G. Test Photos

Appendix H. Photographs of EUT



Summary of Test Result

Report Clause	Ref Std. Clause	Test Items	Result (PASS/FAIL)	Remark
1.1.2	15.203	Antenna Requirement	PASS	-
3.1	15.207	AC Power-line Conducted Emissions	PASS	-
3.2	15.247(a)	DTS Bandwidth	PASS	-
3.3	15.247(b)	Maximum Conducted Output Power	PASS	-
3.4	15.247(e)	Power Spectral Density	PASS	-
3.5	15.247(d)	Emissions in Non-restricted Frequency Bands	PASS	-
3.6	15.247(d)	Emissions in Restricted Frequency Bands	PASS	-

Declaration of Conformity:

The test results with all measurement uncertainty excluded are presented in accordance with the regulation limits or requirements declared by manufacturers.

Comments and Explanations:

The declared of product specification for EUT presented in the report are provided by the manufacturer, and the manufacturer takes all the responsibilities for the accuracy of product specification.

Reviewed by: **Sam Chen**
Report Producer: **Sandy Chuang**



1 General Description

1.1 Information

1.1.1 RF General Information

Frequency Range (MHz)	Bluetooth Mode	Ch. Frequency (MHz)	Channel Number
2400-2483.5	LE	2402-2480	0-39 [40]

Band	Mode	BWch (MHz)	Nant
2.4-2.4835GHz	BT-LE	1	1TX

Note:

- ◆ Bluetooth LE uses a GFSK modulation.
- ◆ BWch is the nominal channel bandwidth.
- ◆ Nss-Min is the minimum number of spatial streams.
- ◆ Nant is the number of outputs. e.g., 2(2, 3) means have 2 outputs for port 2 and port 3. 2 means have 2 outputs for port 1 and port 2.



1.1.2 Antenna Information

Ant.	Port	Brand	P/N	Antenna Type	Connector	Gain (dBi)		
						WLAN 2.4GHz	WLAN 5GHz	Bluetooth
1	1	Wieson	GT128HT346C-001	Chip	N/A	0.71	4.64	0.71
2	2	Wieson	GT128HT346C-001	Chip	N/A	1.76	3.33	-

Note1: The above information was declared by manufacturer.

Note2: The EUT has two antennas.

<For 2.4GHz Band>

For IEEE 802.11b/g/n mode(1TX/1RX):

The EUT supports the antenna with TX and RX diversity functions.

Both Port 1 and Port 2 support transmit and receive functions, but only one of them will be used at one time.

The port 1 and port 2 were test for radiated emission test and the worst case was found in port 2. thus, it was selected to test and record for conducted.

<For 5GHz Band>

For IEEE 802.11a/n/ac mode(1TX/1RX):

The EUT supports the antenna with TX and RX diversity functions.

Both Port 1 and Port 2 support transmit and receive functions, but only one of them will be used at one time.

The port 1 and port 2 were test for radiated emission test and the worst case was found in port 1. thus, it was selected to test and record for conducted.

<For Bluetooth>

Only Port 1 can be used as transmitting/receiving antenna.

1.1.3 Mode Test Duty Cycle

Mode	DC	DCF(dB)
BT-LE	0.156	8.07

1.1.4 EUT Operational Condition

EUT Power Type	From host system		
Function	<input checked="" type="checkbox"/> Point-to-multipoint	<input type="checkbox"/> Point-to-point	
Test Software Version	BlueTool(1.9.5.8)		
Support Mode	<input checked="" type="checkbox"/> LE 1M PHY: 1 Mb/s		
	<input type="checkbox"/> LE Coded PHY (S=2): 500 Kb/s		
	<input type="checkbox"/> LE Coded PHY (S=8): 125 Kb/s		
	<input type="checkbox"/> LE 2M PHY: 2 Mb/s		

Note: The above information was declared by manufacturer.



1.2 Applicable Standards

According to the specifications of the manufacturer, the EUT must comply with the requirements of the following standards:

- ◆ 47 CFR FCC Part 15
- ◆ ANSI C63.10-2013
- ◆ FCC KDB 558074 D01 v05r02

1.3 Testing Location Information

Testing Location		
<input type="checkbox"/>	HWA YA	ADD : No. 52, Huaya 1st Rd., Guishan Dist., Taoyuan City, Taiwan (R.O.C.) TEL : 886-3-327-3456 FAX : 886-3-327-0973
<input checked="" type="checkbox"/>	JHUBEI	ADD : No.8, Lane 724, Bo-ai St., Jhubei City, HsinChu County 302, Taiwan, R.O.C. TEL : 886-3-656-9065 FAX : 886-3-656-9085

Test Condition	Test Site No.	Test Engineer	Test Environment	Test Date
RF Conducted	TH01-CB	Ekko Heieh	21~24°C / 50~59%	May 07, 2019~ May 31, 2019
Radiated (Below 1GHz)	03CH03-CB	Cola Fan	25~27°C / 55~65%	May 20, 2019~ May 25, 2019
Radiated (Above 1GHz)	03CH06-CB	Brian Sun	22~24°C / 50~60%	May 07, 2019~ May 31, 2019
AC Conduction	CO02-CB	GN Hou	22.1~23.8°C / 61~63%	May 22, 2019

Test site Designation No. TW0006 with FCC.

Test site registered number IC 4086B with Industry Canada.

1.4 Measurement Uncertainty

ISO/IEC 17025 requires that an estimate of the measurement uncertainties associated with the emissions test results be included in the report. The measurement uncertainties given below are based on a 95% confidence level (based on a coverage factor (k=2))

Test Items	Uncertainty	Remark
Conducted Emission (150kHz ~ 30MHz)	2.0 dB	Confidence levels of 95%
Radiated Emission (30MHz ~ 1,000MHz)	4.3 dB	Confidence levels of 95%
Radiated Emission (1GHz ~ 18GHz)	3.9 dB	Confidence levels of 95%
Radiated Emission (18GHz ~ 40GHz)	4.7 dB	Confidence levels of 95%
Conducted Emission	1.3 dB	Confidence levels of 95%
Output Power Measurement	1.3 dB	Confidence levels of 95%
Power Density Measurement	1.3 dB	Confidence levels of 95%
Bandwidth Measurement	9.74 x10 ⁻⁸	Confidence levels of 95%



2 Test Configuration of EUT

2.1 Test Channel Mode

Mode	PowerSetting
BT-LE_Nss1_1TX	-
2402MHz	Default
2440MHz	Default
2480MHz	Default



2.2 The Worst Case Measurement Configuration

The Worst Case Mode for Following Conformance Tests	
Tests Item	AC power-line conducted emissions
Condition	AC power-line conducted measurement for line and neutral
Operating Mode	Normal Link
1	2.4GHz + Bluetooth
2	5GHz + Bluetooth
For operating mode 2 is the worst case and it was record in this test report.	

The Worst Case Mode for Following Conformance Tests	
Tests Item	DTS Bandwidth Maximum Conducted Output Power Power Spectral Density Emissions in Non-restricted Frequency Bands
Test Condition	Conducted measurement at transmit chains

The Worst Case Mode for Following Conformance Tests	
Tests Item	Emissions in Restricted Frequency Bands
Test Condition	Radiated measurement If EUT consist of multiple antenna assembly (multiple antenna are used in EUT regardless of spatial multiplexing MIMO configuration), the radiated test should be performed with highest antenna gain of each antenna type.
Operating Mode < 1GHz	Normal Link
1	Place EUT in Z axis + 2.4GHz + Bluetooth
2	Place EUT in Z axis + 5GHz + Bluetooth
Mode 1 has been evaluated to be the worst case among Mode 1~2, thus measurement for Mode 3 will follow this same test mode.	
3	Place EUT in Y axis + 2.4GHz + Bluetooth
For operating mode 2 is the worst case and it was record in this test report.	
Operating Mode > 1GHz	CTX
The EUT was performed at X axis, Y axis and Z axis position. The worst case was found at Z axis, thus the measurement will follow this same test configuration.	



2.3 EUT Operation during Test

For CTX Mode:

The EUT was programmed to be in continuously transmitting mode.

For Normal Link:

During the test, the EUT operation to normal function.

2.4 Accessories

N/A



2.5 Support Equipment

For AC Conduction:

Support Equipment				
No.	Equipment	Brand Name	Model Name	FCC ID
A	PC	SAIVIA	SGH8190LP1	N/A
B	LCD Monitor	DELL	E1913C	N/A
C	Printer	EPSON	LQ-300+	N/A
D	Modem	ACEEX	DM1414	N/A
E	Keyboard	iCooky	SK068	N/A
F	Mouse	Logitech	Logitech	N/A
G	2.4/5G AP	ASUS	RP-N53	MSQ-RPN53
H	Bluetooth Speaker	MARUS	MSK06C-RD	N/A

For Radiated (below 1GHz):

Support Equipment				
No.	Equipment	Brand Name	Model Name	FCC ID
A	Notebook	Acer	Z5WBH	N/A
B	Bluetooth Speaker	MARUS	MSK06C-RD	N/A
C	WLAN AP	Netgear	R8000	N/A
D	Earphone	SHYARO CHI	MIC-04	N/A
E	Mouse	Logitech	M-U0026	N/A
F	Notebook	DELL	E4300	N/A

For Radiated (above 1GHz):

Support Equipment				
No.	Equipment	Brand Name	Model Name	FCC ID
A	Notebook	Acer	Z5WBH	N/A

For RF Conducted:

Support Equipment				
No.	Equipment	Brand Name	Model Name	FCC ID
A	Notebook	Acer	Z5WBH	N/A

2.6 Test Setup Diagram

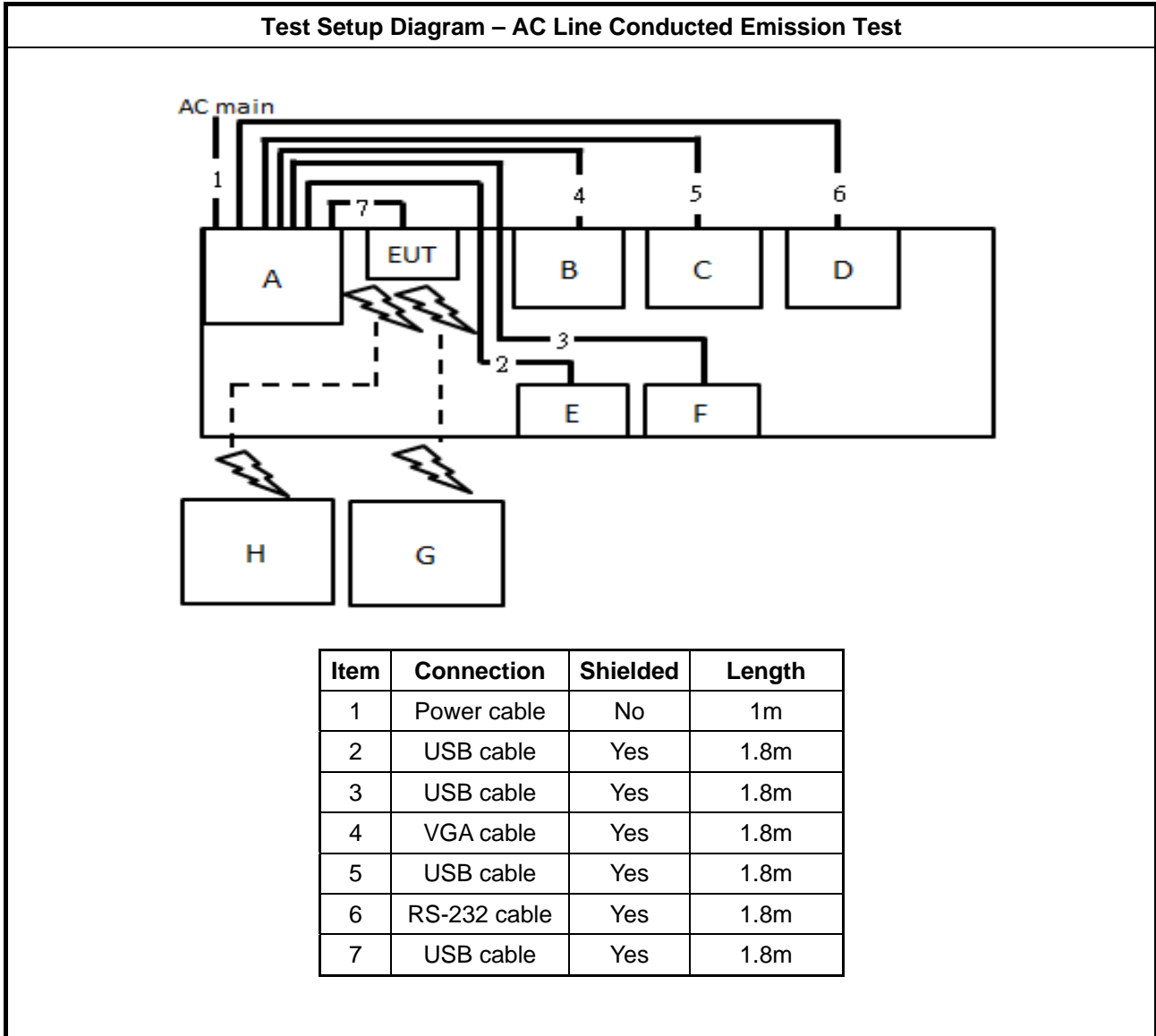

Test Setup Diagram - Radiated Test < 1GHz

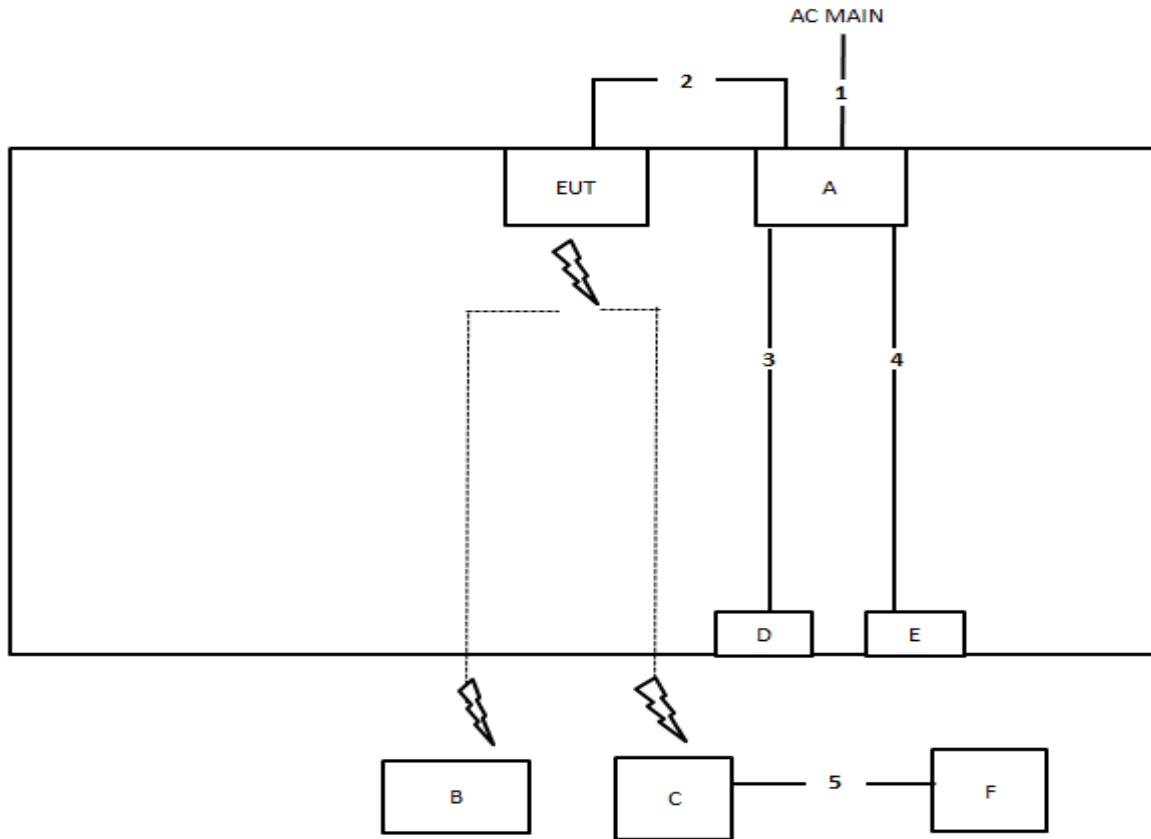

Item	Connection	Shielded	Length
1	Power cable	No	1.8m
2	USB cable	Yes	1.0m
3	Audio cable	No	1.1m
4	USB cable	Yes	1.8m
5	RJ-45 cable	No	1.5m



Test Setup Diagram - Radiated Test > 1GHz

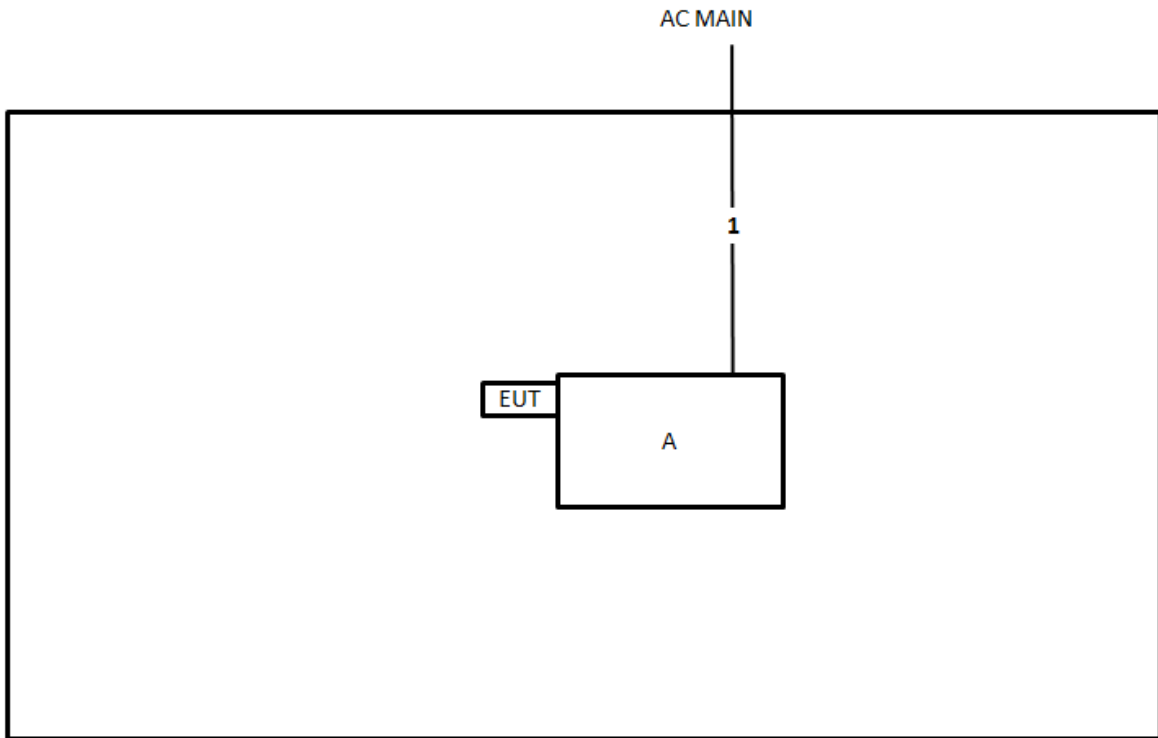

Item	Connection	Shielded	Length
1	Power cable	No	2.6m



3 Transmitter Test Result

3.1 AC Power-line Conducted Emissions

3.1.1 AC Power-line Conducted Emissions Limit

AC Power-line Conducted Emissions Limit		
Frequency Emission (MHz)	Quasi-Peak	Average
0.15-0.5	66 - 56 *	56 - 46 *
0.5-5	56	46
5-30	60	50

Note 1: * Decreases with the logarithm of the frequency.

3.1.2 Measuring Instruments

Refer a test equipment and calibration data table in this test report.

3.1.3 Test Procedures

Test Method
▪ Refer as ANSI C63.10-2013 , clause 6.2 for AC power-line conducted emissions.

3.1.4 Test Setup

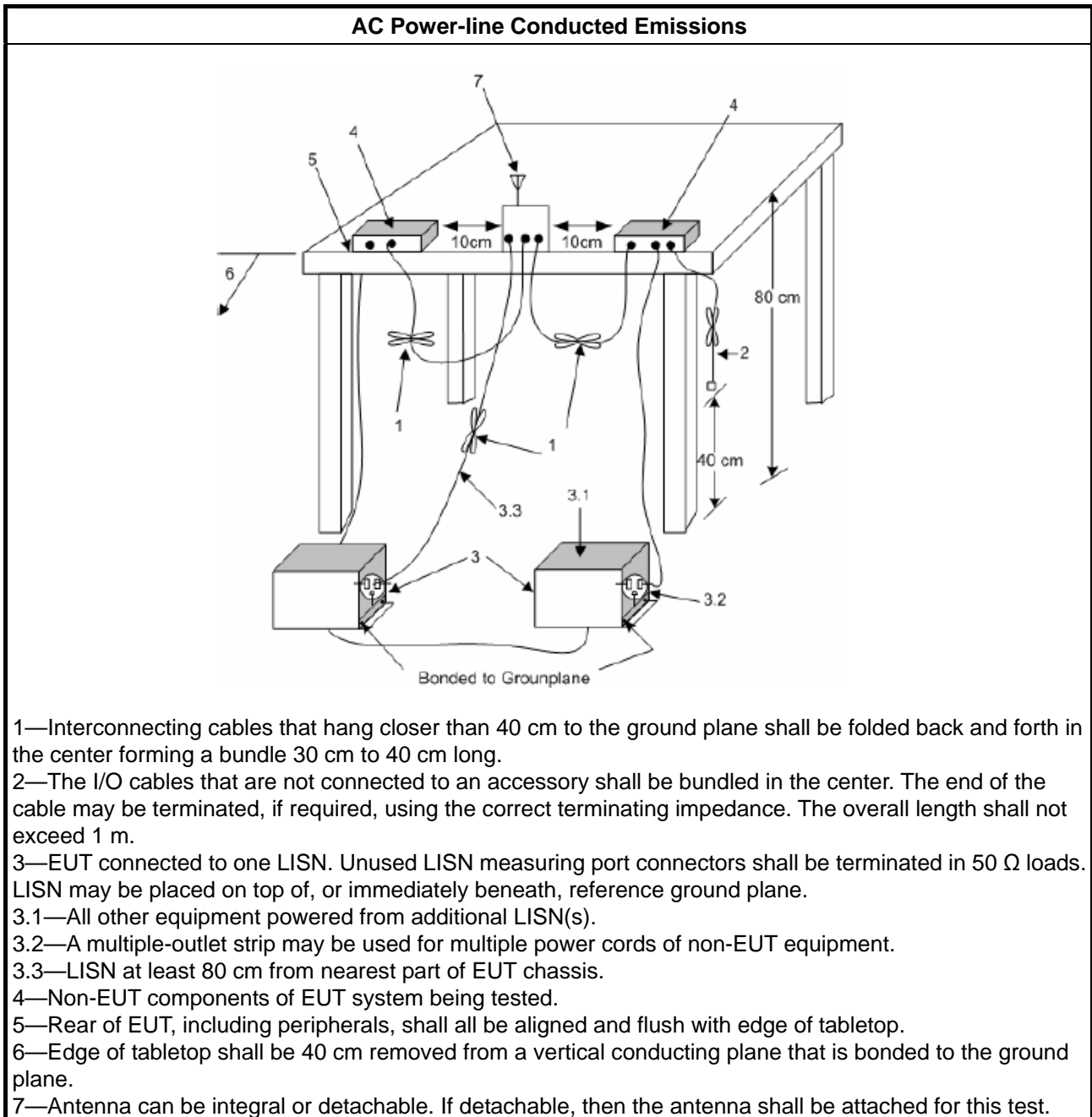

3.1.5 Test Result of AC Power-line Conducted Emissions

Refer as Appendix A

3.2 DTS Bandwidth

3.2.1 6dB Bandwidth Limit

6dB Bandwidth Limit
Systems using digital modulation techniques:
<ul style="list-style-type: none"> ▪ 6 dB bandwidth \geq 500 kHz.

3.2.2 Measuring Instruments

Refer a test equipment and calibration data table in this test report.

3.2.3 Test Procedures

Test Method
<ul style="list-style-type: none"> ▪ For the emission bandwidth shall be measured using one of the options below:
<input checked="" type="checkbox"/> Refer as FCC KDB 558074, clause 8.2 & C63.10 clause 11.8.1 Option 1 for 6 dB bandwidth measurement.
<input type="checkbox"/> Refer as FCC KDB 558074, clause 8.2 & C63.10 clause 11.8.2 Option 2 for 6 dB bandwidth measurement.
<input type="checkbox"/> Refer as ANSI C63.10, clause 6.9.1 for occupied bandwidth testing.

3.2.4 Test Setup

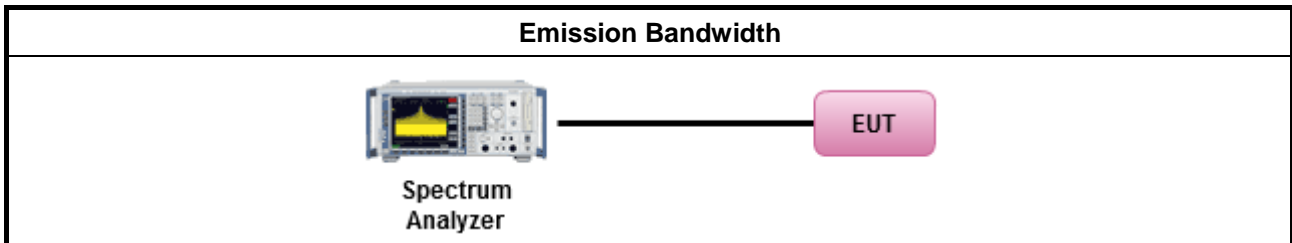

3.2.5 Test Result of Emission Bandwidth

Refer as Appendix B



3.3 Maximum Conducted Output Power

3.3.1 Maximum Conducted Output Power Limit

Maximum Conducted Output Power Limit	
	<ul style="list-style-type: none"> ▪ If $G_{TX} \leq 6$ dBi, then $P_{Out} \leq 30$ dBm (1 W)
	<ul style="list-style-type: none"> ▪ Point-to-multipoint systems (P2M): If $G_{TX} > 6$ dBi, then $P_{Out} = 30 - (G_{TX} - 6)$ dBm
	<ul style="list-style-type: none"> ▪ Point-to-point systems (P2P): If $G_{TX} > 6$ dBi, then $P_{Out} = 30 - (G_{TX} - 6)/3$ dBm
	<ul style="list-style-type: none"> ▪ Smart antenna system (SAS):
	<ul style="list-style-type: none"> - Single beam: If $G_{TX} > 6$ dBi, then $P_{Out} = 30 - (G_{TX} - 6)/3$ dBm
	<ul style="list-style-type: none"> - Overlap beam: If $G_{TX} > 6$ dBi, then $P_{Out} = 30 - (G_{TX} - 6)/3$ dBm
	<ul style="list-style-type: none"> - Aggregate power on all beams: If $G_{TX} > 6$ dBi, then $P_{Out} = 30 - (G_{TX} - 6)/3 + 8$ dB dBm
<p>P_{Out} = maximum peak conducted output power or maximum conducted output power in dBm, G_{TX} = the maximum transmitting antenna directional gain in dBi.</p>	

3.3.2 Measuring Instruments

Refer a test equipment and calibration data table in this test report.



3.3.3 Test Procedures

Test Method	
<ul style="list-style-type: none"> ▪ Maximum Peak Conducted Output Power 	
<input type="checkbox"/>	Refer as FCC KDB 558074, clause 8.3.1.1 & C63.10 clause 11.9.1.1 (RBW ≥ EBW method).
<input type="checkbox"/>	Refer as FCC KDB 558074, clause 8.3.1.3 & C63.10 clause 11.9.1.3 (peak power meter).
<ul style="list-style-type: none"> ▪ Maximum Conducted Output Power 	
[duty cycle ≥ 98% or external video / power trigger]	
<input type="checkbox"/>	Refer as FCC KDB 558074, clause 8.3.2.2 & C63.10 clause 11.9.2.2.2 Method AVGSA-1.
<input type="checkbox"/>	Refer as FCC KDB 558074, clause 8.3.2.2 & C63.10 clause 11.9.2.2.3 Method AVGSA-1A. (alternative)
duty cycle < 98% and average over on/off periods with duty factor	
<input type="checkbox"/>	Refer as FCC KDB 558074, clause 8.3.2.2 & C63.10 clause 11.9.2.2.4 Method AVGSA-2.
<input type="checkbox"/>	Refer as FCC KDB 558074, clause 8.3.2.2 & C63.10 clause 11.9.2.2.5 Method AVGSA-2A (alternative)
<input type="checkbox"/>	Refer as FCC KDB 558074, clause 8.3.2.2 & C63.10 clause 11.9.2.2.6 Method AVGSA-3
<input type="checkbox"/>	Refer as FCC KDB 558074, clause 8.3.2.2 & C63.10 clause 11.9.2.2.7 Method AVGSA-3A (alternative)
Measurement using a power meter (PM)	
<input checked="" type="checkbox"/>	Refer as FCC KDB 558074, clause 8.3.2.3 & C63.10 clause 11.9.2.3.1 Method AVGPM (using an RF average power meter).
<input type="checkbox"/>	Refer as FCC KDB 558074, clause 8.3.2.3 & C63.10 clause 11.9.2.3.2 Method AVGPM-G (using an gate RF average power meter).
<ul style="list-style-type: none"> ▪ For conducted measurement. 	
<ul style="list-style-type: none"> ▪ If the EUT supports multiple transmit chains using options given below: Refer as FCC KDB 662911, In-band power measurements. Using the measure-and-sum approach, measured all transmit ports individually. Sum the power (in linear power units e.g., mW) of all ports for each individual sample and save them. 	
<ul style="list-style-type: none"> ▪ If multiple transmit chains, EIRP calculation could be following as methods: $P_{total} = P_1 + P_2 + \dots + P_n$ (calculated in linear unit [mW] and transfer to log unit [dBm]) $EIRP_{total} = P_{total} + DG$ 	

3.3.4 Test Setup

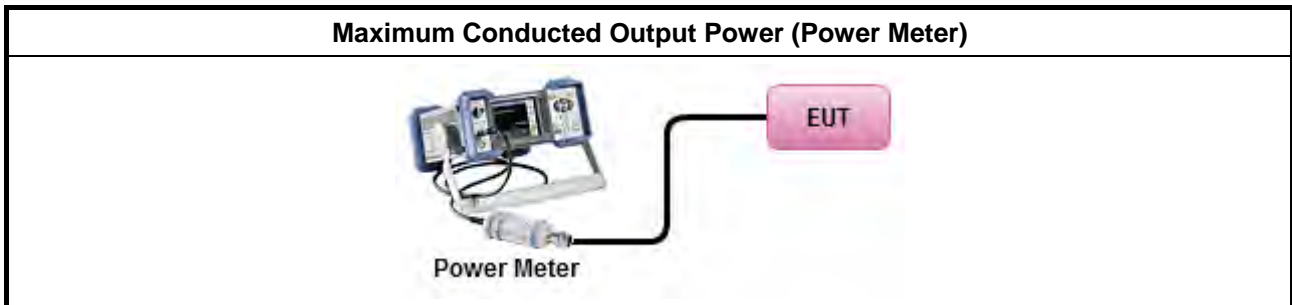

3.3.5 Test Result of Maximum Conducted Output Power

Refer as Appendix C



3.4 Power Spectral Density

3.4.1 Power Spectral Density Limit

Power Spectral Density Limit
<ul style="list-style-type: none"> Power Spectral Density (PSD) ≤ 8 dBm/3kHz

3.4.2 Measuring Instruments

Refer a test equipment and calibration data table in this test report.

3.4.3 Test Procedures

Test Method
<ul style="list-style-type: none"> Peak power spectral density procedures that the same method as used to determine the conducted output power. If maximum peak conducted output power was measured to demonstrate compliance to the output power limit, then the peak PSD procedure below (Method PKPSD) shall be used. If maximum conducted output power was measured to demonstrate compliance to the output power limit, then one of the average PSD procedures shall be used, as applicable based on the following criteria (the peak PSD procedure is also an acceptable option).
<input checked="" type="checkbox"/> Refer as FCC KDB 558074, clause 8.4 & C63.10 clause 11.10.2 Method PKPSD. [duty cycle ≥ 98% or external video / power trigger]
<input type="checkbox"/> Refer as FCC KDB 558074, clause 8.4 & C63.10 clause 11.10.3 Method AVGPSD-1.
<input type="checkbox"/> Refer as FCC KDB 558074, clause 8.4 & C63.10 clause 11.10.5 Method AVGPSD-2.
<input type="checkbox"/> Refer as FCC KDB 558074, clause 8.4 & C63.10 clause 11.10.7 Method AVGPSD-3. duty cycle < 98% and average over on/off periods with duty factor
<input type="checkbox"/> Refer as FCC KDB 558074, clause 8.4 & C63.10 clause 11.10.4 Method AVGPSD-1A. (alternative).
<input type="checkbox"/> Refer as FCC KDB 558074, clause 8.4 & C63.10 clause 11.10.6 Method AVGPSD-2A. (alternative)
<input type="checkbox"/> Refer as FCC KDB 558074, clause 8.4 & C63.10 clause 11.10.8 Method AVGPSD-3A. (alternative)
<ul style="list-style-type: none"> For conducted measurement. <ul style="list-style-type: none"> If The EUT supports multiple transmit chains using options given below: <ul style="list-style-type: none"> <input checked="" type="checkbox"/> Option 1: Measure and sum the spectra across the outputs. Refer as FCC KDB 662911, In-band power spectral density (PSD). Sample all transmit ports simultaneously using a spectrum analyzer for each transmit port. Where the trace bin-by-bin of each transmit port summing can be performed. (i.e., in the first spectral bin of output 1 is summed with that in the first spectral bin of output 2 and that from the first spectral bin of output 3, and so on up to the NTX output to obtain the value for the first frequency bin of the summed spectrum.). Add up the amplitude (power) values for the different transmit chains and use this as the new data trace. <input type="checkbox"/> Option 2: Measure and sum spectral maxima across the outputs. With this technique, spectra are measured at each output of the device at the required resolution bandwidth. The maximum value (peak) of each spectrum is determined. These maximum values are then summed mathematically in linear power units across the outputs. These operations shall be performed separately over frequency spans that have different out-of-band or spurious emission limits,



Option 3: Measure and add $10 \log(N)$ dB, where N is the number of transmit chains. Refer as FCC KDB 662911, In-band power spectral density (PSD). Performed at each transmit chains and each transmit chains shall be compared with the limit have been reduced with $10 \log(N)$. Or each transmit chains shall be add $10 \log(N)$ to compared with the limit.

3.4.4 Test Setup

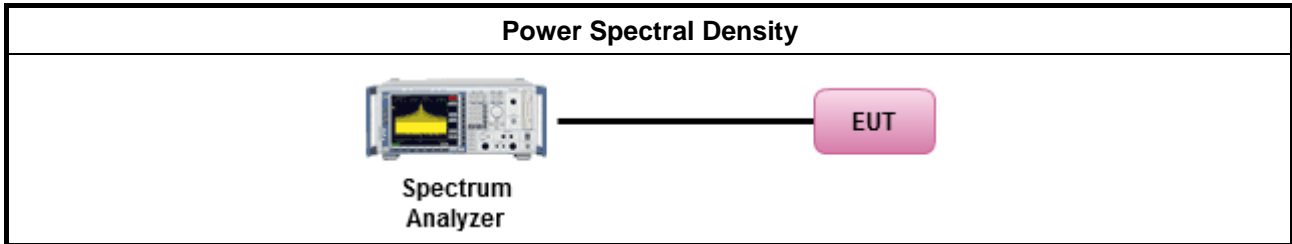

3.4.5 Test Result of Power Spectral Density

Refer as Appendix D

3.5 Emissions in Non-restricted Frequency Bands

3.5.1 Emissions in Non-restricted Frequency Bands Limit

Un-restricted Band Emissions Limit	
RF output power procedure	Limit (dBc)
Peak output power procedure	20
Average output power procedure	30

Note 1: If the peak output power procedure is used to measure the fundamental emission power to demonstrate compliance to requirements, then the peak conducted output power measured within any 100 kHz outside the authorized frequency band shall be attenuated by at least 20 dB relative to the maximum measured in-band peak PSD level.

Note 2: If the average output power procedure is used to measure the fundamental emission power to demonstrate compliance to requirements, then the power in any 100 kHz outside of the authorized frequency band shall be attenuated by at least 30 dB relative to the maximum measured in-band average PSD level.

3.5.2 Measuring Instruments

Refer a test equipment and calibration data table in this test report.

3.5.3 Test Procedures

Test Method
<ul style="list-style-type: none"> Refer as FCC KDB 558074, clause 8.5 for unwanted emissions into non-restricted bands.

3.5.4 Test Setup

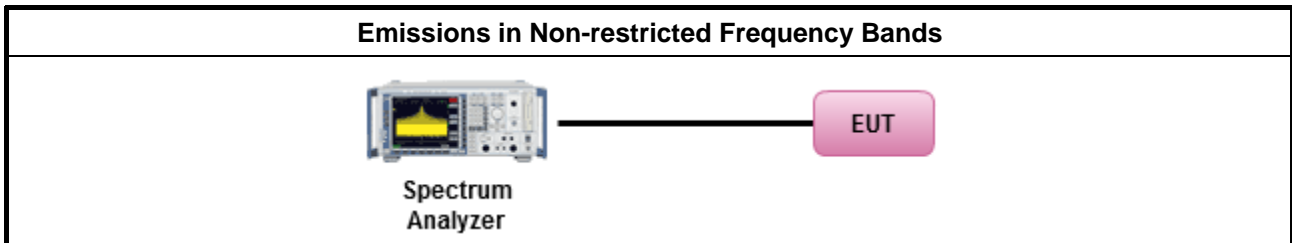

3.5.5 Test Result of Emissions in Non-restricted Frequency Bands

Refer as Appendix E



3.6 Emissions in Restricted Frequency Bands

3.6.1 Emissions in Restricted Frequency Bands Limit

Restricted Band Emissions Limit			
Frequency Range (MHz)	Field Strength (uV/m)	Field Strength (dBuV/m)	Measure Distance (m)
0.009~0.490	2400/F(kHz)	48.5 - 13.8	300
0.490~1.705	24000/F(kHz)	33.8 - 23	30
1.705~30.0	30	29	30
30~88	100	40	3
88~216	150	43.5	3
216~960	200	46	3
Above 960	500	54	3

Note 1: Test distance for frequencies at or above 30 MHz, measurements may be performed at a distance other than the limit distance provided they are not performed in the near field and the emissions to be measured can be detected by the measurement equipment. When performing measurements at a distance other than that specified, the results shall be extrapolated to the specified distance using an extrapolation factor of 20 dB/decade (inverse of linear distance for field-strength measurements, inverse of linear distance-squared for power-density measurements).

Note 2: Test distance for frequencies at below 30 MHz, measurements may be performed at a distance closer than the EUT limit distance; however, an attempt should be made to avoid making measurements in the near field. When performing measurements below 30 MHz at a closer distance than the limit distance, the results shall be extrapolated to the specified distance by either making measurements at a minimum of two or more distances on at least one radial to determine the proper extrapolation factor or by using the square of an inverse linear distance extrapolation factor (40 dB / decade). The test report shall specify the extrapolation method used to determine compliance of the EUT.

Note 3: Using the distance of 1m during the test for above 18 GHz, and the test value to correct for the distance factor at 3m.

3.6.2 Measuring Instruments

Refer a test equipment and calibration data table in this test report.



3.6.3 Test Procedures

Test Method	
<ul style="list-style-type: none"> ▪ The average emission levels shall be measured in [duty cycle \geq 98 or duty factor]. 	
<ul style="list-style-type: none"> ▪ Refer as ANSI C63.10, clause 6.10.3 band-edge testing shall be performed at the lowest frequency channel and highest frequency channel within the allowed operating band. 	
<ul style="list-style-type: none"> ▪ For the transmitter unwanted emissions shall be measured using following options below: 	
	<ul style="list-style-type: none"> ▪ Refer as FCC KDB 558074, clause 8.6 for unwanted emissions into restricted bands.
	<input type="checkbox"/> Refer as FCC KDB 558074, clause 8.6 & C63.10 clause 11.12.2.5.1(trace averaging for duty cycle \geq 98%).
	<input type="checkbox"/> Refer as FCC KDB 558074, clause 8.6 & C63.10 clause 11.12.2.5.2(trace averaging + duty factor).
	<input checked="" type="checkbox"/> Refer as FCC KDB 558074, clause 8.6 & C63.10 clause 11.12.2.5.3(Reduced VBW \geq 1/T).
	<input type="checkbox"/> Refer as ANSI C63.10, clause 11.12.2.5.3 (Reduced VBW). VBW \geq 1/T, where T is pulse time.
	<input type="checkbox"/> Refer as ANSI C63.10, clause 7.5 average value of pulsed emissions.
	<input checked="" type="checkbox"/> Refer as FCC KDB 558074, clause 8.6 & C63.10 clause 11.12.2.4 measurement procedure peak limit.
<ul style="list-style-type: none"> ▪ For the transmitter band-edge emissions shall be measured using following options below: 	
	<ul style="list-style-type: none"> ▪ Refer as FCC KDB 558074 clause 8.7 & c63.10 clause 11.13.1, When the performing peak or average radiated measurements, emissions within 2 MHz of the authorized band edge may be measured using the marker-delta method described below.
	<ul style="list-style-type: none"> ▪ Refer as FCC KDB 558074, clause 8.7 (ANSI C63.10, clause 6.10.6) for marker-delta method for band-edge measurements.
	<ul style="list-style-type: none"> ▪ Refer as FCC KDB 558074, clause 8.7 for narrower resolution bandwidth (100kHz) using the band power and summing the spectral levels (i.e., 1 MHz).
	<ul style="list-style-type: none"> ▪ For conducted unwanted emissions into restricted bands (absolute emission limits). Devices with multiple transmit chains using options given below: (1) Measure and sum the spectra across the outputs or (2) Measure and add 10 log(N) dB
	<ul style="list-style-type: none"> ▪ For FCC KDB 662911 The methodology described here may overestimate array gain, thereby resulting in apparent failures to satisfy the out-of-band limits even if the device is actually compliant. In such cases, compliance may be demonstrated by performing radiated tests around the frequencies at which the apparent failures occurred.

3.6.4 Test Setup

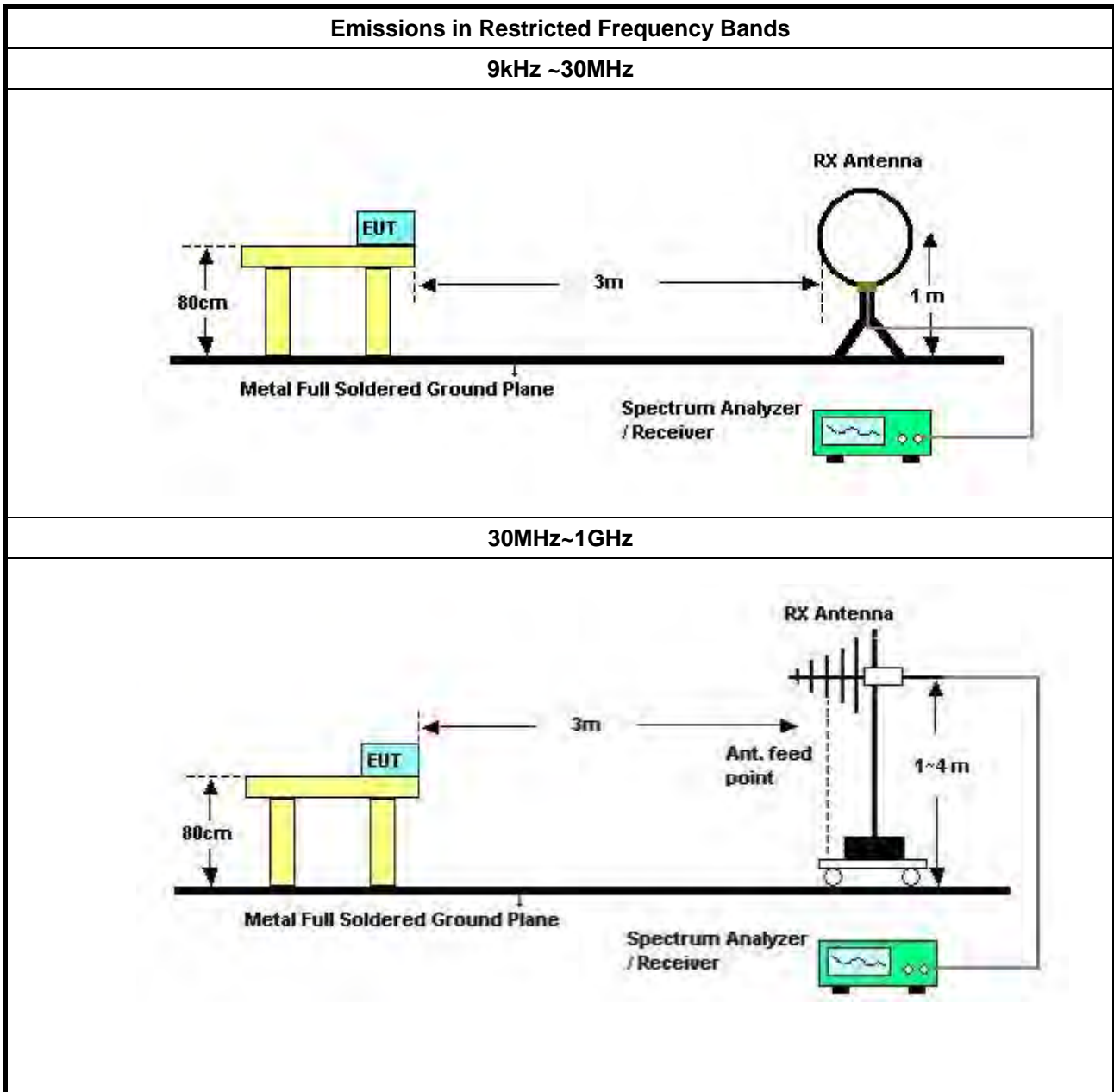

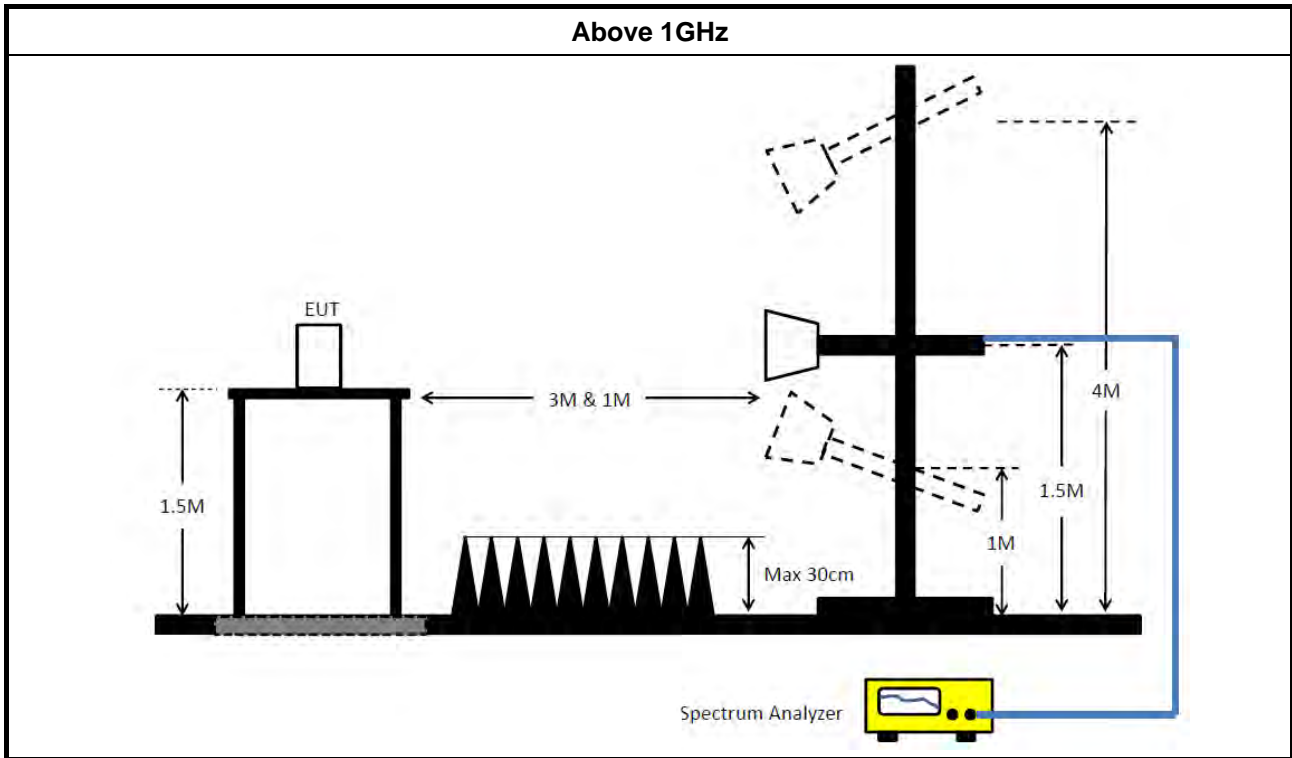

3.6.5 Measurement Results Calculation

The measured Level is calculated using:

Corrected Reading: Antenna Factor + Cable Loss + Read Level - Preamp Factor = Level.

3.6.6 Emissions in Restricted Frequency Bands (Below 30MHz)

All amplitude of spurious emissions that are attenuated by more than 20 dB below the permissible value has no need to be reported.

The radiated emissions were investigated from 9 kHz or the lowest frequency generated within the device, up to the 10 harmonic or 40 GHz, whichever is appropriate.

3.6.7 Test Result of Emissions in Restricted Frequency Bands

Refer as Appendix F



4 Test Equipment and Calibration Data

Instrument	Manufacturer	Model No.	Serial No.	Characteristics	Calibration Date	Calibration Due Date	Remark
LISN	Schwarzbeck	NSLK 8127	8127650	9kHz ~ 30MHz	Nov. 21, 2018	Nov. 20, 2019	Conduction (CO02-CB)
LISN	Schwarzbeck	NSLK 8127	8127478	9kHz ~ 30MHz	Nov. 05, 2018	Nov. 04, 2019	Conduction (CO02-CB)
EMI Receiver	Agilent	N9038A	MY52260140	9kHz ~ 8.4GHz	Jan. 16, 2019	Jan. 15, 2020	Conduction (CO02-CB)
COND Cable	Woken	Cable	2	0.15MHz ~ 30MHz	Nov. 06, 2018	Nov. 05, 2019	Conduction (CO02-CB)
Software	Audix	E3	6.120210n	-	N.C.R.	N.C.R.	Conduction (CO02-CB)
Loop Antenna	Teseq	HLA 6120	24155	9kHz - 30 MHz	Mar. 29, 2019	Mar. 28, 2020	Radiation (03CH03-CB)
Bilog Antenna	Schaffner	CBL6112B & N-6-06	2928 & AT-N0607	20MHz ~ 2GHz	Jan. 02, 2019	Jan. 01, 2020	Radiation (03CH03-CB)
Pre-Amplifier	Agilent	8447D	2944A10259	9kHz ~ 1.3GHz	Jan. 16, 2019	Jan. 15, 2020	Radiation (03CH03-CB)
Spectrum Analyzer	R&S	FSP40	100056	9kHz ~ 40GHz	Jan. 31, 2019	Jan. 30, 2020	Radiation (03CH03-CB)
EMI Test Receiver	R&S	ESCS	100359	9kHz ~ 2.75GHz	Jul. 03, 2018	Jul. 02, 2019	Radiation (03CH03-CB)
Low Cable	Woken	RG402	Low Cable-02+27	25MHz ~ 1GHz	Oct. 08, 2018	Oct. 07, 2019	Radiation (03CH03-CB)
Horn Antenna	SCHWARZBECK	BBHA9120D	9120D-1292	1GHz~18GHz	Jul. 20, 2018	Jul. 19, 2019	Radiation (03CH06-CB)
Horn Antenna	Schwarzbeck	BBHA 9170	BBHA9170252	15GHz ~ 40GHz	Jun. 28, 2018	Jun. 27, 2019	Radiation (03CH06-CB)
Pre-Amplifier	Agilent	8449B	3008A02310	1GHz ~ 26.5GHz	Jan. 08, 2019	Jan. 07, 2020	Radiation (03CH06-CB)
Pre-Amplifier	MITEQ	TTA1840-35-HG	1864479	18GHz ~ 40GHz	Jul. 04, 2018	Jul. 03, 2019	Radiation (03CH06-CB)
Spectrum analyzer	R&S	FSP40	100080	9kHz~40GHz	Oct. 03, 2018	Oct. 02, 2019	Radiation (03CH06-CB)
RF Cable	HUBER+SUHNER	RG402	High Cable-05	1GHz~18GHz	Oct. 08, 2018	Oct. 07, 2019	Radiation (03CH06-CB)
RF Cable	HUBER+SUHNER	RG402	High Cable-05+24	1GHz~18GHz	Oct. 08, 2018	Oct. 07, 2019	Radiation (03CH06-CB)



Instrument	Manufacturer	Model No.	Serial No.	Characteristics	Calibration Date	Calibration Due Date	Remark
RF Cable-high	Woken	High Cable-40G#1	N/A	18GHz ~ 40 GHz	Jul. 27, 2018	Jul. 26, 2019	Radiation (03CH06-CB)
RF Cable-high	Woken	High Cable-40G#2	N/A	18GHz ~ 40 GHz	Jul. 27, 2018	Jul. 26, 2019	Radiation (03CH06-CB)
Spectrum analyzer	R&S	FSV40	100979	9kHz~40GHz	Feb. 25, 2019	Feb. 24, 2020	Conducted (TH01-CB)
RF Cable-high	Woken	RG402	High Cable-06	1 GHz – 26.5 GHz	Oct. 08, 2018	Oct. 07, 2019	Conducted (TH01-CB)
RF Cable-high	Woken	RG402	High Cable-07	1 GHz –26.5 GHz	Oct. 08, 2018	Oct. 07, 2019	Conducted (TH01-CB)
RF Cable-high	Woken	RG402	High Cable-08	1 GHz –26.5 GHz	Oct. 08, 2018	Oct. 07, 2019	Conducted (TH01-CB)
RF Cable-high	Woken	RG402	High Cable-09	1 GHz –26.5 GHz	Oct. 08, 2018	Oct. 07, 2019	Conducted (TH01-CB)
RF Cable-high	Woken	RG402	High Cable-10	1 GHz –26.5 GHz	Oct. 08, 2018	Oct. 07, 2019	Conducted (TH01-CB)
RF Cable-high	Woken	RG402	High Cable-28	1 GHz –26.5 GHz	Nov. 19, 2018	Nov. 18, 2019	Conducted (TH01-CB)
Power Sensor	Agilent	E9327A	US40442088	50MHz~18GHz	Jan. 15, 2019	Jan. 14, 2020	Conducted (TH01-CB)
Power Meter	Agilent	E4416A	GB41291199	50MHz~18GHz	Jan. 15, 2019	Jan. 14, 2020	Conducted (TH01-CB)

Note: Calibration Interval of instruments listed above is one year.

NCR means Non-Calibration required.



AC Power-line Conducted Emissions Result

Appendix A

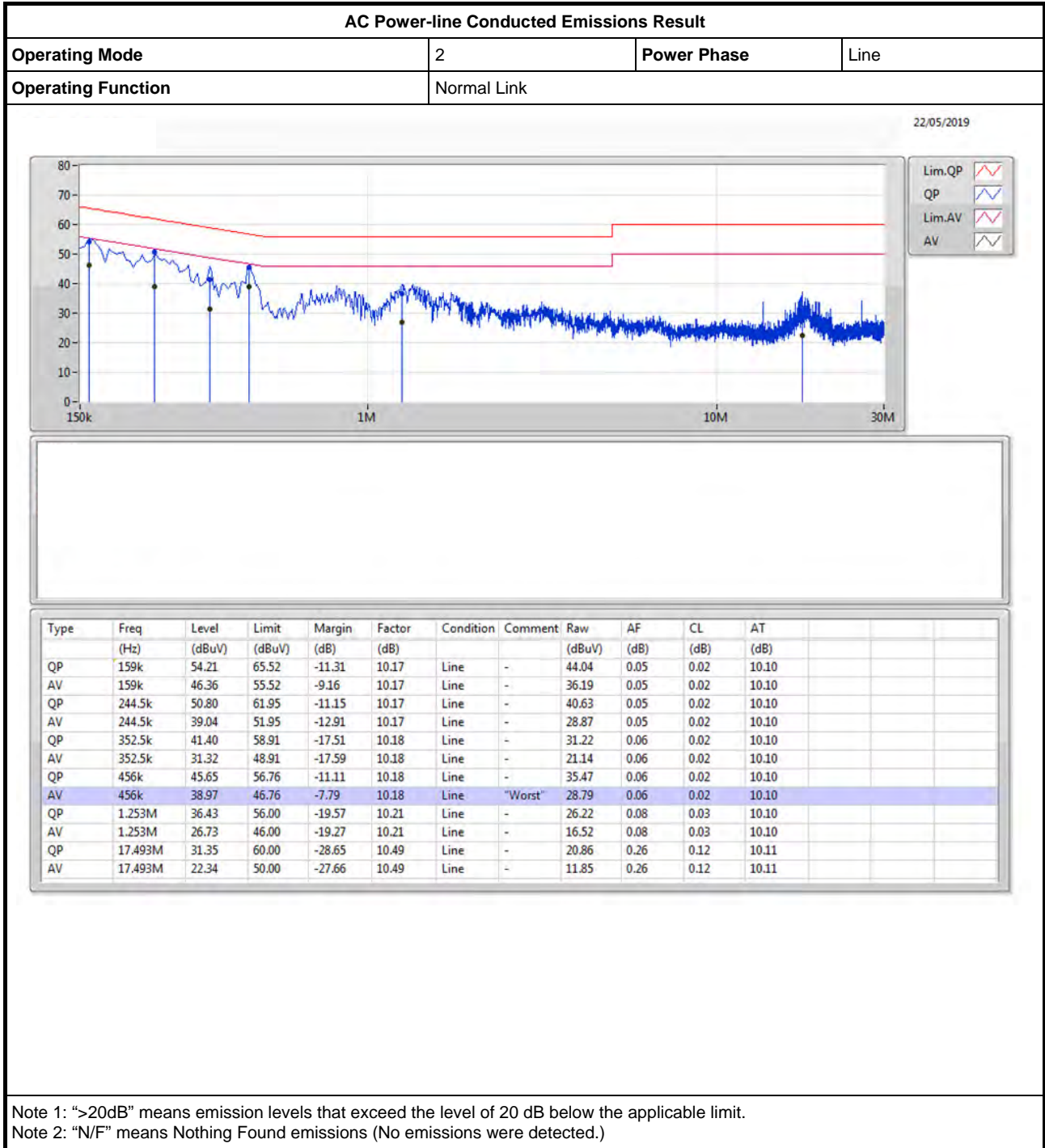



AC Power-line Conducted Emissions Result

Appendix A

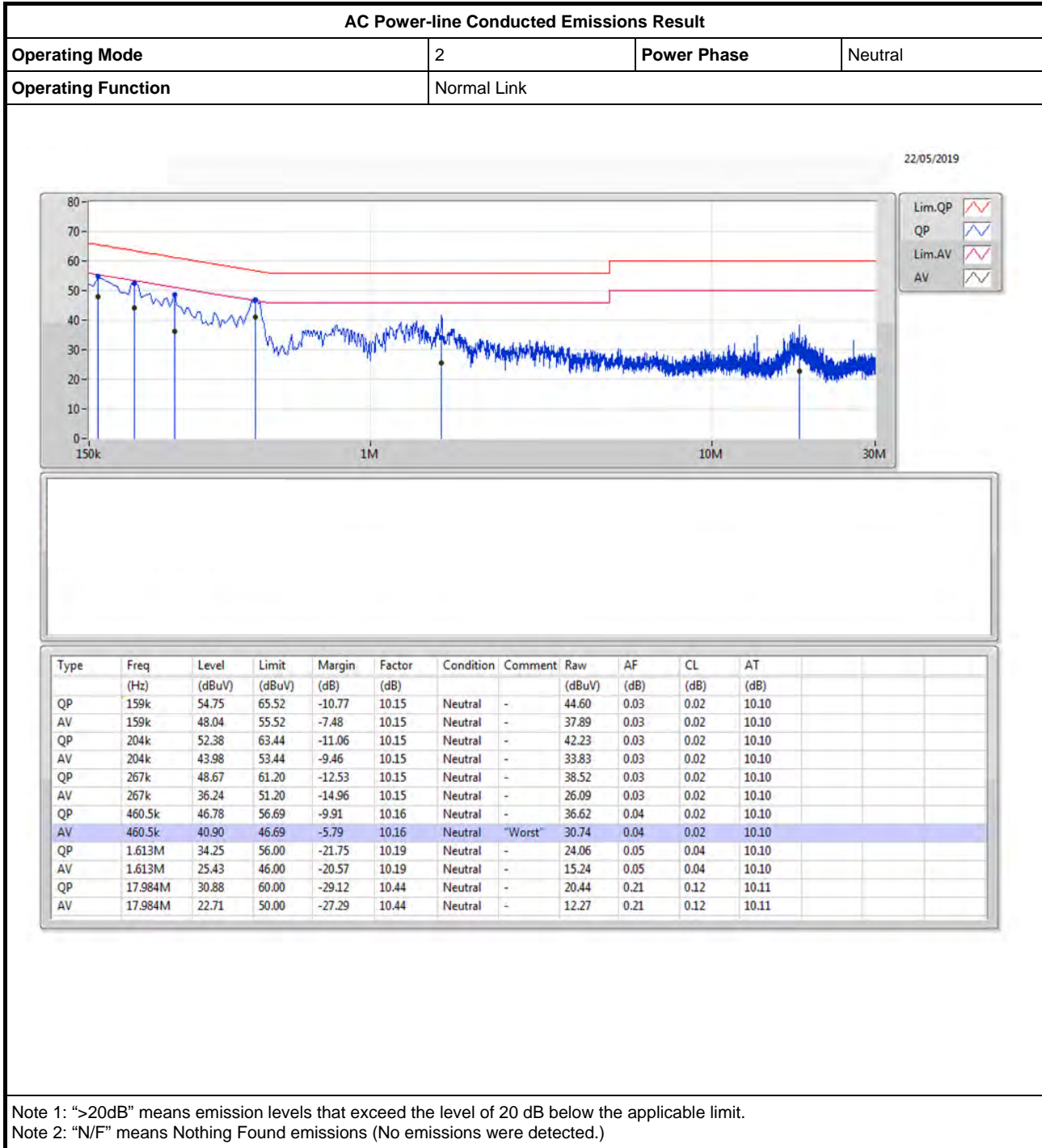



Summary

Mode	Max-N dB (Hz)	Max-OBW (Hz)	ITU-Code	Min-N dB (Hz)	Min-OBW (Hz)
2.4-2.4835GHz	-	-	-	-	-
BT-LE_Nss1_1TX	716.25k	1.049M	1M05F1D	712.5k	1.047M

Max-N dB = Maximum 6dB down bandwidth; Max-OBW = Maximum 99% occupied bandwidth;
Min-N dB = Minimum 6dB down bandwidth; Min-OBW = Minimum 99% occupied bandwidth;

Result

Mode	Result	Limit (Hz)	Port 1-N dB (Hz)	Port 1-OBW (Hz)
BT-LE_Nss1_1TX	-	-	-	-
2402MHz	Pass	500k	712.5k	1.047M
2440MHz	Pass	500k	713.75k	1.049M
2480MHz	Pass	500k	716.25k	1.049M

Port X-N dB = Port X 6dB down bandwidth; Port X-OBW = Port X 99% occupied bandwidth;

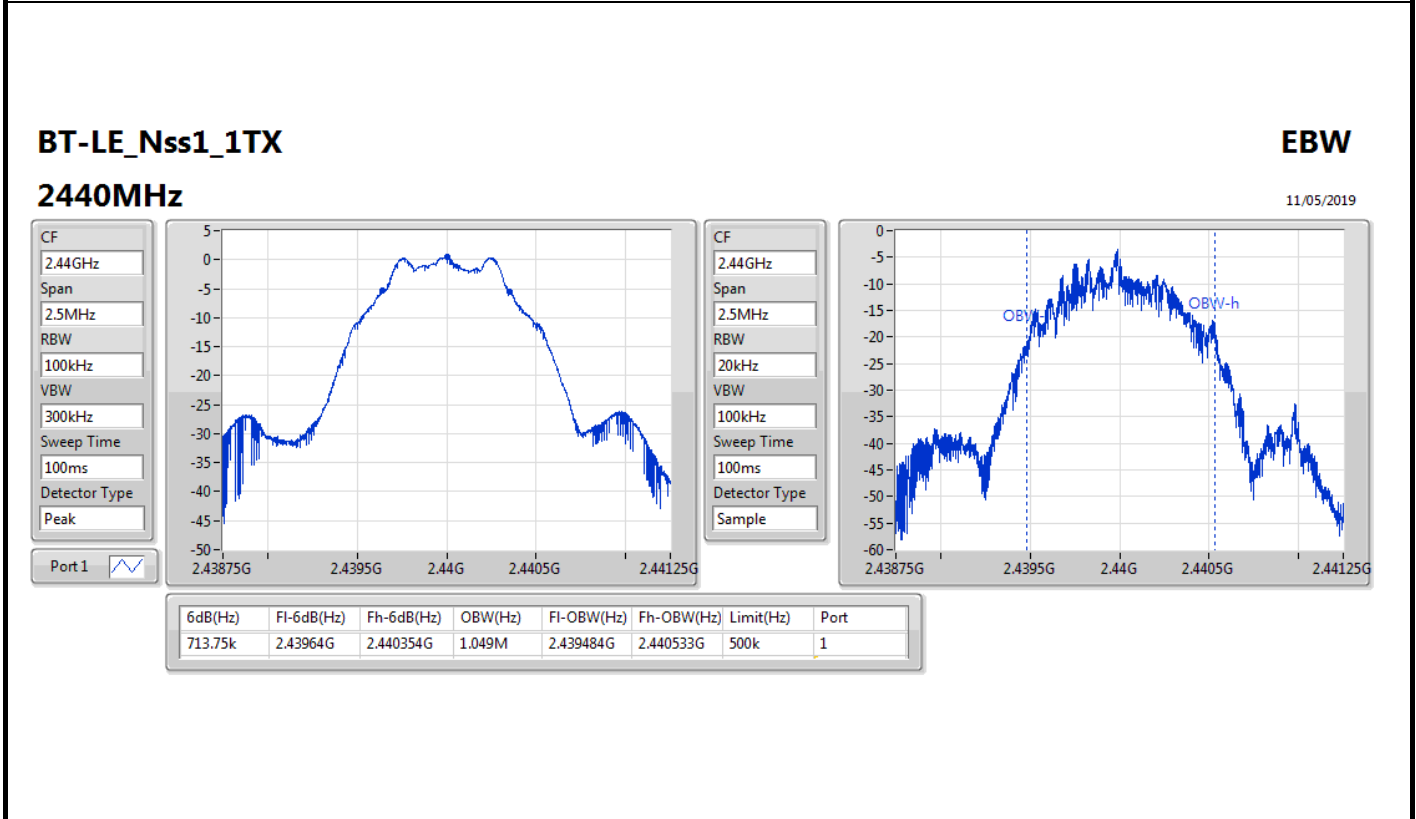
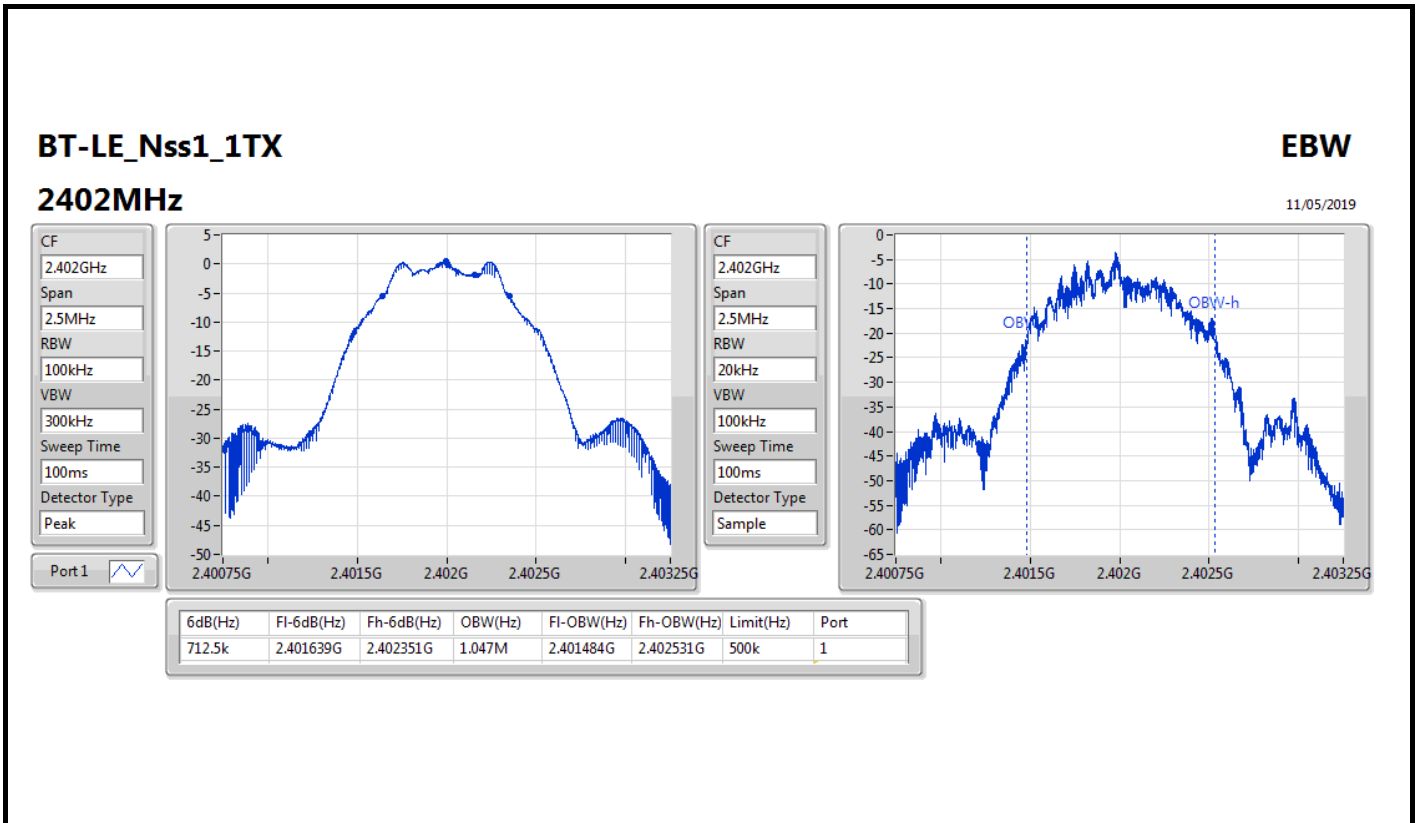

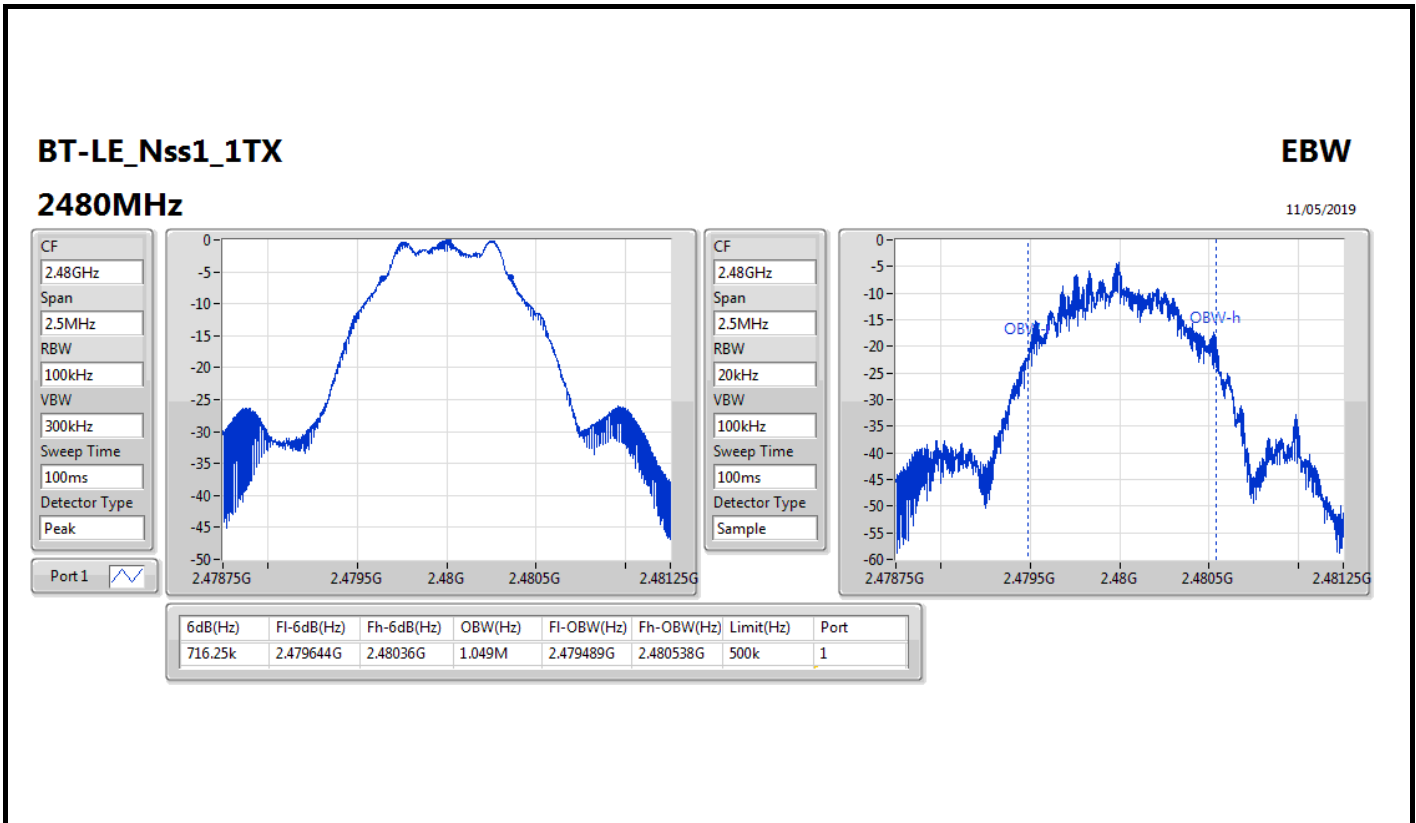



Summary

Mode	Total Power (dBm)	Total Power (W)
2.4-2.4835GHz	-	-
BT-LE_Nss1_1TX	1.40	0.00138

Result

Mode	Result	DG (dBi)	Port 1 (dBm)	Total Power (dBm)	Power Limit (dBm)
BT-LE_Nss1_1TX	-	-	-	-	-
2402MHz	Pass	0.71	1.34	1.34	30.00
2440MHz	Pass	0.71	1.40	1.40	30.00
2480MHz	Pass	0.71	0.90	0.90	30.00

DG = Directional Gain; **Port X** = Port X output power



Summary

Mode	PD (dBm/RBW)
2.4-2.4835GHz	-
BT-LE_Nss1_1TX	-13.03

RBW=3 kHz.

Result

Mode	Result	DG (dBi)	Port 1 (dBm/RBW)	PD (dBm/RBW)	PD Limit (dBm/RBW)
BT-LE_Nss1_1TX	-	-	-	-	-
2402MHz	Pass	0.71	-13.03	-13.03	8.00
2440MHz	Pass	0.71	-13.26	-13.26	8.00
2480MHz	Pass	0.71	-13.51	-13.51	8.00

DG = Directional Gain; RBW=3 kHz;

PD = trace bin-by-bin of each transmits port summing can be performed maximum power density; Port X = Port X power density;

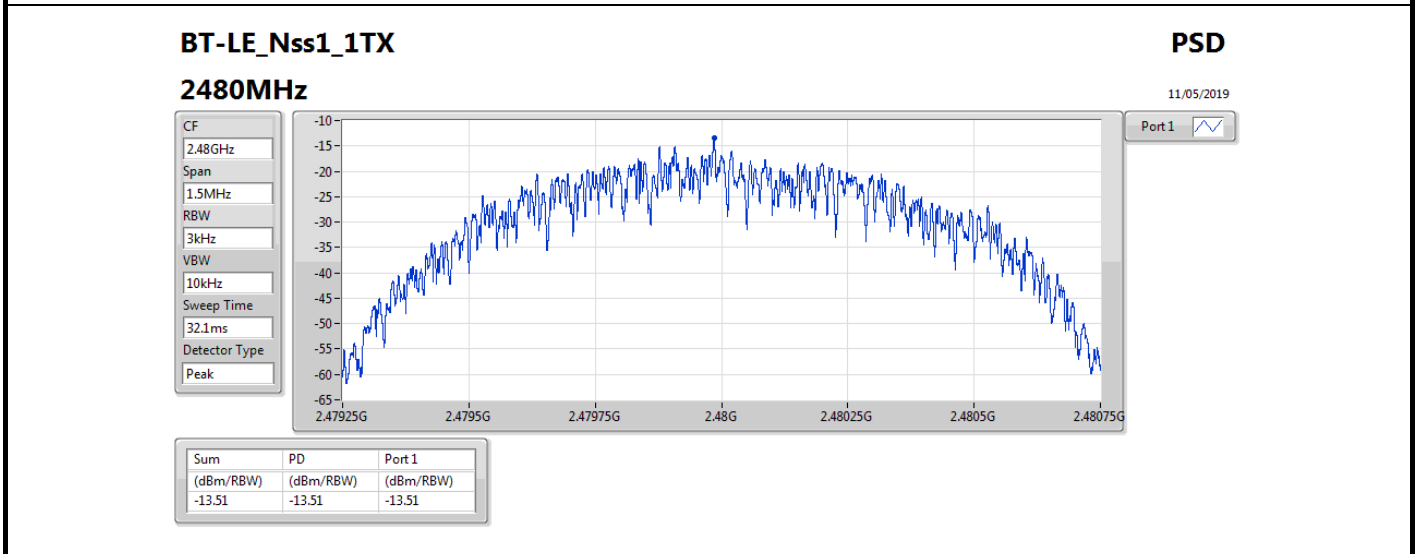
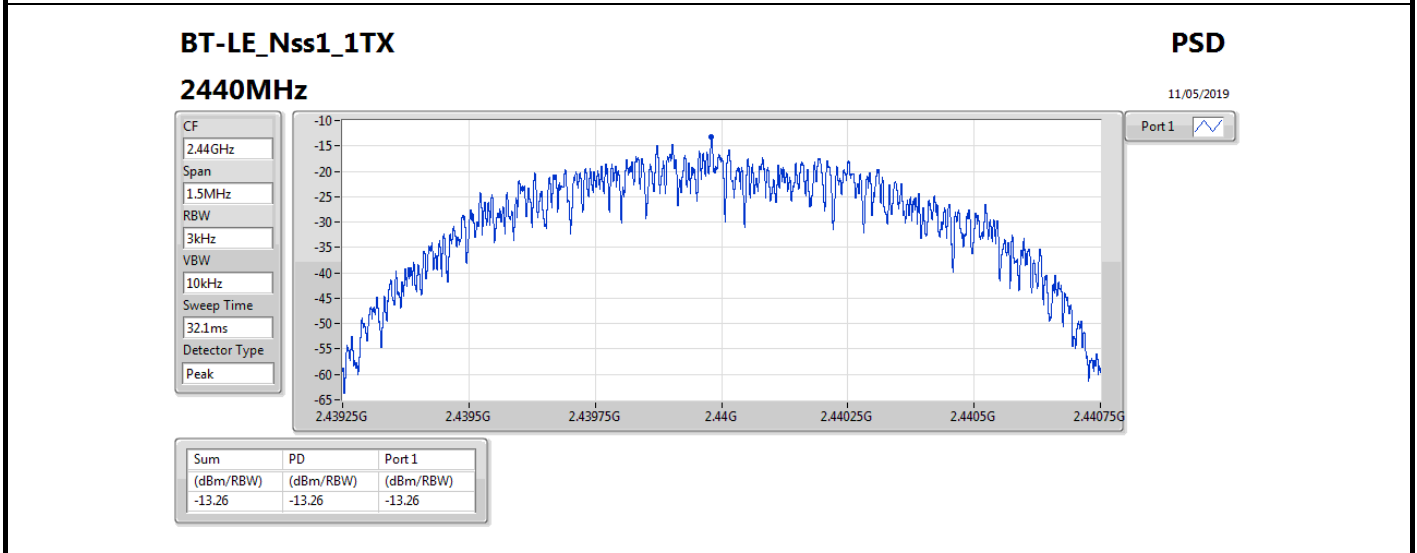
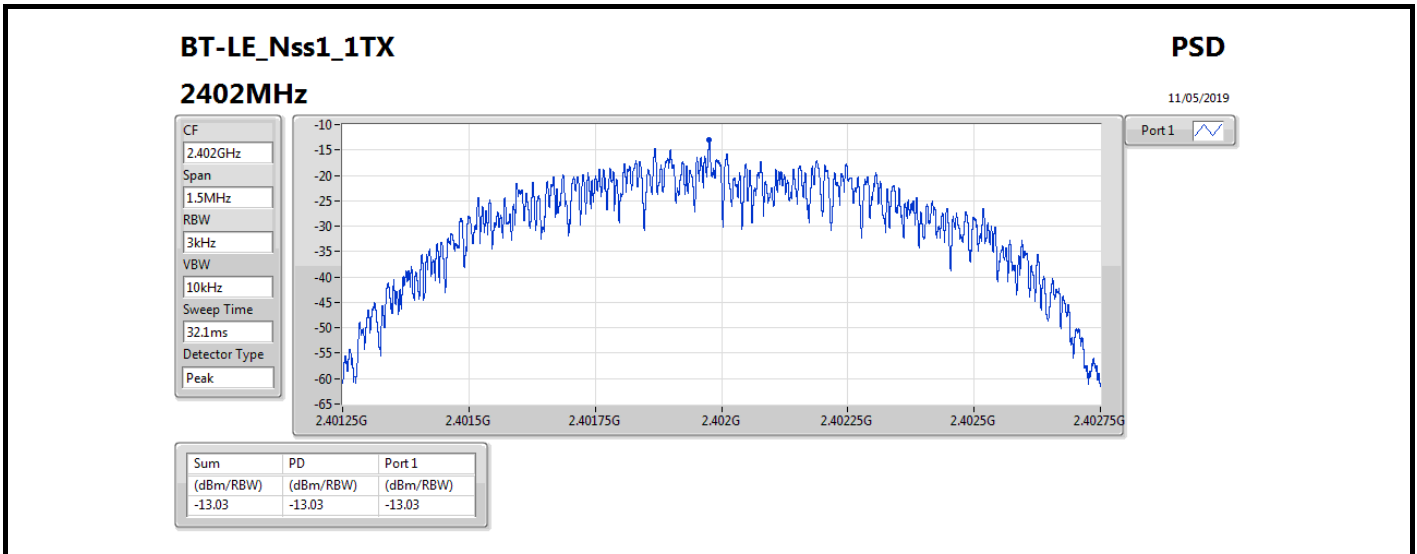



Summary

Mode	Result	Ref (Hz)	Ref (dBm)	Limit (dBm)	Freq (Hz)	Level (dBm)	Freq (Hz)	Level (dBm)	Freq (Hz)	Level (dBm)	Freq (Hz)	Level (dBm)	Port
2.4-2.4835GHz	-	-	-	-	-	-	-	-	-	-	-	-	-
BT-LE_Nss1_1TX	Pass	2.43975G	15.86	-14.14	1.84152G	-47.46	2.39976G	-37.22	2.48435G	-46.46	16.80472G	-41.52	1

Result

Mode	Result	Ref (Hz)	Ref (dBm)	Limit (dBm)	Freq (Hz)	Level (dBm)	Freq (Hz)	Level (dBm)	Freq (Hz)	Level (dBm)	Freq (Hz)	Level (dBm)	Port
BT-LE_Nss1_1TX	-	-	-	-	-	-	-	-	-	-	-	-	-
2402MHz	Pass	2.43975G	15.86	-14.14	1.84152G	-47.46	2.39976G	-37.22	2.48435G	-46.46	16.80472G	-41.52	1
2440MHz	Pass	2.43975G	15.86	-14.14	1.63906G	-47.11	2.39976G	-47.22	2.48368G	-45.68	16.50078G	-40.84	1
2480MHz	Pass	2.43975G	15.86	-14.14	2.17186G	-48.08	2.3982G	-47.31	2.48368G	-45.93	16.85819G	-41.57	1

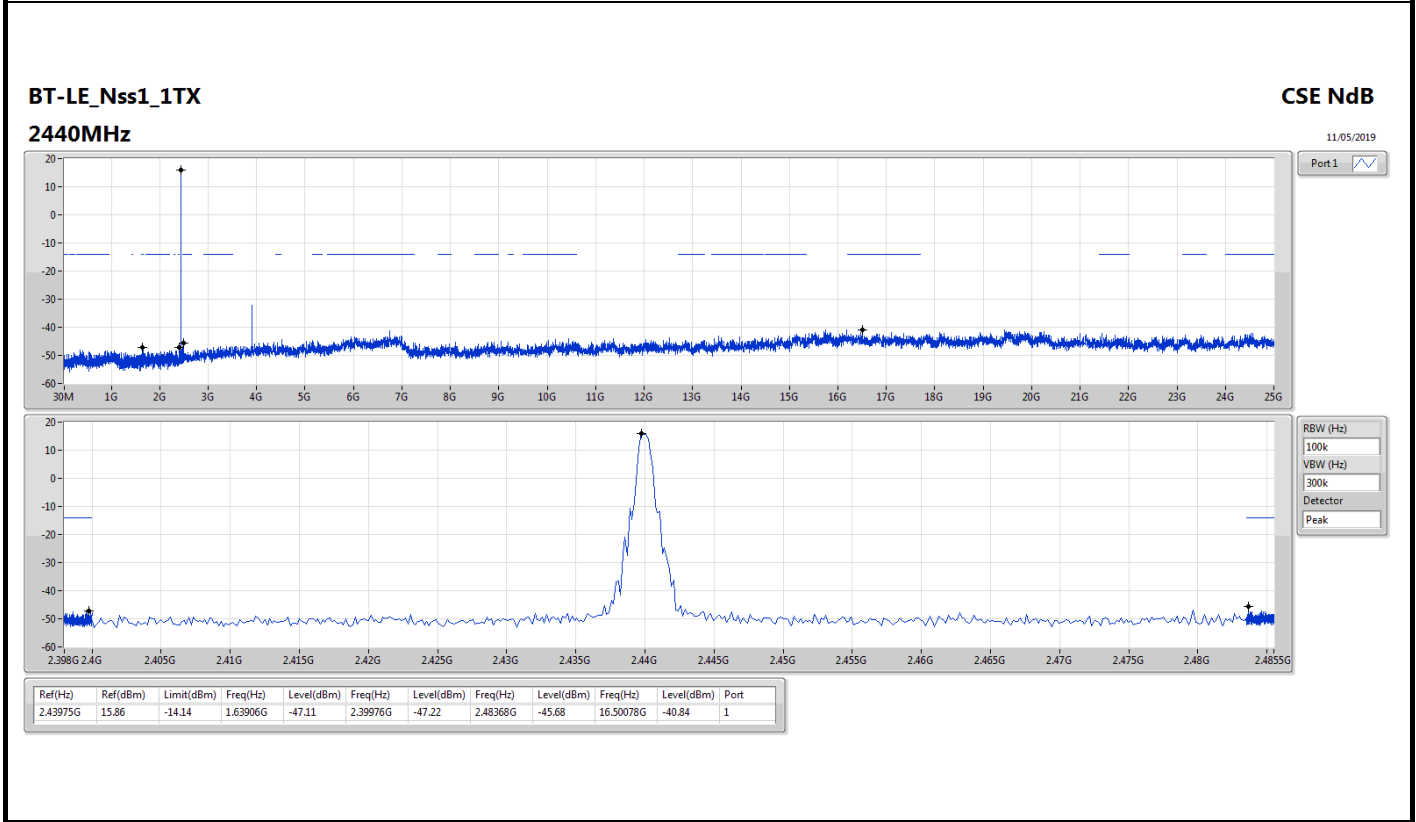
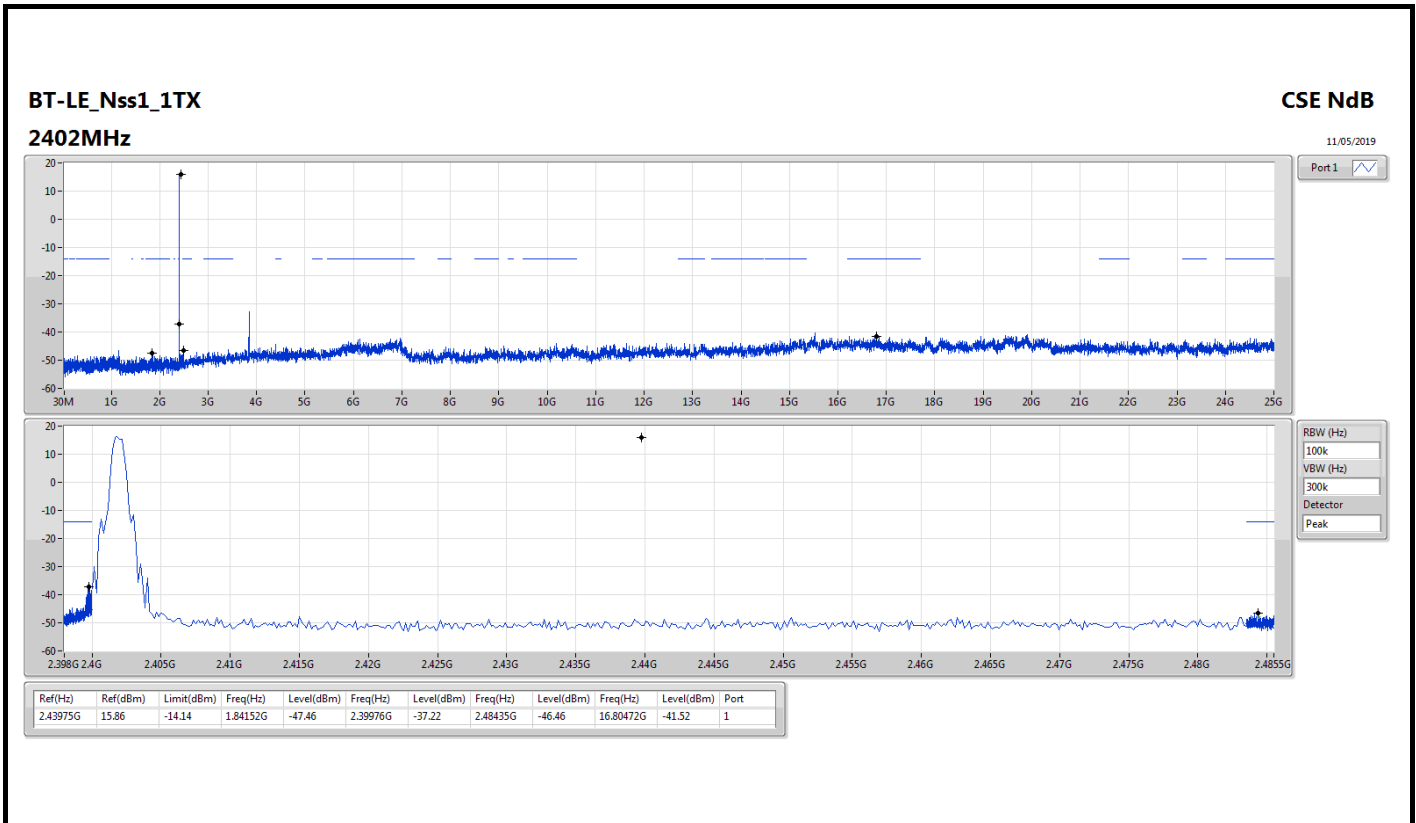

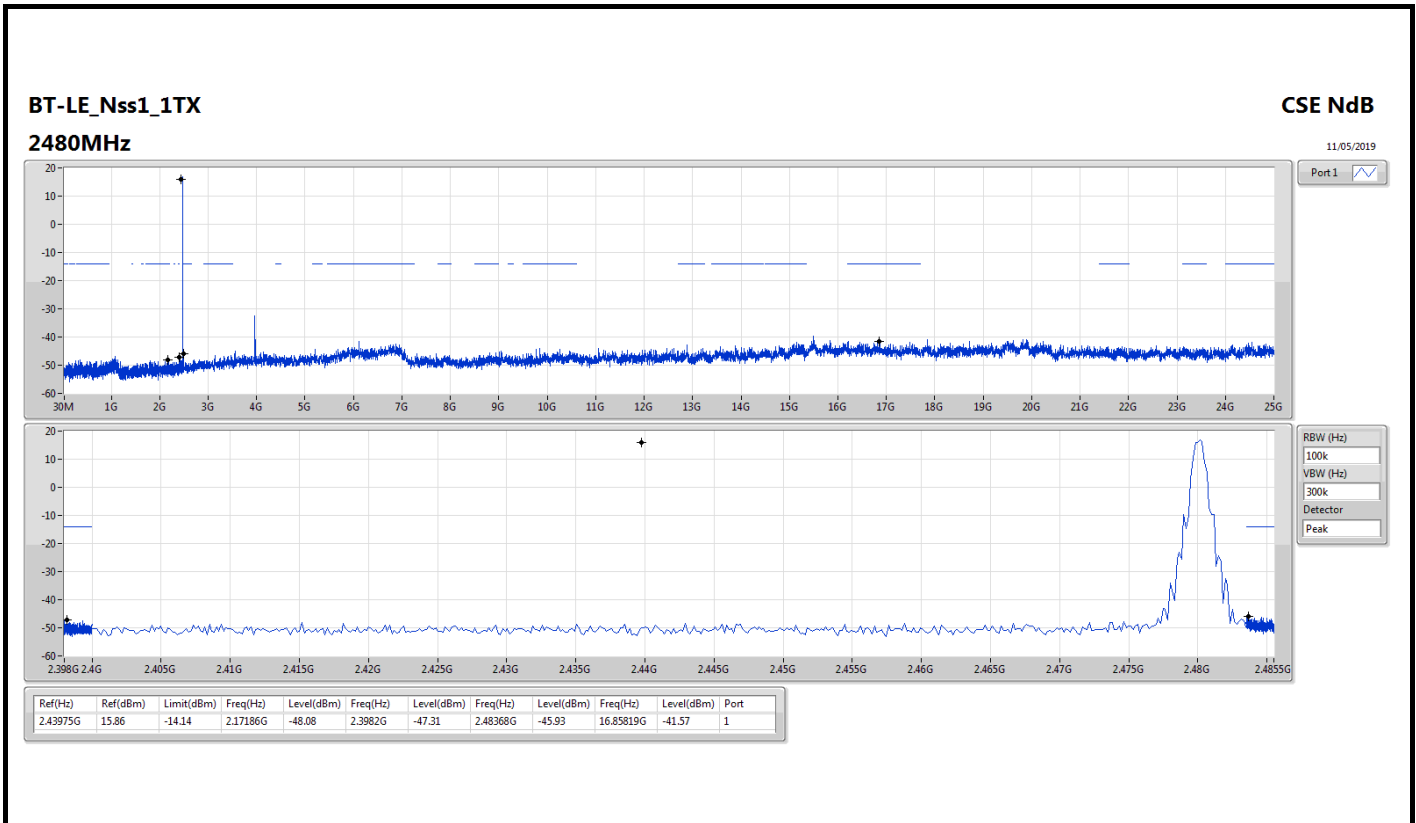



RSE below 1GHz Result

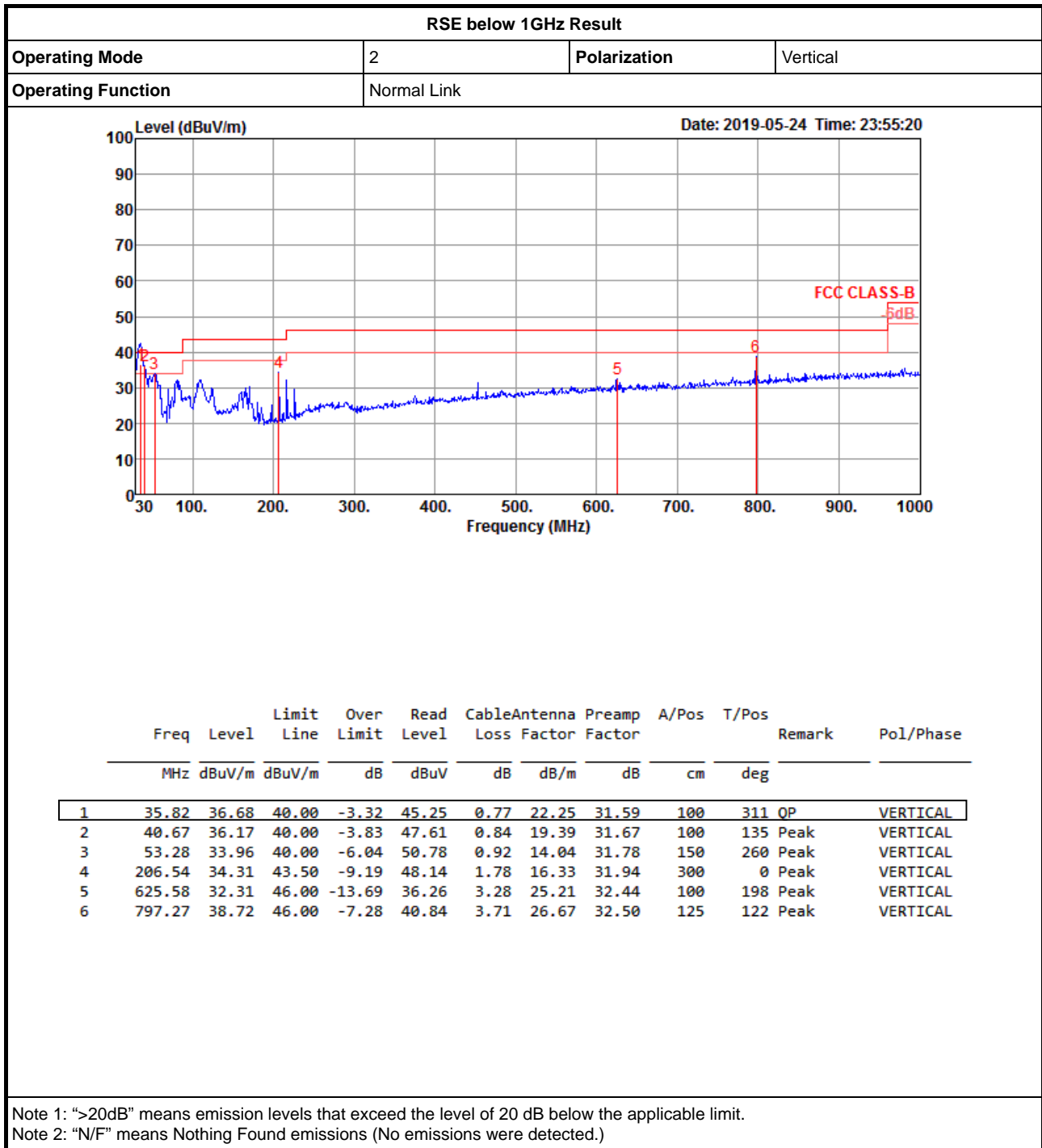



RSE below 1GHz Result

Appendix F.1

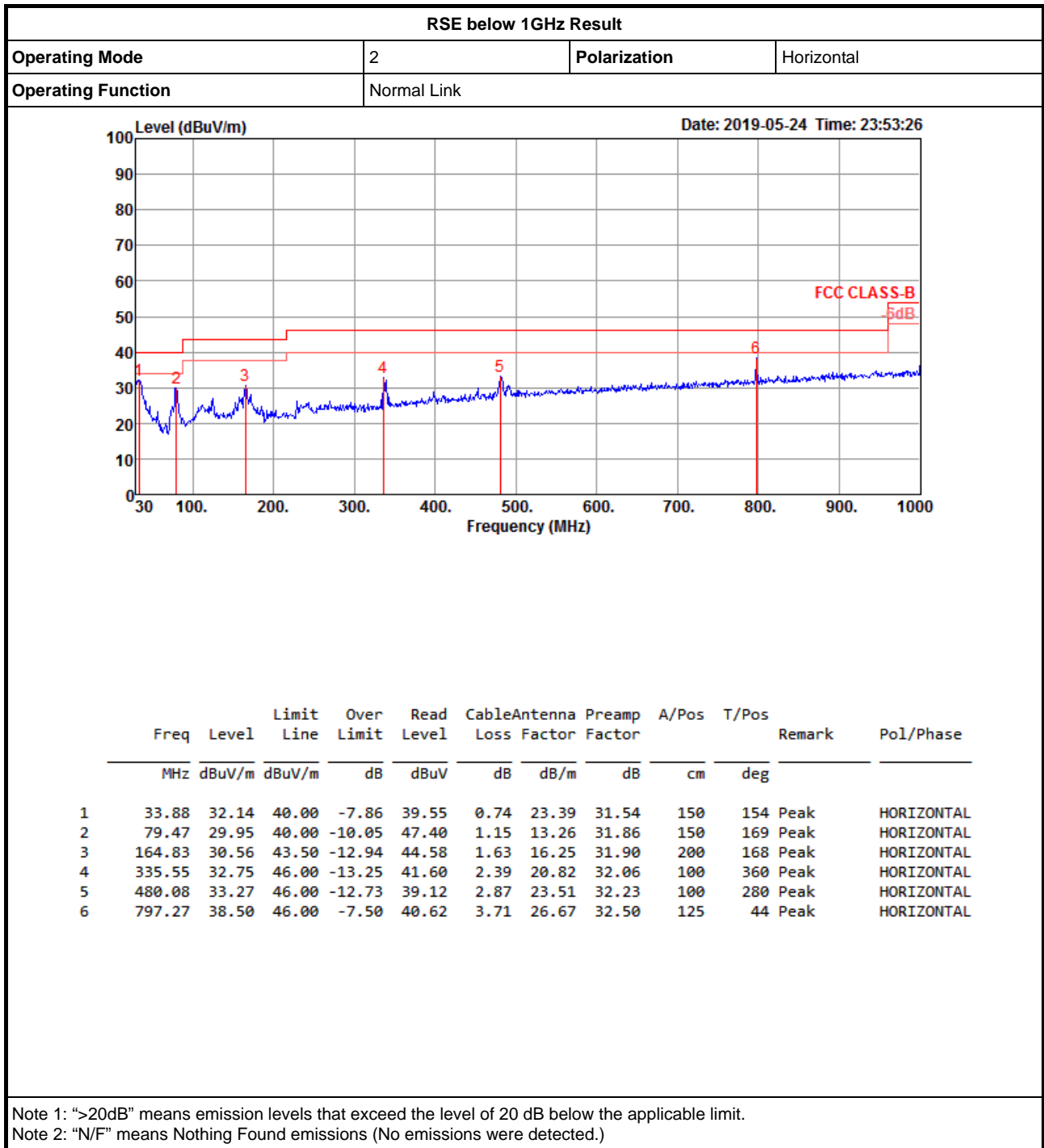



Summary

Mode	Result	Type	Freq (Hz)	Level (dBuV/m)	Limit (dBuV/m)	Margin (dB)	Factor (dB)	Dist (m)	Condition	Azimuth (°)	Height (m)	Comments
2.4-2.4835GHz	-	-	-	-	-	-	-	-	-	-	-	-
BT-LE_Nss1_1TX	Pass	AV	2.4994G	46.87	54.00	-7.13	32.46	3	Vertical	251	1.28	-

BT-LE_Nss1_1TX

11/05/2019

2402MHz_TX

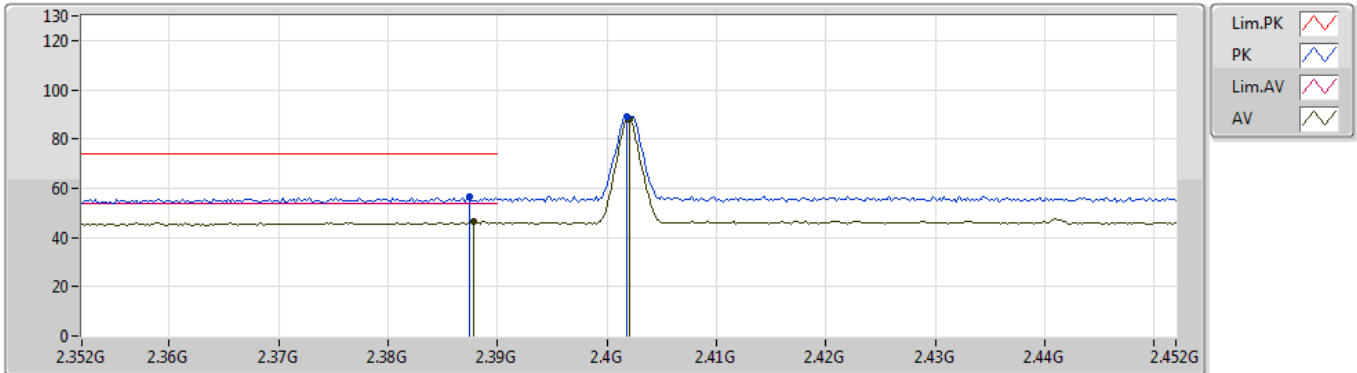

EUT Z_1TX
Setting Default
06-B-2
FSP(100080)

Type	Freq (Hz)	Level (dBuV/m)	Limit (dBuV/m)	Margin (dB)	Factor (dB)	Dist (m)	Condition	Azimuth (°)	Height (m)	Comment
PK	2.3874G	56.35	74.00	-17.65	32.11	3	Vertical	139	1.01	-
AV	2.3878G	46.35	54.00	-7.65	32.11	3	Vertical	139	1.01	-
PK	2.4018G	89.37	Inf	-Inf	32.16	3	Vertical	139	1.01	-
AV	2.402G	88.02	Inf	-Inf	32.16	3	Vertical	139	1.01	-

BT-LE_Nss1_1TX

11/05/2019

2402MHz_TX

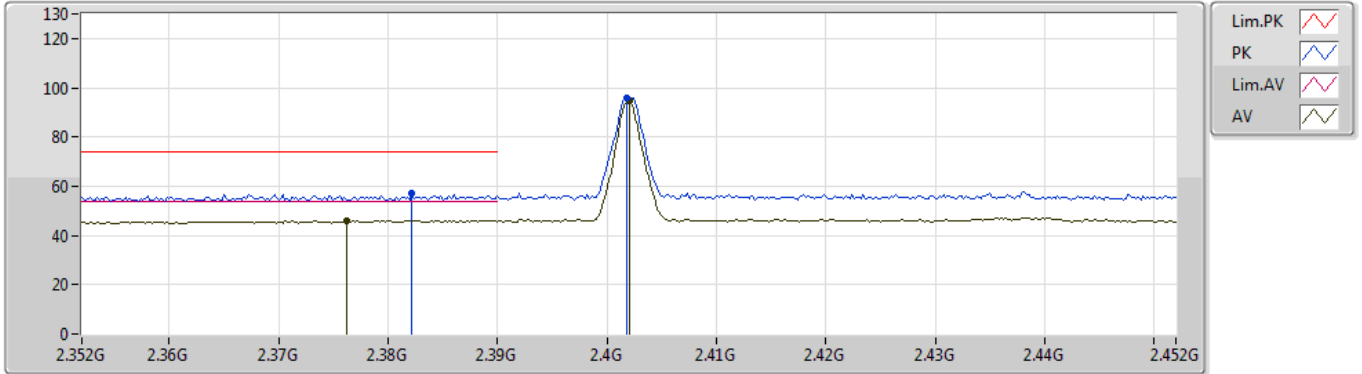

EUT_Z_1TX
 Setting Default
 06-B-2
 FSP(100080)

Type	Freq (Hz)	Level (dBuV/m)	Limit (dBuV/m)	Margin (dB)	Factor (dB)	Dist (m)	Condition	Azimuth (°)	Height (m)	Comment
PK	2.3822G	57.17	74.00	-16.83	32.10	3	Horizontal	20	1.11	-
AV	2.3762G	46.21	54.00	-7.79	32.08	3	Horizontal	20	1.11	-
PK	2.4018G	96.09	Inf	-Inf	32.16	3	Horizontal	20	1.11	-
AV	2.402G	94.82	Inf	-Inf	32.16	3	Horizontal	20	1.11	-

BT-LE_Nss1_1TX

11/05/2019

2402MHz_TX

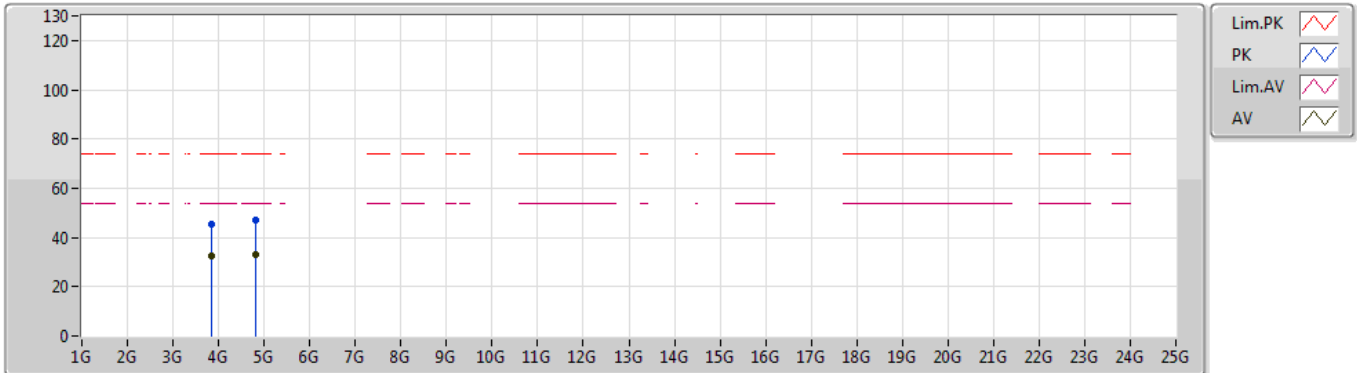

EUT_Z_1TX
Setting Default
06-B-2
FSP(100080)

Type	Freq (Hz)	Level (dBuV/m)	Limit (dBuV/m)	Margin (dB)	Factor (dB)	Dist (m)	Condition	Azimuth (°)	Height (m)	Comment
PK	3.84313G	45.39	74.00	-28.61	3.29	3	Vertical	52	2.89	-
AV	3.84317G	32.65	54.00	-21.35	3.29	3	Vertical	52	2.89	-
PK	4.8031G	47.02	74.00	-26.98	6.53	3	Vertical	122	1.13	-
AV	4.7996G	32.84	54.00	-21.16	6.53	3	Vertical	122	1.13	-

BT-LE_Nss1_1TX

11/05/2019

2402MHz_TX

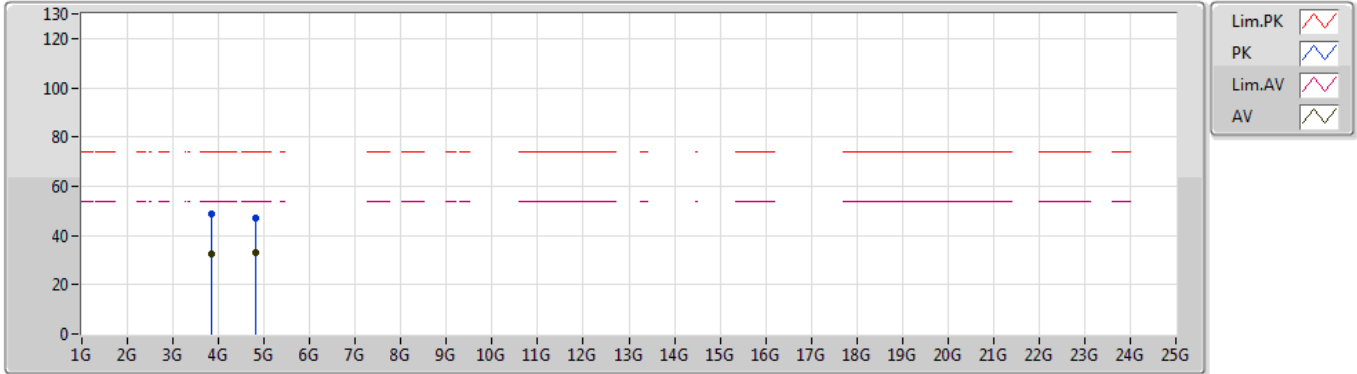

EUT_Z_1TX
 Setting Default
 06-B-2
 FSP(100080)

Type	Freq (Hz)	Level (dBuV/m)	Limit (dBuV/m)	Margin (dB)	Factor (dB)	Dist (m)	Condition	Azimuth (°)	Height (m)	Comment
PK	3.84324G	48.62	74.00	-25.38	3.29	3	Horizontal	317	1.12	-
AV	3.84317G	32.51	54.00	-21.49	3.29	3	Horizontal	317	1.12	-
PK	4.80178G	47.21	74.00	-26.79	6.53	3	Horizontal	103	1.08	-
AV	4.80022G	32.82	54.00	-21.18	6.53	3	Horizontal	103	1.08	-

BT-LE_Nss1_1TX

11/05/2019

2440MHz_TX

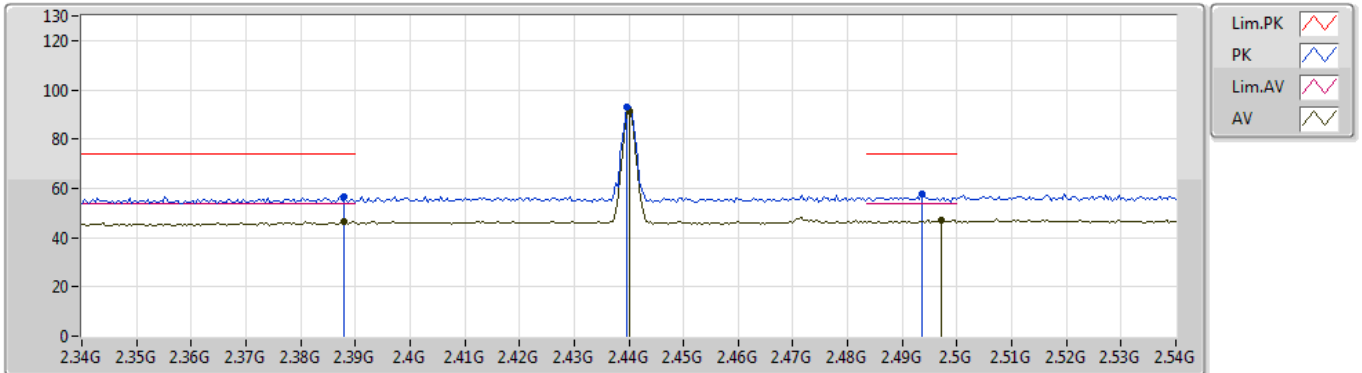

EUT_Z_1TX
 Setting Default
 06-B-2
 FSP(100080)

Type	Freq (Hz)	Level (dBuV/m)	Limit (dBuV/m)	Margin (dB)	Factor (dB)	Dist (m)	Condition	Azimuth (°)	Height (m)	Comment
PK	2.388G	56.39	74.00	-17.61	32.11	3	Vertical	139	1.00	-
AV	2.388G	46.46	54.00	-7.54	32.11	3	Vertical	139	1.00	-
PK	2.4396G	92.75	Inf	-Inf	32.28	3	Vertical	139	1.00	-
AV	2.44G	91.44	Inf	-Inf	32.28	3	Vertical	139	1.00	-
PK	2.4936G	57.44	74.00	-16.56	32.44	3	Vertical	139	1.00	-
AV	2.4972G	46.86	54.00	-7.14	32.45	3	Vertical	139	1.00	-

BT-LE_Nss1_1TX

11/05/2019

2440MHz_TX

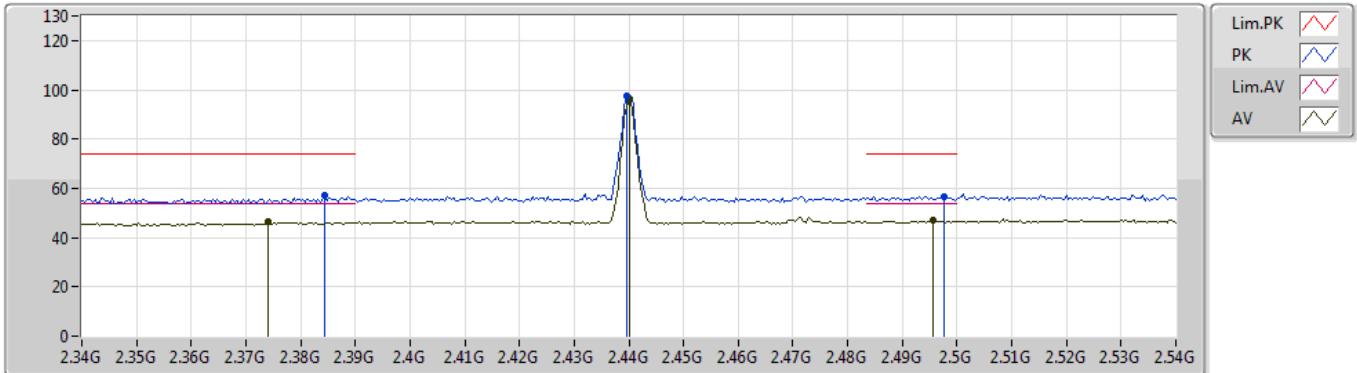

EUT_Z_1TX
 Setting Default
 06-B-2
 FSP(100080)

Type	Freq (Hz)	Level (dBuV/m)	Limit (dBuV/m)	Margin (dB)	Factor (dB)	Dist (m)	Condition	Azimuth (°)	Height (m)	Comment
PK	2.3844G	56.93	74.00	-17.07	32.10	3	Horizontal	0	1.54	-
AV	2.374G	46.25	54.00	-7.75	32.07	3	Horizontal	0	1.54	-
PK	2.4396G	97.45	Inf	-Inf	32.28	3	Horizontal	0	1.54	-
AV	2.44G	96.11	Inf	-Inf	32.28	3	Horizontal	0	1.54	-
PK	2.4976G	56.61	74.00	-17.39	32.45	3	Horizontal	0	1.54	-
AV	2.4956G	46.81	54.00	-7.19	32.45	3	Horizontal	0	1.54	-

BT-LE_Nss1_1TX

11/05/2019

2440MHz_TX

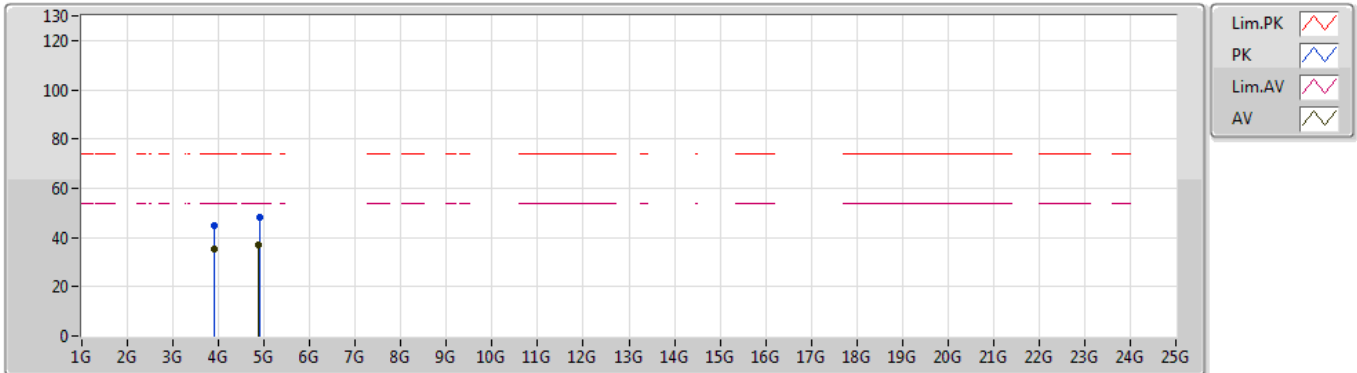

EUT_Z_1TX
Setting Default
06-B-2
FSP(100080)

Type	Freq (Hz)	Level (dBuV/m)	Limit (dBuV/m)	Margin (dB)	Factor (dB)	Dist (m)	Condition	Azimuth (°)	Height (m)	Comment
PK	3.91408G	44.76	74.00	-29.24	3.56	3	Vertical	56	2.86	-
AV	3.90388G	35.19	54.00	-18.81	3.53	3	Vertical	56	2.86	-
PK	4.89008G	48.38	74.00	-25.62	6.76	3	Vertical	32	1.19	-
AV	4.8752G	36.84	54.00	-17.16	6.71	3	Vertical	32	1.19	-

BT-LE_Nss1_1TX

11/05/2019

2440MHz_TX

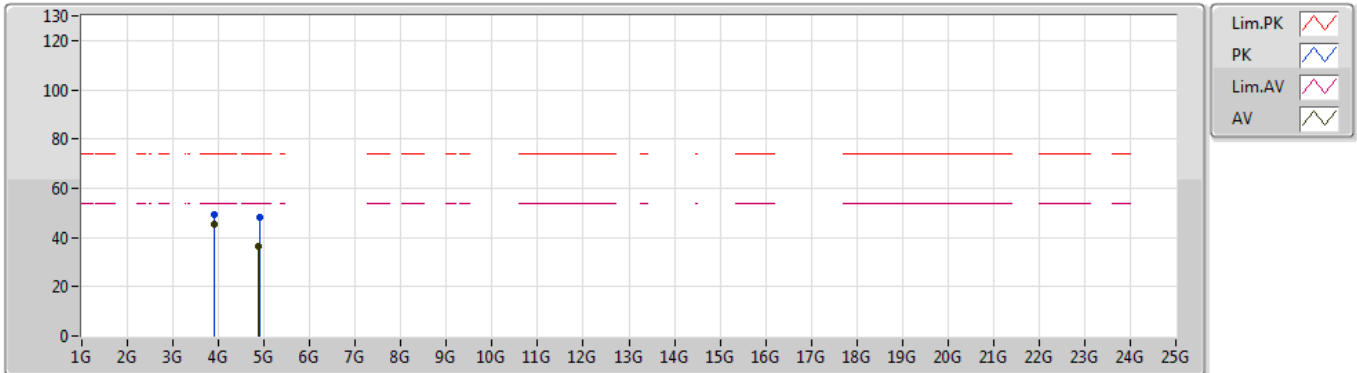

EUT_Z_1TX
Setting Default
06-B-2
FSP(100080)

Type	Freq (Hz)	Level (dBuV/m)	Limit (dBuV/m)	Margin (dB)	Factor (dB)	Dist (m)	Condition	Azimuth (°)	Height (m)	Comment
PK	3.90402G	49.29	74.00	-24.71	3.53	3	Horizontal	320	1.06	-
AV	3.90402G	45.50	54.00	-8.50	3.53	3	Horizontal	320	1.06	-
PK	4.89008G	48.01	74.00	-25.99	6.76	3	Horizontal	335	1.09	-
AV	4.87808G	36.63	54.00	-17.37	6.72	3	Horizontal	335	1.09	-

BT-LE_Nss1_1TX

11/05/2019

2480MHz_TX

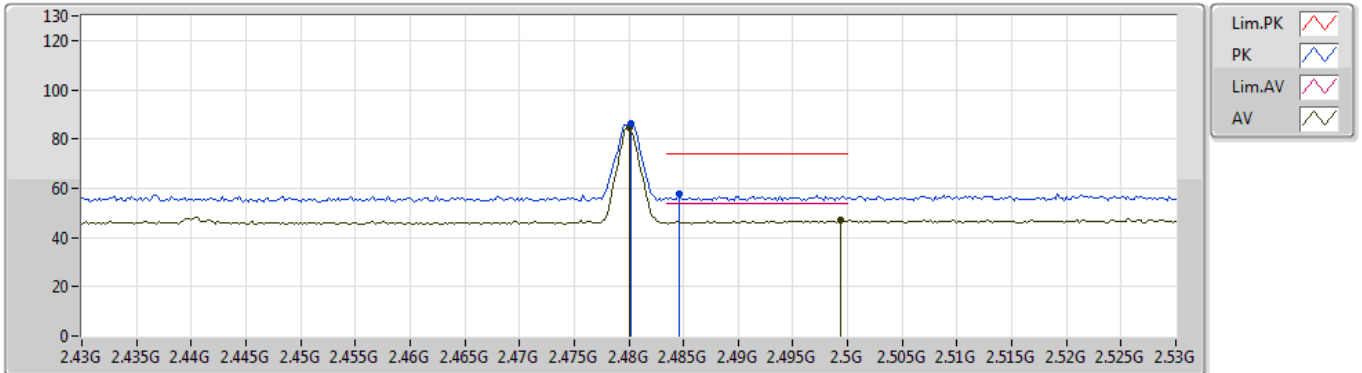

EUT Z_1TX
 Setting Default
 06-B-2
 FSP(100080)

Type	Freq (Hz)	Level (dBuV/m)	Limit (dBuV/m)	Margin (dB)	Factor (dB)	Dist (m)	Condition	Azimuth (°)	Height (m)	Comment
PK	2.4802G	86.06	Inf	-Inf	32.40	3	Vertical	251	1.28	-
AV	2.48G	84.71	Inf	-Inf	32.40	3	Vertical	251	1.28	-
PK	2.4846G	57.77	74.00	-16.23	32.42	3	Vertical	251	1.28	-
AV	2.4994G	46.87	54.00	-7.13	32.46	3	Vertical	251	1.28	-

BT-LE_Nss1_1TX

11/05/2019

2480MHz_TX

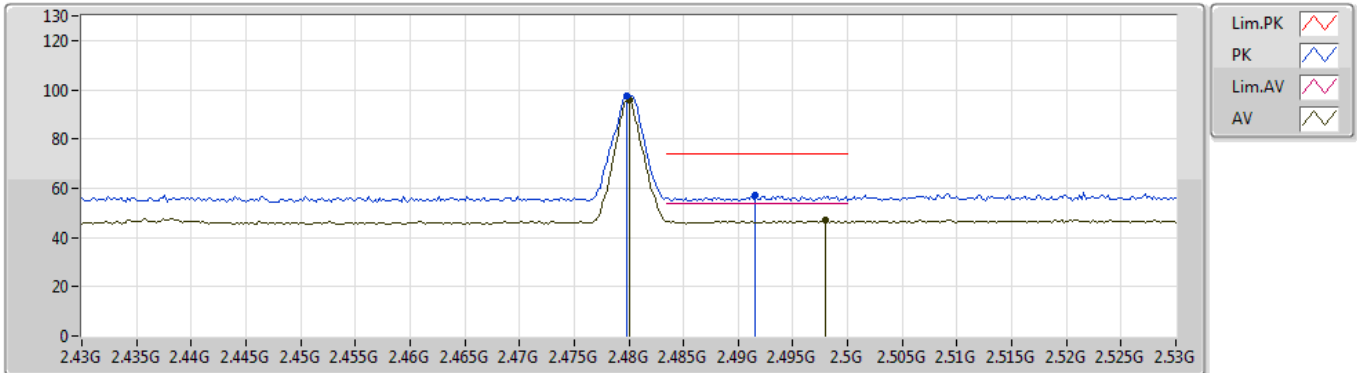

EUT Z_1TX
 Setting Default
 06-B-2
 FSP(100080)

Type	Freq (Hz)	Level (dBuV/m)	Limit (dBuV/m)	Margin (dB)	Factor (dB)	Dist (m)	Condition	Azimuth (°)	Height (m)	Comment
PK	2.4798G	97.29	Inf	-Inf	32.40	3	Horizontal	67	1.03	-
AV	2.48G	95.95	Inf	-Inf	32.40	3	Horizontal	67	1.03	-
PK	2.4916G	57.17	74.00	-16.83	32.43	3	Horizontal	67	1.03	-
AV	2.498G	46.80	54.00	-7.20	32.46	3	Horizontal	67	1.03	-

BT-LE_Nss1_1TX

11/05/2019

2480MHz_TX

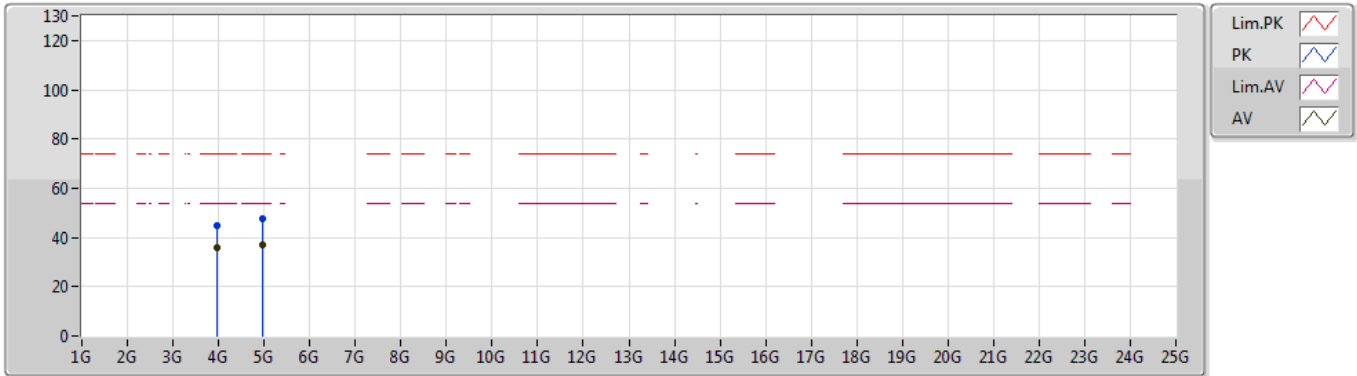

EUT_Z_1TX
 Setting Default
 06-B-2
 FSP(100080)

Type	Freq (Hz)	Level (dBuV/m)	Limit (dBuV/m)	Margin (dB)	Factor (dB)	Dist (m)	Condition	Azimuth (°)	Height (m)	Comment
PK	3.96955G	44.98	74.00	-29.02	3.76	3	Vertical	58	2.72	-
AV	3.96801G	36.00	54.00	-18.00	3.76	3	Vertical	58	2.72	-
PK	4.97398G	47.76	74.00	-26.24	6.96	3	Vertical	42	2.69	-
AV	4.9723G	36.79	54.00	-17.21	6.96	3	Vertical	42	2.69	-

BT-LE_Nss1_1TX

11/05/2019

2480MHz_TX

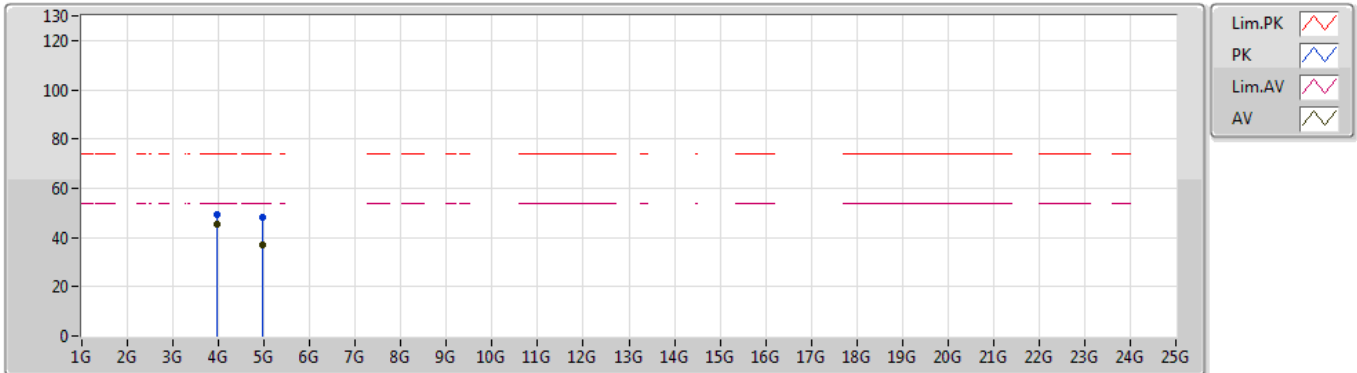

EUT_Z_1TX
Setting Default
06-B-2
FSP(100080)

Type	Freq (Hz)	Level (dBuV/m)	Limit (dBuV/m)	Margin (dB)	Factor (dB)	Dist (m)	Condition	Azimuth (°)	Height (m)	Comment
PK	3.96798G	49.44	74.00	-24.56	3.76	3	Horizontal	314	1.04	-
AV	3.96799G	45.44	54.00	-8.56	3.76	3	Horizontal	314	1.04	-
PK	4.9645G	47.93	74.00	-26.07	6.94	3	Horizontal	180	1.95	-
AV	4.96012G	36.76	54.00	-17.24	6.93	3	Horizontal	180	1.95	-