



# RADIO TEST REPORT

**Test Report No. : 12656071S-T-R1**

**Applicant** : Nintendo Co., Ltd.  
**Type of Equipment** : Game Console  
**Model No.** : HDH-002  
**FCC ID** : BKEHDH002  
**Test regulation** : FCC Part 15 Subpart E: 2019  
**Test result** : Complied (Refer to SECTION 3.2)  
**Test Item** : Maximum Conducted Output Power,  
Spurious Emission( 1 GHz to 13 GHz),  
Restricted Band Edges  
**Purpose of test** : Spot check

1. This test report shall not be reproduced in full or partial, without the written approval of UL Japan, Inc.
2. The results in this report apply only to the sample tested.
3. This sample tested is in compliance with the limits of the above regulation.
4. The test results in this test report are traceable to the national or international standards.
5. This test report must not be used by the customer to claim product certification, approval, or endorsement by any agency of the Federal Government.
6. This test report covers Radio technical requirements.  
It does not cover administrative issues such as Manual or non-Radio test related Requirements. (if applicable)
7. The all test items in this test report are conducted by UL Japan, Inc. Shonan EMC Lab.
8. The opinions and the interpretations to the result of the description in this report are outside scopes where UL Japan has been accredited.
9. The information provided from the customer for this report is identified in SECTION 1.
10. This report is a revised version of 12656071S-T. 12656071S-T is replaced with this report.

**Date of test:** April 3 to August 4, 2019

**Representative test engineer:** K. Takeyama  
Kazutaka Takeyama  
Engineer  
Consumer Technology Division

**Approved by:** A. Hayashi  
Akio Hayashi  
Leader  
Consumer Technology Division



CERTIFICATE 1266.03

- The testing in which "Non-accreditation" is displayed is outside the accreditation scopes in UL Japan.  
 There is no testing item of "Non-accreditation".

**UL Japan, Inc.**  
**Shonan EMC Lab.**

1-22-3 Megumigaoka, Hiratsuka-shi, Kanagawa-ken, 259-1220 JAPAN  
Telephone : +81 463 50 6400  
Facsimile : +81 463 50 6401

## **REVISION HISTORY**

### **Original Test Report No.: 12656071S-T**

Revision	Test report No.	Date	Page revised	Contents
- (Original)	12656071S-T	August 6, 2019	-	-
1	12656071S-T-R1	September 27, 2019	5	Addition of product description as below, The EUT is intended to be used for software development or events.

---

**UL Japan, Inc.**

**Shonan EMC Lab.**

1-22-3 Megumigaoka, Hiratsuka-shi, Kanagawa-ken, 259-1220 JAPAN

Telephone : +81 463 50 6400

Facsimile : +81 463 50 6401

<b>CONTENTS</b>	<b>PAGE</b>
<b>SECTION 1: Customer information.....</b>	<b>4</b>
<b>SECTION 2: Equipment under test (E.U.T.).....</b>	<b>4</b>
<b>SECTION 3: Test specification, procedures &amp; results.....</b>	<b>6</b>
<b>SECTION 4: Operation of E.U.T. during testing.....</b>	<b>9</b>
<b>SECTION 5 Maximum Conducted Output Power.....</b>	<b>13</b>
<b>SECTION 6: Radiated Spurious Emission and Band Edge Compliance.....</b>	<b>14</b>
<b>APPENDIX 1: Test data .....</b>	<b>16</b>
Maximum Conducted Output Power.....	16
Radiated Emission.....	27
<b>APPENDIX 2: Test instruments .....</b>	<b>51</b>
<b>APPENDIX 3: Photographs of test setup .....</b>	<b>52</b>
Radiated Spurious Emission .....	52

## **SECTION 1: Customer information**

Company Name : Nintendo Co., Ltd.  
Address : 11-1 Hokotate-cho, Kamitoba, Minami-ku, Kyoto 601-8501, Japan  
Telephone Number : + 81 75 662 9600  
Facsimile Number : + 81 75 662 9624  
Contact Person : Kazuya Kuramoto

The information provided from the customer is as follows;

- Applicant, Type of Equipment, Model No., FCC ID on the cover and other relevant pages
  - Operating/Test Mode(s) (Mode(s)) on all the relevant pages
  - SECTION 1: Customer information
  - SECTION 2: Equipment under test (E.U.T.)
  - SECTION 4: Operation of E.U.T. during testing
- \* The laboratory is exempted from liability of any test results affected from the above information in SECTION 2 and 4.

## **SECTION 2: Equipment under test (E.U.T.)**

### **2.1 Identification of E.U.T.**

Type of Equipment : Game Console  
Model No. : HDH-002  
Serial No. : Refer to SECTION 4.2  
Rating : DC 3.8 V (battery),  
AC Adapter input: AC 100 V - 240 V, 50 Hz / 60 Hz, 1 A,  
AC Adapter output: DC 5 V - DC 15 V, 2.6 A  
Receipt Date of Sample : December 27, 2018  
(Information from test lab.)  
Country of Mass-production : China  
Condition of EUT : Engineering prototype  
(Not for Sale: This sample is equivalent to mass-produced items.)  
Modification of EUT : No Modification by the test lab.

## 2.2 Product Description

Model: HDH-002 (referred to as the EUT in this report) is a Game Console.  
The EUT is intended to be used for software development or events.

### Radio Specification

Wireless LAN, Bluetooth part:

Equipment type	:	Transmitter
Frequency of operation	:	Wireless LAN part: (2.4 GHz): 2412 MHz - 2472 MHz, (U-NII-1): 5180 MHz - 5240 MHz, (U-NII-2A): 5260 MHz - 5320 MHz, Bluetooth (BDR/EDR/BTLE) part: 2402 MHz - 2480 MHz
Radio part clock frequency	:	37.4 MHz
Channel spacing	:	Wireless LAN part: (2.4 GHz): 5 MHz, (5 GHz): 20 MHz, Bluetooth part: (BDR/EDR): 1 MHz, (BT LE): 2 MHz
Type of modulation	:	Wireless LAN part: 2.4 GHz bands: DBPSK, DQPSK, CCK, OFDM, 5 GHz bands: OFDM Bluetooth (BT) part: BDR (Basic Data Rate): GFSK, EDR (Enhanced Data Rate): $\pi/4$ -DQPSK, 8DPSK, BT LE (Low Energy mode): GFSK
Antenna type	:	Sheet metal antenna
Antenna connector type	:	(Ant: 0): MHF2, (Ant: 1): MHF2
Antenna gain	:	2.4 GHz bands: (Ant: 0): -0.904 dBi, (Ant: 1): -0.730 dBi 5 GHz bands: (Ant: 0): 2.949 dBi, (Ant: 1): 1.994 dBi
Power Supply (radio part input)	:	DC 1.8 V, DC 3.3 V
Operation temperature range	:	+5 deg.C to +35 deg.C

Remarks: This wireless module consists of 1 chip each of 5 GHz bands and 2.4 GHz bands.

NFC part:

Equipment type	:	Transmitter
Frequency of operation	:	13.56 MHz
Radio part clock frequency	:	27.12 MHz
Type of modulation	:	ASK
Power Supply (radio part input)	:	DC 1.8 V, DC 5.0 V
Antenna type	:	Ferrite Chip Antenna
Operation temperature range	:	+5 deg.C to +35 deg.C

## **SECTION 3: Test specification, procedures & results**

### **3.1 Test Specification**

Test Specification : FCC Part 15 Subpart E  
FCC Part 15 final revised on July 19, 2019 and effective August 19, 2019 except 15.258  
Title : FCC 47CFR Part15 Radio Frequency Device Subpart E  
Unlicensed National Information Infrastructure Devices  
Section 15.407 General technical requirements

\* The revisions made after testing date do not affect the test specification applied to the EUT.

\* Also the EUT complies with FCC Part 15 Subpart B.

### **3.2 Procedures and results**

Item	Test Procedure	Specification	Worst margin	Results	Remarks
Maximum Conducted Output Power	FCC: KDB Publication Number 789033	FCC: 15.407 (a) (1) (2) (3)	See data	Complied a)	Conducted
	IC: -	IC: RSS-247 6.2.1.1 6.2.2.1 6.2.3.1 6.2.4.1			
Spurious Emission Restricted Band Edge	FCC: ANSI C63.10-2013 KDB Publication Number 789033	FCC: 15.407 (b), 15.205 and 15.209	2.6 dB Freq.: 5350 MHz Detector: Average Polarization: Horizontal Mode: Tx, IEEE802.11n HT40 (SISO), 5310 MHz	Complied # b)	Radiated
	IC: -	IC: RSS-247 6.2.1.2 6.2.2.2 6.2.3.2 6.2.4.2			
Note: UL Japan, Inc.'s EMI Work Procedures No. 13-EM-W0420 and 13-EM-W0422.					
a) Refer to APPENDIX 1 (data of Maximum Conducted Output Power)					
b) Refer to APPENDIX 1 (data of Radiated Emission)					
Symbols:					
Complied The data of this test item has enough margin, more than the measurement uncertainty.					
Complied# The data of this test item meets the limits unless the measurement uncertainty is taken into consideration.					

\* In case any questions arise about test procedure, ANSI C63.10: 2013 is also referred.

#### **FCC Part 15.31 (e)**

This EUT provides the stable voltage constantly to RF Module regardless of input voltage. Therefore, this EUT complies with the requirement.

#### **FCC Part 15.203 Antenna requirement**

It is impossible for end users to replace the antenna, because the antenna is mounted inside of the EUT. Therefore, the equipment complies with the antenna requirement of Section 15.203.

### 3.3 Addition to standard

No addition, exclusion nor deviation has been made from the standard.

### 3.4 Uncertainty

There is no applicable rule of uncertainty in this applied standard. Therefore, the following results are derived depending on whether or not laboratory uncertainty is applied.

The following uncertainties have been calculated to provide a confidence level of 95 % using a coverage factor  $k=2$ .

Item	Frequency range	Uncertainty (+/-)				
		No. 1 SAC / SR	No. 2 SAC / SR	No. 3 SAC / SR	No. 4 SAC / SR	No. 5,6,8 SR
Conducted emission (AC Mains) LISN	150 kHz-30 MHz	2.9 dB	2.8 dB	2.9 dB	2.9 dB	2.9 dB
Radiated emission (Measurement distance: 3 m)	9 kHz-30 MHz	3.0 dB	3.0 dB	3.1 dB	-	-
	30 MHz-200 MHz	4.6 dB	4.6 dB	4.7 dB	-	-
	200 MHz-1 GHz	6.0 dB	6.0 dB	6.1 dB	-	-
	1 GHz-6 GHz	4.8 dB	4.8 dB	4.8 dB	-	-
	6 GHz-18 GHz	5.4 dB	5.4 dB	5.4 dB	-	-
Radiated emission (Measurement distance: 1 m)	18 GHz-40 GHz	5.6 dB	5.6 dB	5.6 dB	-	-
	1 GHz-18 GHz	5.7 dB	5.7 dB	5.7 dB	-	-
	18 GHz-40 GHz	5.9 dB	5.9 dB	5.9 dB	-	-

SAC=Semi-Anechoic Chamber

SR= Shielded Room is applied besides radiated emission

Antenna terminal test	Uncertainty (+/-)
Power Measurement above 1 GHz (Average Detector)_SPM-06	0.81 dB
Power Measurement above 1 GHz (Peak Detector)_SPM-06	1.53 dB
Power Measurement above 1 GHz (Average Detector)_SPM-07	0.95 dB
Power Measurement above 1 GHz (Peak Detector)_SPM-07	1.21 dB
Power Measurement above 1 GHz (Average Detector)_SPM-13	0.90 dB
Power Measurement above 1 GHz (Peak Detector)_SPM-13	1.04 dB

### 3.5 Test Location

UL Japan, Inc. Shonan EMC Lab.  
1-22-3, Megumigaoka, Hiratsuka-shi, Kanagawa-ken 259-1220 JAPAN  
Telephone: +81 463 50 6400, Facsimile: +81 463 50 6401  
A2LA Certificate Number: 1266.03  
FCC Test Firm Registration Number: 626366

Test site	IC Registration Number	Width x Depth x Height (m)	Size of reference ground plane (m) / horizontal conducting plane	Maximum measurement distance
No.1 Semi-anechoic chamber	2973D-1	20.6 x 11.3 x 7.65	20.6 x 11.3	10 m
No.2 Semi-anechoic chamber	2973D-2	20.6 x 11.3 x 7.65	20.6 x 11.3	10 m
No.3 Semi-anechoic chamber	2973D-3	12.7 x 7.7 x 5.35	12.7 x 7.7	5 m
No.4 Semi-anechoic chamber	-	8.1 x 5.1 x 3.55	8.1 x 5.1	-
No.1 Shielded room	-	6.8 x 4.1 x 2.7	6.8 x 4.1	-
No.2 Shielded room	-	6.8 x 4.1 x 2.7	6.8 x 4.1	-
No.3 Shielded room	-	6.3 x 4.7 x 2.7	6.3 x 4.7	-
No.4 Shielded room	-	4.4 x 4.7 x 2.7	4.4 x 4.7	-
No.5 Shielded room	-	7.8 x 6.4 x 2.7	7.8 x 6.4	-
No.6 Shielded room	-	7.8 x 6.4 x 2.7	7.8 x 6.4	-
No.8 shielded room	-	3.45 x 5.5 x 2.4	3.45 x 5.5	-
No.1 Measurement room	-	2.55 x 4.1 x 2.5	-	-

### 3.6 Test data, Test instruments, and Test set up

Refer to APPENDIX.



## **SECTION 4: Operation of E.U.T. during testing**

### **4.1 Operating Mode(s)**

Test operating mode was determined as follows according to “Section 1 of 6 802.11 a/b/g/n testing - Managing Complex Regulatory Approvals -” of TCB Council Workshop October 2009 and also was judged the necessity of 802.11ac mode by the pre-test.

<b>Mode</b>	<b>Remarks *)</b>
Transmitting (Tx), IEEE 802.11a (11a)	48 Mbps, PN9
Transmitting (Tx), IEEE 802.11n HT20 (11n-20), SISO	MCS 6, PN9
Transmitting (Tx), IEEE 802.11ac VHT20 (11ac-20), SISO	MCS 3, PN9
Transmitting (Tx), IEEE 802.11n HT20 (11n-20), MIMO	MCS 15, PN9
Transmitting (Tx), IEEE 802.11ac VHT20 (11ac-20), MIMO	MCS 4, PN9
Transmitting (Tx), IEEE 802.11n HT40 (11n-40), SISO	MCS 3 (5190 MHz for Radiated Emission), MCS 5 (5190 MHz for other testing), MCS 3 (Other than 5190 MHz), PN9
Transmitting (Tx), IEEE 802.11ac VHT40 (11ac-40), SISO	MCS 9 (5190 MHz for Radiated Emission), MCS 4 (5190 MHz for other testing), MCS 2 (Other than 5190 MHz), PN9
Transmitting (Tx), IEEE 802.11n HT40 (11n-40), MIMO	MCS 15(U-NII-1 Band only), MCS 11(Other than U-NII-1 Band) PN9
Transmitting (Tx), IEEE 802.11ac VHT40 (11ac-40), MIMO	MCS 4(U-NII-1 Band only), MCS 6(Other than U-NII-1 Band), PN9
Transmitting (Tx), IEEE 802.11ac VHT80 (11ac-80), SISO	MCS 5, PN9
Transmitting (Tx), IEEE 802.11ac VHT80 (11ac-80), MIMO	MCS 5
<p>*Power of the EUT was set by the software as follows;  Power settings: Fixed (refer to power setting (target power) table)  Software: cmd.exe version 6.1.7601.23403</p> <p>*Worst rate is determined by antenna terminal power for Antenna terminated testing and EIRP for Radiated Emission testing of HDH-001 (12656071S-J-R1).  *This setting of software is the worst case.  Any conditions under the normal use do not exceed the condition of setting.  In addition, end users cannot change the settings of the output power of the product.</p>	

**UL Japan, Inc.**

**Shonan EMC Lab.**

1-22-3 Megumigaoka, Hiratsuka-shi, Kanagawa-ken, 259-1220 JAPAN

Telephone : +81 463 50 6400

Facsimile : +81 463 50 6401

\*The details of Operation mode(s)

Test Item	Operating Mode	Tested Antenna *3)	Tested Frequency	
			U-NII-1 Band	U-NII-2A Band
Maximum Conducted Output Power *1)	Transmitting (Tx), IEEE 802.11a (11a)	0	5180 MHz	5260 MHz
	Transmitting (Tx), IEEE 802.11n HT20 (11n-20), SISO		5220 MHz	5300 MHz
	Transmitting (Tx), IEEE 802.11ac VHT20 (11ac-20), SISO		5240 MHz	5320 MHz
	Transmitting (Tx), IEEE 802.11n HT20 (11n-20), MIMO	0 & 1		
	Transmitting (Tx), IEEE 802.11ac VHT20 (11ac-20), MIMO			
	Transmitting (Tx), IEEE 802.11n HT40 (11n-40), SISO	0, 1	5190 MHz	5270 MHz
	Transmitting (Tx), IEEE 802.11ac VHT40 (11ac-40), SISO	(Only U-NII-1 Band)	5230 MHz	5310 MHz
	Transmitting (Tx), IEEE 802.11n HT40 (11n-40), MIMO	0 & 1		
Radiated Spurious Emission (Above 1 GHz) *2), *4)	Transmitting (Tx), IEEE 802.11ac VHT40 (11ac-40), MIMO			
	Transmitting (Tx), IEEE 802.11ac VHT40 (11ac-40), MIMO			
	Transmitting (Tx), IEEE 802.11ac VHT80 (11ac-80), SISO	1	5210 MHz	5290 MHz
	Transmitting (Tx), IEEE 802.11ac VHT80 (11ac-80), MIMO	0 & 1		
	Transmitting (Tx), IEEE 802.11ac VHT20 (11ac-20), SISO	0	5180 MHz	5320 MHz
	Transmitting (Tx), IEEE 802.11n HT20 (11n-20), MIMO *5)	0 & 1		
	Transmitting (Tx), IEEE 802.11n HT40 (11n-40), SISO	0	5190 MHz	5310 MHz
	Transmitting (Tx), IEEE 802.11ac VHT40 (11ac-40), MIMO *5)	0 & 1		
Transmitting (Tx), IEEE 802.11ac VHT80 (11ac-80), SISO	0	5210 MHz	5290 MHz	
Transmitting (Tx), IEEE 802.11ac VHT80 (11ac-80), MIMO *5)	0 & 1			

\*1)The worst rate was determined based on the test result of HDH-001 (12656071S-J-R1).  
\*2) The mode was tested as a representative, because it had the highest power and data rate at antenna terminal test of HDH-001 (12656071S-J-R1).  
\*3) The test was performed with the antenna that had higher power as a representative.  
\*4) Since 11a, 11n and 11ac mode have the same modulation method and no differences in transmitting specification, test was performed on the representative mode that had the highest radiated carrier power.  
\*5) This mode wasn't worst, but only band edge of spurious emissions were measured for confirmation.

Power setting (target power) table

Bandwidth	Channel frequency	Mode	Rate / MCS mode [dBm]									
			6 M	9 M	12 M	18 M	24 M	36 M	48 M	54 M	-	-
20 MHz	5180 MHz – 5240 MHz	11a	6 M	9 M	12 M	18 M	24 M	36 M	48 M	54 M	-	-
			13.5	13.5	13.5	13.5	13.5	13.5	13.5	13.5	-	-
	5180 MHz – 5240 MHz	11n-HT20 (SISO)	MCS 0	MCS 1	MCS 2	MCS 3	MCS 4	MCS 5	MCS 6	MCS 7	-	-
			13.5	13.5	13.5	13.5	13.5	13.5	13.5	13.5	-	-
	5180 MHz – 5240 MHz	11n-HT20 (MIMO)	MCS 8	MCS 9	MCS 10	MCS 11	MCS 12	MCS 13	MCS 14	MCS 15	-	-
			10.5	10.5	10.5	10.5	10.5	10.5	10.5	10.5	-	-
	5180 MHz – 5240 MHz	11ac-VHT20 (SISO)	MCS 0	MCS 1	MCS 2	MCS 3	MCS 4	MCS 5	MCS 6	MCS 7	MCS 8	-
			13.5	13.5	13.5	13.5	13.5	13.5	13.5	13.5	13.0	-
	5180 MHz – 5240 MHz	11ac-VHT20 (MIMO)	MCS 0	MCS 1	MCS 2	MCS 3	MCS 4	MCS 5	MCS 6	MCS 7	MCS 8	-
			10.5	10.5	10.5	10.5	10.5	10.5	10.5	10.5	10.5	-
40 MHz	5190 MHz	11n-HT40 (SISO)	MCS 0	MCS 1	MCS 2	MCS 3	MCS 4	MCS 5	MCS 6	MCS 7	-	-
			10.0	10.0	10.0	10.0	10.0	10.0	10.0	10.0	-	-
	5230 MHz	11n-HT40 (SISO)	MCS 0	MCS 1	MCS 2	MCS 3	MCS 4	MCS 5	MCS 6	MCS 7	-	-
			13.5	13.5	13.5	13.5	13.5	13.5	13.5	13.5	-	-
	5190 MHz	11n-HT40 (MIMO)	MCS 8	MCS 9	MCS 10	MCS 11	MCS 12	MCS 13	MCS 14	MCS 15	-	-
			7.0	7.0	7.0	7.0	7.0	7.0	7.0	7.0	-	-
	5230 MHz	11n-HT40 (MIMO)	MCS 8	MCS 9	MCS 10	MCS 11	MCS 12	MCS 13	MCS 14	MCS 15	-	-
			10.5	10.5	10.5	10.5	10.5	10.5	10.5	10.5	-	-
	5190 MHz	11ac-VHT40 (SISO)	MCS 0	MCS 1	MCS 2	MCS 3	MCS 4	MCS 5	MCS 6	MCS 7	MCS 8	MCS 9
			10.0	10.0	10.0	10.0	10.0	10.0	10.0	10.0	10.0	10.0
	5230 MHz	11ac-VHT40 (SISO)	MCS 0	MCS 1	MCS 2	MCS 3	MCS 4	MCS 5	MCS 6	MCS 7	MCS 8	MCS 9
			13.5	13.5	13.5	13.5	13.5	13.5	13.5	13.5	13.0	13.0
	5190 MHz	11ac-VHT40 (MIMO)	MCS 0	MCS 1	MCS 2	MCS 3	MCS 4	MCS 5	MCS 6	MCS 7	MCS 8	MCS 9
			7.0	7.0	7.0	7.0	7.0	7.0	7.0	7.0	7.0	7.0
5230 MHz	11ac-VHT40 (MIMO)	MCS 0	MCS 1	MCS 2	MCS 3	MCS 4	MCS 5	MCS 6	MCS 7	MCS 8	MCS 9	
		10.5	10.5	10.5	10.5	10.5	10.5	10.5	10.5	10.5	10.5	
80 MHz	5210 MHz *1)	11ac-VHT80 (SISO)	MCS 0	MCS 1	MCS 2	MCS 3	MCS 4	MCS 5	MCS 6	MCS 7	MCS 8	MCS 9
			9.5	9.5	9.5	9.5	9.5	9.5	9.5	9.5	9.5	9.5
	5210 MHz *2)	11ac-VHT80 (MIMO)	MCS 0	MCS 1	MCS 2	MCS 3	MCS 4	MCS 5	MCS 6	MCS 7	MCS 8	MCS 9
			6.5	6.5	6.5	6.5	6.5	6.5	6.5	6.5	6.5	6.5
20 MHz	5260 MHz – 5320 MHz	11a	6 M	9 M	12 M	18 M	24 M	36 M	48 M	54 M	-	-
			13.5	13.5	13.5	13.5	13.5	13.5	13.5	13.5	-	-
	5260 MHz – 5320 MHz	11n-HT20 (SISO)	MCS 0	MCS 1	MCS 2	MCS 3	MCS 4	MCS 5	MCS 6	MCS 7	-	-
			13.5	13.5	13.5	13.5	13.5	13.5	13.5	13.5	-	-
	5260 MHz – 5320 MHz	11n-HT20 (MIMO)	MCS 8	MCS 9	MCS 10	MCS 11	MCS 12	MCS 13	MCS 14	MCS 15	-	-
			10.5	10.5	10.5	10.5	10.5	10.5	10.5	10.5	-	-
	5260 MHz – 5320 MHz	11ac-VHT20 (SISO)	MCS 0	MCS 1	MCS 2	MCS 3	MCS 4	MCS 5	MCS 6	MCS 7	MCS 8	-
			13.5	13.5	13.5	13.5	13.5	13.5	13.5	13.5	13.0	-
	5260 MHz – 5320 MHz	11ac-VHT20 (MIMO)	MCS 0	MCS 1	MCS 2	MCS 3	MCS 4	MCS 5	MCS 6	MCS 7	MCS 8	-
			10.5	10.5	10.5	10.5	10.5	10.5	10.5	10.5	10.5	-
40 MHz	5270 MHz – 5310 MHz	11n-HT40 (SISO)	MCS 0	MCS 1	MCS 2	MCS 3	MCS 4	MCS 5	MCS 6	MCS 7	-	-
			13.5	13.5	13.5	13.5	13.5	13.5	13.5	13.5	-	-
	5270 MHz – 5310 MHz	11n-HT40 (MIMO)	MCS 8	MCS 9	MCS 10	MCS 11	MCS 12	MCS 13	MCS 14	MCS 15	-	-
			10.5	10.5	10.5	10.5	10.5	10.5	10.5	10.5	-	-
	5270 MHz – 5310 MHz	11ac-VHT40 (SISO)	MCS 0	MCS 1	MCS 2	MCS 3	MCS 4	MCS 5	MCS 6	MCS 7	MCS 8	MCS 9
			13.5	13.5	13.5	13.5	13.5	13.5	13.5	13.5	13.0	13.0
5270 MHz – 5310 MHz	11ac-VHT40 (MIMO)	MCS 0	MCS 1	MCS 2	MCS 3	MCS 4	MCS 5	MCS 6	MCS 7	MCS 8	MCS 9	
		10.5	10.5	10.5	10.5	10.5	10.5	10.5	10.5	10.5	10.5	
80 MHz	5290 MHz *1)	11ac-VHT80 (SISO)	MCS 0	MCS 1	MCS 2	MCS 3	MCS 4	MCS 5	MCS 6	MCS 7	MCS 8	MCS 9
			9.5	9.5	9.5	9.5	9.5	9.5	9.5	9.5	9.5	9.5
	5290 MHz *2)	11ac-VHT80 (MIMO)	MCS 0	MCS 1	MCS 2	MCS 3	MCS 4	MCS 5	MCS 6	MCS 7	MCS 8	MCS 9
			6.5	6.5	6.5	6.5	6.5	6.5	6.5	6.5	6.5	6.5

\*1) All tests are carried out with 9.5 dBm setting regarding worst case although typical power setting is 9.0 dBm.

\*2) All tests are carried out with 6.5 dBm setting regarding worst case although typical power setting is 6.0 dBm.

#### 4.2 Configuration and peripherals

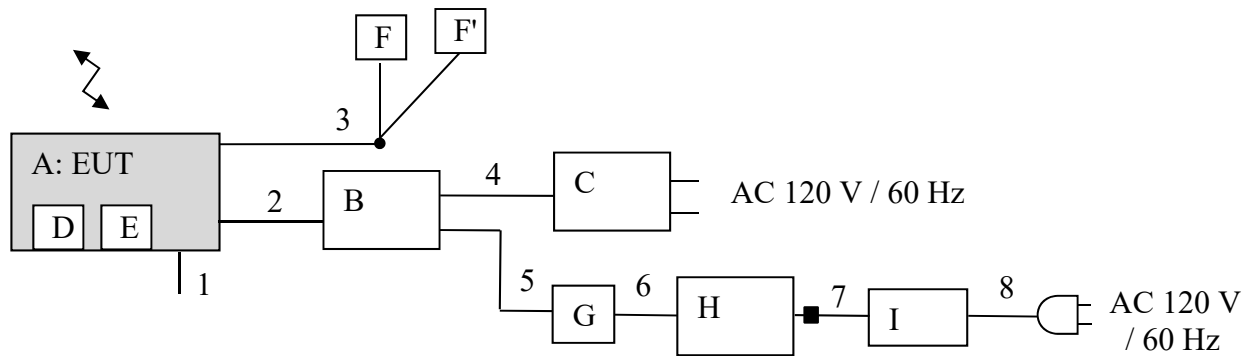

■: Standard Ferrite Core

\* Cabling and setup(s) were taken into consideration and test data was taken under worse case conditions.

#### Description of EUT and Support equipment

No.	Item	Model number	Serial number	Manufacturer	Remarks
A	Game Console	HDH-002	XJW01000026236 *1) XJW01000026052 *2)	Nintendo Co., Ltd.	EUT
B	SDEV Cradle	HAT-003	XZL0100007151	Nintendo Co., Ltd.	-
C	AC Adapter	HAC-002	-	Nintendo Co., Ltd.	-
D	Game Card	HAC-008	DFCAA22L000	Nintendo Co., Ltd.	-
E	Micro SD Card	-	-	Transcend	-
F, F'	Headphone	-	-	Nintendo Co., Ltd.	-
G	GIGA Ethernet Adapter	LAN-GTJU3	3495DB2BF5CA	Logitec	-
H	Laptop PC	CF-S10AWNDS	2BKSA58270	Panasonic	-
I	AC Adapter	CF-AA6402A M1	6402AM111Z03016A	Panasonic	-

\*1) Used for Maximum Peak Output Power

\*2) Used for Conducted Emission test and Radiated Emission test

#### List of cables used

No.	Cable Name	Length (m)	Shield		Remarks
			Cable	Connector	
1	Signal	0.1	Unshielded	Unshielded	*3)
2	USB	0.4	Shielded	Shielded	-
3	Headphone	0.5 + 0.3	Unshielded	Unshielded	-
4	USB	1.8	Shielded	Shielded	-
5	USB	0.15	Shielded	Shielded	-
6	LAN	0.5	Unshielded	Unshielded	-
7	DC	1.8	Unshielded	Unshielded	-
8	AC	1.0	Unshielded	Unshielded	-

\*3) This signal cable is used only for the settings of Bluetooth test mode, not used for the product.

## **SECTION 5 Maximum Conducted Output Power**

### **Test Procedure**

The tests were made with below setting connected to the antenna port.

Test	Span	RBW	VBW	Sweep time	Detector	Trace	Instrument used and Test method
Maximum Conducted Output Power	-	-	-	Auto	Average	-	Power Meter (Sensor: 160 MHz BW) (Method PM)

\* The test method was also referred to KDB 789033 D02 General UNII Test Procedures New Rules v02r01 "Guidelines for Compliance Testing of Unlicensed National Information Infrastructure (U-NII) Devices Part 15, Subpart E".

The test results and limit are rounded off to two decimals place, so some differences might be observed.  
The equipment and cables were not used for factor 0 dB of the data sheets.

**Test data** : APPENDIX  
**Test result** : Pass

## **SECTION 6: Radiated Spurious Emission and Band Edge Compliance**

### **Test Procedure**

< Above 1GHz >

EUT was placed on a platform of nominal size, 1.0 m by 1.5 m, raised 0.8 m above the conducting ground plane. The table is made of expanded polystyrol and expanded polypropylene and the table top is covered with polycarbonate. That has very low permittivity.

The Radiated Electric Field Strength has been measured in a Semi Anechoic Chamber with absorbent materials lined on a ground plane.

The height of the measuring antenna varied between 1 m and 4 m and EUT was rotated a full revolution in order to obtain the maximum value of the electric field strength.

The measurements were performed for both vertical and horizontal antenna polarization with the Test Receiver, or the Spectrum Analyzer.

The measurements were made with the following detector function of the test receiver and the Spectrum analyzer (in linear mode).

The test was made with the detector (RBW/VBW) in the following table.

When using Spectrum analyzer, the test was made with adjusting span to zero by using peak hold.

< Above 1GHz >

Inside of restricted bands (Section 15.205):

Apply to limit in the Section 15.209 (a).

Outside of the restricted bands:

Apply to limit 68.2 dBuV/m, 3 m (-27 dBm e.i.r.p.\* ) in the Section 15.407 (b) (1) (2) (3).

For U-NII-3 Bandedge

-27 dBm/MHz at 75 MHz or more above or below the band edge increasing linearly to 10 dBm/MHz at 25 MHz above or below the band edge, and from 25 MHz above or below the band edge increasing linearly to a level of 15.6 dBm/MHz at 5 MHz above or below the band edge, and from 5 MHz above or below the band edge increasing linearly to a level of 27 dBm/MHz at the band edge in the section 15.407(b)(4)(i).

Restricted band edge:

Apply to limit in the Section 15.209 (a).

Since this limit is severer than the limit of the inside of restricted bands.

\*Electric field strength to e.i.r.p. conversion:

$$E = \frac{1000000 \sqrt{30 P}}{3} \text{ (uV/m)} \quad : P \text{ is the e.i.r.p. (Watts)}$$

---

**UL Japan, Inc.**

**Shonan EMC Lab.**

1-22-3 Megumigaoka, Hiratsuka-shi, Kanagawa-ken, 259-1220 JAPAN

Telephone : +81 463 50 6400

Facsimile : +81 463 50 6401

**Test Antennas are used as below;**

Frequency	Above 1 GHz
Antenna Type	Horn

Frequency	Above 1 GHz	
Instrument used	Spectrum Analyzer	
Detector	Peak	Average
IF Bandwidth	RBW: 1 MHz VBW: 3 MHz	Method VB *1) RBW: 1 MHz VBW: 1/T MHz (T: burst length, refer to APPENDIX) Detector: Peak Trace: Max hold

\*1) The test method was also referred to KDB 789033 D02 General UNII Test Procedures New Rules v02r01 "Guidelines for Compliance Testing of Unlicensed National Information Infrastructure (U-NII) Devices Part 15, Subpart E".

**Figure 1: Test Setup**

1 GHz - 13 GHz

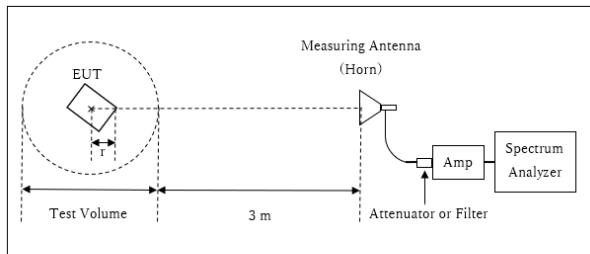

r : Radius of an outer periphery of EUT  
x : Center of turn table

Distance Factor:  $20 \times \log(3.89 \text{ m} / 3.0 \text{ m}) = 2.26 \text{ dB}$

\* Test Distance:  $(3 + \text{Test Volume} / 2) - r = 3.89 \text{ m}$

Test Volume : 2.0 m

(Test Volume has been calibrated based on CISPR 16-1-4.)

$r = 0.11 \text{ m}$

- The carrier level and noise levels were confirmed at each position of X, Y and Z axes of EUT to see the position of maximum noise, and the test was made at the position that has the maximum noise.

Mode	Frequency		Carrier	1 GHz - 6.4 GHz	6.4 GHz - 13 GHz
	Test Antenna				
SISO	Horizontal		X	X	X
	Vertical		Y	Y	X
MIMO	Horizontal		Z	Z	X
	Vertical		Z	Z	X

\*The worst condition was determined based on the test result of HDH-001 (12656071S-J-R1).

The test results and limit are rounded off to one decimal place, so some differences might be observed.

**Measurement range** : 1 GHz - 13 GHz  
**Test data** : APPENDIX  
**Test result** : Pass

**APPENDIX 1: Test data****Maximum Conducted Output Power**

Test place                      Shonan EMC Lab. No.1 Measurement Room  
Date                                March 31, 2019  
Temperature / Humidity        20 deg. C / 48 % RH  
Engineer                         Kazutaka Takeyama  
Mode                                Tx, IEEE802.11a, PN9, worst antenna port 0

Applied limit: 15.407, mobile and portable client device

Tested Frequency [MHz]	Power Meter Reading [dBm]	Cable Loss [dB]	Atten. Loss [dB]	Duty Factor [dB]	Antenna Gain [dBi]	Conducted Power				e.i.r.p.			
						Result [dBm]	[mW]	Limit [dBm]	Margin [dB]	Result [dBm]	[mW]	Limit [dBm]	Margin [dB]
5180	-2.47	3.89	10.21	1.72	2.95	13.35	21.63	23.97	10.62	16.30	42.66	29.97	13.67
5220	-2.46	3.90	10.21	1.72	2.95	13.37	21.73	23.97	10.60	16.32	42.85	29.97	13.65
5240	-2.33	3.90	10.21	1.72	2.95	13.50	22.39	23.97	10.47	16.45	44.16	29.97	13.52
5260	-2.34	3.91	10.21	1.72	2.95	13.50	22.39	23.97	10.47	16.45	44.16	29.97	13.52
5300	-2.25	3.92	10.21	1.72	2.95	13.60	22.91	23.97	10.37	16.55	45.19	29.97	13.42
5320	-2.17	3.92	10.21	1.72	2.95	13.68	23.33	23.97	10.29	16.63	46.03	29.97	13.34

Sample Calculation:

Conducted Power Result = Reading + Cable Loss (including the cable(s) customer supplied) + Atten. Loss + Duty Factor

e.i.r.p. Result = Conducted Power Result + Antenna Gain

Conducted Power Limit (5250 MHz-5350 MHz, 5470 MHz-5725 MHz) = 250 mW or (11 + 10logB) dBm, whichever is

Conducted Power Limit (5725 MHz-5850 MHz) = 1 W

Although the EUT operates on Master mode, more stringent limit for Client device was applied. (W52 for FCC)



## Maximum Conducted Output Power

Test place	Shonan EMC Lab. No.1 Measurement Room
Date	March 31, 2019
Temperature / Humidity	20 deg. C / 48 % RH
Engineer	Kazutaka Takeyama
Mode	Tx, IEEE802.11n HT20 (SISO), PN9, worst antenna port 0

Applied limit: 15.407, mobile and portable client device

Tested Frequency [MHz]	Power Meter Reading [dBm]	Cable Loss [dB]	Atten. Loss [dB]	Duty Factor [dB]	Antenna Gain [dBi]	Conducted Power				e.i.r.p.			
						Result [dBm]	[mW]	Limit [dBm]	Margin [dB]	Result [dBm]	[mW]	Limit [dBm]	Margin [dB]
5180	-2.87	3.89	10.21	1.81	2.95	13.04	20.14	23.97	10.93	15.99	39.72	29.97	13.98
5220	-2.66	3.90	10.21	1.81	2.95	13.26	21.18	23.97	10.71	16.21	41.78	29.97	13.76
5240	-2.77	3.90	10.21	1.81	2.95	13.15	20.65	23.97	10.82	16.10	40.74	29.97	13.87
5260	-2.48	3.91	10.21	1.81	2.95	13.45	22.13	23.97	10.52	16.40	43.65	29.97	13.57
5300	-2.42	3.92	10.21	1.81	2.95	13.52	22.49	23.97	10.45	16.47	44.36	29.97	13.50
5320	-2.28	3.92	10.21	1.81	2.95	13.66	23.23	23.97	10.31	16.61	45.81	29.97	13.36

Sample Calculation:

Conducted Power Result = Reading + Cable Loss (including the cable(s) customer supplied) + Atten. Loss + Duty Factor

e.i.r.p. Result = Conducted Power Result + Antenna Gain

Conducted Power Limit (5250 MHz-5350 MHz, 5470 MHz-5725 MHz) = 250 mW or (11 + 10logB) dBm, whichever is

Conducted Power Limit (5725 MHz-5850 MHz) = 1 W

Although the EUT operates on Master mode, more stringent limit for Client device was applied. (W52 for FCC)

## Maximum Conducted Output Power

Test place	Shonan EMC Lab. No.1 Measurement Room
Date	March 31, 2019
Temperature / Humidity	20 deg. C / 48 % RH
Engineer	Kazutaka Takeyama
Mode	Tx, IEEE802.11ac VHT20 (SISO), PN9, worst antenna port 0

Applied limit: 15.407, mobile and portable client device

Tested Frequency [MHz]	Power Meter Reading [dBm]	Cable Loss [dB]	Atten. Loss [dB]	Duty Factor [dB]	Antenna Gain [dBi]	Conducted Power				e.i.r.p.			
						Result [dBm]	[mW]	Limit [dBm]	Margin [dB]	Result [dBm]	[mW]	Limit [dBm]	Margin [dB]
5180	-1.76	3.89	10.21	1.01	2.95	13.35	21.63	23.97	10.62	16.30	42.66	29.97	13.67
5220	-1.58	3.90	10.21	1.01	2.95	13.54	22.59	23.97	10.43	16.49	44.57	29.97	13.48
5240	-1.71	3.90	10.21	1.01	2.95	13.41	21.93	23.97	10.56	16.36	43.25	29.97	13.61
5260	-1.47	3.91	10.21	1.01	2.95	13.66	23.23	23.97	10.31	16.61	45.81	29.97	13.36
5300	-1.34	3.92	10.21	1.01	2.95	13.80	23.99	23.97	10.17	16.75	47.32	29.97	13.22
5320	-1.20	3.92	10.21	1.01	2.95	13.94	24.77	23.97	10.03	16.89	48.87	29.97	13.08

Sample Calculation:

Conducted Power Result = Reading + Cable Loss (including the cable(s) customer supplied) + Atten. Loss + Duty Factor

e.i.r.p. Result = Conducted Power Result + Antenna Gain

Conducted Power Limit (5250 MHz-5350 MHz, 5470 MHz-5725 MHz) = 250 mW or (11 + 10logB) dBm, whichever is

Conducted Power Limit (5725 MHz-5850 MHz) = 1 W

Although the EUT operates on Master mode, more stringent limit for Client device was applied. (W52 for FCC)

## Maximum Conducted Output Power

Test place	Shonan EMC Lab. No.1 Measurement Room
Date	April 4, 2019
Temperature / Humidity	22 deg. C / 40 % RH
Engineer	Yosuke Ishikawa
Mode	Tx, IEEE802.11n HT20 (MIMO), PN9

Antenna 0+1							Applied limit: 15.407, mobile and portable client device						
Tested Frequency [MHz]	Conducted power						e.i.r.p.						
	0 [mW]	1 [mW]	Sum [mW]	Result [dBm]	Limit [dBm]	Margin [dB]	0 [mW]	1 [mW]	Sum [mW]	Result [dBm]	Limit [dBm]	Margin [dB]	
5180	9.79	11.12	20.91	13.20	23.97	10.77	19.32	17.58	36.89	15.67	29.97	14.30	
5220	10.38	11.19	21.57	13.34	23.97	10.63	20.46	17.70	38.16	15.82	29.97	14.15	
5240	10.07	10.74	20.81	13.18	23.97	10.79	19.86	16.98	36.84	15.66	29.97	14.31	
5260	10.12	11.67	21.78	13.38	23.97	10.59	19.95	18.45	38.40	15.84	29.97	14.13	
5300	10.69	11.22	21.91	13.41	23.97	10.56	21.08	17.74	38.82	15.89	29.97	14.08	
5320	10.96	11.38	22.34	13.49	23.97	10.48	21.62	17.99	39.61	15.98	29.97	13.99	

Tested Frequency [MHz]	Duty Factor [dB]	Antenna 0						Antenna 1					
		Power Meter Reading [dBm]	Cable Loss [dB]	Atten. Loss [dB]	Antenna Gain [dBi]	Result Cond. Power [dBm]	e.i.r.p. [dBm]	Power Meter Reading [dBm]	Cable Loss [dB]	Atten. Loss [dB]	Antenna Gain [dBi]	Result Cond. Power [dBm]	e.i.r.p. [dBm]
5180	2.76	-6.95	3.89	10.21	2.95	9.91	12.86	-6.40	3.89	10.21	1.99	10.46	12.45
5220	2.76	-6.71	3.90	10.21	2.95	10.16	13.11	-6.38	3.90	10.21	1.99	10.49	12.48
5240	2.76	-6.84	3.90	10.21	2.95	10.03	12.98	-6.56	3.90	10.21	1.99	10.31	12.30
5260	2.76	-6.83	3.91	10.21	2.95	10.05	13.00	-6.21	3.91	10.21	1.99	10.67	12.66
5300	2.76	-6.60	3.92	10.21	2.95	10.29	13.24	-6.39	3.92	10.21	1.99	10.50	12.49
5320	2.76	-6.49	3.92	10.21	2.95	10.40	13.35	-6.33	3.92	10.21	1.99	10.56	12.55

Sample Calculation:

Conducted Power Result = Reading + Cable Loss (including the cable(s) customer supplied) + Atten. Loss + Duty Factor

e.i.r.p. Result = Conducted Power Result + Antenna Gain

Conducted Power Limit (5250 MHz-5350 MHz, 5470 MHz-5725 MHz) = 250 mW or (11 + 10logB) dBm, whichever is

Conducted Power Limit (5725 MHz-5850 MHz) = 1 W

Although the EUT operates on Master mode, more stringent limit for Client device was applied. (W52 for FCC)

## Maximum Conducted Output Power

Test place	Shonan EMC Lab. No.1 Measurement Room
Date	April 4, 2019
Temperature / Humidity	22 deg. C / 40 % RH
Engineer	Yosuke Ishikawa
Mode	Tx, IEEE802.11ac VHT20 (MIMO), PN9

**Antenna 0+1** Applied limit: 15.407, mobile and portable client device

Tested Frequency [MHz]	Conducted power						e.i.r.p.					
	Antenna			Result [dBm]	Limit [dBm]	Margin [dB]	Antenna			Result [dBm]	Limit [dBm]	Margin [dB]
	0 [mW]	1 [mW]	Sum [mW]				0 [mW]	1 [mW]	Sum [mW]			
5180	10.02	11.78	21.80	13.38	23.97	10.59	19.77	18.62	38.39	15.84	29.97	14.13
5220	10.57	11.17	21.74	13.37	23.97	10.60	20.84	17.66	38.50	15.85	29.97	14.12
5240	10.30	10.47	20.78	13.18	23.97	10.79	20.32	16.56	36.88	15.67	29.97	14.30
5260	10.21	11.32	21.53	13.33	23.97	10.64	20.13	17.91	38.04	15.80	29.97	14.17
5300	10.94	11.75	22.69	13.56	23.97	10.41	21.57	18.58	40.15	16.04	29.97	13.93
5320	10.79	11.86	22.65	13.55	23.97	10.42	21.28	18.75	40.03	16.02	29.97	13.95

Tested Frequency [MHz]	Duty Factor [dB]	Antenna 0						Antenna 1					
		Power Meter Reading [dBm]	Cable Loss [dB]	Atten. Loss [dB]	Antenna Gain [dBi]	Result		Power Meter Reading [dBm]	Cable Loss [dB]	Atten. Loss [dB]	Antenna Gain [dBi]	Result	
						Cond. Power [dBm]	e.i.r.p. [dBm]					Cond. Power [dBm]	e.i.r.p. [dBm]
5180	2.08	-6.17	3.89	10.21	2.95	10.01	12.96	-5.47	3.89	10.21	1.99	10.71	12.70
5220	2.08	-5.95	3.90	10.21	2.95	10.24	13.19	-5.71	3.90	10.21	1.99	10.48	12.47
5240	2.08	-6.06	3.90	10.21	2.95	10.13	13.08	-5.99	3.90	10.21	1.99	10.20	12.19
5260	2.08	-6.11	3.91	10.21	2.95	10.09	13.04	-5.66	3.91	10.21	1.99	10.54	12.53
5300	2.08	-5.82	3.92	10.21	2.95	10.39	13.34	-5.51	3.92	10.21	1.99	10.70	12.69
5320	2.08	-5.88	3.92	10.21	2.95	10.33	13.28	-5.47	3.92	10.21	1.99	10.74	12.73

Sample Calculation:

Conducted Power Result = Reading + Cable Loss (including the cable(s) customer supplied) + Atten. Loss + Duty Factor

e.i.r.p. Result = Conducted Power Result + Antenna Gain

Conducted Power Limit (5250 MHz-5350 MHz, 5470 MHz-5725 MHz) = 250 mW or (11 + 10logB) dBm, whichever is

Conducted Power Limit (5725 MHz-5850 MHz) = 1 W

Although the EUT operates on Master mode, more stringent limit for Client device was applied. (W52 for FCC)

## Maximum Conducted Output Power

Test place                   Shonan EMC Lab. No.1 Measurement Room  
 Date                            March 31, 2019  
 Temperature / Humidity    20 deg. C / 48 % RH  
 Engineer                     Kazutaka Takeyama  
 Mode                          Tx, IEEE802.11n HT40 (SISO), PN9,  
                                   worst antenna port 1 (5190 MHz), 0 (other channel frequency)

Applied limit: 15.407, mobile and portable client device

Tested Frequency [MHz]	Power Meter Reading [dBm]	Cable Loss [dB]	Atten. Loss [dB]	Duty Factor [dB]	Antenna Gain [dBi]	Conducted Power			e.i.r.p.					
						Result [dBm]	Limit [dBm]	Margin [dB]	Result [dBm]	Limit [dBm]	Margin [dB]	Result [mW]	Limit [dBm]	Margin [dB]
5190	-6.82	3.89	10.21	2.63	1.99	9.91	9.79	23.97	14.06	11.90	15.50	29.97	18.07	-
-	-	-	-	-	-	-	-	-	-	-	-	-	-	-
5230	-3.06	3.90	10.21	1.76	2.95	12.81	19.10	23.97	11.16	15.76	37.67	29.97	14.21	-
5270	-2.82	3.91	10.21	1.76	2.95	13.06	20.23	23.97	10.91	16.01	39.90	29.97	13.96	-
-	-	-	-	-	-	-	-	-	-	-	-	-	-	-
5310	-2.73	3.92	10.21	1.76	2.95	13.16	20.70	23.97	10.81	16.11	40.83	29.97	13.86	-

Sample Calculation:

Conducted Power Result = Reading + Cable Loss (including the cable(s) customer supplied) + Atten. Loss + Duty Factor

e.i.r.p. Result = Conducted Power Result + Antenna Gain

Conducted Power Limit (5250 MHz-5350 MHz, 5470 MHz-5725 MHz) = 250 mW or (11 + 10logB) dBm, whichever is

Conducted Power Limit (5725 MHz-5850 MHz) = 1 W

Although the EUT operates on Master mode, more stringent limit for Client device was applied. (W52 for FCC)

## Maximum Conducted Output Power

Test place                   Shonan EMC Lab. No.1 Measurement Room  
Date                            March 31, 2019  
Temperature / Humidity    20 deg. C / 48 % RH  
Engineer                     Kazutaka Takeyama  
Mode                          Tx, IEEE802.11ac VHT40 (SISO), PN9,  
                                  worst antenna port 1 (5190 MHz), 0 (other channel frequency)

Applied limit: 15.407, mobile and portable client device

Tested Frequency [MHz]	Power Meter Reading [dBm]	Cable Loss [dB]	Atten. Loss [dB]	Duty Factor [dB]	Antenna Gain [dBi]	Conducted Power			e.i.r.p.				
						Result [dBm]	Limit [dBm]	Margin [dB]	Result [dBm]	Limit [dBm]	Margin [dB]		
5190	-6.61	3.89	10.21	2.15	1.99	9.64	9.20	23.97	14.33	11.63	14.55	29.97	18.34
-	-	-	-	-	-	-	-	-	-	-	-	-	-
5230	-2.58	3.90	10.21	1.39	2.95	12.92	19.59	23.97	11.05	15.87	38.64	29.97	14.10
5270	-2.62	3.91	10.21	1.39	2.95	12.89	19.45	23.97	11.08	15.84	38.37	29.97	14.13
-	-	-	-	-	-	-	-	-	-	-	-	-	-
5310	-2.50	3.92	10.21	1.39	2.95	13.02	20.04	23.97	10.95	15.97	39.54	29.97	14.00

Sample Calculation:

Conducted Power Result = Reading + Cable Loss (including the cable(s) customer supplied) + Atten. Loss + Duty Factor

e.i.r.p. Result = Conducted Power Result + Antenna Gain

Conducted Power Limit (5250 MHz-5350 MHz, 5470 MHz-5725 MHz) = 250 mW or (11 + 10logB) dBm, whichever is

Conducted Power Limit (5725 MHz-5850 MHz) = 1 W

## Maximum Conducted Output Power

Test place	Shonan EMC Lab. No.1 Measurement Room
Date	April 4, 2019
Temperature / Humidity	22 deg. C / 40 % RH
Engineer	Yosuke Ishikawa
Mode	Tx, IEEE802.11n HT40 (MIMO), PN9

**Antenna 0+1** Applied limit: 15.407, mobile and portable client device

Tested Frequency [MHz]	Conducted power						e.i.r.p.					
	Antenna			Result [dBm]	Limit [dBm]	Margin [dB]	Antenna			Result [dBm]	Limit [dBm]	Margin [dB]
	0 [mW]	1 [mW]	Sum [mW]				0 [mW]	1 [mW]	Sum [mW]			
5190	3.66	4.05	7.71	8.87	23.97	15.10	7.23	6.40	13.62	11.34	29.97	18.63
-	-	-	-	-	-	-	-	-	-	-	-	-
5230	9.79	10.45	20.24	13.06	23.97	10.91	19.32	16.52	35.83	15.54	29.97	14.43
5270	9.98	11.17	21.15	13.25	23.97	10.72	19.67	17.66	37.33	15.72	29.97	14.25
-	-	-	-	-	-	-	-	-	-	-	-	-
5310	10.33	11.30	21.63	13.35	23.97	10.62	20.37	17.86	38.23	15.82	29.97	14.15

Tested Frequency [MHz]	Duty Factor [dB]	Antenna 0					Antenna 1							
		Power Meter Reading [dBm]	Cable Loss [dB]	Atten. Loss [dB]	Antenna Gain [dBi]	Result		Power Meter Reading [dBm]	Cable Loss [dB]	Atten. Loss [dB]	Antenna Gain [dBi]	Result		
						Cond. Power [dBm]	e.i.r.p. [dBm]					Cond. Power [dBm]	e.i.r.p. [dBm]	
5190	3.59	-11.82	3.93	9.94	2.95	5.64	8.59	-11.39	3.93	9.94	1.99	6.07	8.06	
-	-	-	-	-	-	-	-	-	-	-	-	-	-	
5230	2.51	-6.71	3.90	10.21	2.95	9.91	12.86	-6.43	3.90	10.21	1.99	10.19	12.18	
5270	2.51	-6.64	3.91	10.21	2.95	9.99	12.94	-6.15	3.91	10.21	1.99	10.48	12.47	
-	-	-	-	-	-	-	-	-	-	-	-	-	-	
5310	2.51	-6.50	3.92	10.21	2.95	10.14	13.09	-6.11	3.92	10.21	1.99	10.53	12.52	

Sample Calculation:

Conducted Power Result = Reading + Cable Loss (including the cable(s) customer supplied) + Atten. Loss + Duty Factor

e.i.r.p. Result = Conducted Power Result + Antenna Gain

Conducted Power Limit (5250 MHz-5350 MHz, 5470 MHz-5725 MHz) = 250 mW or (11 + 10logB) dBm, whichever is

Conducted Power Limit (5725 MHz-5850 MHz) = 1 W

Although the EUT operates on Master mode, more stringent limit for Client device was applied. (W52 for FCC)

\*In the measurement of 5190MHz, a EUT of serial number different from the worst rate check is used.

**UL Japan, Inc.**

**Shonan EMC Lab.**

1-22-3 Megumigaoka, Hiratsuka-shi, Kanagawa-ken, 259-1220 JAPAN

Telephone : +81 463 50 6400

Facsimile : +81 463 50 6401

## Maximum Conducted Output Power

Test place	Shonan EMC Lab. No.1 Measurement Room
Date	April 4, 2019
Temperature / Humidity	22 deg. C / 40 % RH
Engineer	Yosuke Ishikawa
Mode	Tx, IEEE802.11ac VHT40 (MIMO), PN9

**Antenna 0+1** Applied limit: 15.407, mobile and portable client device

Tested Frequency [MHz]	Conducted power						e.i.r.p.					
	Antenna 0			Antenna 1			Antenna 0			Antenna 1		
	0	1	Sum	Result	Limit	Margin	0	1	Sum	Result	Limit	Margin
	[mW]	[mW]	[mW]	[dBm]	[dBm]	[dB]	[mW]	[mW]	[mW]	[dBm]	[dBm]	[dB]
5190	3.64	4.20	7.84	8.94	23.97	15.03	7.18	6.64	13.81	11.40	29.97	18.57
-	-	-	-	-	-	-	-	-	-	-	-	-
5230	9.91	11.19	21.10	13.24	23.97	10.73	19.54	17.70	37.24	15.71	29.97	14.26
5270	9.84	10.94	20.78	13.18	23.97	10.79	19.40	17.30	36.70	15.65	29.97	14.32
-	-	-	-	-	-	-	-	-	-	-	-	-
5310	10.05	10.86	20.91	13.20	23.97	10.77	19.81	17.18	36.99	15.68	29.97	14.29

Tested Frequency [MHz]	Duty Factor [dB]	Antenna 0						Antenna 1					
		Power Meter Reading [dBm]	Cable Loss [dB]	Atten. Loss [dB]	Antenna Gain [dBi]	Result Cond. Power [dBm]	Result e.i.r.p. [dBm]	Power Meter Reading [dBm]	Cable Loss [dB]	Atten. Loss [dB]	Antenna Gain [dBi]	Result Cond. Power [dBm]	Result e.i.r.p. [dBm]
5190	2.87	-11.13	3.93	9.94	2.95	5.61	8.56	-10.51	3.93	9.94	1.99	6.23	8.22
-	-	-	-	-	-	-	-	-	-	-	-	-	-
5230	3.39	-7.54	3.90	10.21	2.95	9.96	12.91	-7.01	3.90	10.21	1.99	10.49	12.48
5270	3.39	-7.58	3.91	10.21	2.95	9.93	12.88	-7.12	3.91	10.21	1.99	10.39	12.38
-	-	-	-	-	-	-	-	-	-	-	-	-	-
5310	3.39	-7.50	3.92	10.21	2.95	10.02	12.97	-7.16	3.92	10.21	1.99	10.36	12.35

Sample Calculation:

Conducted Power Result = Reading + Cable Loss (including the cable(s) customer supplied) + Atten. Loss + Duty Factor

e.i.r.p. Result = Conducted Power Result + Antenna Gain

Conducted Power Limit (5250 MHz-5350 MHz, 5470 MHz-5725 MHz) = 250 mW or (11 + 10logB) dBm, whichever is

Conducted Power Limit (5725 MHz-5850 MHz) = 1 W

Although the EUT operates on Master mode, more stringent limit for Client device was applied. (W52 for FCC)

\*In the measurement of 5190MHz, a EUT of serial number different from the worst rate check is used.

**UL Japan, Inc.**

**Shonan EMC Lab.**

1-22-3 Megumigaoka, Hiratsuka-shi, Kanagawa-ken, 259-1220 JAPAN

Telephone : +81 463 50 6400

Facsimile : +81 463 50 6401



## Maximum Conducted Output Power

Test place                   Shonan EMC Lab. No.1 Measurement Room  
 Date                         March 31, 2019  
 Temperature / Humidity   20 deg. C / 48 % RH  
 Engineer                  Kazutaka Takeyama  
 Mode                        Tx, IEEE802.11ac VHT80 (SISO), PN9,  
                               worst antenna port : 1

Applied limit: 15.407, mobile and portable client device

Tested Frequency [MHz]	Power Meter Reading [dBm]	Cable Loss [dB]	Atten. Loss [dB]	Duty Factor [dB]	Antenna Gain [dBi]	Conducted Power			e.i.r.p.				
						Result [dBm]	Limit [dBm]	Margin [dB]	Result [dBm]	Limit [dBm]	Margin [dB]	Result [mW]	Limit [dBm]
5210	-9.42	3.89	10.21	3.33	1.99	8.01	6.32	23.97	15.96	10.00	10.00	29.97	19.97
-	-	-	-	-	-	-	-	-	-	-	-	-	-
5290	-9.27	3.92	10.21	3.33	1.99	8.19	6.59	23.97	15.78	10.18	10.42	29.97	19.79
-	-	-	-	-	-	-	-	-	-	-	-	-	-
-	-	-	-	-	-	-	-	-	-	-	-	-	-

Sample Calculation:

Conducted Power Result = Reading + Cable Loss (including the cable(s) customer supplied) + Atten. Loss + Duty Factor

e.i.r.p. Result = Conducted Power Result + Antenna Gain

Conducted Power Limit (5250 MHz-5350 MHz, 5470 MHz-5725 MHz) = 250 mW or (11 + 10logB) dBm, whichever is

Conducted Power Limit (5725 MHz-5850 MHz) = 1 W

Although the EUT operates on Master mode, more stringent limit for Client device was applied. (W52 for FCC)

\*In the measurement of 5210MHz, a EUT of serial number different from the worst rate check is used.

## Maximum Conducted Output Power

Test place                   Shonan EMC Lab. No.1 Measurement Room  
Date                            April 4, 2019  
Temperature / Humidity      22 deg. C / 40 % RH  
Engineer                     Yosuke Ishikawa  
Mode                          Tx, IEEE802.11ac VHT80 (MIMO), PN9

**Antenna 0+1** Applied limit: 15.407, mobile and portable client device

Tested Frequency [MHz]	Conducted power						e.i.r.p.					
	1 [mW]	2 [mW]	Sum [mW]	Result [dBm]	Limit [dBm]	Margin [dB]	1 [mW]	2 [mW]	Sum [mW]	Result [dBm]	Limit [dBm]	Margin [dB]
5210	2.99	3.33	6.32	8.01	23.97	15.96	5.89	5.27	11.16	10.48	29.97	19.49
-	-	-	-	-	-	-	-	-	-	-	-	-
5290	3.38	3.36	6.74	8.29	23.97	15.68	6.67	5.31	11.98	10.78	29.97	19.19
-	-	-	-	-	-	-	-	-	-	-	-	-
-	-	-	-	-	-	-	-	-	-	-	-	-

Tested Frequency [MHz]	Duty Factor [dB]	Antenna 0					Antenna 1					Result e.i.r.p. [dBm]	Result e.i.r.p. [dBm]
		Power Meter Reading [dBm]	Cable Loss [dB]	Atten. Loss [dB]	Antenna Gain [dBi]	Cond. Power [dBm]	Power Meter Reading [dBm]	Cable Loss [dB]	Atten. Loss [dB]	Antenna Gain [dBi]	Cond. Power [dBm]		
5210	3.84	-13.19	3.89	10.21	2.95	4.75	7.70	-12.71	3.89	10.21	1.99	5.23	7.22
-	-	-	-	-	-	-	-	-	-	-	-	-	-
5290	3.84	-12.68	3.92	10.21	2.95	5.29	8.24	-12.71	3.92	10.21	1.99	5.26	7.25
-	-	-	-	-	-	-	-	-	-	-	-	-	-
-	-	-	-	-	-	-	-	-	-	-	-	-	-

Sample Calculation:

Conducted Power Result = Reading + Cable Loss (including the cable(s) customer supplied) + Atten. Loss + Duty Factor

e.i.r.p. Result = Conducted Power Result + Antenna Gain

Conducted Power Limit (5250 MHz-5350 MHz, 5470 MHz-5725 MHz) = 250 mW or (11 + 10logB) dBm, whichever is

Conducted Power Limit (5725 MHz-5850 MHz) = 1 W

Although the EUT operates on Master mode, more stringent limit for Client device was applied. (W52 for FCC)

\*In the measurement of 5210MHz, a EUT of serial number different from the worst rate check is used.

## Radiated Emission

Report No.  
 Test place           Shonan EMC Lab.  
 Semi Anechoic Chamber No.3  
 Date                    April 3, 2019  
 Temperature / Humidity 21 deg. C / 36 % RH  
 Engineer               Kenichi Adachi  
                               (1 GHz - 6.4 GHz)  
 Mode                   Tx,                    5180 MHz  
                               Tx, IEEE802.11ac VHT20 (SISO)

### (below 1GHz and above 1GHz Inside of the restricted band)

(\* PK: Peak, AV: Average, QP: Quasi-Peak)

Polarity	Frequency [MHz]	Detector	Reading [dBuV]	Ant.Fac. [dB/m]	Loss [dB]	Gain [dB]	Distance Factor [dB]	Result [dBuV/m]	Limit [dBuV/m]	Margin [dB]	Height [cm]	Angle [deg.]	Remark
Hori.	5150.000	PK	54.29	32.18	16.32	43.04	2.26	62.01	73.90	11.8	148	343	VBW:2.7 kHz
Hori.	5150.000	AV	39.32	32.18	16.32	43.04	2.26	47.04	53.90	<b>6.8</b>	148	343	
Vert.	5150.000	PK	51.94	32.18	16.32	43.04	2.26	59.66	73.90	14.2	180	64	VBW:2.7 kHz
Vert.	5150.000	AV	38.85	32.18	16.32	43.04	2.26	46.57	53.90	7.3	180	64	

Result [dBuV/m] = Reading + Ant.Fac. + Loss (Cable+(Attenuator or Filter)(below 18 GHz)) - Gain(Amplifier) + Distance factor

\*Other frequency noises omitted in this report were not seen or have enough margin (more than 20dB).

\*The 4th harmonic was not seen so the result was its base noise level

Distance factor : 1 GHz - 13 GHz :  $20\log(3.89\text{ m} / 3.0\text{ m}) = 2.26\text{ dB}$

13 GHz - 40 GHz :  $20\log(1.0\text{ m} / 3.0\text{ m}) = -9.54\text{ dB}$

**UL Japan, Inc.**

**Shonan EMC Lab.**

1-22-3 Megumigaoka, Hiratsuka-shi, Kanagawa 259-1220 JAPAN

Telephone : +81 463 50 6400

Facsimile : +81 463 50 6401

**Radiated Spurious Emission**  
**(Reference Plot for band-edge)**

Test place	Shonan EMC Lab.
Semi Anechoic Chamber	No.3
Date	April 3, 2019
Temperature / Humidity	21 deg. C / 36 % RH
Engineer	Kenichi Adachi
	(1 GHz – 6.4 GHz)
Mode	Tx, OFDM VHT20 (SISO) ,5180 MHz

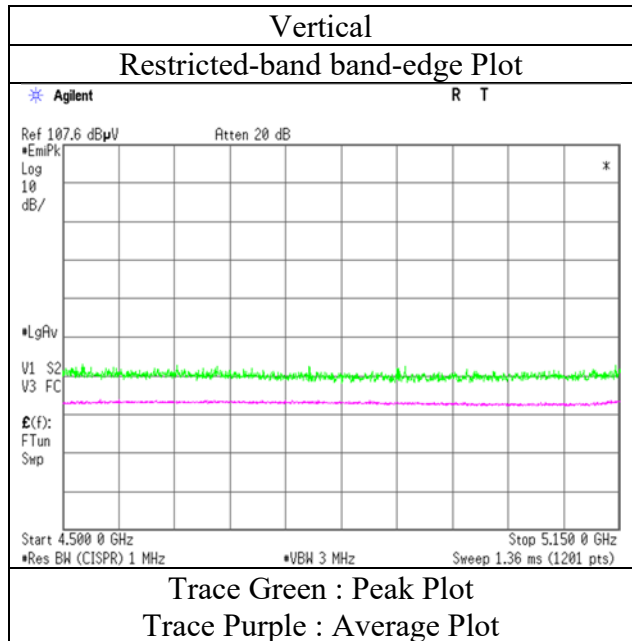
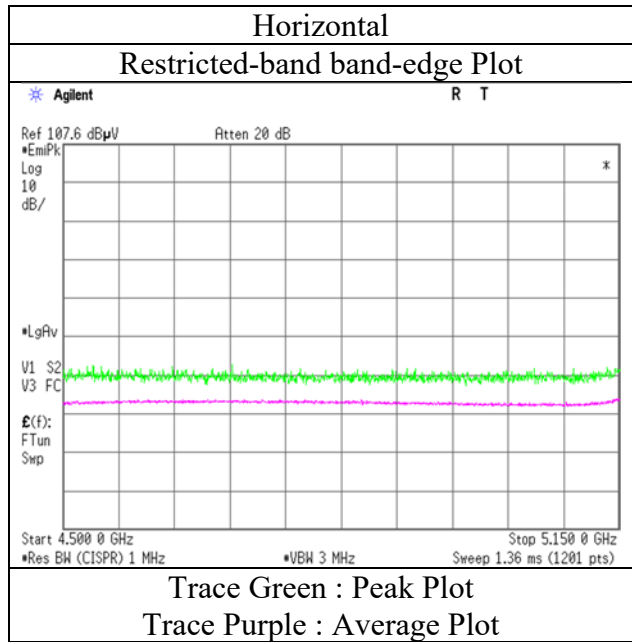

\* The measurement was conducted for a sufficiently long enough time to detect any possible spurious emissions.  
 Final result of restricted band edge was shown in tabular data.

**UL Japan, Inc.**  
**Shonan EMC Lab.**

1-22-3 Megumigaoka, Hiratsuka-shi, Kanagawa-ken, 259-1220 JAPAN  
 Telephone : +81 463 50 6400  
 Facsimile : +81 463 50 6401

## Radiated Emission

Report No.  
 Test place           Shonan EMC Lab.  
 Semi Anechoic Chamber No.3  
 Date                    April 3, 2019  
 Temperature / Humidity 21 deg. C / 36 % RH  
 Engineer               Kenichi Adachi  
                               (1 GHz - 6.4 GHz)  
 Mode                   Tx,                    5320 MHz  
                               Tx, IEEE802.11ac VHT20 (SISO)

### (below 1GHz and above 1GHz Inside of the restricted band)

(\* PK: Peak, AV: Average, QP: Quasi-Peak)

Polarity	Frequency [MHz]	Detector	Reading [dBuV]	Ant.Fac. [dB/m]	Loss [dB]	Gain [dB]	Distance Factor [dB]	Result [dBuV/m]	Limit [dBuV/m]	Margin [dB]	Height [cm]	Angle [deg.]	Remark
Hori.	5350.000	PK	56.56	31.73	16.40	43.21	2.26	63.74	73.90	10.1	110	339	VBW:2.7 kHz
Hori.	5350.000	AV	39.87	31.73	16.40	43.21	2.26	47.05	53.90	<b>6.8</b>	110	339	
Vert.	5350.000	PK	54.61	31.73	16.40	43.21	2.26	61.79	73.90	12.1	176	67	VBW:2.7 kHz
Vert.	5350.000	AV	39.10	31.73	16.40	43.21	2.26	46.28	53.90	7.6	176	67	

Result [dBuV/m] = Reading + Ant.Fac. + Loss (Cable+(Attenuator or Filter)(below 18 GHz)) - Gain(Amplifier) + Distance factor

\*Other frequency noises omitted in this report were not seen or have enough margin (more than 20dB).

\*The 4th harmonic was not seen so the result was its base noise level

Distance factor : 1 GHz - 13 GHz :  $20\log(3.89\text{ m} / 3.0\text{ m}) = 2.26\text{ dB}$

13 GHz - 40 GHz :  $20\log(1.0\text{ m} / 3.0\text{ m}) = -9.54\text{ dB}$

**UL Japan, Inc.**

**Shonan EMC Lab.**

1-22-3 Megumigaoka, Hiratsuka-shi, Kanagawa 259-1220 JAPAN

Telephone : +81 463 50 6400

Facsimile : +81 463 50 6401

**Radiated Spurious Emission**  
**(Reference Plot for band-edge)**

Test place	Shonan EMC Lab.
Semi Anechoic Chamber	No.3
Date	April 3, 2019
Temperature / Humidity	21 deg. C / 36 % RH
Engineer	Kenichi Adachi
	(1 GHz – 6.4 GHz)
Mode	Tx, OFDM VHT20 (SISO) ,5320 MHz

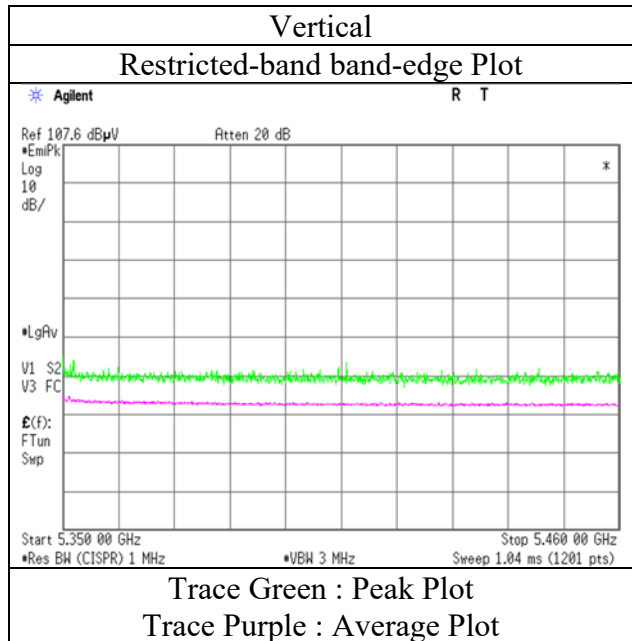
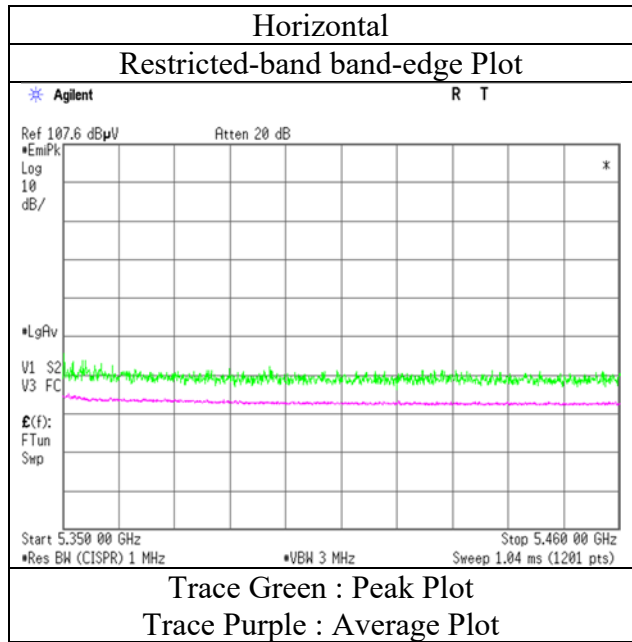

\* The measurement was conducted for a sufficiently long enough time to detect any possible spurious emissions.  
 Final result of restricted band edge was shown in tabular data.

**UL Japan, Inc.**  
**Shonan EMC Lab.**

1-22-3 Megumigaoka, Hiratsuka-shi, Kanagawa-ken, 259-1220 JAPAN  
 Telephone : +81 463 50 6400  
 Facsimile : +81 463 50 6401

## Radiated Emission

Report No.  
 Test place           Shonan EMC Lab.  
 Semi Anechoic Chamber No.3  
 Date                    April 3, 2019  
 Temperature / Humidity 21 deg. C / 36 % RH  
 Engineer               Kenichi Adachi  
                               (1 GHz - 6.4 GHz)  
 Mode                   Tx,                    5190 MHz  
                               Tx, IEEE802.11n HT40 (SISO)

### (below 1GHz and above 1GHz Inside of the restricted band)

(\* PK: Peak, AV: Average, QP: Quasi-Peak)

Polarity	Frequency [MHz]	Detector	Reading [dBuV]	Ant.Fac. [dB/m]	Loss [dB]	Gain [dB]	Distance Factor [dB]	Result [dBuV/m]	Limit [dBuV/m]	Margin [dB]	Height [cm]	Angle [deg.]	Remark
Hori.	5150.000	PK	53.55	32.18	16.32	43.04	2.26	61.27	73.90	12.6	126	343	VBW:5.1 kHz
Hori.	5150.000	AV	42.67	32.18	16.32	43.04	2.26	50.39	53.90	3.5	126	343	
Vert.	5150.000	PK	52.43	32.18	16.32	43.04	2.26	60.15	73.90	13.7	218	63	VBW:5.1 kHz
Vert.	5150.000	AV	41.29	32.18	16.32	43.04	2.26	49.01	53.90	4.8	218	63	

Result [dBuV/m] = Reading + Ant.Fac. + Loss (Cable+(Attenuator or Filter)(below 18 GHz)) - Gain(Amplifier) + Distance factor

\*Other frequency noises omitted in this report were not seen or have enough margin (more than 20dB).

\*The 4th harmonic was not seen so the result was its base noise level

Distance factor : 1 GHz - 13 GHz :  $20\log(3.89\text{ m} / 3.0\text{ m}) = 2.26\text{ dB}$

13 GHz - 40 GHz :  $20\log(1.0\text{ m} / 3.0\text{ m}) = -9.54\text{ dB}$

**UL Japan, Inc.**

**Shonan EMC Lab.**

1-22-3 Megumigaoka, Hiratsuka-shi, Kanagawa 259-1220 JAPAN

Telephone : +81 463 50 6400

Facsimile : +81 463 50 6401

**Radiated Spurious Emission**  
**(Reference Plot for band-edge)**

Test place	Shonan EMC Lab.
Semi Anechoic Chamber	No.3
Date	April 3, 2019
Temperature / Humidity	21 deg. C / 36 % RH
Engineer	Kenichi Adachi
	(1 GHz – 6.4 GHz)
Mode	Tx, IEEE802.11n HT40 (SISO) ,5190 MHz

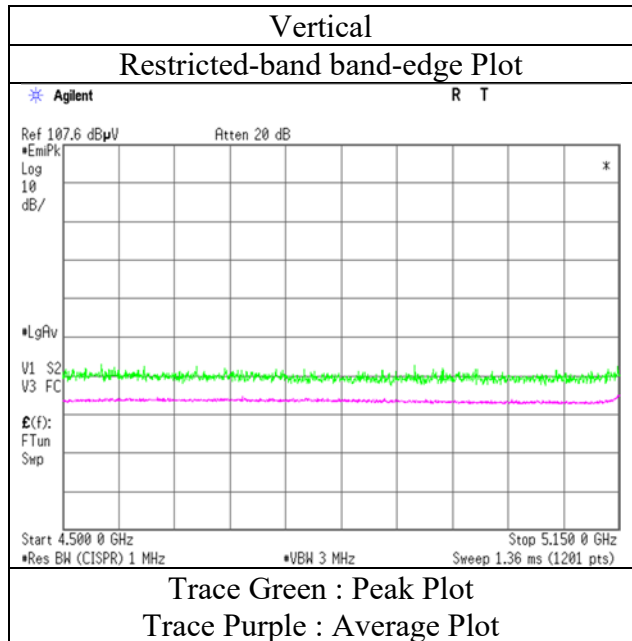
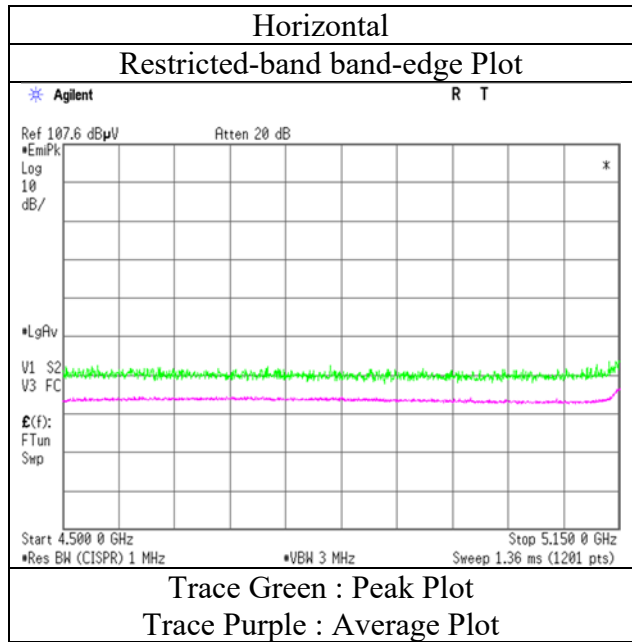

\* The measurement was conducted for a sufficiently long enough time to detect any possible spurious emissions.  
 Final result of restricted band edge was shown in tabular data.



## Radiated Emission

Report No.  
 Test place           Shonan EMC Lab.  
 Semi Anechoic Chamber No.3  
 Date                    April 3, 2019  
 Temperature / Humidity 21 deg. C / 36 % RH  
 Engineer               Kenichi Adachi  
                               (1 GHz - 6.4 GHz)  
 Mode                   Tx,                    5310 MHz  
                               Tx, IEEE802.11n HT40 (SISO)

### (below 1GHz and above 1GHz Inside of the restricted band)

(\* PK: Peak, AV: Average, QP: Quasi-Peak)

Polarity	Frequency [MHz]	Detector	Reading [dBuV]	Ant.Fac. [dB/m]	Loss [dB]	Gain [dB]	Distance Factor [dB]	Result [dBuV/m]	Limit [dBuV/m]	Margin [dB]	Height [cm]	Angle [deg.]	Remark
Hori.	5350.000	PK	57.95	31.73	16.40	43.21	2.26	65.13	73.90	8.7	118	337	VBW:5.1 kHz
Hori.	5350.000	AV	44.09	31.73	16.40	43.21	2.26	51.27	53.90	2.6	118	337	
Vert.	5350.000	PK	56.88	31.73	16.40	43.21	2.26	64.06	73.90	9.8	177	66	VBW:5.1 kHz
Vert.	5350.000	AV	42.77	31.73	16.40	43.21	2.26	49.95	53.90	3.9	177	66	

Result [dBuV/m] = Reading + Ant.Fac. + Loss (Cable+(Attenuator or Filter)(below 18 GHz)) - Gain(Amplifier) + Distance factor

\*Other frequency noises omitted in this report were not seen or have enough margin (more than 20dB).

\*The 4th harmonic was not seen so the result was its base noise level

Distance factor : 1 GHz - 13 GHz :  $20\log(3.89\text{ m} / 3.0\text{ m}) = 2.26\text{ dB}$

13 GHz - 40 GHz :  $20\log(1.0\text{ m} / 3.0\text{ m}) = -9.54\text{ dB}$

**UL Japan, Inc.**

**Shonan EMC Lab.**

1-22-3 Megumigaoka, Hiratsuka-shi, Kanagawa 259-1220 JAPAN

Telephone : +81 463 50 6400

Facsimile : +81 463 50 6401

## Radiated Spurious Emission (Reference Plot for band-edge)

Test place	Shonan EMC Lab.
Semi Anechoic Chamber	No.3
Date	April 3, 2019
Temperature / Humidity	21 deg. C / 36 % RH
Engineer	Kenichi Adachi
	(1 GHz – 6.4 GHz)
Mode	Tx, IEEE802.11n HT40 (SISO) ,5310 MHz

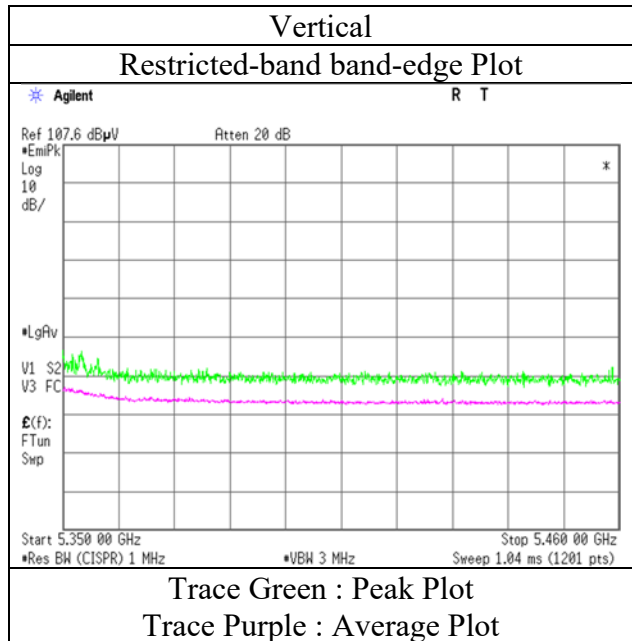
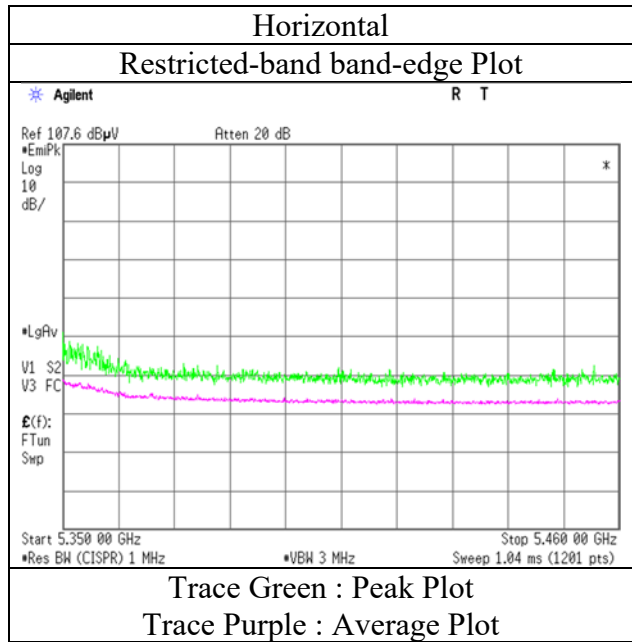

\* The measurement was conducted for a sufficiently long enough time to detect any possible spurious emissions.  
Final result of restricted band edge was shown in tabular data.

## Radiated Emission

Report No.  
 Test place           Shonan EMC Lab.  
 Semi Anechoic Chamber No.3  
 Date                    April 6, 2019  
 Temperature / Humidity 22 deg. C / 56 % RH  
 Engineer               Makoto Hosaka  
                               (1 GHz - 6.4 GHz)  
 Mode                   Tx,                    5210 MHz  
                               Tx, IEEE802.11ac VHT80 (SISO)

### (below 1GHz and above 1GHz Inside of the restricted band)

(\* PK: Peak, AV: Average, QP: Quasi-Peak)

Polarity	Frequency [MHz]	Detector	Reading [dBuV]	Ant.Fac. [dB/m]	Loss [dB]	Gain [dB]	Distance Factor [dB]	Result [dBuV/m]	Limit [dBuV/m]	Margin [dB]	Height [cm]	Angle [deg.]	Remark
Hori.	5150.000	PK	52.06	32.18	16.32	43.04	2.26	59.78	73.90	14.1	107	337	VBW:12 kHz
Hori.	5150.000	AV	42.55	32.18	16.32	43.04	2.26	50.27	53.90	<b>3.6</b>	107	337	
Vert.	5150.000	PK	51.26	32.18	16.32	43.04	2.26	58.98	73.90	14.9	341	14	VBW:12 kHz
Vert.	5150.000	AV	42.15	32.18	16.32	43.04	2.26	49.87	53.90	4.0	341	14	

Result [dBuV/m] = Reading + Ant.Fac. + Loss (Cable+(Attenuator or Filter)(below 18 GHz)) - Gain(Amplifier) + Distance factor

\*Other frequency noises omitted in this report were not seen or have enough margin (more than 20dB).

\*The 4th harmonic was not seen so the result was its base noise level

Distance factor : 1 GHz - 13 GHz :  $20\log(3.89\text{ m} / 3.0\text{ m}) = 2.26\text{ dB}$

13 GHz - 40 GHz :  $20\log(1.0\text{ m} / 3.0\text{ m}) = -9.54\text{ dB}$

**UL Japan, Inc.**

**Shonan EMC Lab.**

1-22-3 Megumigaoka, Hiratsuka-shi, Kanagawa 259-1220 JAPAN

Telephone : +81 463 50 6400

Facsimile : +81 463 50 6401

## Radiated Spurious Emission (Reference Plot for band-edge)

Test place	Shonan EMC Lab.
Semi Anechoic Chamber	No.3
Date	April 6, 2019
Temperature / Humidity	22 deg.C / 56 %RH
Engineer	Makoto Hosaka
	(1 GHz – 6.4 GHz)
Mode	Tx, OFDM VHT80 (SISO) ,5210 MHz

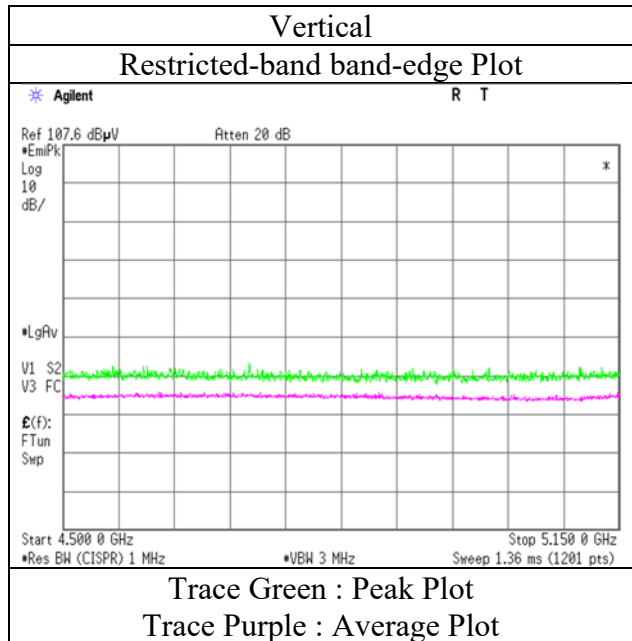
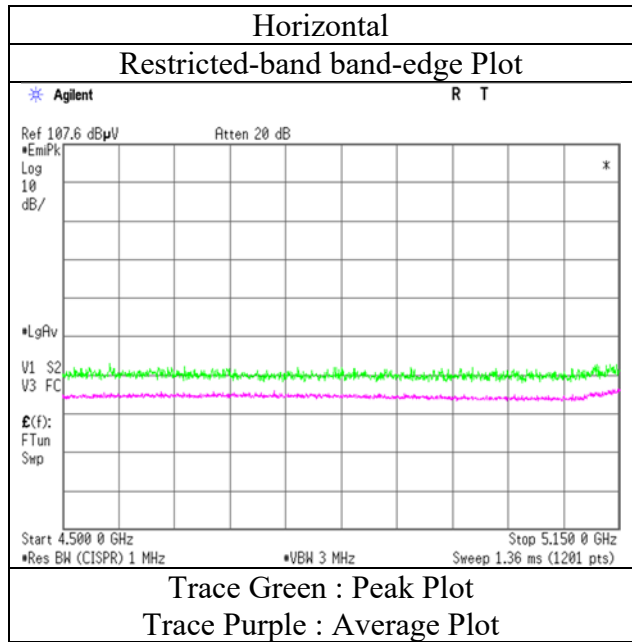

\* The measurement was conducted for a sufficiently long enough time to detect any possible spurious emissions.  
Final result of restricted band edge was shown in tabular data.

**UL Japan, Inc.**  
**Shonan EMC Lab.**

1-22-3 Megumigaoka, Hiratsuka-shi, Kanagawa-ken, 259-1220 JAPAN  
Telephone : +81 463 50 6400  
Facsimile : +81 463 50 6401

## Radiated Emission

Report No.  
 Test place           Shonan EMC Lab.  
 Semi Anechoic Chamber No.3  
 Date                    April 6, 2019  
 Temperature / Humidity 22 deg. C / 56 % RH  
 Engineer              Makoto Hosaka  
                           (1 GHz - 6.4 GHz)  
 Mode                  Tx,                 5290 MHz  
                           Tx, IEEE802.11ac VHT80 (SISO)

### (below 1GHz and above 1GHz Inside of the restricted band)

(\* PK: Peak, AV: Average, QP: Quasi-Peak)

Polarity	Frequency [MHz]	Detector	Reading [dBuV]	Ant.Fac. [dB/m]	Loss [dB]	Gain [dB]	Distance Factor [dB]	Result [dBuV/m]	Limit [dBuV/m]	Margin [dB]	Height [cm]	Angle [deg.]	Remark
Hori.	5350.000	PK	51.61	31.73	16.40	43.21	2.26	58.79	73.90	15.1	100	340	VBW:12 kHz
Hori.	5350.000	AV	41.00	31.73	16.40	43.21	2.26	48.18	53.90	5.7	100	340	
Vert.	5350.000	PK	50.44	31.73	16.40	43.21	2.26	57.62	73.90	16.2	331	304	VBW:12 kHz
Vert.	5350.000	AV	40.67	31.73	16.40	43.21	2.26	47.85	53.90	6.0	331	304	

Result [dBuV/m] = Reading + Ant.Fac. + Loss (Cable+(Attenuator or Filter)(below 18 GHz)) - Gain(Amplifier) + Distance factor

\*Other frequency noises omitted in this report were not seen or have enough margin (more than 20dB).

\*The 4th harmonic was not seen so the result was its base noise level

Distance factor : 1 GHz - 13 GHz :  $20\log(3.89\text{ m} / 3.0\text{ m}) = 2.26\text{ dB}$

13 GHz - 40 GHz :  $20\log(1.0\text{ m} / 3.0\text{ m}) = -9.54\text{ dB}$

**UL Japan, Inc.**

**Shonan EMC Lab.**

1-22-3 Megumigaoka, Hiratsuka-shi, Kanagawa 259-1220 JAPAN

Telephone : +81 463 50 6400

Facsimile : +81 463 50 6401

**Radiated Spurious Emission**  
**(Reference Plot for band-edge)**

Test place	Shonan EMC Lab.
Semi Anechoic Chamber	No.3
Date	April 6, 2019
Temperature / Humidity	22 deg.C / 56 %RH
Engineer	Makoto Hosaka
	(1 GHz – 6.4 GHz)
Mode	Tx, OFDM VHT80 (SISO) ,5290 MHz

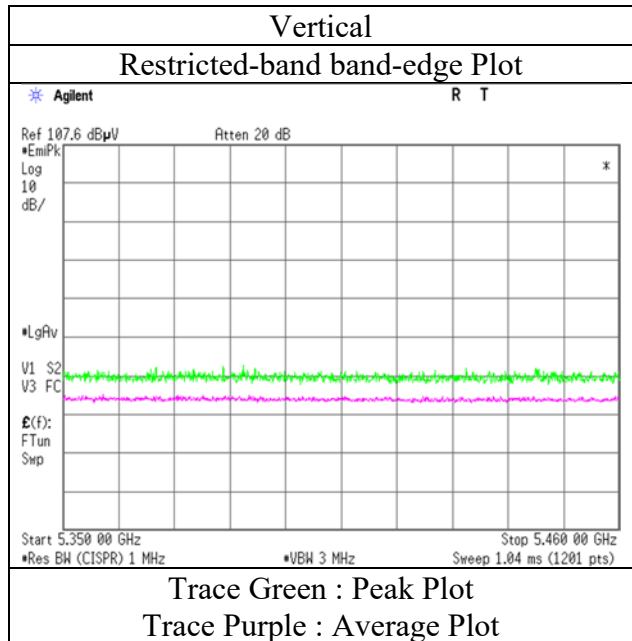
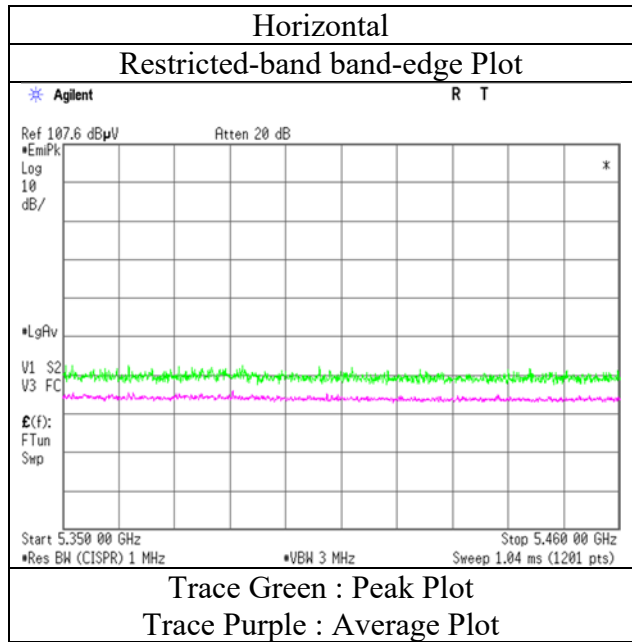

\* The measurement was conducted for a sufficiently long enough time to detect any possible spurious emissions.  
Final result of restricted band edge was shown in tabular data.

## Radiated Emission

Report No.  
 Test place           Shonan EMC Lab.  
 Semi Anechoic Chamber No.3  
 Date                   April 3, 2019  
 Temperature / Humidity 21 deg. C / 36 % RH  
 Engineer             Kenichi Adachi  
                           (1 GHz - 6.4 GHz)  
 Mode                 Tx,                 5180 MHz  
                           Tx, IEEE802.11n HT20 (MIMO)

### (below 1GHz and above 1GHz Inside of the restricted band)

(\* PK: Peak, AV: Average, QP: Quasi-Peak)

Polarity	Frequency [MHz]	Detector	Reading [dBuV]	Ant.Fac. [dB/m]	Loss [dB]	Gain [dB]	Distance Factor [dB]	Result [dBuV/m]	Limit [dBuV/m]	Margin [dB]	Height [cm]	Angle [deg.]	Remark
Hori.	5150.000	PK	50.43	32.18	16.32	43.04	2.26	58.15	73.90	15.7	201	291	VBW:9.1 kHz
Hori.	5150.000	AV	40.48	32.18	16.32	43.04	2.26	48.20	53.90	5.7	201	291	
Vert.	5150.000	PK	50.36	32.18	16.32	43.04	2.26	58.08	73.90	15.8	175	220	VBW:9.1 kHz
Vert.	5150.000	AV	40.72	32.18	16.32	43.04	2.26	48.44	53.90	5.4	175	220	

Result [dBuV/m] = Reading + Ant.Fac. + Loss (Cable+(Attenuator or Filter)(below 18 GHz)) - Gain(Amplifier) + Distance factor

\*Other frequency noises omitted in this report were not seen or have enough margin (more than 20dB).

\*The 4th harmonic was not seen so the result was its base noise level

Distance factor : 1 GHz - 13 GHz :  $20\log(3.89\text{ m} / 3.0\text{ m}) = 2.26\text{ dB}$

13 GHz - 40 GHz :  $20\log(1.0\text{ m} / 3.0\text{ m}) = -9.54\text{ dB}$

## Radiated Spurious Emission (Reference Plot for band-edge)

Test place	Shonan EMC Lab.
Semi Anechoic Chamber	No.3
Date	April 3, 2019
Temperature / Humidity	21 deg. C / 36 % RH
Engineer	Kenichi Adachi
	(1 GHz – 6.4 GHz)
Mode	Tx, IEEE802.11n HT20 (MIMO) ,5180 MHz

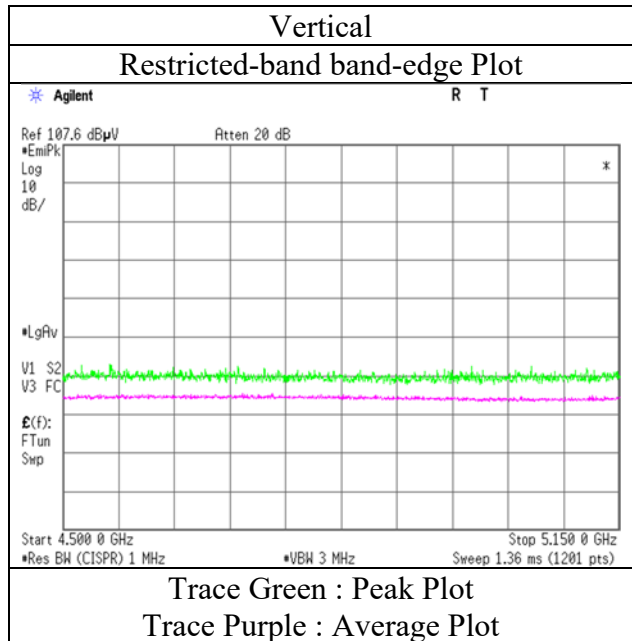
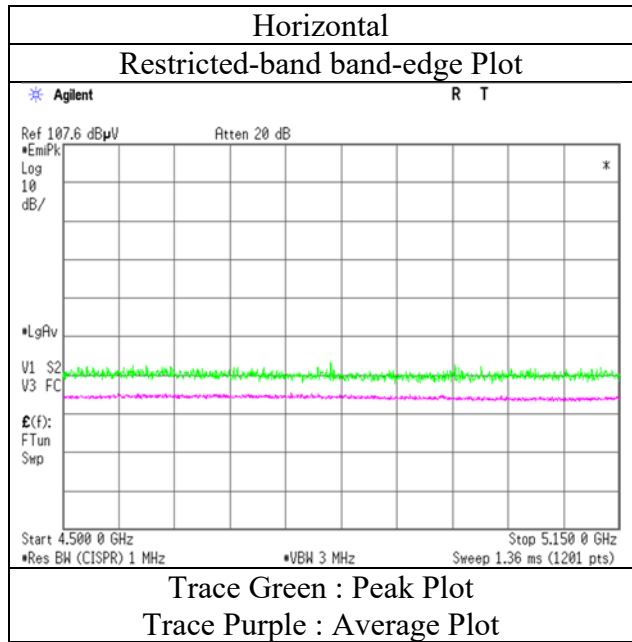

\* The measurement was conducted for a sufficiently long enough time to detect any possible spurious emissions.  
Final result of restricted band edge was shown in tabular data.



## Radiated Emission

Report No.  
 Test place           Shonan EMC Lab.  
 Semi Anechoic Chamber No.3  
 Date                    April 3, 2019  
 Temperature / Humidity 21 deg. C / 36 % RH  
 Engineer               Kenichi Adachi  
                               (1 GHz - 6.4 GHz)  
 Mode                   Tx,                    5320 MHz  
                               Tx, IEEE802.11n HT20 (MIMO)

### (below 1GHz and above 1GHz Inside of the restricted band)

(\* PK: Peak, AV: Average, QP: Quasi-Peak)

Polarity	Frequency [MHz]	Detector	Reading [dBuV]	Ant.Fac. [dB/m]	Loss [dB]	Gain [dB]	Distance Factor [dB]	Result [dBuV/m]	Limit [dBuV/m]	Margin [dB]	Height [cm]	Angle [deg.]	Remark
Hori.	5350.000	PK	52.86	31.73	16.40	43.21	2.26	60.04	73.90	13.8	187	292	VBW:9.1 kHz
Hori.	5350.000	AV	40.91	31.73	16.40	43.21	2.26	48.09	53.90	<b>5.8</b>	187	292	
Vert.	5350.000	PK	51.09	31.73	16.40	43.21	2.26	58.27	73.90	15.6	186	222	VBW:9.1 kHz
Vert.	5350.000	AV	40.73	31.73	16.40	43.21	2.26	47.91	53.90	5.9	186	222	

Result [dBuV/m] = Reading + Ant.Fac. + Loss (Cable+(Attenuator or Filter)(below 18 GHz)) - Gain(Amplifier) + Distance factor

\*Other frequency noises omitted in this report were not seen or have enough margin (more than 20dB).

\*The 4th harmonic was not seen so the result was its base noise level

Distance factor : 1 GHz - 13 GHz :  $20\log(3.89\text{ m} / 3.0\text{ m}) = 2.26\text{ dB}$

13 GHz - 40 GHz :  $20\log(1.0\text{ m} / 3.0\text{ m}) = -9.54\text{ dB}$

**UL Japan, Inc.**

**Shonan EMC Lab.**

1-22-3 Megumigaoka, Hiratsuka-shi, Kanagawa 259-1220 JAPAN

Telephone : +81 463 50 6400

Facsimile : +81 463 50 6401

## Radiated Spurious Emission (Reference Plot for band-edge)

Test place	Shonan EMC Lab.
Semi Anechoic Chamber	No.3
Date	April 3, 2019
Temperature / Humidity	21 deg. C / 36 % RH
Engineer	Kenichi Adachi (1 GHz – 6.4 GHz)
Mode	Tx, IEEE802.11n HT20 (MIMO) ,5320 MHz

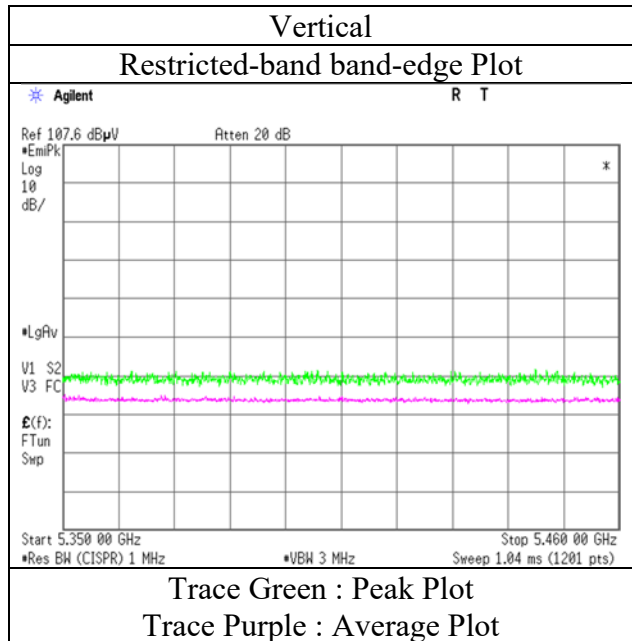
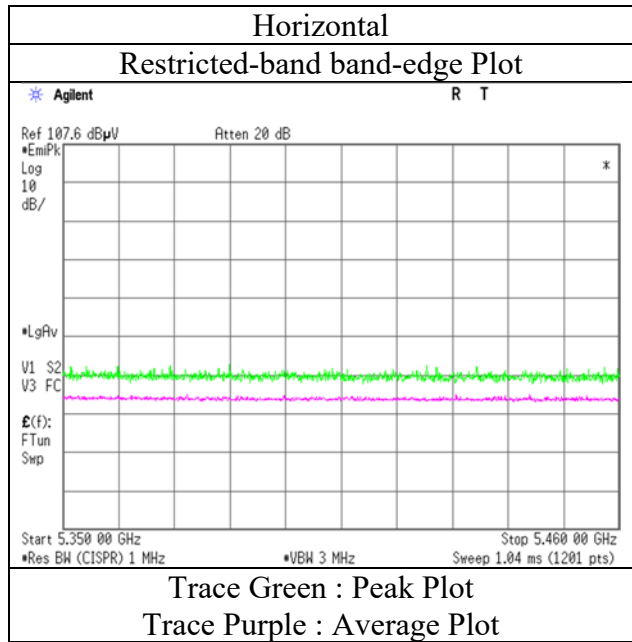

\* The measurement was conducted for a sufficiently long enough time to detect any possible spurious emissions.  
Final result of restricted band edge was shown in tabular data.

## Radiated Emission

Report No.  
 Test place           Shonan EMC Lab.  
 Semi Anechoic Chamber No.3  
 Date                    April 3, 2019  
 Temperature / Humidity 21 deg. C / 36 % RH  
 Engineer               Kenichi Adachi  
                               (1 GHz - 6.4 GHz)  
 Mode                   Tx,                    5190 MHz  
                               Tx, IEEE802.11ac VHT40 (MIMO)

### (below 1GHz and above 1GHz Inside of the restricted band)

(\* PK: Peak, AV: Average, QP: Quasi-Peak)

Polarity	Frequency [MHz]	Detector	Reading [dBuV]	Ant.Fac. [dB/m]	Loss [dB]	Gain [dB]	Distance Factor [dB]	Result [dBuV/m]	Limit [dBuV/m]	Margin [dB]	Height [cm]	Angle [deg.]	Remark
Hori.	5150.000	PK	49.94	32.18	16.32	43.04	2.26	57.66	73.90	16.2	212	295	VBW:10 kHz
Hori.	5150.000	AV	41.15	32.18	16.32	43.04	2.26	48.87	53.90	5.0	212	295	
Vert.	5150.000	PK	50.94	32.18	16.32	43.04	2.26	58.66	73.90	15.2	166	217	VBW:10 kHz
Vert.	5150.000	AV	41.64	32.18	16.32	43.04	2.26	49.36	53.90	4.5	166	217	

Result [dBuV/m] = Reading + Ant.Fac. + Loss (Cable+(Attenuator or Filter)(below 18 GHz)) - Gain(Amplifier) + Distance factor

\*Other frequency noises omitted in this report were not seen or have enough margin (more than 20dB).

\*The 4th harmonic was not seen so the result was its base noise level

Distance factor : 1 GHz - 13 GHz :  $20\log(3.89\text{ m} / 3.0\text{ m}) = 2.26\text{ dB}$

13 GHz - 40 GHz :  $20\log(1.0\text{ m} / 3.0\text{ m}) = -9.54\text{ dB}$

**UL Japan, Inc.**

**Shonan EMC Lab.**

1-22-3 Megumigaoka, Hiratsuka-shi, Kanagawa 259-1220 JAPAN

Telephone : +81 463 50 6400

Facsimile : +81 463 50 6401

## Radiated Spurious Emission (Reference Plot for band-edge)

Test place	Shonan EMC Lab.
Semi Anechoic Chamber	No.3
Date	April 3, 2019
Temperature / Humidity	21 deg. C / 36 % RH
Engineer	Kenichi Adachi
	(1 GHz – 6.4 GHz)
Mode	Tx, OFDM VHT40 (MIMO) ,5190 MHz

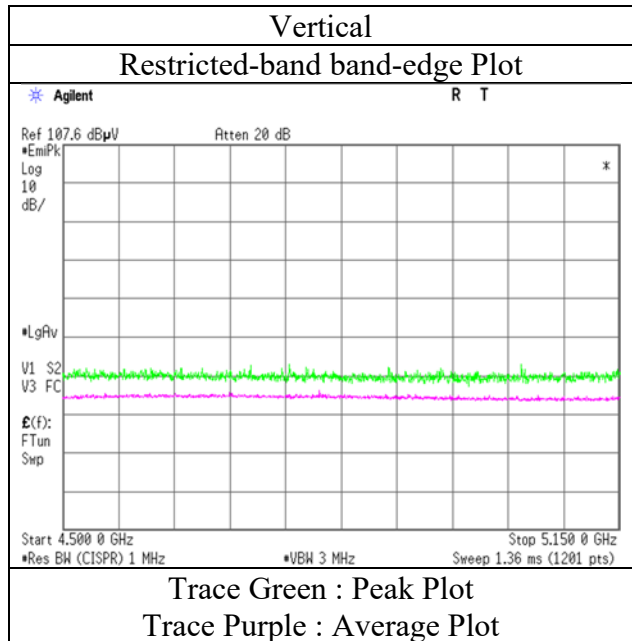
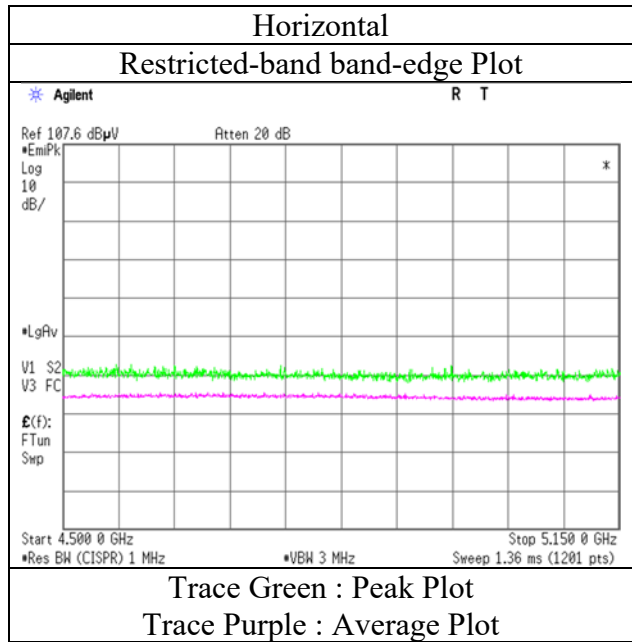

\* The measurement was conducted for a sufficiently long enough time to detect any possible spurious emissions.  
Final result of restricted band edge was shown in tabular data.

## Radiated Emission

Report No.  
 Test place           Shonan EMC Lab.  
 Semi Anechoic Chamber No.3  
 Date                   April 3, 2019  
 Temperature / Humidity 21 deg. C / 36 % RH  
 Engineer             Kenichi Adachi  
                           (1 GHz - 6.4 GHz)  
 Mode                 Tx,                 5310 MHz  
                           Tx, IEEE802.11ac VHT40 (MIMO)

### (below 1GHz and above 1GHz Inside of the restricted band)

(\* PK: Peak, AV: Average, QP: Quasi-Peak)

Polarity	Frequency [MHz]	Detector	Reading [dBuV]	Ant.Fac. [dB/m]	Loss [dB]	Gain [dB]	Distance Factor [dB]	Result [dBuV/m]	Limit [dBuV/m]	Margin [dB]	Height [cm]	Angle [deg.]	Remark
Hori.	5350.000	PK	52.90	31.73	16.40	43.21	2.26	60.08	73.90	13.8	213	294	VBW:13 kHz
Hori.	5350.000	AV	42.84	31.73	16.40	43.21	2.26	50.02	53.90	<b>3.8</b>	213	294	
Vert.	5350.000	PK	52.25	31.73	16.40	43.21	2.26	59.43	73.90	14.4	165	109	VBW:13 kHz
Vert.	5350.000	AV	42.92	31.73	16.40	43.21	2.26	50.10	53.90	<b>3.8</b>	165	109	

Result [dBuV/m] = Reading + Ant.Fac. + Loss (Cable+(Attenuator or Filter)(below 18 GHz)) - Gain(Amplifier) + Distance factor

\*Other frequency noises omitted in this report were not seen or have enough margin (more than 20dB).

\*The 4th harmonic was not seen so the result was its base noise level

Distance factor : 1 GHz - 13 GHz :  $20\log(3.89\text{ m} / 3.0\text{ m}) = 2.26\text{ dB}$

13 GHz - 40 GHz :  $20\log(1.0\text{ m} / 3.0\text{ m}) = -9.54\text{ dB}$

**UL Japan, Inc.**

**Shonan EMC Lab.**

1-22-3 Megumigaoka, Hiratsuka-shi, Kanagawa 259-1220 JAPAN

Telephone : +81 463 50 6400

Facsimile : +81 463 50 6401

## Radiated Spurious Emission (Reference Plot for band-edge)

Test place	Shonan EMC Lab.
Semi Anechoic Chamber	No.3
Date	April 3, 2019
Temperature / Humidity	21 deg. C / 36 % RH
Engineer	Kenichi Adachi
	(1 GHz – 6.4 GHz)
Mode	Tx, OFDM VHT40 (MIMO) ,5310 MHz

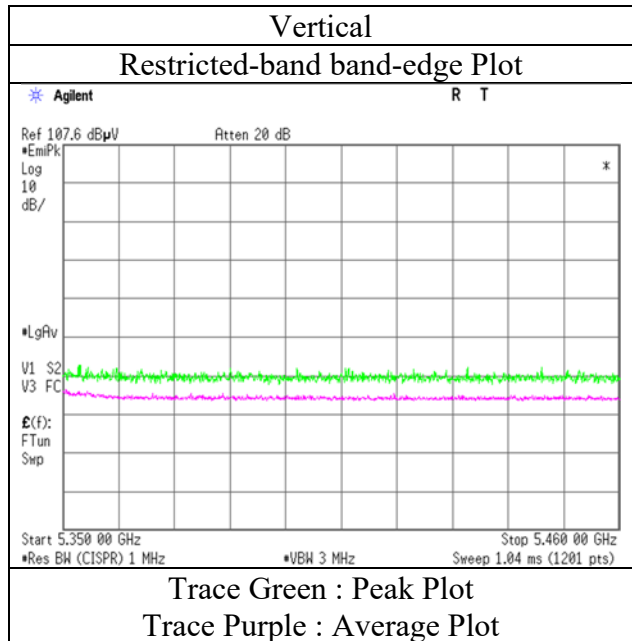
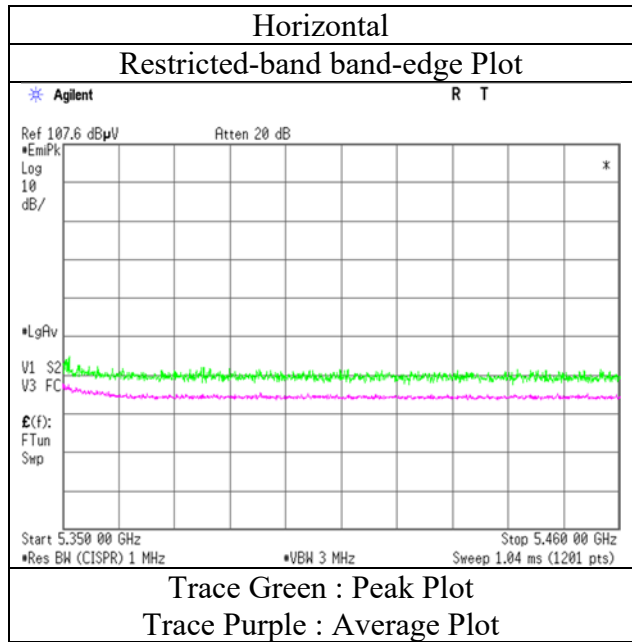

\* The measurement was conducted for a sufficiently long enough time to detect any possible spurious emissions.  
Final result of restricted band edge was shown in tabular data.

## Radiated Emission

Report No.  
 Test place Shonan EMC Lab.  
 Semi Anechoic Chamber No.3  
 Date April 6, 2019  
 Temperature / Humidity 22 deg. C / 56 % RH  
 Engineer Makoto Hosaka  
 (1 GHz - 6.4 GHz)  
 Mode Tx, 5210 MHz  
 Tx, IEEE802.11ac VHT80 (MIMO)

### (below 1GHz and above 1GHz Inside of the restricted band)

(\* PK: Peak, AV: Average, QP: Quasi-Peak)

Polarity	Frequency [MHz]	Detector	Reading [dBuV]	Ant.Fac. [dB/m]	Loss [dB]	Gain [dB]	Distance Factor [dB]	Result [dBuV/m]	Limit [dBuV/m]	Margin [dB]	Height [cm]	Angle [deg.]	Remark
Hori.	5150.000	PK	49.34	32.18	16.32	43.04	2.26	57.06	73.90	16.8	304	245	VBW:15 kHz
Hori.	5150.000	AV	40.65	32.18	16.32	43.04	2.26	48.37	53.90	5.5	304	245	
Vert.	5150.000	PK	49.62	32.18	16.32	43.04	2.26	57.34	73.90	16.5	177	221	VBW:15 kHz
Vert.	5150.000	AV	40.79	32.18	16.32	43.04	2.26	48.51	53.90	5.3	177	221	

Result [dBuV/m] = Reading + Ant.Fac. + Loss (Cable+(Attenuator or Filter)(below 18 GHz)) - Gain(Amplifier) + Distance factor

\*Other frequency noises omitted in this report were not seen or have enough margin (more than 20dB).

\*The 4th harmonic was not seen so the result was its base noise level

Distance factor : 1 GHz - 13 GHz :  $20\log(3.89\text{ m} / 3.0\text{ m}) = 2.26\text{ dB}$

13 GHz - 40 GHz :  $20\log(1.0\text{ m} / 3.0\text{ m}) = -9.54\text{ dB}$

**UL Japan, Inc.**

**Shonan EMC Lab.**

1-22-3 Megumigaoka, Hiratsuka-shi, Kanagawa 259-1220 JAPAN

Telephone : +81 463 50 6400

Facsimile : +81 463 50 6401

## Radiated Spurious Emission (Reference Plot for band-edge)

Test place	Shonan EMC Lab.
Semi Anechoic Chamber	No.3
Date	April 6, 2019
Temperature / Humidity	22 deg.C / 56 %RH
Engineer	Makoto Hosaka
	(1 GHz – 6.4 GHz)
Mode	Tx, OFDM VHT80 (MIMO) ,5210 MHz

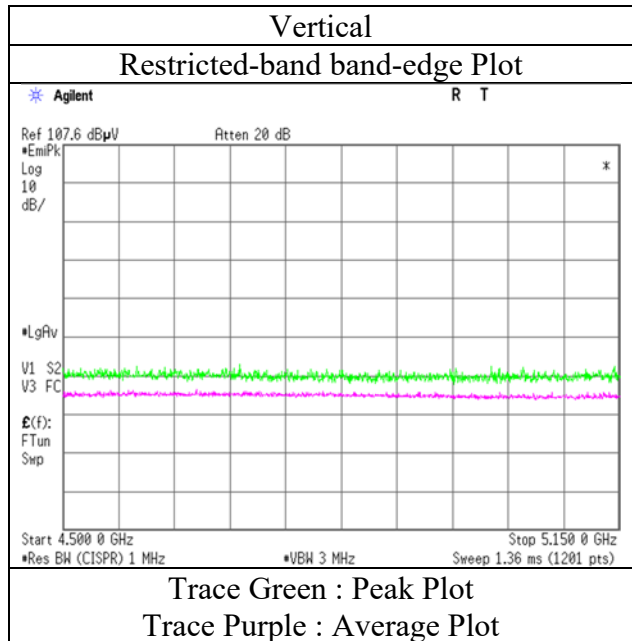
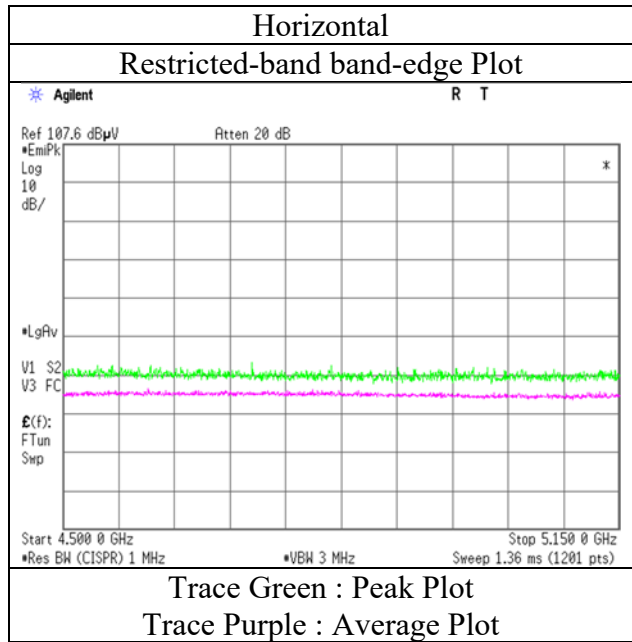

\* The measurement was conducted for a sufficiently long enough time to detect any possible spurious emissions.  
Final result of restricted band edge was shown in tabular data.



## Radiated Emission

Report No.  
 Test place           Shonan EMC Lab.  
 Semi Anechoic Chamber No.3  
 Date                    April 6, 2019  
 Temperature / Humidity 22 deg. C / 56 % RH  
 Engineer               Makoto Hosaka  
                               (1 GHz - 6.4 GHz)  
 Mode                    Tx,                    5290 MHz  
                               Tx, IEEE802.11ac VHT80 (MIMO)

### (below 1GHz and above 1GHz Inside of the restricted band)

(\* PK: Peak, AV: Average, QP: Quasi-Peak)

Polarity	Frequency [MHz]	Detector	Reading [dBuV]	Ant.Fac. [dB/m]	Loss [dB]	Gain [dB]	Distance Factor [dB]	Result [dBuV/m]	Limit [dBuV/m]	Margin [dB]	Height [cm]	Angle [deg.]	Remark
Hori.	5350.000	PK	49.51	31.73	16.40	43.21	2.26	56.69	73.90	17.2	298	248	VBW:15 kHz
Hori.	5350.000	AV	40.46	31.73	16.40	43.21	2.26	47.64	53.90	6.2	298	248	
Vert.	5350.000	PK	48.80	31.73	16.40	43.21	2.26	55.98	73.90	17.9	195	221	VBW:15 kHz
Vert.	5350.000	AV	40.66	31.73	16.40	43.21	2.26	47.84	53.90	<b>6.0</b>	195	221	

Result [dBuV/m] = Reading + Ant.Fac. + Loss (Cable+(Attenuator or Filter)(below 18 GHz)) - Gain(Amplifier) + Distance factor

\*Other frequency noises omitted in this report were not seen or have enough margin (more than 20dB).

\*The 4th harmonic was not seen so the result was its base noise level

Distance factor : 1 GHz - 13 GHz :  $20\log(3.89\text{ m} / 3.0\text{ m}) = 2.26\text{ dB}$

13 GHz - 40 GHz :  $20\log(1.0\text{ m} / 3.0\text{ m}) = -9.54\text{ dB}$

**UL Japan, Inc.**

**Shonan EMC Lab.**

1-22-3 Megumigaoka, Hiratsuka-shi, Kanagawa 259-1220 JAPAN

Telephone : +81 463 50 6400

Facsimile : +81 463 50 6401

**Radiated Spurious Emission**  
**(Reference Plot for band-edge)**

Test place	Shonan EMC Lab.
Semi Anechoic Chamber	No.3
Date	April 6, 2019
Temperature / Humidity	22 deg.C / 56 %RH
Engineer	Makoto Hosaka
	(1 GHz – 6.4 GHz)
Mode	Tx, OFDM VHT80 (MIMO) ,5290 MHz

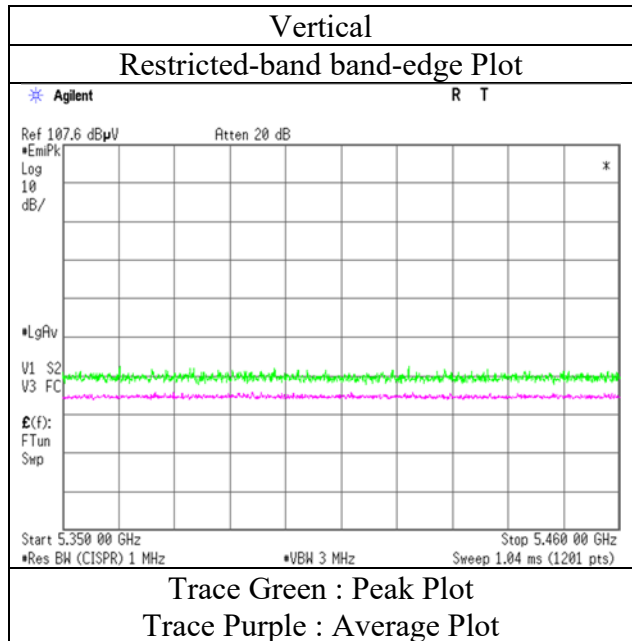
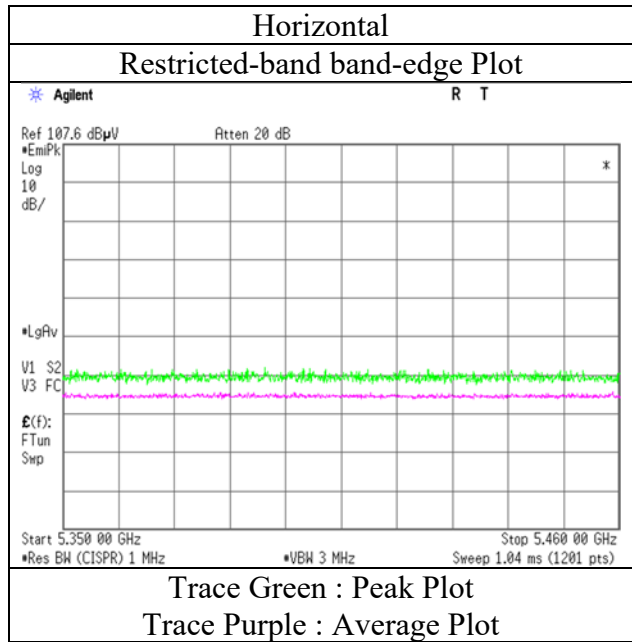

\* The measurement was conducted for a sufficiently long enough time to detect any possible spurious emissions.  
 Final result of restricted band edge was shown in tabular data.

**UL Japan, Inc.**  
**Shonan EMC Lab.**

1-22-3 Megumigaoka, Hiratsuka-shi, Kanagawa-ken, 259-1220 JAPAN  
 Telephone : +81 463 50 6400  
 Facsimile : +81 463 50 6401

**APPENDIX 2: Test Instruments**

## EMI test equipment

Local ID	Test Name	LIMS ID	Description	Manufacturer	Model	Serial	Last Calibration Date	Calibration Due Date	Calibration Interval (Month)
SAT10-15	AT	160493	Attenuator	Weinschel Corp.	54A-10	83406	2018/12/6	2019/12/30	12
SCC-G13	AT	145166	Coaxial Cable	Suhner	SUCOFLEX 102	31599/2	2018/12/25	2019/12/31	12
SOS-13	AT	146321	Humidity Indicator	CUSTOM	CTH-202	Q.C.17	2018/12/5	2019/12/31	12
SPM-07	AT	146247	Power Meter	AGILENT	8990B	MY5100272	2018/7/13	2019/7/31	12
SPSS-04	AT	146310	Power sensor	AGILENT	N1923A	MY5326009	2018/7/13	2019/7/31	12
SSA-03	AT	145801	Spectrum Analyzer	AGILENT	E4448A	MY48250152	2018/8/30	2019/8/31	12
STM-G7	AT	171614	Terminator	WEINSCHEL	M1459A	88995	2018/7/10	2019/7/31	12
KJM-09	RE	145929	Measure	KOMELON	KMC-36	-	-	-	-
KSA-08	RE	145089	Spectrum Analyzer	AGILENT	E4446A	MY46180525	2018/10/7	2019/10/31	12
SAEC-03(SVSWR)	RE	145566	Semi-Anechoic Chamber	TDK	SAEC-03(SVSWR)	3	2018/7/17	2019/7/31	12
SAF-04	RE	145127	Pre Amplifier	Toyo Corporation	TPA0118-36	2072554	2018/6/26	2019/6/30	12
SAF-06	RE	145005	Pre Amplifier	Toyo Corporation	TPA0118-36	1440491	2019/2/8	2020/2/29	12
SAT10-05	RE	145136	Attenuator(above1 GHz)	AGILENT	8493C-010	74864	2018/11/25	2019/11/30	12
SCC-G40	RE	166491	Coaxial Cable	Junkosha	MWX221-01000NFSNMS/B	1612S005	2019/1/25	2020/1/31	12
SCC-G43	RE	156380	Coaxial Cable	HUBER+SUNER	SUCOFLEX_104_E	SN MY 13406/4E	2018/7/10	2019/7/31	12
SCC-G44	RE	168300	Coaxial Cable	HUBER+SUNER	SUCOFLEX 104	800070/4A	2019/3/26	2020/3/31	12
SHA-03	RE	145501	Horn Antenna	Schwarzbeck	BBHA9120D	9120D-739	2018/7/23	2019/7/31	12
SOS-05	RE	146293	Humidity Indicator	A&D	AD-5681	4062518	2018/10/25	2019/10/31	12
STS-01	RE	145792	Digital Hitester	HIOKI	3805-50	80997812	2018/10/16	2019/10/31	12

\*Hyphens for Last Calibration Date, Calibration Due Date and Cal Int (month) are instruments that Calibration is not required (e.g. software), or instruments checked in advance before use.

The expiration date of the calibration is the end of the expired month.

As for some calibrations performed after the tested dates, those test equipment have been controlled by means of an unbroken chains of calibrations.

All equipment is calibrated with valid calibrations. Each measurement data is traceable to the national or international standards

Test Item:

RE: Radiated emission,

AT: Antenna terminal conducted test