



RADIO TEST REPORT

Test Report No. : 12656071S-H

Applicant : **Nintendo Co., Ltd.**

Type of Equipment : **Game Console**

Model No. : **HDH-001** Based on the manufacturer's declaration, Model HDH-001 can be regarded as equivalent to Model HDH-002 for the radio characteristics related to this application. (Refer Theory of Operation-Differences)

FCC ID : **BKEHDH001** Based on the manufacturer's declaration, Model HDH-001 can be regarded as equivalent to Model HDH-002 for the radio characteristics related to this application. (Refer Theory of Operation-Differences)

Test regulation : **FCC Part 15 Subpart C: 2019**
 * Bluetooth BDR/EDR part

Test Result : **Complied (Refer to SECTION 3.2)**

1. This test report shall not be reproduced in full or partial, without the written approval of UL Japan, Inc.
2. The results in this report apply only to the sample tested.
3. This sample tested is in compliance with the limits of the above regulation.
4. The test results in this test report are traceable to the national or international standards.
5. This test report must not be used by the customer to claim product certification, approval, or endorsement by any agency of the Federal Government.
6. This test report covers Radio technical requirements.
It does not cover administrative issues such as Manual or non-Radio test related Requirements. (if applicable)
7. The all test items in this test report are conducted by UL Japan, Inc. Shonan EMC Lab.
8. The opinions and the interpretations to the result of the description in this report are outside scopes where UL Japan has been accredited.
9. The information provided from the customer for this report is identified in SECTION 1.

Date of test: January 7 to March 12, 2019

Representative test engineer: *K. Takeyama*
 Kazutaka Takeyama
 Engineer
 Consumer Technology Division

Approved by: *A. Hayashi*
 Akio Hayashi
 Leader
 Consumer Technology Division



- The testing in which "Non-accreditation" is displayed is outside the accreditation scopes in UL Japan.
- There is no testing item of "Non-accreditation".

CONTENTS	PAGE
SECTION 1: Customer information.....	4
SECTION 2: Equipment under test (E.U.T.).....	4
SECTION 3: Test specification, procedures & results.....	6
SECTION 4: Operation of E.U.T. during testing.....	9
SECTION 5: Conducted Emission.....	11
SECTION 6: Radiated Spurious Emission	12
SECTION 7: Antenna Terminal Conducted Tests.....	14
APPENDIX 1: Test data	15
Conducted Emission	15
20 dB Bandwidth, 99 % Occupied Bandwidth and Carrier Frequency Separation.....	19
Number of Hopping Frequency	23
Dwell time.....	25
Maximum Peak Output Power.....	28
Average Output Power.....	29
Burst Rate Confirmation	30
Radiated Spurious Emission	31
Conducted Spurious Emission	42
Conducted Emission Band Edge compliance	48
APPENDIX 2: Test instruments	50
APPENDIX 3: Photographs of test setup	51
Conducted Emission	51
Radiated Spurious Emission	52
Pre-check of Worst Case Position.....	53

SECTION 1: Customer information

Company Name : Nintendo Co., Ltd.
Address : 11-1 Hokotate-cho, Kamitoba, Minami-ku, Kyoto 601-8501, Japan
Telephone Number : +81-75-662-9600
Facsimile Number : +81-75-662-9624
Contact Person : Kazuya Kuramoto

The information provided from the customer is as follows;

- Applicant, Type of Equipment, Model No., FCC ID on the cover and other relevant pages
 - Operating/Test Mode(s) (Mode(s)) on all the relevant pages
 - SECTION 1: Customer information
 - SECTION 2: Equipment under test (E.U.T.)
 - SECTION 4: Operation of E.U.T. during testing
- * The laboratory is exempted from liability of any test results affected from the above information in SECTION 2 and 4.

SECTION 2: Equipment under test (E.U.T.)

2.1 Identification of E.U.T.

Type of Equipment : Game Console
Model No. : HDH-001
Serial No. : Refer to Section 4.2
Rating : DC 3.8 V (battery),
AC Adapter input: AC 100 V - 240 V, 50 Hz / 60 Hz, 1 A,
AC Adapter output: DC 5 V - DC 15 V, 2.6 A
Receipt Date of Sample : December 27, 2018
(Information from test lab.)
Country of Mass-production : China
Condition of EUT : Engineering prototype
(Not for Sale: This sample is equivalent to mass-produced items.)
Modification of EUT : No Modification by the test lab.

2.2 Product Description

Model: HDH-001 (referred to as the EUT in this report) is a Game Console.

Radio Specification

Wireless LAN, Bluetooth part:

Equipment type	:	Transmitter
Frequency of operation	:	Wireless LAN part: (2.4 GHz): 2412 MHz - 2472 MHz, (U-NII-1): 5180 MHz - 5240 MHz, (U-NII-2A): 5260 MHz - 5320 MHz, (U-NII-2C): 5500 MHz - 5700 MHz, (U-NII-3): 5745 MHz - 5825 MHz, Bluetooth (BDR/EDR/BTLE) part: 2402 MHz - 2480 MHz
Radio part clock frequency	:	37.4 MHz
Channel spacing	:	Wireless LAN part: (2.4 GHz): 5 MHz, (5 GHz): 20 MHz, Bluetooth part: (BDR/EDR): 1 MHz, (BT LE): 2 MHz
Type of modulation	:	Wireless LAN part: 2.4 GHz bands: DBPSK, DQPSK, CCK, OFDM, 5 GHz bands: OFDM Bluetooth (BT) part: BDR (Basic Data Rate): GFSK, EDR (Enhanced Data Rate): $\pi/4$ -DQPSK, 8DPSK, BT LE (Low Energy mode): GFSK
Antenna type	:	Sheet metal antenna
Antenna connector type	:	(Ant: 0): MHF2, (Ant: 1): MHF2
Antenna gain	:	2.4 GHz bands: (Ant: 0): -0.904 dBi, (Ant: 1): -0.730 dBi 5 GHz bands: (Ant: 0): 2.949 dBi, (Ant: 1): 1.994 dBi
Power Supply (radio part input)	:	DC 1.8 V, DC 3.3 V
Operation temperature range	:	+5 deg.C to +35 deg.C

Remarks: This wireless module consists of 1 chip each of 5 GHz bands and 2.4 GHz bands.

NFC part:

Equipment type	:	Transmitter
Frequency of operation	:	13.56 MHz
Radio part clock frequency	:	27.12 MHz
Type of modulation	:	ASK
Power Supply (radio part input)	:	DC 1.8 V, DC 5.0 V
Antenna type	:	Ferrite Chip Antenna
Operation temperature range	:	+5 deg.C to +35 deg.C

SECTION 3: Test specification, procedures & results

3.1 Test Specification

Test Specification : FCC Part 15 Subpart C
FCC Part 15 final revised on June 4, 2019 and effective July 5, 2019 except 15.258
Title : FCC 47CFR Part15 Radio Frequency Device Subpart C Intentional Radiators
Section 15.207 Conducted limits
Section 15.247 Operation within the bands 902-928MHz,
2400-2483.5MHz, and 5725-5850MHz

* The revision on June 4, 2019, does not affect the test specification applied to the EUT.

* Also the EUT complies with FCC Part 15 Subpart B.

3.2 Procedures and results

Item	Test Procedure	Specification	Worst Margin	Results	Remarks
Conducted Emission	FCC: ANSI C63.10-2013 6. Standard test methods	FCC: Section 15.207	12.8 dB 0.16051 MHz, QP, N, Mode: Tx DH5 2480 MHz	Complied a)	-
	IC: RSS-Gen 8.8	IC: RSS-Gen 8.8	0.16052 MHz, QP, N, Mode: Tx 3DH5 2480 MHz		
Carrier Frequency Separation	FCC: KDB 558074 D01 15.247 Meas Guidance v05r01	FCC: Section15.247(a)(1)	See data.	Complied b)	Conducted
	IC: -	IC: RSS-247 5.1 (b)			
20 dB Bandwidth	FCC: KDB 558074 D01 15.247 Meas Guidance v05r01	FCC: Section15.247(a)(1)		Complied b)	Conducted
	IC: -	IC: RSS-247 5.1 (a)			
Number of Hopping Frequency	FCC: KDB 558074 D01 15.247 Meas Guidance v05r01	FCC: Section15.247(a)(1)(iii)		Complied c)	Conducted
	IC: -	IC: RSS-247 5.1 (d)			
Dwell time	FCC: KDB 558074 D01 15.247 Meas Guidance v05r01	FCC: Section15.247(a)(1)(iii)	Complied d)	Conducted	
	IC: -	IC: RSS-247 5.1 (d)			
Maximum Peak Output Power	FCC: KDB 558074 D01 15.247 Meas Guidance v05r01	FCC: Section15.247(a)(b)(1)	Complied e)	Conducted	
	IC: RSS-Gen 6.12	IC: RSS-247 5.4 (b)			
Spurious Emission & Band Edge Compliance	FCC: KDB 558074 D01 15.247 Meas Guidance v05r01 IC: RSS-Gen 6.13	FCC: Section15.247(d) IC: RSS-247 5.5 RSS-Gen 8.9 RSS-Gen 8.10	1.5 dB 4804.00 MHz, Average, Horizontal, Mode: Tx 2402 MHz, EDR	Complied# f) / g)	Conducted/ Radiated (above 30 MHz) *1)

Note: UL Japan, Inc.'s EMI Work Procedures No. 13-EM-W0420 and 13-EM-W0422.

- *1) Radiated test was selected over 30 MHz based on section 15.247(d). (Measurement was performed before issue of KDB 558074 v05r02.)
a) Refer to APPENDIX 1 (data of Conducted Emission)
b) Refer to APPENDIX 1 (data of 20dB Bandwidth, 99%Occupied Bandwidth and Carrier Frequency Separation)
c) Refer to APPENDIX 1 (data of Number of Hopping Frequency)
d) Refer to APPENDIX 1 (data of Dwell time)
e) Refer to APPENDIX 1 (data of Maximum Peak Output Power)
f) Refer to APPENDIX 1 (data of Conducted Spurious Emission)
g) Refer to APPENDIX 1 (data of Radiated Spurious Emission)

Symbols:

Complied The data of this test item has enough margin, more than the measurement uncertainty.
Complied# The data of this test item meets the limits unless the measurement uncertainty is taken into consideration.

* In case any questions arise about test procedure, ANSI C63.10: 2013 is also referred.

UL Japan, Inc.

Shonan EMC Lab.

1-22-3 Megumigaoka, Hiratsuka-shi, Kanagawa-ken, 259-1220 JAPAN

Telephone : +81 463 50 6400

Facsimile : +81 463 50 6401

FCC Part 15.31 (e)

This EUT provides the stable voltage constantly to RF Module regardless of input voltage. Therefore, this EUT complies with the requirement.

FCC Part 15.203 Antenna requirement

It is impossible for end users to replace the antenna, because the antenna is mounted inside of the EUT. Therefore, the equipment complies with the antenna requirement of Section 15.203.

3.3 Addition to standard

Item	Test Procedure	Specification	Worst margin	Results	Remarks
99 % Occupied Bandwidth	RSS-Gen 6.7	IC: -	N/A	- b)	Conducted
b) Refer to APPENDIX 1 (data of 20 dB Bandwidth, 99 % Occupied Bandwidth and Carrier Frequency Separation)					

Other than above, no addition, exclusion nor deviation has been made from the standard.

3.4 Uncertainty

There is no applicable rule of uncertainty in this applied standard. Therefore, the results are derived depending on whether or not laboratory uncertainty is applied.

The following uncertainties have been calculated to provide a confidence level of 95 % using a coverage factor $k=2$.

Shonan EMC Lab.

Item	Frequency range	Uncertainty (+/-)				
		No. 1 SAC / SR	No. 2 SAC / SR	No. 3 SAC / SR	No. 4 SAC / SR	No. 5,6,8 SR
Conducted emission (AC Mains) LISN	150 kHz-30 MHz	2.9 dB	2.8 dB	2.9 dB	2.9 dB	2.9 dB
Radiated emission (Measurement distance: 3 m)	9 kHz-30 MHz	3.0 dB	3.0 dB	3.1 dB	-	-
	30 MHz-200 MHz	4.6 dB	4.6 dB	4.7 dB	-	-
	200 MHz-1 GHz	6.0 dB	6.0 dB	6.1 dB	-	-
	1 GHz-6 GHz	4.8 dB	4.8 dB	4.8 dB	-	-
	6 GHz-18 GHz	5.4 dB	5.4 dB	5.4 dB	-	-
Radiated emission (Measurement distance: 1 m)	18 GHz-40 GHz	5.6 dB	5.6 dB	5.6 dB	-	-
	1 GHz-18 GHz	5.7 dB	5.7 dB	5.7 dB	-	-
	18 GHz-40 GHz	5.9 dB	5.9 dB	5.9 dB	-	-

SAC=Semi-Anechoic Chamber

SR= Shielded Room is applied besides radiated emission

Antenna terminal test	Uncertainty (+/-)
Power Measurement above 1 GHz (Average Detector)_SPM-06	0.81 dB
Power Measurement above 1 GHz (Peak Detector)_SPM-06	1.53 dB
Power Measurement above 1 GHz (Average Detector)_SPM-07	0.95 dB
Power Measurement above 1 GHz (Peak Detector)_SPM-07	1.21 dB
Power Measurement above 1 GHz (Average Detector)_SPM-13	0.90 dB
Power Measurement above 1 GHz (Peak Detector)_SPM-13	1.04 dB
Spurious emission (Conducted) below 1GHz	1.8 dB
Spurious emission (Conducted) 1 GHz-3 GHz	1.7 dB
Spurious emission (Conducted) 3 GHz-18 GHz	2.3 dB
Spurious emission (Conducted) 18 GHz-26.5 GHz	2.4 dB
Spurious emission (Conducted) 26.5 GHz-40 GHz	2.4 dB
Bandwidth Measurement	0.61 %
Duty cycle and Time Measurement	0.012 %

3.5 Test Location

UL Japan, Inc. Shonan EMC Lab.

1-22-3, Megumigaoka, Hiratsuka-shi, Kanagawa-ken 259-1220 JAPAN

Telephone: +81 463 50 6400, Facsimile: +81 463 50 6401

JAB Accreditation No. RTL02610 (FCC Test Firm Registration Number: 839876, ISED Lab Company Number: 2973D)

Test site	Width x Depth x Height (m)	Size of reference ground plane (m) / horizontal conducting plane	Maximum measurement distance
No.1 Semi-anechoic chamber	20.6 x 11.3 x 7.65	20.6 x 11.3	10 m
No.2 Semi-anechoic chamber	20.6 x 11.3 x 7.65	20.6 x 11.3	10 m
No.3 Semi-anechoic chamber	12.7 x 7.7 x 5.35	12.7 x 7.7	5 m
No.4 Semi-anechoic chamber	8.1 x 5.1 x 3.55	8.1 x 5.1	-
No.1 Shielded room	6.8 x 4.1 x 2.7	6.8 x 4.1	-
No.2 Shielded room	6.8 x 4.1 x 2.7	6.8 x 4.1	-
No.3 Shielded room	6.3 x 4.7 x 2.7	6.3 x 4.7	-
No.4 Shielded room	4.4 x 4.7 x 2.7	4.4 x 4.7	-
No.5 Shielded room	7.8 x 6.4 x 2.7	7.8 x 6.4	-
No.6 Shielded room	7.8 x 6.4 x 2.7	7.8 x 6.4	-
No.8 shielded room	3.45 x 5.5 x 2.4	3.45 x 5.5	-
No.1 Measurement room	2.55 x 4.1 x 2.5	-	-

3.6 Test data, Test instruments, and Test set up

Refer to APPENDIX.

SECTION 4: Operation of E.U.T. during testing

4.1 Operating Mode(s)

Bluetooth (BT): Transmitting (Tx), Payload: PRBS9

Details of Operating Mode(s)

Test Item	Mode	Tested frequency
Conducted Emission, Spurious Emission (Conducted/Radiated)	Tx (Hopping Off) DH5, 3DH5	2402 MHz 2441 MHz 2480 MHz
Carrier Frequency Separation	Tx (Hopping On) DH5, 3DH5	2402 MHz 2441 MHz 2480 MHz
20 dB Bandwidth	Tx (Hopping Off) DH5, 3DH5	2402 MHz 2441 MHz 2480 MHz
Number of Hopping Frequency	Tx (Hopping On) DH5, 3DH5	-
Dwell time	Tx (Hopping On), -DH1, DH3, DH5 -3DH1, 3DH3, 3DH5	-
Maximum Peak Output Power	Tx (Hopping Off) DH5, 2DH5, 3DH5	2402 MHz 2441 MHz 2480 MHz
Band Edge Compliance (Conducted)	Tx DH5, 3DH5 -Hopping On -Hopping Off	2402 MHz 2480 MHz
99 % Occupied Bandwidth	Tx DH5, 3DH5 -Hopping On -Hopping Off	2402 MHz 2441 MHz 2480 MHz
<p>*As a result of preliminary test, the formal test was performed with the above modes, which had the maximum payload length (except Dwell time test)</p> <p>*2DH mode (2Mb/s EDR: pi/4DQPSK) was excluded for other tests than power measurement by using 3DH mode (3 Mb/s EDR: 8DPSK) as a representative.</p> <p>* It is considered that the non-tested packet type (e.g. inquiry) can be omitted as it is complied with above all the test items based on Bluetooth Core specification.</p> <p>*EUT has the power settings by the software as follows; Power settings: Fixed Software: cmd.exe version 6.1.7601.23403 BlueTool.exe ver.1.9.2.4</p> <p>*This setting of software is the worst case. Any conditions under the normal use do not exceed the condition of setting. In addition, end users cannot change the settings of the output power of the product.</p>		

4.2 Configuration and peripherals

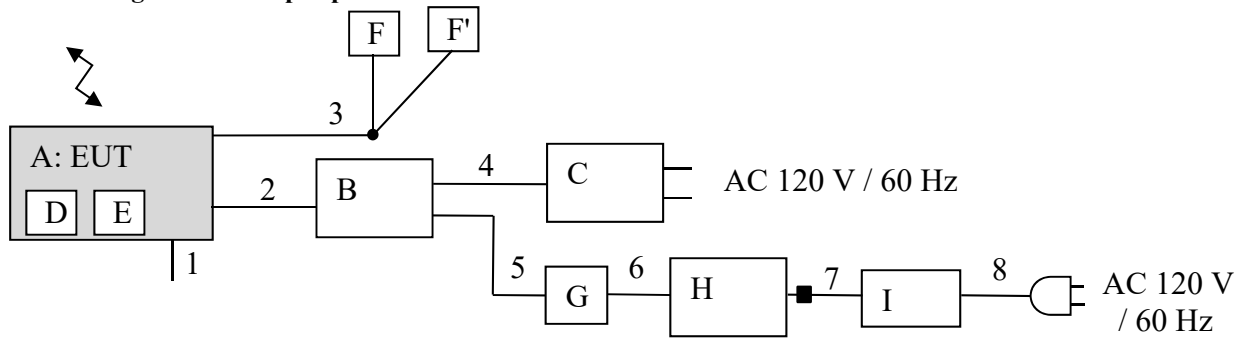

■: Standard Ferrite Core

* Cabling and setup(s) were taken into consideration and test data was taken under worse case conditions.

Description of EUT and Support equipment

No.	Item	Model number	Serial number	Manufacturer	Remarks
A	Game Console	HDH-001	XJW01000021026 *1) XJW01000021040 *2)	Nintendo Co., Ltd.	EUT
B	SDEV Cradle	HAT-003	XZL0100007151	Nintendo Co., Ltd.	-
C	AC Adapter	HAC-002		Nintendo Co., Ltd.	-
D	Game Card	HAC-008	DFCAA22L000	Nintendo Co., Ltd.	-
E	Micro SD Card	-	-	Transcend	-
F, F'	Headphone	-	-	Nintendo Co., Ltd.	-
G	GIGA Ethernet Adapter	LAN-GTJU3	3495DB2BF5CA	Logitec	-
H	Laptop PC	CF-S10AWNDS	2BKSA58270	Panasonic	-
I	AC Adapter	CF-AA6402A M1	6402AM111Z03016A	Panasonic	-

*1) Used for Antenna Terminal conducted test

*2) Used for Conducted Emission test and Radiated Emission test

List of cables used

No.	Cable Name	Length (m)	Shield		Remarks
			Cable	Connector	
1	Signal	0.1	Unshielded	Unshielded	*3)
2	USB	0.4	Shielded	Shielded	-
3	Headphone	0.5 + 0.3	Unshielded	Unshielded	-
4	USB	1.8	Shielded	Shielded	-
5	USB	0.15	Shielded	Shielded	-
6	LAN	0.5	Unshielded	Unshielded	-
7	DC	1.8	Unshielded	Unshielded	-
8	AC	1.0	Unshielded	Unshielded	-

*3) This signal cable is used only for the settings of the bluetooth test mode, not used for the product.

SECTION 5: Conducted Emission

Test Procedure and conditions

EUT was placed on a platform of nominal size, 1.0 m by 2.0 m, raised 0.8 m above the conducting ground plane. The table is made of expanded polystyrol and expanded polypropylene and the table top is covered with polycarbonate. That has very low permittivity.

The rear of tabletop was located 40 cm to the vertical conducting plane. The rear of EUT, including peripherals aligned and flushed with rear of tabletop. All other surfaces of tabletop were at least 80 cm from any other grounded conducting surface. EUT was located 80 cm from a Line Impedance Stabilization Network (LISN) / Artificial mains Network (AMN) and excess AC cable was bundled in center.

I/O cables that were connected to the peripherals were bundled in center. They were folded back and forth forming a bundle 30 cm to 40 cm long and were hanged at a 40 cm height to the ground plane. All unused 50 ohm connectors of the LISN (AMN) were resistivity terminated in 50 ohm when not connected to the measuring equipment.

The AC Mains Terminal Continuous disturbance Voltage has been measured with the EUT via AC Adapter in a Shielded room.

The EUT via AC Adapter was connected to a LISN (AMN).

An overview sweep with peak detection has been performed.

The test results and limit are rounded off to one decimal place, so some differences might be observed.

Detector : QP and CISPR AV
Measurement range : 0.15 MHz - 30 MHz
Test data : APPENDIX
Test result : Pass

Figure 1: Test Setup

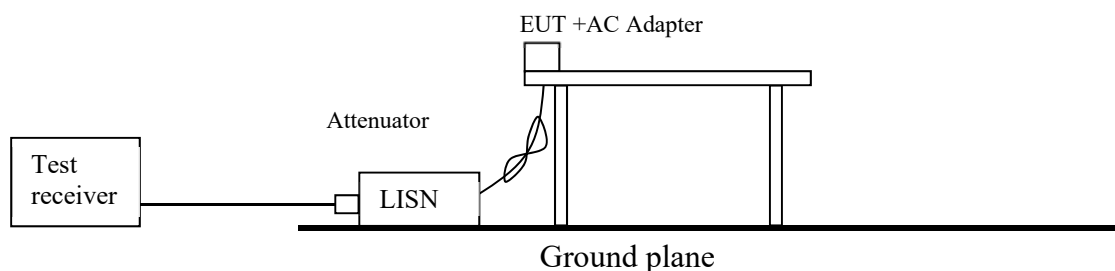

SECTION 6: Radiated Spurious Emission

Test Procedure

[For below 1 GHz]

EUT was placed on a platform of nominal size, 1.0 m by 1.5 m, raised 0.8 m above the conducting ground plane. The table is made of expanded polystyrol and expanded polypropylene and the table top is covered with polycarbonate. That has very low permittivity. The Radiated Electric Field Strength has been measured in a Semi Anechoic Chamber with a ground plane.

[For above 1 GHz]

EUT was placed on a urethane platform of nominal size, 0.5 m by 0.5 m, raised 1.5 m above the conducting ground plane. The Radiated Electric Field Strength has been measured in a Semi Anechoic Chamber with absorbent materials lined on a ground plane.

The height of the measuring antenna varied between 1 and 4 m and EUT was rotated a full revolution in order to obtain the maximum value of the electric field strength.

Test antenna was aimed at the EUT for receiving the maximum signal and always kept within the illumination area of the 3 dB beamwidth of the antenna.

The measurements were performed for both vertical and horizontal antenna polarization with the Test Receiver, or the Spectrum Analyzer.

The measurements were made with the following detector function of the test receiver and the Spectrum analyzer (in linear mode).

The test was made with the detector (RBW/VBW) in the following table.

When using Spectrum analyzer, the test was made with adjusting span to zero by using peak hold.

Test Antennas are used as below;

Frequency	30 MHz to 200 MHz	200 MHz to 1 GHz	Above 1 GHz
Antenna Type	Biconical	Logperiodic	Horn

In any 100 kHz bandwidth outside the restricted band in which the spread spectrum intentional radiator is operating, the radio frequency power that is produced by the intentional radiator confirmed 20 dB below that in the 100 kHz bandwidth within the band that contains the highest level of the desired power, based on a radiated measurement.

20 dBc was applied to the frequency over the limit of FCC 15.209 / Table 4 of RSS-Gen 8.9 (IC) and outside the restricted band of FCC15.205 / Table 6 of RSS-Gen 8.10 (IC).

Frequency	Below 1 GHz	Above 1 GHz		20 dBc
Instrument used	Test Receiver	Spectrum Analyzer		Spectrum Analyzer
Detector	QP	PK	AV *1)	PK
IF Bandwidth	BW 120 kHz	RBW: 1 MHz VBW: 3 MHz	RBW: 1 MHz VBW: 1/T (T: burst length, refer to Burst rate confirmation sheet) Detector: Peak	RBW: 100 kHz VBW: 300 kHz

*1) Average Power Measurement was performed based on KDB 558074 D01 15.247 Meas Guidance v05r01.

UL Japan, Inc.

Shonan EMC Lab.

1-22-3 Megumigaoka, Hiratsuka-shi, Kanagawa-ken, 259-1220 JAPAN

Telephone : +81 463 50 6400

Facsimile : +81 463 50 6401

Figure 2: Test Setup

Below 1 GHz

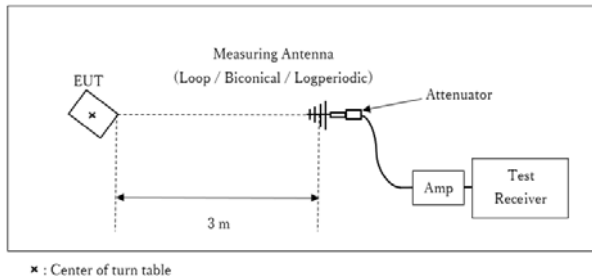

Test Distance: 3 m

1 GHz - 13 GHz

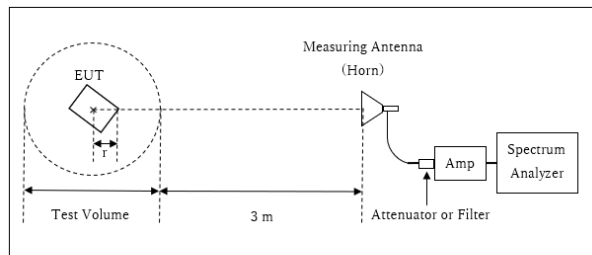

Distance Factor: $20 \times \log(3.89 \text{ m} / 3.0 \text{ m}) = 2.26\text{dB}$
* Test Distance: $(3 + \text{Test Volume} / 2) - r = 3.89 \text{ m}$

Test Volume : 2.0 m
(Test Volume has been calibrated based on CISPR 16-1-4.)
r = 0.11 m

13 GHz - 26.5 GHz

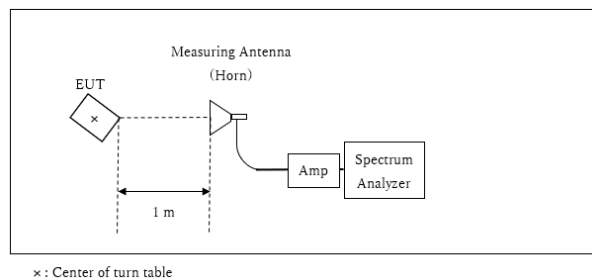

Distance Factor: $20 \times \log(1.0 \text{ m} / 3.0 \text{ m}) = -9.54 \text{ dB}$
*Test Distance: 1 m

- The carrier level and noise levels were confirmed at each position of X, Y and Z axes of EUT to see the position of maximum noise, and the test was made at the position that has the maximum noise.

Antenna polarization	Spurious Below 1 GHz	Spurious 1 GHz - 2.8 GHz	Spurious 2.8 GHz - 13 GHz	Spurious 13 GHz - 26.5 GHz
Horizontal	X	X	X	X
Vertical	X	Z	X	X

The test results and limit are rounded off to one decimal place, so some differences might be observed.

Measurement range : 30 MHz - 26.5 GHz
Test data : APPENDIX
Test result : Pass

UL Japan, Inc.

Shonan EMC Lab.

1-22-3 Megumigaoka, Hiratsuka-shi, Kanagawa-ken, 259-1220 JAPAN

Telephone : +81 463 50 6400

Facsimile : +81 463 50 6401

SECTION 7: Antenna Terminal Conducted Tests

Test Procedure

The tests were made with below setting connected to the antenna port.

Test	Span	RBW	VBW	Sweep time	Detector	Trace	Instrument used
20 dB Bandwidth	3 MHz	30 kHz	100 kHz	Auto	Peak	Max Hold	Spectrum Analyzer
99 % Occupied Bandwidth *1)	Enough width to display emission skirts	1 to 5 % of OBW	Three times of RBW	Auto	Peak	Max Hold *1)	Spectrum Analyzer
Maximum Peak Output Power	-	-	-	Auto	Peak Average *2)	-	Power Meter (Sensor: 160 MHz BW)
Carrier Frequency Separation	3 MHz	100 kHz	300 kHz	Auto	Peak	Max Hold	Spectrum Analyzer
Number of Hopping Frequency	30 MHz	300 kHz	1000 kHz	Auto	Peak	Max Hold	Spectrum Analyzer
Dwell Time	Zero Span	100 kHz, 1 MHz	300 kHz, 3 MHz	As necessary capture the entire dwell time per hopping channel	Peak	Clear Write	Spectrum Analyzer
Conducted Spurious Emission *3)	9 kHz to 150 kHz	200 Hz	620 Hz	Auto	Peak	Max Hold	Spectrum Analyzer
	150 kHz to 30 MHz	10 kHz	30 kHz				
	30 MHz to 25 GHz	100 kHz	300 kHz				
Conducted Spurious Emission Band Edge compliance	10 MHz	100 kHz	300 kHz	Auto	Peak	Max Hold	Spectrum Analyzer

*1) Peak hold was applied as Worst-case measurement.
*2) Reference data
*3) In the frequency range below 30 MHz, RBW was narrowed to separate the noise contents.
Then, wide-band noise near the limit was checked separately, however the noise was not detected as shown in the chart.

The test results and limit are rounded off to two decimals place, so some differences might be observed.
The equipment and cables were not used for factor 0 dB of the data sheets.

Test data : APPENDIX
Test result : Pass

APPENDIX 1: Test data

Conducted Emission

DATA OF CONDUCTED EMISSION TEST

UL Japan, Inc. Shonan EMC Lab. No.3 Shielded Room
Date : 2019/03/11

Mode : Tx DH5 2480 MHz
Power : AC 120 V / 60 Hz(AC adapter input)
Temp./Humi. : 25 deg.C / 36 %RH

Remarks : -

Limit : FCC_Part 15 Subpart C(15.207)

Engineer : Kenichi Adachi

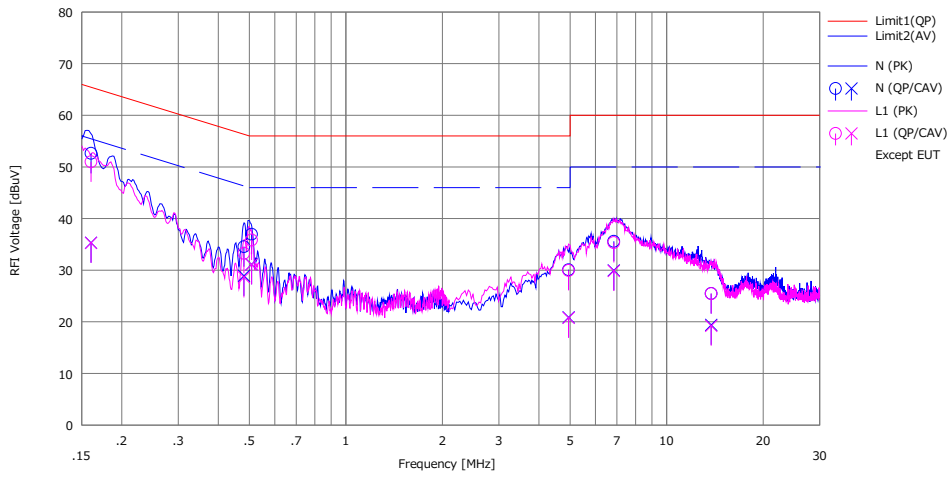

No.	Freq. [MHz]	Reading		LISN [dB]	LOSS [dB]	Results		Limit		Margin		Phase	Comment
		<QP> [dBuV]	<CAV> [dBuV]			<QP> [dBuV]	<CAV> [dBuV]	<QP> [dB]	<AV> [dB]	<QP> [dB]	<AV> [dB]		
1	0.16051	40.08	22.75	9.69	2.87	52.64	35.31	65.44	55.44	12.8	20.1	N	
2	0.48105	21.97	16.34	9.68	2.90	34.55	28.92	56.32	46.32	21.7	17.4	N	
3	0.50784	24.39	18.54	9.68	2.90	36.97	31.12	56.00	46.00	19.0	14.8	N	
4	4.94748	16.98	7.74	10.01	3.09	30.08	20.84	56.00	46.00	25.9	25.1	N	
5	6.84154	22.23	16.59	10.23	3.13	35.59	29.95	60.00	50.00	24.4	20.0	N	
6	13.77349	11.21	5.14	10.99	3.28	25.48	19.41	60.00	50.00	34.5	30.5	N	
7	0.16051	38.43	22.71	9.69	2.87	60.99	35.27	65.44	55.44	14.4	20.1	L1	
8	0.48105	20.68	16.03	9.68	2.90	33.26	28.61	56.32	46.32	23.0	17.7	L1	
9	0.50784	23.27	18.52	9.68	2.90	35.85	31.10	56.00	46.00	20.1	14.9	L1	
10	4.94748	16.84	7.67	10.01	3.09	29.94	20.77	56.00	46.00	26.0	25.2	L1	
11	6.84154	21.98	16.48	10.23	3.13	35.34	29.84	60.00	50.00	24.6	20.1	L1	
12	13.77349	11.19	4.95	10.99	3.28	25.46	19.22	60.00	50.00	34.5	30.7	L1	

Calculation: Result[dBuV]=Reading[dBuV]+C.Fac(LISN+Cable+ATT)[dB]
LISN: SLS-02 with Extension cable

UL Japan, Inc.

Shonan EMC Lab.

1-22-3 Megumigaoka, Hiratsuka-shi, Kanagawa-ken, 259-1220 JAPAN

Telephone : +81 463 50 6400

Facsimile : +81 463 50 6401

Conducted Emission

Report No.	12656071S-H
Test place	Shonan EMC Lab. No.3 Shielded room
Date	March 11, 2019
Temperature / Humidity	25 deg. C / 36 % RH
Engineer	Kenichi Adachi
Mode	Tx, Hopping Off, DH5

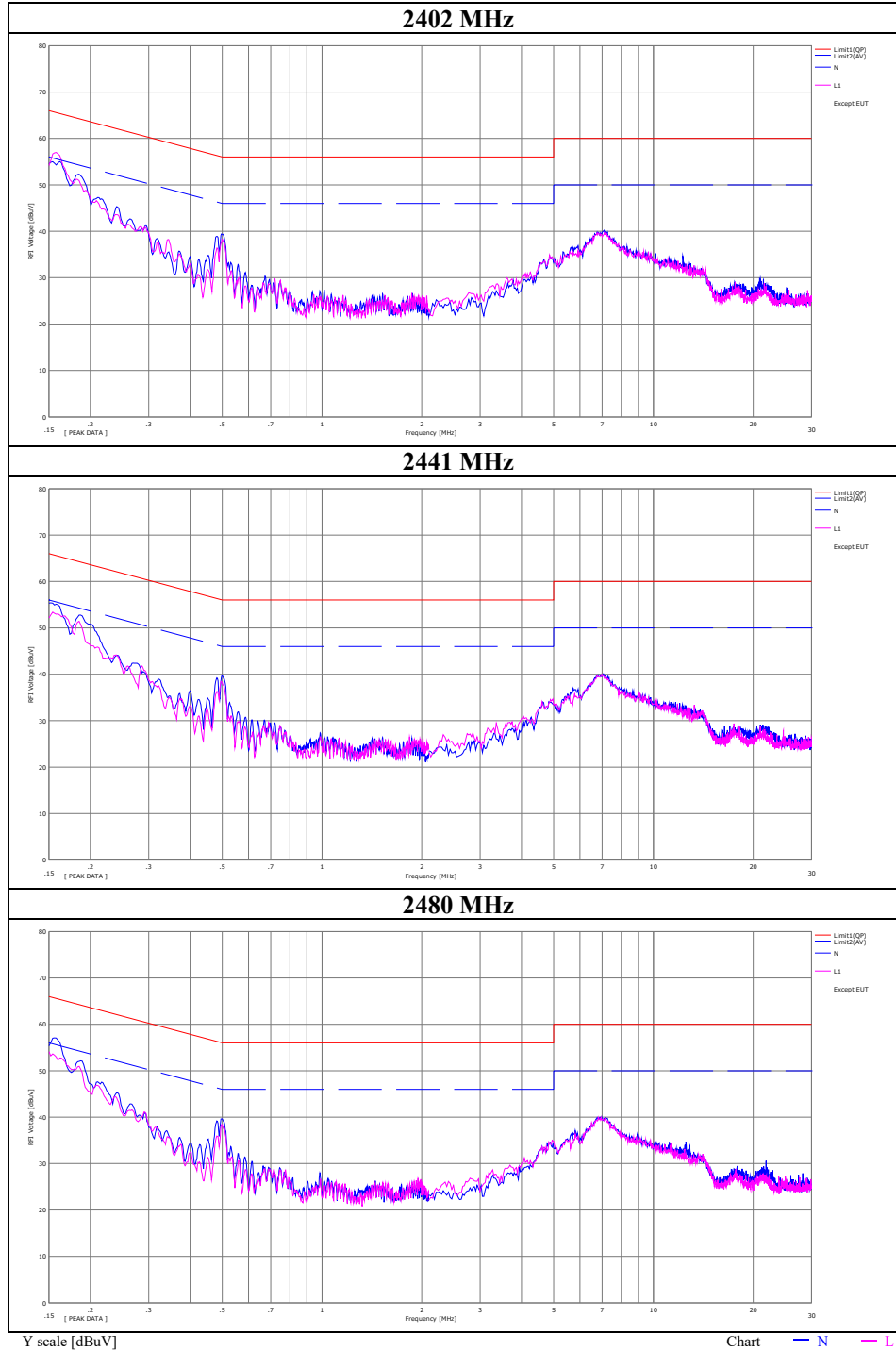

Conducted Emission

DATA OF CONDUCTED EMISSION TEST

UL Japan, Inc. Shonan EMC Lab. No.3 Shielded Room
Date : 2019/03/11

Mode : Tx 3DH5 2480 MHz
Power : AC 120 V / 60 Hz(AC adapter input)
Temp./Humi. : 25 deg.C / 36 %RH

Remarks : -

Limit : FCC_Part 15 Subpart C(15.207)

Engineer : Kenichi Adachi

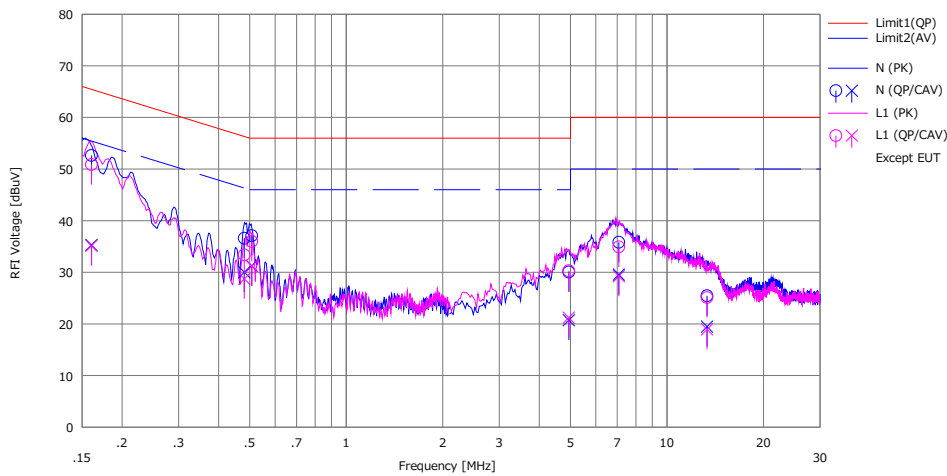

No.	Freq. [MHz]	Reading		LISN [dB]	LOSS [dB]	Results		Limit		Margin		Phase	Comment
		<QP>	<CAV>			<QP>	<CAV>	<QP>	<AV>	<QP>	<AV>		
		[dBuV]	[dBuV]			[dBuV]	[dBuV]	[dBuV]	[dBuV]	[dB]	[dB]		
1	0.16052	40.08	22.74	9.69	2.87	52.64	35.30	65.44	55.44	12.8	20.1	N	
2	0.48108	24.01	17.44	9.68	2.90	36.59	30.02	56.32	46.32	19.7	16.3	N	
3	0.50775	24.51	18.68	9.68	2.90	37.09	31.26	56.00	46.00	18.9	14.7	N	
4	4.94534	16.96	7.64	10.01	3.09	30.06	20.74	56.00	46.00	25.9	25.2	N	
5	7.07535	22.42	16.16	10.26	3.14	35.82	29.56	60.00	50.00	24.1	20.4	N	
6	13.32874	11.24	5.25	10.95	3.27	25.46	19.47	60.00	50.00	34.5	30.5	N	
7	0.16052	38.32	22.58	9.69	2.87	50.88	35.14	65.44	55.44	14.5	20.3	L1	
8	0.48108	20.79	16.14	9.68	2.90	33.37	28.72	56.32	46.32	22.9	17.6	L1	
9	0.50775	23.42	18.64	9.68	2.90	36.00	31.22	56.00	46.00	20.0	14.7	L1	
10	4.94534	17.19	8.12	10.01	3.09	30.29	21.22	56.00	46.00	25.7	24.7	L1	
11	7.07535	21.51	15.84	10.26	3.14	34.91	29.24	60.00	50.00	25.0	20.7	L1	
12	13.32874	10.89	4.74	10.95	3.27	25.11	18.96	60.00	50.00	34.8	31.0	L1	

Calculation: Result[dBuV]=Reading[dBuV]+C.Fac(LISN+Cable+ATT)[dB]
LISN: SLS-02 with Extention cable

Conducted Emission

Report No.	12656071S-H
Test place	Shonan EMC Lab. No.3 Shielded room
Date	March 11, 2019
Temperature / Humidity	25 deg. C / 36 % RH
Engineer	Kenichi Adachi
Mode	Tx, Hopping Off, 3DH5

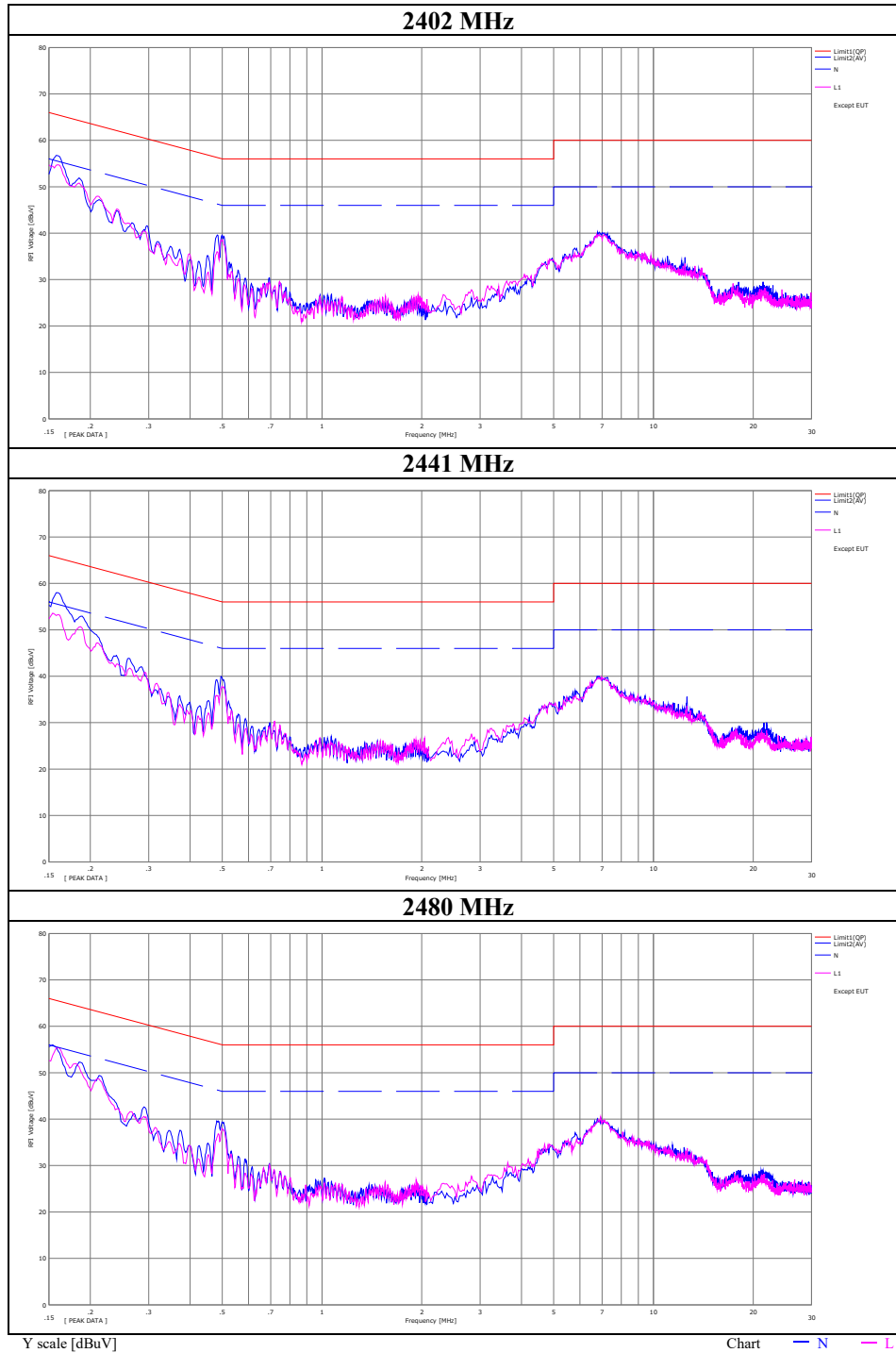

20 dB Bandwidth, 99 % Occupied Bandwidth and Carrier Frequency Separation

Report No. 12656071S-H
Test place Shonan EMC Lab. No.1 Measurement Room
Date March 12, 2019
Temperature / Humidity 23 deg. C / 59 % RH
Engineer Kenichi Adachi
Mode Tx, Hopping Off, Tx, Hopping On

Mode	Freq. [MHz]	20 dB Bandwidth [MHz]	99 % Occupied Bandwidth [kHz]	Carrier Frequency Separation [MHz]	Limit for Carrier Frequency separation [MHz]
DH5	2402.0	1.033	931.7	1.000	>= 0.689
DH5	2441.0	1.049	952.7	1.000	>= 0.700
DH5	2480.0	1.038	947.8	1.000	>= 0.692
DH5	Hopping On	-	78650.1	-	-
3DH5	2402.0	1.317	1202.1	1.000	>= 0.878
3DH5	2441.0	1.317	1202.5	1.000	>= 0.878
3DH5	2480.0	1.317	1200.9	1.000	>= 0.878
3DH5	Hopping On	-	78729.6	-	-

Limit: Two-thirds of 20 dB Bandwidth or 25 kHz (whichever is greater).

No limit applies to 20 dB Bandwidth.

20 dB Bandwidth and 99 % Occupied Bandwidth

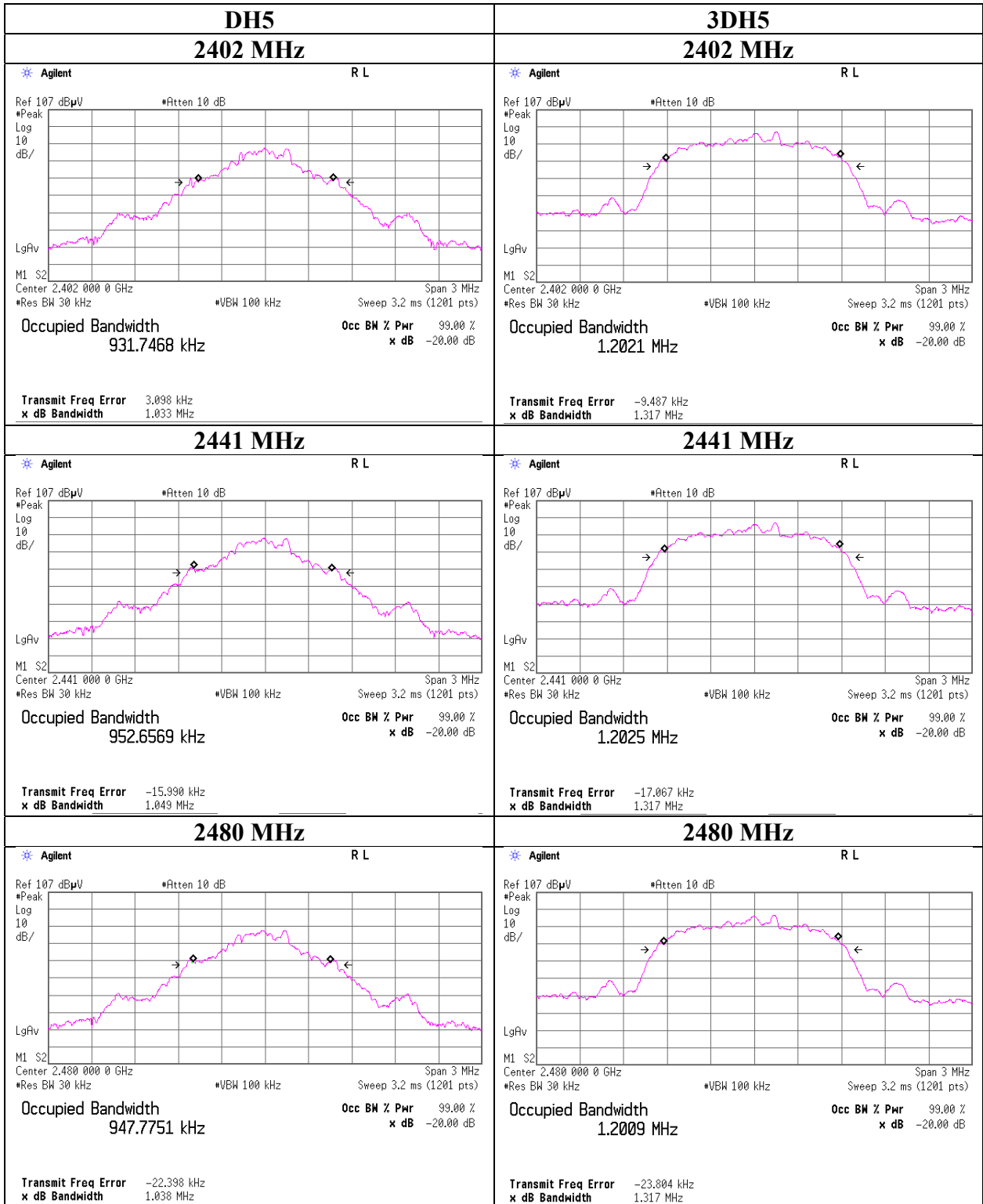

UL Japan, Inc.

Shonan EMC Lab.

1-22-3 Megumigaoka, Hiratsuka-shi, Kanagawa-ken, 259-1220 JAPAN

Telephone : +81 463 50 6400

Facsimile : +81 463 50 6401

20 dB Bandwidth and 99 % Occupied Bandwidth

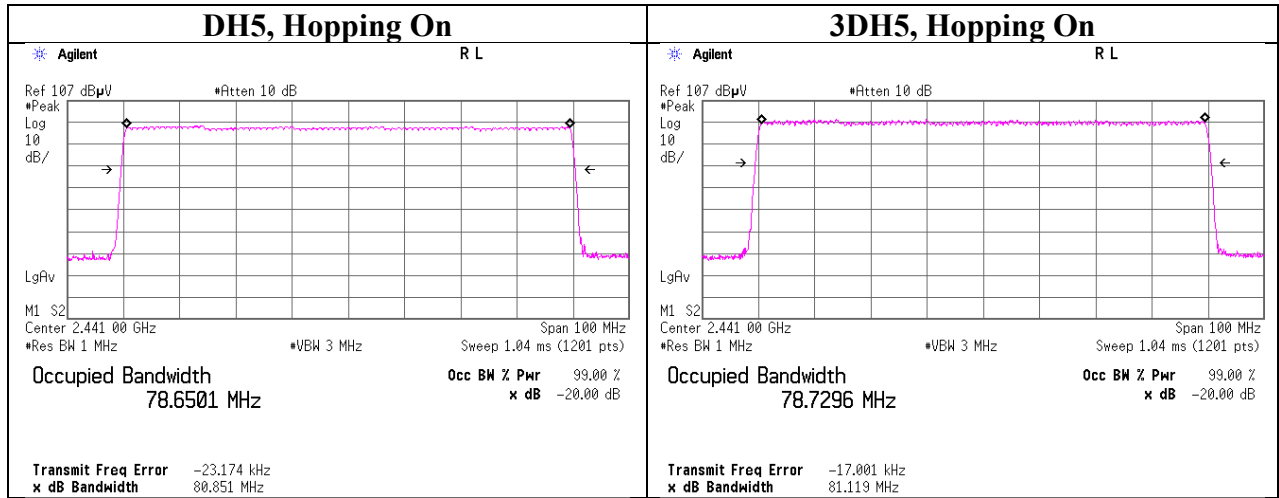

UL Japan, Inc.

Shonan EMC Lab.

1-22-3 Megumigaoka, Hiratsuka-shi, Kanagawa-ken, 259-1220 JAPAN

Telephone : +81 463 50 6400

Facsimile : +81 463 50 6401

Carrier Frequency Separation

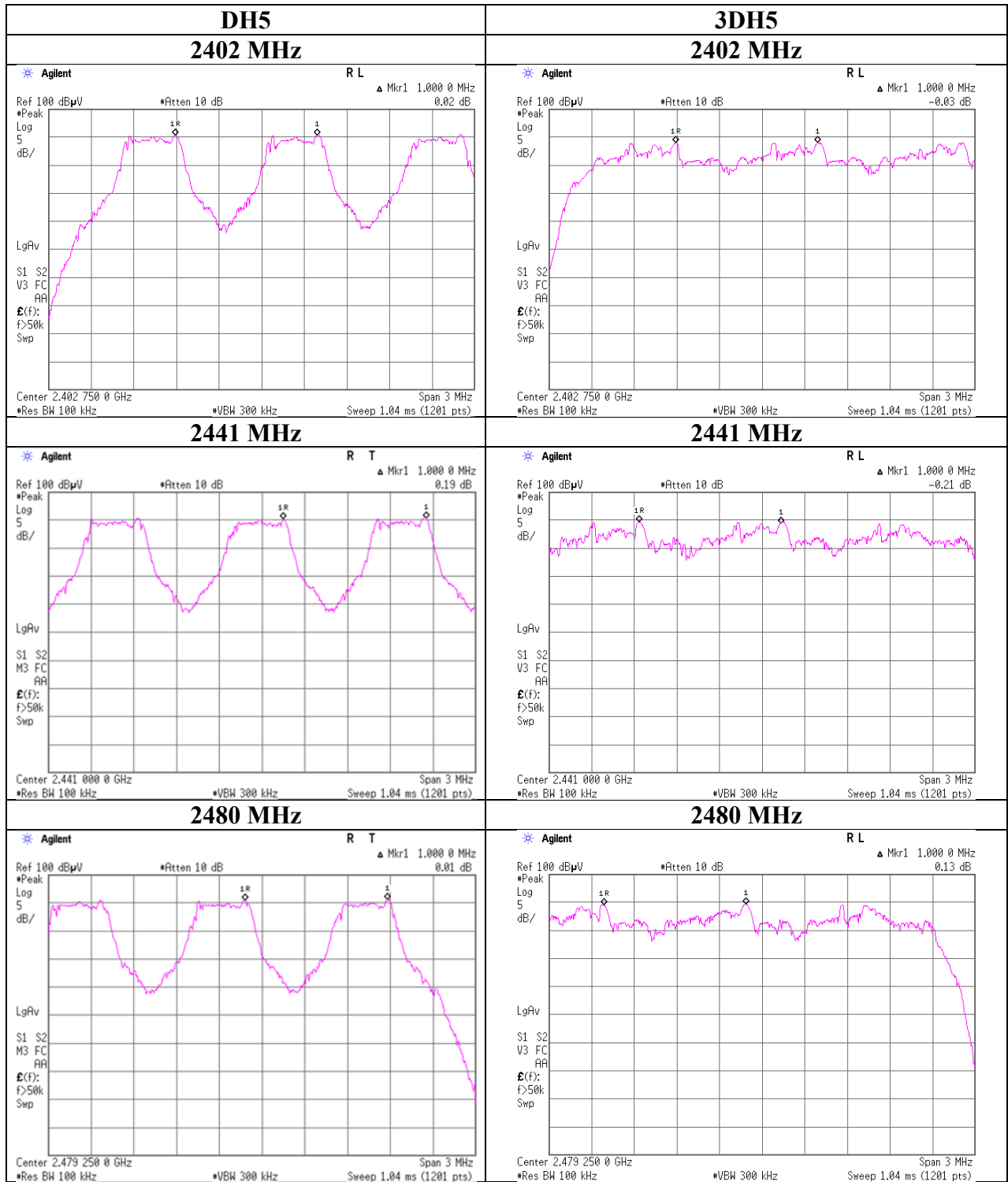

UL Japan, Inc.

Shonan EMC Lab.

1-22-3 Megumigaoka, Hiratsuka-shi, Kanagawa-ken, 259-1220 JAPAN

Telephone : +81 463 50 6400

Facsimile : +81 463 50 6401

Number of Hopping Frequency

Report No. 12656071S-H
Test place Shonan EMC Lab. No.1 Measurement Room
Date March 12, 2019
Temperature / Humidity 23 deg. C / 59 % RH
Engineer Kenichi Adachi
Mode Tx, Hopping On

Mode	Number of channel [channels]	Limit [channels]
DH5	79	≥ 15
3DH5	79	≥ 15

Test was not performed at AFH mode whose number of hopping channel is 20 channels because this Bluetooth radio is in compliance of Bluetooth Specification.

Number of Hopping Frequency

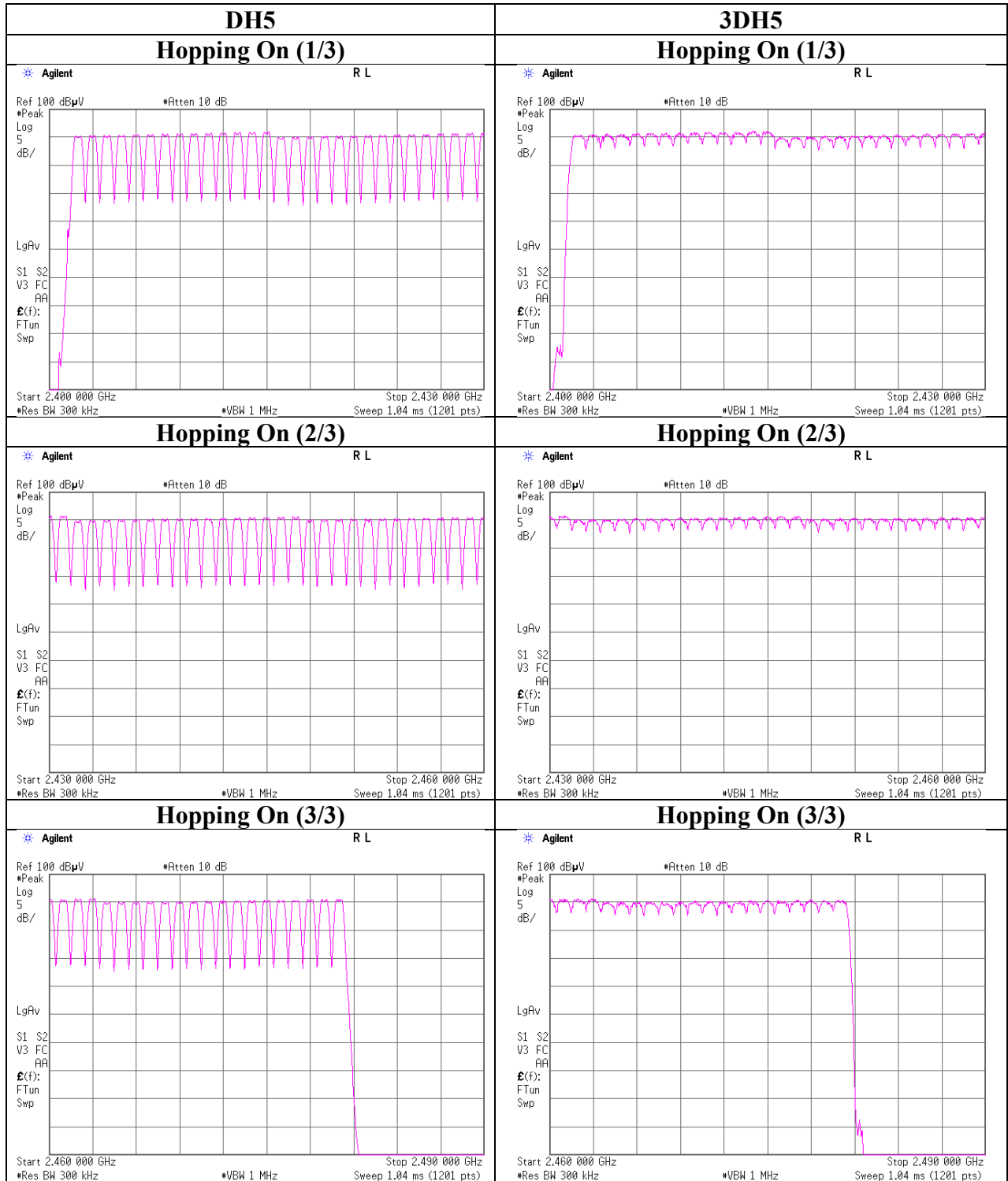

Dwell time

Report No. 12656071S-H
Test place Shonan EMC Lab. No.1 Measurement Room
Date March 12, 2019
Temperature / Humidity 23 deg. C / 59 % RH
Engineer Kenichi Adachi
Mode Tx, Hopping On

Mode	Number of transmission in a 31.6 (79 Hopping x 0.4) second period		Length of transmission [ms]	Result [ms]	Limit [ms]
DH1	50.4 times / 5 s	x 31.6 s = 319 times	0.422	135	400
DH3	27.8 times / 5 s	x 31.6 s = 176 times	1.683	296	400
DH5	18.2 times / 5 s	x 31.6 s = 116 times	2.946	342	400
3DH1	49.8 times / 5 s	x 31.6 s = 315 times	0.428	135	400
3DH3	29.6 times / 5 s	x 31.6 s = 188 times	1.679	316	400
3DH5	20.2 times / 5 s	x 31.6 s = 128 times	2.935	376	400

Sample Calculation

Result = Number of transmission x Length of transmission

*Average data of 5 tests.(except Inquiry)

Mode	Sampling [times]					Average [times]
	1	2	3	4	5	
DH1	50	51	50	51	50	50.4
DH3	32	26	27	26	28	27.8
DH5	17	17	20	18	19	18.2
3DH1	50	50	49	50	50	49.8
3DH3	32	30	30	28	28	29.6
3DH5	20	19	20	21	21	20.2

Sample Calculation

Average = Summation (Sampling 1 to 5) / 5

This device complies with the Bluetooth protocol for FHSS operation, employing a pseudo random channel selection and hopping rate to ensure that the occupancy time in $N \times 0.4$ s, where N is the number of channels being used in the hopping sequence ($20 \leq N \leq 79$), is always less than 0.4 s regardless of packet size. This is confirmed in the test report for $N = 79$.

Dwell time

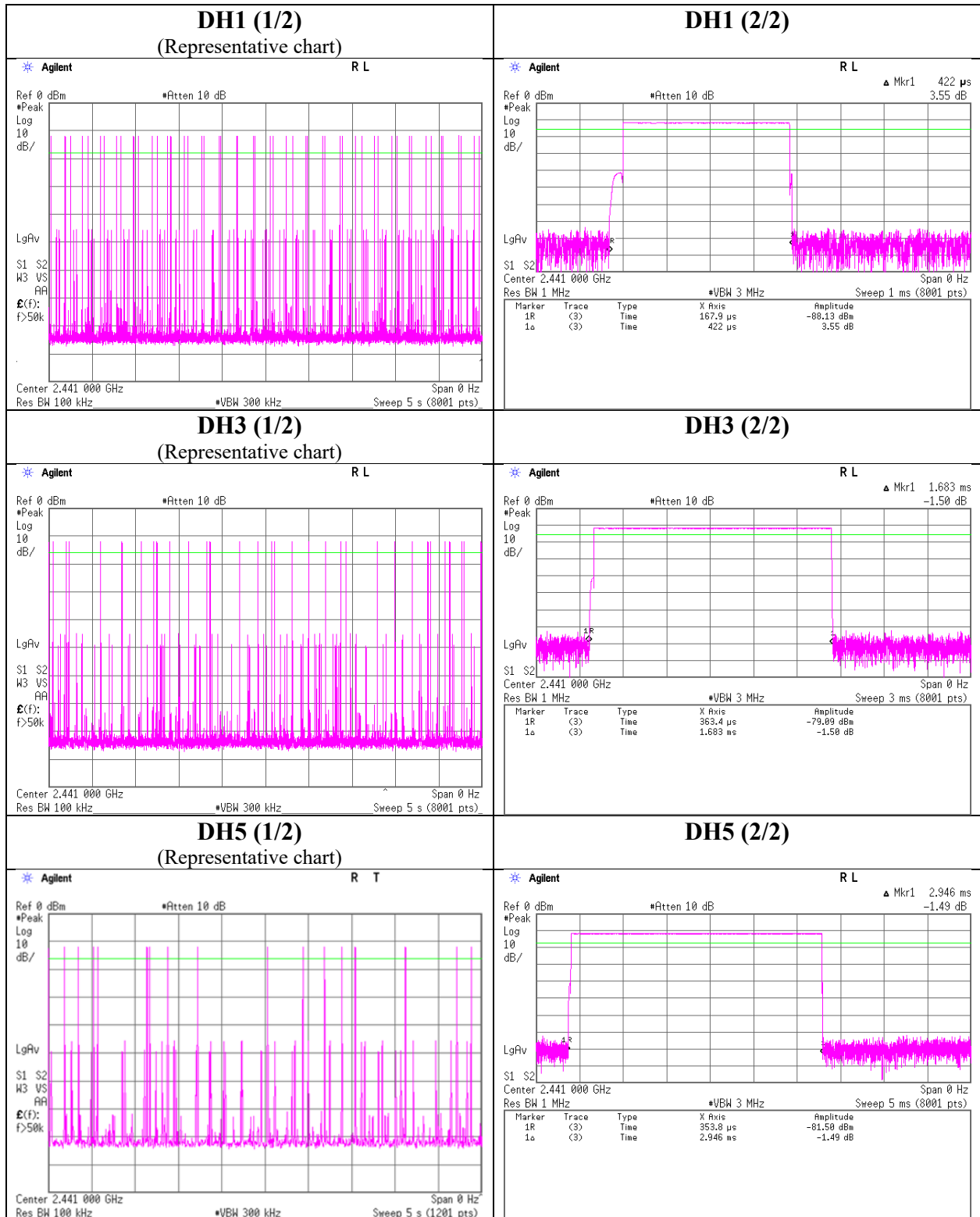

UL Japan, Inc.

Shonan EMC Lab.

1-22-3 Megumigaoka, Hiratsuka-shi, Kanagawa-ken, 259-1220 JAPAN

Telephone : +81 463 50 6400

Facsimile : +81 463 50 6401

Dwell time

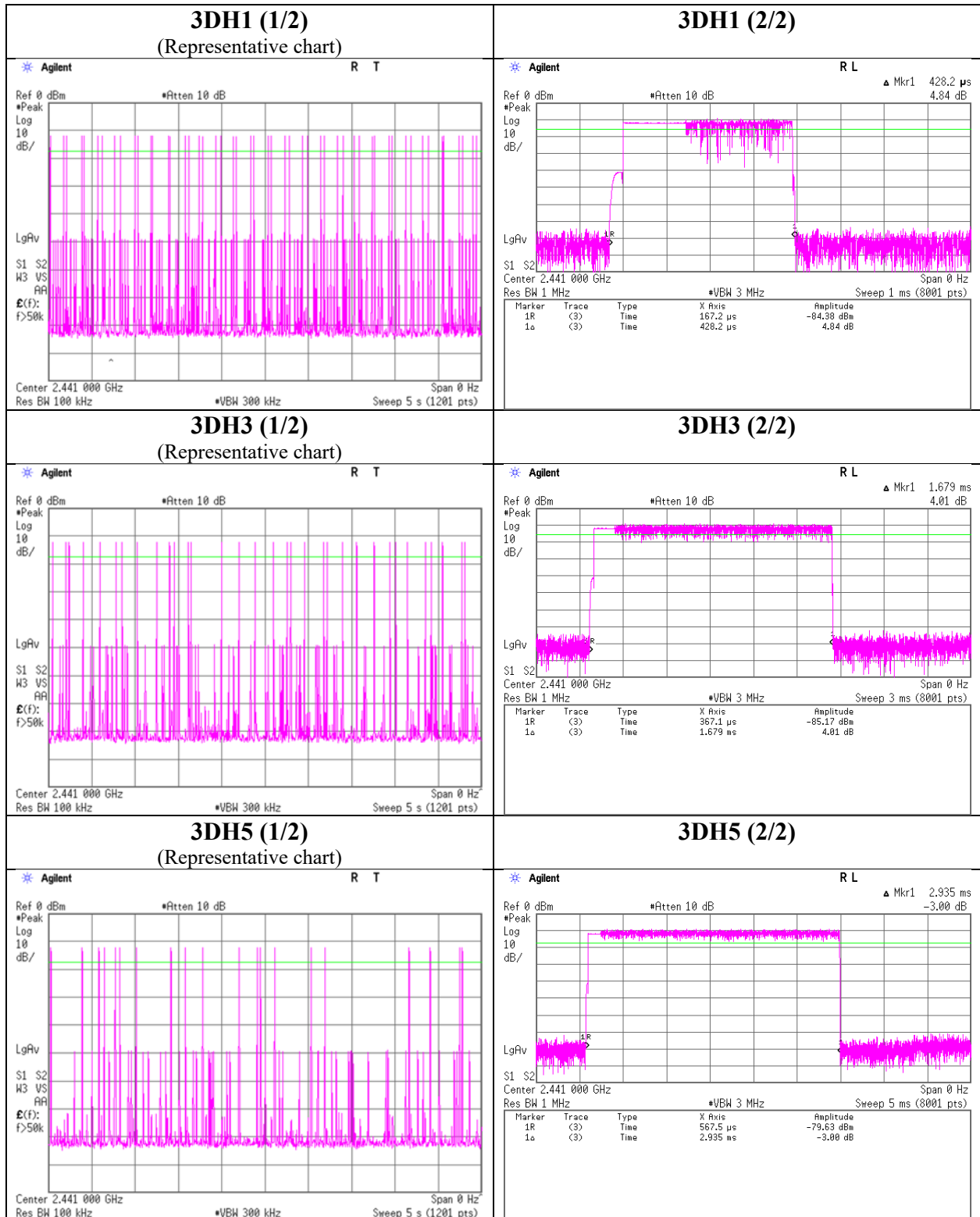

UL Japan, Inc.

Shonan EMC Lab.

1-22-3 Megumigaoka, Hiratsuka-shi, Kanagawa-ken, 259-1220 JAPAN

Telephone : +81 463 50 6400

Facsimile : +81 463 50 6401

Maximum Peak Output Power

Report No. 12656071S-H
Test place Shonan EMC Lab. No.1 Measurement Room
Date January 7, 2019
Temperature / Humidity 23 deg. C / 24 % RH
Engineer Yosuke Ishikawa
Mode Tx, Hopping Off

Mode	Freq. [MHz]	Reading [dBm]	Cable Loss [dB]	Atten. Loss [dB]	Conducted Power					e.i.r.p. for RSS-247					
					Result		Limit		Margin [dB]	Antenna Gain [dBi]	Result		Limit		Margin [dB]
					[dBm]	[mW]	[dBm]	[mW]			[dBm]	[mW]	[dBm]	[mW]	
DH5	2402.0	-11.26	2.40	10.18	1.32	1.36	20.96	125	19.64	-0.90	0.42	1.10	36.02	4000	35.60
DH5	2441.0	-11.15	2.41	10.18	1.44	1.39	20.96	125	19.52	-0.90	0.54	1.13	36.02	4000	35.48
DH5	2480.0	-10.97	2.42	10.18	1.63	1.46	20.96	125	19.33	-0.90	0.73	1.18	36.02	4000	35.29
2DH5	2402.0	-8.72	2.40	10.18	3.86	2.43	20.96	125	17.10	-0.90	2.96	1.98	36.02	4000	33.06
2DH5	2441.0	-8.69	2.41	10.18	3.90	2.45	20.96	125	17.06	-0.90	3.00	2.00	36.02	4000	33.02
2DH5	2480.0	-8.67	2.42	10.18	3.93	2.47	20.96	125	17.03	-0.90	3.03	2.01	36.02	4000	32.99
3DH5	2402.0	-8.41	2.40	10.18	4.17	2.61	20.96	125	16.79	-0.90	3.27	2.12	36.02	4000	32.75
3DH5	2441.0	-8.45	2.41	10.18	4.14	2.59	20.96	125	16.82	-0.90	3.24	2.11	36.02	4000	32.78
3DH5	2480.0	-8.35	2.42	10.18	4.25	2.66	20.96	125	16.71	-0.90	3.35	2.16	36.02	4000	32.67

Sample Calculation:

Result = Reading + Cable Loss (including the cable(s) customer supplied) + Attenuator Loss

e.i.r.p. Result = Conducted Power Result + Antenna Gain

Test was not performed at AFH mode, because the decrease of number of channel (min: 20 ch) at AFH mode does not influence on the output power and bandwidth of the EUT.

As this device had AFH mode and frequency separation could not meet the requirement of over 20 dB BW without 2/3 relaxation, 125 mW power limit was applied to it.

Average Output Power
(Reference data for SAR testing)

Report No. 12656071S-H
Test place Shonan EMC Lab. No.1 Measurement Room
Date January 7, 2019
Temperature / Humidity 23 deg. C / 24 % RH
Engineer Yosuke Ishikawa
Mode Tx, Hopping Off

Mode	Freq. [MHz]	Reading [dBm]	Cable Loss [dB]	Atten. Loss [dB]	Result (Time average)		Duty factor [dB]	Result (Burst power average)	
					[dBm]	[mW]		[dBm]	[mW]
DH5	2402.0	-12.91	2.40	10.18	-0.33	0.93	1.08	0.75	1.19
DH5	2441.0	-12.79	2.41	10.18	-0.20	0.95	1.08	0.88	1.22
DH5	2480.0	-12.64	2.42	10.18	-0.04	0.99	1.08	1.04	1.27
2DH5	2402.0	-12.72	2.40	10.18	-0.14	0.97	1.07	0.93	1.24
2DH5	2441.0	-12.71	2.41	10.18	-0.12	0.97	1.07	0.95	1.24
2DH5	2480.0	-12.70	2.42	10.18	-0.10	0.98	1.07	0.97	1.25
3DH5	2402.0	-12.72	2.40	10.18	-0.14	0.97	1.07	0.93	1.24
3DH5	2441.0	-12.71	2.41	10.18	-0.12	0.97	1.07	0.95	1.24
3DH5	2480.0	-12.70	2.42	10.18	-0.10	0.98	1.07	0.97	1.25

Sample Calculation:

Result (Time average) = Reading + Cable Loss (including the cable(s) customer supplied) + Attenuator Loss

Result (Burst power average) = Time average + Duty factor

*The equipment and cables were not used for factor 0 dB of the data sheets.

UL Japan, Inc.

Shonan EMC Lab.

1-22-3 Megumigaoka, Hiratsuka-shi, Kanagawa-ken, 259-1220 JAPAN

Telephone : +81 463 50 6400

Facsimile : +81 463 50 6401

Burst Rate Confirmation

Report No. 12656071S-H
Test place Shonan EMC Lab. No.1 Measurement Room
Date January 7, 2019
Temperature / Humidity 23 deg. C / 24 % RH
Engineer Yosuke Ishikawa
Mode Tx, Hopping Off

DH5

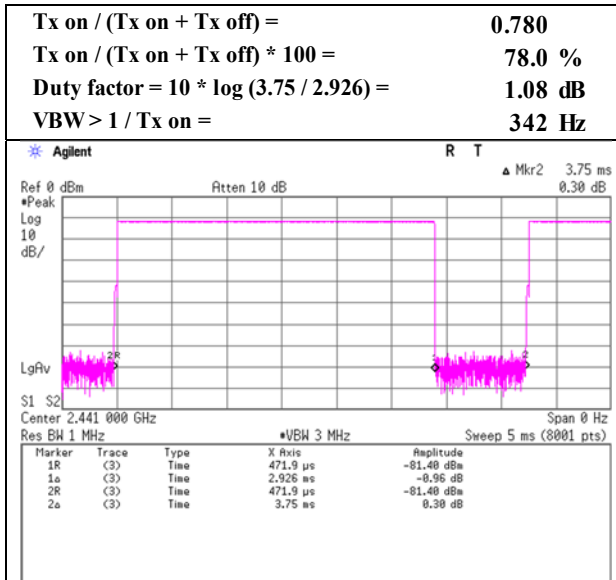

2DH5

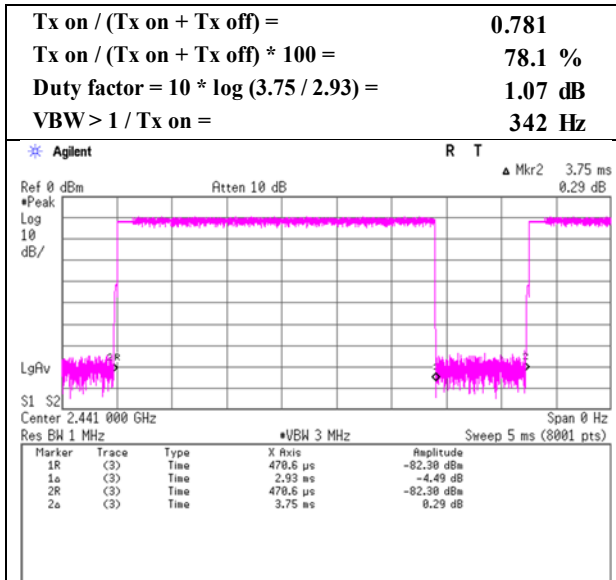

3DH5

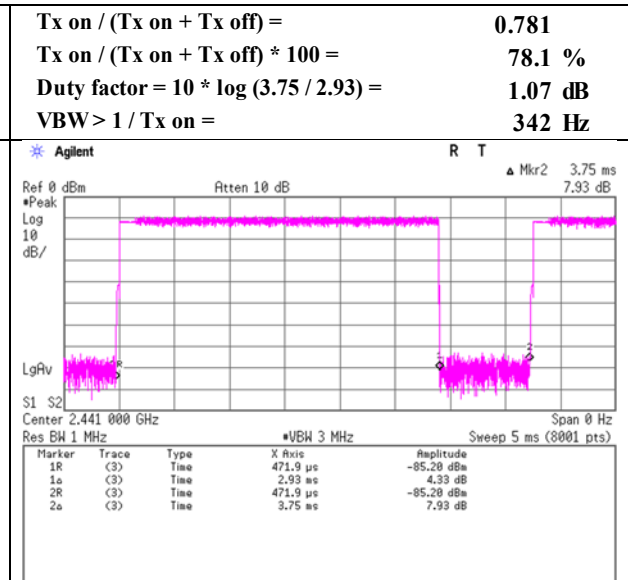

UL Japan, Inc.

Shonan EMC Lab.

1-22-3 Megumigaoka, Hiratsuka-shi, Kanagawa-ken, 259-1220 JAPAN

Telephone : +81 463 50 6400

Facsimile : +81 463 50 6401

Radiated Spurious Emission

Test place	Shonan EMC Lab.		
Semi Anechoic Chamber	No.3	No.3	No.3
Date	January 7, 2019	February 27, 2019	March 11, 2019
Temperature / Humidity	22 deg.C / 30 %RH	24 deg.C / 39 %RH	23 deg.C / 33 %RH
Engineer	Kazutaka Takeyama (30 MHz - 1000 MHz)	Kenichi Adachi (1 GHz - 13 GHz)	Kenichi Adachi (13 GHz - 26.5 GHz)
Mode	Tx, 2402 MHz Tx, Bluetooth, DH5, PRBS9,		

(* PK: Peak, AV: Average, QP: Quasi-Peak)

Polarity	Frequency [MHz]	Detector	Reading [dBuV]	Ant.Fac. [dB/m]	Loss [dB]	Gain [dB]	Distance Factor [dB]	Result [dBuV/m]	Limit [dBuV/m]	Margin [dB]	Height [cm]	Angle [deg]	Remark
Hori.	115.857	QP	36.70	12.70	7.23	32.15	0.00	24.48	43.50	19.0	300	124	
Hori.	380.925	QP	42.80	15.21	9.16	31.97	0.00	35.20	46.00	10.8	100	96	
Hori.	405.500	QP	42.30	15.97	9.27	31.98	0.00	35.56	46.00	10.4	100	115	
Hori.	430.080	QP	40.40	16.33	9.37	31.97	0.00	34.13	46.00	11.8	100	103	
Hori.	442.368	QP	34.30	16.62	9.42	31.97	0.00	28.37	46.00	17.6	100	328	
Hori.	454.656	QP	38.30	16.81	9.47	31.97	0.00	32.61	46.00	13.3	100	333	
Hori.	2390.000	PK	45.18	27.86	14.79	41.59	2.26	48.50	73.90	25.4	168	258	
Hori.	3202.654	PK	49.63	28.83	6.49	41.94	2.26	45.27	73.90	28.6	154	315	
Hori.	4804.000	PK	56.54	31.43	7.36	42.88	2.26	54.71	73.90	19.1	167	88	
Hori.	7206.000	PK	47.78	36.79	9.34	42.92	2.26	53.25	73.90	20.6	150	0	
Hori.	9608.000	PK	48.63	38.51	10.73	43.17	2.26	56.96	73.90	16.9	121	6	
Hori.	12010.000	PK	47.35	39.24	11.82	42.29	2.26	58.38	73.90	15.5	150	0	
Hori.	2390.000	AV	35.45	27.86	14.79	41.59	2.26	38.77	53.90	15.1	168	258	VBW: 360 Hz
Hori.	3202.654	AV	40.87	28.83	6.49	41.94	2.26	36.51	53.90	17.3	154	315	VBW: 360 Hz
Hori.	4804.000	AV	51.90	31.43	7.36	42.88	2.26	50.07	53.90	3.8	167	88	VBW: 360 Hz
Hori.	7206.000	AV	36.32	36.79	9.34	42.92	2.26	41.79	53.90	12.1	150	0	VBW: 360 Hz
Hori.	9608.000	AV	37.97	38.51	10.73	43.17	2.26	46.30	53.90	7.6	121	6	VBW: 360 Hz
Hori.	12010.000	AV	36.38	39.24	11.82	42.29	2.26	47.41	53.90	6.4	150	0	VBW: 360 Hz
Vert.	36.971	QP	37.60	16.01	6.58	32.20	0.00	27.99	40.00	12.0	100	173	
Vert.	345.014	QP	40.30	15.05	9.00	31.95	0.00	32.40	46.00	13.6	100	180	
Vert.	921.601	QP	35.10	22.02	11.14	30.90	0.00	37.36	46.00	8.6	100	358	
Vert.	2390.000	PK	45.12	27.86	14.79	41.59	2.26	48.44	73.90	25.4	202	86	
Vert.	3202.654	PK	50.76	28.83	6.49	41.94	2.26	46.40	73.90	27.5	256	312	
Vert.	4804.000	PK	57.43	31.43	7.36	42.88	2.26	55.60	73.90	18.3	162	44	
Vert.	7206.000	PK	47.84	36.79	9.34	42.92	2.26	53.31	73.90	20.5	150	0	
Vert.	9608.000	PK	48.87	38.51	10.73	43.17	2.26	57.20	73.90	16.7	100	63	
Vert.	12010.000	PK	47.33	39.24	11.82	42.29	2.26	58.36	73.90	15.5	150	0	
Vert.	2390.000	AV	35.41	27.86	14.79	41.59	2.26	38.73	53.90	15.1	202	86	VBW: 360 Hz
Vert.	3202.654	AV	43.44	28.83	6.49	41.94	2.26	39.08	53.90	14.8	256	312	VBW: 360 Hz
Vert.	4804.000	AV	53.11	31.43	7.36	42.88	2.26	51.28	53.90	2.6	162	44	VBW: 360 Hz
Vert.	7206.000	AV	36.36	36.79	9.34	42.92	2.26	41.83	53.90	12.0	150	0	VBW: 360 Hz
Vert.	9608.000	AV	38.01	38.51	10.73	43.17	2.26	46.34	53.90	7.5	100	63	VBW: 360 Hz
Vert.	12010.000	AV	36.34	39.24	11.82	42.29	2.26	47.37	53.90	6.5	150	0	VBW: 360 Hz

Result = Reading + Ant.Fac. + Loss (Cable+(Attenuator or Filter)(below 18 GHz)) - Gain(Amplifier) + Distance factor

Distance factor : 1 GHz - 13 GHz : 20log (3.89 m / 3.0 m) = 2.26 dB

13 GHz - 40 GHz : 20log (1.0 m / 3.0 m) = -9.54 dB

* These results have sufficient margin without taking account Duty cycle correction factor.

20 dBc Data Sheet (RBW 100 kHz, VBW 300 kHz)

Polarity	Frequency [MHz]	Detector	Reading [dBuV]	Ant.Fac. [dB/m]	Loss [dB]	Gain [dB]	Distance Factor [dB]	Result [dBuV/m]	Limit [dBuV/m]	Margin [dB]	Remark
Hori.	2402.000	PK	92.78	27.86	14.80	41.60	2.26	96.10	-	-	Carrier
Hori.	2400.000	PK	38.64	27.86	14.80	41.60	2.26	41.96	76.10	34.1	
Vert.	2402.000	PK	92.75	27.86	14.80	41.60	2.26	96.07	-	-	Carrier
Vert.	2400.000	PK	38.60	27.86	14.80	41.60	2.26	41.92	76.07	34.1	

Result = Reading + Ant.Fac. + Loss (Cable+(Attenuator or Filter)(below 18 GHz)) - Gain(Amplifier) + Distance factor

Distance factor : 1 GHz - 13 GHz : 20log (3.89 m / 3.0 m) = 2.26 dB

13 GHz - 40 GHz : 20log (1.0 m / 3.0 m) = -9.54 dB

UL Japan, Inc.

Shonan EMC Lab.

1-22-3 Megumigaoka, Hiratsuka-shi, Kanagawa-ken, 259-1220 JAPAN

Telephone : +81 463 50 6400

Facsimile : +81 463 50 6401

**Radiated Spurious Emission
(Reference Plot for band-edge)**

Report No.	12656071S-H
Test place	Shonan EMC Lab.
Semi Anechoic Chamber	No.3
Date	February 27, 2019
Temperature / Humidity	24 deg. C / 39 % RH
Engineer	Kenichi Adachi (1 GHz -13 GHz)
Mode	Tx, Hopping Off, DH5 2402 MHz

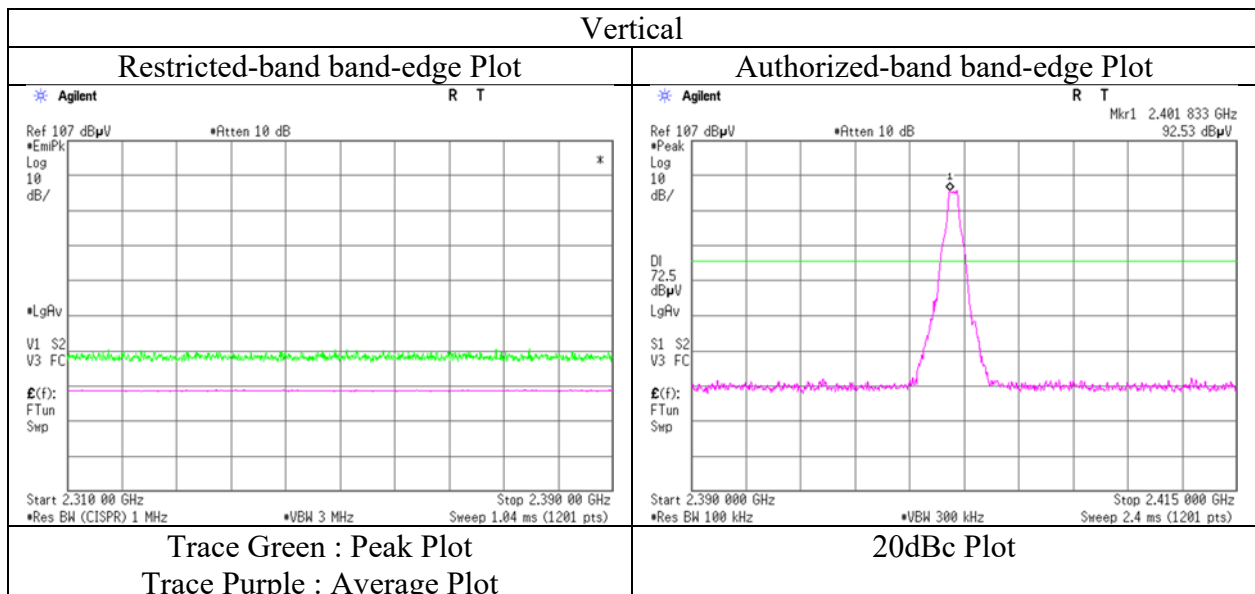
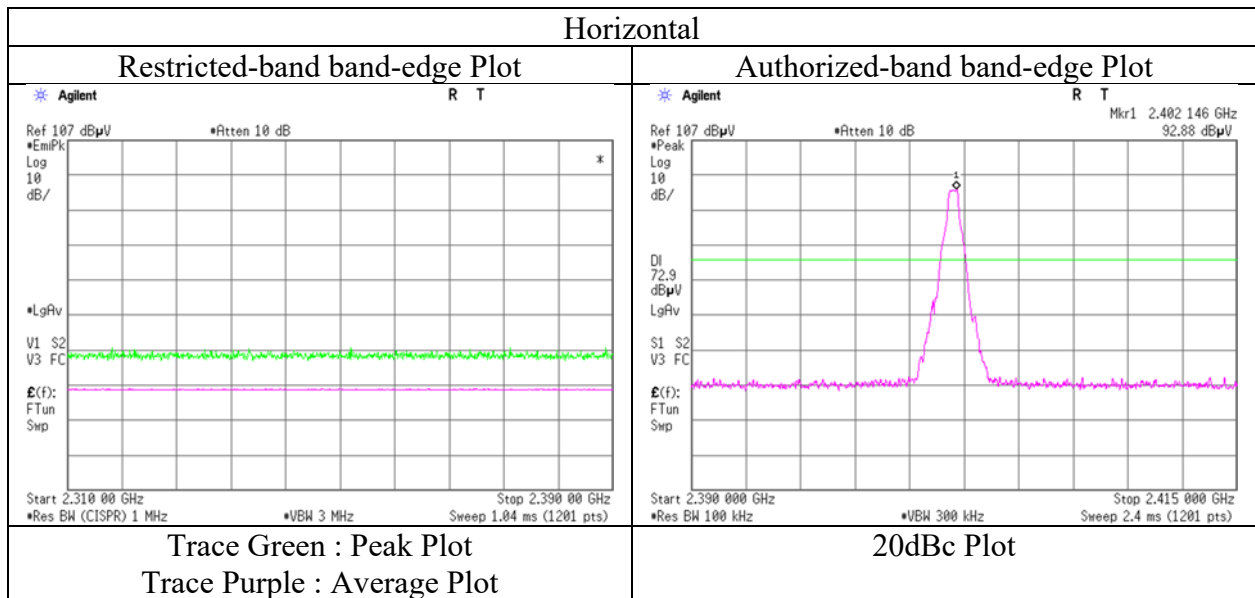

* The measurement was conducted for a sufficiently long enough time to detect any possible spurious emissions.
Final result of restricted band edge was shown in tabular data.

Radiated Spurious Emission

Test place	Shonan EMC Lab.		
Semi Anechoic Chamber	No.3	No.3	No.3
Date	January 7, 2019	February 27, 2019	March 11, 2019
Temperature / Humidity	22 deg.C / 30 %RH	24 deg.C / 39 %RH	23 deg.C / 33 %RH
Engineer	Kazutaka Takeyama (30 MHz - 1000 MHz)	Kenichi Adachi (1 GHz - 13 GHz)	Kenichi Adachi (13 GHz - 26.5 GHz)
Mode	Tx, 2441 MHz Tx, Bluetooth, DH5, PRBS9,		

(* PK: Peak, AV: Average, QP: Quasi-Peak)

Polarity	Frequency [MHz]	Detector	Reading [dBuV]	Ant.Fac. [dB/m]	Loss [dB]	Gain [dB]	Distance Factor [dB]	Result [dBuV/m]	Limit [dBuV/m]	Margin [dB]	Height [cm]	Angle [deg]	Remark
Hori.	115.842	QP	38.30	12.69	7.23	32.15	0.00	26.07	43.50	17.4	300	125	
Hori.	380.841	QP	41.40	15.21	9.16	31.97	0.00	33.80	46.00	12.2	100	77	
Hori.	405.503	QP	40.50	15.97	9.27	31.98	0.00	33.76	46.00	12.2	100	75	
Hori.	430.079	QP	40.60	16.33	9.37	31.97	0.00	34.33	46.00	11.6	100	66	
Hori.	3254.645	PK	47.98	28.43	6.52	41.97	2.26	43.22	73.90	30.6	154	317	
Hori.	4882.000	PK	49.54	31.37	7.41	42.89	2.26	47.69	73.90	26.2	168	86	
Hori.	7323.000	PK	47.11	37.01	9.36	43.15	2.26	52.59	73.90	21.3	150	0	
Hori.	9764.000	PK	48.78	38.92	10.62	43.01	2.26	57.57	73.90	16.3	122	8	
Hori.	12205.000	PK	47.51	39.22	11.92	42.19	2.26	58.72	73.90	15.1	150	0	
Hori.	3254.645	AV	35.98	28.43	6.52	41.97	2.26	31.22	53.90	22.6	154	317	VBW: 360 Hz
Hori.	4882.000	AV	45.98	31.37	7.41	42.89	2.26	44.13	53.90	9.7	168	86	VBW: 360 Hz
Hori.	7323.000	AV	36.48	37.01	9.36	43.15	2.26	41.96	53.90	11.9	150	0	VBW: 360 Hz
Hori.	9764.000	AV	36.84	38.92	10.62	43.01	2.26	45.63	53.90	8.2	122	8	VBW: 360 Hz
Hori.	12205.000	AV	35.91	39.22	11.92	42.19	2.26	47.12	53.90	6.7	150	0	VBW: 360 Hz
Vert.	38.442	QP	37.20	15.42	6.61	32.20	0.00	27.03	40.00	12.9	100	180	
Vert.	345.013	QP	41.60	15.05	9.00	31.95	0.00	33.70	46.00	12.3	100	183	
Vert.	897.600	QP	33.30	22.11	11.06	31.11	0.00	35.36	46.00	10.6	100	7	
Vert.	921.589	QP	36.00	22.02	11.14	30.90	0.00	38.26	46.00	7.7	100	358	
Vert.	3254.645	PK	48.94	28.43	6.52	41.97	2.26	44.18	73.90	29.7	178	315	
Vert.	4882.000	PK	51.96	31.37	7.41	42.89	2.26	50.11	73.90	23.7	164	42	
Vert.	7323.000	PK	47.04	37.01	9.36	43.15	2.26	52.52	73.90	21.3	150	0	
Vert.	9764.000	PK	48.85	38.92	10.62	43.01	2.26	57.64	73.90	16.2	100	65	
Vert.	12205.000	PK	47.43	39.22	11.92	42.19	2.26	58.64	73.90	15.2	150	0	
Vert.	3254.645	AV	38.43	28.43	6.52	41.97	2.26	33.67	53.90	20.2	178	315	VBW: 360 Hz
Vert.	4882.000	AV	47.67	31.37	7.41	42.89	2.26	45.82	53.90	8.0	164	42	VBW: 360 Hz
Vert.	7323.000	AV	36.44	37.01	9.36	43.15	2.26	41.92	53.90	11.9	150	0	VBW: 360 Hz
Vert.	9764.000	AV	36.96	38.92	10.62	43.01	2.26	45.75	53.90	8.1	100	65	VBW: 360 Hz
Vert.	12205.000	AV	35.82	39.22	11.92	42.19	2.26	47.03	53.90	6.8	150	0	VBW: 360 Hz

Result = Reading + Ant.Fac. + Loss (Cable+(Attenuator or Filter)(below 18 GHz)) - Gain(Amplifier) + Distance factor

Distance factor : 1 GHz - 13 GHz : $20\log(3.89\text{ m} / 3.0\text{ m}) = 2.26\text{ dB}$

13 GHz - 40 GHz : $20\log(1.0\text{ m} / 3.0\text{ m}) = -9.54\text{ dB}$

* These results have sufficient margin without taking account Duty cycle correction factor.

Radiated Spurious Emission

Test place	Shonan EMC Lab.		
Semi Anechoic Chamber	No.3	No.3	No.3
Date	January 7, 2019	February 27, 2019	March 11, 2019
Temperature / Humidity	22 deg.C / 30 %RH	24 deg.C / 39 %RH	23 deg.C / 33 %RH
Engineer	Kazutaka Takeyama (30 MHz - 1000 MHz)	Kenichi Adachi (1 GHz - 13 GHz)	Kenichi Adachi (13 GHz - 26.5 GHz)
Mode	Tx, 2480 MHz Tx, Bluetooth, DH5, PRBS9,		

(* PK: Peak, AV: Average, QP: Quasi-Peak)

Polarity	Frequency [MHz]	Detector	Reading [dBuV]	Ant.Fac. [dB/m]	Loss [dB]	Gain [dB]	Distance Factor [dB]	Result [dBuV/m]	Limit [dBuV/m]	Margin [dB]	Height [cm]	Angle [deg]	Remark
Hori.	115.840	QP	38.50	12.69	7.23	32.15	0.00	26.27	43.50	17.2	300	126	
Hori.	380.845	QP	41.10	15.21	9.16	31.97	0.00	33.50	46.00	12.5	100	280	
Hori.	405.500	QP	40.30	15.97	9.27	31.98	0.00	33.56	46.00	12.4	100	287	
Hori.	430.800	QP	40.90	16.34	9.37	31.97	0.00	34.64	46.00	11.3	100	287	
Hori.	2483.500	PK	47.02	27.65	14.88	41.62	2.26	50.19	73.90	23.7	173	249	
Hori.	3306.637	PK	48.64	28.12	6.53	42.00	2.26	43.55	73.90	30.3	152	312	
Hori.	4960.000	PK	50.63	31.54	7.46	42.91	2.26	48.98	73.90	24.9	175	94	
Hori.	7440.000	PK	46.49	37.10	9.38	43.38	2.26	51.85	73.90	22.0	150	0	
Hori.	9920.000	PK	46.49	38.97	10.51	42.84	2.26	55.39	73.90	18.5	119	4	
Hori.	12400.000	PK	45.24	38.65	11.99	42.08	2.26	56.06	73.90	17.8	150	0	
Hori.	2483.500	AV	35.91	27.65	14.88	41.62	2.26	39.08	53.90	14.8	173	249	VBW: 360 Hz
Hori.	3306.637	AV	40.04	28.12	6.53	42.00	2.26	34.95	53.90	18.9	152	312	VBW: 360 Hz
Hori.	4960.000	AV	43.54	31.54	7.46	42.91	2.26	41.89	53.90	12.0	175	94	VBW: 360 Hz
Hori.	7440.000	AV	37.05	37.10	9.38	43.38	2.26	42.41	53.90	11.4	150	0	VBW: 360 Hz
Hori.	9920.000	AV	36.06	38.97	10.51	42.84	2.26	44.96	53.90	8.9	119	4	VBW: 360 Hz
Hori.	12400.000	AV	33.42	38.65	11.99	42.08	2.26	44.24	53.90	9.6	150	0	VBW: 360 Hz
Vert.	38.440	QP	37.10	15.44	6.61	32.20	0.00	26.95	40.00	13.0	100	4	
Vert.	345.011	QP	41.50	15.05	9.00	31.95	0.00	33.60	46.00	12.4	100	22	
Vert.	897.014	QP	35.50	22.10	11.06	31.11	0.00	37.55	46.00	8.4	100	3	
Vert.	909.303	QP	34.80	22.06	11.10	31.01	0.00	36.95	46.00	9.0	100	358	
Vert.	2483.500	PK	47.29	27.65	14.88	41.62	2.26	50.46	73.90	23.4	200	85	
Vert.	3306.637	PK	48.94	28.12	6.53	42.00	2.26	43.85	73.90	30.0	252	309	
Vert.	4960.000	PK	50.54	31.54	7.46	42.91	2.26	48.89	73.90	25.0	163	45	
Vert.	7440.000	PK	46.44	37.10	9.38	43.38	2.26	51.80	73.90	22.1	150	0	
Vert.	9920.000	PK	46.52	38.97	10.51	42.84	2.26	55.42	73.90	18.4	100	66	
Vert.	12400.000	PK	45.12	38.65	11.99	42.08	2.26	55.94	73.90	17.9	150	0	
Vert.	2483.500	AV	35.98	27.65	14.88	41.62	2.26	39.15	53.90	14.7	200	85	VBW: 360 Hz
Vert.	3306.637	AV	40.16	28.12	6.53	42.00	2.26	35.07	53.90	18.8	252	309	VBW: 360 Hz
Vert.	4960.000	AV	43.22	31.54	7.46	42.91	2.26	41.57	53.90	12.3	163	45	VBW: 360 Hz
Vert.	7440.000	AV	37.00	37.10	9.38	43.38	2.26	42.36	53.90	11.5	150	0	VBW: 360 Hz
Vert.	9920.000	AV	36.14	38.97	10.51	42.84	2.26	45.04	53.90	8.8	100	66	VBW: 360 Hz
Vert.	12400.000	AV	33.38	38.65	11.99	42.08	2.26	44.20	53.90	9.7	150	0	VBW: 360 Hz

Result = Reading + Ant.Fac. + Loss (Cable+(Attenuator or Filter)(below 18 GHz)) - Gain(Amplifier) + Distance factor

Distance factor : 1 GHz - 13 GHz : 20log (3.89 m / 3.0 m) = 2.26 dB

13 GHz - 40 GHz : 20log (1.0 m / 3.0 m) = -9.54 dB

* These results have sufficient margin without taking account Duty cycle correction factor.

Radiated Spurious Emission
(Reference Plot for band-edge)

Report No. 12656071S-H
Test place Shonan EMC Lab.
Semi Anechoic Chamber No.3
Date February 27, 2019
Temperature / Humidity 24 deg. C / 39 % RH
Engineer Kenichi Adachi
(1 GHz -13 GHz)
Mode Tx, Hopping Off, DH5 2480 MHz

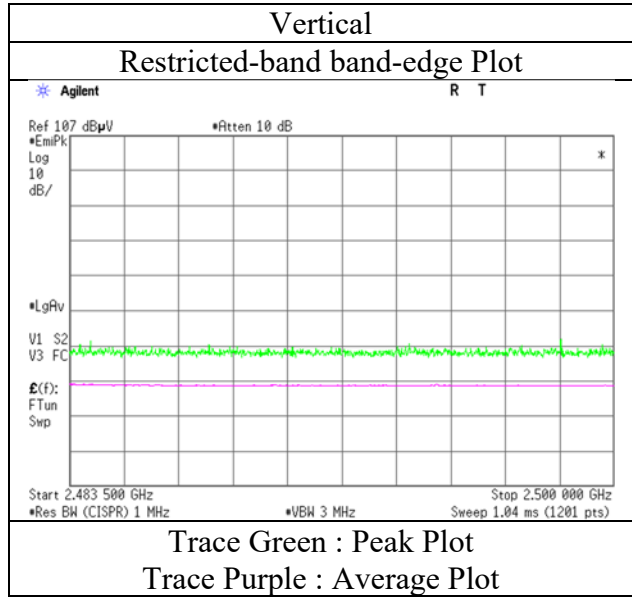
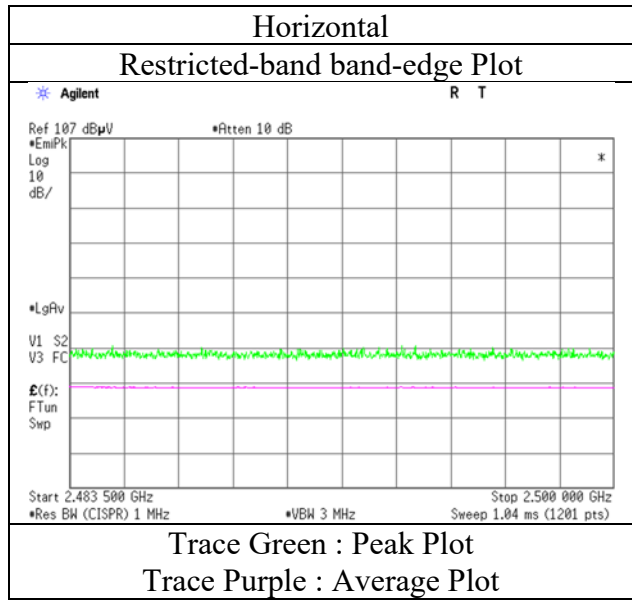

* The measurement was conducted for a sufficiently long enough time to detect any possible spurious emissions. Final result of restricted band edge was shown in tabular data.

Radiated Spurious Emission

Test place	Shonan EMC Lab.		
Semi Anechoic Chamber	No.3	No.3	No.3
Date	January 7, 2019	February 27, 2019	March 11, 2019
Temperature / Humidity	22 deg.C / 30 %RH	24 deg.C / 39 %RH	23 deg.C / 33 %RH
Engineer	Kazutaka Takeyama (30 MHz - 1000 MHz)	Kenichi Adachi (1 GHz - 13 GHz)	Kenichi Adachi (13 GHz - 26.5 GHz)
Mode	Tx, 2402 MHz Tx, Bluetooth, 3DH5, PRBS9,		

(* PK: Peak, AV: Average, QP: Quasi-Peak)

Polarity	Frequency [MHz]	Detector	Reading [dBuV]	Ant.Fac. [dB/m]	Loss [dB]	Gain [dB]	Distance Factor [dB]	Result [dBuV/m]	Limit [dBuV/m]	Margin [dB]	Height [cm]	Angle [deg]	Remark
Hori.	115.850	QP	38.30	12.70	7.23	32.15	0.00	26.08	43.50	17.4	300	127	
Hori.	380.850	QP	41.50	15.21	9.16	31.97	0.00	33.90	46.00	12.1	100	286	
Hori.	405.505	QP	40.80	15.97	9.27	31.98	0.00	34.06	46.00	11.9	100	282	
Hori.	430.800	QP	41.50	16.34	9.37	31.97	0.00	35.24	46.00	10.7	100	289	
Hori.	2390.000	PK	46.00	27.86	14.79	41.59	2.26	49.32	73.90	24.5	200	241	
Hori.	4804.000	PK	60.00	31.43	7.36	42.88	2.26	58.17	73.90	15.7	100	332	
Hori.	7206.000	PK	48.50	36.79	9.34	42.92	2.26	53.97	73.90	19.9	100	0	
Hori.	9608.000	PK	48.40	38.51	10.73	43.17	2.26	56.73	73.90	17.1	100	0	
Hori.	2390.000	AV	35.20	27.86	14.79	41.59	2.26	38.52	53.90	15.3	200	241	VBW: 360 Hz
Hori.	4804.000	AV	54.20	31.43	7.36	42.88	2.26	52.37	53.90	1.5	100	332	VBW: 360 Hz
Hori.	7206.000	AV	36.20	36.79	9.34	42.92	2.26	41.67	53.90	12.2	100	0	VBW: 360 Hz
Hori.	9608.000	AV	37.90	38.51	10.73	43.17	2.26	46.23	53.90	7.6	100	0	VBW: 360 Hz
Vert.	38.444	QP	38.30	15.44	6.61	32.20	0.00	28.15	40.00	11.8	100	1	
Vert.	345.010	QP	42.20	15.05	9.00	31.95	0.00	34.30	46.00	11.7	100	22	
Vert.	897.011	QP	35.90	22.10	11.06	31.11	0.00	37.95	46.00	8.0	100	3	
Vert.	909.300	QP	35.50	22.06	11.10	31.01	0.00	37.65	46.00	8.3	100	356	
Vert.	2390.000	PK	46.30	27.86	14.79	41.59	2.26	49.62	73.90	24.2	100	270	
Vert.	4804.000	PK	58.10	31.43	7.36	42.88	2.26	56.27	73.90	17.6	150	41	
Vert.	7206.000	PK	47.30	36.79	9.34	42.92	2.26	52.77	73.90	21.1	100	0	
Vert.	9608.000	PK	49.00	38.51	10.73	43.17	2.26	57.33	73.90	16.5	100	0	
Vert.	2390.000	AV	35.10	27.86	14.79	41.59	2.26	38.42	53.90	15.4	100	270	VBW: 360 Hz
Vert.	4804.000	AV	51.30	31.43	7.36	42.88	2.26	49.47	53.90	4.4	150	41	VBW: 360 Hz
Vert.	7206.000	AV	36.00	36.79	9.34	42.92	2.26	41.47	53.90	12.4	100	0	VBW: 360 Hz
Vert.	9608.000	AV	37.30	38.51	10.73	43.17	2.26	45.63	53.90	8.2	100	0	VBW: 360 Hz

Result = Reading + Ant.Fac. + Loss (Cable+(Attenuator or Filter)(below 18 GHz)) - Gain(Amplifier) + Distance factor

Distance factor : 1 GHz - 13 GHz : $20\log(3.89\text{ m} / 3.0\text{ m}) = 2.26\text{ dB}$

13 GHz - 40 GHz : $20\log(1.0\text{ m} / 3.0\text{ m}) = -9.54\text{ dB}$

* These results have sufficient margin without taking account Duty cycle correction factor.

20 dBc Data Sheet (RBW 100 kHz, VBW 300 kHz)

Polarity	Frequency [MHz]	Detector	Reading [dBuV]	Ant.Fac. [dB/m]	Loss [dB]	Gain [dB]	Distance Factor [dB]	Result [dBuV/m]	Limit [dBuV/m]	Margin [dB]	Remark
Hori.	2402.000	PK	94.00	27.86	14.80	41.60	2.26	97.32	-	-	Carrier
Hori.	2400.000	PK	39.40	27.86	14.80	41.60	2.26	42.72	77.32	34.6	
Vert.	2402.000	PK	92.20	27.86	14.80	41.60	2.26	95.52	-	-	Carrier
Vert.	2400.000	PK	39.20	27.86	14.80	41.60	2.26	42.52	75.52	33.0	

Result = Reading + Ant.Fac. + Loss (Cable+(Attenuator or Filter)(below 18 GHz)) - Gain(Amplifier) + Distance factor

Distance factor : 1 GHz - 13 GHz : $20\log(3.89\text{ m} / 3.0\text{ m}) = 2.26\text{ dB}$

13 GHz - 40 GHz : $20\log(1.0\text{ m} / 3.0\text{ m}) = -9.54\text{ dB}$

UL Japan, Inc.

Shonan EMC Lab.

1-22-3 Megumigaoka, Hiratsuka-shi, Kanagawa-ken, 259-1220 JAPAN

Telephone : +81 463 50 6400

Facsimile : +81 463 50 6401

Radiated Spurious Emission (Reference Plot for band-edge)

Report No.	12656071S-H
Test place	Shonan EMC Lab.
Semi Anechoic Chamber	No.3
Date	February 27, 2019
Temperature / Humidity	24 deg. C / 39 % RH
Engineer	Kenichi Adachi (1 GHz -13 GHz)
Mode	Tx, Hopping Off, 3DH5 2402 MHz

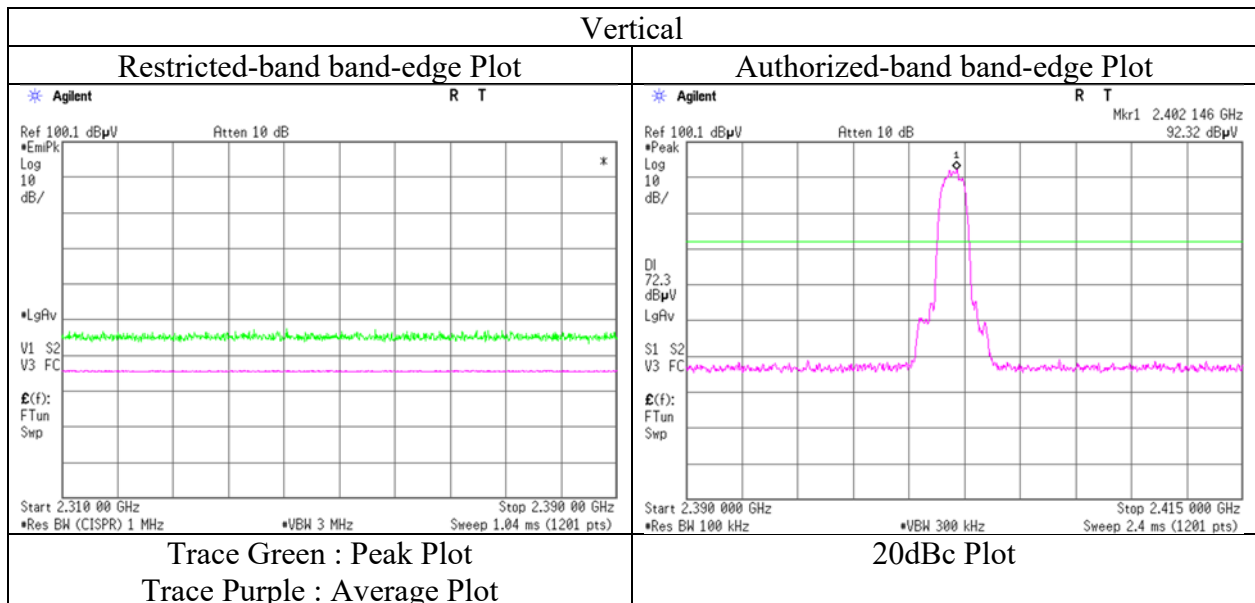
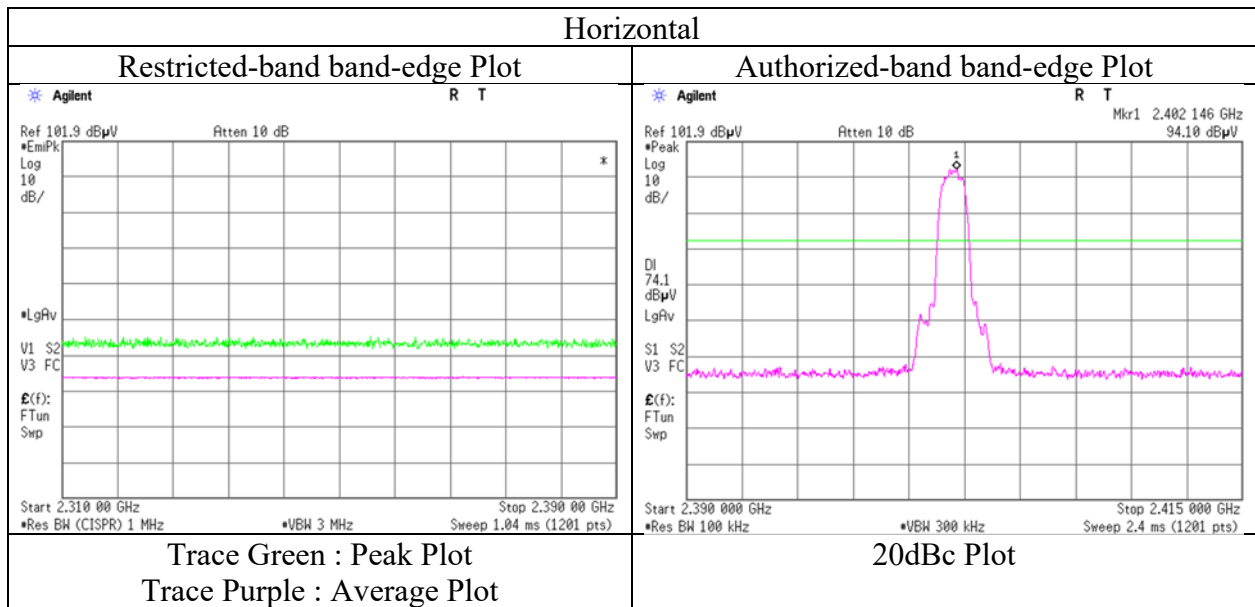

* The measurement was conducted for a sufficiently long enough time to detect any possible spurious emissions. Final result of restricted band edge was shown in tabular data.

Radiated Spurious Emission

Test place	Shonan EMC Lab.		
Semi Anechoic Chamber	No.3	No.3	No.3
Date	January 7, 2019	February 27, 2019	March 11, 2019
Temperature / Humidity	22 deg.C / 30 %RH	24 deg.C / 39 %RH	23 deg.C / 33 %RH
Engineer	Kazutaka Takeyama (30 MHz - 1000 MHz)	Kenichi Adachi (1 GHz - 13 GHz)	Kenichi Adachi (13 GHz - 26.5 GHz)
Mode	Tx, 2441 MHz Tx, Bluetooth, 3DH5, PRBS9,		

(* PK: Peak, AV: Average, QP: Quasi-Peak)

Polarity	Frequency [MHz]	Detector	Reading [dBuV]	Ant.Fac. [dB/m]	Loss [dB]	Gain [dB]	Distance Factor [dB]	Result [dBuV/m]	Limit [dBuV/m]	Margin [dB]	Height [cm]	Angle [deg]	Remark
Hori.	115.840	QP	38.20	12.69	7.23	32.15	0.00	25.97	43.50	17.5	300	125	
Hori.	380.844	QP	41.00	15.21	9.16	31.97	0.00	33.40	46.00	12.6	100	282	
Hori.	405.503	QP	40.40	15.97	9.27	31.98	0.00	33.66	46.00	12.3	100	290	
Hori.	430.804	QP	41.40	16.34	9.37	31.97	0.00	35.14	46.00	10.8	100	288	
Hori.	4882.000	PK	54.80	31.37	7.41	42.89	2.26	52.95	73.90	20.9	100	336	
Hori.	7323.000	PK	47.90	37.01	9.36	43.15	2.26	53.38	73.90	20.5	100	0	
Hori.	9764.000	PK	48.60	38.92	10.62	43.01	2.26	57.39	73.90	16.5	100	0	
Hori.	4882.000	AV	49.00	31.37	7.41	42.89	2.26	47.15	53.90	6.7	100	336	VBW: 360 Hz
Hori.	7323.000	AV	36.00	37.01	9.36	43.15	2.26	41.48	53.90	12.4	100	0	VBW: 360 Hz
Hori.	9764.000	AV	36.50	38.92	10.62	43.01	2.26	45.29	53.90	8.6	100	0	VBW: 360 Hz
Vert.	38.442	QP	38.00	15.44	6.61	32.20	0.00	27.85	40.00	12.1	100	359	
Vert.	345.010	QP	41.80	15.05	9.00	31.95	0.00	33.90	46.00	12.1	100	21	
Vert.	897.014	QP	35.70	22.10	11.06	31.11	0.00	37.75	46.00	8.2	100	3	
Vert.	909.301	QP	35.00	22.06	11.10	31.01	0.00	37.15	46.00	8.8	100	357	
Vert.	4882.000	PK	56.30	31.37	7.41	42.89	2.26	54.45	73.90	19.4	100	41	
Vert.	7323.000	PK	48.60	37.01	9.36	43.15	2.26	54.08	73.90	19.8	100	0	
Vert.	9764.000	PK	49.00	38.92	10.62	43.01	2.26	57.79	73.90	16.1	100	0	
Vert.	4882.000	AV	48.80	31.37	7.41	42.89	2.26	46.95	53.90	6.9	100	41	VBW: 360 Hz
Vert.	7323.000	AV	36.60	37.01	9.36	43.15	2.26	42.08	53.90	11.8	100	0	VBW: 360 Hz
Vert.	9764.000	AV	36.50	38.92	10.62	43.01	2.26	45.29	53.90	8.6	100	0	VBW: 360 Hz

Result = Reading + Ant.Fac. + Loss (Cable+(Attenuator or Filter)(below 18 GHz)) - Gain(Amplifier) + Distance factor

Distance factor : 1 GHz - 13 GHz : $20\log(3.89\text{ m} / 3.0\text{ m}) = 2.26\text{ dB}$

13 GHz - 40 GHz : $20\log(1.0\text{ m} / 3.0\text{ m}) = -9.54\text{ dB}$

* These results have sufficient margin without taking account Duty cycle correction factor.

Radiated Spurious Emission

Test place	Shonan EMC Lab.		
Semi Anechoic Chamber	No.3	No.3	No.3
Date	January 7, 2019	February 27, 2019	March 11, 2019
Temperature / Humidity	22 deg.C / 30 %RH	24 deg.C / 39 %RH	23 deg.C / 33 %RH
Engineer	Kazutaka Takeyama (30 MHz - 1000 MHz)	Kenichi Adachi (1 GHz - 13 GHz)	Kenichi Adachi (13 GHz - 26.5 GHz)
Mode	Tx, 2480 MHz Tx, Bluetooth, 3DH5, PRBS9,		

(* PK: Peak, AV: Average, QP: Quasi-Peak)

Polarity	Frequency [MHz]	Detector	Reading [dBuV]	Ant.Fac. [dB/m]	Loss [dB]	Gain [dB]	Distance Factor [dB]	Result [dBuV/m]	Limit [dBuV/m]	Margin [dB]	Height [cm]	Angle [deg]	Remark
Hori.	115.850	QP	38.30	12.70	7.23	32.15	0.00	26.08	43.50	17.4	300	124	
Hori.	380.845	QP	41.00	15.21	9.16	31.97	0.00	33.40	46.00	12.6	100	282	
Hori.	405.510	QP	40.40	15.97	9.27	31.98	0.00	33.66	46.00	12.3	100	283	
Hori.	430.801	QP	41.20	16.34	9.37	31.97	0.00	34.94	46.00	11.0	101	284	
Hori.	2483.500	PK	46.80	27.65	14.88	41.62	2.26	49.97	73.90	23.9	111	255	
Hori.	4960.000	PK	55.90	31.54	7.46	42.91	2.26	54.25	73.90	19.6	109	338	
Hori.	7440.000	PK	48.40	37.10	9.38	43.38	2.26	53.76	73.90	20.1	100	0	
Hori.	9920.000	PK	47.10	38.97	10.51	42.84	2.26	56.00	73.90	17.9	100	0	
Hori.	2483.500	AV	35.70	27.65	14.88	41.62	2.26	38.87	53.90	15.0	111	255	VBW: 360 Hz
Hori.	4960.000	AV	48.40	31.54	7.46	42.91	2.26	46.75	53.90	7.1	109	338	VBW: 360 Hz
Hori.	7440.000	AV	36.70	37.10	9.38	43.38	2.26	42.06	53.90	11.8	100	0	VBW: 360 Hz
Hori.	9920.000	AV	36.00	38.97	10.51	42.84	2.26	44.90	53.90	9.0	100	0	VBW: 360 Hz
Vert.	38.440	QP	37.00	15.44	6.61	32.20	0.00	26.85	40.00	13.1	100	4	
Vert.	345.011	QP	41.60	15.05	9.00	31.95	0.00	33.70	46.00	12.3	100	22	
Vert.	897.013	QP	35.30	22.10	11.06	31.11	0.00	37.35	46.00	8.6	100	1	
Vert.	909.302	QP	34.80	22.06	11.10	31.01	0.00	36.95	46.00	9.0	100	356	
Vert.	2483.500	PK	47.40	27.65	14.88	41.62	2.26	50.57	73.90	23.3	100	289	
Vert.	4960.000	PK	54.60	31.54	7.46	42.91	2.26	52.95	73.90	20.9	111	44	
Vert.	7440.000	PK	48.00	37.10	9.38	43.38	2.26	53.36	73.90	20.5	100	0	
Vert.	9920.000	PK	47.70	38.97	10.51	42.84	2.26	56.60	73.90	17.3	100	0	
Vert.	2483.500	AV	35.60	27.65	14.88	41.62	2.26	38.77	53.90	15.1	100	289	VBW: 360 Hz
Vert.	4960.000	AV	46.50	31.54	7.46	42.91	2.26	44.85	53.90	9.0	111	44	VBW: 360 Hz
Vert.	7440.000	AV	36.50	37.10	9.38	43.38	2.26	41.86	53.90	12.0	100	0	VBW: 360 Hz
Vert.	9920.000	AV	36.20	38.97	10.51	42.84	2.26	45.10	53.90	8.8	100	0	VBW: 360 Hz

Result = Reading + Ant.Fac. + Loss (Cable+(Attenuator or Filter)(below 18 GHz)) - Gain(Amplifier) + Distance factor

Distance factor : 1 GHz - 13 GHz : $20\log(3.89\text{ m} / 3.0\text{ m}) = 2.26\text{ dB}$

13 GHz - 40 GHz : $20\log(1.0\text{ m} / 3.0\text{ m}) = -9.54\text{ dB}$

* These results have sufficient margin without taking account Duty cycle correction factor.

UL Japan, Inc.

Shonan EMC Lab.

1-22-3 Megumigaoka, Hiratsuka-shi, Kanagawa-ken, 259-1220 JAPAN

Telephone : +81 463 50 6400

Facsimile : +81 463 50 6401

Radiated Spurious Emission
(Reference Plot for band-edge)

Report No. 12656071S-H
Test place Shonan EMC Lab.
Semi Anechoic Chamber No.3
Date February 27, 2019
Temperature / Humidity 24 deg. C / 39 % RH
Engineer Kenichi Adachi
(1 GHz -13 GHz)
Mode Tx, Hopping Off, 3DH5 2480 MHz

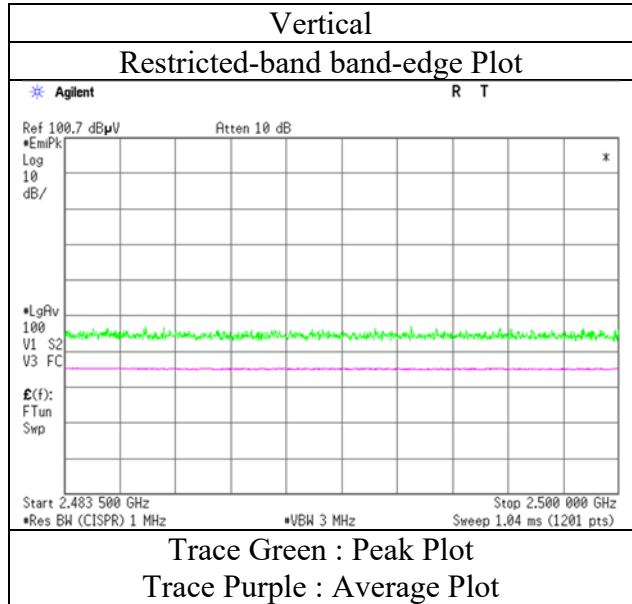
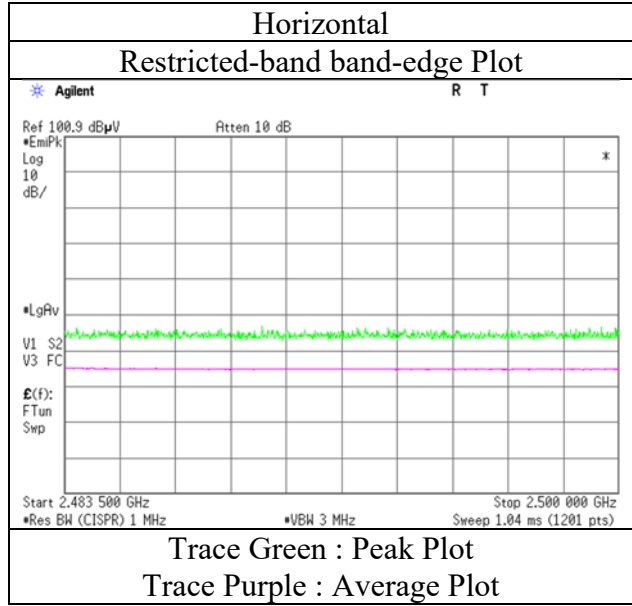

* The measurement was conducted for a sufficiently long enough time to detect any possible spurious emissions. Final result of restricted band edge was shown in tabular data.

Radiated Spurious Emission
(Plot data, Worst case)

Report No. 12656071S-H
Test place Shonan EMC Lab.
Semi Anechoic Chamber Refer to previous sheet
Date Refer to previous sheet
Temperature / Humidity Refer to previous sheet
Engineer Refer to previous sheet
Mode Tx, Hopping Off, 3DH5 2480 MHz

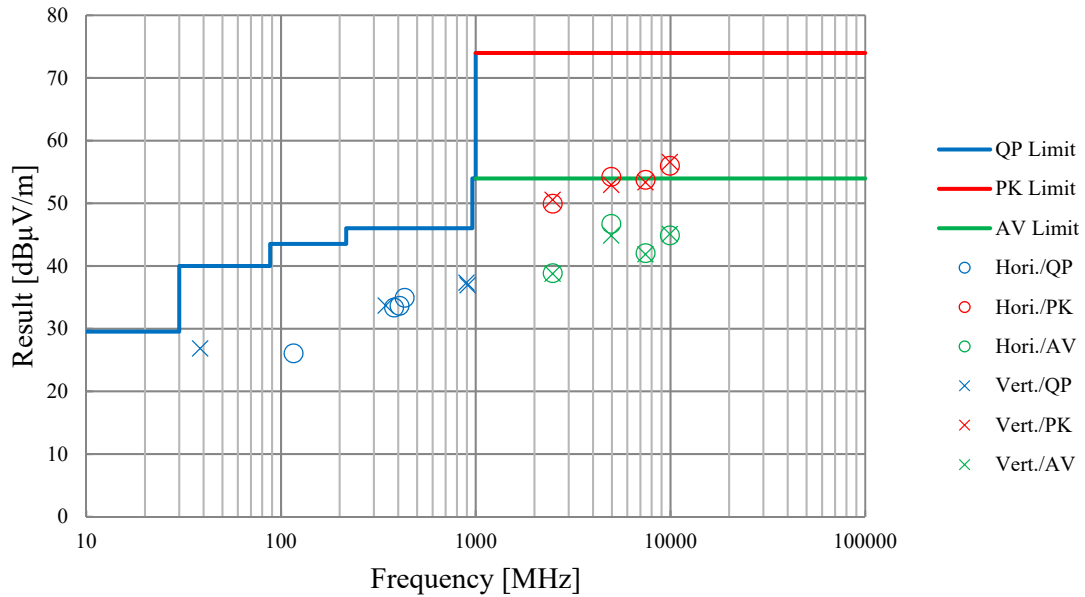

*These plots data contains sufficient number to show the trend of characteristic features for EUT.

Conducted Spurious Emission

Report No. 12656071S-H
 Test place Shonan EMC Lab. No.1 Measurement Room
 Date March 12, 2019
 Temperature / Humidity 23 deg. C / 59 % RH
 Engineer Kenichi Adachi
 Mode Tx, Hopping Off, DH5

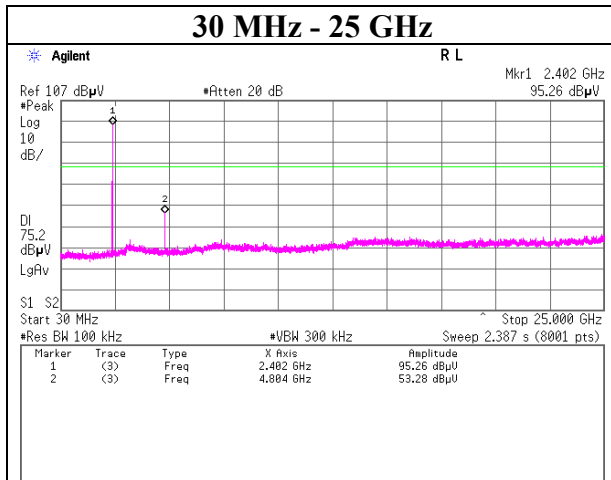
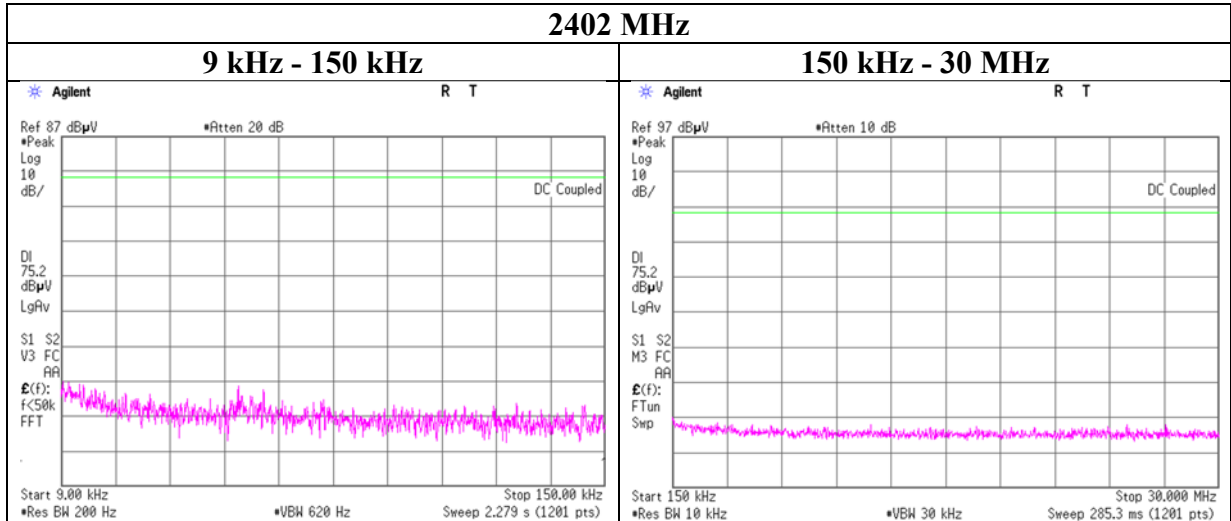

Conducted Spurious Emission

Report No.	12656071S-H
Test place	Shonan EMC Lab. No.1 Measurement Room
Date	March 12, 2019
Temperature / Humidity	23 deg. C / 59 % RH
Engineer	Kenichi Adachi
Mode	Tx, Hopping Off, DH5

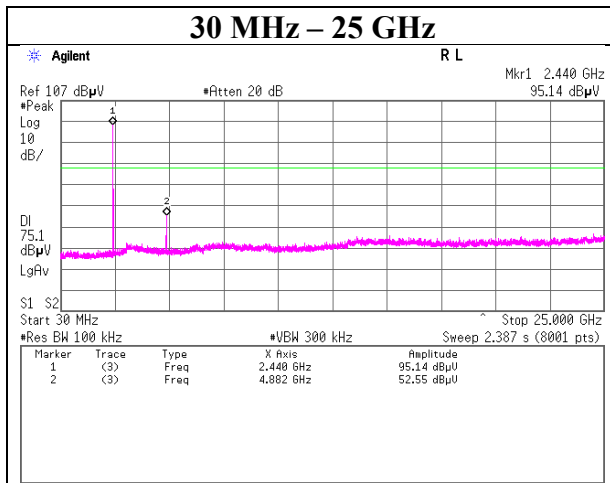
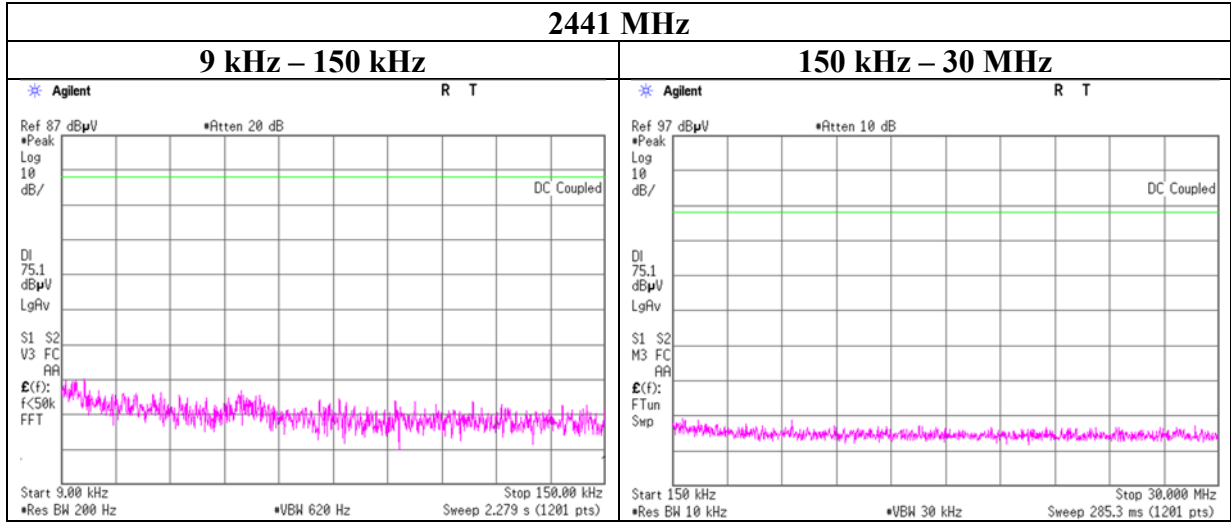

Conducted Spurious Emission

Report No.	12656071S-H
Test place	Shonan EMC Lab. No.1 Measurement Room
Date	March 12, 2019
Temperature / Humidity	23 deg. C / 59 % RH
Engineer	Kenichi Adachi
Mode	Tx, Hopping Off, DH5

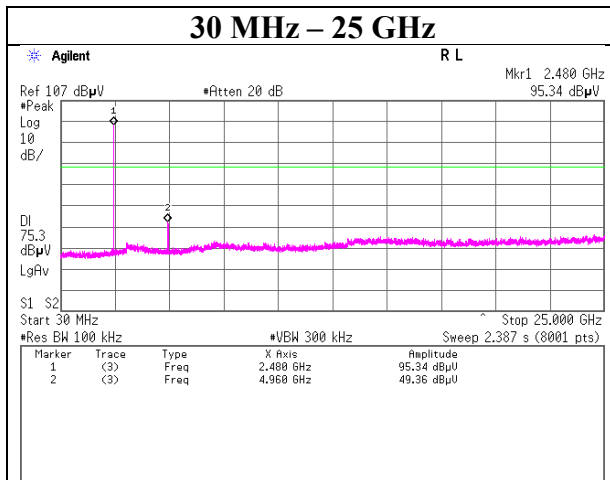
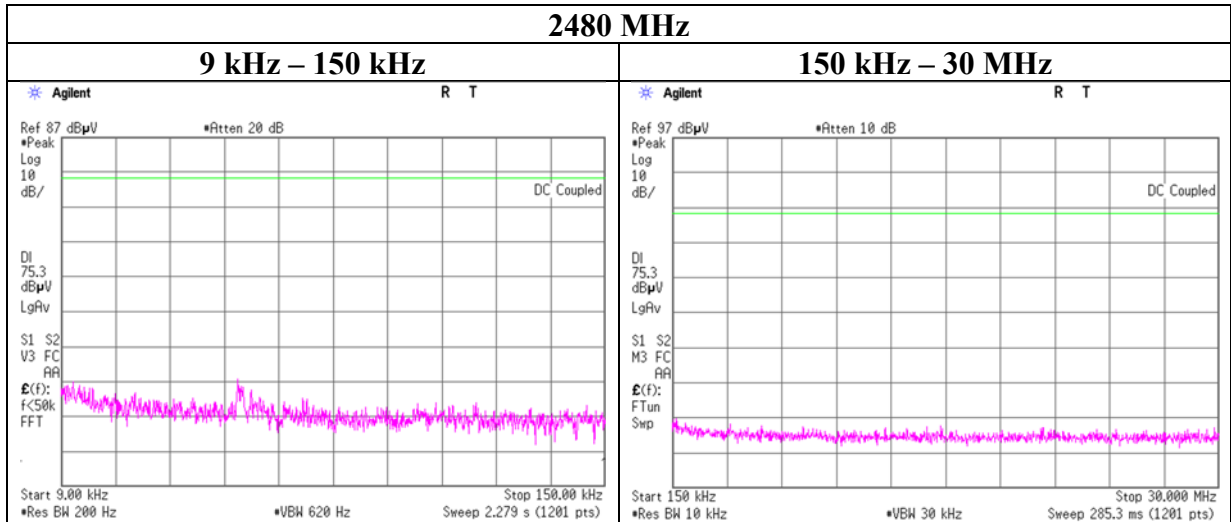

Conducted Spurious Emission

Report No.	12656071S-H
Test place	Shonan EMC Lab. No.1 Measurement Room
Date	March 12, 2019
Temperature / Humidity	23 deg. C / 59 % RH
Engineer	Kenichi Adachi
Mode	Tx, Hopping Off, 3DH5

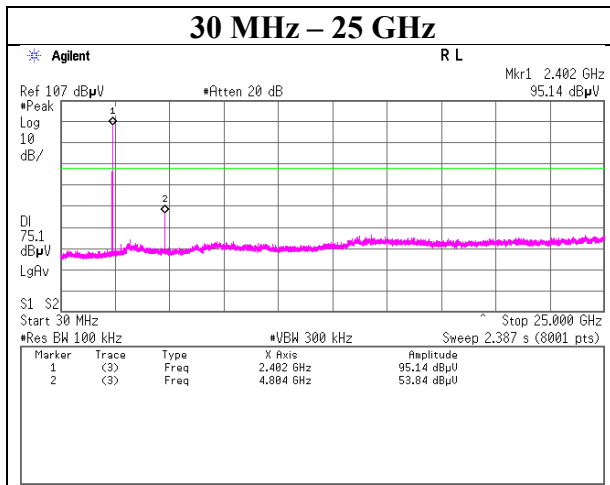
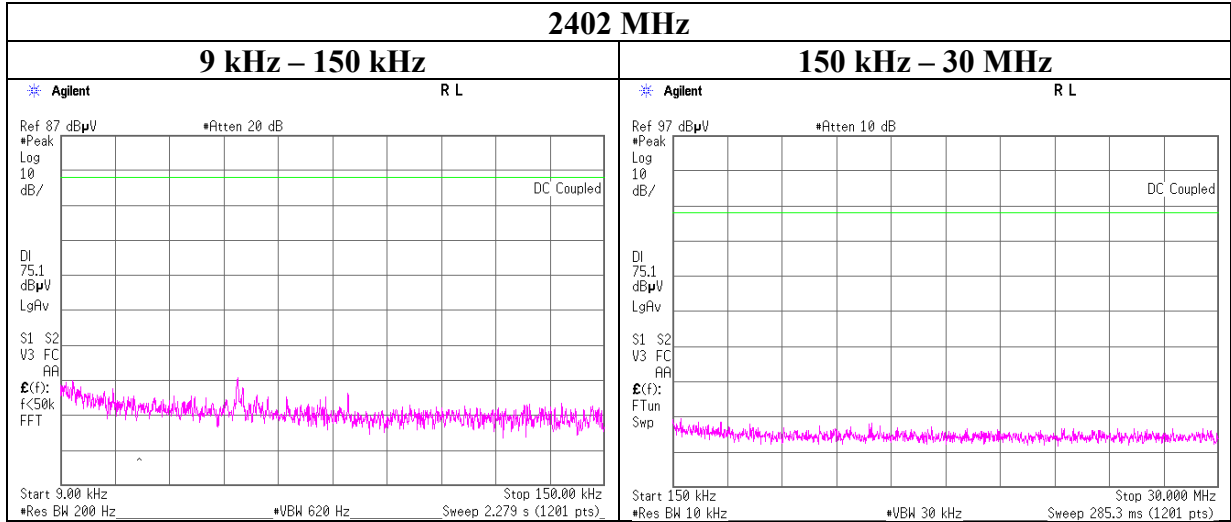

Conducted Spurious Emission

Report No.	12656071S-H
Test place	Shonan EMC Lab. No.1 Measurement Room
Date	March 12, 2019
Temperature / Humidity	23 deg. C / 59 % RH
Engineer	Kenichi Adachi
Mode	Tx, Hopping Off, 3DH5

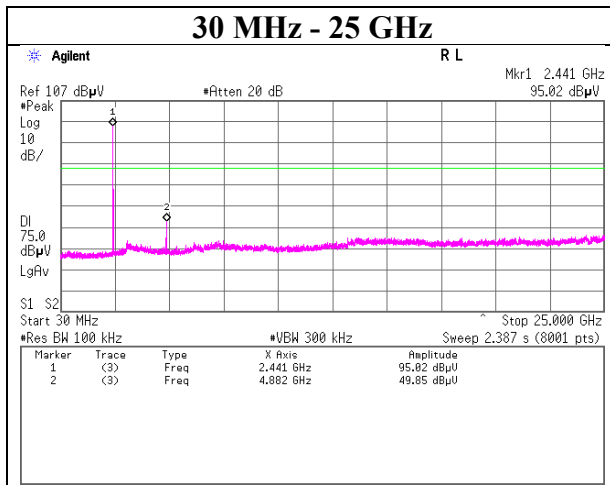
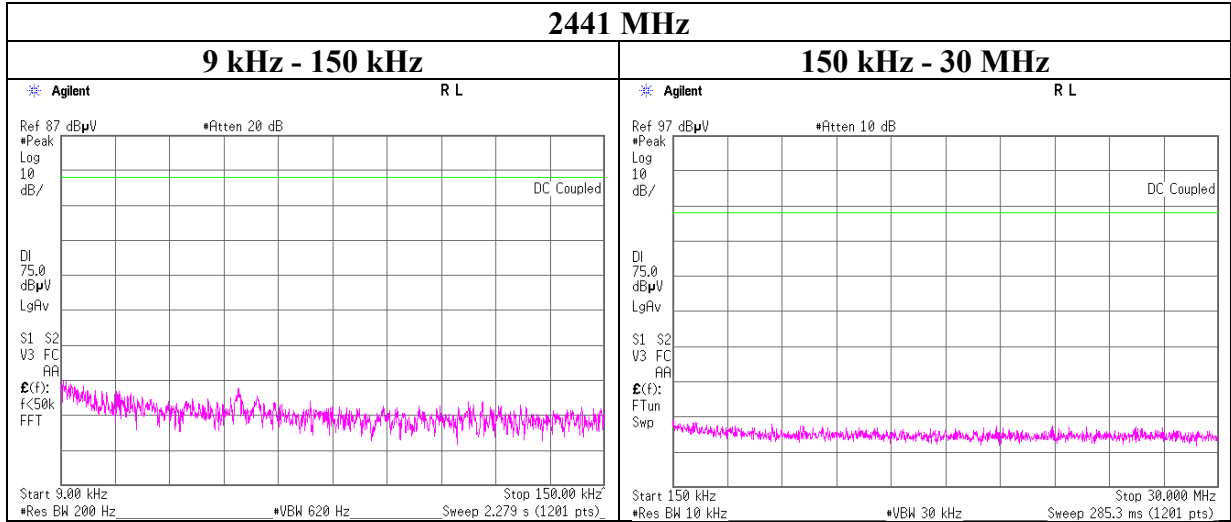

Conducted Spurious Emission

Report No.	12656071S-H
Test place	Shonan EMC Lab. No.1 Measurement Room
Date	March 12, 2019
Temperature / Humidity	23 deg. C / 59 % RH
Engineer	Kenichi Adachi
Mode	Tx, Hopping Off, 3DH5

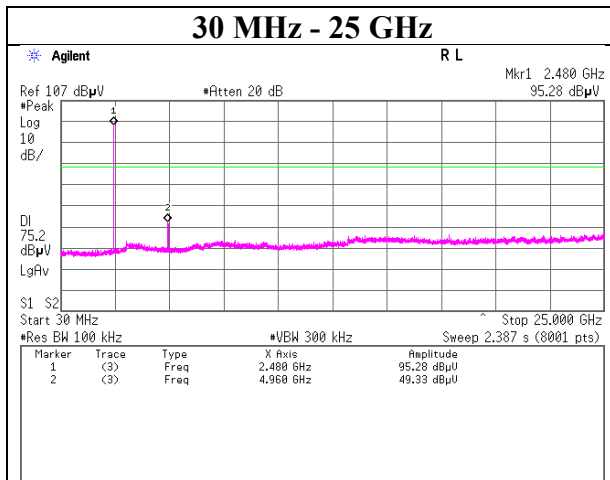
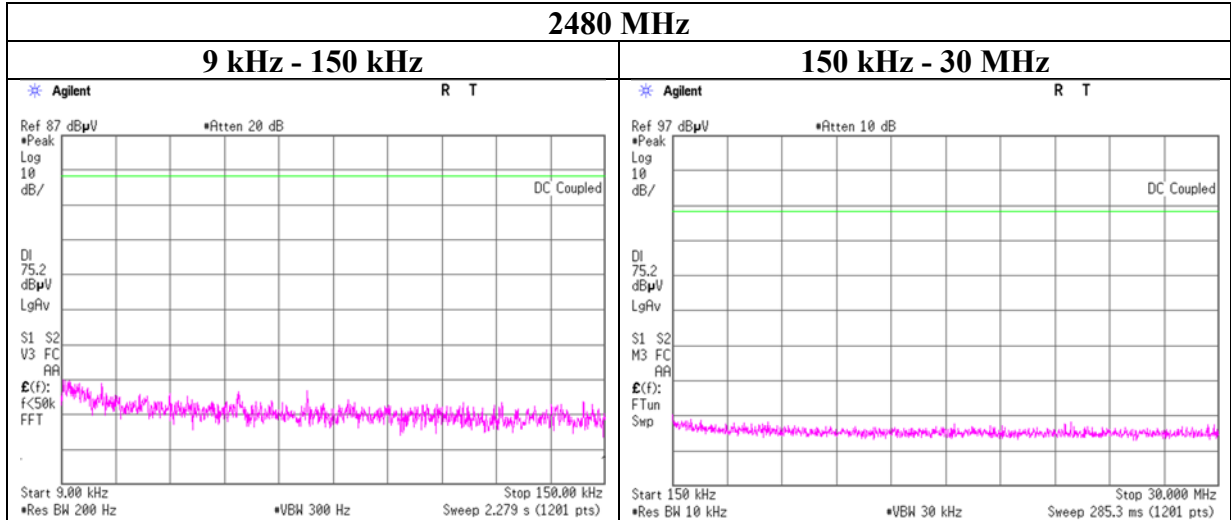

Conducted Emission Band Edge compliance

Report No.	12656071S-H
Test place	Shonan EMC Lab. No.1 Measurement Room
Date	March 12, 2019
Temperature / Humidity	23 deg. C / 59 % RH
Engineer	Kenichi Adachi
Mode	Tx DH5

Hopping On

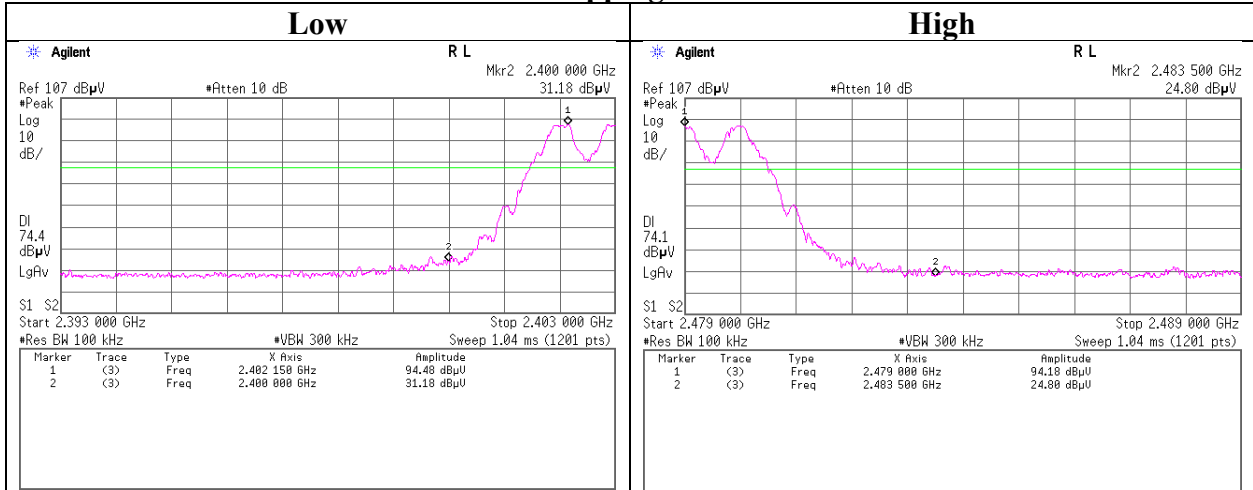

Hopping Off

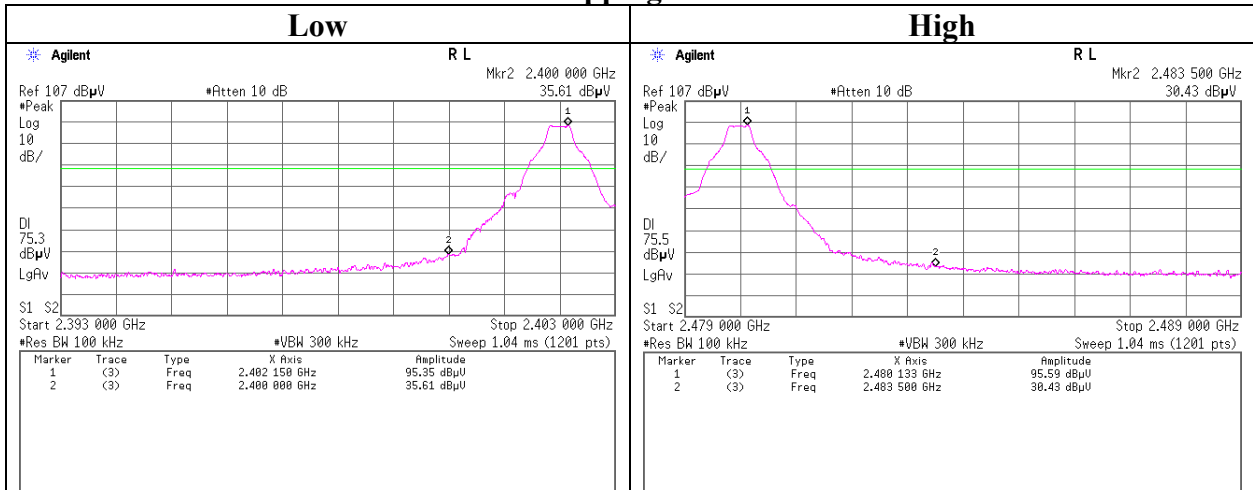

UL Japan, Inc.

Shonan EMC Lab.

1-22-3 Megumigaoka, Hiratsuka-shi, Kanagawa-ken, 259-1220 JAPAN

Telephone : +81 463 50 6400

Facsimile : +81 463 50 6401

Conducted Emission Band Edge compliance

Report No. 12656071S-H
 Test place Shonan EMC Lab. No.1 Measurement Room
 Date March 12, 2019
 Temperature / Humidity 23 deg. C / 59 % RH
 Engineer Kenichi Adachi
 Mode Tx 3DH5

Hopping On

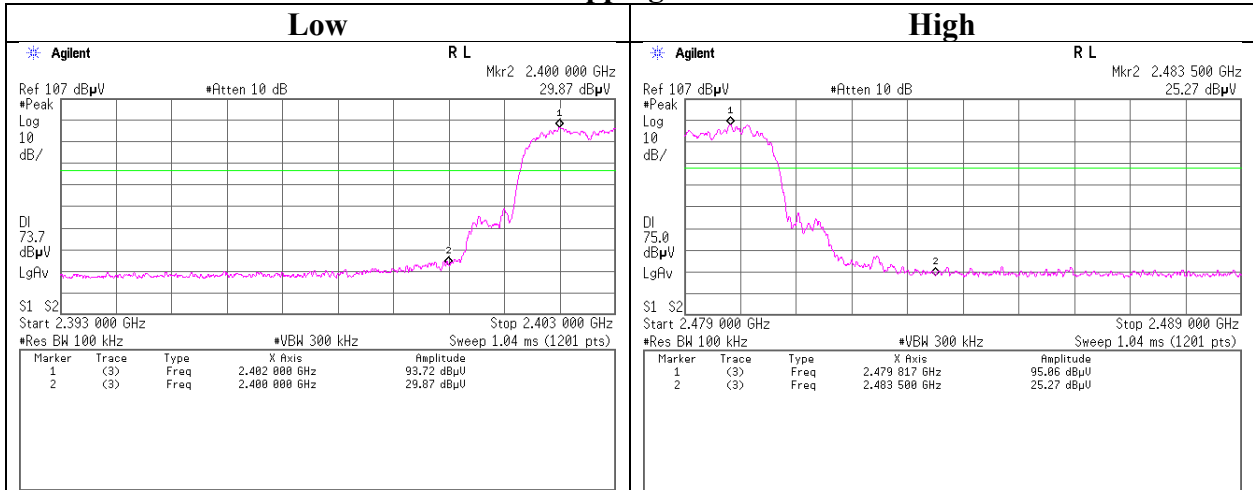

Hopping Off

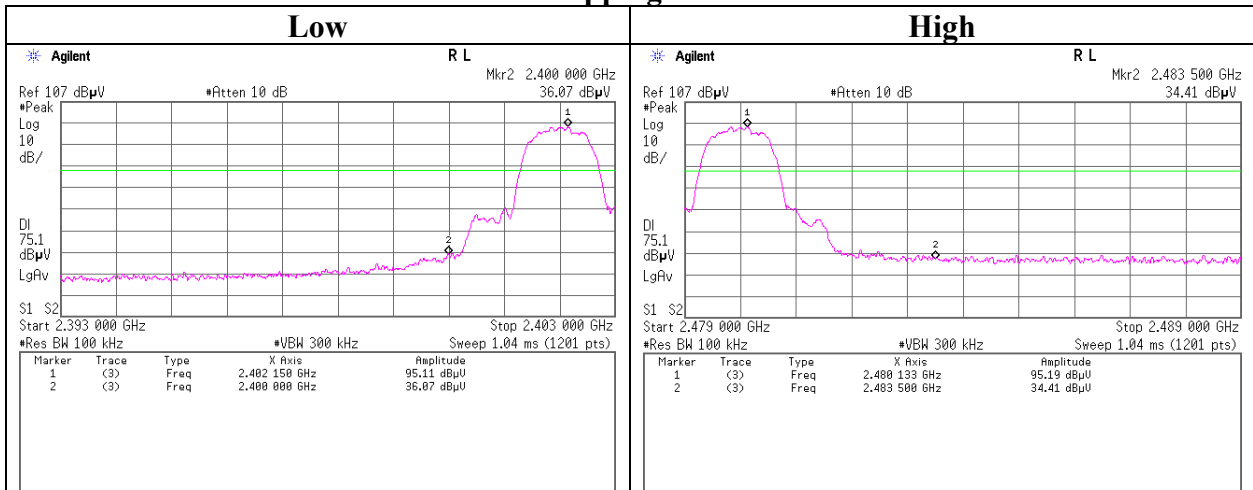

UL Japan, Inc.

Shonan EMC Lab.

1-22-3 Megumigaoka, Hiratsuka-shi, Kanagawa-ken, 259-1220 JAPAN

Telephone : +81 463 50 6400

Facsimile : +81 463 50 6401

APPENDIX 2: Test instruments

Test Instruments

Local ID	Test Name	LIMS ID	Description	Manufacturer	Model	Serial	Last Calibration Date	Calibration Due Date	Calibration Interval (Month)
SAT10-15	AT	160493	Attenuator	Weinschel Corp.	54A-10	83406	2018/12/6	2019/12/30	12
SCC-G13	AT	145166	Coaxial Cable	Suhner	SUCOFLEX 102	31599/2	2018/12/25	2019/12/31	12
SOS-13	AT	146321	Humidity Indicator	CUSTOM	CTH-202	Q.C.17	2018/12/5	2019/12/31	12
SPM-07	AT	146247	Power Meter	AGILENT	8990B	MY5100272	2018/7/13	2019/7/31	12
SPSS-04	AT	146310	Power sensor	AGILENT	N1923A	MY5326009	2018/7/13	2019/7/31	12
SSA-03	AT	145801	Spectrum Analyzer	AGILENT	E4448A	MY48250152	2018/8/30	2019/8/31	12
STM-G7	AT	171614	Terminator	WEINSCHEL	M1459A	88995	2018/7/10	2019/7/31	12
SCC-C9/C10/SRSE-03	CE	145036	Coaxial Cable&RF Selector	Suhner/Suhner/TOYO	RG223U/141PE/NS4906	-/0901-271(RF Selector)	2018/4/9	2019/4/30	12
SOS-06	CE	146294	Humidity Indicator	A&D	AD-5681	4062118	2018/12/5	2019/12/31	12
SLS-05	CE (AE)	145542	LISN	Rohde & Schwarz	ENV216	100516	2019/2/19	2020/2/29	12
STM-08	CE (AE)	146190	Terminator	TME	CT-01 BP	-	2018/12/25	2019/12/31	12
SAT3-13	CE (EUT)	150923	Attenuator	JFW	50HF-003N	-	2019/1/25	2020/1/31	12
SLS-02	CE (EUT)	145539	LISN	Rohde & Schwarz	ENV216	100512	2019/2/20	2020/2/29	12
SAEC-03(NSA)	RE	145565	Semi-Anechoic Chamber	TDK	SAEC-03(NSA)	3	2018/6/2	2019/6/30	12
SAEC-03(SVSWR)	RE	145566	Semi-Anechoic Chamber	TDK	SAEC-03(SVSWR)	3	2018/7/17	2019/7/31	12
SAF-03	RE	145126	Pre Amplifier	SONOMA	310N	290213	2019/2/5	2020/2/29	12
SAF-06	RE	145005	Pre Amplifier	Toyo Corporation	TPA0118-36	1440491	2019/2/8	2020/2/29	12
SAJ-02	RE	146104	Antenna Tilt Jig	Intelligent System Engineering Co., Ltd	Antenna Tilt Jig	T-S002	-	-	-
SAJ-03	RE	146105	Antenna Tilt Jig	Intelligent System Engineering Co., Ltd	Antenna Tilt Jig	T-S003	-	-	-
SAT10-05	RE	145136	Attenuator(above1G Hz)	AGILENT	8493C-010	74864	2018/11/25	2019/11/30	12
SAT6-13	RE	167094	Attenuator	JFW	50HF-006N	-	2019/2/5	2020/2/29	12
SBA-03	RE	145023	Biconical Antenna	Schwarzbeck	BBA9106	91032666	2018/6/17	2019/6/30	12
SCC-C1/C2/C3/C4/C5/C10/SRSE-03	RE	145171	Coaxial Cable&RF Selector	Fujikura/Fujikura/Suhner/Suhner/Suhner/TOYO	8D2W/12DSFA/141PE/141PE/141PE/141P	-/0901-271(RF Selector)	2018/4/9	2019/4/30	12
SCC-G05	RE	145039	Coaxial Cable	Junkosha	J12J102207-00	APR-30-15-037	2019/1/25	2020/1/31	12
SCC-G15	RE	145176	Coaxial Cable	Suhner	SUCOFLEX 102	32703/2	2018/3/19	2019/3/31	12
SCC-G22	RE	145180	Coaxial Cable	Suhner	SUCOFLEX 104	296199/4	2018/5/11	2019/5/31	12
SCC-G33	RE	145184	Coaxial Cable	Junkosha	MWX241-01000KMSKMS	-	2018/4/20	2019/4/30	12
SCC-G41	RE	151617	Coaxial Cable	Junkosha	MWX221-01000NFSNMS/B	1612S006	2019/1/25	2020/1/31	12
SFL-02	RE	145301	Highpass Filter	MICRO-TRONICS	HPM50111	51	2018/11/16	2019/11/30	12
SHA-03	RE	145501	Horn Antenna	Schwarzbeck	BBHA9120D	9120D-739	2018/7/23	2019/7/31	12
SHA-04	RE	145512	Horn Antenna	ETS LINDGREN	Sep-60	LM3640	2018/7/23	2019/7/31	12
SLA-07	RE	145529	Logperiodic Antenna	Schwarzbeck	VUSLP9111B	196	2018/6/17	2019/6/30	12
SOS-05	RE	146293	Humidity Indicator	A&D	AD-5681	4062518	2018/10/25	2019/10/31	12
STR-08	RE, CE	150463	Test Receiver	Rohde & Schwarz	ESW44	101581	2018/11/28	2019/11/30	12
COTS-SEMI-5	RE, CE	170932	EMI Software	TSJ	TEPTO-DV3(RE, CE, ME, PE)	-	-	-	-
KJM-02	RE, CE	146432	Measure	TAJIMA	GL19-55	-	-	-	-
STS-03	RE, CE	146210	Digital Hitester	HIOKI	3805-50	80997823	2018/10/16	2019/10/31	12

*Hyphens for Last Calibration Date, Calibration Due Date and Cal Int (month) are instruments that Calibration is not required (e.g. software), or instruments checked in advance before use.

The expiration date of the calibration is the end of the expired month.

All equipment is calibrated with valid calibrations. Each measurement data is traceable to the national or international standards.

As for some calibrations performed after the tested dates, those test equipment have been controlled by means of an unbroken chains of calibrations.

Test item: CE: Conducted Emission test
RE: Radiated Emission test
AT: Antenna Terminal Conducted test

UL Japan, Inc.

Shonan EMC Lab.

1-22-3 Megumigaoka, Hiratsuka-shi, Kanagawa-ken, 259-1220 JAPAN

Telephone : +81 463 50 6400

Facsimile : +81 463 50 6401