



RADIO TEST REPORT

Test Report No. : 12656071S-F

Applicant : Nintendo Co., Ltd.
Type of Equipment : Game Console
Model No. : HDH-001
FCC ID : BKEHDH001
Test regulation : **FCC Part 15 Subpart C: 2019**
* Wireless LAN (2.4 GHz bands) and Bluetooth low energy part
Test Result : **Complied (Refer to SECTION 3.2)**

1. This test report shall not be reproduced in full or partial, without the written approval of UL Japan, Inc.
2. The results in this report apply only to the sample tested.
3. This sample tested is in compliance with the limits of the above regulation.
4. The test results in this test report are traceable to the national or international standards.
5. This test report must not be used by the customer to claim product certification, approval, or endorsement by any agency of the Federal Government.
6. This test report covers Radio technical requirements.
It does not cover administrative issues such as Manual or non-Radio test related Requirements. (if applicable)
7. The all test items in this test report are conducted by UL Japan, Inc. Shonan EMC Lab.
8. The opinions and the interpretations to the result of the description in this report are outside scopes where UL Japan has been accredited.
9. The information provided from the customer for this report is identified in SECTION 1.

Date of test: January 7 to March 11, 2019

Representative test engineer: *K. Takeyama*
Kazutaka Takeyama
Engineer
Consumer Technology Division

Approved by : *A. Hayashi*
Akio Hayashi
Leader
Consumer Technology Division



- The testing in which "Non-accreditation" is displayed is outside the accreditation scopes in UL Japan.
 There is no testing item of "Non-accreditation".

UL Japan, Inc.
Shonan EMC Lab.

1-22-3 Megumigaoka, Hiratsuka-shi, Kanagawa-ken, 259-1220 JAPAN
Telephone : +81 463 50 6400
Facsimile : +81 463 50 6401

CONTENTS	PAGE
SECTION 1: Customer information.....	4
SECTION 2: Equipment under test (E.U.T.).....	4
SECTION 3: Test specification, procedures & results.....	6
SECTION 4: Operation of E.U.T. during testing.....	9
SECTION 5: Conducted Emission.....	13
SECTION 6: Radiated Spurious Emission	14
SECTION 7: Antenna Terminal Conducted Tests.....	18
APPENDIX 1: Test data	19
Conducted Emission	19
-6 dB Bandwidth	23
99 % Occupied Bandwidth.....	49
Maximum Peak Conducted Output Power.....	75
Maximum Conducted Output Power (Reference data).....	101
Burst rate confirmation	127
Radiated Emission.....	140
Spurious Emission (Conducted).....	196
Power Density	200
APPENDIX 2: Test instruments	236
APPENDIX 3: Photographs of test setup	238
Conducted Emission	238
Radiated Spurious Emission	239
Pre-check of Worst Case Position.....	240

SECTION 1: Customer information

Company Name : Nintendo Co., Ltd.
Address : 11-1 Hokotate-cho, Kamitoba, Minami-ku, Kyoto 601-8501, Japan
Telephone Number : +81-75-662-9600
Facsimile Number : +81-75-662-9624
Contact Person : Kazuya Kuramoto

The information provided from the customer is as follows;

- Applicant, Type of Equipment, Model No., FCC ID on the cover and other relevant pages
- Operating/Test Mode(s) (Mode(s)) on all the relevant pages
- SECTION 1: Customer information
- SECTION 2: Equipment under test (E.U.T.)
- SECTION 4: Operation of E.U.T. during testing

* The laboratory is exempted from liability of any test results affected from the above information in SECTION 2 and 4.

SECTION 2: Equipment under test (E.U.T.)

2.1 Identification of E.U.T.

Type of Equipment : Game Console
Model No. : HDH-001
Serial No. : Refer to Section 4.2
Rating : DC 3.8 V (battery),
AC Adapter input: AC 100 V - 240 V, 50 Hz / 60 Hz, 1 A,
AC Adapter output: DC 5 V - DC 15 V, 2.6 A
Receipt Date of Sample : December 27, 2018
(Information from test lab.)
Country of Mass-production : China
Condition of EUT : Engineering prototype
(Not for Sale: This sample is equivalent to mass-produced items.)
Modification of EUT : No Modification by the test lab.

2.2 Product Description

Model: HDH-001 (referred to as the EUT in this report) is a Game Console.

Radio Specification

Wireless LAN, Bluetooth part:

Equipment type	:	Transmitter
Frequency of operation	:	Wireless LAN part: (2.4 GHz): 2412 MHz - 2472 MHz, (U-NII-1): 5180 MHz - 5240 MHz, (U-NII-2A): 5260 MHz - 5320 MHz, (U-NII-2C): 5500 MHz - 5700 MHz, (U-NII-3): 5745 MHz - 5825 MHz, Bluetooth (BDR/EDR/BTLE) part: 2402 MHz - 2480 MHz
Radio part clock frequency	:	37.4 MHz
Channel spacing	:	Wireless LAN part: (2.4 GHz): 5 MHz, (5 GHz): 20 MHz, Bluetooth part: (BDR/EDR): 1 MHz, (BT LE): 2 MHz
Type of modulation	:	Wireless LAN part: 2.4 GHz bands: DBPSK, DQPSK, CCK, OFDM, 5 GHz bands: OFDM Bluetooth (BT) part: BDR (Basic Data Rate): GFSK, EDR (Enhanced Data Rate): $\pi/4$ -DQPSK, 8DPSK, BT LE (Low Energy mode): GFSK
Antenna type	:	Sheet metal antenna
Antenna connector type	:	(Ant: 0): MHF2, (Ant: 1): MHF2
Antenna gain	:	2.4 GHz bands: (Ant: 0): -0.904 dBi, (Ant: 1): -0.730 dBi 5 GHz bands: (Ant: 0): 2.949 dBi, (Ant: 1): 1.994 dBi
Power Supply (radio part input)	:	DC 1.8 V, DC 3.3 V
Operation temperature range	:	+5 deg.C to +35 deg.C

Remarks: This wireless module consists of 1 chip each of 5 GHz bands and 2.4 GHz bands.

NFC part:

Equipment type	:	Transmitter
Frequency of operation	:	13.56 MHz
Radio part clock frequency	:	27.12 MHz
Type of modulation	:	ASK
Power Supply (radio part input)	:	DC 1.8 V, DC 5.0 V
Antenna type	:	Ferrite Chip Antenna
Operation temperature range	:	+5 deg.C to +35 deg.C

SECTION 3: Test specification, procedures & results

3.1 Test Specification

Test Specification : FCC Part 15 Subpart C
FCC Part 15 final revised on June 4, 2019 and effective July 5, 2019 except 15.258

Title : FCC 47CFR Part15 Radio Frequency Device Subpart C Intentional Radiators
Section 15.207 Conducted limits
Section 15.247 Operation within the bands 902-928MHz,
2400-2483.5MHz, and 5725-5850MHz

* The revision on June 4, 2019, does not affect the test specification applied to the EUT.

* Also the EUT complies with FCC Part 15 Subpart B.

3.2 Procedures and results

Item	Test Procedure	Specification	Worst margin	Results	Remarks
Conducted Emission	FCC: ANSI C63.10-2013 6. Standard test methods ----- IC: RSS-Gen 8.8	FCC: Section 15.207 ----- IC: RSS-Gen 8.8	12.0 dB Freq.: 0.48833 MHz Detector: AV Phase: L1 Mode: Tx, OFDM VHT20(MIMO), 2437 MHz	Complied a)	-
6 dB Bandwidth	FCC: KDB 558074 D01 15.247 Meas Guidance v05r01 ----- IC: -	FCC: Section 15.247(a)(2) ----- IC: RSS-247 5.2(a)	See data.	Complied b)	Conducted
Maximum Peak Output Power	FCC: KDB 558074 D01 15.247 Meas Guidance v05r01 ----- IC: RSS-Gen 6.12	FCC: Section 15.247(b)(3) ----- IC: RSS-247 5.4(d)		Complied c)	Conducted
Power Density	FCC: KDB 558074 D01 15.247 Meas Guidance v05r01 ----- IC: -	FCC: Section 15.247(e) ----- IC: RSS-247 5.2(b)		Complied d)	Conducted
Spurious Emission Restricted Band Edges	FCC: KDB 558074 D01 15.247 Meas Guidance v05r01 ----- IC: RSS-Gen 6.13	FCC: Section15.247(d) ----- IC: RSS-247 5.5 RSS-Gen 8.9 RSS-Gen 8.10		1.8 dB Freq.: 9608 MHz Detector: AV Polarization: Vertical Mode: Tx, BT LE 2402 MHz	Complied# e), f)

Note: UL Japan, Inc.'s EMI Work Procedures No. 13-EM-W0420 and 13-EM-W0422.

*1) Radiated test was selected over 30 MHz based on section 15.247(d) and KDB 558074 D01 15.247 Meas Guidance v05r01 8.5 and 8.6. (Measurement was performed before issue of KDB 558074 v05r02.)

- a) Refer to APPENDIX 1 (data of Conducted Emission)
- b) Refer to APPENDIX 1 (data of -6 dB Bandwidth and 99 % Occupied Bandwidth)
- c) Refer to APPENDIX 1 (data of Maximum Peak Conducted Output Power)
- d) Refer to APPENDIX 1 (data of Power Density)
- e) Refer to APPENDIX 1 (data of Spurious Emission (Conducted))
- f) Refer to APPENDIX 1 (data of Radiated Emission)

Symbols:

Complied The data of this test item has enough margin, more than the measurement uncertainty.

Complied# The data of this test item meets the limits unless the measurement uncertainty is taken into consideration.

* In case any questions arise about test procedure, ANSI C63.10: 2013 is also referred.

UL Japan, Inc.

Shonan EMC Lab.

1-22-3 Megumigaoka, Hiratsuka-shi, Kanagawa-ken, 259-1220 JAPAN

Telephone : +81 463 50 6400

Facsimile : +81 463 50 6401

FCC Part 15.31 (e)

This EUT provides the stable voltage constantly to RF Module regardless of input voltage. Therefore, this EUT complies with the requirement.

FCC Part 15.203 Antenna requirement

It is impossible for end users to replace the antenna, because the antenna is mounted inside of the EUT. Therefore, the equipment complies with the antenna requirement of Section 15.203.

3.3 Addition to standard

Item	Test Procedure	Specification	Worst margin	Results	Remarks
99 % Occupied Bandwidth	RSS-Gen 6.7	IC: -	N/A	- a)	Conducted
a) Refer to APPENDIX 1 (data of 6 dB Bandwidth and 99 % Occupied Bandwidth)					

Other than above, no addition, exclusion nor deviation has been made from the standard.

3.4 Uncertainty

There is no applicable rule of uncertainty in this applied standard. Therefore, the results are derived depending on whether or not laboratory uncertainty is applied.

The following uncertainties have been calculated to provide a confidence level of 95 % using a coverage factor $k=2$.

Shonan EMC Lab.

Item	Frequency range	Uncertainty (+/-)				
		No. 1 SAC / SR	No. 2 SAC / SR	No. 3 SAC / SR	No. 4 SAC / SR	No. 5,6,8 SR
Conducted emission (AC Mains) LISN	150 kHz-30 MHz	2.9 dB	2.8 dB	2.9 dB	2.9 dB	2.9 dB
Radiated emission (Measurement distance: 3 m)	9 kHz-30 MHz	3.0 dB	3.0 dB	3.1 dB	-	-
	30 MHz-200 MHz	4.6 dB	4.6 dB	4.7 dB	-	-
	200 MHz-1 GHz	6.0 dB	6.0 dB	6.1 dB	-	-
	1 GHz-6 GHz	4.8 dB	4.8 dB	4.8 dB	-	-
	6 GHz-18 GHz	5.4 dB	5.4 dB	5.4 dB	-	-
Radiated emission (Measurement distance: 1 m)	18 GHz-40 GHz	5.6 dB	5.6 dB	5.6 dB	-	-
	1 GHz-18 GHz	5.7 dB	5.7 dB	5.7 dB	-	-
	18 GHz-40 GHz	5.9 dB	5.9 dB	5.9 dB	-	-

SAC=Semi-Anechoic Chamber

SR= Shielded Room is applied besides radiated emission

Antenna terminal test	Uncertainty (+/-)
Power Measurement above 1 GHz (Average Detector)_SPM-06	0.81 dB
Power Measurement above 1 GHz (Peak Detector)_SPM-06	1.53 dB
Power Measurement above 1 GHz (Average Detector)_SPM-07	0.95 dB
Power Measurement above 1 GHz (Peak Detector)_SPM-07	1.21 dB
Power Measurement above 1 GHz (Average Detector)_SPM-13	0.90 dB
Power Measurement above 1 GHz (Peak Detector)_SPM-13	1.04 dB
Spurious emission (Conducted) below 1GHz	1.8 dB
Spurious emission (Conducted) 1 GHz-3 GHz	1.7 dB
Spurious emission (Conducted) 3 GHz-18 GHz	2.3 dB
Spurious emission (Conducted) 18 GHz-26.5 GHz	2.4 dB
Spurious emission (Conducted) 26.5 GHz-40 GHz	2.4 dB
Bandwidth Measurement	0.61 %
Duty cycle and Time Measurement	0.012 %

UL Japan, Inc.

Shonan EMC Lab.

1-22-3 Megumigaoka, Hiratsuka-shi, Kanagawa-ken, 259-1220 JAPAN

Telephone : +81 463 50 6400

Facsimile : +81 463 50 6401

3.5 Test Location

UL Japan, Inc. Shonan EMC Lab.
1-22-3, Megumigaoka, Hiratsuka-shi, Kanagawa-ken 259-1220 JAPAN
Telephone: +81 463 50 6400, Facsimile: +81 463 50 6401
JAB Accreditation No. : RTL02610
FCC Test Firm Registration Number: 626366

Test site	IC Registration Number	Width x Depth x Height (m)	Size of reference ground plane (m) / horizontal conducting plane	Maximum measurement distance
No.1 Semi-anechoic chamber	2973D-1	20.6 x 11.3 x 7.65	20.6 x 11.3	10 m
No.2 Semi-anechoic chamber	2973D-2	20.6 x 11.3 x 7.65	20.6 x 11.3	10 m
No.3 Semi-anechoic chamber	2973D-3	12.7 x 7.7 x 5.35	12.7 x 7.7	5 m
No.4 Semi-anechoic chamber	-	8.1 x 5.1 x 3.55	8.1 x 5.1	-
No.1 Shielded room	-	6.8 x 4.1 x 2.7	6.8 x 4.1	-
No.2 Shielded room	-	6.8 x 4.1 x 2.7	6.8 x 4.1	-
No.3 Shielded room	-	6.3 x 4.7 x 2.7	6.3 x 4.7	-
No.4 Shielded room	-	4.4 x 4.7 x 2.7	4.4 x 4.7	-
No.5 Shielded room	-	7.8 x 6.4 x 2.7	7.8 x 6.4	-
No.6 Shielded room	-	7.8 x 6.4 x 2.7	7.8 x 6.4	-
No.8 shielded room	-	3.45 x 5.5 x 2.4	3.45 x 5.5	-
No.1 Measurement room	-	2.55 x 4.1 x 2.5	-	-

3.6 Test data, Test instruments, and Test set up

Refer to APPENDIX.

SECTION 4: Operation of E.U.T. during testing

4.1 Operating Mode(s)

Test operating mode was determined as follows according to “Section 1 of 6 802.11 a/b/g/n testing - Managing Complex Regulatory Approvals - ” of TCB Council Workshop October 2009 and also was judged the necessity of 802.11ac mode by the pre-test.

Mode	Remarks*
Transmitting (Tx), IEEE 802.11b	11 Mbps, PN9
Transmitting (Tx), IEEE 802.11g	48 Mbps, PN9
Transmitting (Tx), IEEE 802.11n HT20 (11n-20), SISO	MCS 4, PN9 (2412 MHz) MCS 3, PN9 (Other than 2412 MHz)
Transmitting (Tx), OFDM VHT20 (OFDM-20), SISO	MCS 4, PN9 (2412 MHz) MCS 3, PN9 (Other than 2412 MHz)
Transmitting (Tx), IEEE 802.11n HT40 (11n-40), SISO	MCS 6, PN9
Transmitting (Tx), OFDM VHT40 (OFDM-40), SISO	MCS 4, PN9
Transmitting (Tx), IEEE 802.11n HT20 (11n-20), MIMO	MCS 14, PN9
Transmitting (Tx), OFDM VHT20 (OFDM-20), MIMO	MCS 3, PN9
Transmitting (Tx), IEEE 802.11n HT40 (11n-40), MIMO	MCS 11, PN9
Transmitting (Tx), OFDM VHT40 (OFDM-40), MIMO	MCS 3, PN9
Transmitting (Tx), Bluetooth (BT) Low Energy (LE)	Maximum Packet Size, PRBS9
*The worst condition was determined based on the test result of Maximum Peak Output Power (Mid Channel)	
*Power of the EUT was set by the software as follows; Power settings: Fixed (refer to power setting (target power) table) Software: cmd.exe version 6.1.7601.23403 *This setting of software is the worst case. Any conditions under the normal use do not exceed the condition of setting. In addition, end users cannot change the settings of the output power of the product.	

*The details of Operating mode(s)

Test Item	Operating Mode	Tested Antenna	Tested frequency
Conducted Emission	Transmitting (Tx), Bluetooth (BT) Low Energy (LE)	0	2402 MHz 2440 MHz 2480 MHz
	Transmitting (Tx), OFDM VHT20 (OFDM-20), MIMO	0 & 1	2437 MHz
Spurious Emission	Transmitting (Tx), Bluetooth (BT) Low Energy (LE)	0	2402 MHz 2440 MHz 2480 MHz
	Transmitting (Tx), IEEE 802.11b	1	2412 MHz 2437 MHz 2462 MHz 2467 MHz 2472 MHz
	Transmitting (Tx), OFDM VHT20 (OFDM-20), SISO	1	2412 MHz 2417 MHz 2437 MHz
	Transmitting (Tx), OFDM VHT20 (OFDM-20), MIMO	0 & 1	2462 MHz 2467 MHz 2472 MHz
	Transmitting (Tx), IEEE 802.11n HT40 (11n-40), SISO	1	2422 MHz 2437 MHz
	Transmitting (Tx), IEEE 802.11n HT40 (11n-40), MIMO	0 & 1	2452 MHz 2457 MHz 2462 MHz
	Transmitting (Tx), Bluetooth (BT) Low Energy (LE)	0	2402 MHz 2440 MHz 2480 MHz
6dB Bandwidth Maximum Peak Output Power Power Density 99% Occupied Bandwidth	Transmitting (Tx), IEEE 802.11b,	1	2412 MHz 2437 MHz 2462 MHz 2467 MHz 2472 MHz
	Transmitting (Tx), IEEE 802.11g, Transmitting (Tx), IEEE 802.11n HT20 (11n-20), SISO, Transmitting (Tx), OFDM VHT20 (OFDM-20), SISO	1	2412 MHz 2417 MHz 2437 MHz 2462 MHz 2467 MHz
	Transmitting (Tx), IEEE 802.11n HT20 (11n-20), MIMO, Transmitting (Tx), OFDM VHT20 (OFDM-20), MIMO	0 & 1	2472 MHz
	Transmitting (Tx), IEEE 802.11n HT40 (11n-40), SISO Transmitting (Tx), OFDM VHT40 (OFDM-40), SISO	1	2422 MHz 2437 MHz 2452 MHz
	Transmitting (Tx), IEEE 802.11n HT40 (11n-40), MIMO Transmitting (Tx), OFDM VHT40 (OFDM-40), MIMO	0 & 1	2457 MHz 2462 MHz

UL Japan, Inc.

Shonan EMC Lab.

1-22-3 Megumigaoka, Hiratsuka-shi, Kanagawa-ken, 259-1220 JAPAN

Telephone : +81 463 50 6400

Facsimile : +81 463 50 6401

4.2 Configuration and peripherals

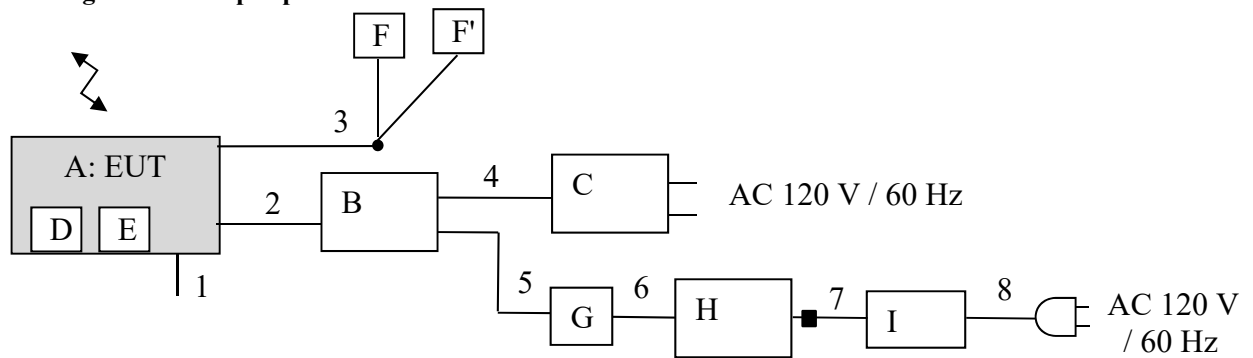

■ : Ferrite core

* Cabling and setup(s) were taken into consideration and test data was taken under worse case conditions.

Description of EUT and Support equipment

No.	Item	Model number	Serial number	Manufacturer	Remarks
A	Game Console	HDH-001	XJW01000021026 *1) XJW01000021040 *2)	Nintendo Co., Ltd.	EUT
B	SDEV Cradle	HAT-003	XZL0100007151	Nintendo Co., Ltd.	-
C	AC Adapter	HAC-002	-	Nintendo Co., Ltd.	-
D	Game Card	HAC-008	DFCAA22L000	Nintendo Co., Ltd.	-
E	Micro SD Card	-	-	Transcend	-
F, F'	Headphone	-	-	Nintendo Co., Ltd.	-
G	GIGA Ethernet Adapter	LAN-GTJU3	3495DB2BF5CA	Logitec	-
H	Laptop PC	CF-S10AWNDS	2BKSA58270	Panasonic	-
I	AC Adapter	CF-AA6402A M1	6402AM111Z03016A	Panasonic	-

*1) Used for Antenna Terminal conducted test

*2) Used for Conducted Emission test and Radiated Emission test

List of cables used

No.	Cable Name	Length (m)	Shield		Remarks
			Cable	Connector	
1	Signal	0.1	Unshielded	Unshielded	*3)
2	USB	0.4	Shielded	Shielded	-
3	Headphone	0.5 + 0.3	Unshielded	Unshielded	-
4	USB	1.8	Shielded	Shielded	-
5	USB	0.15	Shielded	Shielded	-
6	LAN	0.5	Unshielded	Unshielded	-
7	DC	1.8	Unshielded	Unshielded	-
8	AC	1.0	Unshielded	Unshielded	-

*3) This signal cable is used only for the settings of Bluetooth test mode, not used for the product.

UL Japan, Inc.

Shonan EMC Lab.

1-22-3 Megumigaoka, Hiratsuka-shi, Kanagawa-ken, 259-1220 JAPAN

Telephone : +81 463 50 6400

Facsimile : +81 463 50 6401

SECTION 5: Conducted Emission

Test Procedure and conditions

EUT was placed on a platform of nominal size, 1.0 m by 2.0 m, raised 0.8 m above the conducting ground plane. The table is made of expanded polystyrol and expanded polypropylene and the table top is covered with polycarbonate. That has very low permittivity.

The rear of tabletop was located 40 cm to the vertical conducting plane. The rear of EUT, including peripherals aligned and flushed with rear of tabletop. All other surfaces of tabletop were at least 80cm from any other grounded conducting surface. EUT was located 80 cm from a Line Impedance Stabilization Network (LISN) / Artificial mains Network (AMN) and excess AC cable was bundled in center.

I/O cables that were connected to the peripherals were bundled in center. They were folded back and forth forming a bundle 30 cm to 40 cm long and were hanged at a 40 cm height to the ground plane. All unused 50ohm connectors of the LISN (AMN) were resistivity terminated in 50 ohm when not connected to the measuring equipment.

The AC Mains Terminal Continuous disturbance Voltage has been measured with the EUT via AC adapter in Shielded room.

The EUT via AC adapter was connected to a LISN (AMN).

An overview sweep with peak detection has been performed.

The test results and limit are rounded off to one decimal place, so some differences might be observed.

Detector : QP and CISPR AV
Measurement range : 0.15 MHz - 30 MHz
Test data : APPENDIX
Test result : Pass

Figure 1: Test Setup

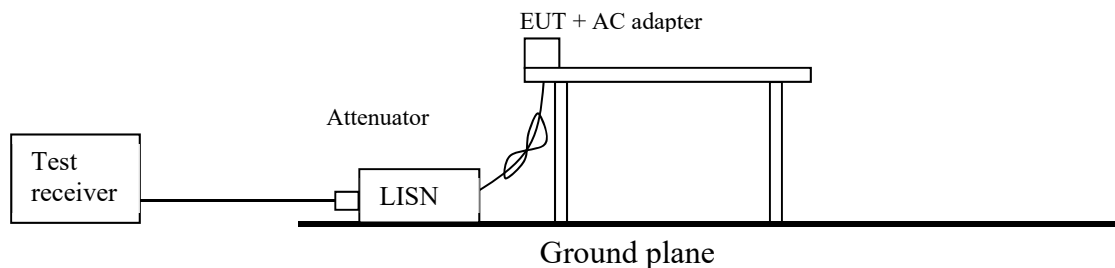

SECTION 6: Radiated Spurious Emission

Test Procedure

It was measured based on "8.5 and 8.6 of KDB 558074 D01 15.247 Meas Guidance v05r01".

[For below 1 GHz]

EUT was placed on a platform of nominal size, 1.0 m by 1.5 m, raised 0.8 m above the conducting ground plane. The table is made of expanded polystyrol and expanded polypropylene and the table top is covered with polycarbonate. That has very low permittivity.

The Radiated Electric Field Strength has been measured in a Semi Anechoic Chamber with a ground plane.

[For above 1 GHz]

EUT was placed on a urethane platform of nominal size, 0.5 m by 0.5 m, raised 1.5 m above the conducting ground plane.

The Radiated Electric Field Strength has been measured in a Semi Anechoic Chamber with absorbent materials lined on a ground plane.

The height of the measuring antenna varied between 1 m and 4 m and EUT was rotated a full revolution in order to obtain the maximum value of the electric field strength.

Test antenna was aimed at the EUT for receiving the maximum signal and always kept within the illumination area of the 3 dB beamwidth of the antenna.

The measurements were performed for both vertical and horizontal antenna polarization with the Test Receiver, or the Spectrum Analyzer.

The measurements were made with the following detector function of the test receiver and the Spectrum analyzer (in linear mode).

The test was made with the detector (RBW/VBW) in the following table.

When using Spectrum analyzer, the test was made with adjusting span to zero by using peak hold.

Test Antennas are used as below;

Frequency	30 MHz to 200 MHz	200 MHz to 1 GHz	Above 1 GHz
Antenna Type	Biconical	Logperiodic	Horn

In any 100 kHz bandwidth outside the restricted band in which the spread spectrum intentional radiator is operating, the radio frequency power that is produced by the intentional radiator confirmed 20 dB below that in the 100 kHz bandwidth within the band that contains the highest level of the desired power, based on a radiated measurement.

20 dBc was applied to the frequency over the limit of FCC 15.209 / Table 4 of RSS-Gen 8.9(IC) and outside the restricted band of FCC15.205 / Table 6 of RSS-Gen 8.10 (IC).

Frequency	Below 1 GHz	Above 1 GHz		20 dBc
Instrument used	Test Receiver	Spectrum Analyzer		Spectrum Analyzer
Detector	QP	PK	AV *1)	PK
IF Bandwidth	BW 120 kHz	RBW: 1 MHz VBW: 3 MHz	Bluetooth low energy: Average Power Method: <u>11.12.2.5.2</u> RBW: 1 MHz VBW: 3 MHz Detector: Power Averaging (Linear voltage) Trace: 100 traces Duty factor was added to the results.	RBW: 100 kHz VBW: 300 kHz
			Wireless LAN: Average Power Method: <u>11.12.2.5.3</u> RBW: 1 MHz VBW: 1/T (T: burst length, refer to Burst rate confirmation sheet) Detector: Peak Trace: max hold	

*1) Average Power Measurement was performed based on ANSI C63.10-2013.

Figure 2: Test Setup

Below 1 GHz

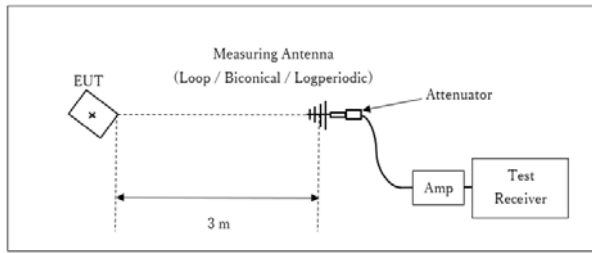

× : Center of turn table

Test Distance: 3 m

1 GHz - 13 GHz

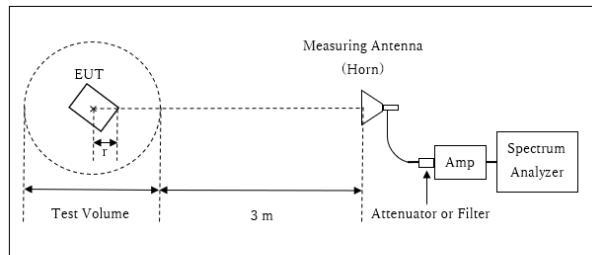

r : Radius of an outer periphery of EUT
 × : Center of turn table

Distance Factor: $20 \times \log(3.89 \text{ m} / 3.0 \text{ m}) = 2.26 \text{ dB}$
 * Test Distance: $(3 + \text{Test Volume} / 2) - r = 3.89 \text{ m}$

Test Volume : 2.0 m
 (Test Volume has been calibrated based on CISPR 16-1-4.)
 $r = 0.11 \text{ m}$

13 GHz – 26.5 GHz

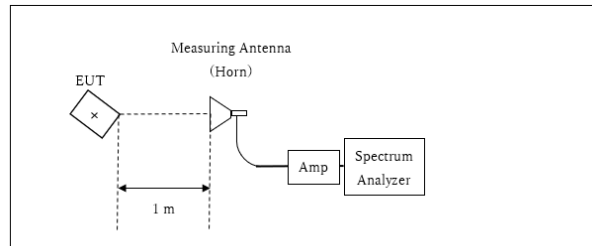

× : Center of turn table

Distance Factor: $20 \times \log(1.0 \text{ m} / 3.0 \text{ m}) = -9.54 \text{ dB}$
 *Test Distance: 1 m

- The carrier level and noise levels were confirmed at each position of X, Y and Z axes of EUT to see the position of maximum noise, and the test was made at the position that has the maximum noise.

Worst position:

Bluetooth low energy:

Antenna polarization	Carrier (Band edge)	Spurious			
		Below 1 GHz	Above 1 GHz		
			1 GHz- 2.8 GHz	2.8 GHz -13 GHz	13 GHz - 26.5 GHz
Horizontal	X	X	X	X	X
Vertical	Z	X	Z	X	X

Worst position:

Wireless LAN:

Mode	Antenna polarization	Carrier (Band edge)	Spurious			
			Below 1 GHz	Above 1 GHz		
				1 GHz- 2.8 GHz	2.8 GHz -13 GHz	13 GHz - 26.5 GHz
SISO	Horizontal	Z	-	Z	Y	X
	Vertical	Z	-	Z	X	X
MIMO	Horizontal	X	X	X	Y	X
	Vertical	Y	X	Y	X	X

The test results and limit are rounded off to one decimal place, so some differences might be observed.

Measurement range : 30 MHz - 26.5 GHz
Test data : APPENDIX
Test result : Pass

SECTION 7: Antenna Terminal Conducted Tests

Test Procedure

The tests were made with below setting connected to the antenna port.

Test	Span	RBW	VBW	Sweep time	Detector	Trace	Instrument used
6 dB Bandwidth	50 MHz	100 kHz	300 kHz	Auto	Peak	Max Hold	Spectrum Analyzer
99 % Occupied Bandwidth *1)	Enough width to display emission skirts	1 to 5 % of OBW	Three times of RBW	Auto	Peak	Max Hold	Spectrum Analyzer
Maximum Peak Output Power	-	-	-	Auto	Peak/Average *2)	-	Power Meter (Sensor: 160 MHz BW)
Peak Power Density	1.5 times the 6 dB Bandwidth	3 kHz	9.1 kHz	Auto	Peak	Max Hold	Spectrum Analyzer *3)
Conducted Spurious Emission *4)	9 kHz to 150 kHz	200 Hz	620 Hz	Auto	Peak	Max Hold	Spectrum Analyzer
	150 kHz to 30 MHz	10 kHz	30 kHz				
*1) Peak hold was applied as Worst-case measurement.							
*2) Reference data							
*3) Section 11.10.2 Method PKPSD (peak PSD) of "ANSI C63.10-2013".							
*4) In the frequency range below 30 MHz, RBW was narrowed to separate the noise contents. Then, wide-band noise near the limit was checked separately, however the noise was low enough as shown in the chart.							

The test results and limit are rounded off to two decimals place, so some differences might be observed. The equipment and cables were not used for factor 0 dB of the data sheets.

Test data : APPENDIX
Test result : Pass

DATA OF CONDUCTED EMISSION TEST

UL Japan, Inc. Shonan EMC Lab. No.3 Shielded Room

Date : 2019/03/11

Company : Nintendo Co., Ltd.
 Kind of EUT : Game console
 Model No. : HDH-001
 Serial No. : XJW01000021040
 Remarks : -

Mode : Tx BTLE 2402 MHz
 Order No. : 12656071S
 Power : AC 120 V / 60 Hz(AC adapter input)
 Temp./Humi. : 25 deg.C / 36 %RH

Limit : FCC_Part 15 Subpart C(15.207)

Engineer : Kenichi Adachi

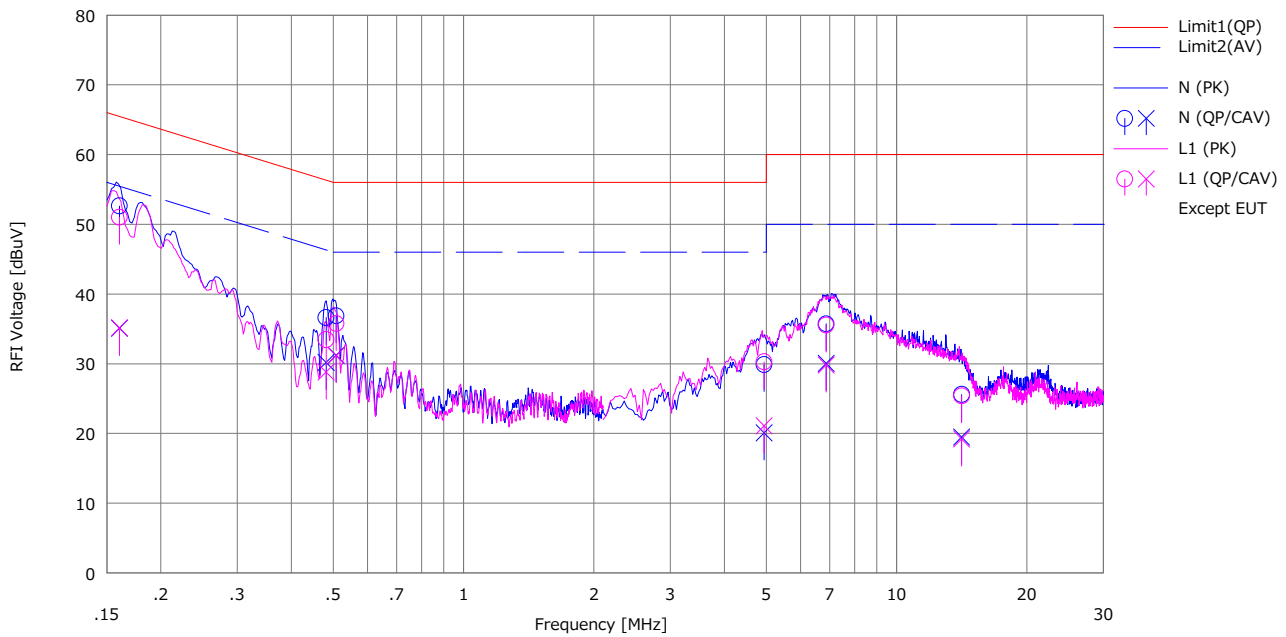

No.	Freq. [MHz]	Reading		C.Fac [dB]	Results		Limit		Margin		Phase	Comment
		<QP>	<CAV>		<QP>	<CAV>	<QP>	<AV>	<QP>	<AV>		
		[dBuV]	[dBuV]		[dBuV]	[dBuV]	[dBuV]	[dBuV]	[dB]	[dB]		
1	0.16049	40.08	22.54	12.56	52.64	35.10	65.44	55.44	12.8	20.3	N	
2	0.48135	24.04	17.60	12.58	36.62	30.18	56.32	46.32	19.7	16.1	N	
3	0.50798	24.28	18.64	12.58	36.86	31.22	56.00	46.00	19.1	14.7	N	
4	4.94349	16.78	6.97	13.10	29.88	20.07	56.00	46.00	26.1	25.9	N	
5	6.87480	22.36	16.69	13.36	35.72	30.05	60.00	50.00	24.2	19.9	N	
6	14.13590	11.28	5.19	14.31	25.59	19.50	60.00	50.00	34.4	30.5	N	
7	0.16049	38.44	22.59	12.56	51.00	35.15	65.44	55.44	14.4	20.2	L1	
8	0.48135	20.88	16.22	12.58	33.46	28.80	56.32	46.32	22.8	17.5	L1	
9	0.50798	23.18	18.59	12.58	35.76	31.17	56.00	46.00	20.2	14.8	L1	
10	4.94349	17.17	7.98	13.10	30.27	21.08	56.00	46.00	25.7	24.9	L1	
11	6.87480	22.18	16.46	13.36	35.54	29.82	60.00	50.00	24.4	20.1	L1	
12	14.13590	11.08	4.89	14.31	25.39	19.20	60.00	50.00	34.6	30.8	L1	

Calculation: Result[dBuV]=Reading[dBuV]+C.Fac(LISN+Cable+ATT)[dB]
 LISN: SLS-02 with Extention cable

DATA OF CONDUCTED EMISSION TEST

UL Japan, Inc. Shonan EMC Lab. No.3 Shielded Room

Date : 2019/03/11

Company : Nintendo Co., Ltd.
 Kind of EUT : Game console
 Model No. : HDH-001
 Serial No. : XJW01000021040
 Remarks : -

Mode : Tx BTLE 2440 MHz
 Order No. : 12656071S
 Power : AC 120 V / 60 Hz(AC adapter input)
 Temp./Humi. : 25 deg.C / 36 %RH

Limit : FCC_Part 15 Subpart C(15.207)

Engineer : Kenichi Adachi

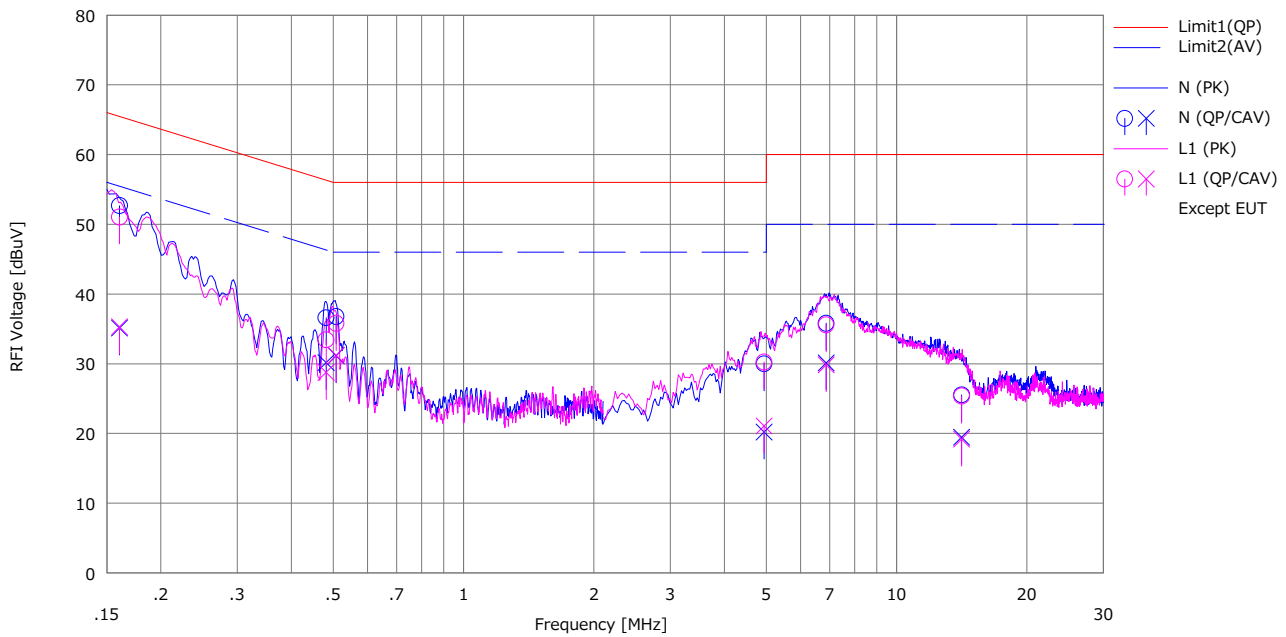

No.	Freq. [MHz]	Reading		C.Fac [dB]	Results		Limit		Margin		Phase	Comment
		<QP>	<CAV>		<QP>	<CAV>	<QP>	<AV>	<QP>	<AV>		
		[dBuV]	[dBuV]		[dBuV]	[dBuV]	[dBuV]	[dBuV]	[dB]	[dB]		
1	0.16054	40.11	22.56	12.56	52.67	35.12	65.44	55.44	12.7	20.3	N	
2	0.48143	24.01	17.58	12.58	36.59	30.16	56.31	46.31	19.7	16.1	N	
3	0.50798	24.19	18.56	12.58	36.77	31.14	56.00	46.00	19.2	14.8	N	
4	4.94347	16.87	7.08	13.10	29.97	20.18	56.00	46.00	26.0	25.8	N	
5	6.87488	22.44	16.76	13.36	35.80	30.12	60.00	50.00	24.2	19.8	N	
6	14.13676	11.22	5.14	14.31	25.53	19.45	60.00	50.00	34.4	30.5	N	
7	0.16054	38.48	22.71	12.56	51.04	35.27	65.44	55.44	14.4	20.1	L1	
8	0.48143	20.84	16.18	12.58	33.42	28.76	56.31	46.31	22.8	17.5	L1	
9	0.50798	23.21	18.62	12.58	35.79	31.20	56.00	46.00	20.2	14.8	L1	
10	4.94347	17.14	7.96	13.10	30.24	21.06	56.00	46.00	25.7	24.9	L1	
11	6.87488	22.21	16.48	13.36	35.57	29.84	60.00	50.00	24.4	20.1	L1	
12	14.13676	11.04	4.88	14.31	25.35	19.19	60.00	50.00	34.6	30.8	L1	

Calculation: Result[dBuV]=Reading[dBuV]+C.Fac(LISN+Cable+ATT)[dB]
 LISN: SLS-02 with Extention cable

DATA OF CONDUCTED EMISSION TEST

UL Japan, Inc. Shonan EMC Lab. No.3 Shielded Room

Date : 2019/03/11

Company : Nintendo Co., Ltd.
 Kind of EUT : Game console
 Model No. : HDH-001
 Serial No. : XJW01000021040
 Remarks : -

Mode : Tx BTLE 2480 MHz
 Order No. : 12656071S
 Power : AC 120 V / 60 Hz(AC adapter input)
 Temp./Humi. : 25 deg.C / 36 %RH

Limit : FCC_Part 15 Subpart C(15.207)

Engineer : Kenichi Adachi

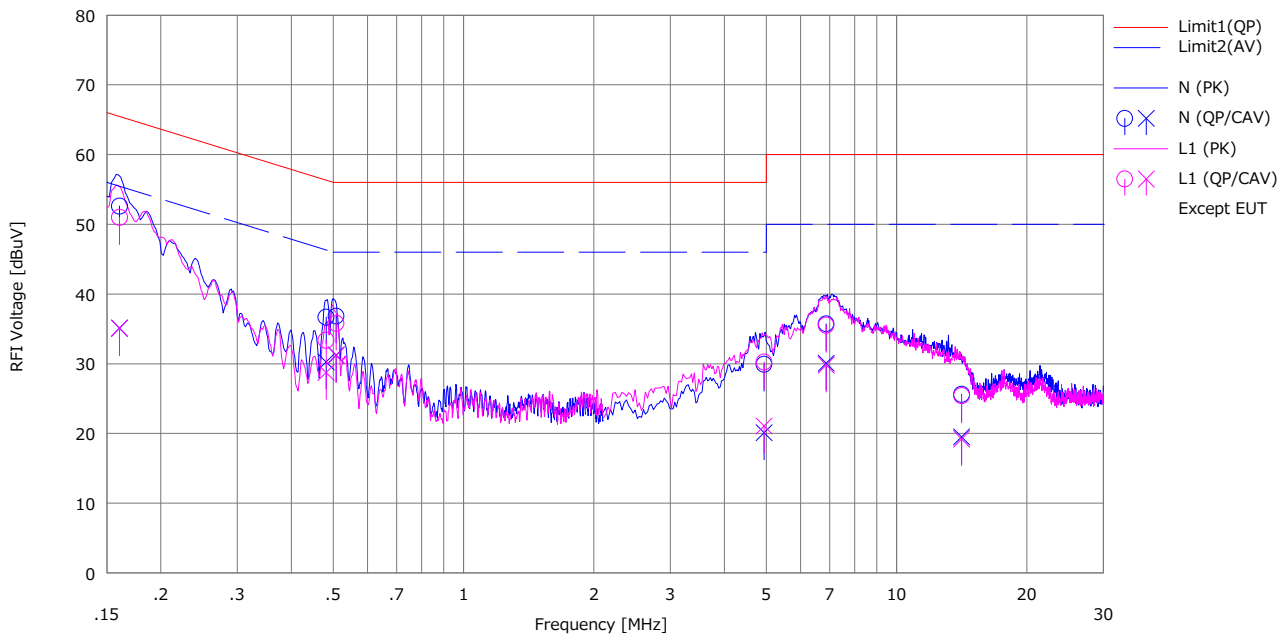

No.	Freq. [MHz]	Reading		C.Fac [dB]	Results		Limit		Margin		Phase	Comment
		<QP>	<CAV>		<QP>	<CAV>	<QP>	<AV>	<QP>	<AV>		
		[dBuV]	[dBuV]		[dBuV]	[dBuV]	[dBuV]	[dBuV]	[dB]	[dB]		
1	0.16052	40.03	22.52	12.56	52.59	35.08	65.44	55.44	12.8	20.3	N	
2	0.48139	24.09	17.66	12.58	36.67	30.24	56.32	46.32	19.6	16.0	N	
3	0.50797	24.24	18.65	12.58	36.82	31.23	56.00	46.00	19.1	14.7	N	
4	4.94362	16.82	7.01	13.10	29.92	20.11	56.00	46.00	26.0	25.8	N	
5	6.87457	22.37	16.71	13.36	35.73	30.07	60.00	50.00	24.2	19.9	N	
6	14.13625	11.30	5.21	14.31	25.61	19.52	60.00	50.00	34.3	30.4	N	
7	0.16052	38.42	22.55	12.56	50.98	35.11	65.44	55.44	14.4	20.3	L1	
8	0.48139	20.78	16.16	12.58	33.36	28.74	56.32	46.32	22.9	17.5	L1	
9	0.50797	23.22	18.61	12.58	35.80	31.19	56.00	46.00	20.2	14.8	L1	
10	4.94362	17.14	7.95	13.10	30.24	21.05	56.00	46.00	25.7	24.9	L1	
11	6.87457	22.16	16.44	13.36	35.52	29.80	60.00	50.00	24.4	20.2	L1	
12	14.13625	11.10	4.92	14.31	25.41	19.23	60.00	50.00	34.5	30.7	L1	

Calculation: Result[dBuV]=Reading[dBuV]+C.Fac(LISN+Cable+ATT)[dB]
 LISN: SLS-02 with Extention cable

DATA OF CONDUCTED EMISSION TEST

UL Japan, Inc. Shonan EMC Lab. No.3 Shielded Room

Date :2019/03/11

Company : Nintendo Co., Ltd.
 Kind of EUT : Game console
 Model No. : HDH-001
 Serial No. : XJW01000021040
 Remarks : -

Mode : Tx, OFDM VHT20, MIMO, 2437 MHz
 Order No. : 12656071S
 Power : AC 120 V / 60 Hz(AC adapter input)
 Temp./Humi. : 25 deg.C / 36 %RH

Limit : FCC_Part 15 Subpart C(15.207)

Engineer : Kenichi Adachi

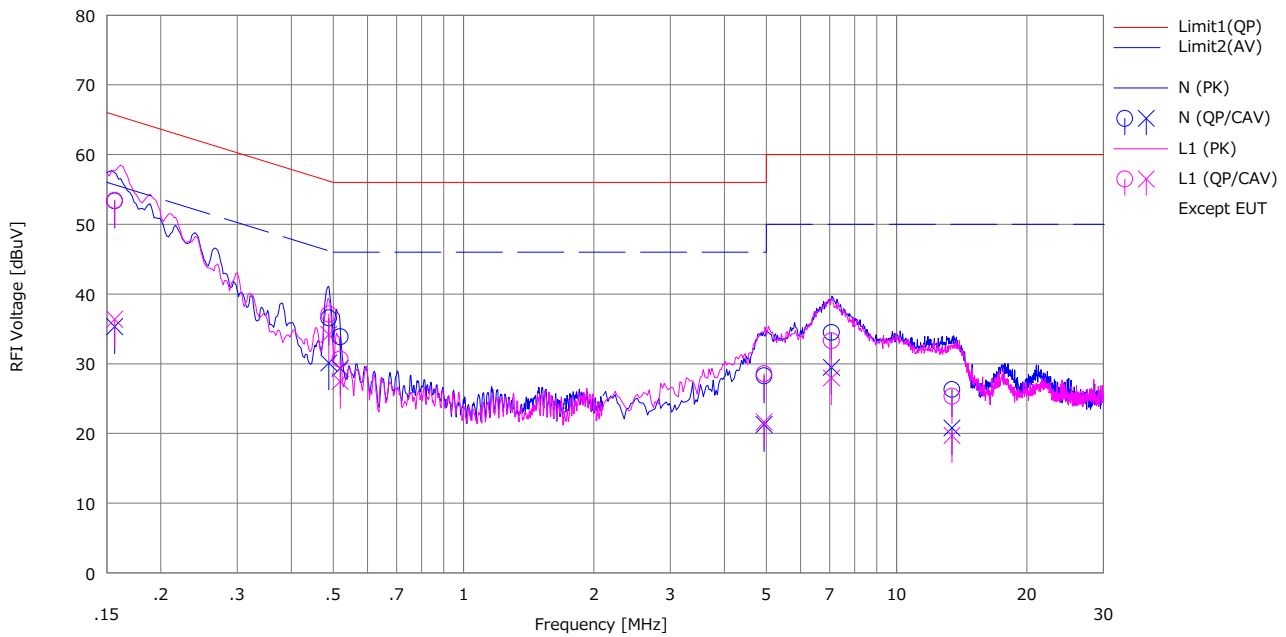

No.	Freq. [MHz]	Reading		C.Fac [dB]	Results		Limit		Margin		Phase	Comment
		<QP> [dBuV]	<CAV> [dBuV]		<QP> [dBuV]	<CAV> [dBuV]	<QP> [dBuV]	<AV> [dBuV]	<QP> [dB]	<AV> [dB]		
1	0.15643	40.79	22.78	12.55	53.34	35.33	65.65	55.65	12.3	20.3	N	
2	0.48833	23.98	17.54	12.58	36.56	30.12	56.20	46.20	19.6	16.0	N	
3	0.51888	21.29	16.76	12.58	33.87	29.34	56.00	46.00	22.1	16.6	N	
4	4.93912	15.16	8.18	13.10	28.26	21.28	56.00	46.00	27.7	24.7	N	
5	7.07264	21.09	16.08	13.39	34.48	29.47	60.00	50.00	25.5	20.5	N	
6	13.41334	12.08	6.57	14.22	26.30	20.79	60.00	50.00	33.7	29.2	N	
7	0.15643	40.88	23.84	12.55	53.43	36.39	65.65	55.65	12.2	19.2	L1	
8	0.48833	24.55	21.59	12.58	37.13	34.17	56.20	46.20	19.0	12.0	L1	
9	0.51888	18.08	14.87	12.58	30.66	27.45	56.00	46.00	25.3	18.5	L1	
10	4.93912	15.46	8.54	13.10	28.56	21.64	56.00	46.00	27.4	24.3	L1	
11	7.07264	19.89	14.55	13.39	33.28	27.94	60.00	50.00	26.7	22.0	L1	
12	13.41334	11.09	5.48	14.22	25.31	19.70	60.00	50.00	34.6	30.3	L1	

Calculation: Result[dBuV]=Reading[dBuV]+C.Fac(LISN+Cable+ATT)[dB]
 LISN: SLS-02 with Extention cable

-6 dB Bandwidth

Test place	UL Japan, Inc. Shonan EMC Lab.	No.1 Measurement Room
Date	March 11, 2019	
Temperature / Humidity	24 deg.C , 55 %RH	
Engineer	Yosuke Ishikawa	
Mode	Tx, Bluetooth Low Energy, PN9	

Freq. [MHz]	-6 dB Bandwidth [MHz]	Limit [MHz]
2402.0000	0.734	> 0.500
2440.0000	0.728	> 0.500
2480.0000	0.724	> 0.500

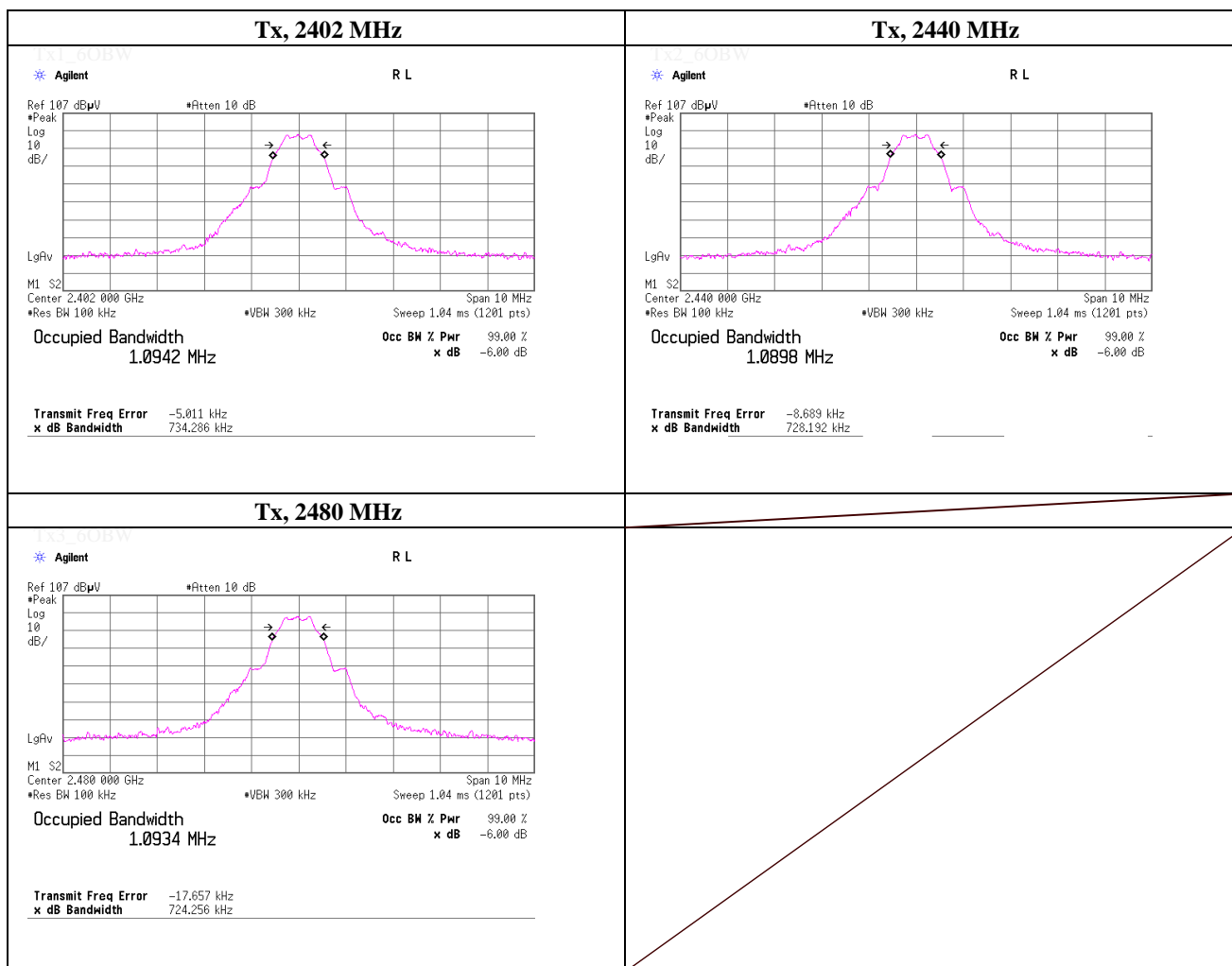

-6 dB Bandwidth

Test place	UL Japan, Inc. Shonan EMC Lab.	No.1 Measurement Room
Date	February 28, 2019	
Temperature / Humidity	23 deg.C , 55 %RH	
Engineer	Yosuke Ishikawa	
Mode	Tx, IEEE802.11b, PN9, worst antenna port 1, worst data mode 11 Mbps	

Freq. [MHz]	-6 dB Bandwidth [MHz]	Limit [MHz]
2412.0000	8.650	> 0.500
2437.0000	8.777	> 0.500
2462.0000	8.749	> 0.500

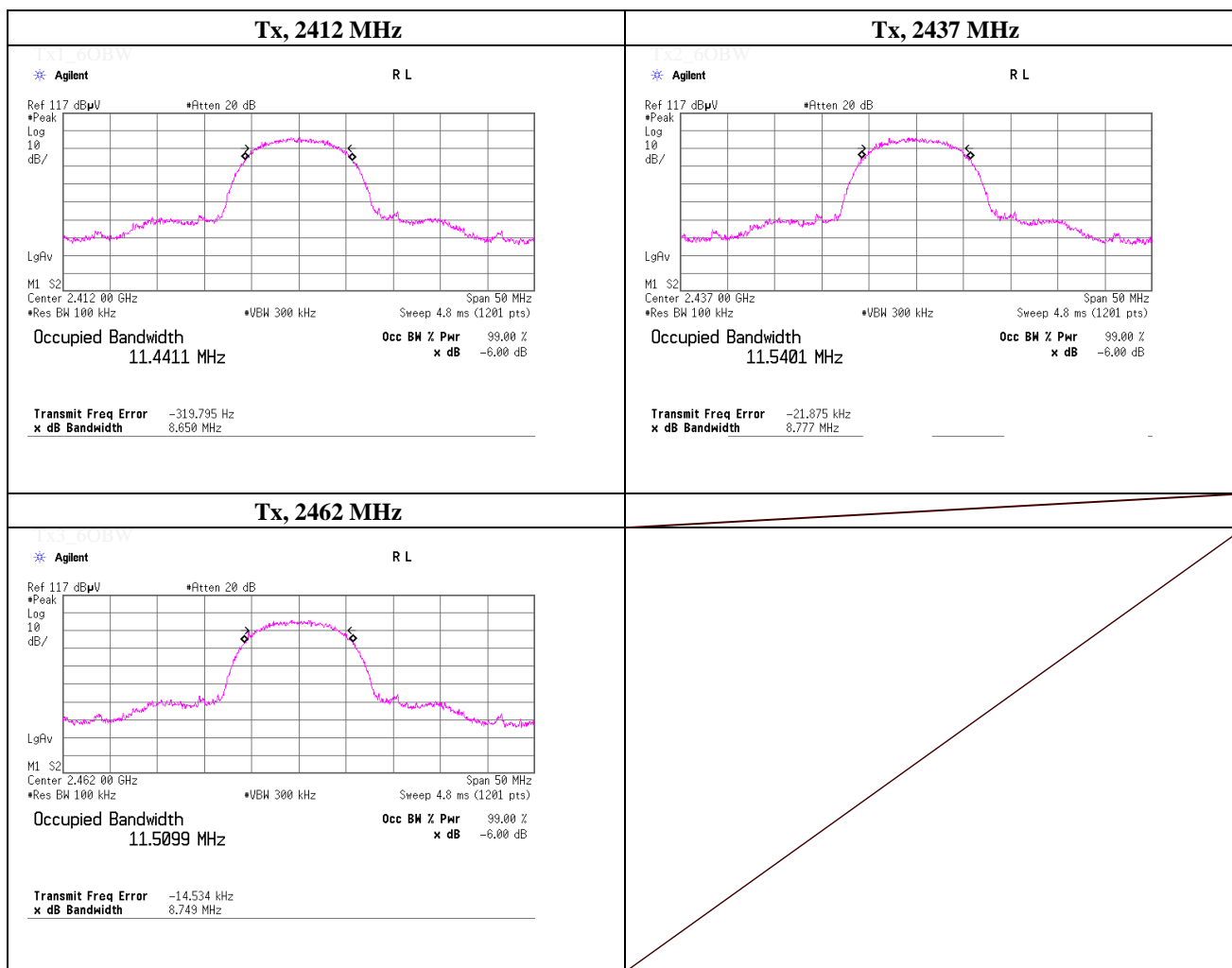

-6 dB Bandwidth

Test place	UL Japan, Inc. Shonan EMC Lab.	No.1 Measurement Room
Date	February 28, 2019	
Temperature / Humidity	23 deg.C , 55 %RH	
Engineer	Yosuke Ishikawa	
Mode	Tx, IEEE802.11b, PN9, worst antenna port 1, worst data mode 11 Mbps	

Freq. [MHz]	-6 dB Bandwidth [MHz]	Limit [MHz]
2467.0000	8.589	> 0.500
2472.0000	8.745	> 0.500

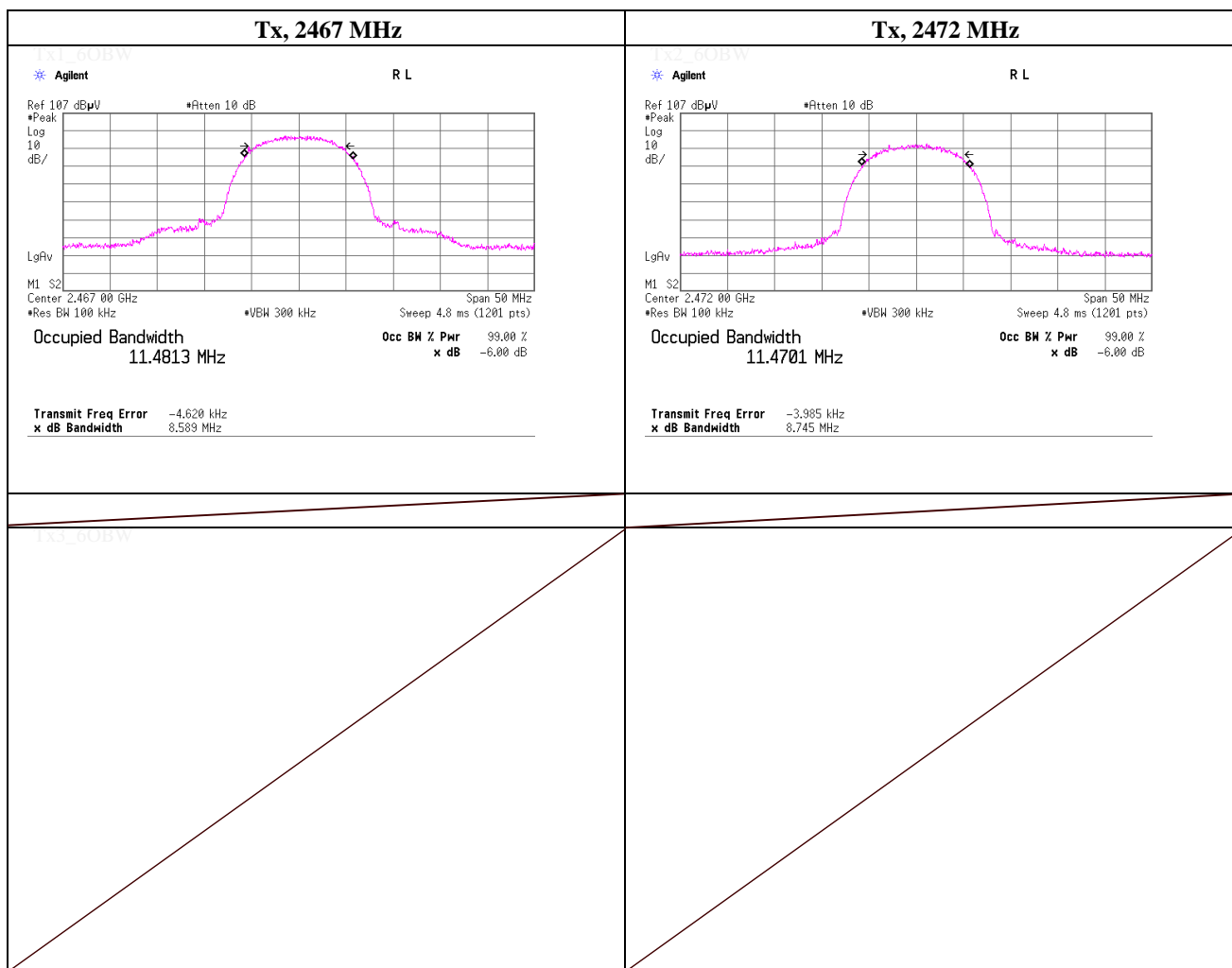

UL Japan, Inc.

Shonan EMC Lab.

1-22-3 Megumigaoka, Hiratsuka-shi, Kanagawa 259-1220 JAPAN

Telephone : +81 463 50 6400

Facsimile : +81 463 50 6401

-6 dB Bandwidth

Test place	UL Japan, Inc. Shonan EMC Lab.	No.1 Measurement Room
Date	February 28, 2019	
Temperature / Humidity	23 deg.C , 55 %RH	
Engineer	Yosuke Ishikawa	
Mode	Tx, IEEE802.11g, PN9, worst antenna port 1, worst data mode 48 Mbps	

Freq. [MHz]	-6 dB Bandwidth [MHz]	Limit [MHz]
2412.0000	16.467	> 0.500

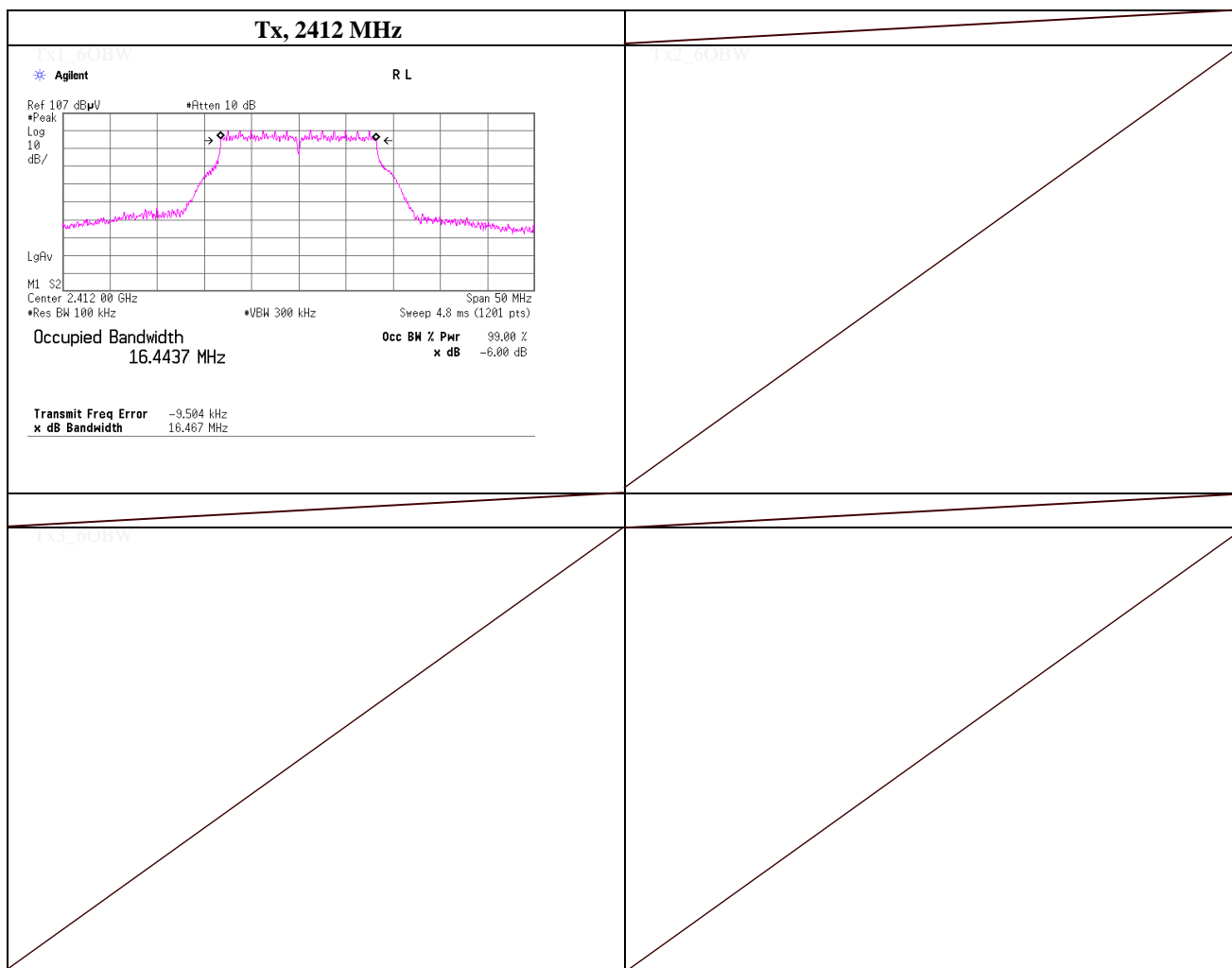

UL Japan, Inc.

Shonan EMC Lab.

1-22-3 Megumigaoka, Hiratsuka-shi, Kanagawa 259-1220 JAPAN

Telephone : +81 463 50 6400

Facsimile : +81 463 50 6401

-6 dB Bandwidth

Test place	UL Japan, Inc. Shonan EMC Lab.	No.1 Measurement Room
Date	February 28, 2019	
Temperature / Humidity	23 deg.C , 55 %RH	
Engineer	Yosuke Ishikawa	
Mode	Tx, IEEE802.11g, PN9, worst antenna port 1, worst data mode 48 Mbps	

Freq. [MHz]	-6 dB Bandwidth [MHz]	Limit [MHz]
2417.0000	16.473	> 0.500
2437.0000	16.463	> 0.500
2462.0000	16.466	> 0.500

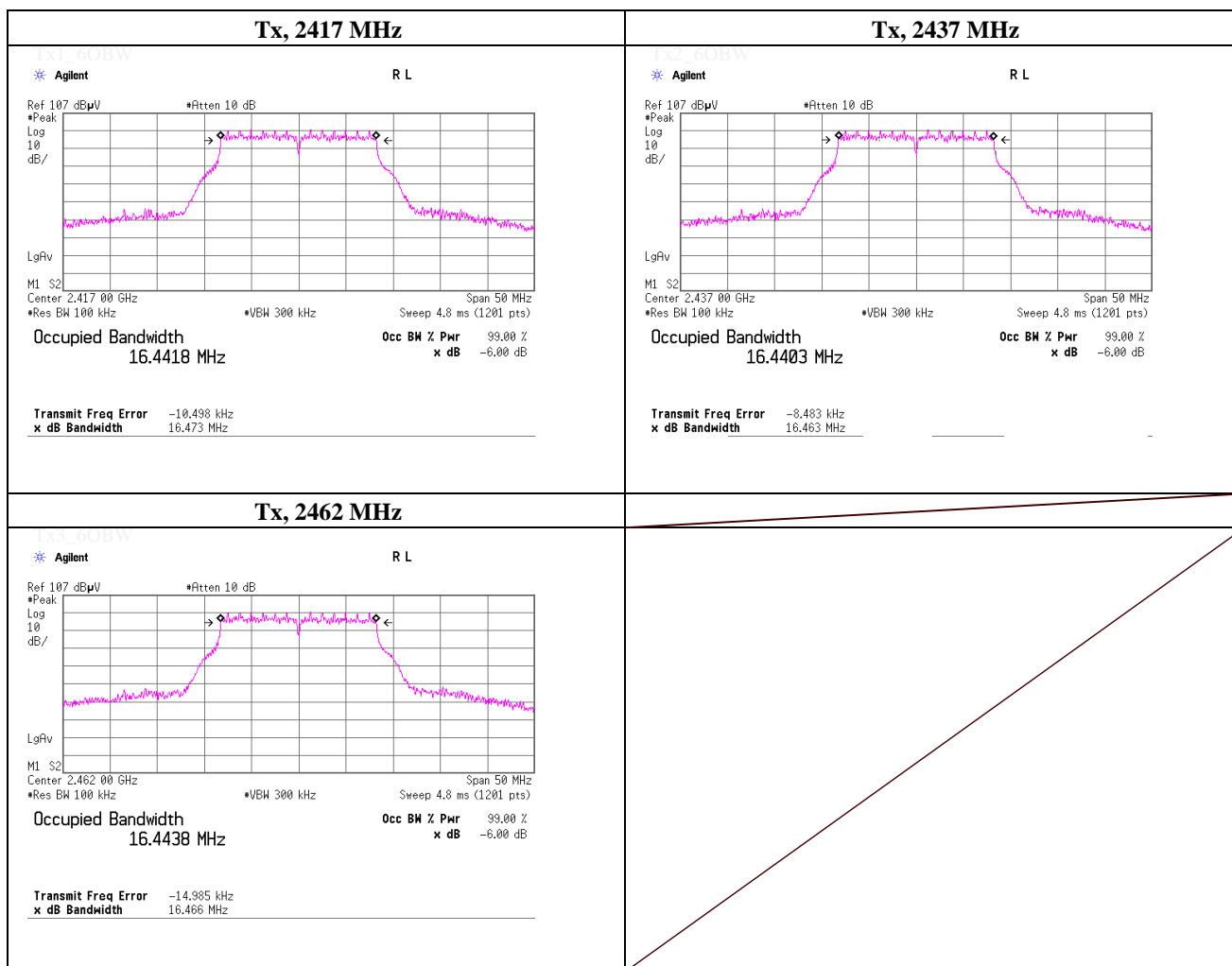

-6 dB Bandwidth

Test place	UL Japan, Inc. Shonan EMC Lab.	No.1 Measurement Room
Date	February 28, 2019	
Temperature / Humidity	23 deg.C , 55 %RH	
Engineer	Yosuke Ishikawa	
Mode	Tx, IEEE802.11g, PN9, worst antenna port 1, worst data mode 48 Mbps	

Freq. [MHz]	-6 dB Bandwidth [MHz]	Limit [MHz]
2467.0000	16.471	> 0.500
2472.0000	16.473	> 0.500

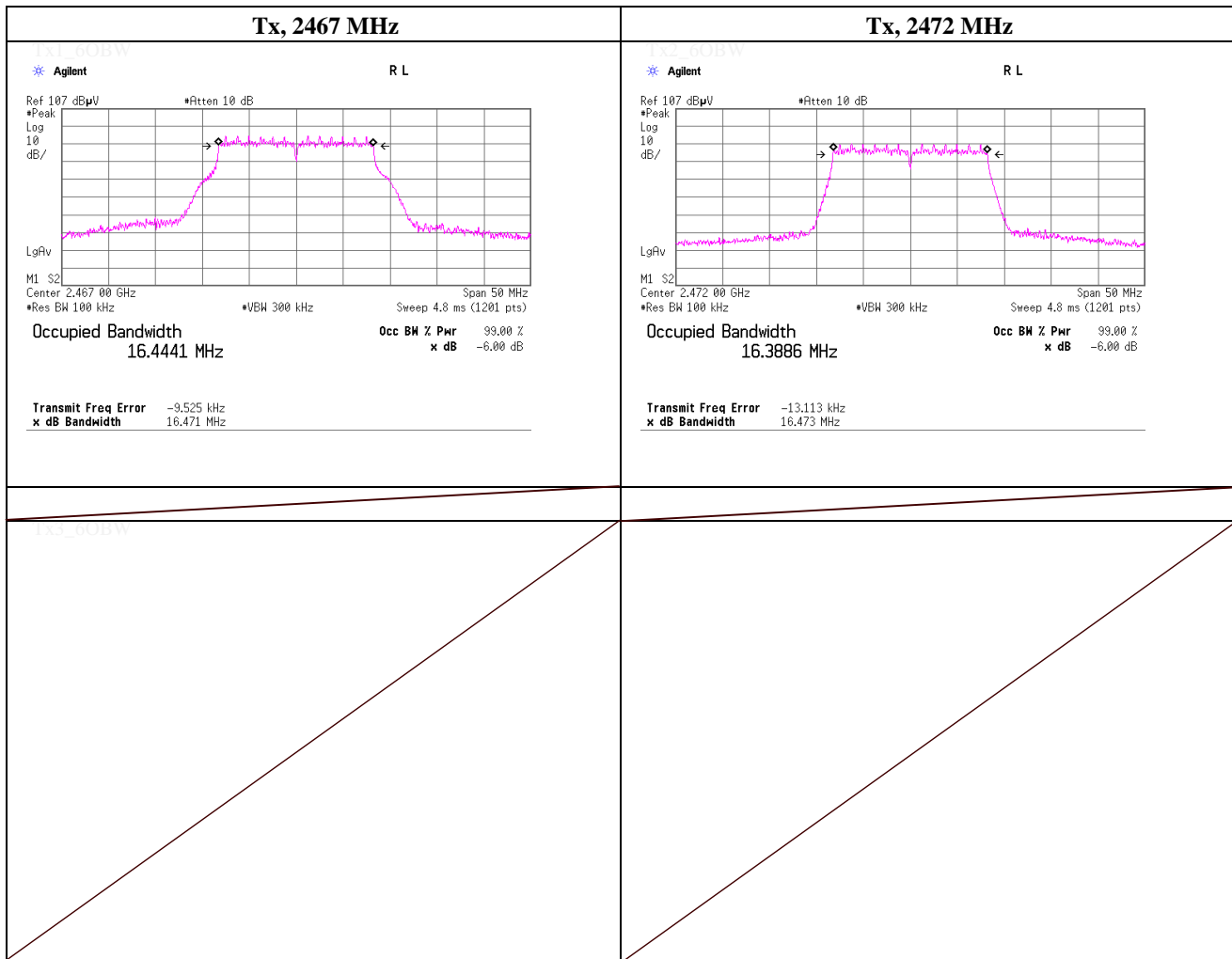

-6 dB Bandwidth

Test place	UL Japan, Inc. Shonan EMC Lab.	No.1 Measurement Room
Date	February 28, 2019	
Temperature / Humidity	23 deg.C , 55 %RH	
Engineer	Yosuke Ishikawa	
Mode	Tx, IEEE802.11n HT20 (SISO), PN9, worst antenna port 1, worst data mode 4 (MCS)	

Freq. [MHz]	-6 dB Bandwidth [MHz]	Limit [MHz]
2412.0000	17.730	> 0.500

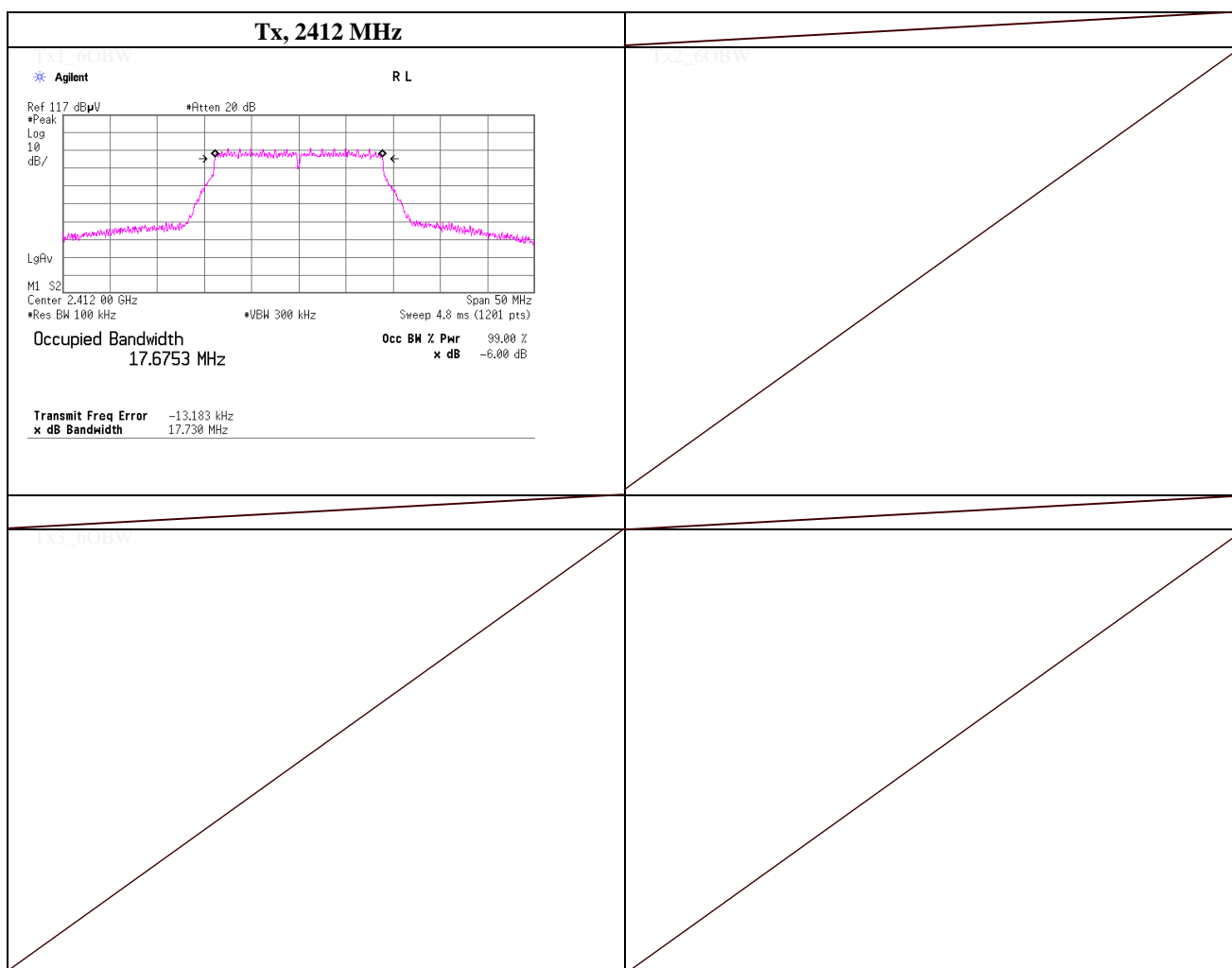

UL Japan, Inc.

Shonan EMC Lab.

1-22-3 Megumigaoka, Hiratsuka-shi, Kanagawa 259-1220 JAPAN

Telephone : +81 463 50 6400

Facsimile : +81 463 50 6401

-6 dB Bandwidth

Test place	UL Japan, Inc. Shonan EMC Lab.	No.1 Measurement Room
Date	February 28, 2019	
Temperature / Humidity	23 deg.C , 55 %RH	
Engineer	Yosuke Ishikawa	
Mode	Tx, IEEE802.11n HT20 (SISO), PN9, worst antenna port 1, worst data mode 3 (MCS)	

Freq. [MHz]	-6 dB Bandwidth [MHz]	Limit [MHz]
2417.0000	17.764	> 0.500
2437.0000	17.777	> 0.500
2462.0000	17.737	> 0.500

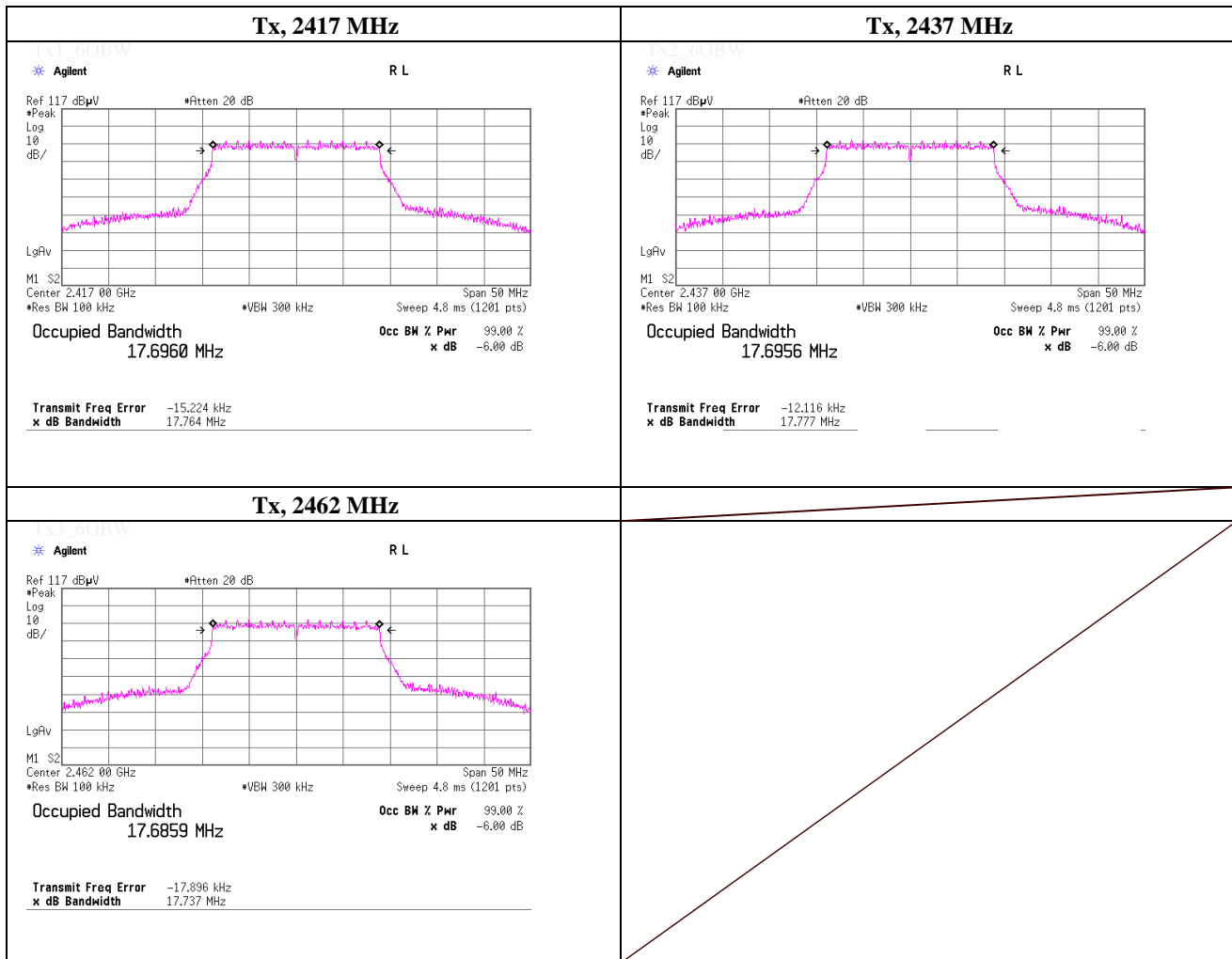

-6 dB Bandwidth

Test place	UL Japan, Inc. Shonan EMC Lab.	No.1 Measurement Room
Date	February 28, 2019	
Temperature / Humidity	23 deg.C , 55 %RH	
Engineer	Yosuke Ishikawa	
Mode	Tx, IEEE802.11n HT20 (SISO), PN9, worst antenna port 1, worst data mode 3 (MCS)	

Freq. [MHz]	-6 dB Bandwidth [MHz]	Limit [MHz]
2467.0000	17.751	> 0.500
2472.0000	17.114	> 0.500

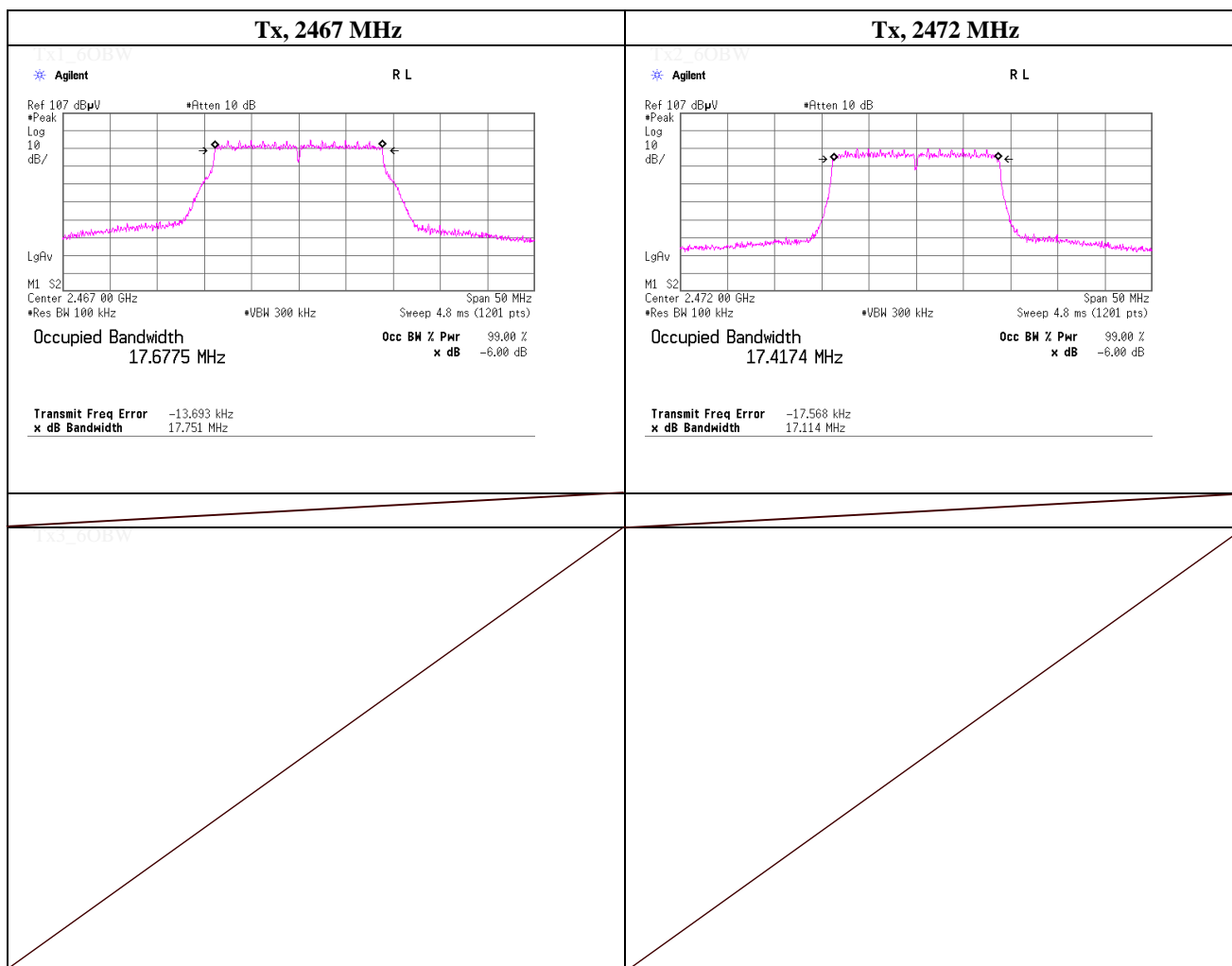

-6 dB Bandwidth

Test place	UL Japan, Inc. Shonan EMC Lab.	No.1 Measurement Room
Date	February 28, 2019	
Temperature / Humidity	23 deg.C , 55 %RH	
Engineer	Yosuke Ishikawa	
Mode	Tx, OFDM VHT20 (SISO), PN9, worst antenna port 1, worst data mode 4 (MCS)	

Freq. [MHz]	-6 dB Bandwidth [MHz]	Limit [MHz]
2412.0000	17.737	> 0.500

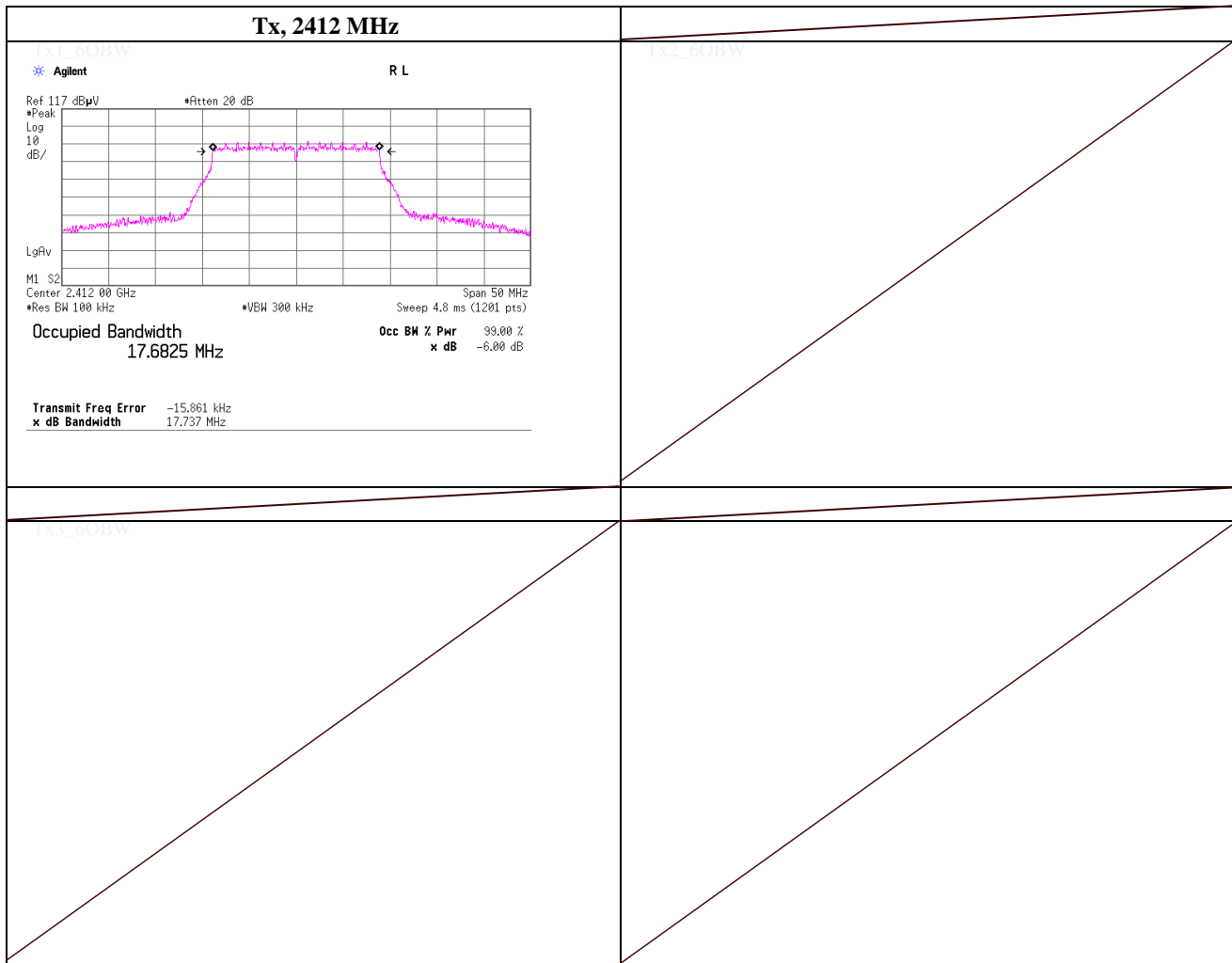

-6 dB Bandwidth

Test place	UL Japan, Inc. Shonan EMC Lab.	No.1 Measurement Room
Date	February 28, 2019	
Temperature / Humidity	23 deg.C , 55 %RH	
Engineer	Yosuke Ishikawa	
Mode	Tx, OFDM VHT20 (SISO), PN9, worst antenna port 1, worst data mode 3 (MCS)	

Freq. [MHz]	-6 dB Bandwidth [MHz]	Limit [MHz]
2417.0000	17.732	> 0.500
2437.0000	17.740	> 0.500
2462.0000	17.754	> 0.500

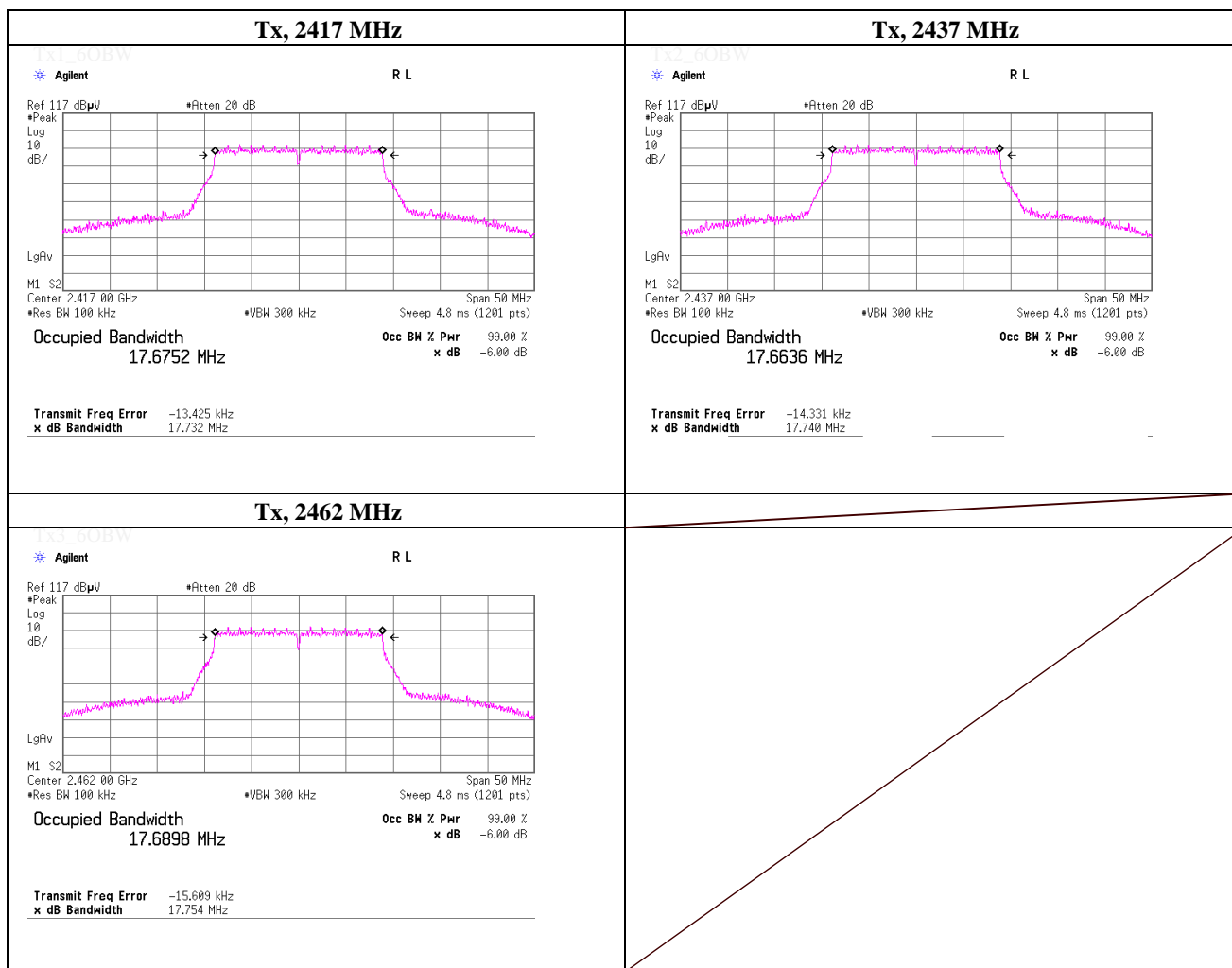

-6 dB Bandwidth

Test place	UL Japan, Inc. Shonan EMC Lab.	No.1 Measurement Room
Date	February 28, 2019	
Temperature / Humidity	23 deg.C , 55 %RH	
Engineer	Yosuke Ishikawa	
Mode	Tx, OFDM VHT20 (SISO), PN9, worst antenna port 1, worst data mode 3 (MCS)	

Freq. [MHz]	-6 dB Bandwidth [MHz]	Limit [MHz]
2467.0000	17.768	> 0.500
2472.0000	17.451	> 0.500

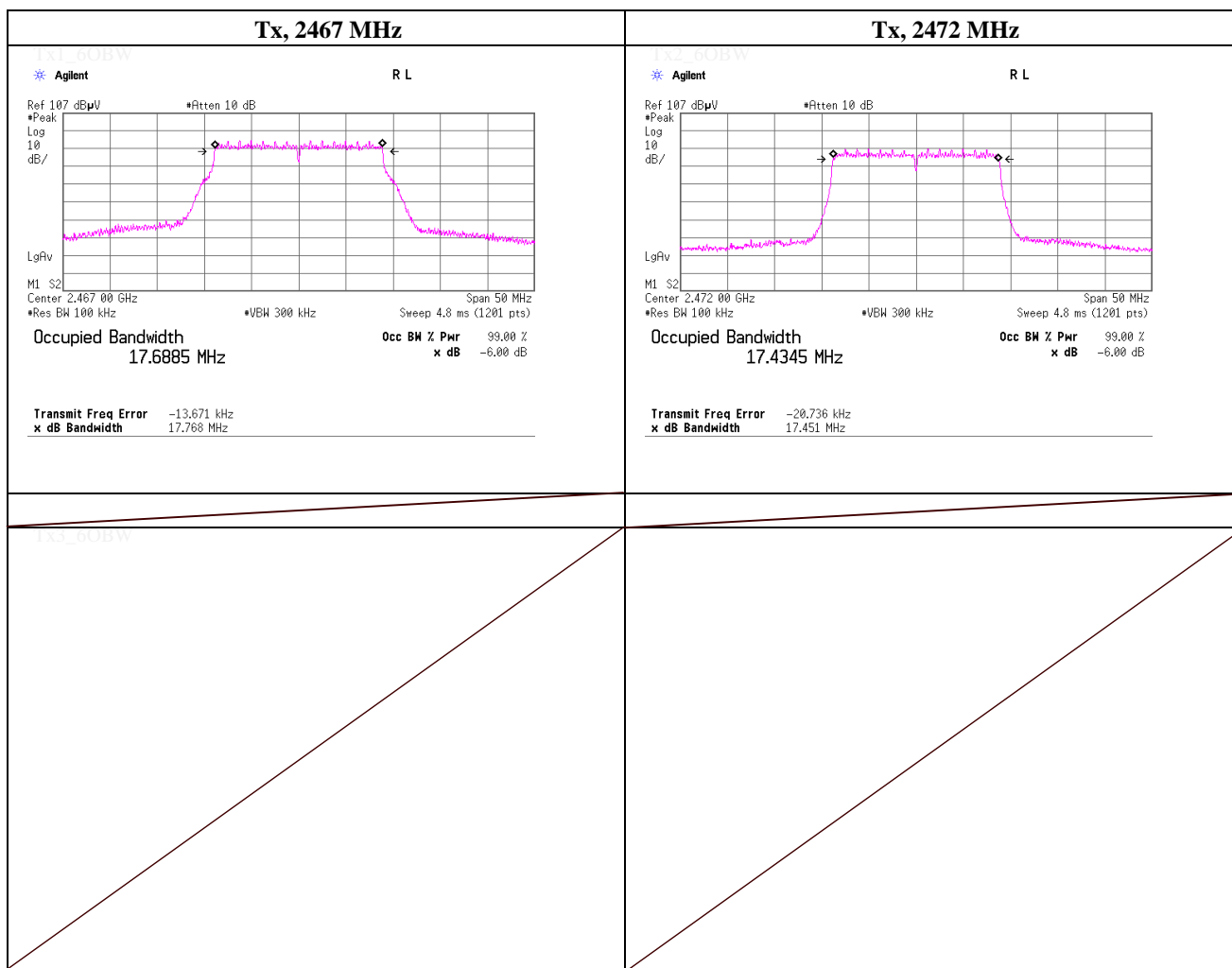

-6 dB Bandwidth

Test place	UL Japan, Inc. Shonan EMC Lab.	No.1 Measurement Room
Date	March 1, 2019	
Temperature / Humidity	24 deg.C , 52 %RH	
Engineer	Yosuke Ishikawa	
Mode	Tx, IEEE802.11n HT20 (MIMO), PN9, antenna port 0, worst data mode 14 (MCS)	

Freq. [MHz]	-6 dB Bandwidth [MHz]	Limit [MHz]
2412.0000	17.731	> 0.500

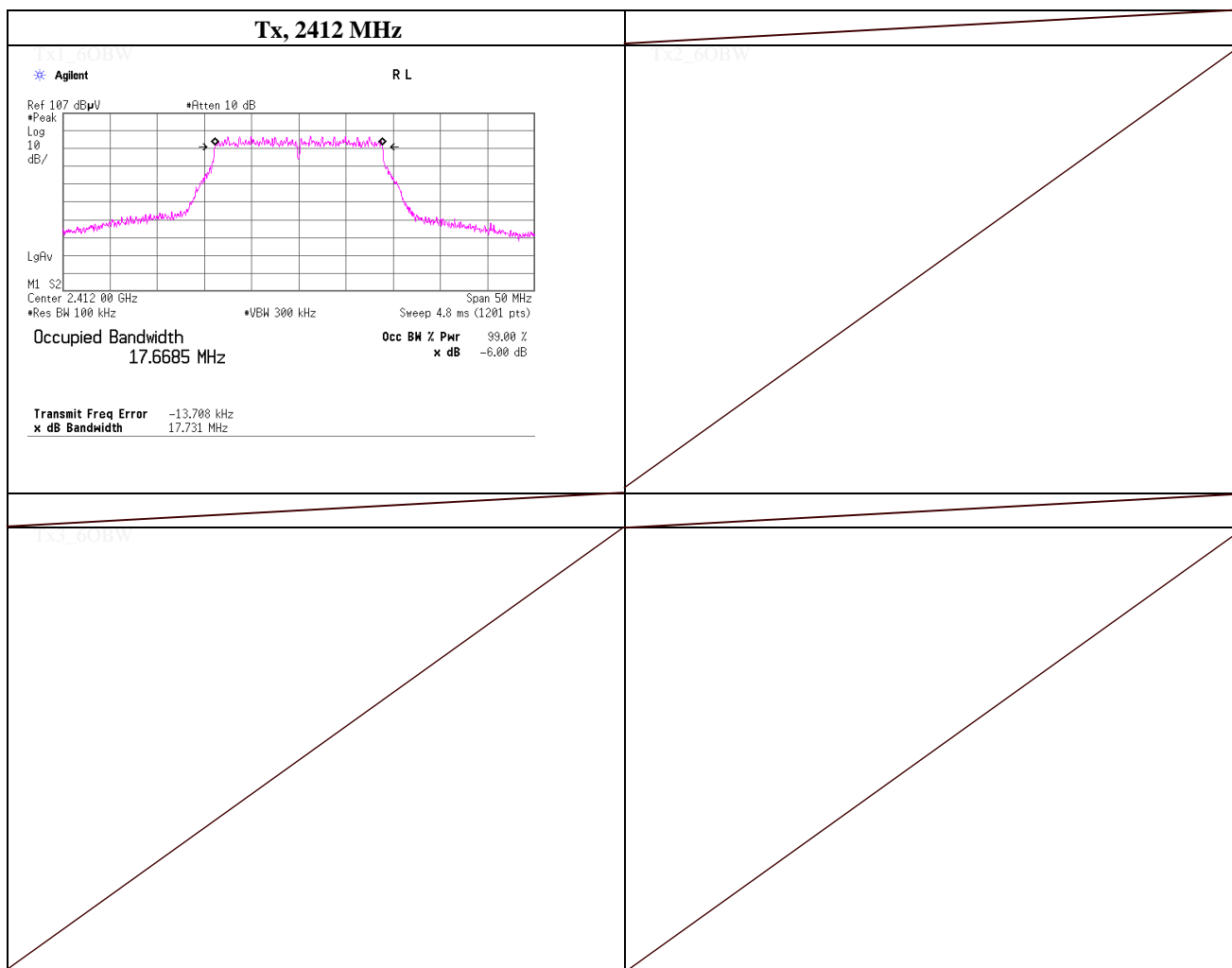

-6 dB Bandwidth

Test place	UL Japan, Inc. Shonan EMC Lab.	No.1 Measurement Room
Date	March 1, 2019	
Temperature / Humidity	24 deg.C , 52 %RH	
Engineer	Yosuke Ishikawa	
Mode	Tx, IEEE802.11n HT20 (MIMO), PN9, antenna port 1, worst data mode 14 (MCS)	

Freq. [MHz]	-6 dB Bandwidth [MHz]	Limit [MHz]
2417.0000	17.760	> 0.500
2437.0000	17.748	> 0.500
2462.0000	17.716	> 0.500

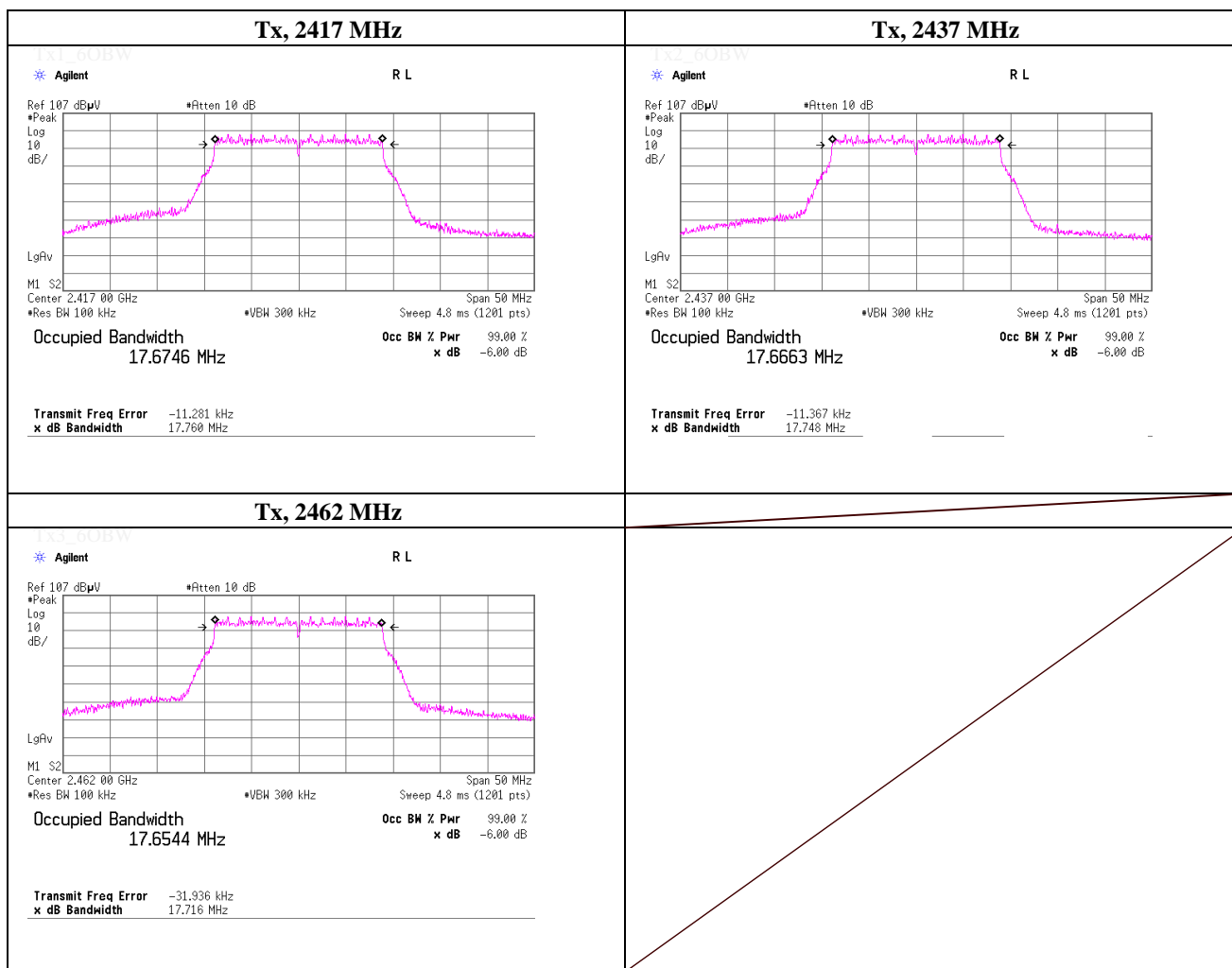

-6 dB Bandwidth

Test place	UL Japan, Inc. Shonan EMC Lab.	No.1 Measurement Room
Date	March 1, 2019	
Temperature / Humidity	24 deg.C , 52 %RH	
Engineer	Yosuke Ishikawa	
Mode	Tx, IEEE802.11n HT20 (MIMO), PN9, antenna port 1, worst data mode 14 (MCS)	

Freq. [MHz]	-6 dB Bandwidth [MHz]	Limit [MHz]
2467.0000	17.729	> 0.500
2472.0000	17.340	> 0.500

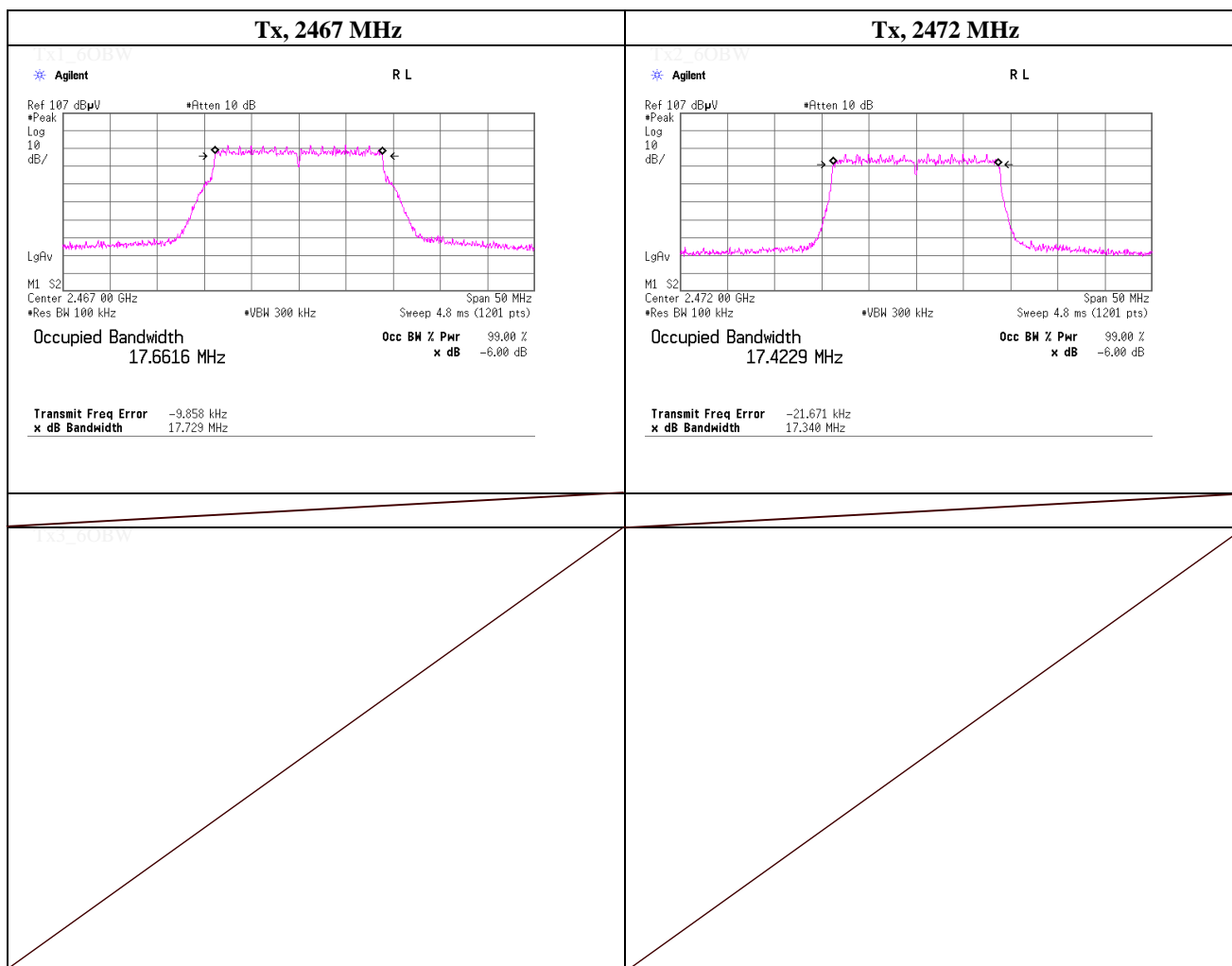

-6 dB Bandwidth

Test place	UL Japan, Inc. Shonan EMC Lab.	No.1 Measurement Room
Date	March 5, 2019	
Temperature / Humidity	23 deg.C , 53 %RH	
Engineer	Kazutaka Takeyama	
Mode	Tx, OFDM VHT20 (MIMO), PN9, antenna port 1, worst data mode 3 (MCS)	

Freq. [MHz]	-6 dB Bandwidth [MHz]	Limit [MHz]
2412.0000	17.730	> 0.500

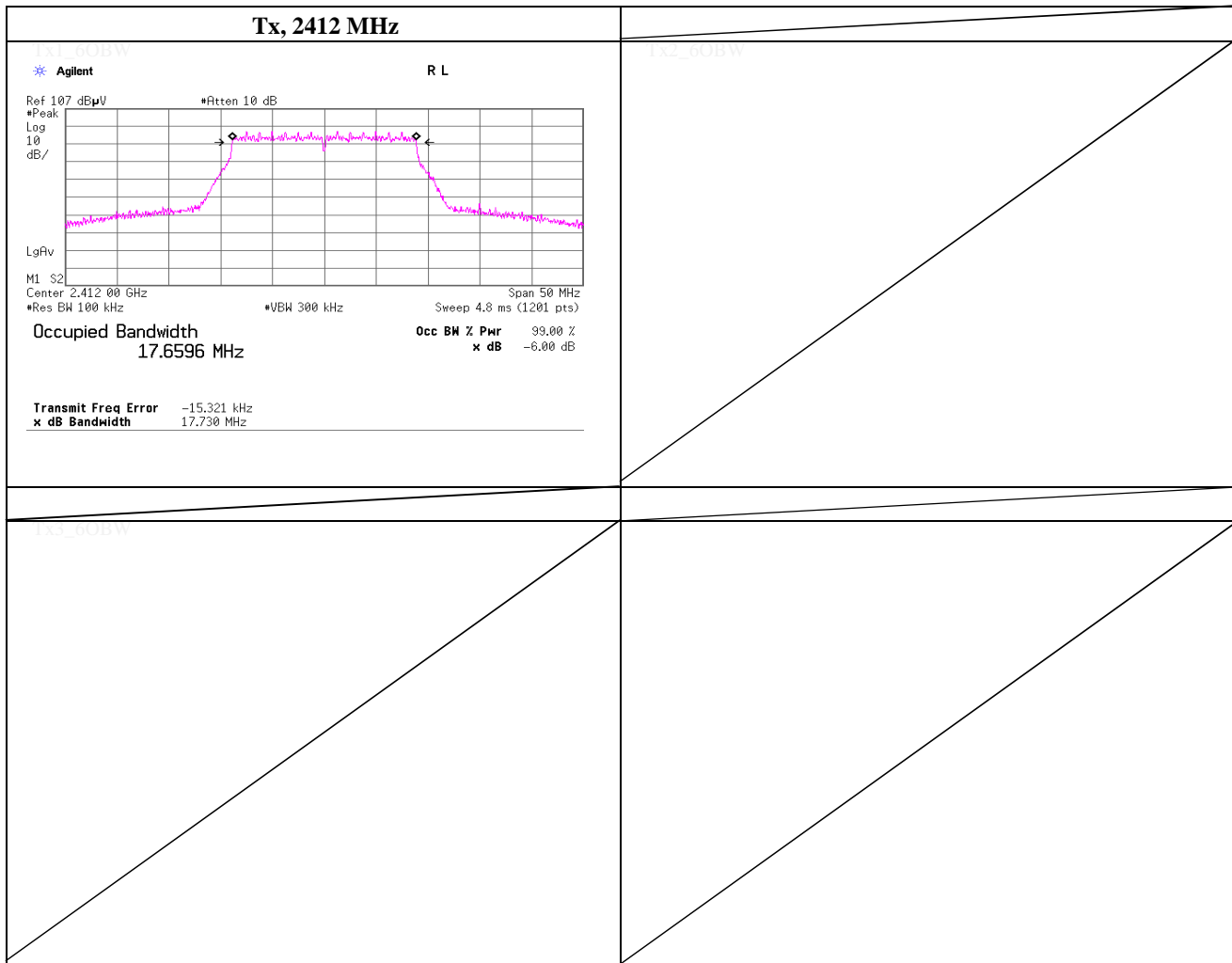

UL Japan, Inc.

Shonan EMC Lab.

1-22-3 Megumigaoka, Hiratsuka-shi, Kanagawa 259-1220 JAPAN

Telephone : +81 463 50 6400

Facsimile : +81 463 50 6401

-6 dB Bandwidth

Test place	UL Japan, Inc. Shonan EMC Lab.	No.1 Measurement Room
Date	March 5, 2019	
Temperature / Humidity	23 deg.C , 53 %RH	
Engineer	Kazutaka Takeyama	
Mode	Tx, OFDM VHT20 (MIMO), PN9, antenna port 1, worst data mode 3 (MCS)	

Freq. [MHz]	-6 dB Bandwidth [MHz]	Limit [MHz]
2417.0000	17.695	> 0.500
2437.0000	17.682	> 0.500
2462.0000	17.720	> 0.500

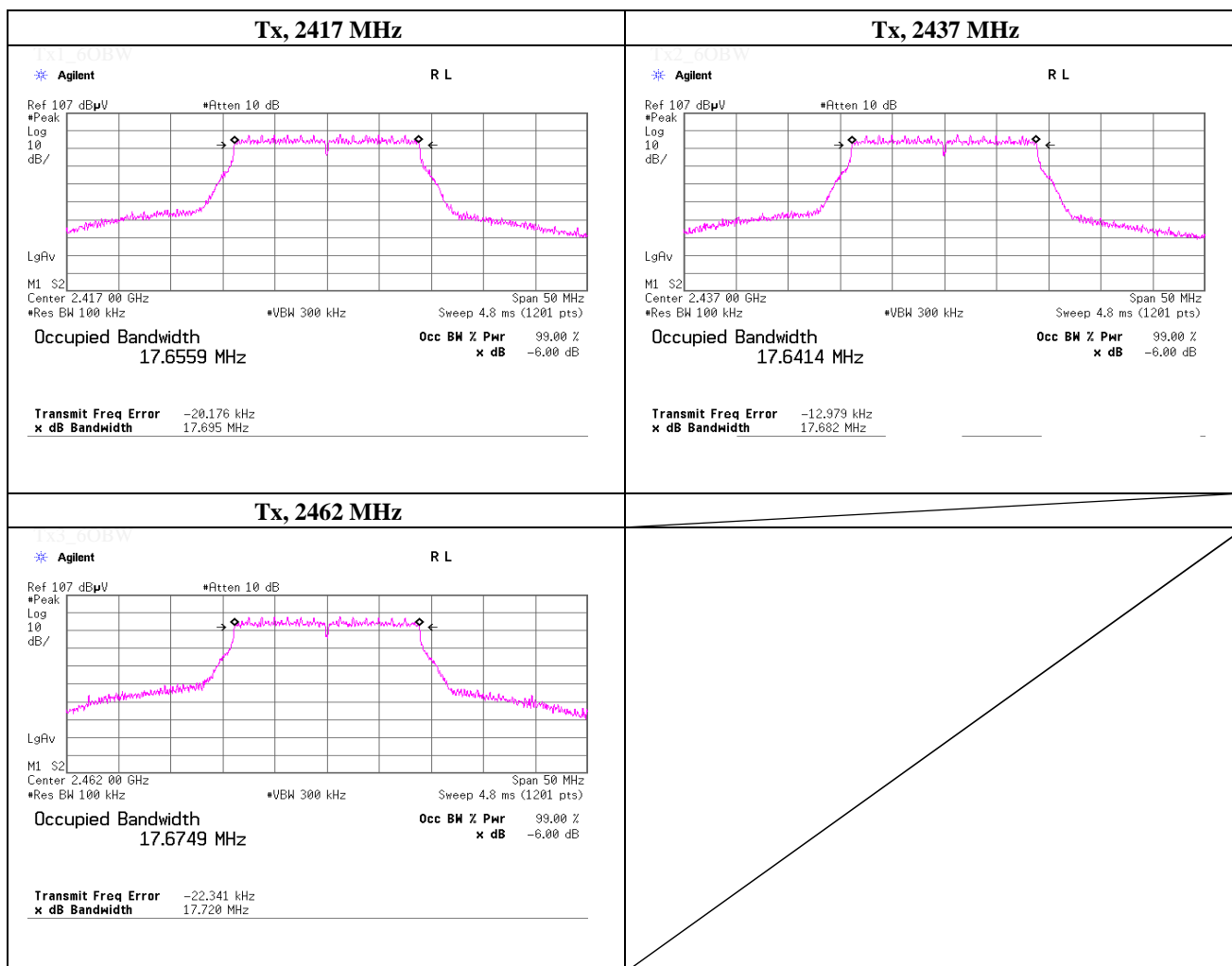

-6 dB Bandwidth

Test place	UL Japan, Inc. Shonan EMC Lab.	No.1 Measurement Room
Date	March 5, 2019	
Temperature / Humidity	23 deg.C , 53 %RH	
Engineer	Kazutaka Takeyama	
Mode	Tx, OFDM VHT20 (MIMO), PN9, antenna port 1, worst data mode 3 (MCS)	

Freq. [MHz]	-6 dB Bandwidth [MHz]	Limit [MHz]
2467.0000	17.753	> 0.500
2472.0000	17.167	> 0.500

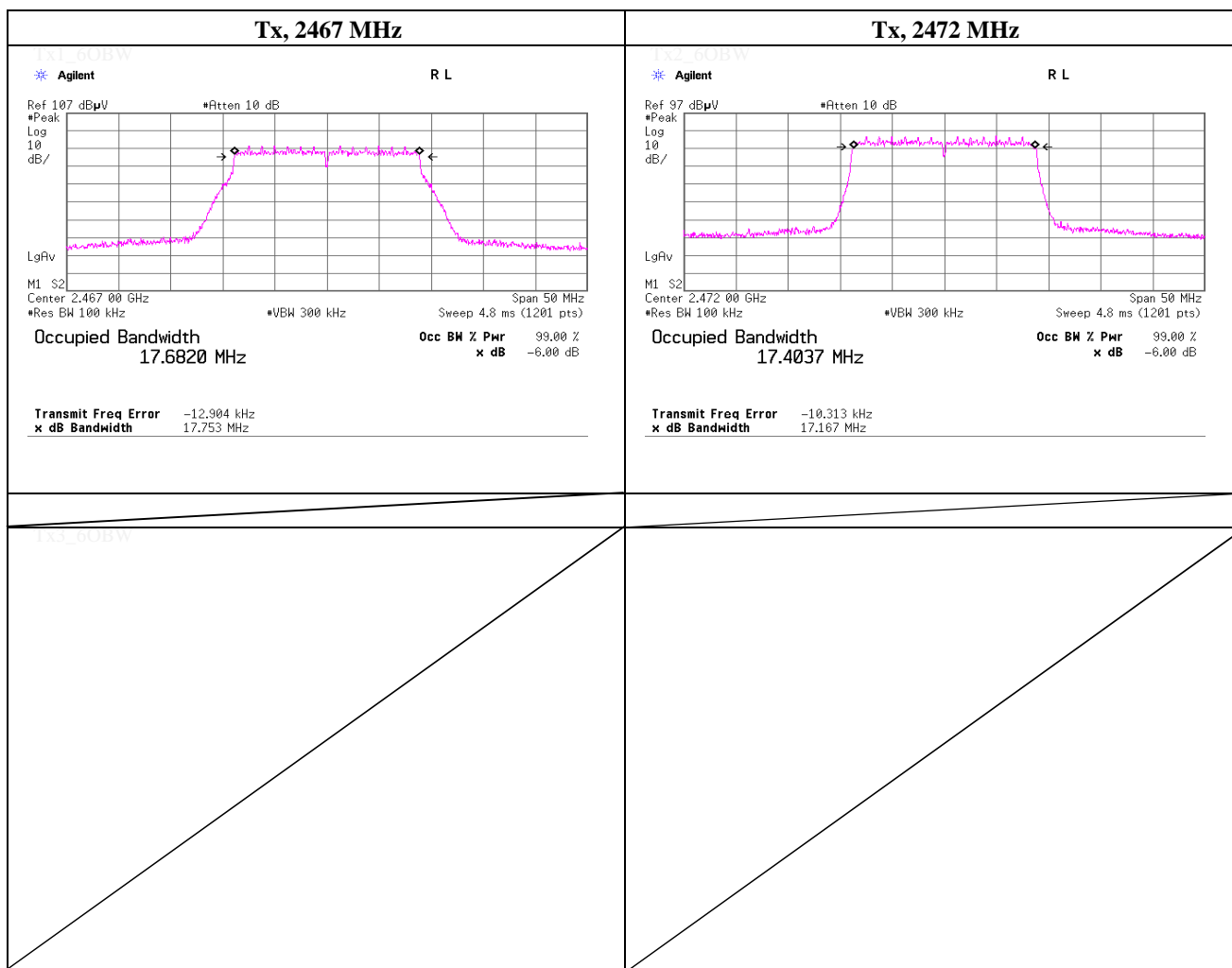

-6 dB Bandwidth

Test place	UL Japan, Inc. Shonan EMC Lab.	No.1 Measurement Room
Date	March 1, 2019	
Temperature / Humidity	24 deg.C , 52 %RH	
Engineer	Yosuke Ishikawa	
Mode	Tx, IEEE802.11n HT40 (SISO), PN9, worst antenna port 1, worst data mode 6 (MCS)	

Freq. [MHz]	-6 dB Bandwidth [MHz]	Limit [MHz]
2422.0000	36.497	> 0.500
2437.0000	36.490	> 0.500
2452.0000	36.497	> 0.500

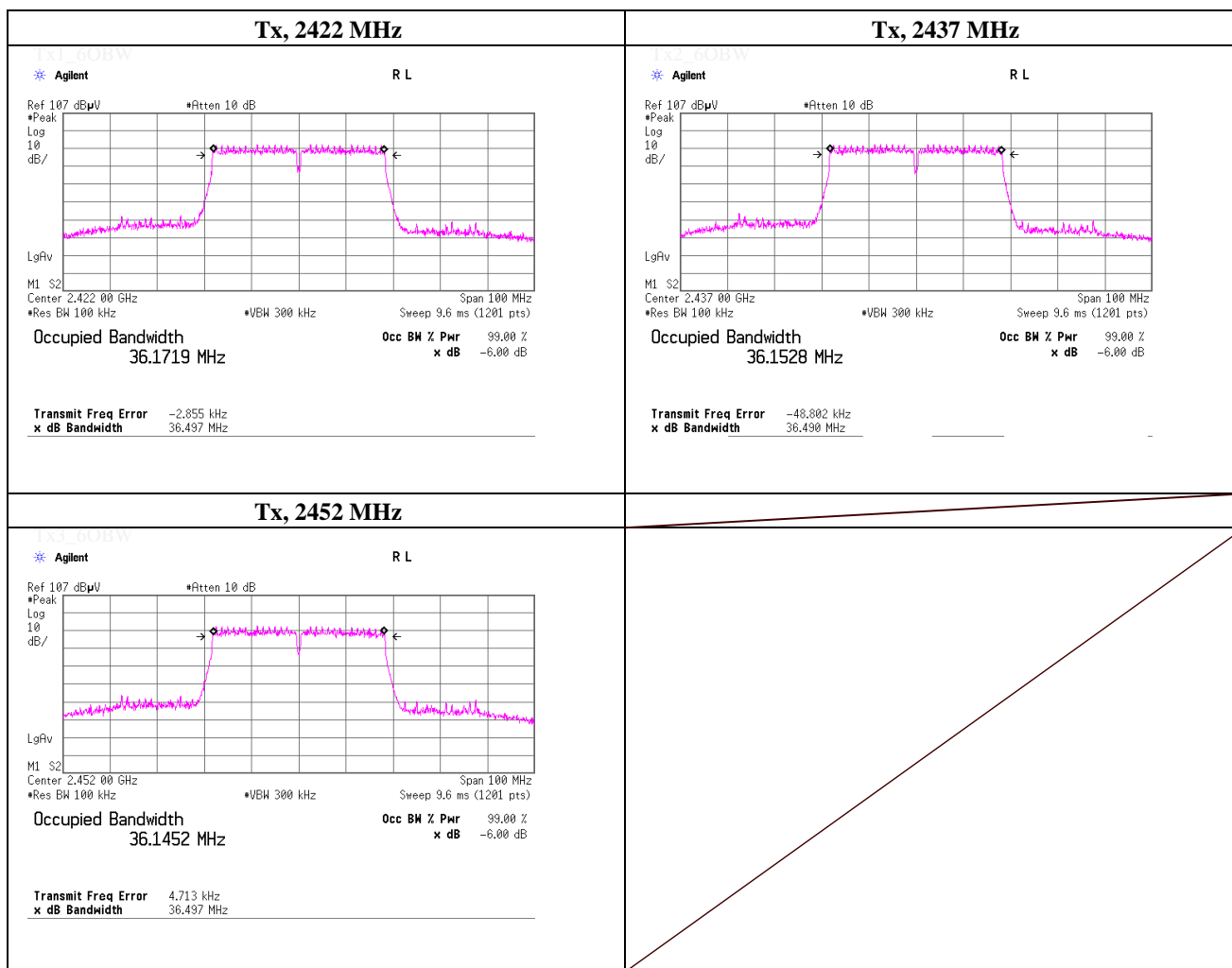

-6 dB Bandwidth

Test place	UL Japan, Inc. Shonan EMC Lab.	No.1 Measurement Room
Date	March 1, 2019	
Temperature / Humidity	24 deg.C , 52 %RH	
Engineer	Yosuke Ishikawa	
Mode	Tx, IEEE802.11n HT40 (SISO), PN9, worst antenna port 1, worst data mode 6 (MCS)	

Freq. [MHz]	-6 dB Bandwidth [MHz]	Limit [MHz]
2457.0000	36.539	> 0.500
2462.0000	36.537	> 0.500

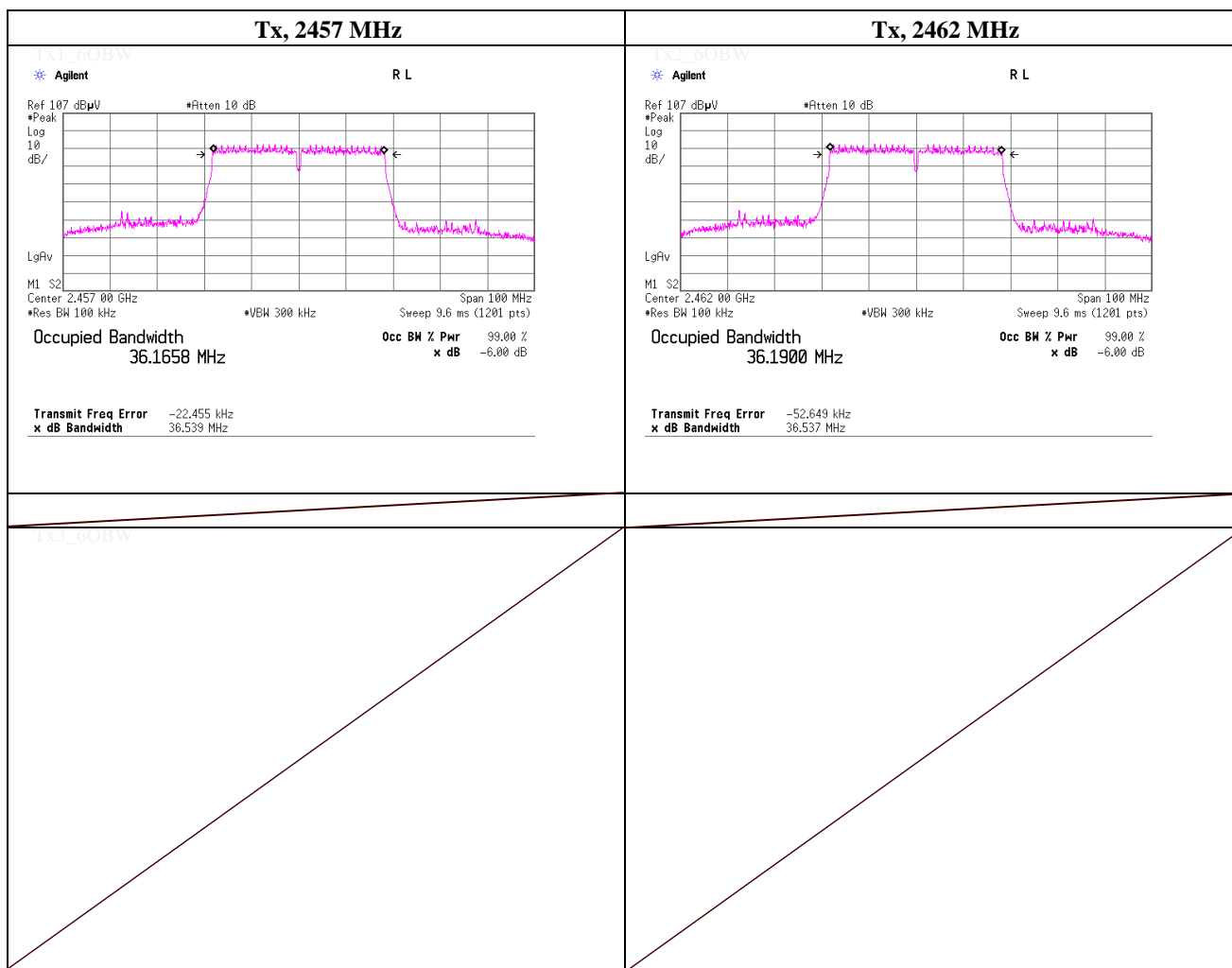

UL Japan, Inc.

Shonan EMC Lab.

1-22-3 Megumigaoka, Hiratsuka-shi, Kanagawa 259-1220 JAPAN

Telephone : +81 463 50 6400

Facsimile : +81 463 50 6401

-6 dB Bandwidth

Test place	UL Japan, Inc. Shonan EMC Lab.	No.1 Measurement Room
Date	March 1, 2019	
Temperature / Humidity	24 deg.C , 52 %RH	
Engineer	Yosuke Ishikawa	
Mode	Tx, OFDM VHT40 (SISO), PN9, worst antenna port 1, worst data mode 4 (MCS)	

Freq. [MHz]	-6 dB Bandwidth [MHz]	Limit [MHz]
2422.0000	36.527	> 0.500
2437.0000	36.465	> 0.500
2452.0000	36.478	> 0.500

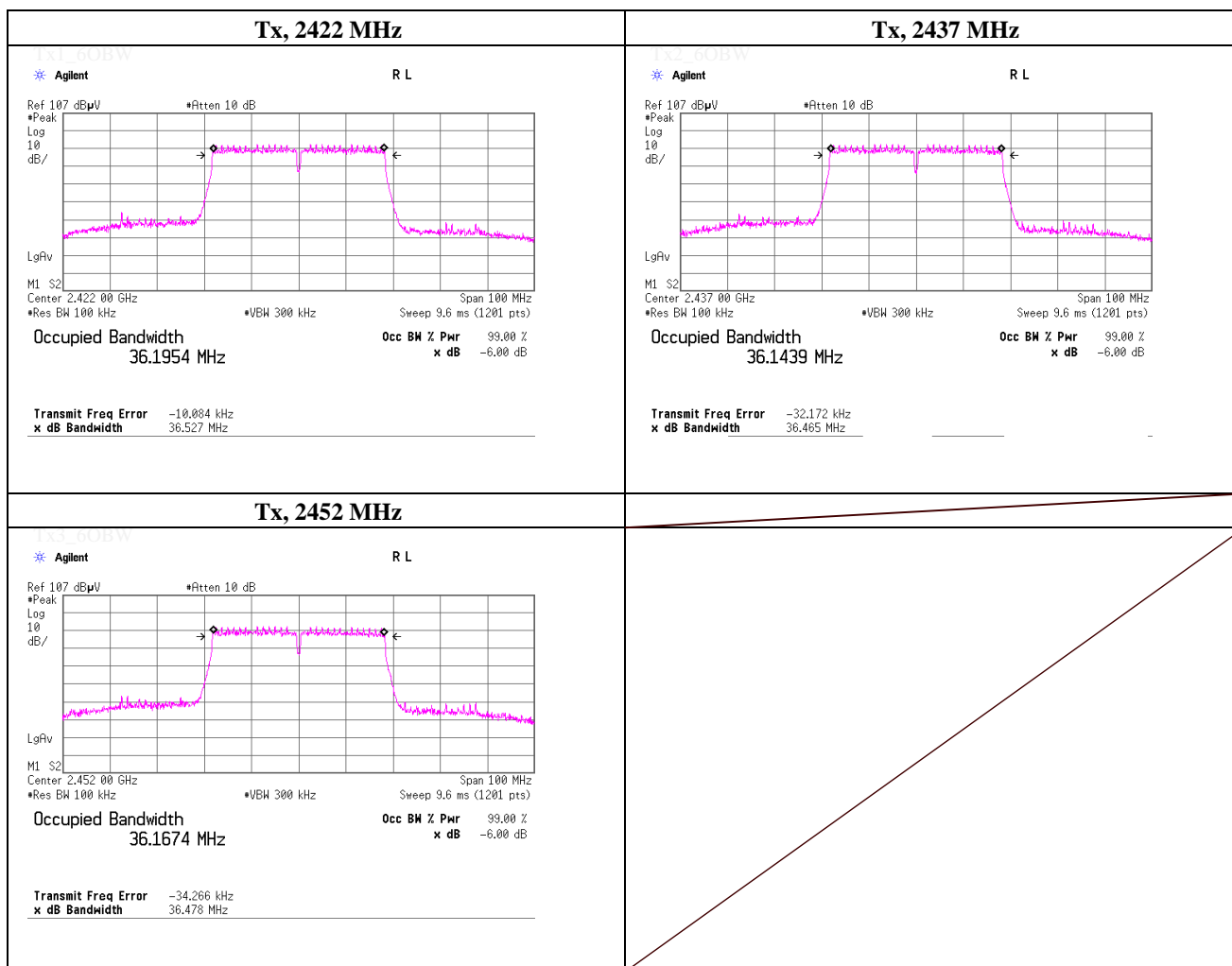

-6 dB Bandwidth

Test place	UL Japan, Inc. Shonan EMC Lab.	No.1 Measurement Room
Date	March 1, 2019	
Temperature / Humidity	24 deg.C , 52 %RH	
Engineer	Yosuke Ishikawa	
Mode	Tx, OFDM VHT40 (SISO), PN9, worst antenna port 1, worst data mode 4 (MCS)	

Freq. [MHz]	-6 dB Bandwidth [MHz]	Limit [MHz]
2457.0000	36.446	> 0.500
2462.0000	36.541	> 0.500

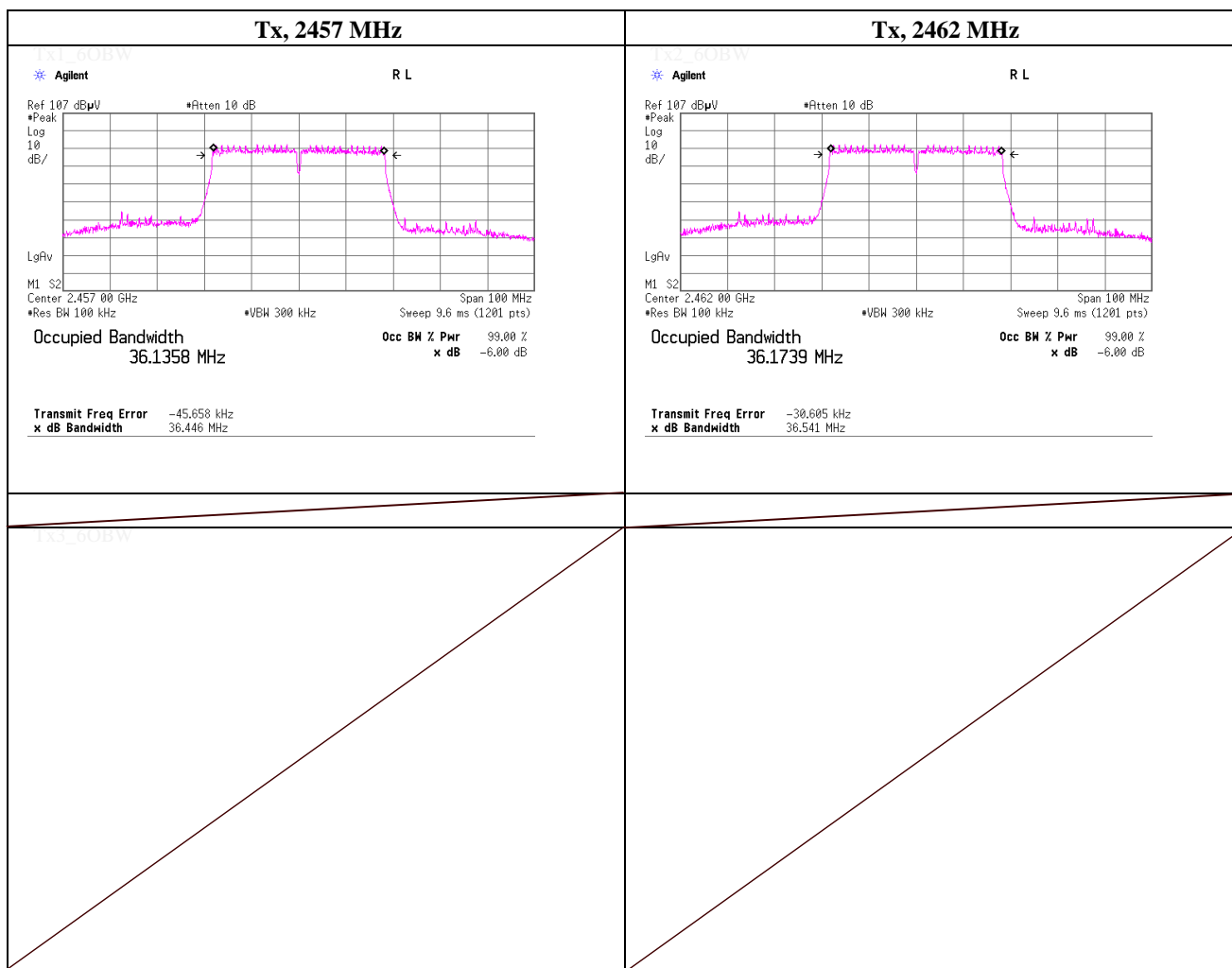

-6 dB Bandwidth

Test place	UL Japan, Inc. Shonan EMC Lab.	No.1 Measurement Room
Date	March 5, 2019	
Temperature / Humidity	23 deg.C , 53 %RH	
Engineer	Kazutaka Takeyama	
Mode	Tx, IEEE802.11n HT40 (MIMO), PN9, antenna port 1, worst data mode 11 (MCS)	

Freq. [MHz]	-6 dB Bandwidth [MHz]	Limit [MHz]
2422.0000	36.506	> 0.500
2437.0000	36.502	> 0.500
2452.0000	36.497	> 0.500

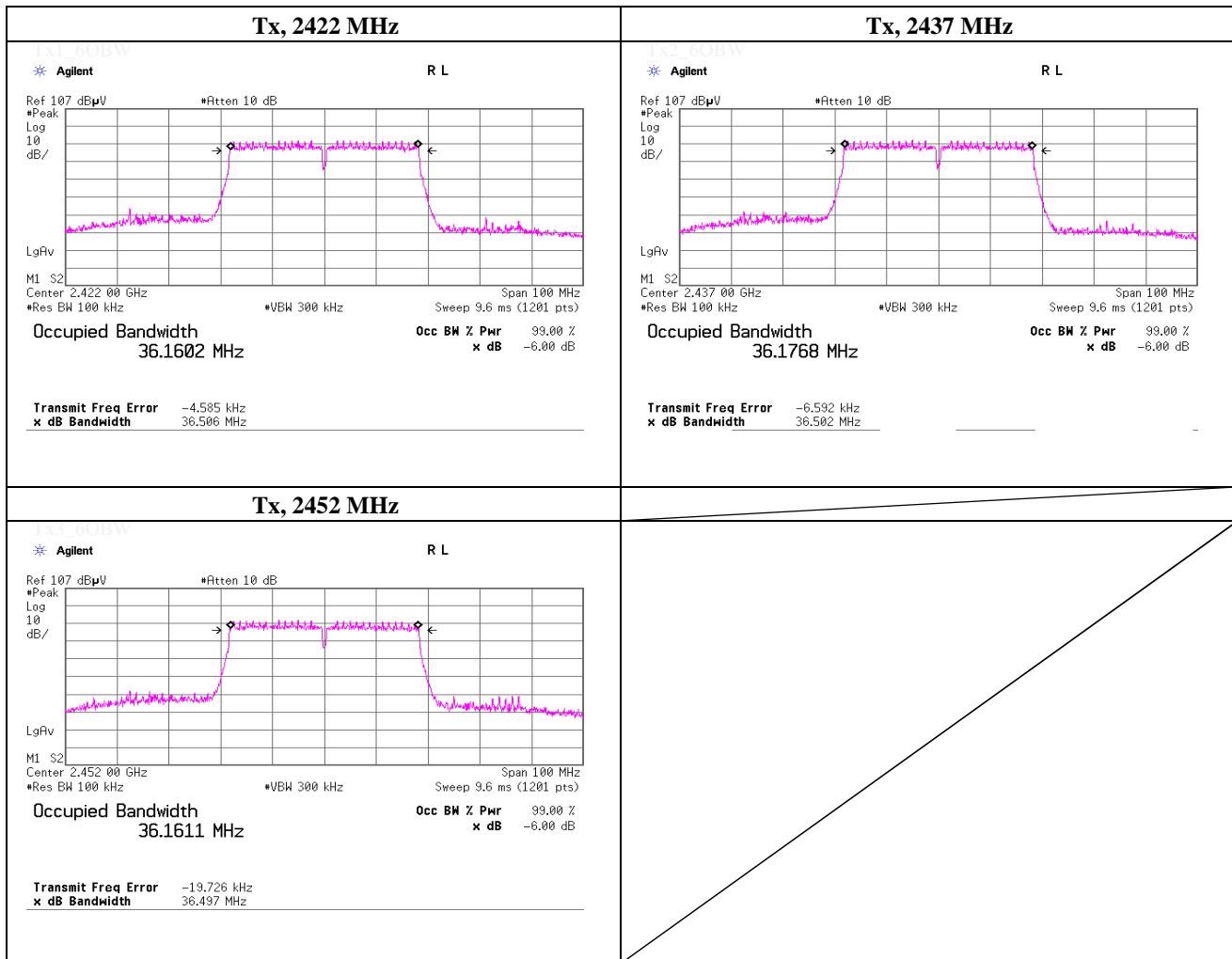

-6 dB Bandwidth

Test place	UL Japan, Inc. Shonan EMC Lab.	No.1 Measurement Room
Date	March 5, 2019	
Temperature / Humidity	23 deg.C , 53 %RH	
Engineer	Kazutaka Takeyama	
Mode	Tx, IEEE802.11n HT40 (MIMO), PN9, antenna port 1, worst data mode 11 (MCS)	

Freq. [MHz]	-6 dB Bandwidth [MHz]	Limit [MHz]
2457.0000	36.489	> 0.500
2462.0000	36.459	> 0.500

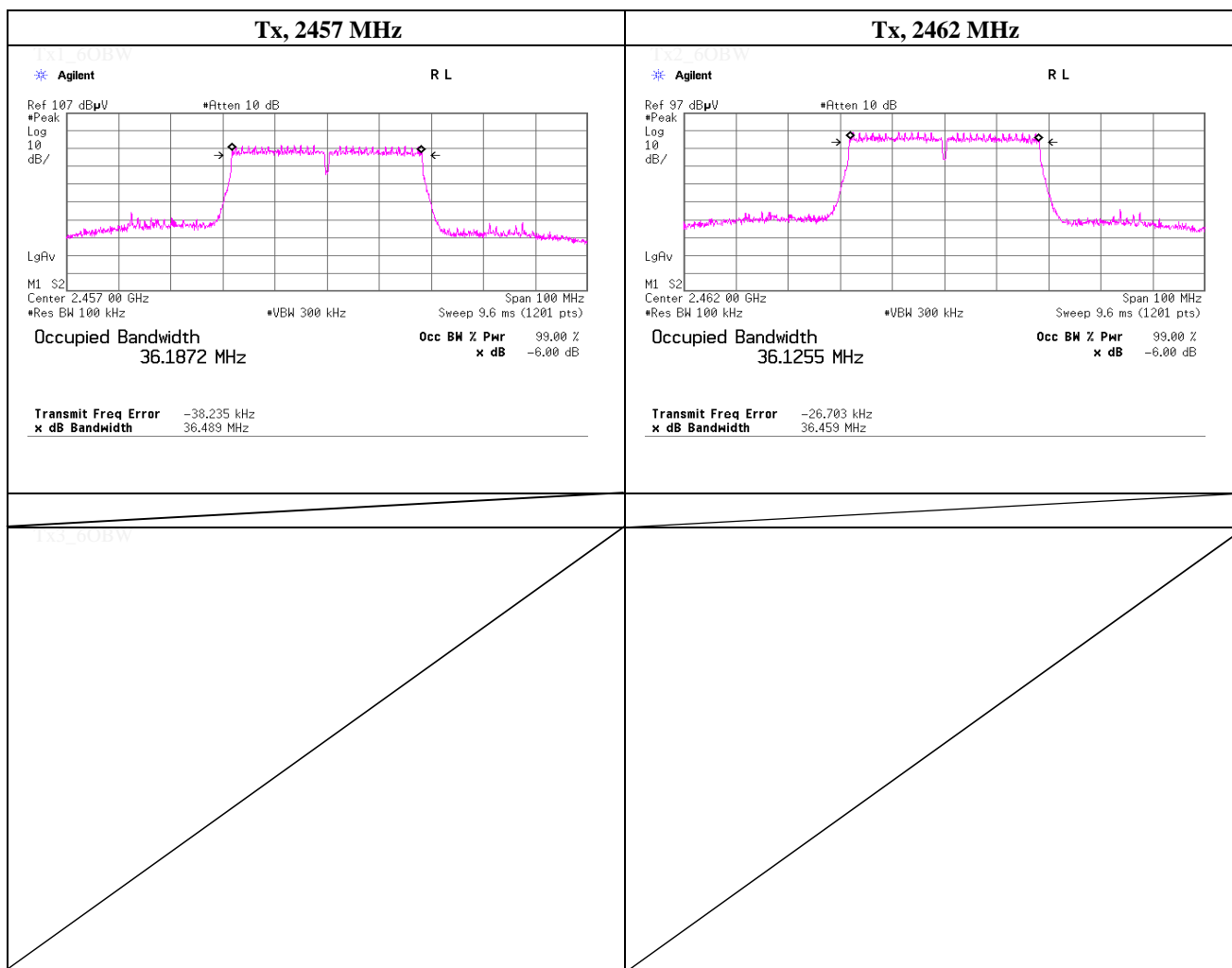

-6 dB Bandwidth

Test place	UL Japan, Inc. Shonan EMC Lab.	No.1 Measurement Room
Date	March 5, 2019	
Temperature / Humidity	23 deg.C , 53 %RH	
Engineer	Kazutaka Takeyama	
Mode	Tx, OFDM VHT40 (MIMO), PN9, antenna port 1, worst data mode 3 (MCS)	

Freq. [MHz]	-6 dB Bandwidth [MHz]	Limit [MHz]
2422.0000	36.512	> 0.500
2437.0000	36.505	> 0.500
2452.0000	36.465	> 0.500

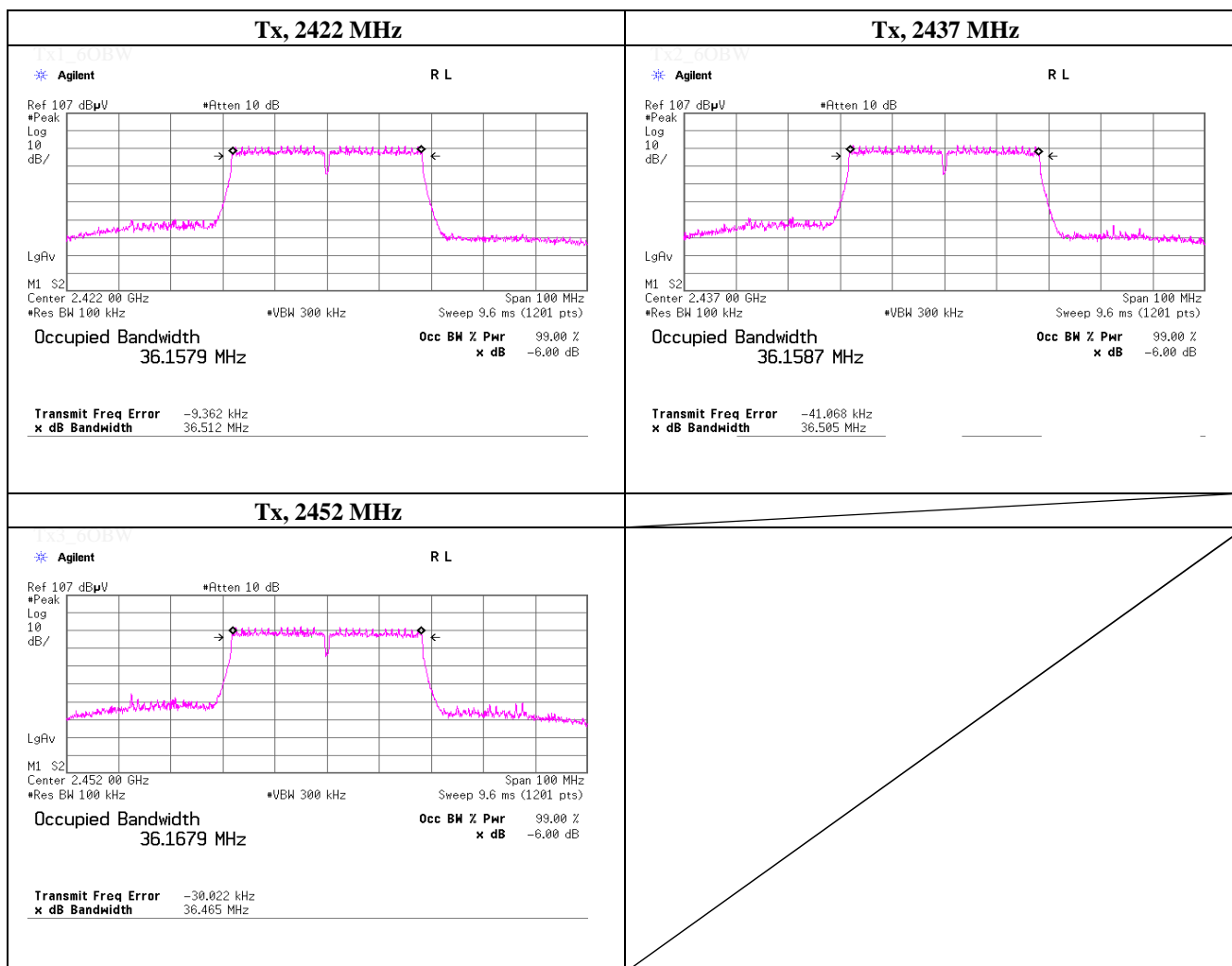

-6 dB Bandwidth

Test place	UL Japan, Inc. Shonan EMC Lab.	No.1 Measurement Room
Date	March 5, 2019	
Temperature / Humidity	23 deg.C , 53 %RH	
Engineer	Kazutaka Takeyama	
Mode	Tx, OFDM VHT40 (MIMO), PN9, antenna port 1, worst data mode 3 (MCS)	

Freq. [MHz]	-6 dB Bandwidth [MHz]	Limit [MHz]
2457.0000	36.436	> 0.500
2462.0000	36.407	> 0.500

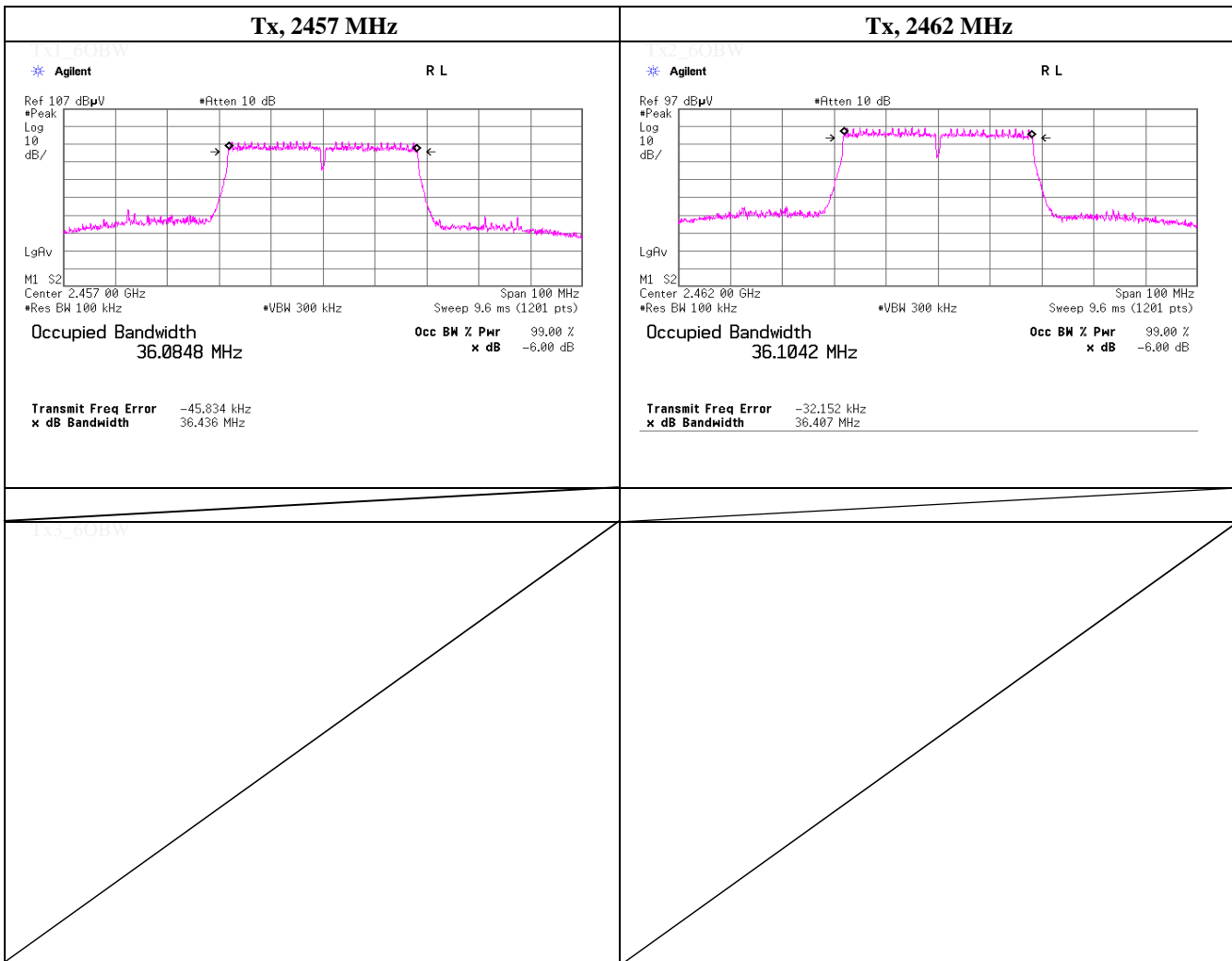

99 % Occupied Bandwidth

Test place	UL Japan, Inc. Shonan EMC Lab.	No.1 Measurement Room
Date	March 11, 2019	
Temperature / Humidity	24 deg.C , 55 %RH	
Engineer	Yosuke Ishikawa	
Mode	Tx, Bluetooth Low Energy, PN9	

Freq. [MHz]	99 % Occupied Bandwidth [kHz]
2402.0000	1064.6
2440.0000	1063.7
2480.0000	1064.5

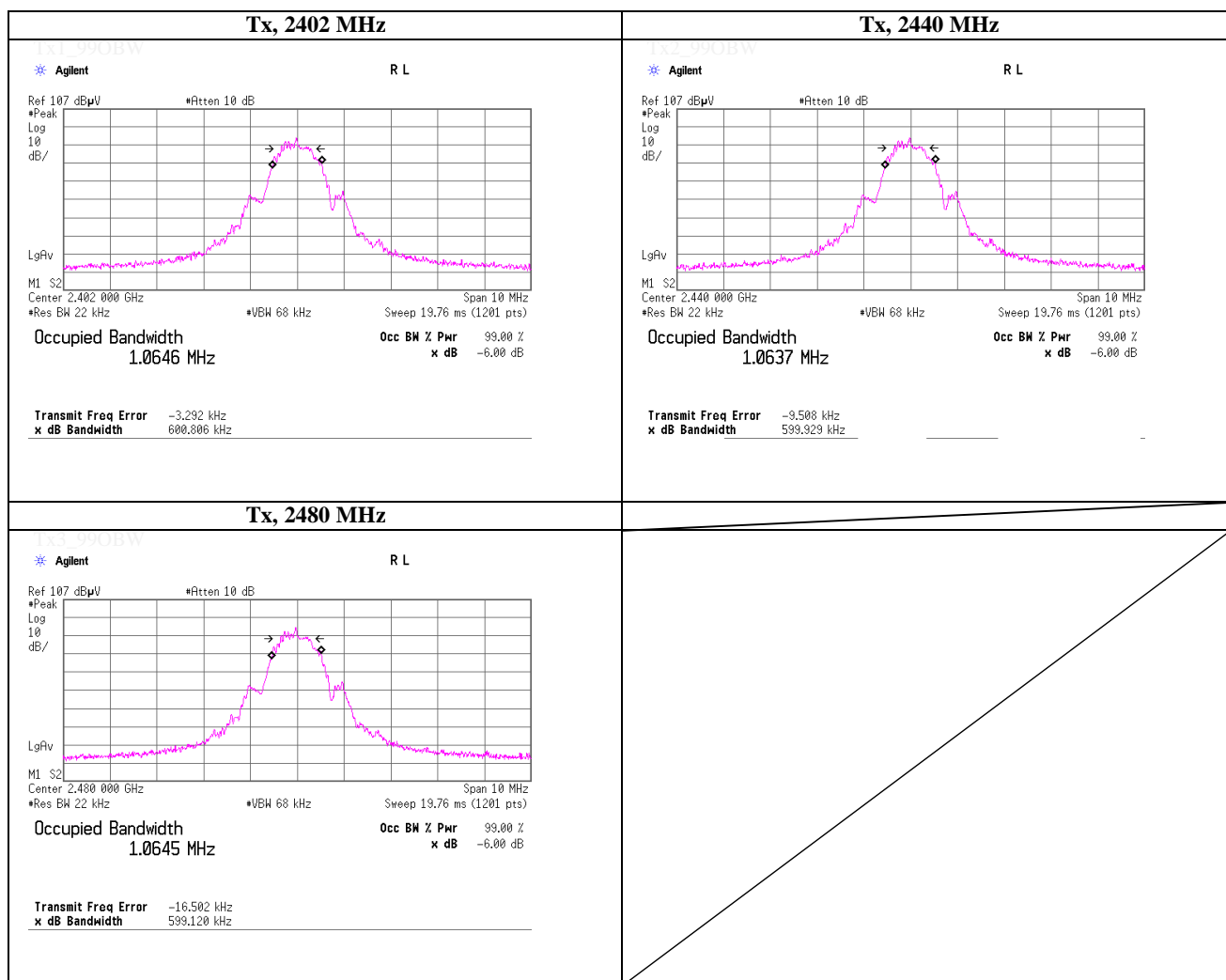

99 % Occupied Bandwidth

Test place	UL Japan, Inc. Shonan EMC Lab.	No.1 Measurement Room
Date	February 28, 2019	
Temperature / Humidity	23 deg.C , 55 %RH	
Engineer	Yosuke Ishikawa	
Mode	Tx, IEEE802.11b, PN9, worst antenna port 1, worst data mode 11 Mbps	

Freq. [MHz]	99 % Occupied Bandwidth [kHz]
2412.0000	11574.0
2437.0000	11573.1
2462.0000	11508.6

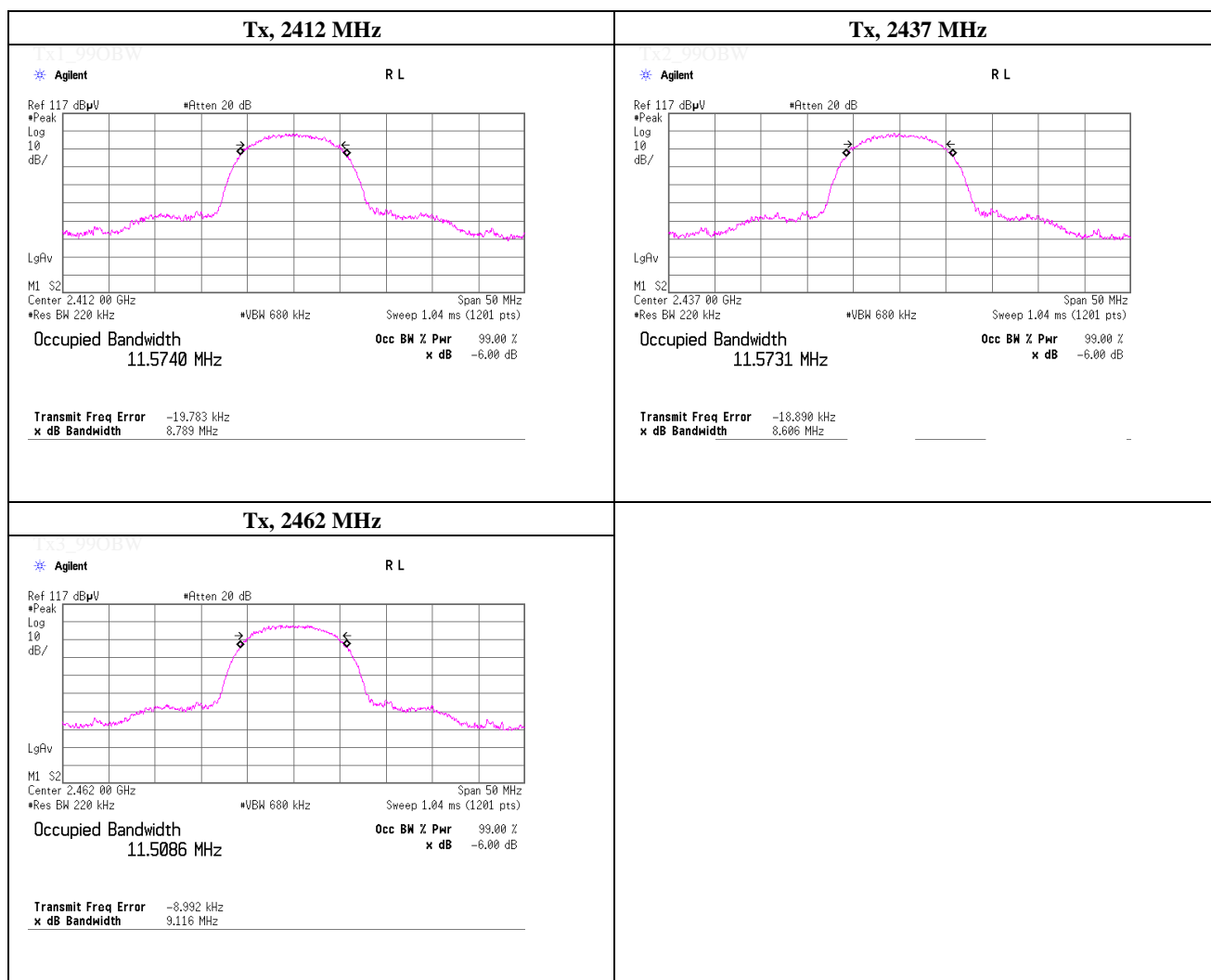

99 % Occupied Bandwidth

Test place	UL Japan, Inc. Shonan EMC Lab.	No.1 Measurement Room
Date	February 28, 2019	
Temperature / Humidity	23 deg.C , 55 %RH	
Engineer	Yosuke Ishikawa	
Mode	Tx, IEEE802.11b, PN9, worst antenna port 1, worst data mode 11 Mbps	

Freq. [MHz]	99 % Occupied Bandwidth [kHz]
2467.0000	11572.9
2472.0000	11511.6

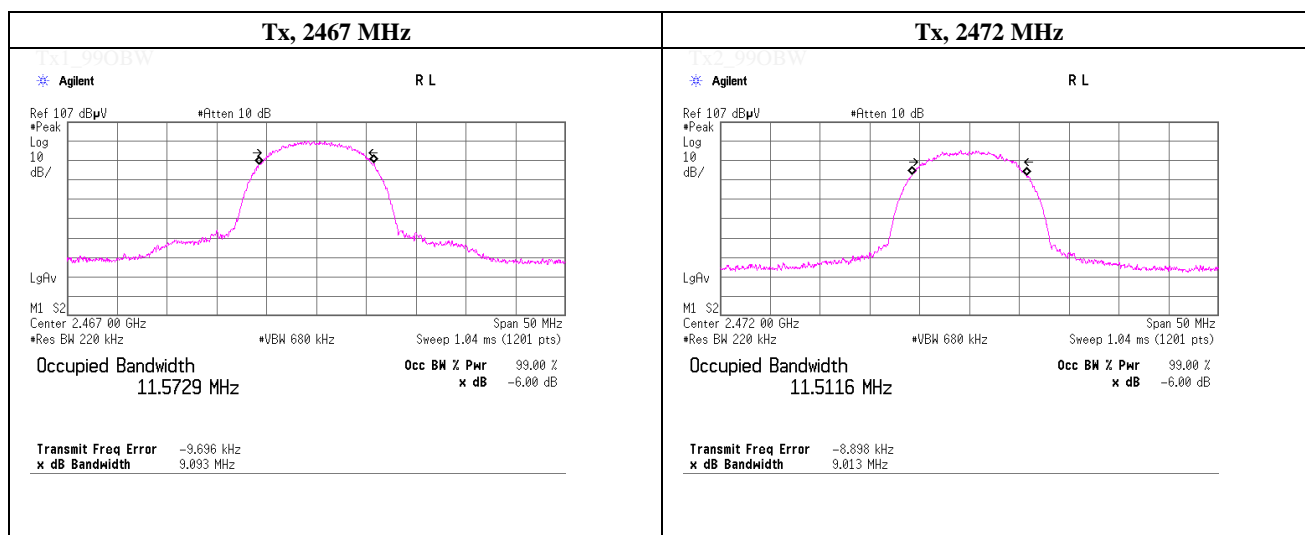

Tx3_99OBW

UL Japan, Inc.

Shonan EMC Lab.

1-22-3 Megumigaoka, Hiratsuka-shi, Kanagawa 259-1220 JAPAN

Telephone : +81 463 50 6400

Facsimile : +81 463 50 6401

99 % Occupied Bandwidth

Test place	UL Japan, Inc. Shonan EMC Lab.	No.1 Measurement Room
Date	February 28, 2019	
Temperature / Humidity	23 deg.C , 55 %RH	
Engineer	Yosuke Ishikawa	
Mode	Tx, IEEE802.11g, PN9, worst antenna port 1, worst data mode 48 Mbps	

Freq. [MHz]	99 % Occupied Bandwidth [kHz]
2412.0000	16898.1

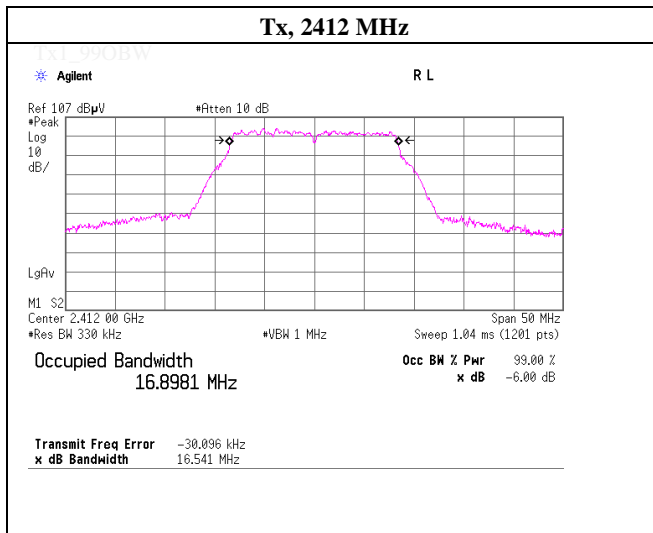

Tx2_99OBW

Tx3_99OBW

UL Japan, Inc.

Shonan EMC Lab.

1-22-3 Megumigaoka, Hiratsuka-shi, Kanagawa 259-1220 JAPAN

Telephone : +81 463 50 6400

Facsimile : +81 463 50 6401

99 % Occupied Bandwidth

Test place	UL Japan, Inc. Shonan EMC Lab.	No.1 Measurement Room
Date	February 28, 2019	
Temperature / Humidity	23 deg.C , 55 %RH	
Engineer	Yosuke Ishikawa	
Mode	Tx, IEEE802.11g, PN9, worst antenna port 1, worst data mode 48 Mbps	

Freq. [MHz]	99 % Occupied Bandwidth [kHz]
2417.0000	16902.5
2437.0000	16901.7
2462.0000	16951.8

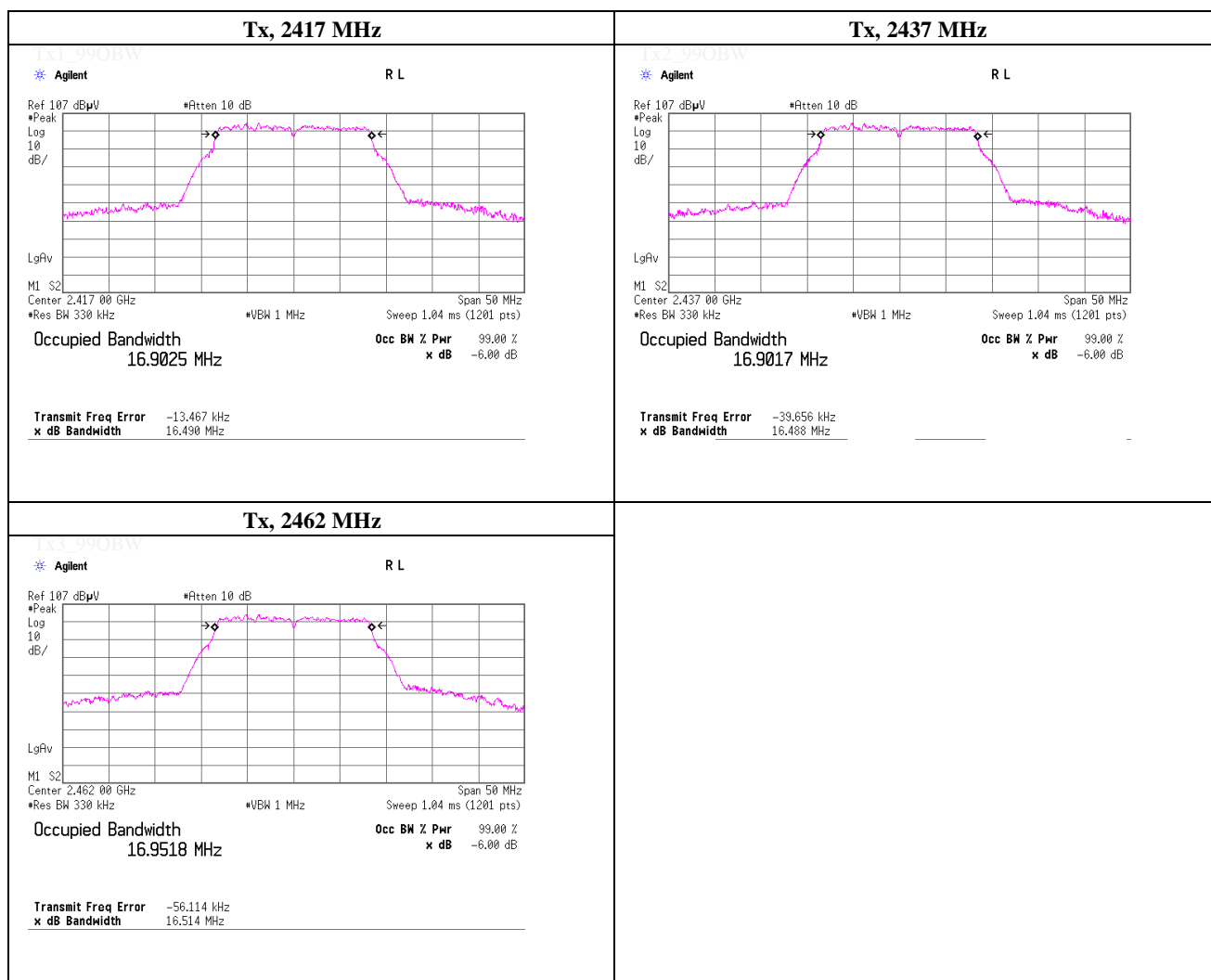

99 % Occupied Bandwidth

Test place	UL Japan, Inc. Shonan EMC Lab.	No.1 Measurement Room
Date	February 28, 2019	
Temperature / Humidity	23 deg.C , 55 %RH	
Engineer	Yosuke Ishikawa	
Mode	Tx, IEEE802.11g, PN9, worst antenna port 1, worst data mode 48 Mbps	

Freq. [MHz]	99 % Occupied Bandwidth [kHz]
2467.0000	16935.9
2472.0000	16620.9

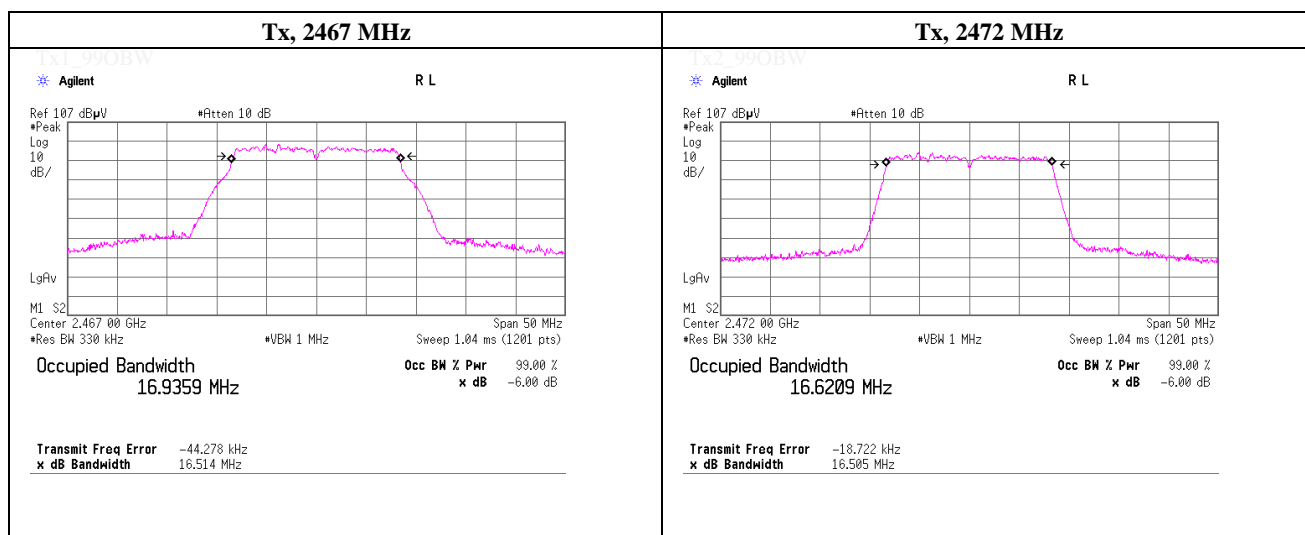

Tx3_990BW

99 % Occupied Bandwidth

Test place	UL Japan, Inc. Shonan EMC Lab.	No.1 Measurement Room
Date	February 28, 2019	
Temperature / Humidity	23 deg.C , 55 %RH	
Engineer	Yosuke Ishikawa	
Mode	Tx, IEEE802.11n HT20 (SISO), PN9, worst antenna port 1, worst data mode 4 (MCS)	

Freq. [MHz]	99 % Occupied Bandwidth [kHz]
2412.0000	18118.2

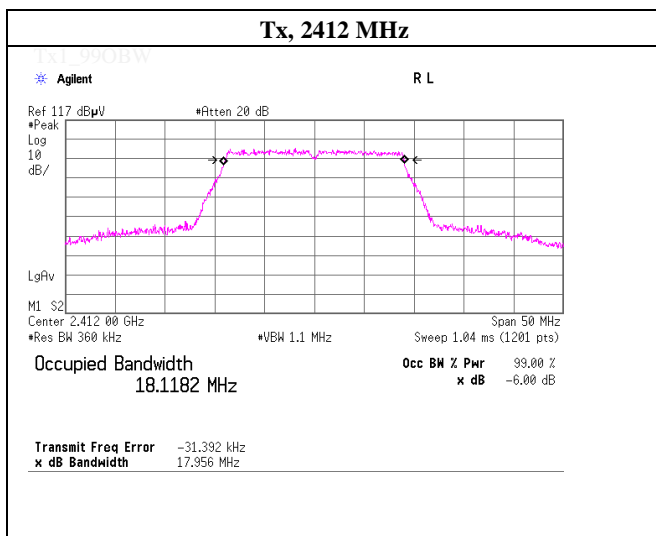

Tx2_99OBW

Tx3_99OBW

99 % Occupied Bandwidth

Test place	UL Japan, Inc. Shonan EMC Lab.	No.1 Measurement Room
Date	February 28, 2019	
Temperature / Humidity	23 deg.C , 55 %RH	
Engineer	Yosuke Ishikawa	
Mode	Tx, IEEE802.11n HT20 (SISO), PN9, worst antenna port 1, worst data mode 3 (MCS)	

Freq. [MHz]	99 % Occupied Bandwidth [kHz]
2417.0000	18104.4
2437.0000	18139.1
2462.0000	18101.2

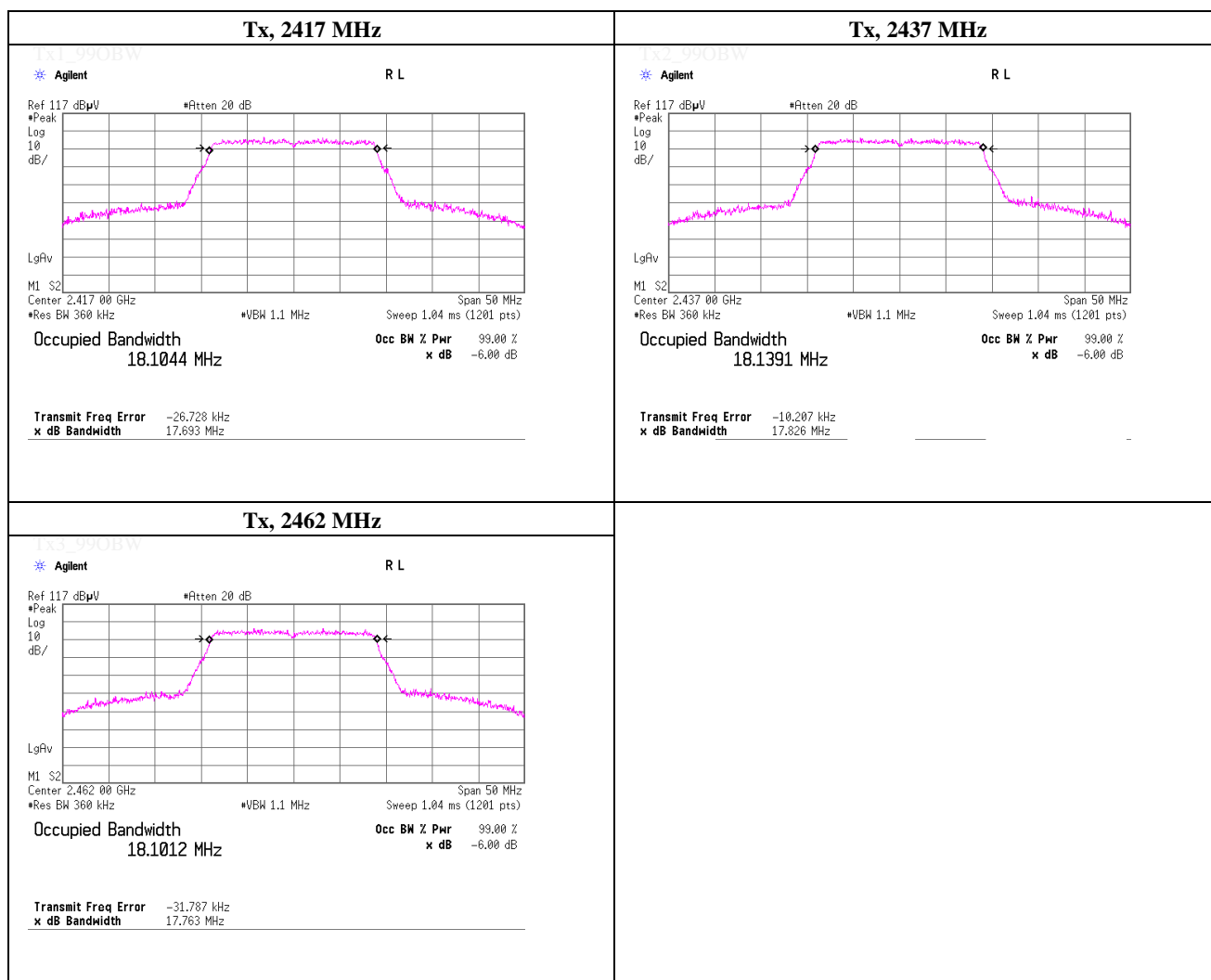

99 % Occupied Bandwidth

Test place	UL Japan, Inc. Shonan EMC Lab.	No.1 Measurement Room
Date	February 28, 2019	
Temperature / Humidity	23 deg.C , 55 %RH	
Engineer	Yosuke Ishikawa	
Mode	Tx, IEEE802.11n HT20 (SISO), PN9, worst antenna port 1, worst data mode 3 (MCS)	

Freq. [MHz]	99 % Occupied Bandwidth [kHz]
2467.0000	18064.6
2472.0000	17455.9

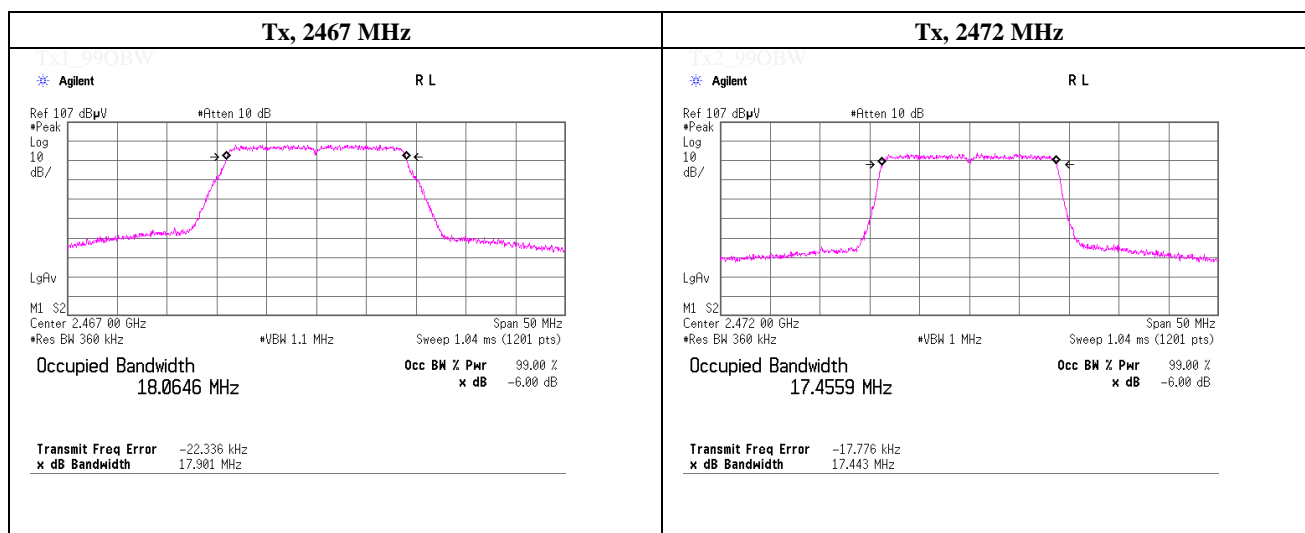

Tx3_99OBW

99 % Occupied Bandwidth

Test place	UL Japan, Inc. Shonan EMC Lab.	No.1 Measurement Room
Date	February 28, 2019	
Temperature / Humidity	23 deg.C , 55 %RH	
Engineer	Yosuke Ishikawa	
Mode	Tx, OFDM VHT20 (SISO), PN9, worst antenna port 1, worst data mode 4 (MCS)	

Freq. [MHz]	99 % Occupied Bandwidth [kHz]
2412.0000	18104.4

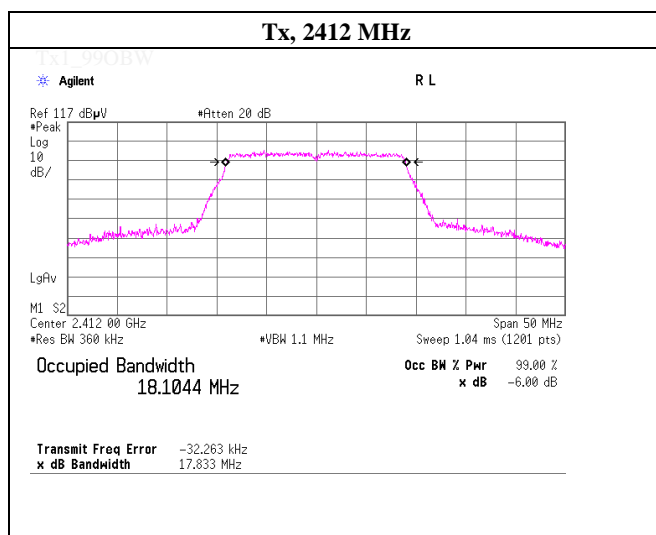

Tx2_99OBW

Tx3_99OBW

99 % Occupied Bandwidth

Test place	UL Japan, Inc. Shonan EMC Lab.	No.1 Measurement Room
Date	February 28, 2019	
Temperature / Humidity	23 deg.C , 55 %RH	
Engineer	Yosuke Ishikawa	
Mode	Tx, OFDM VHT20 (SISO), PN9, worst antenna port 1, worst data mode 3 (MCS)	

Freq. [MHz]	99 % Occupied Bandwidth [kHz]
2417.0000	18120.3
2437.0000	18118.7
2462.0000	18181.6

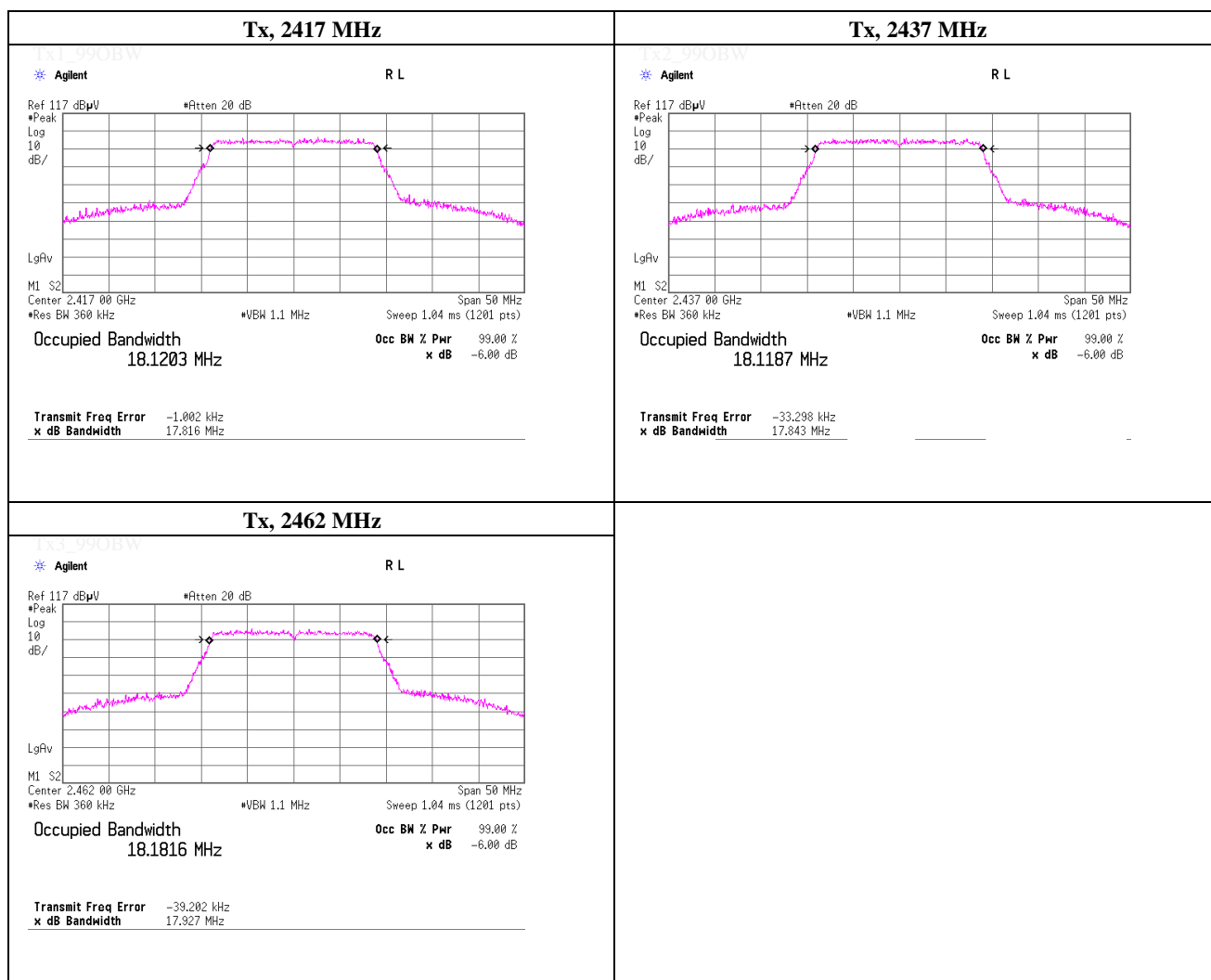

99 % Occupied Bandwidth

Test place	UL Japan, Inc. Shonan EMC Lab.	No.1 Measurement Room
Date	February 28, 2019	
Temperature / Humidity	23 deg.C , 55 %RH	
Engineer	Yosuke Ishikawa	
Mode	Tx, OFDM VHT20 (SISO), PN9, worst antenna port 1, worst data mode 3 (MCS)	

Freq. [MHz]	99 % Occupied Bandwidth [kHz]
2467.0000	18063.4
2472.0000	17461.8

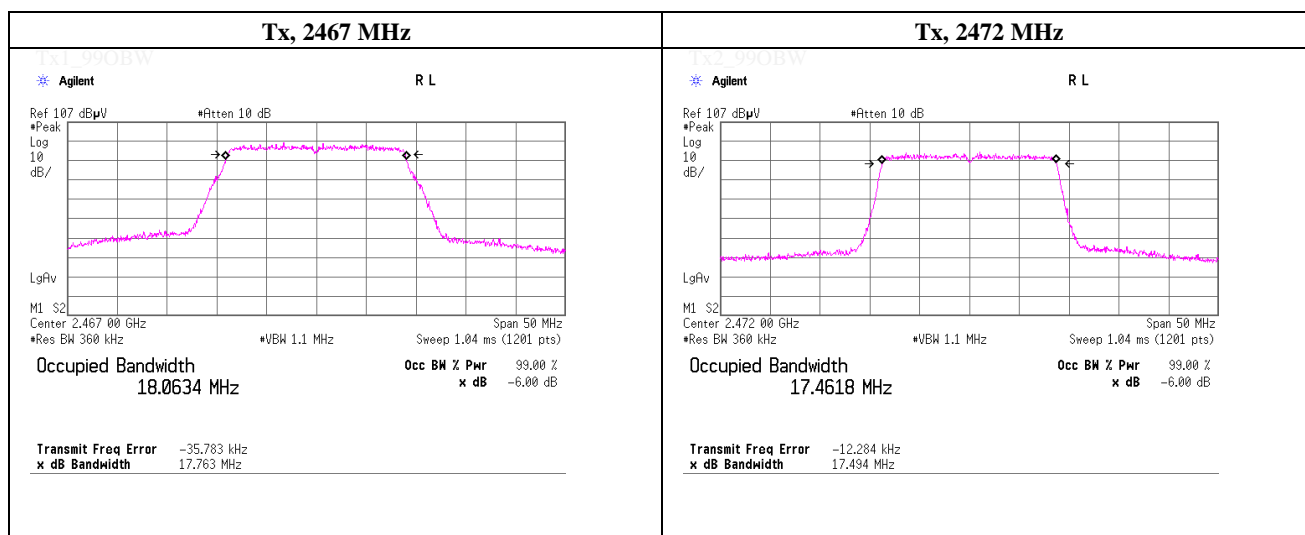

Tx3_99OBW

99 % Occupied Bandwidth

Test place	UL Japan, Inc. Shonan EMC Lab.	No.1 Measurement Room
Date	March 1, 2019	
Temperature / Humidity	24 deg.C , 52 %RH	
Engineer	Yosuke Ishikawa	
Mode	Tx, IEEE802.11n HT20 (MIMO), PN9, antenna port 0, worst data mode 14 (MCS)	

Freq. [MHz]	99 % Occupied Bandwidth [kHz]
2412.0000	18086.3

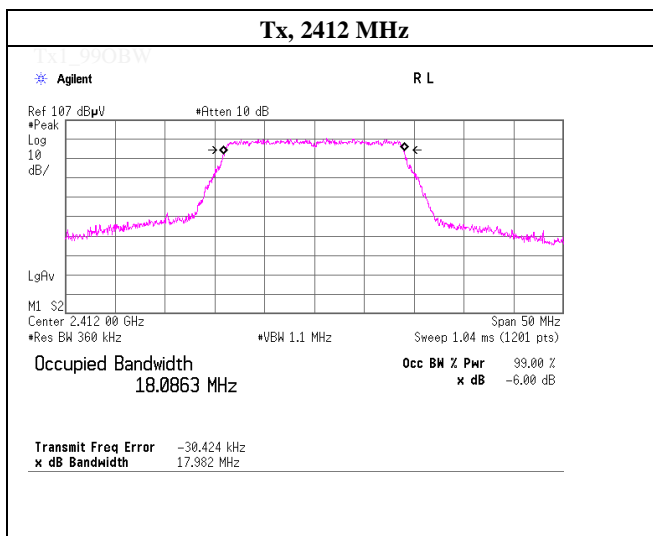

Tx2_99OBW

Tx3_99OBW

99 % Occupied Bandwidth

Test place	UL Japan, Inc. Shonan EMC Lab.	No.1 Measurement Room
Date	March 1, 2019	
Temperature / Humidity	24 deg.C , 52 %RH	
Engineer	Yosuke Ishikawa	
Mode	Tx, IEEE802.11n HT20 (MIMO), PN9, antenna port 1, worst data mode 14 (MCS)	

Freq. [MHz]	99 % Occupied Bandwidth [kHz]
2417.0000	18102.3
2437.0000	18066.0
2462.0000	18058.2

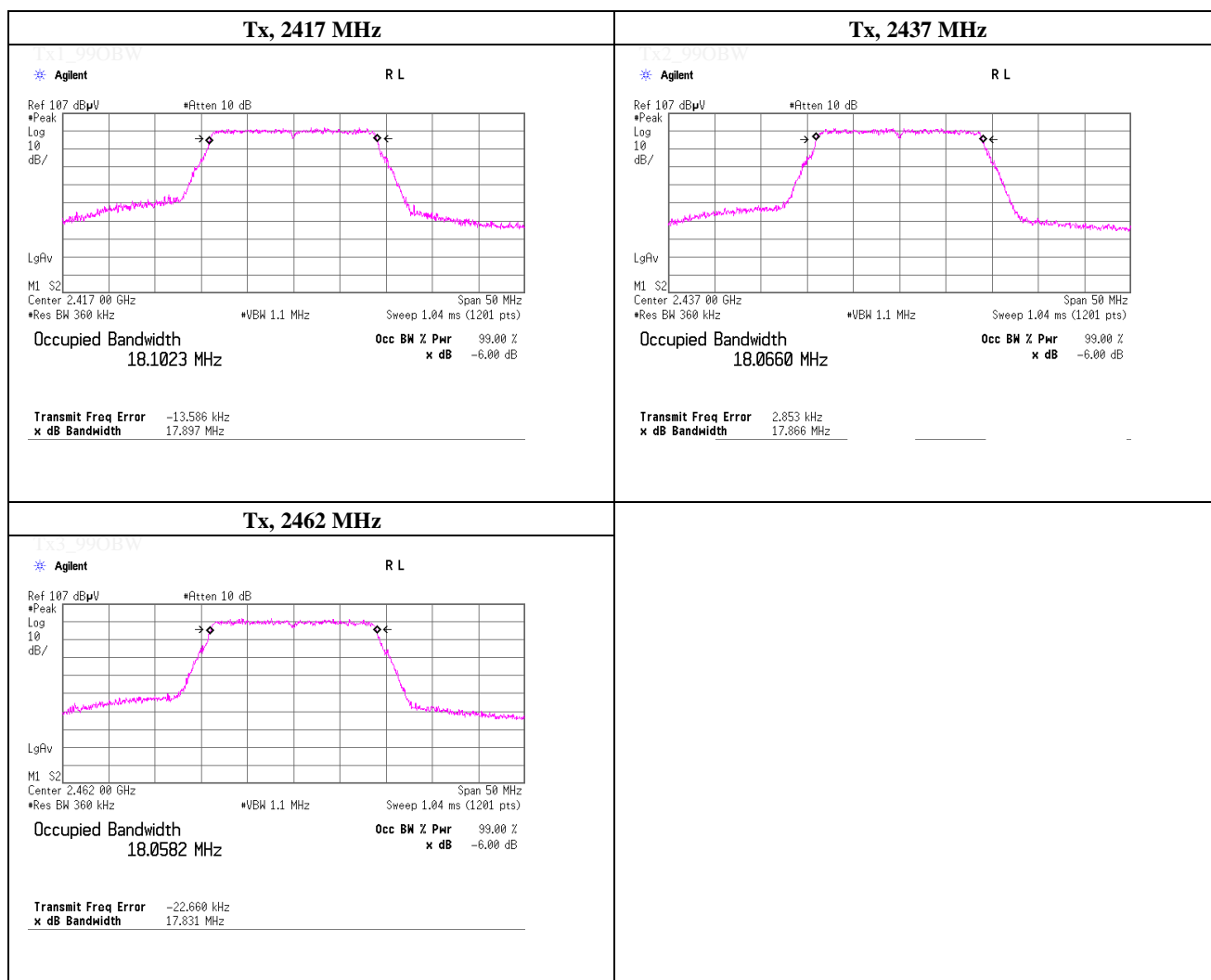

99 % Occupied Bandwidth

Test place	UL Japan, Inc. Shonan EMC Lab.	No.1 Measurement Room
Date	March 1, 2019	
Temperature / Humidity	24 deg.C , 52 %RH	
Engineer	Yosuke Ishikawa	
Mode	Tx, IEEE802.11n HT20 (MIMO), PN9, antenna port 1, worst data mode 14 (MCS)	

Freq. [MHz]	99 % Occupied Bandwidth [kHz]
2467.0000	18057.3
2472.0000	17493.1

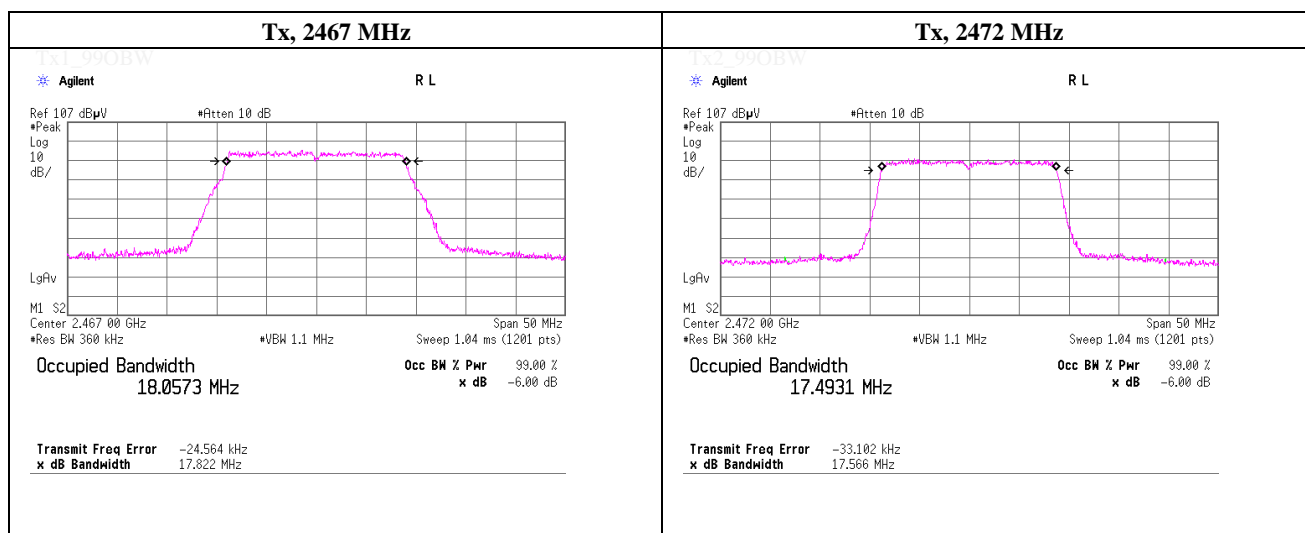

Tx3_99OBW

99 % Occupied Bandwidth

Test place	UL Japan, Inc. Shonan EMC Lab.	No.1 Measurement Room
Date	March 5, 2019	
Temperature / Humidity	23 deg.C , 53 %RH	
Engineer	Kazutaka Takeyama	
Mode	Tx, OFDM VHT20 (MIMO), PN9, antenna port 1, worst data mode 3 (MCS)	

Freq. [MHz]	99 % Occupied Bandwidth [kHz]
2412.0000	18016.2

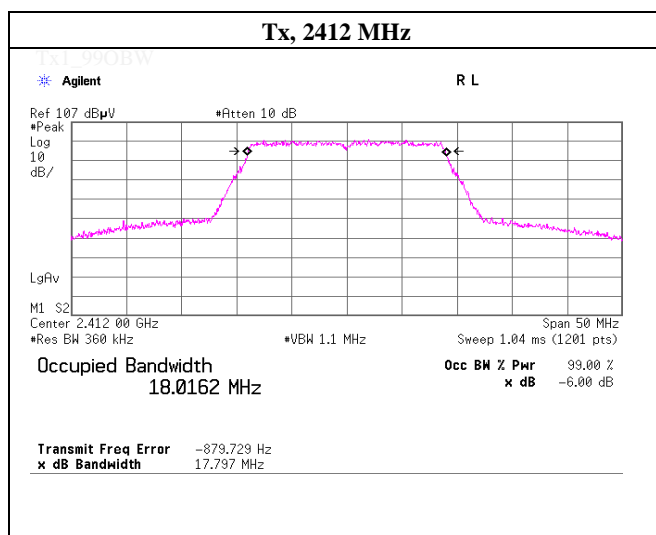

Tx2_99OBW

Tx3_99OBW

99 % Occupied Bandwidth

Test place	UL Japan, Inc. Shonan EMC Lab.	No.1 Measurement Room
Date	March 5, 2019	
Temperature / Humidity	23 deg.C , 53 %RH	
Engineer	Kazutaka Takeyama	
Mode	Tx, OFDM VHT20 (MIMO), PN9, antenna port 1, worst data mode 3 (MCS)	

Freq. [MHz]	99 % Occupied Bandwidth [kHz]
2417.0000	18078.7
2437.0000	18046.6
2462.0000	18057.3

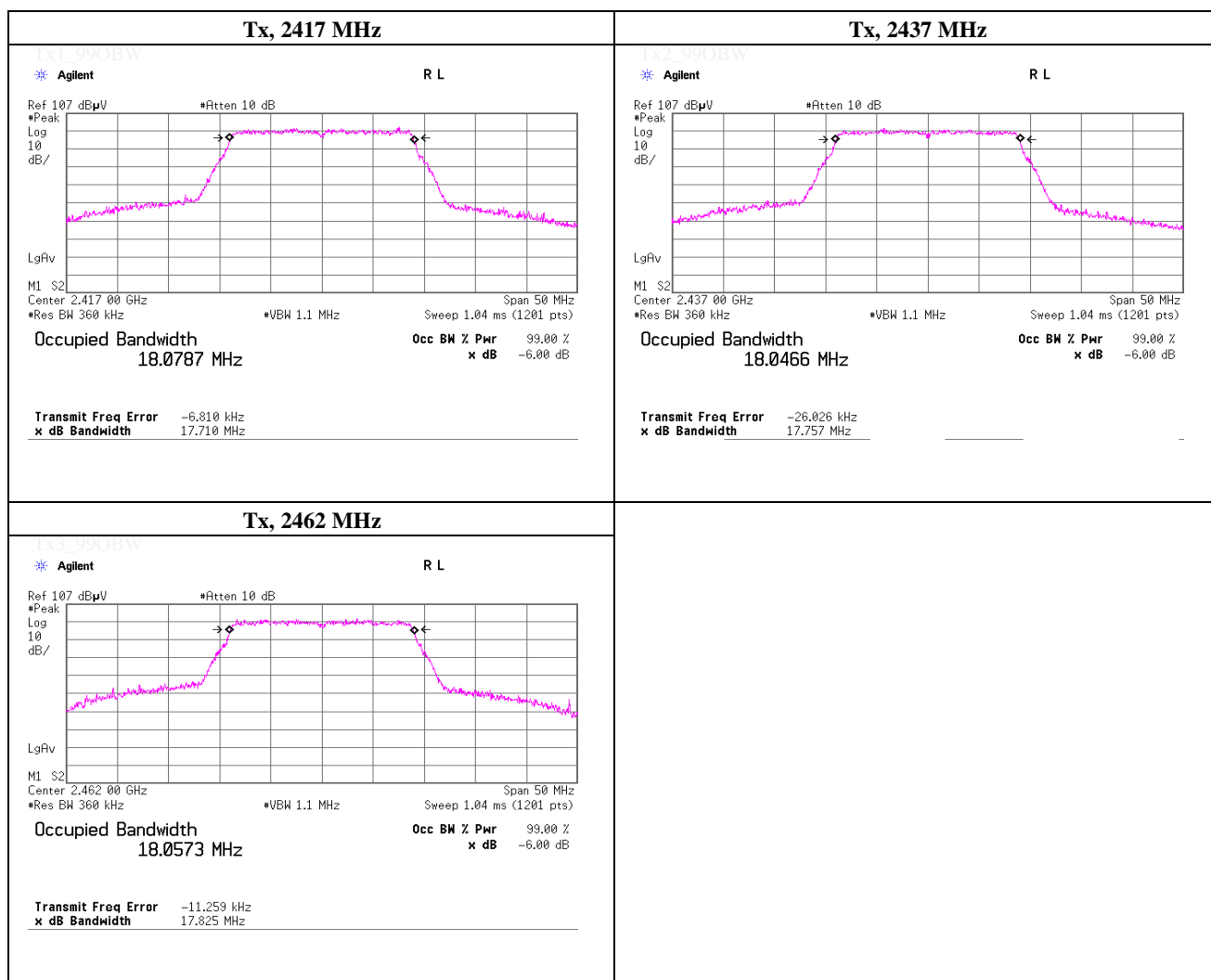

UL Japan, Inc.
Shonan EMC Lab.
 1-22-3 Megumigaoka, Hiratsuka-shi, Kanagawa 259-1220 JAPAN
 Telephone : +81 463 50 6400
 Facsimile : +81 463 50 6401

99 % Occupied Bandwidth

Test place	UL Japan, Inc. Shonan EMC Lab.	No.1 Measurement Room
Date	March 5, 2019	
Temperature / Humidity	23 deg.C , 53 %RH	
Engineer	Kazutaka Takeyama	
Mode	Tx, OFDM VHT20 (MIMO), PN9, antenna port 1, worst data mode 3 (MCS)	

Freq. [MHz]	99 % Occupied Bandwidth [kHz]
2467.0000	18077.0
2472.0000	17449.6

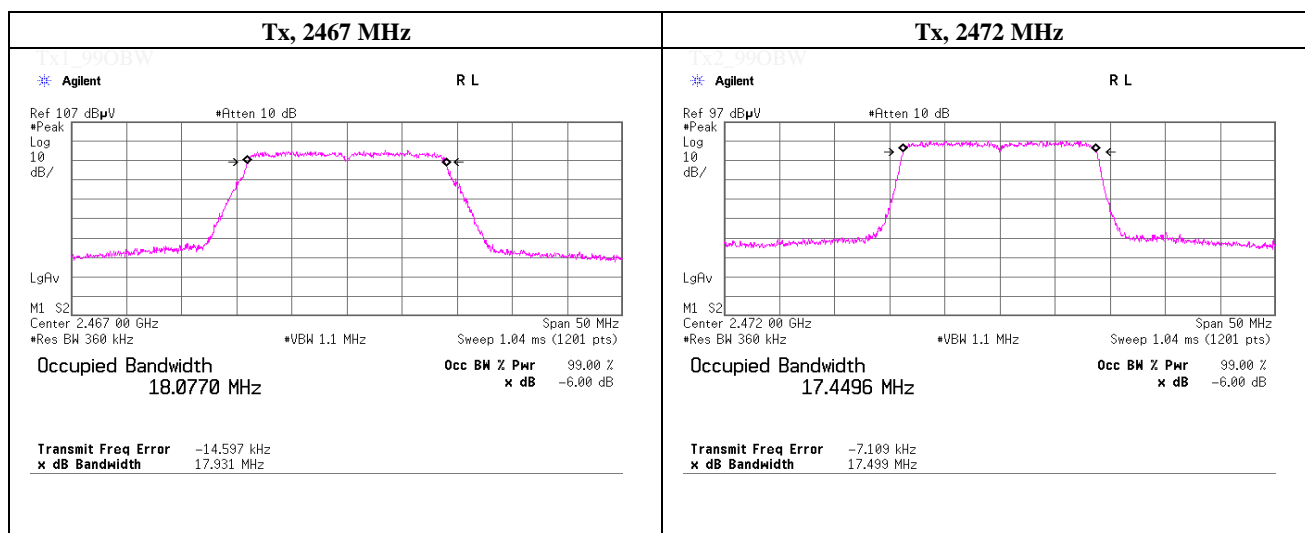

Tx3_99OBW

99 % Occupied Bandwidth

Test place	UL Japan, Inc. Shonan EMC Lab.	No.1 Measurement Room
Date	March 1, 2019	
Temperature / Humidity	24 deg.C , 52 %RH	
Engineer	Yosuke Ishikawa	
Mode	Tx, IEEE802.11n HT40 (SISO), PN9, worst antenna port 1, worst data mode 6 (MCS)	

Freq. [MHz]	99 % Occupied Bandwidth [kHz]
2422.0000	36455.4
2437.0000	36482.9
2452.0000	36440.8

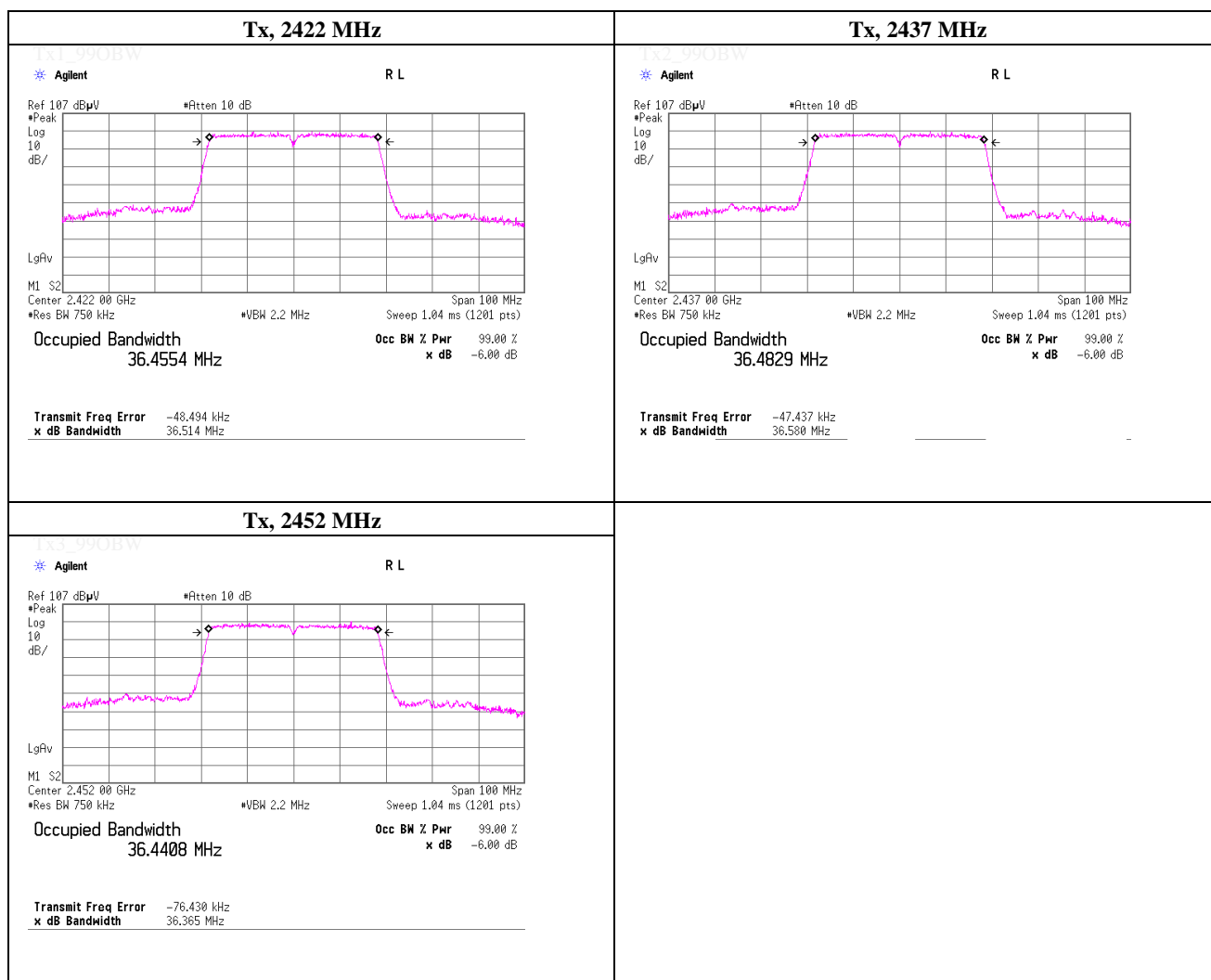

99 % Occupied Bandwidth

Test place	UL Japan, Inc. Shonan EMC Lab.	No.1 Measurement Room
Date	March 1, 2019	
Temperature / Humidity	24 deg.C , 52 %RH	
Engineer	Yosuke Ishikawa	
Mode	Tx, IEEE802.11n HT40 (SISO), PN9, worst antenna port 1, worst data mode 6 (MCS)	

Freq. [MHz]	99 % Occupied Bandwidth [kHz]
2457.0000	36518.8
2462.0000	36553.5

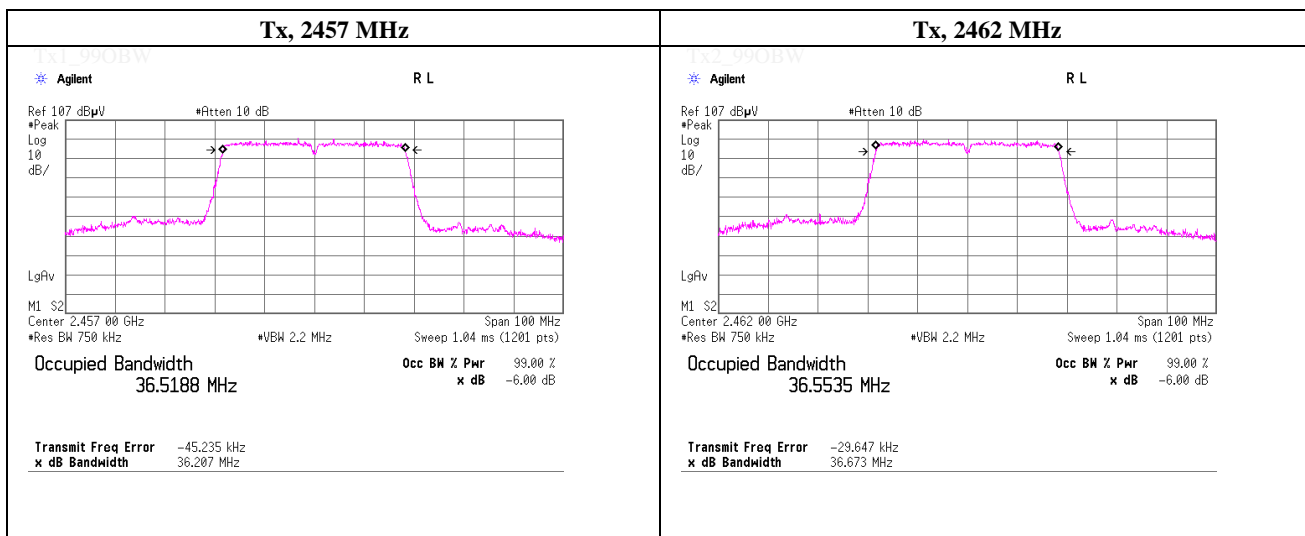

Tx3_99OBW

99 % Occupied Bandwidth

Test place	UL Japan, Inc. Shonan EMC Lab.	No.1 Measurement Room
Date	March 1, 2019	
Temperature / Humidity	24 deg.C , 52 %RH	
Engineer	Yosuke Ishikawa	
Mode	Tx, OFDM VHT40 (SISO), PN9, worst antenna port 1, worst data mode 4 (MCS)	

Freq. [MHz]	99 % Occupied Bandwidth [kHz]
2422.0000	36587.6
2437.0000	36524.9
2452.0000	36516.6

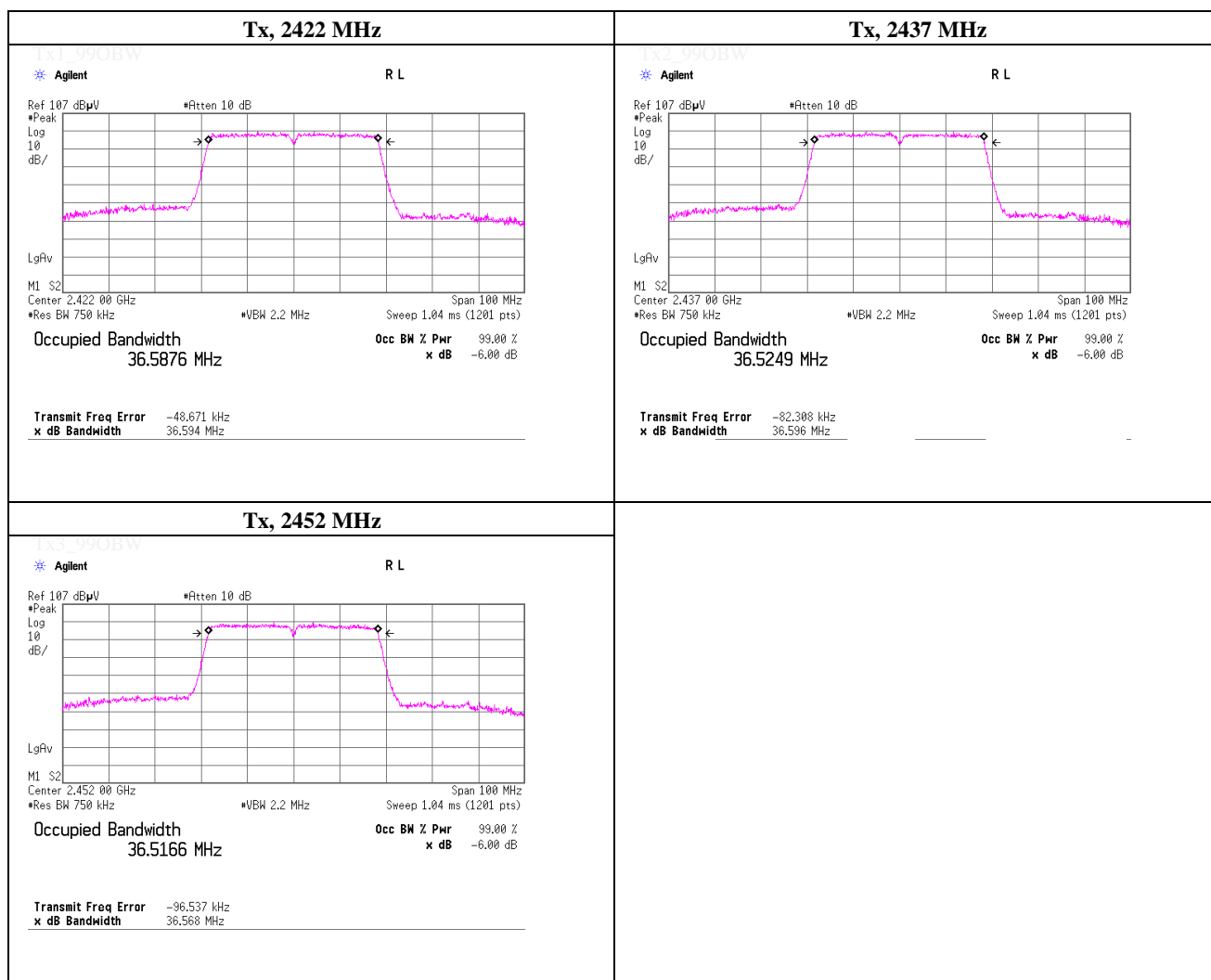

99 % Occupied Bandwidth

Test place	UL Japan, Inc. Shonan EMC Lab.	No.1 Measurement Room
Date	March 1, 2019	
Temperature / Humidity	24 deg.C , 52 %RH	
Engineer	Yosuke Ishikawa	
Mode	Tx, OFDM VHT40 (SISO), PN9, worst antenna port 1, worst data mode 4 (MCS)	

Freq. [MHz]	99 % Occupied Bandwidth [kHz]
2457.0000	36562.7
2462.0000	36523.6

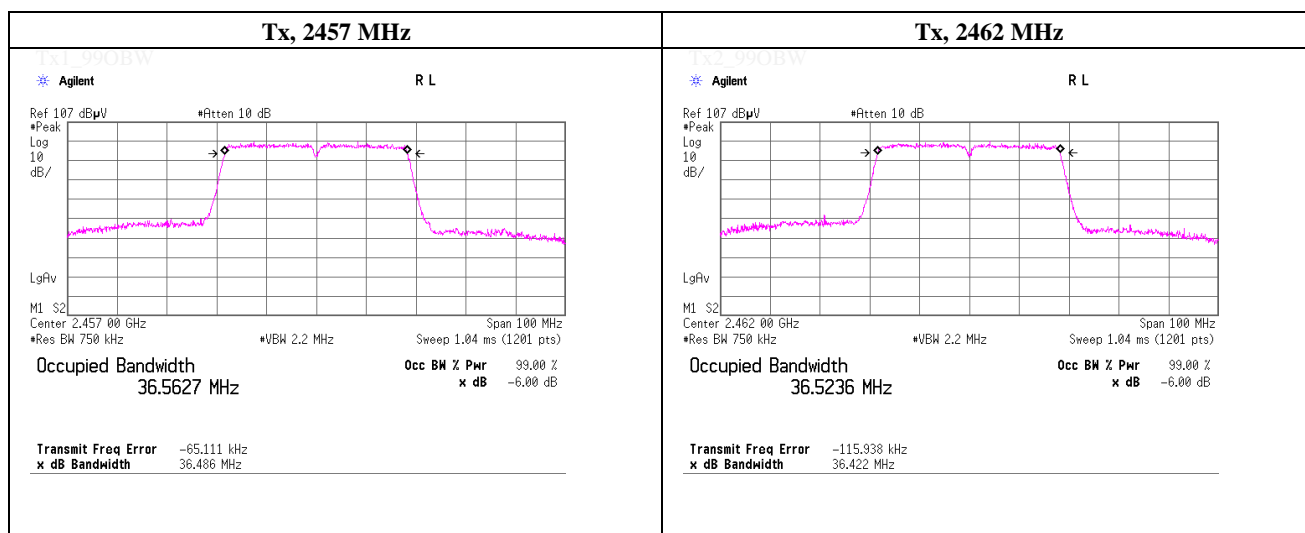

Tx3_99OBW

99 % Occupied Bandwidth

Test place	UL Japan, Inc. Shonan EMC Lab.	No.1 Measurement Room
Date	March 5, 2019	
Temperature / Humidity	23 deg.C , 53 %RH	
Engineer	Kazutaka Takeyama	
Mode	Tx, IEEE802.11n HT40 (MIMO), PN9, antenna port 1, worst data mode 11 (MCS)	

Freq. [MHz]	99 % Occupied Bandwidth [kHz]
2422.0000	36479.4
2437.0000	36548.5
2452.0000	36367.5

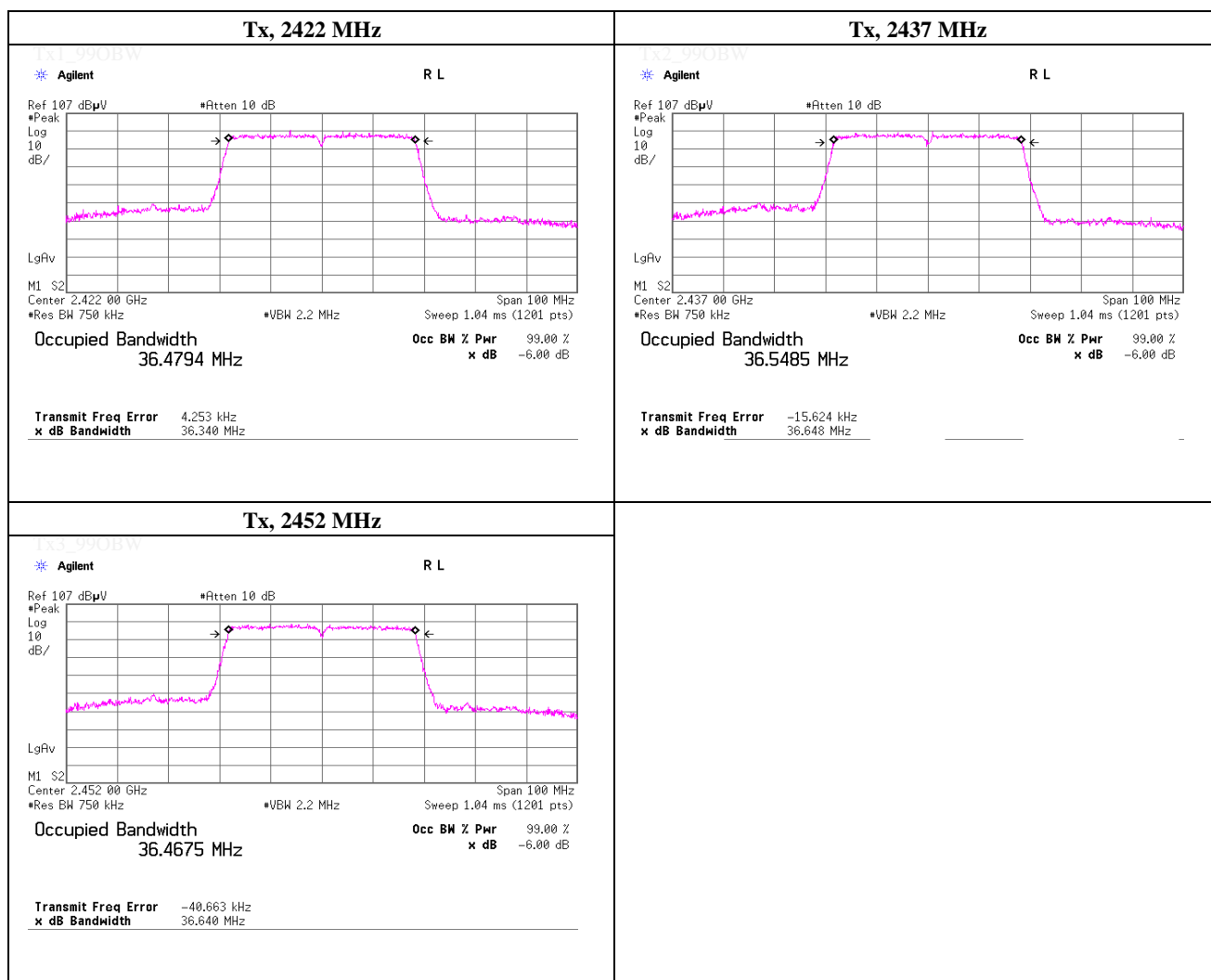

99 % Occupied Bandwidth

Test place	UL Japan, Inc. Shonan EMC Lab.	No.1 Measurement Room
Date	March 5, 2019	
Temperature / Humidity	23 deg.C , 53 %RH	
Engineer	Kazutaka Takeyama	
Mode	Tx, IEEE802.11n HT40 (MIMO), PN9, antenna port 1, worst data mode 11 (MCS)	

Freq. [MHz]	99 % Occupied Bandwidth [kHz]
2457.0000	36528.0
2462.0000	36521.7

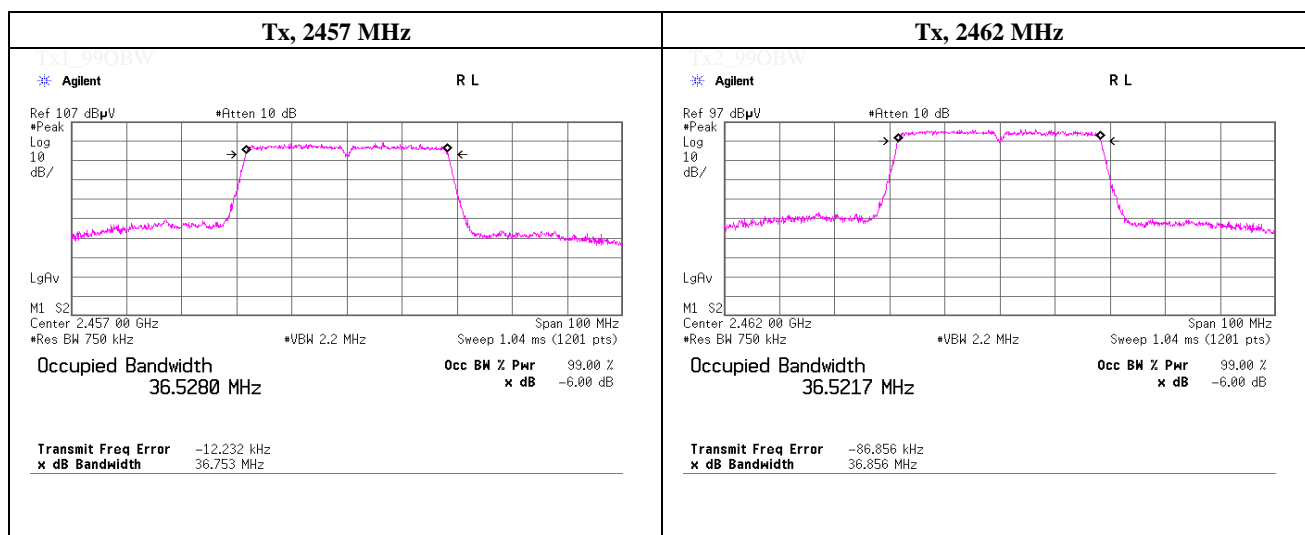

Tx3_99OBW

99 % Occupied Bandwidth

Test place	UL Japan, Inc. Shonan EMC Lab.	No.1 Measurement Room
Date	March 5, 2019	
Temperature / Humidity	23 deg.C , 53 %RH	
Engineer	Kazutaka Takeyama	
Mode	Tx, OFDM VHT40 (MIMO), PN9, antenna port 1, worst data mode 3(MCS)	

Freq. [MHz]	99 % Occupied Bandwidth [kHz]
2422.0000	36419.4
2437.0000	36391.8
2452.0000	36447.3

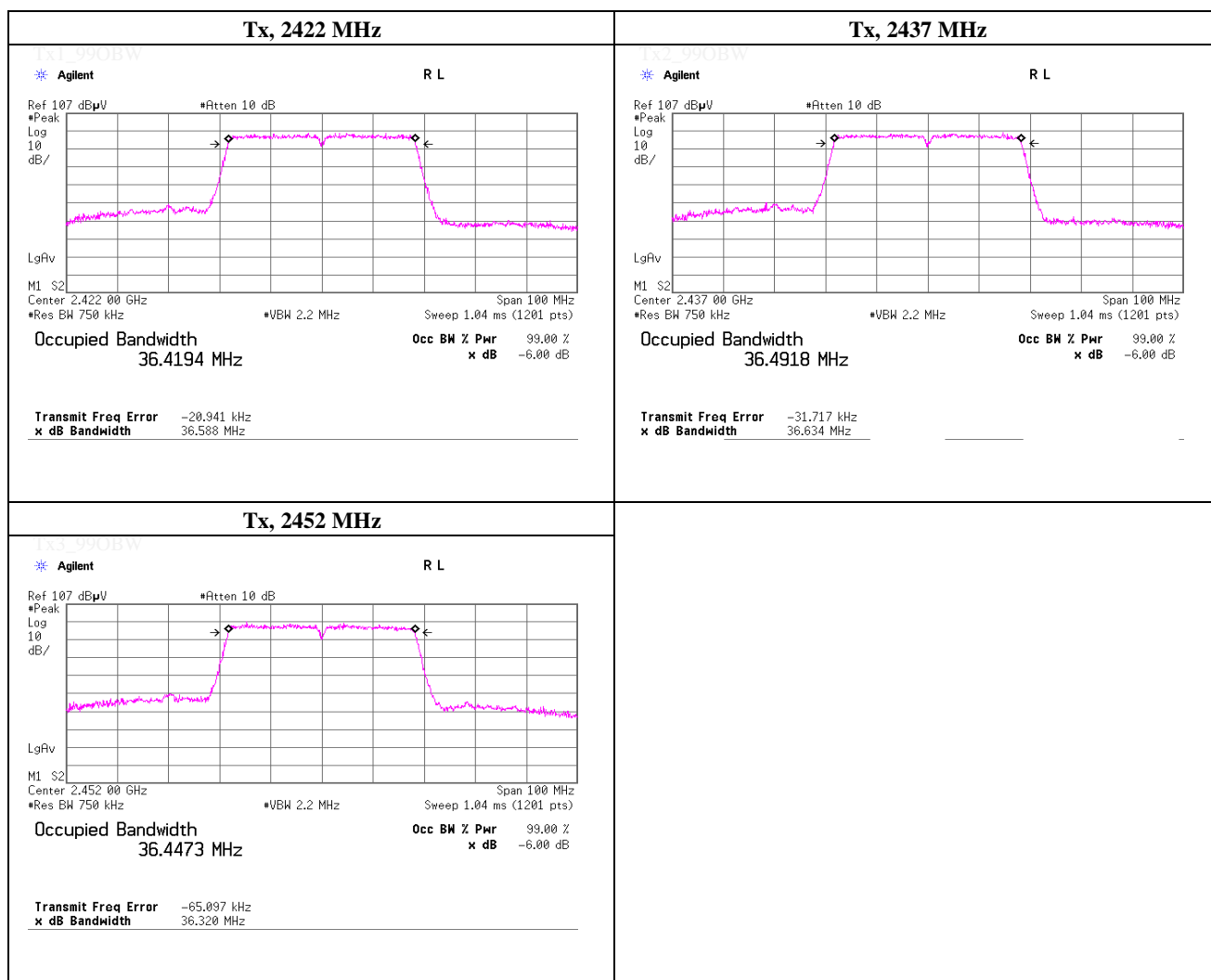

99 % Occupied Bandwidth

Test place	UL Japan, Inc. Shonan EMC Lab.	No.1 Measurement Room
Date	March 5, 2019	
Temperature / Humidity	23 deg.C , 53 %RH	
Engineer	Kazutaka Takeyama	
Mode	Tx, OFDM VHT40 (MIMO), PN9, antenna port 1, worst data mode 3 (MCS)	

Freq. [MHz]	99 % Occupied Bandwidth [kHz]
2457.0000	36448.2
2462.0000	36451.6

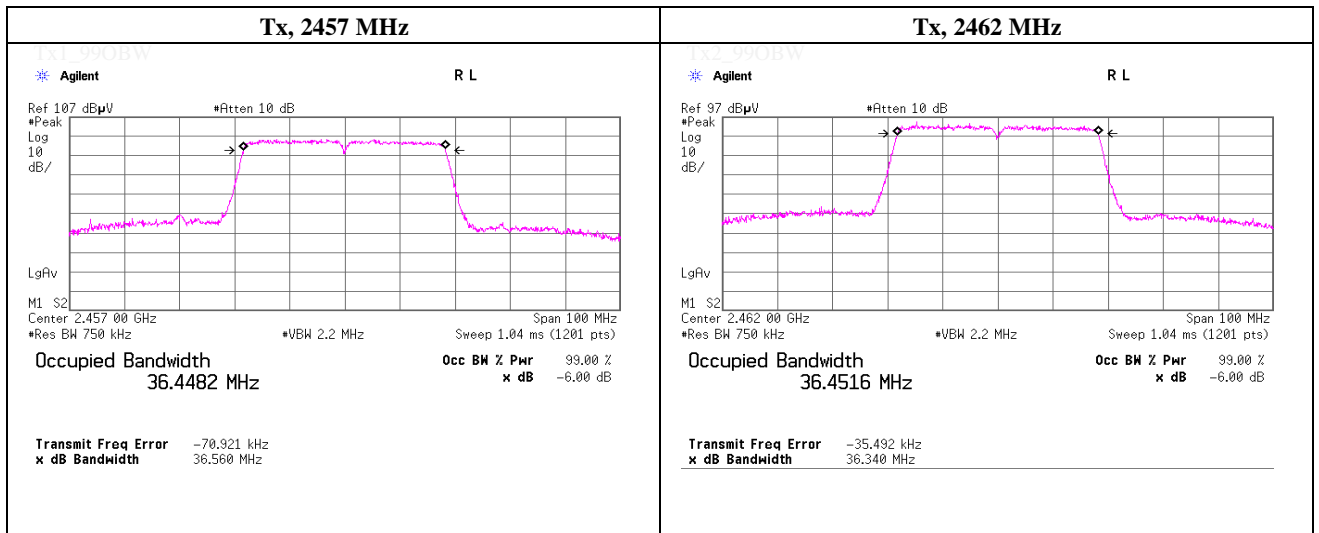

Tx3_99OBW

Maximum Peak Conducted Output Power

(PKPM1)

Test place UL Japan, Inc. Shonan EMC Lab. No.1 Measurement Room
Date January 7, 2019
Temperature / Humidity 23 deg.C , 24 %RH
Engineer Yosuke Ishikawa
Mode Tx, Bluetooth Low Energy, PN9,

(* P/M: Power Meter with power sensor)

Ch	Freq. [MHz]	P/M (Peak) Reading [dBm]	Cable Loss [dB]	Atten. Loss [dB]	Result		Limit		Margin [dB]
					[dBm]	[mW]	[dBm]	[mW]	
Low	2402.0	-11.46	2.40	10.18	1.12	1.29	30.00	1000	28.88
Mid	2440.0	-11.18	2.41	10.18	1.41	1.38	30.00	1000	28.59
High	2480.0	-11.26	2.42	10.18	1.34	1.36	30.00	1000	28.66

Sample Calculation:

Result = Reading + Cable Loss (including the cable(s) customer supplied) + Atten. Loss

UL Japan, Inc.
Shonan EMC Lab.

1-22-3 Megumigaoka, Hiratsuka-shi, Kanagawa 259-1220 JAPAN

Telephone : +81 463 50 6400

Facsimile : +81 463 50 6401

Maximum Peak Conducted Output Power

(PKPM1)

Test place UL Japan, Inc. Shonan EMC Lab. No.1 Measurement Room
Date January 10, 2019
Temperature / Humidity 23 deg.C , 51 %RH
Engineer Yosuke Ishikawa
Mode Tx, IEEE802.11b, PN9, worst antenna : 1 worst data mode : 11 Mbps

(* P/M: Power Meter with power sensor)

Ch	Freq. [MHz]	P/M (Peak) Reading [dBm]	Cable Loss [dB]	Atten. Loss [dB]	Result		Limit		Margin [dB]
					[dBm]	[mW]	[dBm]	[mW]	
Low	2412.0	8.48	2.41	10.18	21.07	127.94	30.00	1000	8.93
Mid	2437.0	8.44	2.41	10.18	21.03	126.77	30.00	1000	8.97
High1	2462.0	8.17	2.42	10.18	20.77	119.40	30.00	1000	9.23

Sample Calculation:

Result = Reading + Cable Loss (including the cable(s) customer supplied) + Atten. Loss

[Pre check]

Antenna 0

	Data rate [Mbps]	Freq. [MHz]	P/M (Peak) Reading [dBm]	Cable Loss [dB]	Atten. Loss [dB]	Result		Limit		Margin [dB]
						[dBm]	[mW]	[dBm]	[mW]	
0	1	2437.0	7.83	2.41	10.18	20.42	110.15	30.00	1000	9.58
0	2	2437.0	8.07	2.41	10.18	20.66	116.41	30.00	1000	9.34
0	5.5	2437.0	8.02	2.41	10.18	20.61	115.08	30.00	1000	9.39
0	11	2437.0	8.14	2.41	10.18	20.73	118.30	30.00	1000	9.27

Antenna 1

	Data rate [Mbps]	Freq. [MHz]	P/M (Peak) Reading [dBm]	Cable Loss [dB]	Atten. Loss [dB]	Result		Limit		Margin [dB]
						[dBm]	[mW]	[dBm]	[mW]	
1	1	2437.0	7.97	2.41	10.18	20.56	113.76	30.00	1000	9.44
1	2	2437.0	8.18	2.41	10.18	20.77	119.40	30.00	1000	9.23
1	5.5	2437.0	8.15	2.41	10.18	20.74	118.58	30.00	1000	9.26
1	11	2437.0	8.44	2.41	10.18	21.03	126.77	30.00	1000	8.97

Worst

Sample Calculation:

Result = Reading + Cable Loss (including the cable(s) customer supplied) + Atten. Loss

UL Japan, Inc.
Shonan EMC Lab.

1-22-3 Megumigaoka, Hiratsuka-shi, Kanagawa 259-1220 JAPAN
Telephone : +81 463 50 6400
Facsimile : +81 463 50 6401

Maximum Peak Conducted Output Power

(PKPM1)

Test place UL Japan, Inc. Shonan EMC Lab. No.1 Measurement Room
Date January 10, 2019
Temperature / Humidity 23 deg.C , 51 %RH
Engineer Yosuke Ishikawa
Mode Tx, IEEE802.11b, PN9, worst antenna : 1 worst data mode : 11 Mbps

(* P/M: Power Meter with power sensor)

Ch	Freq. [MHz]	P/M (Peak) Reading [dBm]	Cable Loss [dB]	Atten. Loss [dB]	Result		Limit		Margin [dB]
					[dBm]	[mW]	[dBm]	[mW]	
High2	2467.0	-0.33	2.42	10.18	12.27	16.87	30.00	1000	17.73
High3	2472.0	-5.02	2.42	10.18	7.58	5.73	30.00	1000	22.42

Sample Calculation:

Result = Reading + Cable Loss (including the cable(s) customer supplied) + Atten. Loss

[Pre check]

Antenna 0

	Data rate [Mbps]	Freq. [MHz]	P/M (Peak) Reading [dBm]	Cable Loss [dB]	Atten. Loss [dB]	Result		Limit		Margin [dB]
						[dBm]	[mW]	[dBm]	[mW]	
0	1	2467.0	-1.55	2.42	10.18	11.05	12.74	30.00	1000	18.95
0	2	2467.0	-1.31	2.42	10.18	11.29	13.46	30.00	1000	18.71
0	5.5	2467.0	-1.24	2.42	10.18	11.36	13.68	30.00	1000	18.64
0	11	2467.0	-0.98	2.42	10.18	11.62	14.52	30.00	1000	18.38

Antenna 1

	Data rate [Mbps]	Freq. [MHz]	P/M (Peak) Reading [dBm]	Cable Loss [dB]	Atten. Loss [dB]	Result		Limit		Margin [dB]
						[dBm]	[mW]	[dBm]	[mW]	
1	1	2467.0	-0.61	2.42	10.18	11.99	15.81	30.00	1000	18.01
1	2	2467.0	-0.41	2.42	10.18	12.19	16.56	30.00	1000	17.81
1	5.5	2467.0	-0.55	2.42	10.18	12.05	16.03	30.00	1000	17.95
1	11	2467.0	-0.33	2.42	10.18	12.27	16.87	30.00	1000	17.73

Worst

Sample Calculation:

Result = Reading + Cable Loss (including the cable(s) customer supplied) + Atten. Loss

UL Japan, Inc.
Shonan EMC Lab.

1-22-3 Megumigaoka, Hiratsuka-shi, Kanagawa 259-1220 JAPAN

Telephone : +81 463 50 6400

Facsimile : +81 463 50 6401

Maximum Peak Conducted Output Power

(PKPM1)

Test place UL Japan, Inc. Shonan EMC Lab. No.1 Measurement Room
Date February 16, 2019
Temperature / Humidity 23 deg.C , 44 %RH
Engineer Yosuke Ishikawa
Mode Tx, IEEE802.11g, PN9, worst antenna : 1 worst data mode : 48 Mbps

(* P/M: Power Meter with power sensor)

Ch	Freq. [MHz]	P/M (Peak) Reading [dBm]	Cable Loss [dB]	Atten. Loss [dB]	Result		Limit		Margin [dB]
					[dBm]	[mW]	[dBm]	[mW]	
Low1	2412.0	10.92	2.41	10.18	23.51	224.39	30.00	1000	6.49

Sample Calculation:

Result = Reading + Cable Loss (including the cable(s) customer supplied) + Atten. Loss

* The Pre-check was measured on 2437 MHz transmissions as the representative.

UL Japan, Inc.
Shonan EMC Lab.

1-22-3 Megumigaoka, Hiratsuka-shi, Kanagawa 259-1220 JAPAN

Telephone : +81 463 50 6400

Facsimile : +81 463 50 6401

Maximum Peak Conducted Output Power

(PKPM1)

Test place UL Japan, Inc. Shonan EMC Lab. No.1 Measurement Room
Date January 10, 2019 February 16, 2019
Temperature / Humidity 23 deg.C , 51 %RH 23 deg.C , 44 %RH
Engineer Yosuke Ishikawa Yosuke Ishikawa
Mode Tx, IEEE802.11g, PN9, worst antenna : 1 worst data mode : 48 Mbps

(* P/M: Power Meter with power sensor)

Ch	Freq. [MHz]	P/M (Peak) Reading [dBm]	Cable Loss [dB]	Atten. Loss [dB]	Result		Limit		Margin [dB]
					[dBm]	[mW]	[dBm]	[mW]	
Low2	2417.0	10.88	2.41	10.18	23.47	222.33	30.00	1000	6.53
Mid	2437.0	10.98	2.41	10.18	23.57	227.51	30.00	1000	6.43
High1	2462.0	10.51	2.42	10.18	23.11	204.64	30.00	1000	6.89

Sample Calculation:

Result = Reading + Cable Loss (including the cable(s) customer supplied) + Atten. Loss

[Pre check]

Antenna 0

	Data rate [Mbps]	Freq. [MHz]	P/M (Peak) Reading [dBm]	Cable Loss [dB]	Atten. Loss [dB]	Result		Limit		Margin [dB]
						[dBm]	[mW]	[dBm]	[mW]	
0	6	2437.0	10.55	2.41	10.18	23.14	206.06	30.00	1000	6.86
0	9	2437.0	10.57	2.41	10.18	23.16	207.01	30.00	1000	6.84
0	12	2437.0	10.34	2.41	10.18	22.93	196.34	30.00	1000	7.07
0	18	2437.0	10.44	2.41	10.18	23.03	200.91	30.00	1000	6.97
0	24	2437.0	10.93	2.41	10.18	23.52	224.91	30.00	1000	6.48
0	36	2437.0	10.90	2.41	10.18	23.49	223.36	30.00	1000	6.51
0	48	2437.0	10.98	2.41	10.18	23.57	227.51	30.00	1000	6.43
0	54	2437.0	10.49	2.41	10.18	23.08	203.24	30.00	1000	6.92

Antenna 1

	Data rate [Mbps]	Freq. [MHz]	P/M (Peak) Reading [dBm]	Cable Loss [dB]	Atten. Loss [dB]	Result		Limit		Margin [dB]
						[dBm]	[mW]	[dBm]	[mW]	
1	6	2437.0	9.99	2.41	10.18	22.58	181.13	30.00	1000	7.42
1	9	2437.0	10.02	2.41	10.18	22.61	182.39	30.00	1000	7.39
1	12	2437.0	9.96	2.41	10.18	22.55	179.89	30.00	1000	7.45
1	18	2437.0	9.81	2.41	10.18	22.40	173.78	30.00	1000	7.60
1	24	2437.0	10.80	2.41	10.18	23.39	218.27	30.00	1000	6.61
1	36	2437.0	10.59	2.41	10.18	23.18	207.97	30.00	1000	6.82
1	48	2437.0	11.00	2.41	10.18	23.59	228.56	30.00	1000	6.41
1	54	2437.0	10.23	2.41	10.18	22.82	191.43	30.00	1000	7.18

Worst

Sample Calculation:

Result = Reading + Cable Loss (including the cable(s) customer supplied) + Atten. Loss

UL Japan, Inc.
Shonan EMC Lab.

1-22-3 Megumigaoka, Hiratsuka-shi, Kanagawa 259-1220 JAPAN

Telephone : +81 463 50 6400

Facsimile : +81 463 50 6401

Maximum Peak Conducted Output Power

(PKPM1)

Test place UL Japan, Inc. Shonan EMC Lab. No.1 Measurement Room
 Date January 10, 2019
 Temperature / Humidity 23 deg.C , 51 %RH
 Engineer Yosuke Ishikawa
 Mode Tx, IEEE802.11g, PN9, worst antenna : 1 worst data mode : 48 Mbps

(* P/M: Power Meter with power sensor)

Ch	Freq. [MHz]	P/M (Peak) Reading [dBm]	Cable Loss [dB]	Atten. Loss [dB]	Result		Limit		Margin [dB]
					[dBm]	[mW]	[dBm]	[mW]	
Hgh2	2467.0	5.12	2.42	10.18	17.72	59.16	30.00	1000	12.28
High3	2472.0	0.37	2.42	10.18	12.97	19.82	30.00	1000	17.03

Sample Calculation:

Result = Reading + Cable Loss (including the cable(s) customer supplied) + Atten. Loss

[Pre check]**Antenna 0**

	Data rate [Mbps]	Freq. [MHz]	P/M (Peak) Reading [dBm]	Cable Loss [dB]	Atten. Loss [dB]	Result		Limit		Margin [dB]
						[dBm]	[mW]	[dBm]	[mW]	
0	6	2467.0	2.39	2.42	10.18	14.99	31.55	30.00	1000	15.01
0	9	2467.0	2.42	2.42	10.18	15.02	31.77	30.00	1000	14.98
0	12	2467.0	2.07	2.42	10.18	14.67	29.31	30.00	1000	15.33
0	18	2467.0	2.02	2.42	10.18	14.62	28.97	30.00	1000	15.38
0	24	2467.0	4.59	2.42	10.18	17.19	52.36	30.00	1000	12.81
0	36	2467.0	4.51	2.42	10.18	17.11	51.40	30.00	1000	12.89
0	48	2467.0	4.98	2.42	10.18	17.58	57.28	30.00	1000	12.42
0	54	2467.0	4.15	2.42	10.18	16.75	47.32	30.00	1000	13.25

Antenna 1

	Data rate [Mbps]	Freq. [MHz]	P/M (Peak) Reading [dBm]	Cable Loss [dB]	Atten. Loss [dB]	Result		Limit		Margin [dB]
						[dBm]	[mW]	[dBm]	[mW]	
1	6	2467.0	3.22	2.42	10.18	15.82	38.19	30.00	1000	14.18
1	9	2467.0	3.20	2.42	10.18	15.80	38.02	30.00	1000	14.20
1	12	2467.0	2.85	2.42	10.18	15.45	35.08	30.00	1000	14.55
1	18	2467.0	2.88	2.42	10.18	15.48	35.32	30.00	1000	14.52
1	24	2467.0	5.13	2.42	10.18	17.73	59.29	30.00	1000	12.27
1	36	2467.0	5.44	2.42	10.18	18.04	63.68	30.00	1000	11.96
1	48	2467.0	5.45	2.42	10.18	18.05	63.83	30.00	1000	11.95
1	54	2467.0	4.57	2.42	10.18	17.17	52.12	30.00	1000	12.83

Worst

Sample Calculation:

Result = Reading + Cable Loss (including the cable(s) customer supplied) + Atten. Loss

UL Japan, Inc.
Shonan EMC Lab.

1-22-3 Megumigaoka, Hiratsuka-shi, Kanagawa 259-1220 JAPAN

Telephone : +81 463 50 6400

Facsimile : +81 463 50 6401

Maximum Peak Conducted Output Power

(PKPM1)

Test place UL Japan, Inc. Shonan EMC Lab. No.1 Measurement Room
 Date February 16, 2019
 Temperature / Humidity 23 deg.C , 44 %RH
 Engineer Yosuke Ishikawa
 Mode Tx, IEEE802.11n HT20 (SISO), PN9, worst antenna : 1 worst data mode : 4 (MCS)

(* P/M: Power Meter with power sensor)

Ch	Freq. [MHz]	P/M (Peak) Reading [dBm]	Cable Loss [dB]	Atten. Loss [dB]	Result		Limit		Margin [dB]
					[dBm]	[mW]	[dBm]	[mW]	
Low1	2412.0	11.85	2.41	10.18	24.44	277.97	30.00	1000	5.56

Sample Calculation:

Result = Reading + Cable Loss (including the cable(s) customer supplied) + Atten. Loss

[Pre check]

Antenna 0

Mode (MCS)	Freq. [MHz]	P/M (Peak) Reading [dBm]	Cable Loss [dB]	Atten. Loss [dB]	Result		Limit		Margin [dB]	
					[dBm]	[mW]	[dBm]	[mW]		
0	0	2412.0	10.51	2.41	10.18	23.10	204.17	30.00	1000	6.90
0	1	2412.0	10.97	2.41	10.18	23.56	226.99	30.00	1000	6.44
0	2	2412.0	10.51	2.41	10.18	23.10	204.17	30.00	1000	6.90
0	3	2412.0	11.66	2.41	10.18	24.25	266.07	30.00	1000	5.75
0	4	2412.0	11.71	2.41	10.18	24.30	269.15	30.00	1000	5.70
0	5	2412.0	11.49	2.41	10.18	24.08	255.86	30.00	1000	5.92
0	6	2412.0	11.61	2.41	10.18	24.20	263.03	30.00	1000	5.80
0	7	2412.0	11.17	2.41	10.18	23.76	237.68	30.00	1000	6.24

Antenna 1

Mode (MCS)	Freq. [MHz]	P/M (Peak) Reading [dBm]	Cable Loss [dB]	Atten. Loss [dB]	Result		Limit		Margin [dB]	
					[dBm]	[mW]	[dBm]	[mW]		
1	0	2412.0	9.63	2.41	10.18	22.22	166.72	30.00	1000	7.78
1	1	2412.0	9.55	2.41	10.18	22.14	163.68	30.00	1000	7.86
1	2	2412.0	9.80	2.41	10.18	22.39	173.38	30.00	1000	7.61
1	3	2412.0	11.82	2.41	10.18	24.41	276.06	30.00	1000	5.59
1	4	2412.0	11.85	2.41	10.18	24.44	277.97	30.00	1000	5.56
1	5	2412.0	11.70	2.41	10.18	24.29	268.53	30.00	1000	5.71
1	6	2412.0	11.67	2.41	10.18	24.26	266.69	30.00	1000	5.74
1	7	2412.0	11.22	2.41	10.18	23.81	240.44	30.00	1000	6.19

Worst

Sample Calculation:

Result = Reading + Cable Loss (including the cable(s) customer supplied) + Atten. Loss

UL Japan, Inc.
Shonan EMC Lab.

1-22-3 Megumigaoka, Hiratsuka-shi, Kanagawa 259-1220 JAPAN

Telephone : +81 463 50 6400

Facsimile : +81 463 50 6401

Maximum Peak Conducted Output Power

(PKPM1)

Test place UL Japan, Inc. Shonan EMC Lab. No.1 Measurement Room
 Date January 10, 2019 February 16, 2019
 Temperature / Humidity 23 deg.C , 51 %RH 23 deg.C , 44 %RH
 Engineer Yosuke Ishikawa Yosuke Ishikawa
 Mode Tx, IEEE802.11n HT20 (SISO), PN9, worst antenna : 1 worst data mode : 3 (MCS)

(* P/M: Power Meter with power sensor)

Ch	Freq. [MHz]	P/M (Peak) Reading [dBm]	Cable Loss [dB]	Atten. Loss [dB]	Result		Limit		Margin [dB]
					[dBm]	[mW]	[dBm]	[mW]	
Low2	2417.0	11.90	2.41	10.18	24.49	281.19	30.00	1000	5.51
Mid	2437.0	11.98	2.41	10.18	24.57	286.42	30.00	1000	5.43
High1	2462.0	11.94	2.42	10.18	24.54	284.45	30.00	1000	5.46

Sample Calculation:

Result = Reading + Cable Loss (including the cable(s) customer supplied) + Atten. Loss

[Pre check]

Antenna 0

	Mode (MCS)	Freq. [MHz]	P/M (Peak) Reading [dBm]	Cable Loss [dB]	Atten. Loss [dB]	Result		Limit		Margin [dB]
						[dBm]	[mW]	[dBm]	[mW]	
0	0	2437.0	10.84	2.41	10.18	23.43	220.29	30.00	1000	6.57
0	1	2437.0	11.06	2.41	10.18	23.65	231.74	30.00	1000	6.35
0	2	2437.0	11.17	2.41	10.18	23.76	237.68	30.00	1000	6.24
0	3	2437.0	11.83	2.41	10.18	24.42	276.69	30.00	1000	5.58
0	4	2437.0	11.41	2.41	10.18	24.00	251.19	30.00	1000	6.00
0	5	2437.0	11.40	2.41	10.18	23.99	250.61	30.00	1000	6.01
0	6	2437.0	11.44	2.41	10.18	24.03	252.93	30.00	1000	5.97
0	7	2437.0	11.02	2.41	10.18	23.61	229.61	30.00	1000	6.39

Antenna 1

	Mode (MCS)	Freq. [MHz]	P/M (Peak) Reading [dBm]	Cable Loss [dB]	Atten. Loss [dB]	Result		Limit		Margin [dB]
						[dBm]	[mW]	[dBm]	[mW]	
1	0	2437.0	10.43	2.41	10.18	23.02	200.45	30.00	1000	6.98
1	1	2437.0	10.83	2.41	10.18	23.42	219.79	30.00	1000	6.58
1	2	2437.0	10.74	2.41	10.18	23.33	215.28	30.00	1000	6.67
1	3	2437.0	11.98	2.41	10.18	24.57	286.42	30.00	1000	5.43
1	4	2437.0	11.41	2.41	10.18	24.00	251.19	30.00	1000	6.00
1	5	2437.0	11.36	2.41	10.18	23.95	248.31	30.00	1000	6.05
1	6	2437.0	11.52	2.41	10.18	24.11	257.63	30.00	1000	5.89
1	7	2437.0	10.96	2.41	10.18	23.55	226.46	30.00	1000	6.45

Worst

Sample Calculation:

Result = Reading + Cable Loss (including the cable(s) customer supplied) + Atten. Loss

UL Japan, Inc.
Shonan EMC Lab.

1-22-3 Megumigaoka, Hiratsuka-shi, Kanagawa 259-1220 JAPAN

Telephone : +81 463 50 6400

Facsimile : +81 463 50 6401

Maximum Peak Conducted Output Power

(PKPM1)

Test place UL Japan, Inc. Shonan EMC Lab. No.1 Measurement Room
 Date January 10, 2019
 Temperature / Humidity 23 deg.C , 51 %RH
 Engineer Yosuke Ishikawa
 Mode Tx, IEEE802.11n HT20 (SISO), PN9, worst antenna : 1 worst data mode : 3 (MCS)

(* P/M: Power Meter with power sensor)

Ch	Freq. [MHz]	P/M (Peak) Reading [dBm]	Cable Loss [dB]	Atten. Loss [dB]	Result		Limit		Margin [dB]
					[dBm]	[mW]	[dBm]	[mW]	
High2	2467.0	6.03	2.42	10.18	18.63	72.95	30.00	1000	11.37
Hgih3	2472.0	1.62	2.42	10.18	14.22	26.42	30.00	1000	15.78

Sample Calculation:

Result = Reading + Cable Loss (including the cable(s) customer supplied) + Atten. Loss

[Pre check]

Antenna 0

	Mode (MCS)	Freq. [MHz]	P/M (Peak) Reading [dBm]	Cable Loss [dB]	Atten. Loss [dB]	Result		Limit		Margin [dB]
						[dBm]	[mW]	[dBm]	[mW]	
0	0	2467.0	2.75	2.42	10.18	15.35	34.28	30.00	1000	14.65
0	1	2467.0	2.67	2.42	10.18	15.27	33.65	30.00	1000	14.73
0	2	2467.0	2.66	2.42	10.18	15.26	33.57	30.00	1000	14.74
0	3	2467.0	5.55	2.42	10.18	18.15	65.31	30.00	1000	11.85
0	4	2467.0	4.90	2.42	10.18	17.50	56.23	30.00	1000	12.50
0	5	2467.0	5.18	2.42	10.18	17.78	59.98	30.00	1000	12.22
0	6	2467.0	5.50	2.42	10.18	18.10	64.57	30.00	1000	11.90
0	7	2467.0	5.35	2.42	10.18	17.95	62.37	30.00	1000	12.05

Antenna 1

	Mode (MCS)	Freq. [MHz]	P/M (Peak) Reading [dBm]	Cable Loss [dB]	Atten. Loss [dB]	Result		Limit		Margin [dB]
						[dBm]	[mW]	[dBm]	[mW]	
1	0	2467.0	3.42	2.42	10.18	16.02	39.99	30.00	1000	13.98
1	1	2467.0	3.20	2.42	10.18	15.80	38.02	30.00	1000	14.20
1	2	2467.0	3.26	2.42	10.18	15.86	38.55	30.00	1000	14.14
1	3	2467.0	6.03	2.42	10.18	18.63	72.95	30.00	1000	11.37
1	4	2467.0	5.45	2.42	10.18	18.05	63.83	30.00	1000	11.95
1	5	2467.0	5.54	2.42	10.18	18.14	65.16	30.00	1000	11.86
1	6	2467.0	5.76	2.42	10.18	18.36	68.55	30.00	1000	11.64
1	7	2467.0	5.62	2.42	10.18	18.22	66.37	30.00	1000	11.78

Worst

Sample Calculation:

Result = Reading + Cable Loss (including the cable(s) customer supplied) + Atten. Loss

UL Japan, Inc.
Shonan EMC Lab.

1-22-3 Megumigaoka, Hiratsuka-shi, Kanagawa 259-1220 JAPAN

Telephone : +81 463 50 6400

Facsimile : +81 463 50 6401

Maximum Peak Conducted Output Power (PKPM1)

Test place UL Japan, Inc. Shonan EMC Lab. No.1 Measurement Room
Date February 16, 2019
Temperature / Humidity 23 deg.C , 44 %RH
Engineer Yosuke Ishikawa
Mode Tx, OFDM VHT20 (SISO), PN9, worst antenna : 1 worst data mode : 4 (MCS)

(* P/M: Power Meter with power sensor)

Ch	Freq. [MHz]	P/M (Peak) Reading [dBm]	Cable Loss [dB]	Atten. Loss [dB]	Result		Limit		Margin [dB]
					[dBm]	[mW]	[dBm]	[mW]	
Low1	2412.0	11.83	2.41	10.18	24.42	276.69	30.00	1000	5.58

Sample Calculation:

Result = Reading + Cable Loss (including the cable(s) customer supplied) + Atten. Loss

[Pre check]

Antenna 0

	Mode (MCS)	Freq. [MHz]	P/M (Peak) Reading [dBm]	Cable Loss [dB]	Atten. Loss [dB]	Result		Limit		Margin [dB]
						[dBm]	[mW]	[dBm]	[mW]	
0	0	2412.0	10.13	2.41	10.18	22.72	187.07	30.00	1000	7.28
0	1	2412.0	10.41	2.41	10.18	23.00	199.53	30.00	1000	7.00
0	2	2412.0	10.05	2.41	10.18	22.64	183.65	30.00	1000	7.36
0	3	2412.0	11.45	2.41	10.18	24.04	253.51	30.00	1000	5.96
0	4	2412.0	11.51	2.41	10.18	24.10	257.04	30.00	1000	5.90
0	5	2412.0	11.51	2.41	10.18	24.10	257.04	30.00	1000	5.90
0	6	2412.0	11.43	2.41	10.18	24.02	252.35	30.00	1000	5.98
0	7	2412.0	11.04	2.41	10.18	23.63	230.67	30.00	1000	6.37
0	8	2412.0	10.16	2.41	10.18	22.75	188.36	30.00	1000	7.25

Antenna 1

	Mode (MCS)	Freq. [MHz]	P/M (Peak) Reading [dBm]	Cable Loss [dB]	Atten. Loss [dB]	Result		Limit		Margin [dB]
						[dBm]	[mW]	[dBm]	[mW]	
1	0	2412.0	9.86	2.41	10.18	22.45	175.79	30.00	1000	7.55
1	1	2412.0	9.75	2.41	10.18	22.34	171.40	30.00	1000	7.66
1	2	2412.0	10.03	2.41	10.18	22.62	182.81	30.00	1000	7.38
1	3	2412.0	11.80	2.41	10.18	24.39	274.79	30.00	1000	5.61
1	4	2412.0	11.83	2.41	10.18	24.42	276.69	30.00	1000	5.58
1	5	2412.0	11.65	2.41	10.18	24.24	265.46	30.00	1000	5.76
1	6	2412.0	11.75	2.41	10.18	24.34	271.64	30.00	1000	5.66
1	7	2412.0	11.03	2.41	10.18	23.62	230.14	30.00	1000	6.38
1	8	2412.0	10.15	2.41	10.18	22.74	187.93	30.00	1000	7.26

Worst

Sample Calculation:

Result = Reading + Cable Loss (including the cable(s) customer supplied) + Atten. Loss

UL Japan, Inc.
Shonan EMC Lab.

1-22-3 Megumigaoka, Hiratsuka-shi, Kanagawa 259-1220 JAPAN
Telephone : +81 463 50 6400
Facsimile : +81 463 50 6401

Maximum Peak Conducted Output Power

(PKPM1)

Test place UL Japan, Inc. Shonan EMC Lab. No.1 Measurement Room
 Date February 16, 2019 March 11, 2019
 Temperature / Humidity 23 deg.C , 44 %RH 22 deg.C , 55 %RH
 Engineer Yosuke Ishikawa Yosuke Ishikawa
 Mode Tx, OFDM VHT20 (SISO), PN9, worst antenna : 1 worst data mode : 3 (MCS)

(* P/M: Power Meter with power sensor)

Ch	Freq. [MHz]	P/M (Peak) Reading [dBm]	Cable Loss [dB]	Atten. Loss [dB]	Result		Limit		Margin [dB]
					[dBm]	[mW]	[dBm]	[mW]	
Low2	2417.0	12.11	2.41	10.18	24.70	295.12	30.00	1000	5.30
Mid	2437.0	12.17	2.41	10.18	24.76	299.23	30.00	1000	5.24
High1	2462.0	11.86	2.42	10.18	24.46	279.25	30.00	1000	5.54

Sample Calculation:

Result = Reading + Cable Loss (including the cable(s) customer supplied) + Atten. Loss

[Pre check]

Antenna 0

	Mode (MCS)	Freq. [MHz]	P/M (Peak) Reading [dBm]	Cable Loss [dB]	Atten. Loss [dB]	Result		Limit		Margin [dB]
						[dBm]	[mW]	[dBm]	[mW]	
0	0	2437.0	10.88	2.41	10.18	23.47	222.33	30.00	1000	6.53
0	1	2437.0	10.80	2.41	10.18	23.39	218.27	30.00	1000	6.61
0	2	2437.0	11.03	2.41	10.18	23.62	230.14	30.00	1000	6.38
0	3	2437.0	11.83	2.41	10.18	24.42	276.69	30.00	1000	5.58
0	4	2437.0	11.37	2.41	10.18	23.96	248.89	30.00	1000	6.04
0	5	2437.0	11.51	2.41	10.18	24.10	257.04	30.00	1000	5.90
0	6	2437.0	11.56	2.41	10.18	24.15	260.02	30.00	1000	5.85
0	7	2437.0	11.15	2.41	10.18	23.74	236.59	30.00	1000	6.26
0	8	2437.0	10.01	2.41	10.18	22.60	181.97	30.00	1000	7.40

Antenna 1

	Mode (MCS)	Freq. [MHz]	P/M (Peak) Reading [dBm]	Cable Loss [dB]	Atten. Loss [dB]	Result		Limit		Margin [dB]
						[dBm]	[mW]	[dBm]	[mW]	
1	0	2437.0	10.44	2.41	10.18	23.03	200.91	30.00	1000	6.97
1	1	2437.0	10.30	2.41	10.18	22.89	194.54	30.00	1000	7.11
1	2	2437.0	10.36	2.41	10.18	22.95	197.24	30.00	1000	7.05
1	3	2437.0	12.17	2.41	10.18	24.76	299.23	30.00	1000	5.24
1	4	2437.0	11.35	2.41	10.18	23.94	247.74	30.00	1000	6.06
1	5	2437.0	11.60	2.41	10.18	24.19	262.42	30.00	1000	5.81
1	6	2437.0	11.61	2.41	10.18	24.20	263.03	30.00	1000	5.80
1	7	2437.0	11.14	2.41	10.18	23.73	236.05	30.00	1000	6.27
1	8	2437.0	9.75	2.41	10.18	22.34	171.40	30.00	1000	7.66

Worst

Sample Calculation:

Result = Reading + Cable Loss (including the cable(s) customer supplied) + Atten. Loss

UL Japan, Inc.
Shonan EMC Lab.

1-22-3 Megumigaoka, Hiratsuka-shi, Kanagawa 259-1220 JAPAN

Telephone : +81 463 50 6400

Facsimile : +81 463 50 6401

Maximum Peak Conducted Output Power

(PKPM1)

Test place UL Japan, Inc. Shonan EMC Lab. No.1 Measurement Room
 Date January 10, 2019
 Temperature / Humidity 23 deg.C , 51 %RH
 Engineer Yosuke Ishikawa
 Mode Tx, OFDM VHT20 (SISO), PN9, worst antenna : 1 worst data mode : 3 (MCS)

(* P/M: Power Meter with power sensor)

Ch	Freq. [MHz]	P/M (Peak) Reading [dBm]	Cable Loss [dB]	Atten. Loss [dB]	Result		Limit		Margin [dB]
					[dBm]	[mW]	[dBm]	[mW]	
High2	2467.0	5.82	2.42	10.18	18.42	69.50	30.00	1000	11.58
High3	2472.0	1.43	2.42	10.18	14.03	25.29	30.00	1000	15.97

Sample Calculation:

Result = Reading + Cable Loss (including the cable(s) customer supplied) + Atten. Loss

[Pre check]

Antenna 0

	Mode (MCS)	Freq. [MHz]	P/M (Peak) Reading [dBm]	Cable Loss [dB]	Atten. Loss [dB]	Result		Limit		Margin [dB]
						[dBm]	[mW]	[dBm]	[mW]	
0	0	2467.0	2.61	2.42	10.18	15.21	33.19	30.00	1000	14.79
0	1	2467.0	2.53	2.42	10.18	15.13	32.58	30.00	1000	14.87
0	2	2467.0	2.47	2.42	10.18	15.07	32.14	30.00	1000	14.93
0	3	2467.0	5.47	2.42	10.18	18.07	64.12	30.00	1000	11.93
0	4	2467.0	4.94	2.42	10.18	17.54	56.75	30.00	1000	12.46
0	5	2467.0	5.47	2.42	10.18	18.07	64.12	30.00	1000	11.93
0	6	2467.0	5.78	2.42	10.18	18.38	68.87	30.00	1000	11.62
0	7	2467.0	5.60	2.42	10.18	18.20	66.07	30.00	1000	11.80
0	8	2467.0	5.05	2.42	10.18	17.65	58.21	30.00	1000	12.35

Antenna 1

	Mode (MCS)	Freq. [MHz]	P/M (Peak) Reading [dBm]	Cable Loss [dB]	Atten. Loss [dB]	Result		Limit		Margin [dB]
						[dBm]	[mW]	[dBm]	[mW]	
1	0	2467.0	3.68	2.42	10.18	16.28	42.46	30.00	1000	13.72
1	1	2467.0	3.31	2.42	10.18	15.91	38.99	30.00	1000	14.09
1	2	2467.0	3.37	2.42	10.18	15.97	39.54	30.00	1000	14.03
1	3	2467.0	5.82	2.42	10.18	18.42	69.50	30.00	1000	11.58
1	4	2467.0	5.64	2.42	10.18	18.24	66.68	30.00	1000	11.76
1	5	2467.0	5.39	2.42	10.18	17.99	62.95	30.00	1000	12.01
1	6	2467.0	5.51	2.42	10.18	18.11	64.71	30.00	1000	11.89
1	7	2467.0	5.61	2.42	10.18	18.21	66.22	30.00	1000	11.79
1	8	2467.0	5.62	2.42	10.18	18.22	66.37	30.00	1000	11.78

Worst

Sample Calculation:

Result = Reading + Cable Loss (including the cable(s) customer supplied) + Atten. Loss

UL Japan, Inc.
Shonan EMC Lab.

1-22-3 Megumigaoka, Hiratsuka-shi, Kanagawa 259-1220 JAPAN

Telephone : +81 463 50 6400

Facsimile : +81 463 50 6401

Maximum Peak Conducted Output Power (PKPM1)

Test place UL Japan, Inc. Shonan EMC Lab. No.1 Measurement Room
Date February 16, 2019
Temperature / Humidity 23 deg.C , 44 %RH
Engineer Yosuke Ishikawa
Mode Tx, IEEE802.11n HT20 (MIMO), PN9, worst data mode : 14 (MCS)

Antenna 0 + Antenna 1

Ch	Freq. [MHz]	Result Ant 0 [mW]	Result Ant 1 [mW]	Result Ant 0 + Ant 1		Limit		Margin [dB]
				[dBm]	[mW]	[dBm]	[mW]	
Low1	2412.0	142.23	131.52	24.37	273.75	30.00	1000	5.63

Antenna 0 (* P/M: Power Meter with power sensor)

Ch	Freq. [MHz]	P/M (Peak) Reading [dBm]	Cable Loss [dB]	Atten. Loss [dB]	Result	
					[dBm]	[mW]
Low1	2412.0	8.94	2.41	10.18	21.53	142.23

Antenna 1 (* P/M: Power Meter with power sensor)

Ch	Freq. [MHz]	P/M (Peak) Reading [dBm]	Cable Loss [dB]	Atten. Loss [dB]	Result	
					[dBm]	[mW]
Low1	2412.0	8.60	2.41	10.18	21.19	131.52

Sample Calculation:

Result = Reading + Cable Loss (including the cable(s) customer supplied) + Atten. Loss

[Pre check]

Mode (MCS)	Freq. [MHz]	Cable Loss [dB]	Atten. Loss [dB]	Antenna 0		Antenna 1		Antenna 0 + 1	
				Reading [dBm]	Result [dBm]	Reading [dBm]	Result [dBm]	Total Result [dBm]	Total Result [mW]
8	2412.0	2.41	10.18	6.93	19.52	7.03	19.62	22.58	181.16
9	2412.0	2.41	10.18	7.00	19.59	6.99	19.58	22.60	181.77
10	2412.0	2.41	10.18	6.91	19.50	6.89	19.48	22.50	177.85
11	2412.0	2.41	10.18	8.78	21.37	8.55	21.14	24.27	267.11
12	2412.0	2.41	10.18	8.81	21.40	8.59	21.18	24.30	269.26
13	2412.0	2.41	10.18	8.80	21.39	8.47	21.06	24.24	265.36
14	2412.0	2.41	10.18	8.94	21.53	8.60	21.19	24.37	273.75
15	2412.0	2.41	10.18	8.90	21.49	8.57	21.16	24.34	271.55

Worst

Sample Calculation:

Result = Reading + Cable Loss (including the cable(s) customer supplied) + Atten. Loss

Total Result [mW] = $10^{Antenna\ 0\ Result / 10} + 10^{Antenna\ 1\ Result / 10}$

Total Result [dBm] = $10 * \log(\text{Total Result [mW]})$

UL Japan, Inc.
Shonan EMC Lab.

1-22-3 Megumigaoka, Hiratsuka-shi, Kanagawa 259-1220 JAPAN
Telephone : +81 463 50 6400
Facsimile : +81 463 50 6401

Maximum Peak Conducted Output Power (PKPM1)

Test place UL Japan, Inc. Shonan EMC Lab. No.1 Measurement Room
Date January 11, 2019 February 16, 2019
Temperature / Humidity 24 deg.C , 51 %RH 23 deg.C , 44 %RH
Engineer Yosuke Ishikawa Yosuke Ishikawa
Mode Tx, IEEE802.11n HT20 (MIMO), PN9, worst data mode : 14 (MCS)

Antenna 0 + Antenna 1

Ch	Freq. [MHz]	Result Ant 0 [mW]	Result Ant 1 [mW]	Result Ant 0 + Ant 1		Limit		Margin [dB]
				[dBm]	[mW]	[dBm]	[mW]	
Low2	2417.0	152.76	137.40	24.63	290.16	30.00	1000	5.37
Mid	2437.0	152.76	160.69	24.96	313.45	30.00	1000	5.04
High1	2462.0	142.56	142.89	24.56	285.45	30.00	1000	5.44

Antenna 0

(* P/M: Power Meter with power sensor)

Ch	Freq. [MHz]	P/M (Peak) Reading [dBm]	Cable Loss [dB]	Atten. Loss [dB]	Result	
					[dBm]	[mW]
Low2	2417.0	9.25	2.41	10.18	21.84	152.76
Mid	2437.0	9.25	2.41	10.18	21.84	152.76
High1	2462.0	8.94	2.42	10.18	21.54	142.56

Antenna 1

(* P/M: Power Meter with power sensor)

Ch	Freq. [MHz]	P/M (Peak) Reading [dBm]	Cable Loss [dB]	Atten. Loss [dB]	Result	
					[dBm]	[mW]
Low2	2417.0	8.79	2.41	10.18	21.38	137.40
Mid	2437.0	9.47	2.41	10.18	22.06	160.69
High1	2462.0	8.95	2.42	10.18	21.55	142.89

Sample Calculation:

Result = Reading + Cable Loss (including the cable(s) customer supplied) + Atten. Loss

[Pre check]

Mode (MCS)	Freq. [MHz]	Cable Loss [dB]	Atten. Loss [dB]	Antenna 0		Antenna 1		Antenna 0 + 1	
				Reading [dBm]	Result [dBm]	Reading [dBm]	Result [dBm]	Total Result [dBm]	Total Result [mW]
8	2437.0	2.41	10.18	7.05	19.64	7.13	19.72	22.69	185.80
9	2437.0	2.41	10.18	6.57	19.16	7.10	19.69	22.44	175.52
10	2437.0	2.41	10.18	6.90	19.49	6.87	19.46	22.49	177.23
11	2437.0	2.41	10.18	9.13	21.72	9.40	21.99	24.87	306.71
12	2437.0	2.41	10.18	9.35	21.94	9.23	21.82	24.89	308.36
13	2437.0	2.41	10.18	8.99	21.58	9.36	21.95	24.78	300.56
14	2437.0	2.41	10.18	9.25	21.84	9.47	22.06	24.96	313.45
15	2437.0	2.41	10.18	9.02	21.61	9.52	22.11	24.88	307.43

Worst

Sample Calculation:

Result = Reading + Cable Loss (including the cable(s) customer supplied) + Atten. Loss

Total Result [mW] = 10 ^ (Antenna 0 Result / 10) + 10 ^ (Antenna 1 Result / 10)

Total Result [dBm] = 10 * log (Total Result [mW])

UL Japan, Inc.
Shonan EMC Lab.

1-22-3 Megumigaoka, Hiratsuka-shi, Kanagawa 259-1220 JAPAN

Telephone : +81 463 50 6400

Facsimile : +81 463 50 6401

Maximum Peak Conducted Output Power

(PKPM1)

Test place UL Japan, Inc. Shonan EMC Lab. No.1 Measurement Room
 Date February 16, 2019
 Temperature / Humidity 23 deg.C , 44 %RH
 Engineer Yosuke Ishikawa
 Mode Tx, OFDM VHT20 (MIMO), PN9, worst data mode : 3 (MCS)

Antenna 0 + Antenna 1

Ch	Freq. [MHz]	Result Ant 0 [mW]	Result Ant 1 [mW]	Result Ant 0 + Ant 1		Limit		Margin [dB]
				[dBm]	[mW]	[dBm]	[mW]	
Low1	2412.0	138.36	145.55	24.53	283.91	30.00	1000	5.47

Antenna 0 (* P/M: Power Meter with power sensor)

Ch	Freq. [MHz]	P/M (Peak) Reading [dBm]	Cable Loss [dB]	Atten. Loss [dB]	Result	
					[dBm]	[mW]
Low1	2412.0	8.82	2.41	10.18	21.41	138.36

Antenna 1 (* P/M: Power Meter with power sensor)

Ch	Freq. [MHz]	P/M (Peak) Reading [dBm]	Cable Loss [dB]	Atten. Loss [dB]	Result	
					[dBm]	[mW]
Low1	2412.0	9.04	2.41	10.18	21.63	145.55

Sample Calculation:

Result = Reading + Cable Loss (including the cable(s) customer supplied) + Atten. Loss

[Pre check]

Mode (MCS)	Freq. [MHz]	Cable Loss [dB]	Atten. Loss [dB]	Antenna 0		Antenna 1		Antenna 0 + 1 Total Result	
				Reading [dBm]	Result [dBm]	Reading [dBm]	Result [dBm]	[dBm]	[mW]
0	2412.0	2.41	10.18	5.70	18.29	6.12	18.71	21.52	141.75
1	2412.0	2.41	10.18	5.89	18.48	6.20	18.79	21.65	146.15
2	2412.0	2.41	10.18	5.77	18.36	6.18	18.77	21.58	143.89
3	2412.0	2.41	10.18	8.82	21.41	9.04	21.63	24.53	283.91
4	2412.0	2.41	10.18	8.71	21.30	9.00	21.59	24.46	279.11
5	2412.0	2.41	10.18	8.68	21.27	8.89	21.48	24.39	274.57
6	2412.0	2.41	10.18	8.70	21.29	8.94	21.53	24.42	276.82
7	2412.0	2.41	10.18	8.72	21.31	9.01	21.60	24.47	279.75
8	2412.0	2.41	10.18	8.72	21.31	8.99	21.58	24.46	279.09

Worst

Sample Calculation:

Result = Reading + Cable Loss (including the cable(s) customer supplied) + Atten. Loss

Total Result [mW] = $10^{\wedge}(\text{Antenna 0 Result} / 10) + 10^{\wedge}(\text{Antenna 1 Result} / 10)$

Total Result [dBm] = $10 * \log(\text{Total Result [mW]})$

UL Japan, Inc.
Shonan EMC Lab.

1-22-3 Megumigaoka, Hiratsuka-shi, Kanagawa 259-1220 JAPAN
 Telephone : +81 463 50 6400
 Facsimile : +81 463 50 6401

Maximum Peak Conducted Output Power (PKPM1)

Test place UL Japan, Inc. Shonan EMC Lab. No.1 Measurement Room
Date January 11, 2019 February 16, 2019
Temperature / Humidity 24 deg.C , 51 %RH 23 deg.C , 44 %RH
Engineer Yosuke Ishikawa Yosuke Ishikawa
Mode Tx, OFDM VHT20 (MIMO), PN9, worst data mode : 3 (MCS)

Antenna 0 + Antenna 1

Ch	Freq. [MHz]	Result Ant 0 [mW]	Result Ant 1 [mW]	Result Ant 0 + Ant 1		Limit		Margin [dB]
				[dBm]	[mW]	[dBm]	[mW]	
Low2	2417.0	158.12	144.54	24.81	302.66	30.00	1000	5.19
Mid	2437.0	165.58	164.44	25.19	330.02	30.00	1000	4.81
High1	2462.0	158.49	154.53	24.96	313.02	30.00	1000	5.04

Antenna 0

(* P/M: Power Meter with power sensor)

Ch	Freq. [MHz]	P/M (Peak) Reading [dBm]	Cable Loss [dB]	Atten. Loss [dB]	Result	
					[dBm]	[mW]
Low2	2417.0	9.40	2.41	10.18	21.99	158.12
Mid	2437.0	9.60	2.41	10.18	22.19	165.58
High1	2462.0	9.40	2.42	10.18	22.00	158.49

Antenna 1

(* P/M: Power Meter with power sensor)

Ch	Freq. [MHz]	P/M (Peak) Reading [dBm]	Cable Loss [dB]	Atten. Loss [dB]	Result	
					[dBm]	[mW]
Low2	2417.0	9.01	2.41	10.18	21.60	144.54
Mid	2437.0	9.57	2.41	10.18	22.16	164.44
High1	2462.0	9.29	2.42	10.18	21.89	154.53

Sample Calculation:

Result = Reading + Cable Loss (including the cable(s) customer supplied) + Atten. Loss

[Pre check]

Mode (MCS)	Freq. [MHz]	Cable Loss [dB]	Atten. Loss [dB]	Antenna 0		Antenna 1		Antenna 0 + 1 Total Result	
				Reading [dBm]	Result [dBm]	Reading [dBm]	Result [dBm]	[dBm]	[mW]
0	2437.0	2.41	10.18	6.82	19.41	7.25	19.84	22.64	183.68
1	2437.0	2.41	10.18	6.54	19.13	6.93	19.52	22.34	171.39
2	2437.0	2.41	10.18	6.65	19.24	6.99	19.58	22.42	174.73
3	2437.0	2.41	10.18	9.60	22.19	9.57	22.16	25.19	330.02
4	2437.0	2.41	10.18	9.00	21.59	9.20	21.79	24.70	295.22
5	2437.0	2.41	10.18	8.88	21.47	9.36	21.95	24.73	296.96
6	2437.0	2.41	10.18	9.04	21.63	9.18	21.77	24.71	295.86
7	2437.0	2.41	10.18	8.92	21.51	9.23	21.82	24.68	293.63
8	2437.0	2.41	10.18	9.11	21.70	9.15	21.74	24.73	297.19

Worst

Sample Calculation:

Result = Reading + Cable Loss (including the cable(s) customer supplied) + Atten. Loss

Total Result [mW] = 10 ^ (Antenna 0 Result / 10) + 10 ^ (Antenna 1 Result / 10)

Total Result [dBm] = 10 * log (Total Result [mW])

UL Japan, Inc.
Shonan EMC Lab.

1-22-3 Megumigaoka, Hiratsuka-shi, Kanagawa 259-1220 JAPAN

Telephone : +81 463 50 6400

Facsimile : +81 463 50 6401

Maximum Peak Conducted Output Power

(PKPM1)

Test place UL Japan, Inc. Shonan EMC Lab. No.1 Measurement Room
 Date January 11, 2019
 Temperature / Humidity 24 deg.C , 51 %RH
 Engineer Yosuke Ishikawa
 Mode Tx, OFDM VHT20 (MIMO), PN9, worst data mode : 3 (MCS)

Antenna 0 + Antenna 1

Ch	Freq. [MHz]	Result Ant 0 [mW]	Result Ant 1 [mW]	Result Ant 0 + Ant 1		Limit		Margin [dB]
				[dBm]	[mW]	[dBm]	[mW]	
High2	2467.0	29.17	35.08	18.08	64.25	30.00	1000	11.92
High3	2472.0	10.91	12.45	13.68	23.36	30.00	1000	16.32

Antenna 0

(* P/M: Power Meter with power sensor)

Ch	Freq. [MHz]	P/M (Peak) Reading [dBm]	Cable Loss [dB]	Atten. Loss [dB]	Result	
					[dBm]	[mW]
High2	2467.0	2.05	2.42	10.18	14.65	29.17
High3	2472.0	-2.22	2.42	10.18	10.38	10.91

Antenna 1

(* P/M: Power Meter with power sensor)

Ch	Freq. [MHz]	P/M (Peak) Reading [dBm]	Cable Loss [dB]	Atten. Loss [dB]	Result	
					[dBm]	[mW]
High2	2467.0	2.85	2.42	10.18	15.45	35.08
High3	2472.0	-1.65	2.42	10.18	10.95	12.45

Sample Calculation:

Result = Reading + Cable Loss (including the cable(s) customer supplied) + Atten. Loss

* The pre-check was measured on 2437 MHz transmission as the representative.

UL Japan, Inc.
Shonan EMC Lab.

1-22-3 Megumigaoka, Hiratsuka-shi, Kanagawa 259-1220 JAPAN

Telephone : +81 463 50 6400

Facsimile : +81 463 50 6401

Maximum Peak Conducted Output Power

(PKPM1)

Test place UL Japan, Inc. Shonan EMC Lab. No.1 Measurement Room
 Date January 10, 2019
 Temperature / Humidity 23 deg.C , 51 %RH
 Engineer Yosuke Ishikawa
 Mode Tx, IEEE802.11n HT40 (SISO), PN9, worst antenna : 1 worst data mode : 6 (MCS)

(* P/M: Power Meter with power sensor)

Ch	Freq. [MHz]	P/M (Peak) Reading [dBm]	Cable Loss [dB]	Atten. Loss [dB]	Result		Limit		Margin [dB]
					[dBm]	[mW]	[dBm]	[mW]	
Low	2422.0	6.60	2.41	10.18	19.19	82.99	30.00	1000	10.81
Mid	2437.0	7.10	2.41	10.18	19.69	93.11	30.00	1000	10.31
High1	2452.0	6.50	2.42	10.18	19.10	81.28	30.00	1000	10.90

Sample Calculation:

Result = Reading + Cable Loss (including the cable(s) customer supplied) + Atten. Loss

[Pre check]

Antenna 0

	Mode (MCS)	Freq. [MHz]	P/M (Peak) Reading [dBm]	Cable Loss [dB]	Atten. Loss [dB]	Result		Limit		Margin [dB]
						[dBm]	[mW]	[dBm]	[mW]	
0	0	2437.0	3.53	2.41	10.18	16.12	40.93	30.00	1000	13.88
0	1	2437.0	3.39	2.41	10.18	15.98	39.63	30.00	1000	14.02
0	2	2437.0	3.98	2.41	10.18	16.57	45.39	30.00	1000	13.43
0	3	2437.0	6.75	2.41	10.18	19.34	85.90	30.00	1000	10.66
0	4	2437.0	6.34	2.41	10.18	18.93	78.16	30.00	1000	11.07
0	5	2437.0	6.28	2.41	10.18	18.87	77.09	30.00	1000	11.13
0	6	2437.0	6.27	2.41	10.18	18.86	76.91	30.00	1000	11.14
0	7	2437.0	6.25	2.41	10.18	18.84	76.56	30.00	1000	11.16

Antenna 1

	Mode (MCS)	Freq. [MHz]	P/M (Peak) Reading [dBm]	Cable Loss [dB]	Atten. Loss [dB]	Result		Limit		Margin [dB]
						[dBm]	[mW]	[dBm]	[mW]	
1	0	2437.0	3.93	2.41	10.18	16.52	44.87	30.00	1000	13.48
1	1	2437.0	3.72	2.41	10.18	16.31	42.76	30.00	1000	13.69
1	2	2437.0	3.86	2.41	10.18	16.45	44.16	30.00	1000	13.55
1	3	2437.0	6.90	2.41	10.18	19.49	88.92	30.00	1000	10.51
1	4	2437.0	6.78	2.41	10.18	19.37	86.50	30.00	1000	10.63
1	5	2437.0	6.86	2.41	10.18	19.45	88.10	30.00	1000	10.55
1	6	2437.0	7.10	2.41	10.18	19.69	93.11	30.00	1000	10.31
1	7	2437.0	7.04	2.41	10.18	19.63	91.83	30.00	1000	10.37

Worst

Sample Calculation:

Result = Reading + Cable Loss (including the cable(s) customer supplied) + Atten. Loss

UL Japan, Inc.
Shonan EMC Lab.

1-22-3 Megumigaoka, Hiratsuka-shi, Kanagawa 259-1220 JAPAN

Telephone : +81 463 50 6400

Facsimile : +81 463 50 6401

Maximum Peak Conducted Output Power

(PKPM1)

Test place UL Japan, Inc. Shonan EMC Lab. No.1 Measurement Room
Date January 10, 2019
Temperature / Humidity 23 deg.C , 51 %RH
Engineer Yosuke Ishikawa
Mode Tx, IEEE802.11n HT40 (SISO), PN9, worst antenna : 1 worst data mode : 6 (MCS)

(* P/M: Power Meter with power sensor)

Ch	Freq. [MHz]	P/M (Peak) Reading [dBm]	Cable Loss [dB]	Atten. Loss [dB]	Result		Limit		Margin [dB]
					[dBm]	[mW]	[dBm]	[mW]	
High2	2457.0	6.71	2.42	10.18	19.31	85.31	30.00	1000	10.69
High3	2462.0	6.73	2.42	10.18	19.33	85.70	30.00	1000	10.67

Sample Calculation:

Result = Reading + Cable Loss (including the cable(s) customer supplied) + Atten. Loss

* The pre-check was measured on 2437 MHz transmission as the representative.

UL Japan, Inc.
Shonan EMC Lab.

1-22-3 Megumigaoka, Hiratsuka-shi, Kanagawa 259-1220 JAPAN

Telephone : +81 463 50 6400

Facsimile : +81 463 50 6401

Maximum Peak Conducted Output Power

(PKPM1)

Test place UL Japan, Inc. Shonan EMC Lab. No.1 Measurement Room
 Date January 10, 2019
 Temperature / Humidity 23 deg.C , 51 %RH
 Engineer Yosuke Ishikawa
 Mode Tx, OFDM VHT40 (SISO), PN9, worst antenna : 1 worst data mode : 4 (MCS)

(* P/M: Power Meter with power sensor)

Ch	Freq. [MHz]	P/M (Peak) Reading [dBm]	Cable Loss [dB]	Atten. Loss [dB]	Result		Limit		Margin [dB]
					[dBm]	[mW]	[dBm]	[mW]	
Low	2422.0	6.86	2.41	10.18	19.45	88.10	30.00	1000	10.55
Mid	2437.0	7.01	2.41	10.18	19.60	91.20	30.00	1000	10.40
High1	2452.0	6.77	2.42	10.18	19.37	86.50	30.00	1000	10.63

Sample Calculation:

Result = Reading + Cable Loss (including the cable(s) customer supplied) + Atten. Loss

[Pre check]

Antenna 0

	Mode (MCS)	Freq. [MHz]	P/M (Peak) Reading [dBm]	Cable Loss [dB]	Atten. Loss [dB]	Result		Limit		Margin [dB]
						[dBm]	[mW]	[dBm]	[mW]	
0	0	2437.0	4.41	2.41	10.18	17.00	50.12	30.00	1000	13.00
0	1	2437.0	4.75	2.41	10.18	17.34	54.20	30.00	1000	12.66
0	2	2437.0	4.51	2.41	10.18	17.10	51.29	30.00	1000	12.90
0	3	2437.0	6.47	2.41	10.18	19.06	80.54	30.00	1000	10.94
0	4	2437.0	6.71	2.41	10.18	19.30	85.11	30.00	1000	10.70
0	5	2437.0	6.71	2.41	10.18	19.30	85.11	30.00	1000	10.70
0	6	2437.0	6.30	2.41	10.18	18.89	77.45	30.00	1000	11.11
0	7	2437.0	6.27	2.41	10.18	18.86	76.91	30.00	1000	11.14
0	8	2437.0	6.63	2.41	10.18	19.22	83.56	30.00	1000	10.78
0	9	2437.0	6.29	2.41	10.18	18.88	77.27	30.00	1000	11.12

Antenna 1

	Mode (MCS)	Freq. [MHz]	P/M (Peak) Reading [dBm]	Cable Loss [dB]	Atten. Loss [dB]	Result		Limit		Margin [dB]
						[dBm]	[mW]	[dBm]	[mW]	
1	0	2437.0	4.70	2.41	10.18	17.29	53.58	30.00	1000	12.71
1	1	2437.0	4.84	2.41	10.18	17.43	55.34	30.00	1000	12.57
1	2	2437.0	4.56	2.41	10.18	17.15	51.88	30.00	1000	12.85
1	3	2437.0	6.84	2.41	10.18	19.43	87.70	30.00	1000	10.57
1	4	2437.0	7.01	2.41	10.18	19.60	91.20	30.00	1000	10.40
1	5	2437.0	6.82	2.41	10.18	19.41	87.30	30.00	1000	10.59
1	6	2437.0	6.97	2.41	10.18	19.56	90.36	30.00	1000	10.44
1	7	2437.0	6.26	2.41	10.18	18.85	76.74	30.00	1000	11.15
1	8	2437.0	6.63	2.41	10.18	19.22	83.56	30.00	1000	10.78
1	9	2437.0	6.68	2.41	10.18	19.27	84.53	30.00	1000	10.73

Worst

Sample Calculation:

Result = Reading + Cable Loss (including the cable(s) customer supplied) + Atten. Loss

UL Japan, Inc.
Shonan EMC Lab.

1-22-3 Megumigaoka, Hiratsuka-shi, Kanagawa 259-1220 JAPAN

Telephone : +81 463 50 6400

Facsimile : +81 463 50 6401

Maximum Peak Conducted Output Power

(PKPM1)

Test place UL Japan, Inc. Shonan EMC Lab. No.1 Measurement Room
Date January 10, 2019
Temperature / Humidity 23 deg.C , 51 %RH
Engineer Yosuke Ishikawa
Mode Tx, OFDM VHT40 (SISO), PN9, worst antenna : 1 worst data mode : 4 (MCS)

(* P/M: Power Meter with power sensor)

Ch	Freq. [MHz]	P/M (Peak) Reading [dBm]	Cable Loss [dB]	Atten. Loss [dB]	Result		Limit		Margin [dB]
					[dBm]	[mW]	[dBm]	[mW]	
High2	2457.0	6.68	2.42	10.18	19.28	84.72	30.00	1000	10.72
High3	2462.0	6.73	2.42	10.18	19.33	85.70	30.00	1000	10.67

Sample Calculation:

Result = Reading + Cable Loss (including the cable(s) customer supplied) + Atten. Loss

* The pre-check was measured on 2437 MHz transmission as the representative.

UL Japan, Inc.
Shonan EMC Lab.

1-22-3 Megumigaoka, Hiratsuka-shi, Kanagawa 259-1220 JAPAN

Telephone : +81 463 50 6400

Facsimile : +81 463 50 6401

Maximum Peak Conducted Output Power (PKPM1)

Test place UL Japan, Inc. Shonan EMC Lab. No.1 Measurement Room
Date January 11, 2019
Temperature / Humidity 24 deg.C , 51 %RH
Engineer Yosuke Ishikawa
Mode Tx, IEEE802.11n HT40 (MIMO), PN9, worst data mode : 11 (MCS)

Antenna 0 + Antenna 1

Ch	Freq. [MHz]	Result Ant 0 [mW]	Result Ant 1 [mW]	Result Ant 0 + Ant 1		Limit		Margin [dB]
				[dBm]	[mW]	[dBm]	[mW]	
Low	2422.0	70.63	79.43	21.76	150.06	30.00	1000	8.24
Mid	2437.0	69.50	77.45	21.67	146.95	30.00	1000	8.33
High1	2452.0	65.31	77.62	21.55	142.93	30.00	1000	8.45

Antenna 0

(* P/M: Power Meter with power sensor)

Ch	Freq. [MHz]	P/M (Peak) Reading [dBm]	Cable Loss [dB]	Atten. Loss [dB]	Result	
					[dBm]	[mW]
Low	2422.0	5.90	2.41	10.18	18.49	70.63
Mid	2437.0	5.83	2.41	10.18	18.42	69.50
High1	2452.0	5.55	2.42	10.18	18.15	65.31

Antenna 1

(* P/M: Power Meter with power sensor)

Ch	Freq. [MHz]	P/M (Peak) Reading [dBm]	Cable Loss [dB]	Atten. Loss [dB]	Result	
					[dBm]	[mW]
Low	2422.0	6.41	2.41	10.18	19.00	79.43
Mid	2437.0	6.30	2.41	10.18	18.89	77.45
High1	2452.0	6.30	2.42	10.18	18.90	77.62

Sample Calculation:

Result = Reading + Cable Loss (including the cable(s) customer supplied) + Atten. Loss

[Pre check]

Mode (MCS)	Freq. [MHz]	Cable Loss [dB]	Atten. Loss [dB]	Antenna 0		Antenna 1		Antenna 0 + 1 Total Result	
				Reading [dBm]	Result [dBm]	Reading [dBm]	Result [dBm]	[dBm]	[mW]
8	2437.0	2.41	10.18	4.04	16.63	4.05	16.64	19.65	92.16
9	2437.0	2.41	10.18	3.99	16.58	4.21	16.80	19.70	93.36
10	2437.0	2.41	10.18	3.54	16.13	4.02	16.61	19.39	86.83
11	2437.0	2.41	10.18	5.83	18.42	6.30	18.89	21.67	146.95
12	2437.0	2.41	10.18	5.71	18.30	5.81	18.40	21.36	136.79
13	2437.0	2.41	10.18	5.70	18.29	5.92	18.51	21.41	138.41
14	2437.0	2.41	10.18	5.90	18.49	5.87	18.46	21.49	140.78
15	2437.0	2.41	10.18	5.74	18.33	6.13	18.72	21.54	142.55

Worst

Sample Calculation:

Result = Reading + Cable Loss (including the cable(s) customer supplied) + Atten. Loss

Total Result [mW] = $10^{(\text{Antenna 0 Result} / 10)} + 10^{(\text{Antenna 1 Result} / 10)}$

Total Result [dBm] = $10 * \log(\text{Total Result [mW]})$

UL Japan, Inc.
Shonan EMC Lab.

1-22-3 Megumigaoka, Hiratsuka-shi, Kanagawa 259-1220 JAPAN

Telephone : +81 463 50 6400

Facsimile : +81 463 50 6401

Maximum Peak Conducted Output Power (PKPM1)

Test place UL Japan, Inc. Shonan EMC Lab. No.1 Measurement Room
 Date January 11, 2019
 Temperature / Humidity 24 deg.C , 51 %RH
 Engineer Yosuke Ishikawa
 Mode Tx, IEEE802.11n HT40 (MIMO), PN9, worst data mode : 11 (MCS)

Antenna 0 + Antenna 1

Ch	Freq. [MHz]	Result Ant 0 [mW]	Result Ant 1 [mW]	Result Ant 0 + Ant 1		Limit		Margin [dB]
				[dBm]	[mW]	[dBm]	[mW]	
High2	2457.0	67.92	75.86	21.58	143.78	30.00	1000	8.42
High3	2462.0	33.50	41.69	18.76	75.19	30.00	1000	11.24

Antenna 0

(* P/M: Power Meter with power sensor)

Ch	Freq. [MHz]	P/M (Peak) Reading [dBm]	Cable Loss [dB]	Atten. Loss [dB]	Result	
					[dBm]	[mW]
High2	2457.0	5.72	2.42	10.18	18.32	67.92
High3	2462.0	2.65	2.42	10.18	15.25	33.50

Antenna 1

(* P/M: Power Meter with power sensor)

Ch	Freq. [MHz]	P/M (Peak) Reading [dBm]	Cable Loss [dB]	Atten. Loss [dB]	Result	
					[dBm]	[mW]
High2	2457.0	6.20	2.42	10.18	18.80	75.86
High3	2462.0	3.60	2.42	10.18	16.20	41.69

Sample Calculation:

Result = Reading + Cable Loss (including the cable(s) customer supplied) + Atten. Loss

* The pre-check was measured on 2437 MHz transmission as the representative.

**UL Japan, Inc.
 Shonan EMC Lab.**

1-22-3 Megumigaoka, Hiratsuka-shi, Kanagawa 259-1220 JAPAN
 Telephone : +81 463 50 6400
 Facsimile : +81 463 50 6401

Maximum Peak Conducted Output Power

(PKPM1)

Test place UL Japan, Inc. Shonan EMC Lab. No.1 Measurement Room
 Date January 11, 2019
 Temperature / Humidity 24 deg.C , 51 %RH
 Engineer Yosuke Ishikawa
 Mode Tx, OFDM VHT40 (MIMO), PN9, worst data mode : 3 (MCS)

Antenna 0 + Antenna 1

Ch	Freq. [MHz]	Result Ant 0 [mW]	Result Ant 1 [mW]	Result Ant 0 + Ant 1		Limit		Margin [dB]
				[dBm]	[mW]	[dBm]	[mW]	
Low	2422.0	71.78	73.79	21.63	145.57	30.00	1000	8.37
Mid	2437.0	68.23	79.98	21.71	148.21	30.00	1000	8.29
High1	2452.0	65.01	73.45	21.41	138.46	30.00	1000	8.59

Antenna 0

(* P/M: Power Meter with power sensor)

Ch	Freq. [MHz]	P/M (Peak) Reading [dBm]	Cable Loss [dB]	Atten. Loss [dB]	Result	
					[dBm]	[mW]
Low	2422.0	5.97	2.41	10.18	18.56	71.78
Mid	2437.0	5.75	2.41	10.18	18.34	68.23
High1	2452.0	5.53	2.42	10.18	18.13	65.01

Antenna 1

(* P/M: Power Meter with power sensor)

Ch	Freq. [MHz]	P/M (Peak) Reading [dBm]	Cable Loss [dB]	Atten. Loss [dB]	Result	
					[dBm]	[mW]
Low	2422.0	6.09	2.41	10.18	18.68	73.79
Mid	2437.0	6.44	2.41	10.18	19.03	79.98
High1	2452.0	6.06	2.42	10.18	18.66	73.45

Sample Calculation:

Result = Reading + Cable Loss (including the cable(s) customer supplied) + Atten. Loss

[Pre check]

Mode (MCS)	Freq. [MHz]	Cable Loss [dB]	Atten. Loss [dB]	Antenna 0		Antenna 1		Antenna 0 + 1	
				Reading [dBm]	Result [dBm]	Reading [dBm]	Result [dBm]	Total Result [dBm]	Total Result [mW]
0	2437.0	2.41	10.18	3.92	16.51	4.23	16.82	19.68	92.85
1	2437.0	2.41	10.18	3.82	16.41	4.25	16.84	19.64	92.06
2	2437.0	2.41	10.18	3.74	16.33	4.14	16.73	19.54	90.05
3	2437.0	2.41	10.18	5.75	18.34	6.44	19.03	21.71	148.21
4	2437.0	2.41	10.18	5.91	18.50	6.11	18.70	21.61	144.92
5	2437.0	2.41	10.18	5.65	18.24	5.91	18.50	21.38	137.47
6	2437.0	2.41	10.18	5.77	18.36	6.16	18.75	21.57	143.54
7	2437.0	2.41	10.18	5.90	18.49	6.13	18.72	21.62	145.10
8	2437.0	2.41	10.18	5.69	18.28	6.00	18.59	21.45	139.58
9	2437.0	2.41	10.18	5.82	18.41	5.89	18.48	21.46	139.81

Worst

Sample Calculation:

Result = Reading + Cable Loss (including the cable(s) customer supplied) + Atten. Loss

Total Result [mW] = 10 ^ (Antenna 0 Result / 10) + 10 ^ (Antenna 1 Result / 10)

Total Result [dBm] = 10 * log (Total Result [mW])

UL Japan, Inc.
Shonan EMC Lab.

1-22-3 Megumigaoka, Hiratsuka-shi, Kanagawa 259-1220 JAPAN

Telephone : +81 463 50 6400

Facsimile : +81 463 50 6401

Maximum Peak Conducted Output Power

(PKPM1)

Test place UL Japan, Inc. Shonan EMC Lab. No.1 Measurement Room
 Date January 11, 2019
 Temperature / Humidity 24 deg.C , 51 %RH
 Engineer Yosuke Ishikawa
 Mode Tx, OFDM VHT40 (MIMO), PN9, worst data mode : 3 (MCS)

Antenna 0 + Antenna 1

Ch	Freq. [MHz]	Result Ant 0 [mW]	Result Ant 1 [mW]	Result Ant 0 + Ant 1		Limit		Margin [dB]
				[dBm]	[mW]	[dBm]	[mW]	
High2	2457.0	66.53	78.70	21.62	145.23	30.00	1000	8.38
High3	2462.0	32.96	38.73	18.55	71.69	30.00	1000	11.45

Antenna 0

(* P/M: Power Meter with power sensor)

Ch	Freq. [MHz]	P/M (Peak) Reading [dBm]	Cable Loss [dB]	Atten. Loss [dB]	Result	
					[dBm]	[mW]
High2	2457.0	5.63	2.42	10.18	18.23	66.53
High3	2462.0	2.58	2.42	10.18	15.18	32.96

Antenna 1

(* P/M: Power Meter with power sensor)

Ch	Freq. [MHz]	P/M (Peak) Reading [dBm]	Cable Loss [dB]	Atten. Loss [dB]	Result	
					[dBm]	[mW]
High2	2457.0	6.36	2.42	10.18	18.96	78.70
High3	2462.0	3.28	2.42	10.18	15.88	38.73

Sample Calculation:

Result = Reading + Cable Loss (including the cable(s) customer supplied) + Atten. Loss

* The pre-check was measured on 2437 MHz transmission as the representative.

UL Japan, Inc.
Shonan EMC Lab.

1-22-3 Megumigaoka, Hiratsuka-shi, Kanagawa 259-1220 JAPAN
 Telephone : +81 463 50 6400
 Facsimile : +81 463 50 6401

Maximum Conducted Output Power (Reference data)

(AVGPM)

Test place UL Japan, Inc. Shonan EMC Lab. No.1 Measurement Room
 Date January 7, 2019
 Temperature / Humidity 23 deg.C , 24 %RH
 Engineer Yosuke Ishikawa
 Mode Tx, Bluetooth Low Energy, PN9,

(* P/M: Power Meter with power sensor, AV: Average)

Ch	Freq. [MHz]	P/M (AV) Reading [dBm]	Cable Loss [dB]	Atten. Loss [dB]	Duty Factor [dB]	Result	
						[dBm]	[mW]
Low	2402.0	-14.02	2.40	10.18	1.78	0.34	1.08
Mid	2440.0	-13.77	2.41	10.18	1.78	0.60	1.15
High	2480.0	-13.84	2.42	10.18	1.78	0.54	1.13

Sample Calculation:

Result = Reading + Cable Loss (including the cable(s) customer supplied) + Atten. Loss + Duty Factor

Deviation = Typical Power + Power Range - Result

UL Japan, Inc.
Shonan EMC Lab.

1-22-3 Megumigaoka, Hiratsuka-shi, Kanagawa 259-1220 JAPAN

Telephone : +81 463 50 6400

Facsimile : +81 463 50 6401

Maximum Conducted Output Power (Reference data)

(AVGPM)

Test place UL Japan, Inc. Shonan EMC Lab. No.1 Measurement Room
 Date January 10, 2019
 Temperature / Humidity 23 deg.C , 51 %RH
 Engineer Yosuke Ishikawa
 Mode Tx, IEEE802.11b, PN9, worst antenna : 1 tested data mode : 11 Mbps

(* P/M: Power Meter with power sensor, AV: Average)

Ch	Freq. [MHz]	P/M (AV) Reading [dBm]	Cable Loss [dB]	Atten. Loss [dB]	Duty Factor [dB]	Result	
						[dBm]	[mW]
Low	2412.0	4.32	2.41	10.18	0.43	17.34	54.20
Mid	2437.0	4.24	2.41	10.18	0.43	17.26	53.21
High1	2462.0	4.01	2.42	10.18	0.43	17.04	50.58

Sample Calculation:

Result = Reading + Cable Loss (including the cable(s) customer supplied) + Atten. Loss + Duty Factor

Deviation = Typical Power + Power Range - Result

* This data shows output power is appropriate for maximum typical power at tested data mode.

UL Japan, Inc.
Shonan EMC Lab.

1-22-3 Megumigaoka, Hiratsuka-shi, Kanagawa 259-1220 JAPAN

Telephone : +81 463 50 6400

Facsimile : +81 463 50 6401

Maximum Conducted Output Power (Reference data)

(AVGPM)

Test place UL Japan, Inc. Shonan EMC Lab. No.1 Measurement Room
Date January 10, 2019
Temperature / Humidity 23 deg.C , 51 %RH
Engineer Yosuke Ishikawa
Mode Tx, IEEE802.11b, PN9, worst antenna : 1 tested data mode : 11 Mbps

(* P/M: Power Meter with power sensor, AV: Average)

Ch	Freq. [MHz]	P/M (AV) Reading [dBm]	Cable Loss [dB]	Atten. Loss [dB]	Duty Factor [dB]	Result	
						[dBm]	[mW]
High2	2467.0	-4.53	2.42	10.18	0.43	8.50	7.08
High3	2472.0	-9.44	2.42	10.18	0.43	3.59	2.29

Sample Calculation:

Result = Reading + Cable Loss (including the cable(s) customer supplied) + Atten. Loss + Duty Factor

Deviation = Typical Power + Power Range - Result

* This data shows output power is appropriate for maximum typical power at tested data mode.

UL Japan, Inc.
Shonan EMC Lab.

1-22-3 Megumigaoka, Hiratsuka-shi, Kanagawa 259-1220 JAPAN

Telephone : +81 463 50 6400

Facsimile : +81 463 50 6401

Maximum Conducted Output Power (Reference data)

(AVGPM)

Test place UL Japan, Inc. Shonan EMC Lab. No.1 Measurement Room
Date February 16, 2019
Temperature / Humidity 23 deg.C , 44 %RH
Engineer Yosuke Ishikawa
Mode Tx, IEEE802.11g, PN9, worst antenna : 1 tested data mode : 48 Mbps

(* P/M: Power Meter with power sensor, AV: Average)

Ch	Freq. [MHz]	P/M (AV) Reading [dBm]	Cable Loss [dB]	Atten. Loss [dB]	Duty Factor [dB]	Result	
						[dBm]	[mW]
Low1	2412.0	0.13	2.41	10.18	1.77	14.49	28.12

Sample Calculation:

Result = Reading + Cable Loss (including the cable(s) customer supplied) + Atten. Loss + Duty Factor

Deviation = Typical Power + Power Range - Result

* This data shows output power is appropriate for maximum typical power at tested data mode.

UL Japan, Inc.
Shonan EMC Lab.

1-22-3 Megumigaoka, Hiratsuka-shi, Kanagawa 259-1220 JAPAN
Telephone : +81 463 50 6400
Facsimile : +81 463 50 6401

Maximum Conducted Output Power (Reference data)

(AVGPM)

Test place UL Japan, Inc. Shonan EMC Lab. No.1 Measurement Room
Date January 10, 2019 February 16, 2019
Temperature / Humidity 23 deg.C , 51 %RH 23 deg.C , 44 %RH
Engineer Yosuke Ishikawa Yosuke Ishikawa
Mode Tx, IEEE802.11g, PN9, worst antenna : 1 tested data mode : 48 Mbps

(* P/M: Power Meter with power sensor, AV: Average)

Ch	Freq. [MHz]	P/M (AV) Reading [dBm]	Cable Loss [dB]	Atten. Loss [dB]	Duty Factor [dB]	Result	
						[dBm]	[mW]
Low2	2417.0	0.06	2.41	10.18	1.77	14.42	27.67
Mid	2437.0	-0.18	2.41	10.18	1.77	14.18	26.18
High1	2462.0	-0.20	2.42	10.18	1.77	14.17	26.12

Sample Calculation:

Result = Reading + Cable Loss (including the cable(s) customer supplied) + Atten. Loss + Duty Factor

Deviation = Typical Power + Power Range - Result

* This data shows output power is appropriate for maximum typical power at tested data mode.

UL Japan, Inc.
Shonan EMC Lab.

1-22-3 Megumigaoka, Hiratsuka-shi, Kanagawa 259-1220 JAPAN

Telephone : +81 463 50 6400

Facsimile : +81 463 50 6401

Maximum Conducted Output Power (Reference data)

(AVGPM)

Test place UL Japan, Inc. Shonan EMC Lab. No.1 Measurement Room
Date January 10, 2019
Temperature / Humidity 23 deg.C , 51 %RH
Engineer Yosuke Ishikawa
Mode Tx, IEEE802.11g, PN9, worst antenna : 1 tested data mode : 48 Mbps

(* P/M: Power Meter with power sensor, AV: Average)

Ch	Freq. [MHz]	P/M (AV) Reading [dBm]	Cable Loss [dB]	Atten. Loss [dB]	Duty Factor [dB]	Result	
						[dBm]	[mW]
Hgih2	2467.0	-6.01	2.42	10.18	1.77	8.36	6.85
High3	2472.0	-10.41	2.42	10.18	1.77	3.96	2.49

Sample Calculation:

Result = Reading + Cable Loss (including the cable(s) customer supplied) + Atten. Loss + Duty Factor

Deviation = Typical Power + Power Range - Result

* This data shows output power is appropriate for maximum typical power at tested data mode.

UL Japan, Inc.
Shonan EMC Lab.

1-22-3 Megumigaoka, Hiratsuka-shi, Kanagawa 259-1220 JAPAN
Telephone : +81 463 50 6400
Facsimile : +81 463 50 6401

Maximum Conducted Output Power (Reference data)

(AVGPM)

Test place UL Japan, Inc. Shonan EMC Lab. No.1 Measurement Room
Date February 16, 2019
Temperature / Humidity 23 deg.C , 44 %RH
Engineer Yosuke Ishikawa
Mode Tx, IEEE802.11n HT20 (SISO), PN9, worst antenna : 1 tested data mode : 4 (MCS)

(* P/M: Power Meter with power sensor, AV: Average)

Ch	Freq. [MHz]	P/M (AV) Reading [dBm]	Cable Loss [dB]	Atten. Loss [dB]	Duty Factor [dB]	Result	
						[dBm]	[mW]
Low1	2412.0	1.38	2.41	10.18	1.41	15.38	34.51

Sample Calculation:

Result = Reading + Cable Loss (including the cable(s) customer supplied) + Atten. Loss + Duty Factor

Deviation = Typical Power + Power Range - Result

* This data shows output power is appropriate for maximum typical power at tested data mode.

UL Japan, Inc.
Shonan EMC Lab.

1-22-3 Megumigaoka, Hiratsuka-shi, Kanagawa 259-1220 JAPAN

Telephone : +81 463 50 6400

Facsimile : +81 463 50 6401

Maximum Conducted Output Power (Reference data)

(AVGPM)

Test place UL Japan, Inc. Shonan EMC Lab. No.1 Measurement Room
 Date February 16, 2019 March 11, 2019
 Temperature / Humidity 23 deg.C , 44 %RH 21 deg.C , 56 %RH
 Engineer Yosuke Ishikawa Yosuke Ishikawa
 Mode Tx, IEEE802.11n HT20 (SISO), PN9, worst antenna : 1 tested data mode : 3 (MCS)

(* P/M: Power Meter with power sensor, AV: Average)

Ch	Freq. [MHz]	P/M (AV) Reading [dBm]	Cable Loss [dB]	Atten. Loss [dB]	Duty Factor [dB]	Result	
						[dBm]	[mW]
Low2	2417.0	2.43	2.41	10.18	1.03	16.05	40.27
Mid	2437.0	2.45	2.41	10.18	1.03	16.07	40.46
High1	2462.0	2.38	2.42	10.18	1.03	16.01	39.90

Sample Calculation:

Result = Reading + Cable Loss (including the cable(s) customer supplied) + Atten. Loss + Duty Factor

Deviation = Typical Power + Power Range - Result

* This data shows output power is appropriate for maximum typical power at tested data mode.

UL Japan, Inc.
Shonan EMC Lab.

1-22-3 Megumigaoka, Hiratsuka-shi, Kanagawa 259-1220 JAPAN
 Telephone : +81 463 50 6400
 Facsimile : +81 463 50 6401

Maximum Conducted Output Power (Reference data)

(AVGPM)

Test place UL Japan, Inc. Shonan EMC Lab. No.1 Measurement Room
 Date January 10, 2019
 Temperature / Humidity 23 deg.C , 51 %RH
 Engineer Yosuke Ishikawa
 Mode Tx, IEEE802.11n HT20 (SISO), PN9, worst antenna : 1 tested data mode : 3 (MCS)

(* P/M: Power Meter with power sensor, AV: Average)

Ch	Freq. [MHz]	P/M (AV) Reading [dBm]	Cable Loss [dB]	Atten. Loss [dB]	Duty Factor [dB]	Result	
						[dBm]	[mW]
High2	2467.0	-5.06	2.42	10.18	1.03	8.57	7.19
Hgih3	2472.0	-9.88	2.42	10.18	1.03	3.75	2.37

Sample Calculation:

Result = Reading + Cable Loss (including the cable(s) customer supplied) + Atten. Loss + Duty Factor

Deviation = Typical Power + Power Range - Result

* This data shows output power is appropriate for maximum typical power at tested data mode.

UL Japan, Inc.
Shonan EMC Lab.

1-22-3 Megumigaoka, Hiratsuka-shi, Kanagawa 259-1220 JAPAN

Telephone : +81 463 50 6400

Facsimile : +81 463 50 6401

Maximum Conducted Output Power (Reference data)

(AVGPM)

Test place UL Japan, Inc. Shonan EMC Lab. No.1 Measurement Room
Date February 16, 2019
Temperature / Humidity 23 deg.C , 44 %RH
Engineer Yosuke Ishikawa
Mode Tx, OFDM VHT20 (SISO), PN9, worst antenna : 1 tested data mode : 4 (MCS)

(* P/M: Power Meter with power sensor, AV: Average)

Ch	Freq. [MHz]	P/M (AV) Reading [dBm]	Cable Loss [dB]	Atten. Loss [dB]	Duty Factor [dB]	Result	
						[dBm]	[mW]
Low1	2412.0	1.44	2.41	10.18	1.38	15.41	34.75

Sample Calculation:

Result = Reading + Cable Loss (including the cable(s) customer supplied) + Atten. Loss + Duty Factor

Deviation = Typical Power + Power Range - Result

* This data shows output power is appropriate for maximum typical power at tested data mode.

UL Japan, Inc.
Shonan EMC Lab.

1-22-3 Megumigaoka, Hiratsuka-shi, Kanagawa 259-1220 JAPAN
Telephone : +81 463 50 6400
Facsimile : +81 463 50 6401

Maximum Conducted Output Power (Reference data)

(AVGPM)

Test place UL Japan, Inc. Shonan EMC Lab. No.1 Measurement Room
Date February 16, 2019 March 11, 2019
Temperature / Humidity 23 deg.C , 44 %RH 22 deg.C , 55 %RH
Engineer Yosuke Ishikawa Yosuke Ishikawa
Mode Tx, OFDM VHT20 (SISO), PN9, worst antenna : 1 tested data mode : 3 (MCS)

(* P/M: Power Meter with power sensor, AV: Average)

Ch	Freq. [MHz]	P/M (AV) Reading [dBm]	Cable Loss [dB]	Atten. Loss [dB]	Duty Factor [dB]	Result	
						[dBm]	[mW]
Low2	2417.0	2.49	2.41	10.18	1.02	16.10	40.74
Mid	2437.0	2.41	2.41	10.18	1.02	16.02	39.99
High1	2462.0	2.39	2.42	10.18	1.02	16.01	39.90

Sample Calculation:

Result = Reading + Cable Loss (including the cable(s) customer supplied) + Atten. Loss + Duty Factor

Deviation = Typical Power + Power Range - Result

* This data shows output power is appropriate for maximum typical power at tested data mode.

UL Japan, Inc.
Shonan EMC Lab.

1-22-3 Megumigaoka, Hiratsuka-shi, Kanagawa 259-1220 JAPAN

Telephone : +81 463 50 6400

Facsimile : +81 463 50 6401

Maximum Conducted Output Power (Reference data)

(AVGPM)

Test place UL Japan, Inc. Shonan EMC Lab. No.1 Measurement Room
Date January 10, 2019
Temperature / Humidity 23 deg.C , 51 %RH
Engineer Yosuke Ishikawa
Mode Tx, OFDM VHT20 (SISO), PN9, worst antenna : 1 tested data mode : 3 (MCS)

(* P/M: Power Meter with power sensor, AV: Average)

Ch	Freq. [MHz]	P/M (AV) Reading [dBm]	Cable Loss [dB]	Atten. Loss [dB]	Duty Factor [dB]	Result	
						[dBm]	[mW]
High2	2467.0	-5.07	2.42	10.18	1.02	8.55	7.16
High3	2472.0	-9.94	2.42	10.18	1.02	3.68	2.33

Sample Calculation:

Result = Reading + Cable Loss (including the cable(s) customer supplied) + Atten. Loss + Duty Factor

Deviation = Typical Power + Power Range - Result

* This data shows output power is appropriate for maximum typical power at tested data mode.

UL Japan, Inc.
Shonan EMC Lab.

1-22-3 Megumigaoka, Hiratsuka-shi, Kanagawa 259-1220 JAPAN
Telephone : +81 463 50 6400
Facsimile : +81 463 50 6401

Maximum Conducted Output Power (Reference data) (AVGPM)

Test place UL Japan, Inc. Shonan EMC Lab. No.1 Measurement Room
Date February 16, 2019
Temperature / Humidity 23 deg.C , 44 %RH
Engineer Yosuke Ishikawa
Mode Tx, IEEE802.11n HT20 (MIMO), PN9, worst data mode : 14 (MCS)

Antenna 0 + Antenna 1

Ch	Freq. [MHz]	Ant 0 Result [mW]	Ant 1 Result [mW]	Result Ant 0 + Ant 1	
				[dBm]	[mW]
Low1	2412.0	12.85	12.71	14.08	25.56

Antenna 0

(* P/M: Power Meter with power sensor, AV: Average with gate trigger mode)

Ch	Freq. [MHz]	P/M (AV) Reading [dBm]	Cable Loss [dB]	Atten. Loss [dB]	Duty Factor [dB]	Result	
						[dBm]	[mW]
Low1	2412.0	-4.15	2.41	10.18	2.65	11.09	12.85

Antenna 1

(* P/M: Power Meter with power sensor, AV: Average with gate trigger mode)

Ch	Freq. [MHz]	P/M (AV) Reading [dBm]	Cable Loss [dB]	Atten. Loss [dB]	Duty Factor [dB]	Result	
						[dBm]	[mW]
Low1	2412.0	-4.20	2.41	10.18	2.65	11.04	12.71

Sample Calculation:

Result = Reading + Cable Loss (including the cable(s) customer supplied) + Atten. Loss + Duty factor

Deviation = Typical Power + Power Range - Result

* This data shows output power is appropriate for maximum typical power at tested data mode.

UL Japan, Inc.
Shonan EMC Lab.

1-22-3 Megumigaoka, Hiratsuka-shi, Kanagawa 259-1220 JAPAN
Telephone : +81 463 50 6400
Facsimile : +81 463 50 6401

Maximum Conducted Output Power (Reference data)

(AVGPM)

Test place UL Japan, Inc. Shonan EMC Lab. No.1 Measurement Room
 Date January 11, 2019 February 16, 2019
 Temperature / Humidity 24 deg.C , 51 %RH 23 deg.C , 44 %RH
 Engineer Yosuke Ishikawa Yosuke Ishikawa
 Mode Tx, IEEE802.11n HT20 (MIMO), PN9, worst data mode : 14 (MCS)

Antenna 0 + Antenna 1

Ch	Freq. [MHz]	Ant 0 Result [mW]	Ant 1 Result [mW]	Result	
				[dBm]	[mW]
Low2	2417.0	14.89	15.81	14.87	30.70
Mid	2437.0	14.49	16.14	14.86	30.63
High1	2462.0	14.49	15.49	14.77	29.98

Antenna 0

(* P/M: Power Meter with power sensor, AV: Average with gate trigger mode)

Ch	Freq. [MHz]	P/M (AV) Reading [dBm]	Cable Loss [dB]	Atten. Loss [dB]	Duty Factor [dB]	Result	
						[dBm]	[mW]
Low2	2417.0	-3.51	2.41	10.18	2.65	11.73	14.89
Mid	2437.0	-3.63	2.41	10.18	2.65	11.61	14.49
High1	2462.0	-3.64	2.42	10.18	2.65	11.61	14.49

Antenna 1

(* P/M: Power Meter with power sensor, AV: Average with gate trigger mode)

Ch	Freq. [MHz]	P/M (AV) Reading [dBm]	Cable Loss [dB]	Atten. Loss [dB]	Duty Factor [dB]	Result	
						[dBm]	[mW]
Low2	2417.0	-3.25	2.41	10.18	2.65	11.99	15.81
Mid	2437.0	-3.16	2.41	10.18	2.65	12.08	16.14
High1	2462.0	-3.35	2.42	10.18	2.65	11.90	15.49

Sample Calculation:

Result = Reading + Cable Loss (including the cable(s) customer supplied) + Atten. Loss + Duty factor

Deviation = Typical Power + Power Range - Result

* This data shows output power is appropriate for maximum typical power at tested data mode.

UL Japan, Inc.
Shonan EMC Lab.

1-22-3 Megumigaoka, Hiratsuka-shi, Kanagawa 259-1220 JAPAN

Telephone : +81 463 50 6400

Facsimile : +81 463 50 6401

Maximum Conducted Output Power (Reference data)

(AVGPM)

Test place UL Japan, Inc. Shonan EMC Lab. No.1 Measurement Room
 Date January 11, 2019
 Temperature / Humidity 24 deg.C , 51 %RH
 Engineer Yosuke Ishikawa
 Mode Tx, IEEE802.11n HT20 (MIMO), PN9, worst data mode : 14 (MCS)

Antenna 0 + Antenna 1

Ch	Freq. [MHz]	Ant 0	Ant 1	Result	
		Result [mW]	Result [mW]	[dBm]	[mW]
High2	2467.0	2.99	3.53	8.14	6.52
High3	2472.0	0.95	1.22	3.36	2.17

Antenna 0

(* P/M: Power Meter with power sensor, AV: Average with gate trigger mode)

Ch	Freq. [MHz]	P/M (AV)	Cable Loss [dB]	Atten. Loss [dB]	Duty Factor [dB]	Result	
		Reading [dBm]				[dBm]	[mW]
High2	2467.0	-10.49	2.42	10.18	2.65	4.76	2.99
High3	2472.0	-15.49	2.42	10.18	2.65	-0.24	0.95

Antenna 1

(* P/M: Power Meter with power sensor, AV: Average with gate trigger mode)

Ch	Freq. [MHz]	P/M (AV)	Cable Loss [dB]	Atten. Loss [dB]	Duty Factor [dB]	Result	
		Reading [dBm]				[dBm]	[mW]
High2	2467.0	-9.77	2.42	10.18	2.65	5.48	3.53
High3	2472.0	-14.40	2.42	10.18	2.65	0.85	1.22

Sample Calculation:

Result = Reading + Cable Loss (including the cable(s) customer supplied) + Atten. Loss + Duty factor

Deviation = Typical Power + Power Range - Result

* This data shows output power is appropriate for maximum typical power at tested data mode.

UL Japan, Inc.
Shonan EMC Lab.

1-22-3 Megumigaoka, Hiratsuka-shi, Kanagawa 259-1220 JAPAN

Telephone : +81 463 50 6400

Facsimile : +81 463 50 6401

Maximum Conducted Output Power (Reference data)

(AVGPM)

Test place UL Japan, Inc. Shonan EMC Lab. No.1 Measurement Room
Date January 11, 2019 February 16, 2019
Temperature / Humidity 24 deg.C , 51 %RH 23 deg.C , 44 %RH
Engineer Yosuke Ishikawa Yosuke Ishikawa
Mode Tx, OFDM VHT20 (MIMO), PN9, worst data mode : 3 (MCS)

Antenna 0 + Antenna 1

Ch	Freq. [MHz]	Ant 0 Result [mW]	Ant 1 Result [mW]	Result	
				[dBm]	[mW]
Low2	2417.0	15.21	16.75	15.05	31.96
Mid	2437.0	15.00	17.14	15.07	32.14
High1	2462.0	14.49	15.78	14.81	30.27

Antenna 0

(* P/M: Power Meter with power sensor, AV: Average with gate trigger mode)

Ch	Freq. [MHz]	P/M (AV) Reading [dBm]	Cable Loss [dB]	Atten. Loss [dB]	Duty Factor [dB]	Result	
						[dBm]	[mW]
Low2	2417.0	-2.43	2.41	10.18	1.66	11.82	15.21
Mid	2437.0	-2.49	2.41	10.18	1.66	11.76	15.00
High1	2462.0	-2.65	2.42	10.18	1.66	11.61	14.49

Antenna 1

(* P/M: Power Meter with power sensor, AV: Average with gate trigger mode)

Ch	Freq. [MHz]	P/M (AV) Reading [dBm]	Cable Loss [dB]	Atten. Loss [dB]	Duty Factor [dB]	Result	
						[dBm]	[mW]
Low2	2417.0	-2.01	2.41	10.18	1.66	12.24	16.75
Mid	2437.0	-1.91	2.41	10.18	1.66	12.34	17.14
High1	2462.0	-2.28	2.42	10.18	1.66	11.98	15.78

Sample Calculation:

Result = Reading + Cable Loss (including the cable(s) customer supplied) + Atten. Loss + Duty factor

Deviation = Typical Power + Power Range - Result

* This data shows output power is appropriate for maximum typical power at tested data mode.

UL Japan, Inc.
Shonan EMC Lab.

1-22-3 Megumigaoka, Hiratsuka-shi, Kanagawa 259-1220 JAPAN

Telephone : +81 463 50 6400

Facsimile : +81 463 50 6401

Maximum Conducted Output Power (Reference data)

(AVGPM)

Test place UL Japan, Inc. Shonan EMC Lab. No.1 Measurement Room
Date January 10, 2019
Temperature / Humidity 23 deg.C , 51 %RH
Engineer Yosuke Ishikawa
Mode Tx, IEEE802.11n HT40 (SISO), PN9, worst antenna : 1 tested data mode : 6 (MCS)

(* P/M: Power Meter with power sensor, AV: Average)

Ch	Freq. [MHz]	P/M (AV) Reading [dBm]	Cable Loss [dB]	Atten. Loss [dB]	Duty Factor [dB]	Result	
						[dBm]	[mW]
Low	2422.0	-6.30	2.41	10.18	2.77	9.06	8.05
Mid	2437.0	-6.32	2.41	10.18	2.77	9.04	8.02
High1	2452.0	-6.16	2.42	10.18	2.77	9.21	8.34

Sample Calculation:

Result = Reading + Cable Loss (including the cable(s) customer supplied) + Atten. Loss + Duty Factor

Deviation = Typical Power + Power Range - Result

* This data shows output power is appropriate for maximum typical power at tested data mode.

UL Japan, Inc.
Shonan EMC Lab.

1-22-3 Megumigaoka, Hiratsuka-shi, Kanagawa 259-1220 JAPAN
Telephone : +81 463 50 6400
Facsimile : +81 463 50 6401

Maximum Conducted Output Power (Reference data)

(AVGPM)

Test place UL Japan, Inc. Shonan EMC Lab. No.1 Measurement Room
 Date January 10, 2019
 Temperature / Humidity 23 deg.C , 51 %RH
 Engineer Yosuke Ishikawa
 Mode Tx, IEEE802.11n HT40 (SISO), PN9, worst antenna : 1 tested data mode : 6 (MCS)

(* P/M: Power Meter with power sensor, AV: Average)

Ch	Freq. [MHz]	P/M (AV) Reading [dBm]	Cable Loss [dB]	Atten. Loss [dB]	Duty Factor [dB]	Result	
						[dBm]	[mW]
High2	2457.0	-6.26	2.42	10.18	2.77	9.11	8.15
High3	2462.0	-6.14	2.42	10.18	2.77	9.23	8.38

Sample Calculation:

Result = Reading + Cable Loss (including the cable(s) customer supplied) + Atten. Loss + Duty Factor

Deviation = Typical Power + Power Range - Result

* This data shows output power is appropriate for maximum typical power at tested data mode.

UL Japan, Inc.
Shonan EMC Lab.

1-22-3 Megumigaoka, Hiratsuka-shi, Kanagawa 259-1220 JAPAN

Telephone : +81 463 50 6400

Facsimile : +81 463 50 6401

Maximum Conducted Output Power (Reference data)

(AVGPM)

Test place UL Japan, Inc. Shonan EMC Lab. No.1 Measurement Room
 Date January 10, 2019
 Temperature / Humidity 23 deg.C , 51 %RH
 Engineer Yosuke Ishikawa
 Mode Tx, OFDM VHT40 (SISO), PN9, worst antenna : 1 tested data mode : 4 (MCS)

(* P/M: Power Meter with power sensor, AV: Average)

Ch	Freq. [MHz]	P/M (AV) Reading [dBm]	Cable Loss [dB]	Atten. Loss [dB]	Duty Factor [dB]	Result	
						[dBm]	[mW]
Low	2422.0	-5.72	2.41	10.18	2.18	9.05	8.04
Mid	2437.0	-5.81	2.41	10.18	2.18	8.96	7.87
High1	2452.0	-5.77	2.42	10.18	2.18	9.01	7.96

Sample Calculation:

Result = Reading + Cable Loss (including the cable(s) customer supplied) + Atten. Loss + Duty Factor

Deviation = Typical Power + Power Range - Result

* This data shows output power is appropriate for maximum typical power at tested data mode.

UL Japan, Inc.
Shonan EMC Lab.

1-22-3 Megumigaoka, Hiratsuka-shi, Kanagawa 259-1220 JAPAN

Telephone : +81 463 50 6400

Facsimile : +81 463 50 6401

Maximum Conducted Output Power (Reference data)

(AVGPM)

Test place UL Japan, Inc. Shonan EMC Lab. No.1 Measurement Room
Date January 10, 2019
Temperature / Humidity 23 deg.C , 51 %RH
Engineer Yosuke Ishikawa
Mode Tx, OFDM VHT40 (SISO), PN9, worst antenna : 1 tested data mode : 4 (MCS)

(* P/M: Power Meter with power sensor, AV: Average)

Ch	Freq. [MHz]	P/M (AV) Reading [dBm]	Cable Loss [dB]	Atten. Loss [dB]	Duty Factor [dB]	Result	
						[dBm]	[mW]
High2	2457.0	-5.53	2.42	10.18	2.18	9.25	8.41
High3	2462.0	-5.69	2.42	10.18	2.18	9.09	8.11

Sample Calculation:

Result = Reading + Cable Loss (including the cable(s) customer supplied) + Atten. Loss + Duty Factor

Deviation = Typical Power + Power Range - Result

* This data shows output power is appropriate for maximum typical power at tested data mode.

UL Japan, Inc.
Shonan EMC Lab.

1-22-3 Megumigaoka, Hiratsuka-shi, Kanagawa 259-1220 JAPAN
Telephone : +81 463 50 6400
Facsimile : +81 463 50 6401

Maximum Conducted Output Power (Reference data)
(AVGPM)

Test place UL Japan, Inc. Shonan EMC Lab. No.1 Measurement Room
Date January 11, 2019
Temperature / Humidity 24 deg.C , 51 %RH
Engineer Yosuke Ishikawa
Mode Tx, IEEE802.11n HT40 (MIMO), PN9, worst data mode : 11 (MCS)

Antenna 0 + Antenna 1

Ch	Freq. [MHz]	Ant 0 Result [mW]	Ant 1 Result [mW]	Result	
				[dBm]	[mW]
High2	2457.0	6.25	7.48	11.38	13.73
High3	2462.0	3.34	3.92	8.61	7.26

Antenna 0

(* P/M: Power Meter with power sensor, AV: Average with gate trigger mode)

Ch	Freq. [MHz]	P/M (AV) Reading [dBm]	Cable Loss [dB]	Atten. Loss [dB]	Duty Factor [dB]	Result	
						[dBm]	[mW]
High2	2457.0	-7.19	2.42	10.18	2.55	7.96	6.25
High3	2462.0	-9.91	2.42	10.18	2.55	5.24	3.34

Antenna 1

(* P/M: Power Meter with power sensor, AV: Average with gate trigger mode)

Ch	Freq. [MHz]	P/M (AV) Reading [dBm]	Cable Loss [dB]	Atten. Loss [dB]	Duty Factor [dB]	Result	
						[dBm]	[mW]
High2	2457.0	-6.41	2.42	10.18	2.55	8.74	7.48
High3	2462.0	-9.22	2.42	10.18	2.55	5.93	3.92

Sample Calculation:

Result = Reading + Cable Loss (including the cable(s) customer supplied) + Atten. Loss + Duty factor

Deviation = Typical Power + Power Range - Result

* This data shows output power is appropriate for maximum typical power at tested data mode.

UL Japan, Inc.
Shonan EMC Lab.

1-22-3 Megumigaoka, Hiratsuka-shi, Kanagawa 259-1220 JAPAN
Telephone : +81 463 50 6400
Facsimile : +81 463 50 6401

Maximum Conducted Output Power (Reference data)
(AVGPM)

Test place UL Japan, Inc. Shonan EMC Lab. No.1 Measurement Room
Date January 11, 2019
Temperature / Humidity 24 deg.C , 51 %RH
Engineer Yosuke Ishikawa
Mode Tx, OFDM VHT40 (MIMO), PN9, worst data mode : 3 (MCS)

Antenna 0 + Antenna 1

Ch	Freq. [MHz]	Ant 0 Result [mW]	Ant 1 Result [mW]	Result	
				[dBm]	[mW]
Low	2422.0	6.62	7.28	11.43	13.90
Mid	2437.0	6.46	7.45	11.43	13.91
High1	2452.0	6.30	7.48	11.39	13.78

Antenna 0

(* P/M: Power Meter with power sensor, AV: Average with gate trigger mode)

Ch	Freq. [MHz]	P/M (AV) Reading [dBm]	Cable Loss [dB]	Atten. Loss [dB]	Duty Factor [dB]	Result	
						[dBm]	[mW]
Low	2422.0	-6.89	2.41	10.18	2.51	8.21	6.62
Mid	2437.0	-7.00	2.41	10.18	2.51	8.10	6.46
High1	2452.0	-7.12	2.42	10.18	2.51	7.99	6.30

Antenna 1

(* P/M: Power Meter with power sensor, AV: Average with gate trigger mode)

Ch	Freq. [MHz]	P/M (AV) Reading [dBm]	Cable Loss [dB]	Atten. Loss [dB]	Duty Factor [dB]	Result	
						[dBm]	[mW]
Low	2422.0	-6.48	2.41	10.18	2.51	8.62	7.28
Mid	2437.0	-6.38	2.41	10.18	2.51	8.72	7.45
High1	2452.0	-6.37	2.42	10.18	2.51	8.74	7.48

Sample Calculation:

Result = Reading + Cable Loss (including the cable(s) customer supplied) + Atten. Loss + Duty factor

Deviation = Typical Power + Power Range - Result

* This data shows output power is appropriate for maximum typical power at tested data mode.

**UL Japan, Inc.
Shonan EMC Lab.**

1-22-3 Megumigaoka, Hiratsuka-shi, Kanagawa 259-1220 JAPAN
Telephone : +81 463 50 6400
Facsimile : +81 463 50 6401

Maximum Conducted Output Power (Reference data)

(AVGPM)

Test place UL Japan, Inc. Shonan EMC Lab. No.1 Measurement Room
 Date January 11, 2019
 Temperature / Humidity 24 deg.C , 51 %RH
 Engineer Yosuke Ishikawa
 Mode Tx, OFDM VHT40 (MIMO), PN9, worst data mode : 3 (MCS)

Antenna 0 + Antenna 1

Ch	Freq. [MHz]	Ant 0	Ant 1	Result	
		Result [mW]	Result [mW]	[dBm]	[mW]
High2	2457.0	6.34	7.45	11.40	13.79
High3	2462.0	3.21	3.92	8.53	7.13

Antenna 0

(* P/M: Power Meter with power sensor, AV: Average with gate trigger mode)

Ch	Freq. [MHz]	P/M (AV)	Cable Loss [dB]	Atten. Loss [dB]	Duty Factor [dB]	Result	
		Reading [dBm]				[dBm]	[mW]
High2	2457.0	-7.09	2.42	10.18	2.51	8.02	6.34
High3	2462.0	-10.04	2.42	10.18	2.51	5.07	3.21

Antenna 1

(* P/M: Power Meter with power sensor, AV: Average with gate trigger mode)

Ch	Freq. [MHz]	P/M (AV)	Cable Loss [dB]	Atten. Loss [dB]	Duty Factor [dB]	Result	
		Reading [dBm]				[dBm]	[mW]
High2	2457.0	-6.39	2.42	10.18	2.51	8.72	7.45
High3	2462.0	-9.18	2.42	10.18	2.51	5.93	3.92

Sample Calculation:

Result = Reading + Cable Loss (including the cable(s) customer supplied) + Atten. Loss + Duty factor

Deviation = Typical Power + Power Range - Result

* This data shows output power is appropriate for maximum typical power at tested data mode.

UL Japan, Inc.
Shonan EMC Lab.

1-22-3 Megumigaoka, Hiratsuka-shi, Kanagawa 259-1220 JAPAN

Telephone : +81 463 50 6400

Facsimile : +81 463 50 6401

Burst rate confirmation

Tx, Bluetooth Low Energy, PN9

Duty Factor Calculation

Duty Factor (RE): $20\log(1/\text{duty cycle}) = 3.56 \text{ dB}$

Duty Factor (AT): $10\log(1/\text{duty cycle}) = 1.78 \text{ dB}$

duty cycle = $0.4143 \text{ [ms]} / 0.6243 \text{ [ms]} = 0.664 \text{ (66.4 \%)}$

Tx2_duty2

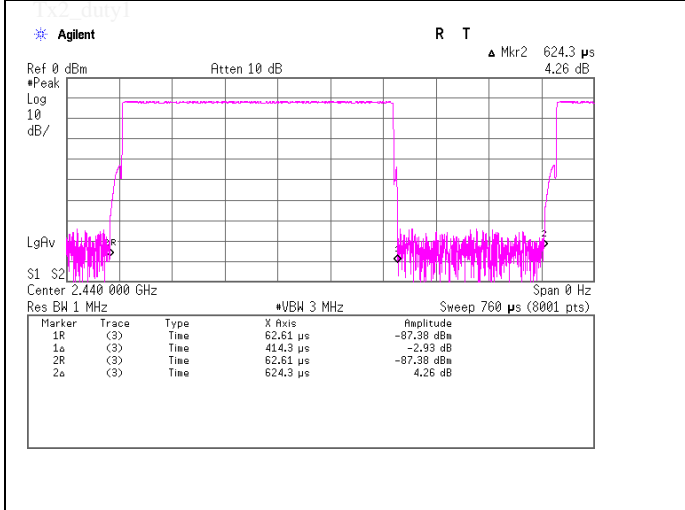

UL Japan, Inc.

Shonan EMC Lab.

1-22-3 Megumigaoka, Hiratsuka-shi, Kanagawa 259-1220 JAPAN

Telephone : +81 463 50 6400

Facsimile : +81 463 50 6401

Burst rate confirmation

Tx, IEEE802.11b, PN9, worst antenna port 1, worst data mode 11 Mbps

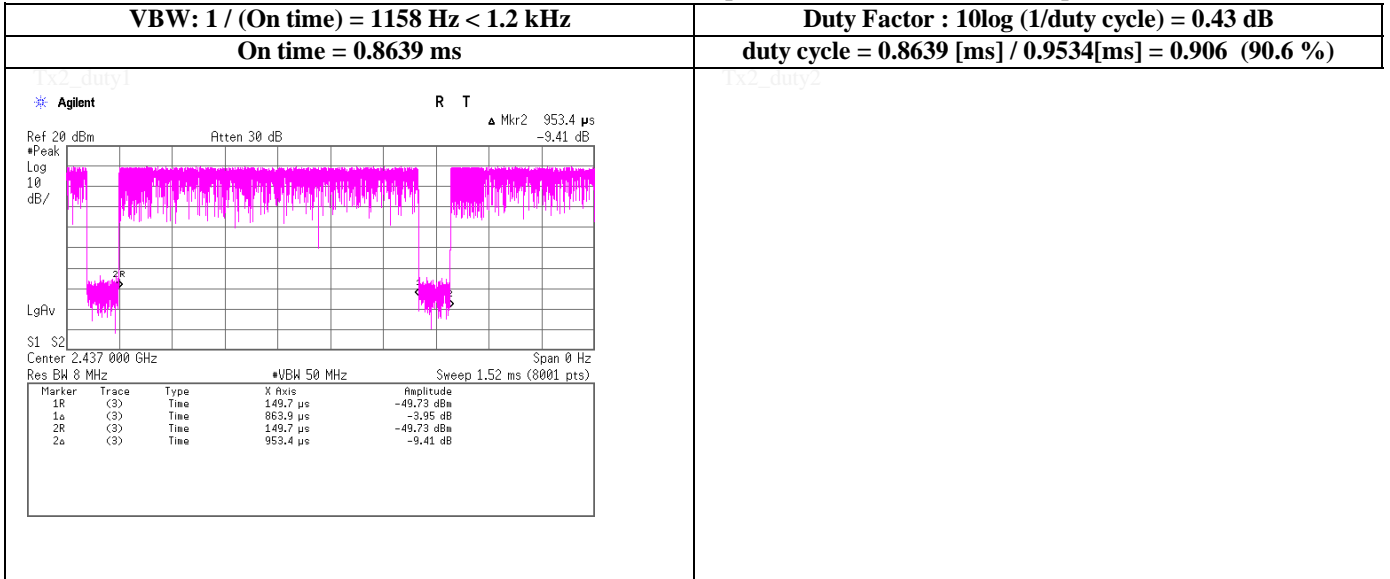

Burst rate confirmation

Tx, IEEE802.11g, PN9, worst antenna port 1, worst data mode 48 Mbps

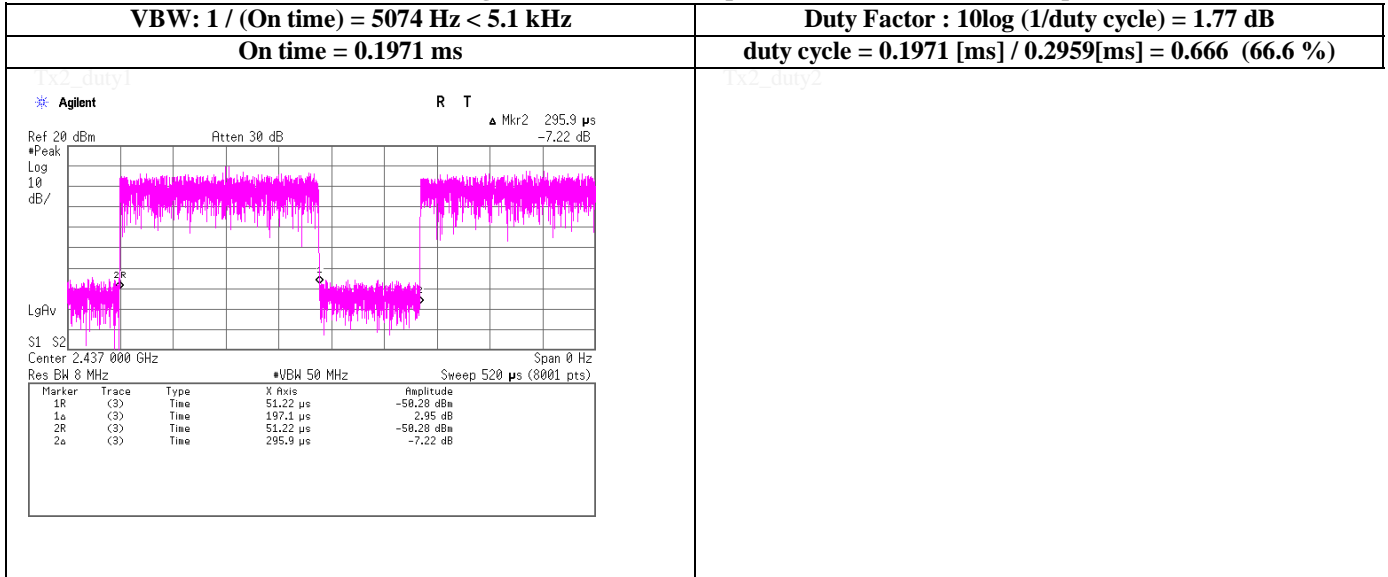

Burst rate confirmation

Tx, IEEE802.11n HT20 (SISO), PN9, worst antenna port 1, worst data mode 4 (MCS)

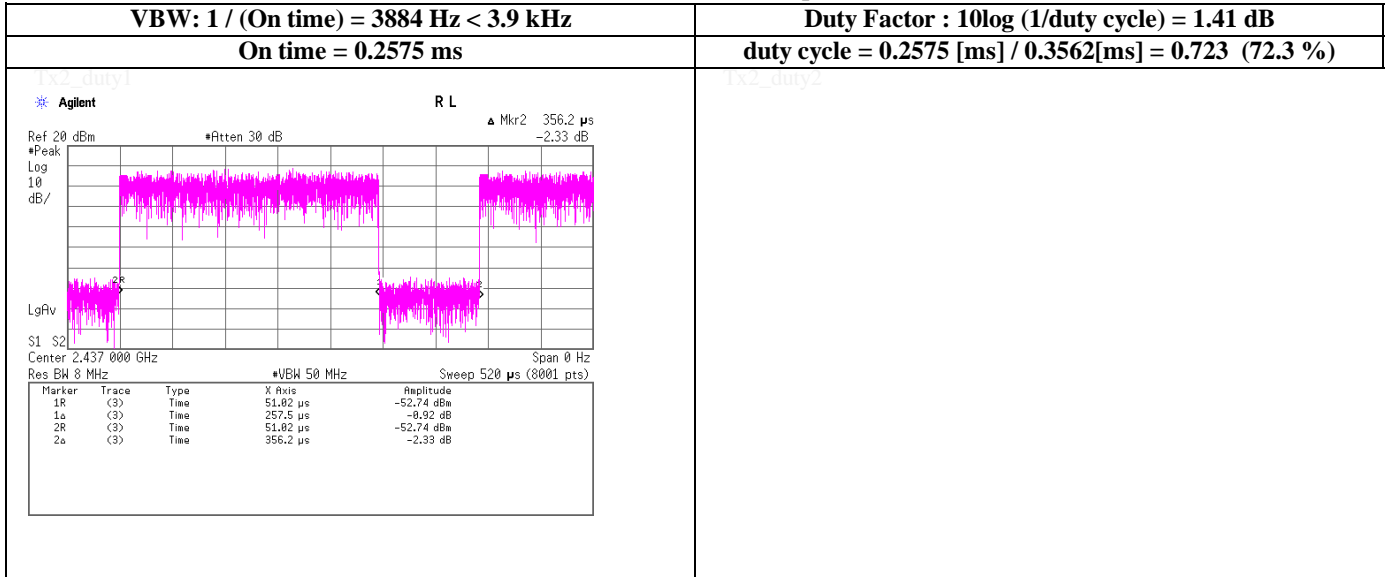

Burst rate confirmation

Tx, IEEE802.11n HT20 (SISO), PN9, worst antenna port 1, worst data mode 3 (MCS)

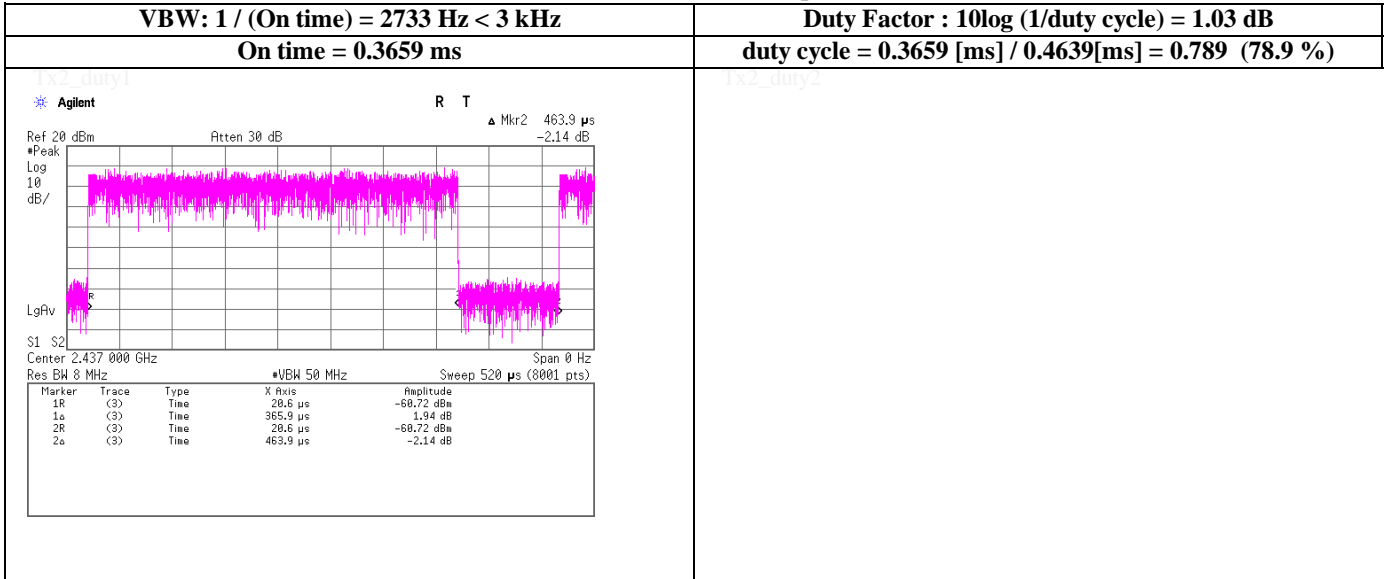

Burst rate confirmation

Tx, OFDM VHT20 (SISO), PN9, worst antenna port 1, worst data mode 4 (MCS)

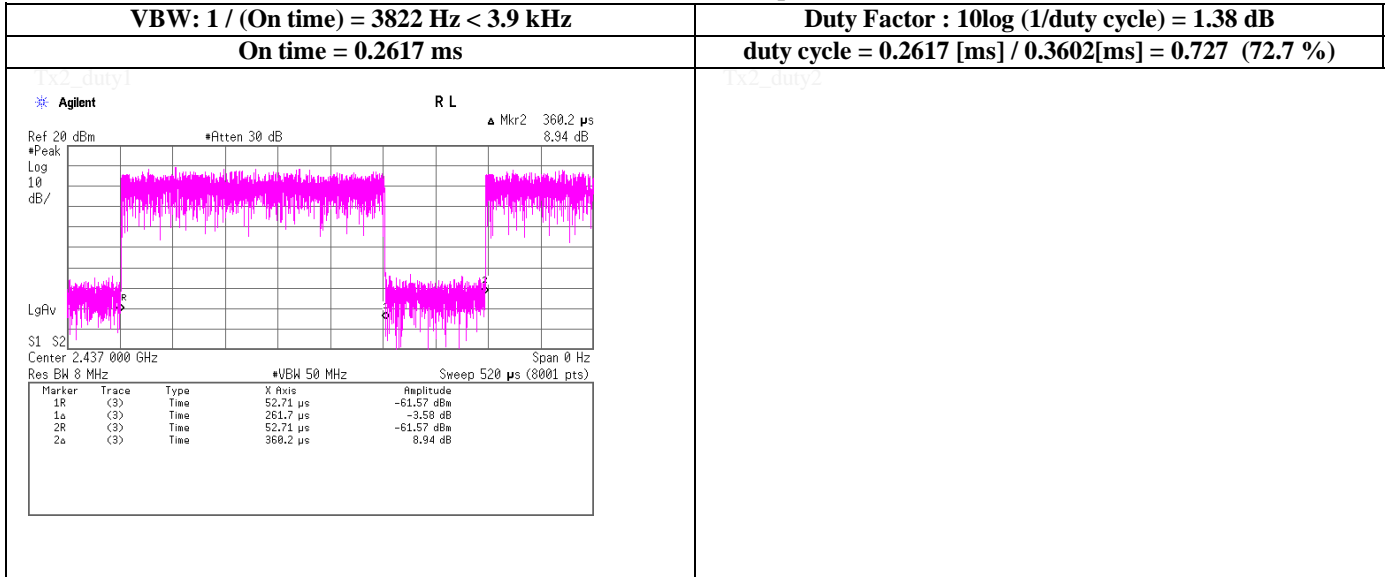

UL Japan, Inc.

Shonan EMC Lab.

1-22-3 Megumigaoka, Hiratsuka-shi, Kanagawa 259-1220 JAPAN

Telephone : +81 463 50 6400

Facsimile : +81 463 50 6401

Burst rate confirmation

Tx, OFDM VHT20 (SISO), PN9, worst antenna port 1, worst data mode 3 (MCS)

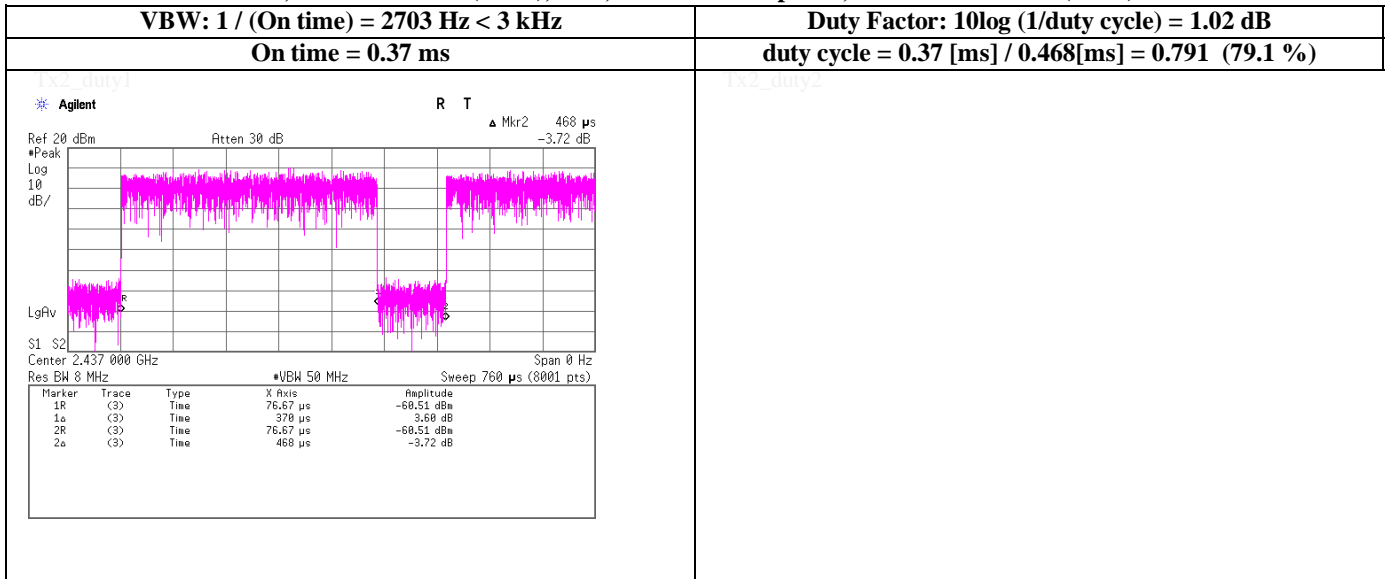

Burst rate confirmation

Tx, IEEE802.11n HT20 (MIMO), PN9, worst data mode 14 (MCS), antenna port: 1

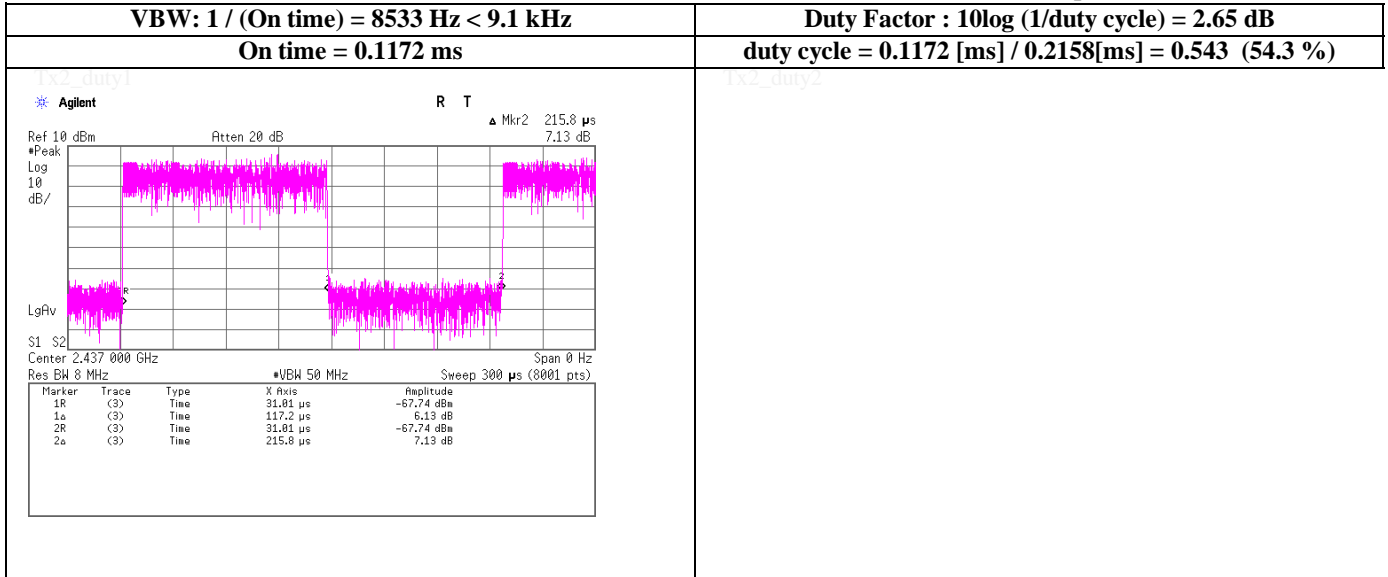

Burst rate confirmation

Tx, OFDM VHT20 (MIMO), PN9, worst data mode 3 (MCS)

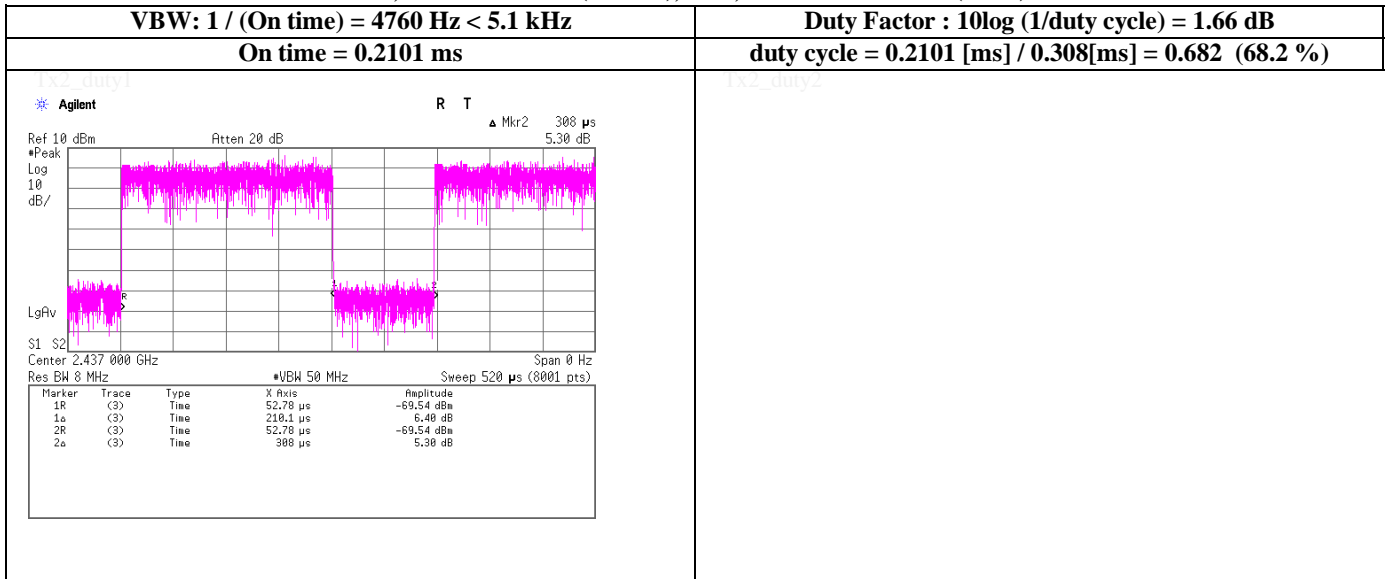

UL Japan, Inc.

Shonan EMC Lab.

1-22-3 Megumigaoka, Hiratsuka-shi, Kanagawa 259-1220 JAPAN

Telephone : +81 463 50 6400

Facsimile : +81 463 50 6401

Burst rate confirmation

Tx, IEEE802.11n HT40 (SISO), PN9, worst antenna port 1, worst data mode 6 (MCS)

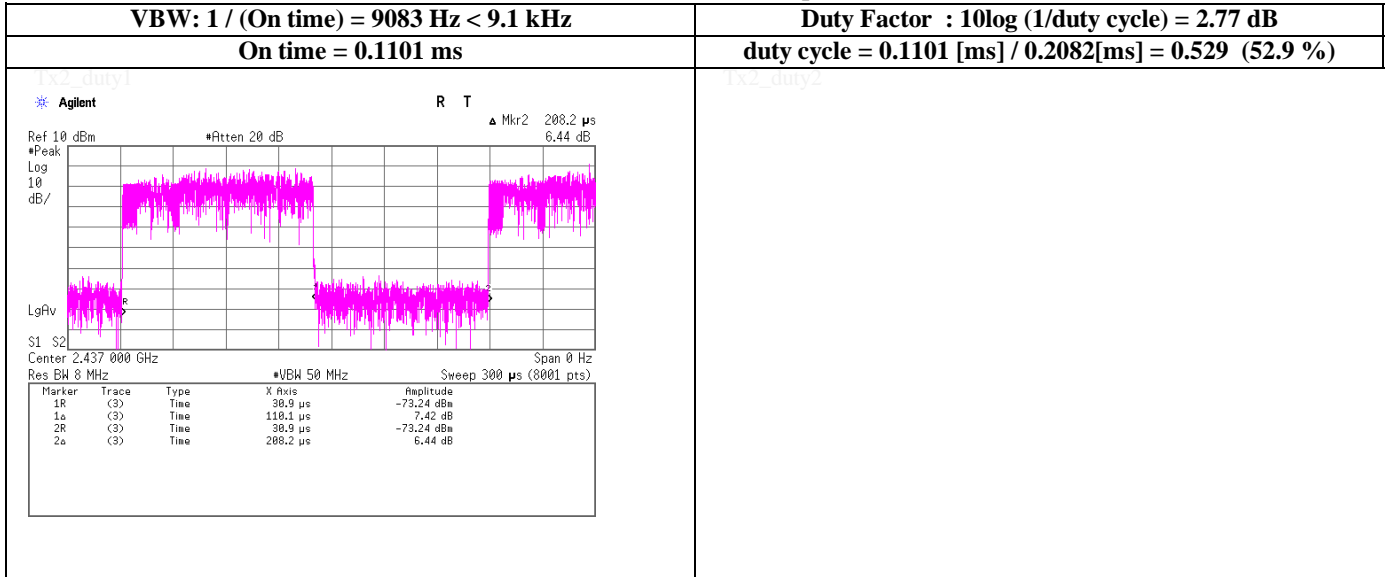

Burst rate confirmation

Tx, OFDM VHT40 (SISO), PN9, worst antenna port 1, worst data mode 4 (MCS)

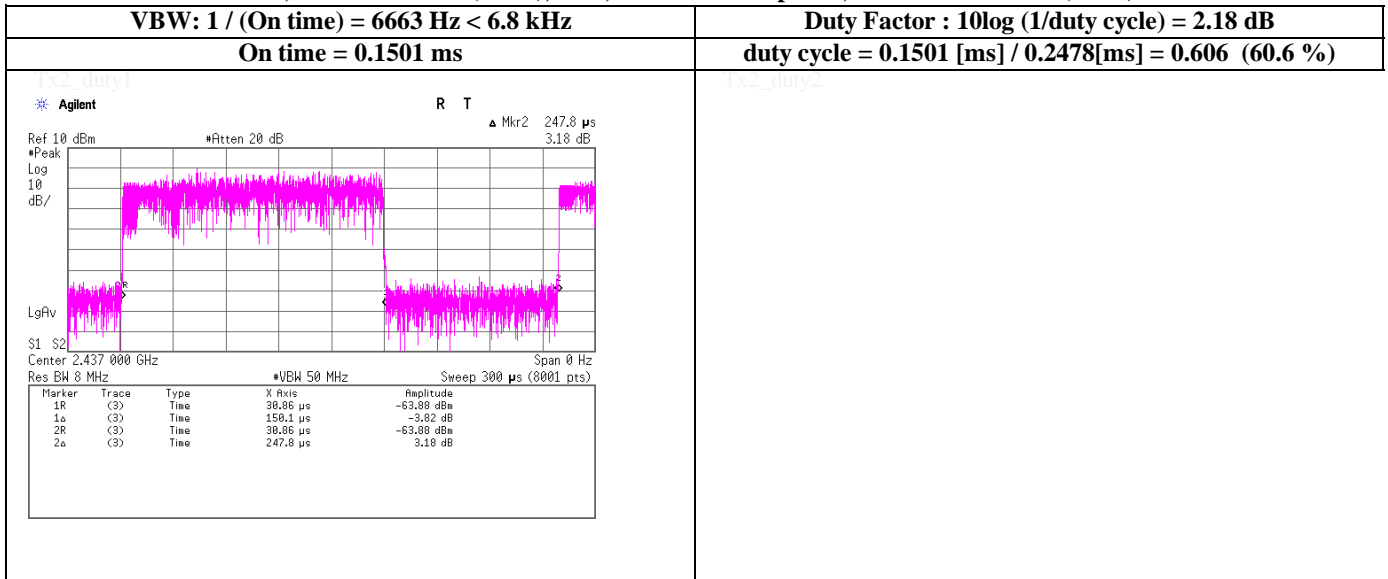

UL Japan, Inc.

Shonan EMC Lab.

1-22-3 Megumigaoka, Hiratsuka-shi, Kanagawa 259-1220 JAPAN

Telephone : +81 463 50 6400

Facsimile : +81 463 50 6401

Burst rate confirmation

Tx, IEEE802.11n HT40 (MIMO), PN9, worst data mode 11 (MCS), antenna port: 1

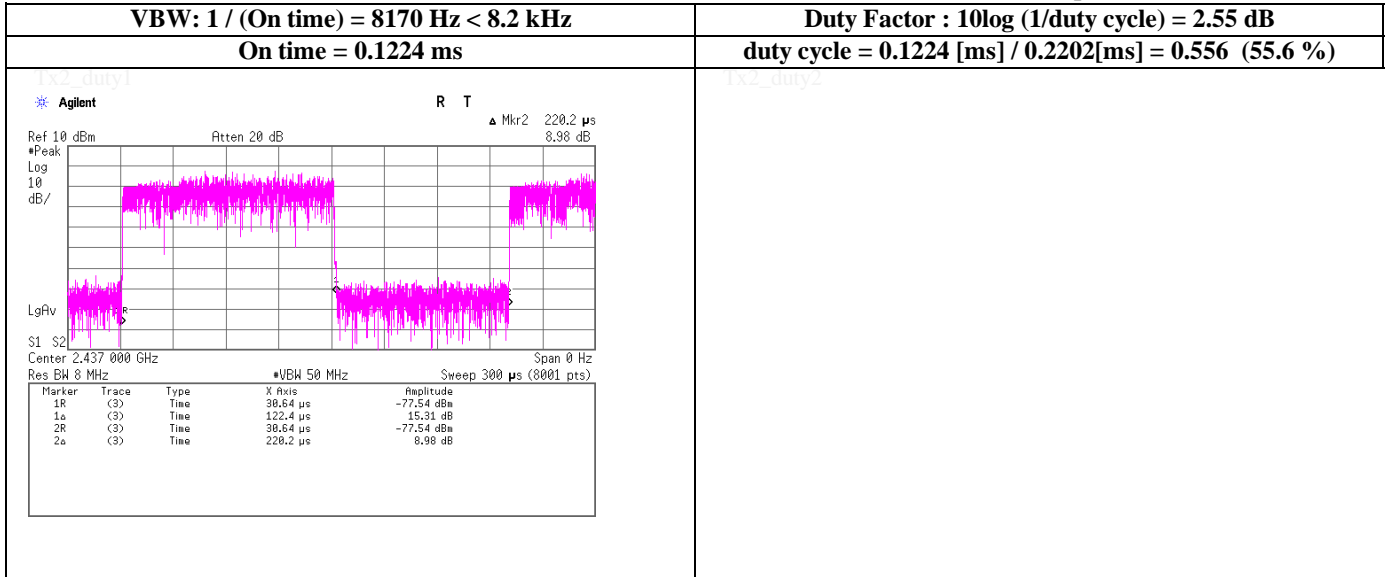

UL Japan, Inc.

Shonan EMC Lab.

1-22-3 Megumigaoka, Hiratsuka-shi, Kanagawa 259-1220 JAPAN

Telephone : +81 463 50 6400

Facsimile : +81 463 50 6401

Burst rate confirmation

Tx, OFDM VHT40 (MIMO), PN9, worst data mode 3 (MCS)

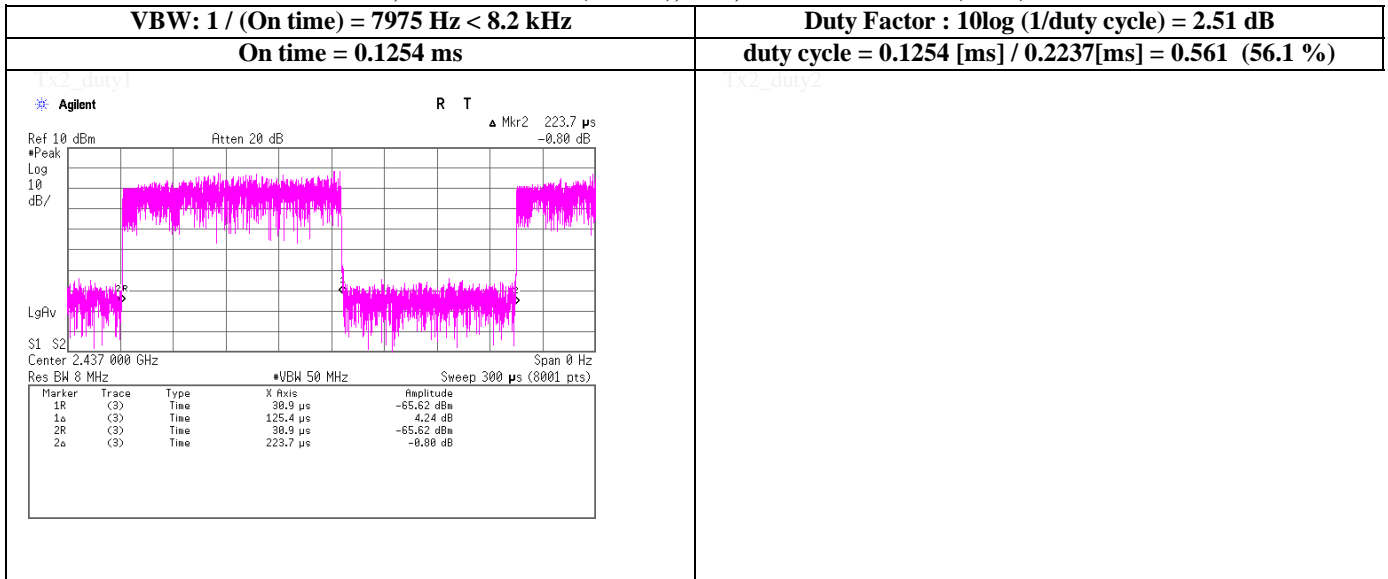

UL Japan, Inc.

Shonan EMC Lab.

1-22-3 Megumigaoka, Hiratsuka-shi, Kanagawa 259-1220 JAPAN

Telephone : +81 463 50 6400

Facsimile : +81 463 50 6401

Radiated Emission

Report No.	12656071S		
Test place	Shonan EMC Lab.		
Semi Anechoic Chamber	No.3	No.3	No.3
Date	January 26, 2019	February 26, 2019	March 11, 2019
Temperature / Humidity	22 deg.C / 31 %RH	25 deg.C / 35 %RH	23 deg.C / 33 %RH
Engineer	Kenichi Adachi	Kazutaka Takeyama	Kenichi Adachi
	(30 MHz - 1000 MHz)	(1 GHz - 13 GHz)	(13 GHz - 26.5 GHz)
Mode	Tx, 2402 MHz BT LE		

(* PK: Peak, AV: Average, QP: Quasi-Peak)

Polarity	Frequency [MHz]	Detector	Reading [dBuV]	Ant.Fac. [dB/m]	Loss [dB]	Gain [dB]	Distance Factor [dB]	Result [dBuV/m]	Limit [dBuV/m]	Margin [dB]	Height [cm]	Angle [deg]	Remark
Hori.	56.275	QP	36.78	9.19	6.69	32.19	0.00	20.47	40.00	19.5	374	157	
Hori.	96.004	QP	47.04	9.46	7.44	32.16	0.00	31.78	43.50	11.7	304	53	
Hori.	168.004	QP	44.74	15.46	7.89	32.10	0.00	35.99	43.50	7.5	187	182	
Hori.	240.011	QP	50.32	11.65	8.31	32.03	0.00	38.25	46.00	7.7	142	177	
Hori.	249.999	QP	53.49	11.81	8.38	32.01	0.00	41.67	46.00	4.3	123	176	
Hori.	454.650	QP	44.46	16.81	9.47	31.97	0.00	38.77	46.00	7.2	108	295	
Hori.	552.953	QP	37.96	17.90	9.83	32.00	0.00	33.69	46.00	12.3	100	142	
Hori.	2390.000	PK	46.00	27.86	14.79	41.59	2.26	49.32	73.90	24.5	100	251	
Hori.	4804.000	PK	49.60	31.43	7.36	42.88	2.26	47.77	73.90	26.1	100	66	
Hori.	7206.000	PK	47.70	36.79	9.34	42.92	2.26	53.17	73.90	20.7	100	0	
Hori.	9608.000	PK	48.50	38.51	10.73	43.17	2.26	56.83	73.90	17.0	100	0	
Vert.	36.864	QP	36.88	16.05	6.58	32.20	0.00	27.31	40.00	12.6	100	191	
Vert.	96.004	QP	45.99	9.46	7.44	32.16	0.00	30.73	43.50	12.7	100	131	
Vert.	168.004	QP	42.75	15.46	7.89	32.10	0.00	34.00	43.50	9.5	100	265	
Vert.	240.011	QP	42.02	11.65	8.31	32.03	0.00	29.95	46.00	16.0	221	145	
Vert.	249.999	QP	43.58	11.81	8.38	32.01	0.00	31.76	46.00	14.2	114	206	
Vert.	454.650	QP	42.22	16.81	9.47	31.97	0.00	36.53	46.00	9.4	153	202	
Vert.	552.953	QP	34.54	17.90	9.83	32.00	0.00	30.27	46.00	15.7	100	23	
Vert.	2390.000	PK	47.10	27.86	14.79	41.59	2.26	50.42	73.90	23.4	100	282	
Vert.	4804.000	PK	49.10	31.43	7.36	42.88	2.26	47.27	73.90	26.6	100	32	
Vert.	7206.000	PK	47.10	36.79	9.34	42.92	2.26	52.57	73.90	21.3	100	0	
Vert.	9608.000	PK	48.50	38.51	10.73	43.17	2.26	56.83	73.90	17.0	100	0	

Result = Reading + Ant.Fac. + Loss (Cable+(Attenuator or Filter)(below 18 GHz)) - Gain(Amplifier) + Distance factor

Distance factor : 1 GHz - 13 GHz : 20log (3.89 m / 3.0 m) = 2.26 dB

13 GHz - 40 GHz : 20log (1.0 m / 3.0 m) = -9.54 dB

Average measurement value with duty factor

Polarity	Frequency [MHz]	Detector	Reading [dBuV]	Ant.Fac. [dB/m]	Loss [dB]	Gain [dB]	Duty Factor [dB]	Distance Factor [dB]	Result [dBuV/m]	Limit [dBuV/m]	Margin [dB]	Remark
Hori.	2390.000	AV	37.90	27.86	14.79	41.59	3.56	2.26	44.78	53.90	9.1	*1)
Hori.	4804.000	AV	40.30	31.43	7.36	42.88	3.56	2.26	42.03	53.90	11.8	
Hori.	7206.000	AV	38.30	36.79	9.34	42.92	3.56	2.26	47.33	53.90	6.5	
Hori.	9608.000	AV	40.00	38.51	10.73	43.17	3.56	2.26	51.89	53.90	2.0	
Vert.	2390.000	AV	38.00	27.86	14.79	41.59	3.56	2.26	44.88	53.90	9.0	*1)
Vert.	4804.000	AV	40.00	31.43	7.36	42.88	3.56	2.26	41.73	53.90	12.1	
Vert.	7206.000	AV	38.60	36.79	9.34	42.92	3.56	2.26	47.63	53.90	6.2	
Vert.	9608.000	AV	40.20	38.51	10.73	43.17	3.56	2.26	52.09	53.90	1.8	

Result = Reading + Ant.Fac. + Loss (Cable+(Attenuator or Filter)(below 18 GHz)) - Gain(Amplifier) + Duty factor + Distance factor

Distance factor : 1 GHz - 13 GHz : 20log (3.89 m / 3.0 m) = 2.26 dB

13 GHz - 40 GHz : 20log (1.0 m / 3.0 m) = -9.54 dB

Duty factor refer to "Duty factor Calculation chart" sheet.

*1) Not out of band emission (Leakage Power)

20 dBc Data Sheet (RBW 100 kHz, VBW 300 kHz)

Polarity	Frequency [MHz]	Detector	Reading [dBuV]	Ant.Fac. [dB/m]	Loss [dB]	Gain [dB]	Distance Factor [dB]	Result [dBuV/m]	Limit [dBuV/m]	Margin [dB]	Remark
Hori.	2402.000	PK	93.60	27.86	14.80	41.60	2.26	96.92	-	-	Carrier
Hori.	2400.000	PK	38.60	27.86	14.80	41.60	2.26	41.92	76.92	35.0	
Vert.	2402.000	PK	93.00	27.86	14.80	41.60	2.26	96.32	-	-	Carrier
Vert.	2400.000	PK	39.30	27.86	14.80	41.60	2.26	42.62	76.32	33.7	

Result = Reading + Ant.Fac. + Loss (Cable+(Attenuator or Filter)(below 18 GHz)) - Gain(Amplifier) + Distance factor

Distance factor : 1 GHz - 13 GHz : 20log (3.89 m / 3.0 m) = 2.26 dB

13 GHz - 40 GHz : 20log (1.0 m / 3.0 m) = -9.54 dB

UL Japan, Inc.

Shonan EMC Lab.

1-22-3 Megumigaoka, Hiratsuka-shi, Kanagawa 259-1220 JAPAN

Telephone : +81 463 50 6400

Facsimile : +81 463 50 6401

Radiated Spurious Emission (Reference Plot for band-edge)

Test place	Shonan EMC Lab.
Semi Anechoic Chamber	No.3
Date	February 26, 2019
Temperature / Humidity	25 deg.C / 35 %RH
Engineer	Kazutaka Takeyama (1 GHz – 2.8 GHz)
Mode	Tx BT LE , 2402 MHz

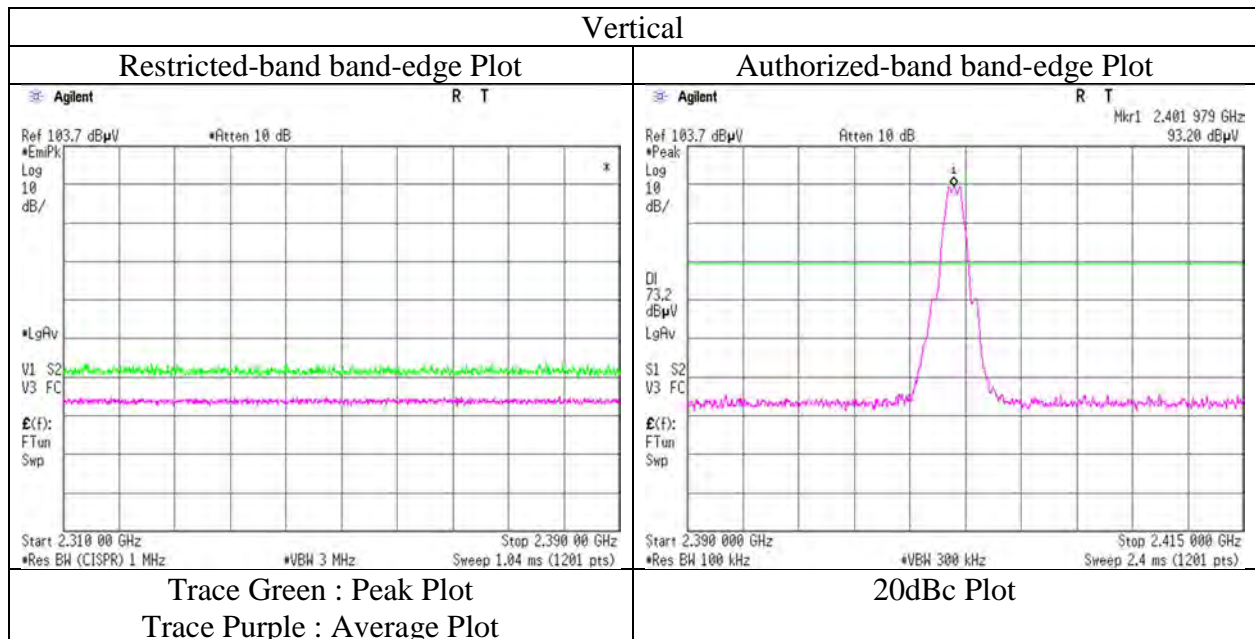
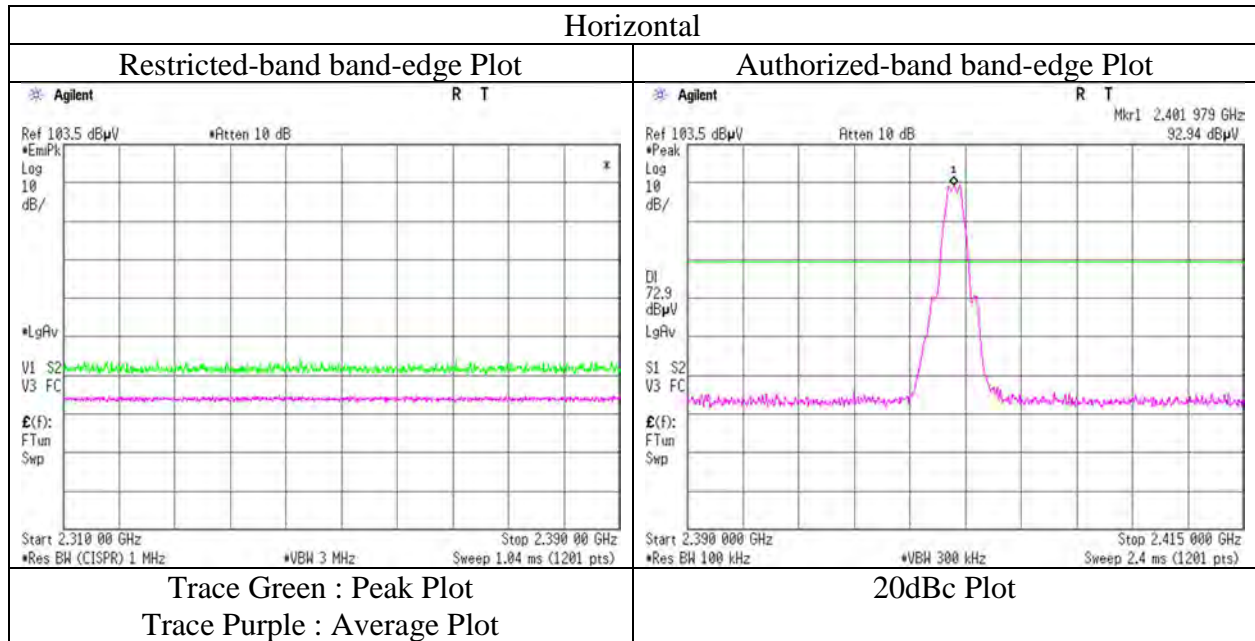

* The measurement was conducted for a sufficiently long enough time to detect any possible spurious emissions. Final result of restricted band edge was shown in tabular data.

Radiated Emission

Report No.	12656071S		
Test place	Shonan EMC Lab.		
Semi Anechoic Chamber	No.3	No.3	No.3
Date	January 26, 2019	February 26, 2019	March 11, 2019
Temperature / Humidity	22 deg.C / 31 %RH	25 deg.C / 35 %RH	23 deg.C / 33 %RH
Engineer	Kenichi Adachi	Kazutaka Takeyama	Kenichi Adachi
	(30 MHz - 1000 MHz)	(1 GHz - 13 GHz)	(13 GHz - 26.5 GHz)
Mode	Tx, 2440 MHz BT LE		

(* PK: Peak, AV: Average, QP: Quasi-Peak)

Polarity	Frequency [MHz]	Detector	Reading [dBuV]	Ant.Fac. [dB/m]	Loss [dB]	Gain [dB]	Distance Factor [dB]	Result [dBuV/m]	Limit [dBuV/m]	Margin [dB]	Height [cm]	Angle [deg]	Remark
Hori.	56.349	QP	36.56	9.17	6.69	32.19	0.00	20.23	40.00	19.7	368	159	
Hori.	96.003	QP	46.88	9.46	7.44	32.16	0.00	31.62	43.50	11.8	302	56	
Hori.	168.003	QP	44.58	15.46	7.89	32.10	0.00	35.83	43.50	7.6	184	179	
Hori.	240.011	QP	50.25	11.65	8.31	32.03	0.00	38.18	46.00	7.8	144	175	
Hori.	249.999	QP	53.01	11.81	8.38	32.01	0.00	41.19	46.00	4.8	125	177	
Hori.	454.649	QP	44.26	16.81	9.47	31.97	0.00	38.57	46.00	7.4	109	298	
Hori.	552.952	QP	37.67	17.90	9.83	32.00	0.00	33.40	46.00	12.6	100	143	
Hori.	4880.000	PK	55.50	31.37	7.41	42.89	2.26	53.65	73.90	20.2	100	331	
Hori.	7320.000	PK	47.00	37.00	9.36	43.15	2.26	52.47	73.90	21.4	100	0	
Hori.	9760.000	PK	48.40	38.92	10.63	43.01	2.26	57.20	73.90	16.7	100	0	
Vert.	36.896	QP	36.42	16.04	6.58	32.20	0.00	26.84	40.00	13.1	100	192	
Vert.	96.003	QP	46.04	9.46	7.44	32.16	0.00	30.78	43.50	12.7	100	134	
Vert.	168.003	QP	42.46	15.46	7.89	32.10	0.00	33.71	43.50	9.7	100	285	
Vert.	240.010	QP	41.87	11.65	8.31	32.03	0.00	29.80	46.00	16.2	219	143	
Vert.	249.999	QP	43.48	11.81	8.38	32.01	0.00	31.66	46.00	14.3	115	208	
Vert.	454.649	QP	42.31	16.81	9.47	31.97	0.00	36.62	46.00	9.3	151	204	
Vert.	552.952	QP	34.42	17.90	9.83	32.00	0.00	30.15	46.00	15.8	100	27	
Vert.	4880.000	PK	53.30	31.37	7.41	42.89	2.26	51.45	73.90	22.4	100	38	
Vert.	7320.000	PK	47.70	37.00	9.36	43.15	2.26	53.17	73.90	20.7	100	0	
Vert.	9760.000	PK	47.90	38.92	10.63	43.01	2.26	56.70	73.90	17.2	100	0	

Result = Reading + Ant.Fac. + Loss (Cable+(Attenuator or Filter)(below 18 GHz)) - Gain(Amplifier) + Distance factor

Distance factor : 1 GHz - 13 GHz : 20log (3.89 m / 3.0 m) = 2.26 dB

13 GHz - 40 GHz : 20log (1.0 m / 3.0 m) = -9.54 dB

Average measurement value with duty factor

Polarity	Frequency [MHz]	Detector	Reading [dBuV]	Ant.Fac. [dB/m]	Loss [dB]	Gain [dB]	Duty Factor [dB]	Distance Factor [dB]	Result [dBuV/m]	Limit [dBuV/m]	Margin [dB]	Remark
Hori.	4880.000	AV	48.70	31.37	7.41	42.89	3.56	2.26	50.41	53.90	3.4	
Hori.	7320.000	AV	38.30	37.00	9.36	43.15	3.56	2.26	47.33	53.90	6.5	
Hori.	9760.000	AV	38.30	38.92	10.63	43.01	3.56	2.26	50.66	53.90	3.2	
Vert.	4880.000	AV	46.20	31.37	7.41	42.89	3.56	2.26	47.91	53.90	5.9	
Vert.	7320.000	AV	38.70	37.00	9.36	43.15	3.56	2.26	47.73	53.90	6.1	
Vert.	9760.000	AV	38.30	38.92	10.63	43.01	3.56	2.26	50.66	53.90	3.2	

Result = Reading + Ant.Fac. + Loss (Cable+(Attenuator or Filter)(below 18 GHz)) - Gain(Amplifier) + Duty factor + Distance factor

Distance factor : 1 GHz - 13 GHz : 20log (3.89 m / 3.0 m) = 2.26 dB

13 GHz - 40 GHz : 20log (1.0 m / 3.0 m) = -9.54 dB

Duty factor refer to "Duty factor Calculation chart" sheet.

*1) Not out of band emission (Leakage Power)

UL Japan, Inc.**Shonan EMC Lab.**

1-22-3 Megumigaoka, Hiratsuka-shi, Kanagawa 259-1220 JAPAN

Telephone : +81 463 50 6400

Facsimile : +81 463 50 6401

Radiated Emission

Report No.	12656071S		
Test place	Shonan EMC Lab.		
Semi Anechoic Chamber	No.3	No.3	No.3
Date	January 26, 2019	February 26, 2019	March 11, 2019
Temperature / Humidity	22 deg.C / 31 %RH	25 deg.C / 35 %RH	23 deg.C / 33 %RH
Engineer	Kenichi Adachi (30 MHz - 1000 MHz)	Kazutaka Takeyama (1 GHz - 13 GHz)	Kenichi Adachi (13 GHz - 26.5 GHz)
Mode	Tx, 2480 MHz BT LE		

(* PK: Peak, AV: Average, QP: Quasi-Peak)

Polarity	Frequency [MHz]	Detector	Reading [dBuV]	Ant.Fac. [dB/m]	Loss [dB]	Gain [dB]	Distance Factor [dB]	Result [dBuV/m]	Limit [dBuV/m]	Margin [dB]	Height [cm]	Angle [deg]	Remark
Hori.	56.213	QP	36.48	9.21	6.69	32.19	0.00	20.19	40.00	19.8	366	152	
Hori.	96.005	QP	46.97	9.46	7.44	32.16	0.00	31.71	43.50	11.7	301	55	
Hori.	168.005	QP	44.68	15.46	7.89	32.10	0.00	35.93	43.50	7.5	184	179	
Hori.	240.012	QP	50.18	11.65	8.31	32.03	0.00	38.11	46.00	7.8	145	179	
Hori.	249.999	QP	53.37	11.81	8.38	32.01	0.00	41.55	46.00	4.4	131	175	
Hori.	454.652	QP	44.23	16.81	9.47	31.97	0.00	38.54	46.00	7.4	107	299	
Hori.	552.955	QP	37.64	17.90	9.83	32.00	0.00	33.37	46.00	12.6	100	143	
Hori.	2483.500	PK	45.00	27.65	14.88	41.62	2.26	48.17	73.90	25.7	108	253	
Hori.	4960.000	PK	53.50	31.54	7.46	42.91	2.26	51.85	73.90	22.0	100	333	
Hori.	7440.000	PK	47.50	37.10	9.38	43.38	2.26	52.86	73.90	21.0	100	0	
Hori.	9920.000	PK	47.00	38.97	10.51	42.84	2.26	55.90	73.90	18.0	100	0	
Vert.	36.598	QP	36.54	16.16	6.58	32.20	0.00	27.08	40.00	12.9	100	189	
Vert.	96.005	QP	45.87	9.46	7.44	32.16	0.00	30.61	43.50	12.8	100	129	
Vert.	168.005	QP	42.93	15.46	7.89	32.10	0.00	34.18	43.50	9.3	100	269	
Vert.	240.012	QP	41.94	11.65	8.31	32.03	0.00	29.87	46.00	16.1	216	143	
Vert.	249.999	QP	43.32	11.81	8.38	32.01	0.00	31.50	46.00	14.5	113	200	
Vert.	454.652	QP	41.67	16.81	9.47	31.97	0.00	35.98	46.00	10.0	154	206	
Vert.	552.955	QP	34.42	17.90	9.83	32.00	0.00	30.15	46.00	15.8	100	29	
Vert.	2483.500	PK	46.20	27.65	14.88	41.62	2.26	49.37	73.90	24.5	100	275	
Vert.	4960.000	PK	52.60	31.54	7.46	42.91	2.26	50.95	73.90	22.9	100	38	
Vert.	7440.000	PK	47.40	37.10	9.38	43.38	2.26	52.76	73.90	21.1	100	0	
Vert.	9920.000	PK	47.00	38.97	10.51	42.84	2.26	55.90	73.90	18.0	100	0	

Result = Reading + Ant.Fac. + Loss (Cable+(Attenuator or Filter)(below 18 GHz)) - Gain(Amplifier) + Distance factor

Distance factor : 1 GHz - 13 GHz : 20log (3.89 m / 3.0 m) = 2.26 dB

13 GHz - 40 GHz : 20log (1.0 m / 3.0 m) = -9.54 dB

Average measurement value with duty factor

Polarity	Frequency [MHz]	Detector	Reading [dBuV]	Ant.Fac. [dB/m]	Loss [dB]	Gain [dB]	Duty Factor [dB]	Distance Factor [dB]	Result [dBuV/m]	Limit [dBuV/m]	Margin [dB]	Remark
Hori.	2483.500	AV	38.30	27.65	14.88	41.62	3.56	2.26	45.03	53.90	8.8	*1)
Hori.	4960.000	AV	45.80	31.54	7.46	42.91	3.56	2.26	47.71	53.90	6.1	
Hori.	7440.000	AV	38.70	37.10	9.38	43.38	3.56	2.26	47.62	53.90	6.2	
Hori.	9920.000	AV	38.40	38.97	10.51	42.84	3.56	2.26	50.86	53.90	3.0	
Vert.	2483.500	AV	38.40	27.65	14.88	41.62	3.56	2.26	45.13	53.90	8.7	*1)
Vert.	4960.000	AV	44.40	31.54	7.46	42.91	3.56	2.26	46.31	53.90	7.5	
Vert.	7440.000	AV	39.00	37.10	9.38	43.38	3.56	2.26	47.92	53.90	5.9	
Vert.	9920.000	AV	38.40	38.97	10.51	42.84	3.56	2.26	50.86	53.90	3.0	

Result = Reading + Ant.Fac. + Loss (Cable+(Attenuator or Filter)(below 18 GHz)) - Gain(Amplifier) + Duty factor + Distance factor

Distance factor : 1 GHz - 13 GHz : 20log (3.89 m / 3.0 m) = 2.26 dB

13 GHz - 40 GHz : 20log (1.0 m / 3.0 m) = -9.54 dB

Duty factor refer to "Duty factor Calculation chart" sheet.

*1) Not out of band emission (Leakage Power)

UL Japan, Inc.

Shonan EMC Lab.

1-22-3 Megumigaoka, Hiratsuka-shi, Kanagawa 259-1220 JAPAN

Telephone : +81 463 50 6400

Facsimile : +81 463 50 6401

Radiated Spurious Emission **(Reference Plot for band-edge)**

Test place	Shonan EMC Lab.
Semi Anechoic Chamber	No.3
Date	February 26, 2019
Temperature / Humidity	25 deg.C / 35 %RH
Engineer	Kazutaka Takeyama (1 GHz – 2.8 GHz)
Mode	Tx BT LE , 2480 MHz

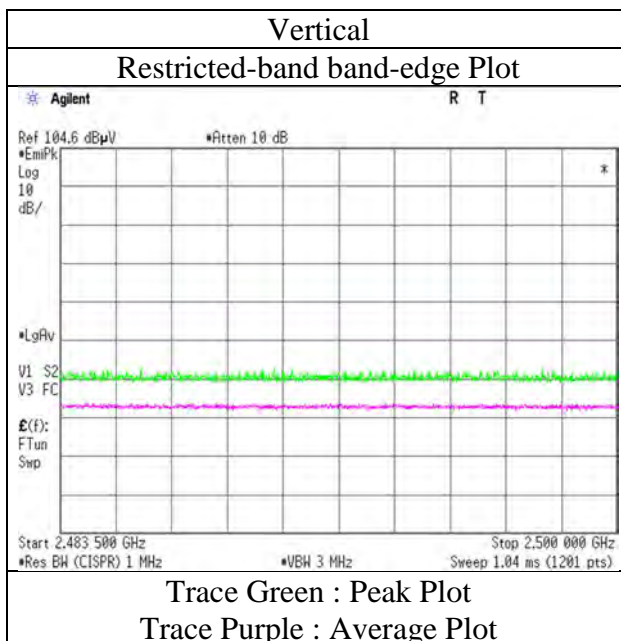
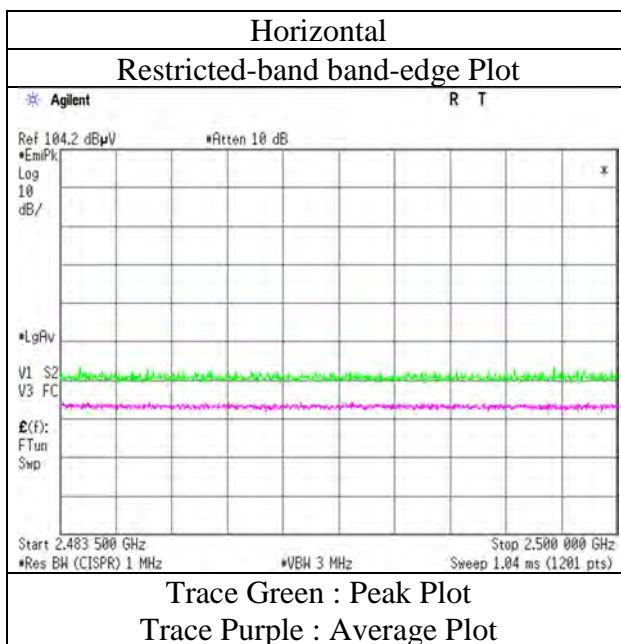

* The measurement was conducted for a sufficiently long enough time to detect any possible spurious emissions. Final result of restricted band edge was shown in tabular data.

Radiated Emission (Worst mode plot)

Report No. Refer to previous sheet
Test place Refer to previous sheet
Semi Anechoic Chamber Refer to previous sheet
Date Refer to previous sheet
Temperature / Humidity Refer to previous sheet
Engineer Refer to previous sheet
Mode Tx, BT LE

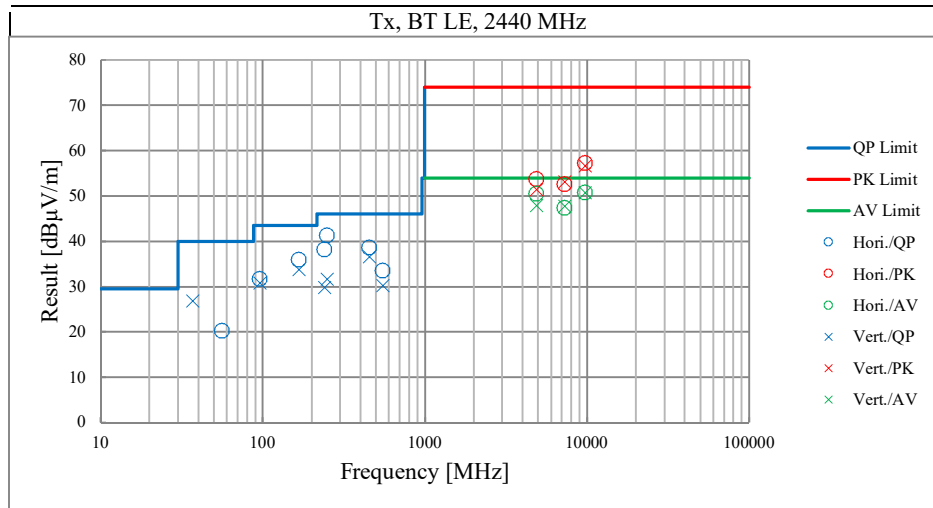

UL Japan, Inc.

Shonan EMC Lab.

1-22-3 Megumigaoka, Hiratsuka-shi, Kanagawa 259-1220 JAPAN

Telephone : +81 463 50 6400

Facsimile : +81 463 50 6401

Radiated Emission

Report No. 12656071S
 Test place Shonan EMC Lab.
 Semi Anechoic Chamber No.3 No.3 No.1 No.3
 Date January 15, 2019 January 16, 2019 February 24, 2019 January 17, 2019
 Temperature / Humidity 20 deg.C / 35 %RH 20 deg.C / 45 %RH 22 deg.C / 33 %RH 21 deg.C / 35 %RH
 Engineer Kazutaka Takeyama Kenichi Adachi Kazutaka Takeyama Makoto Hosaka
 (1 GHz -2.8 GHz) (2.8 GHz - 13 GHz) (13 GHz - 18 GHz) (18 GHz- 26.5 GHz)
 Mode Tx, 2412 MHz
 Tx, IEEE802.11b,

(* PK: Peak, AV: Average, QP: Quasi-Peak)

Polarity	Frequency [MHz]	Detector	Reading [dBuV]	Ant.Fac. [dB/m]	Loss [dB]	Gain [dB]	Distance Factor [dB]	Result [dBuV/m]	Limit [dBuV/m]	Margin [dB]	Height [cm]	Angle [deg]	Remark
Hori.	2390.000	PK	46.00	27.86	14.67	34.78	2.26	56.01	73.90	17.8	300	50	
Hori.	4824.000	PK	47.25	31.46	7.19	34.07	2.26	54.09	73.90	19.8	182	233	
Hori.	7236.000	PK	42.55	36.85	9.04	33.81	2.26	56.89	73.90	17.0	182	25	
Hori.	9648.000	PK	41.45	38.64	10.52	34.13	2.26	58.74	73.90	15.1	183	192	
Hori.	2390.000	AV	37.70	27.86	14.67	34.78	2.26	47.71	53.90	6.1	300	50	
Hori.	4824.000	AV	38.79	31.46	7.19	34.07	2.26	45.63	53.90	8.2	182	233	
Hori.	7236.000	AV	32.98	36.85	9.04	33.81	2.26	47.32	53.90	6.5	182	25	
Hori.	9648.000	AV	31.53	38.64	10.52	34.13	2.26	48.82	53.90	5.0	183	192	
Vert.	2390.000	PK	45.80	27.86	14.67	34.78	2.26	55.81	73.90	18.0	118	107	
Vert.	4824.000	PK	48.35	31.46	7.19	34.07	2.26	55.19	73.90	18.7	149	32	
Vert.	7236.000	PK	44.51	36.85	9.04	33.81	2.26	58.85	73.90	15.0	102	292	
Vert.	9648.000	PK	41.67	38.64	10.52	34.13	2.26	58.96	73.90	14.9	204	161	
Vert.	2390.000	AV	37.50	27.86	14.67	34.78	2.26	47.51	53.90	6.3	118	107	
Vert.	4824.000	AV	39.55	31.46	7.19	34.07	2.26	46.39	53.90	7.5	149	32	
Vert.	7236.000	AV	35.16	36.85	9.04	33.81	2.26	49.50	53.90	4.4	102	292	
Vert.	9648.000	AV	31.86	38.64	10.52	34.13	2.26	49.15	53.90	4.7	204	161	

Result = Reading + Ant.Fac. + Loss (Cable+(Attenuator or Filter)(below 18 GHz)) - Gain(Amplifier) + Distance factor

Distance factor : 1 GHz - 13 GHz : 20log (3.89 m / 3.0 m) = 2.26 dB

13 GHz - 40 GHz : 20log (1.0 m / 3.0 m) = -9.54 dB

20 dBc Data Sheet (RBW 100 kHz, VBW 300 kHz)

Polarity	Frequency [MHz]	Detector	Reading [dBuV]	Ant.Fac. [dB/m]	Loss [dB]	Gain [dB]	Distance Factor [dB]	Result [dBuV/m]	Limit [dBuV/m]	Margin [dB]	Remark
Hori.	2412.000	PK	93.20	27.85	14.69	34.78	2.26	103.22	-	-	Carrier
Hori.	2400.000	PK	46.20	27.86	14.68	34.78	2.26	56.22	83.22	27.0	
Vert.	2412.000	PK	92.20	27.85	14.69	34.78	2.26	102.22	-	-	Carrier
Vert.	2400.000	PK	45.80	27.86	14.68	34.78	2.26	55.82	82.22	26.4	

Result = Reading + Ant.Fac. + Loss (Cable+(Attenuator or Filter)(below 18 GHz)) - Gain(Amplifier) + Distance factor

Distance factor : 1 GHz - 13 GHz : 20log (3.89 m / 3.0 m) = 2.26 dB

13 GHz - 40 GHz : 20log (1.0 m / 3.0 m) = -9.54 dB

UL Japan, Inc.**Shonan EMC Lab.**

1-22-3 Megumigaoka, Hiratsuka-shi, Kanagawa 259-1220 JAPAN

Telephone : +81 463 50 6400

Facsimile : +81 463 50 6401

Radiated Spurious Emission (Reference Plot for band-edge)

Test place	Shonan EMC Lab.
Semi Anechoic Chamber	No.3
Date	January 15, 2019
Temperature / Humidity	20 deg.C / 35 %RH
Engineer	Kazutaka Takeyama
	(1 GHz – 2.8 GHz)
Mode	Tx, IEEE802.11b , 2412 MHz

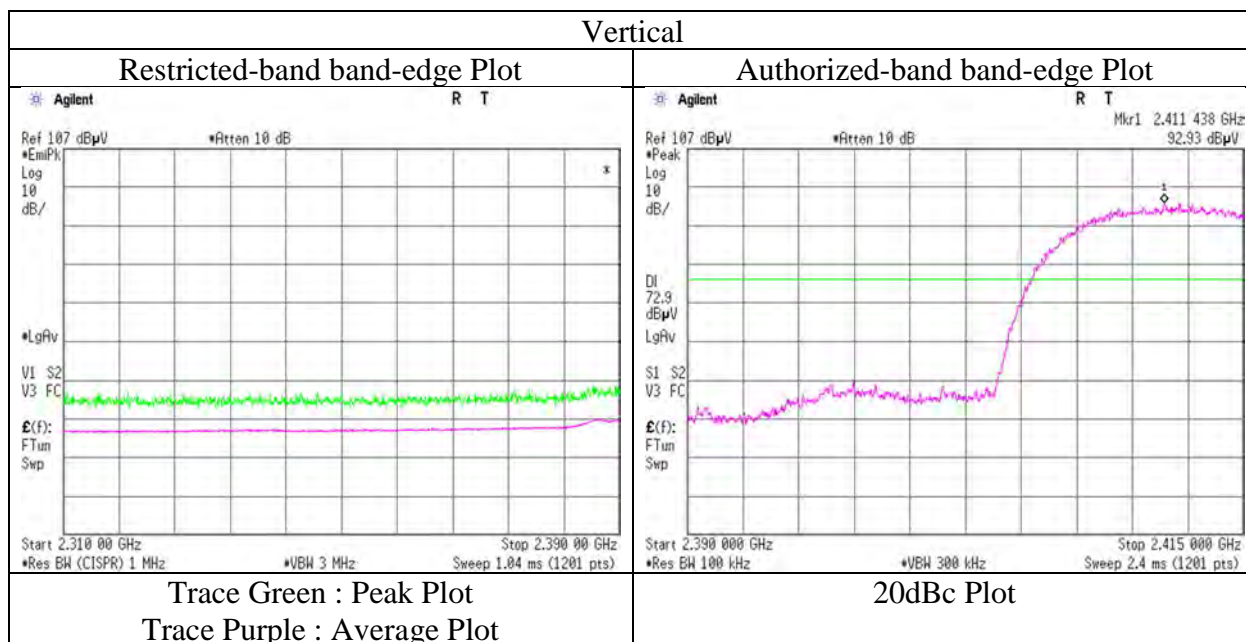
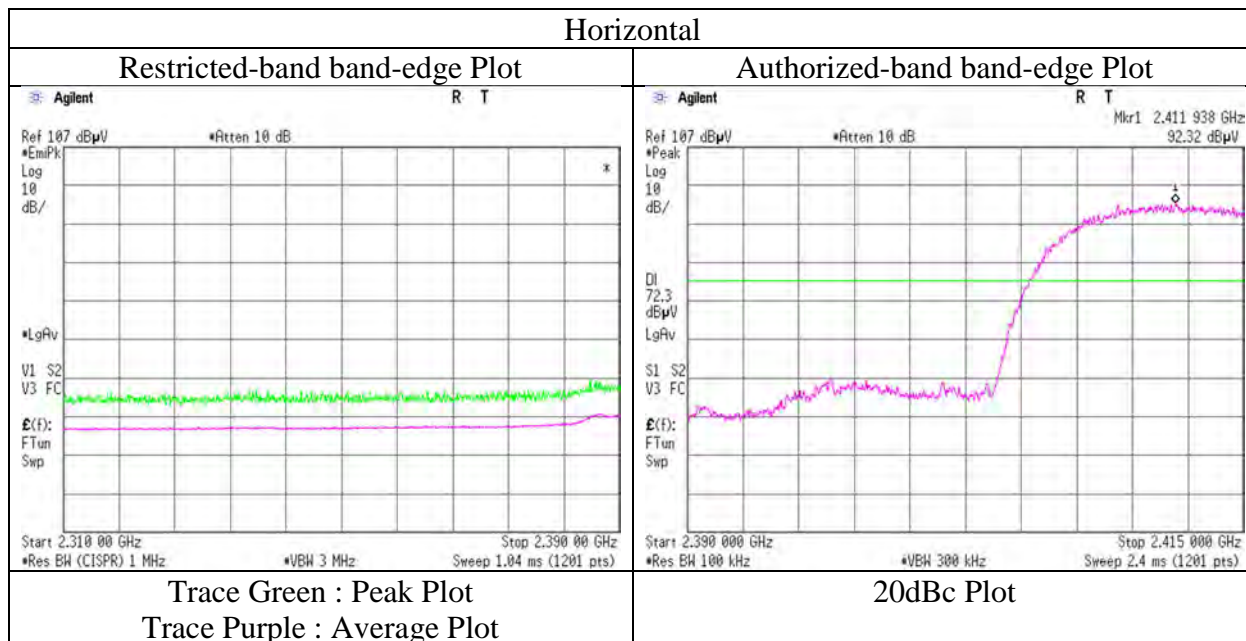

* The measurement was conducted for a sufficiently long enough time to detect any possible spurious emissions. Final result of restricted band edge was shown in tabular data.

UL Japan, Inc.

Shonan EMC Lab.

1-22-3 Megumigaoka, Hiratsuka-shi, Kanagawa-ken, 259-1220 JAPAN

Telephone : +81 463 50 6400

Facsimile : +81 463 50 6401

Radiated Emission

Report No. 12656071S
 Test place Shonan EMC Lab.
 Semi Anechoic Chamber No.3 No.3 No.1 No.3
 Date January 15, 2019 January 16, 2019 February 24, 2019 January 17, 2019
 Temperature / Humidity 20 deg.C / 35 %RH 20 deg.C / 45 %RH 22 deg.C / 33 %RH 21 deg.C / 35 %RH
 Engineer Kazutaka Takeyama Kenichi Adachi Kazutaka Takeyama Makoto Hosaka
 (1 GHz -2.8 GHz) (2.8 GHz - 13 GHz) (13 GHz - 18 GHz) (18 GHz- 26.5 GHz)
 Mode Tx, 2437 MHz
 Tx, IEEE802.11b,

(* PK: Peak, AV: Average, QP: Quasi-Peak)

Polarity	Frequency [MHz]	Detector	Reading [dBuV]	Ant.Fac. [dB/m]	Loss [dB]	Gain [dB]	Distance Factor [dB]	Result [dBuV/m]	Limit [dBuV/m]	Margin [dB]	Height [cm]	Angle [deg]	Remark
Hori.	4874.000	PK	44.73	31.40	7.21	34.05	2.26	51.55	73.90	22.3	183	229	
Hori.	7311.000	PK	41.57	36.99	9.08	33.82	2.26	56.08	73.90	17.8	184	22	
Hori.	9748.000	PK	40.16	38.92	10.45	34.12	2.26	57.67	73.90	16.2	181	190	
Hori.	4874.000	AV	37.43	31.40	7.21	34.05	2.26	44.25	53.90	9.6	183	229	
Hori.	7311.000	AV	29.94	36.99	9.08	33.82	2.26	44.45	53.90	9.4	184	22	
Hori.	9748.000	AV	30.38	38.92	10.45	34.12	2.26	47.89	53.90	6.0	181	190	
Vert.	4874.000	PK	44.95	31.40	7.21	34.05	2.26	51.77	73.90	22.1	147	27	
Vert.	7311.000	PK	41.47	36.99	9.08	33.82	2.26	55.98	73.90	17.9	103	293	
Vert.	9748.000	PK	40.48	38.92	10.45	34.12	2.26	57.99	73.90	15.9	201	164	
Vert.	4874.000	AV	37.75	31.40	7.21	34.05	2.26	44.57	53.90	9.3	147	27	
Vert.	7311.000	AV	30.98	36.99	9.08	33.82	2.26	45.49	53.90	8.4	103	293	
Vert.	9748.000	AV	30.65	38.92	10.45	34.12	2.26	48.16	53.90	5.7	201	164	

Result = Reading + Ant.Fac. + Loss (Cable+(Attenuator or Filter)(below 18 GHz)) - Gain(Amplifier) + Distance factor

Distance factor : 1 GHz - 13 GHz : $20\log(3.89\text{ m} / 3.0\text{ m}) = 2.26\text{ dB}$

13 GHz - 40 GHz : $20\log(1.0\text{ m} / 3.0\text{ m}) = -9.54\text{ dB}$

UL Japan, Inc.

Shonan EMC Lab.

1-22-3 Megumigaoka, Hiratsuka-shi, Kanagawa 259-1220 JAPAN

Telephone : +81 463 50 6400

Facsimile : +81 463 50 6401

Radiated Emission

Report No. 12656071S
 Test place Shonan EMC Lab.
 Semi Anechoic Chamber No.3 No.3 No.1 No.3
 Date January 15, 2019 January 16, 2019 February 24, 2019 January 17, 2019
 Temperature / Humidity 20 deg.C / 35 %RH 20 deg.C / 45 %RH 22 deg.C / 33 %RH 21 deg.C / 35 %RH
 Engineer Kazutaka Takeyama Kenichi Adachi Kazutaka Takeyama Makoto Hosaka
 (1 GHz -2.8 GHz) (2.8 GHz - 13 GHz) (13 GHz - 18 GHz) (18 GHz- 26.5 GHz)
 Mode Tx, 2462 MHz
 Tx, IEEE802.11b,

(* PK: Peak, AV: Average, QP: Quasi-Peak)

Polarity	Frequency [MHz]	Detector	Reading [dBuV]	Ant.Fac. [dB/m]	Loss [dB]	Gain [dB]	Distance Factor [dB]	Result [dBuV/m]	Limit [dBuV/m]	Margin [dB]	Height [cm]	Angle [deg]	Remark
Hori.	2483.500	PK	47.70	27.65	14.77	34.77	2.26	57.61	73.90	16.2	327	52	
Hori.	4924.000	PK	44.38	31.37	7.25	34.04	2.26	51.22	73.90	22.6	182	227	
Hori.	7386.000	PK	42.06	37.01	9.13	33.82	2.26	56.64	73.90	17.2	181	23	
Hori.	9848.000	PK	41.77	39.12	10.38	34.11	2.26	59.42	73.90	14.4	183	193	
Hori.	2483.500	AV	37.30	27.65	14.77	34.77	2.26	47.21	53.90	6.6	327	52	
Hori.	4924.000	AV	35.79	31.37	7.25	34.04	2.26	42.63	53.90	11.2	182	227	
Hori.	7386.000	AV	30.78	37.01	9.13	33.82	2.26	45.36	53.90	8.5	181	23	
Hori.	9848.000	AV	31.78	39.12	10.38	34.11	2.26	49.43	53.90	4.4	183	193	
Vert.	2483.500	PK	46.40	27.65	14.77	34.77	2.26	56.31	73.90	17.5	113	236	
Vert.	4924.000	PK	45.22	31.37	7.25	34.04	2.26	52.06	73.90	21.8	147	30	
Vert.	7386.000	PK	41.68	37.01	9.13	33.82	2.26	56.26	73.90	17.6	104	290	
Vert.	9848.000	PK	41.98	39.12	10.38	34.11	2.26	59.63	73.90	14.2	201	159	
Vert.	2483.500	AV	36.80	27.65	14.77	34.77	2.26	46.71	53.90	7.1	113	236	
Vert.	4924.000	AV	37.92	31.37	7.25	34.04	2.26	44.76	53.90	9.1	147	30	
Vert.	7386.000	AV	31.38	37.01	9.13	33.82	2.26	45.96	53.90	7.9	104	290	
Vert.	9848.000	AV	32.15	39.12	10.38	34.11	2.26	49.80	53.90	4.1	201	159	

Result = Reading + Ant.Fac. + Loss (Cable+(Attenuator or Filter)(below 18 GHz)) - Gain(Amplifier) + Distance factor

Distance factor : 1 GHz - 13 GHz : $20\log(3.89\text{ m} / 3.0\text{ m}) = 2.26\text{ dB}$

13 GHz - 40 GHz : $20\log(1.0\text{ m} / 3.0\text{ m}) = -9.54\text{ dB}$

UL Japan, Inc.

Shonan EMC Lab.

1-22-3 Megumigaoka, Hiratsuka-shi, Kanagawa 259-1220 JAPAN

Telephone : +81 463 50 6400

Facsimile : +81 463 50 6401

Radiated Spurious Emission (Reference Plot for band-edge)

Test place	Shonan EMC Lab.
Semi Anechoic Chamber	No.3
Date	January 15, 2019
Temperature / Humidity	20 deg.C / 35 %RH
Engineer	Kazutaka Takeyama
	(1 GHz – 2.8 GHz)
Mode	Tx, IEEE802.11b , 2462 MHz

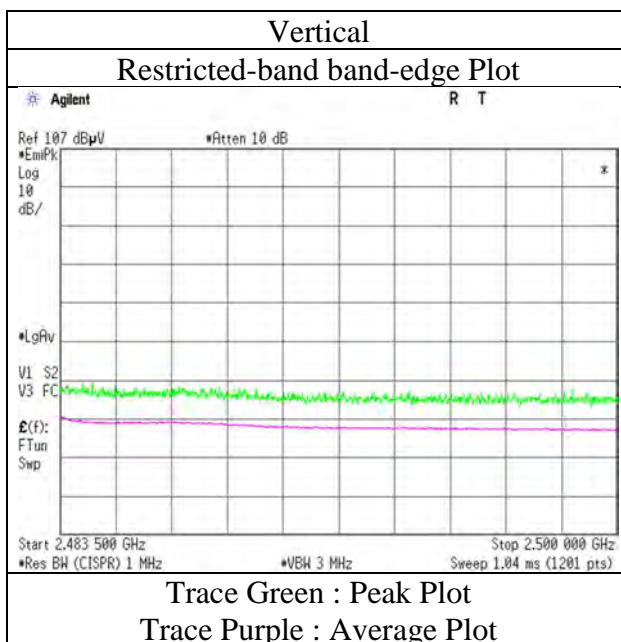
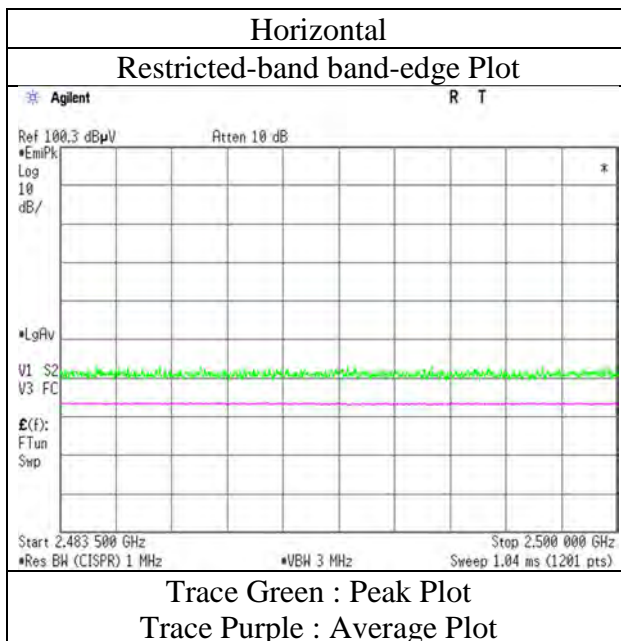

* The measurement was conducted for a sufficiently long enough time to detect any possible spurious emissions. Final result of restricted band edge was shown in tabular data.

UL Japan, Inc.

Shonan EMC Lab.

1-22-3 Megumigaoka, Hiratsuka-shi, Kanagawa-ken, 259-1220 JAPAN

Telephone : +81 463 50 6400

Facsimile : +81 463 50 6401

Radiated Emission

Report No. 12656071S
 Test place Shonan EMC Lab.
 Semi Anechoic Chamber No.3 No.3 No.1 No.3
 Date January 15, 2019 January 16, 2019 February 24, 2019 January 17, 2019
 Temperature / Humidity 20 deg.C / 35 %RH 20 deg.C / 45 %RH 22 deg.C / 33 %RH 21 deg.C / 35 %RH
 Engineer Kazutaka Takeyama Kenichi Adachi Kazutaka Takeyama Makoto Hosaka
 (1 GHz -2.8 GHz) (2.8 GHz - 13 GHz) (13 GHz - 18 GHz) (18 GHz- 26.5 GHz)
 Mode Tx, 2467 MHz
 Tx, IEEE802.11b,

(* PK: Peak, AV: Average, QP: Quasi-Peak)

Polarity	Frequency [MHz]	Detector	Reading [dBuV]	Ant.Fac. [dB/m]	Loss [dB]	Gain [dB]	Distance Factor [dB]	Result [dBuV/m]	Limit [dBuV/m]	Margin [dB]	Height [cm]	Angle [deg]	Remark
Hori.	2483.500	PK	43.00	27.65	14.77	34.77	2.26	52.91	73.90	20.9	400	45	
Hori.	4934.000	PK	41.78	31.41	7.26	34.04	2.26	48.67	73.90	25.2	183	226	
Hori.	7401.000	PK	41.11	36.99	9.13	33.82	2.26	55.67	73.90	18.2	181	25	
Hori.	9868.000	PK	40.24	39.07	10.38	34.11	2.26	57.84	73.90	16.0	182	193	
Hori.	2483.500	AV	33.70	27.65	14.77	34.77	2.26	43.61	53.90	10.2	400	45	
Hori.	4934.000	AV	31.08	31.41	7.26	34.04	2.26	37.97	53.90	15.9	183	226	
Hori.	7401.000	AV	30.38	36.99	9.13	33.82	2.26	44.94	53.90	8.9	181	25	
Hori.	9868.000	AV	30.22	39.07	10.38	34.11	2.26	47.82	53.90	6.0	182	193	
Vert.	2483.500	PK	44.40	27.65	14.77	34.77	2.26	54.31	73.90	19.5	100	237	
Vert.	4934.000	PK	41.86	31.41	7.26	34.04	2.26	48.75	73.90	25.1	148	26	
Vert.	7401.000	PK	41.27	36.99	9.13	33.82	2.26	55.83	73.90	18.0	104	289	
Vert.	9868.000	PK	40.38	39.07	10.38	34.11	2.26	57.98	73.90	15.9	202	163	
Vert.	2483.500	AV	33.70	27.65	14.77	34.77	2.26	43.61	53.90	10.2	100	237	
Vert.	4934.000	AV	31.19	31.41	7.26	34.04	2.26	38.08	53.90	15.8	148	26	
Vert.	7401.000	AV	30.47	36.99	9.13	33.82	2.26	45.03	53.90	8.8	104	289	
Vert.	9868.000	AV	30.42	39.07	10.38	34.11	2.26	48.02	53.90	5.8	202	163	

Result = Reading + Ant.Fac. + Loss (Cable+(Attenuator or Filter)(below 18 GHz)) - Gain(Amplifier) + Distance factor

Distance factor : 1 GHz - 13 GHz : $20\log(3.89\text{ m} / 3.0\text{ m}) = 2.26\text{ dB}$

13 GHz - 40 GHz : $20\log(1.0\text{ m} / 3.0\text{ m}) = -9.54\text{ dB}$

UL Japan, Inc.

Shonan EMC Lab.

1-22-3 Megumigaoka, Hiratsuka-shi, Kanagawa 259-1220 JAPAN

Telephone : +81 463 50 6400

Facsimile : +81 463 50 6401

Radiated Spurious Emission (Reference Plot for band-edge)

Test place	Shonan EMC Lab.
Semi Anechoic Chamber	No.3
Date	January 15, 2019
Temperature / Humidity	20 deg.C / 35 %RH
Engineer	Kazutaka Takeyama
	(1 GHz – 2.8 GHz)
Mode	Tx, IEEE802.11b , 2467 MHz

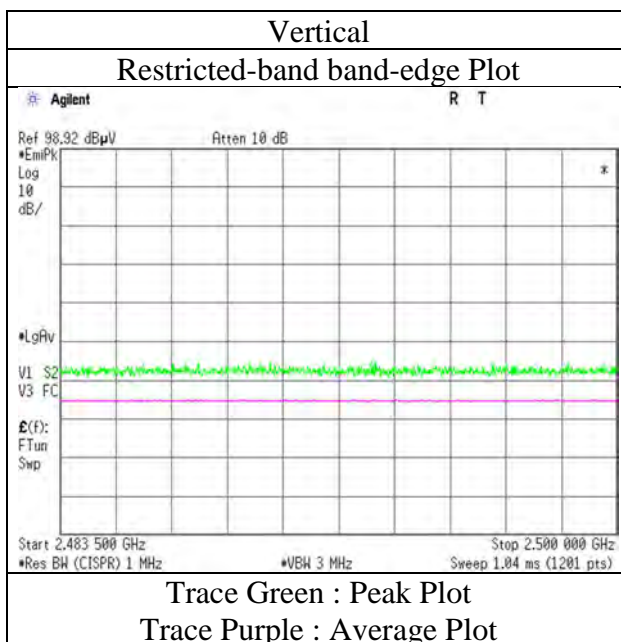
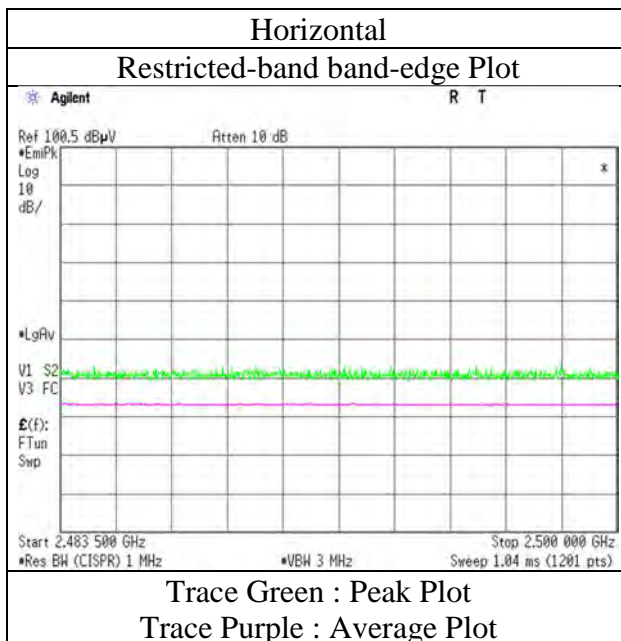

* The measurement was conducted for a sufficiently long enough time to detect any possible spurious emissions. Final result of restricted band edge was shown in tabular data.

Radiated Emission

Report No. 12656071S
 Test place Shonan EMC Lab.
 Semi Anechoic Chamber No.3 No.3 No.1 No.3
 Date January 15, 2019 January 16, 2019 February 24, 2019 January 17, 2019
 Temperature / Humidity 20 deg.C / 35 %RH 20 deg.C / 45 %RH 22 deg.C / 33 %RH 21 deg.C / 35 %RH
 Engineer Kazutaka Takeyama Kenichi Adachi Kazutaka Takeyama Makoto Hosaka
 (1 GHz -2.8 GHz) (2.8 GHz - 13 GHz) (13 GHz - 18 GHz) (18 GHz- 26.5 GHz)
 Mode Tx, 2472 MHz
 Tx, IEEE802.11b,

(* PK: Peak, AV: Average, QP: Quasi-Peak)

Polarity	Frequency [MHz]	Detector	Reading [dBuV]	Ant.Fac. [dB/m]	Loss [dB]	Gain [dB]	Distance Factor [dB]	Result [dBuV/m]	Limit [dBuV/m]	Margin [dB]	Height [cm]	Angle [deg]	Remark
Hori.	2483.500	PK	42.10	27.65	14.77	34.77	2.26	52.01	73.90	21.8	238	52	
Hori.	4944.000	PK	41.02	31.44	7.27	34.03	2.26	47.96	73.90	25.9	185	222	
Hori.	7416.000	PK	41.05	37.03	9.14	33.82	2.26	55.66	73.90	18.2	183	23	
Hori.	9888.000	PK	41.62	39.00	10.38	34.10	2.26	59.16	73.90	14.7	181	189	
Hori.	2483.500	AV	33.60	27.65	14.77	34.77	2.26	43.51	53.90	10.3	238	52	
Hori.	4944.000	AV	30.61	31.44	7.27	34.03	2.26	37.55	53.90	16.3	185	222	
Hori.	7416.000	AV	29.88	37.03	9.14	33.82	2.26	44.49	53.90	9.4	183	23	
Hori.	9888.000	AV	31.34	39.00	10.38	34.10	2.26	48.88	53.90	5.0	181	189	
Vert.	2483.500	PK	43.00	27.65	14.77	34.77	2.26	52.91	73.90	20.9	111	110	
Vert.	4944.000	PK	41.07	31.44	7.27	34.03	2.26	48.01	73.90	25.8	148	28	
Vert.	7416.000	PK	41.26	37.03	9.14	33.82	2.26	55.87	73.90	18.0	103	295	
Vert.	9888.000	PK	41.77	39.00	10.38	34.10	2.26	59.31	73.90	14.5	199	159	
Vert.	2483.500	AV	33.60	27.65	14.77	34.77	2.26	43.51	53.90	10.3	111	110	
Vert.	4944.000	AV	29.58	31.44	7.27	34.03	2.26	36.52	53.90	17.3	148	28	
Vert.	7416.000	AV	29.98	37.03	9.14	33.82	2.26	44.59	53.90	9.3	103	295	
Vert.	9888.000	AV	31.68	39.00	10.38	34.10	2.26	49.22	53.90	4.6	199	159	

Result = Reading + Ant.Fac. + Loss (Cable+(Attenuator or Filter)(below 18 GHz)) - Gain(Amplifier) + Distance factor

Distance factor : 1 GHz - 13 GHz : $20\log(3.89\text{ m} / 3.0\text{ m}) = 2.26\text{ dB}$

13 GHz - 40 GHz : $20\log(1.0\text{ m} / 3.0\text{ m}) = -9.54\text{ dB}$

UL Japan, Inc.

Shonan EMC Lab.

1-22-3 Megumigaoka, Hiratsuka-shi, Kanagawa 259-1220 JAPAN

Telephone : +81 463 50 6400

Facsimile : +81 463 50 6401

Radiated Spurious Emission (Reference Plot for band-edge)

Test place	Shonan EMC Lab.
Semi Anechoic Chamber	No.3
Date	January 15, 2019
Temperature / Humidity	20 deg.C / 35 %RH
Engineer	Kazutaka Takeyama (1 GHz – 2.8 GHz)
Mode	Tx, IEEE802.11b , 2472 MHz

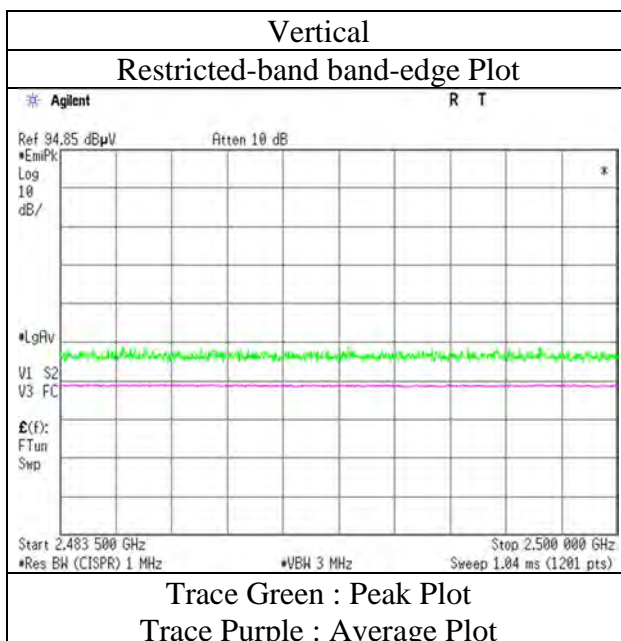
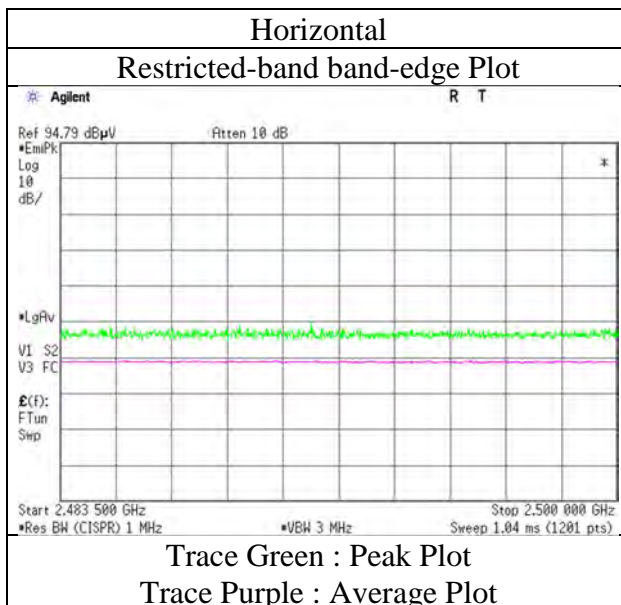

* The measurement was conducted for a sufficiently long enough time to detect any possible spurious emissions. Final result of restricted band edge was shown in tabular data.

Radiated Emission

Report No. 12656071S
 Test place Shonan EMC Lab.
 Semi Anechoic Chamber No.3 No.3 No.3 No.3
 Date February 20, 2019 February 24, 2019 February 25, 2019 February 25, 2019
 Temperature / Humidity 26 deg.C / 35 %RH 22 deg.C / 33 %RH 25 deg.C / 35 %RH 25 deg.C / 35 %RH
 Engineer Yosuke Ishikawa Kazutaka Takeyama Kazutaka Takeyama Kazutaka Takeyama
 (1 GHz - 2.8 GHz) (2.8 GHz - 13 GHz) (13 GHz - 18 GHz) (18 GHz - 26.5 GHz)
 Mode Tx, 2412 MHz
 Tx, OFDM VHT20 (SISO)

(* PK: Peak, AV: Average, QP: Quasi-Peak)

Polarity	Frequency [MHz]	Detector	Reading [dBuV]	Ant.Fac. [dB/m]	Loss [dB]	Gain [dB]	Distance Factor [dB]	Result [dBuV/m]	Limit [dBuV/m]	Margin [dB]	Height [cm]	Angle [deg]	Remark
Hori.	2390.000	PK	54.77	27.86	14.78	41.59	2.26	58.08	73.90	15.8	153	232	
Hori.	4824.000	PK	47.78	31.34	6.52	39.50	2.26	48.40	73.90	25.5	157	135	
Hori.	7236.000	PK	47.45	36.81	7.77	39.31	2.26	54.98	73.90	18.9	170	78	
Hori.	9648.000	PK	46.22	38.26	8.92	39.49	2.26	56.17	73.90	17.7	148	354	
Hori.	2390.000	AV	40.70	27.86	14.78	41.59	2.26	44.01	53.90	9.8	153	232	
Hori.	4824.000	AV	36.64	31.34	6.52	39.50	2.26	37.26	53.90	16.6	157	135	
Hori.	7236.000	AV	37.13	36.81	7.77	39.31	2.26	44.66	53.90	9.2	170	78	
Hori.	9648.000	AV	36.31	38.26	8.92	39.49	2.26	46.26	53.90	7.6	148	354	
Vert.	2390.000	PK	54.42	27.86	14.78	41.59	2.26	57.73	73.90	16.1	184	257	
Vert.	4824.000	PK	49.78	31.34	6.52	39.50	2.26	50.40	73.90	23.5	119	25	
Vert.	7236.000	PK	47.62	36.81	7.77	39.31	2.26	55.15	73.90	18.7	131	298	
Vert.	9648.000	PK	45.78	38.26	8.92	39.49	2.26	55.73	73.90	18.1	152	172	
Vert.	2390.000	AV	41.53	27.86	14.78	41.59	2.26	44.84	53.90	9.0	184	257	
Vert.	4824.000	AV	38.32	31.34	6.52	39.50	2.26	38.94	53.90	14.9	119	25	
Vert.	7236.000	AV	37.23	36.81	7.77	39.31	2.26	44.76	53.90	9.1	131	298	
Vert.	9648.000	AV	36.08	38.26	8.92	39.49	2.26	46.03	53.90	7.8	152	172	

Result = Reading + Ant.Fac. + Loss (Cable+(Attenuator or Filter)(below 18 GHz)) - Gain(Amplifier) + Distance factor

Distance factor : 1 GHz - 13 GHz : 20log (3.89 m / 3.0 m) = 2.26 dB

13 GHz - 40 GHz : 20log (1.0 m / 3.0 m) = -9.54 dB

20 dBc Data Sheet (RBW 100 kHz, VBW 300 kHz)

Polarity	Frequency [MHz]	Detector	Reading [dBuV]	Ant.Fac. [dB/m]	Loss [dB]	Gain [dB]	Distance Factor [dB]	Result [dBuV/m]	Limit [dBuV/m]	Margin [dB]	Remark
Hori.	2412.000	PK	91.04	27.85	14.80	41.60	2.26	94.35	-	-	Carrier
Hori.	2400.000	PK	49.15	27.86	14.79	41.60	2.26	52.46	74.35	21.8	
Vert.	2412.000	PK	92.28	27.85	14.80	41.60	2.26	95.59	-	-	Carrier
Vert.	2400.000	PK	50.32	27.86	14.79	41.60	2.26	53.63	75.59	21.9	

Result = Reading + Ant.Fac. + Loss (Cable+(Attenuator or Filter)(below 18 GHz)) - Gain(Amplifier) + Distance factor

Distance factor : 1 GHz - 13 GHz : 20log (3.89 m / 3.0 m) = 2.26 dB

13 GHz - 40 GHz : 20log (1.0 m / 3.0 m) = -9.54 dB

UL Japan, Inc.**Shonan EMC Lab.**

1-22-3 Megumigaoka, Hiratsuka-shi, Kanagawa 259-1220 JAPAN

Telephone : +81 463 50 6400

Facsimile : +81 463 50 6401

Radiated Spurious Emission (Reference Plot for band-edge)

Test place	Shonan EMC Lab.
Semi Anechoic Chamber	No.3
Date	February 20, 2019
Temperature / Humidity	26 deg.C / 35 %RH
Engineer	Yosuke Ishikawa
	(1 GHz – 2.8 GHz)
Mode	Tx, OFDM VHT20 (SISO) ,2412 MHz

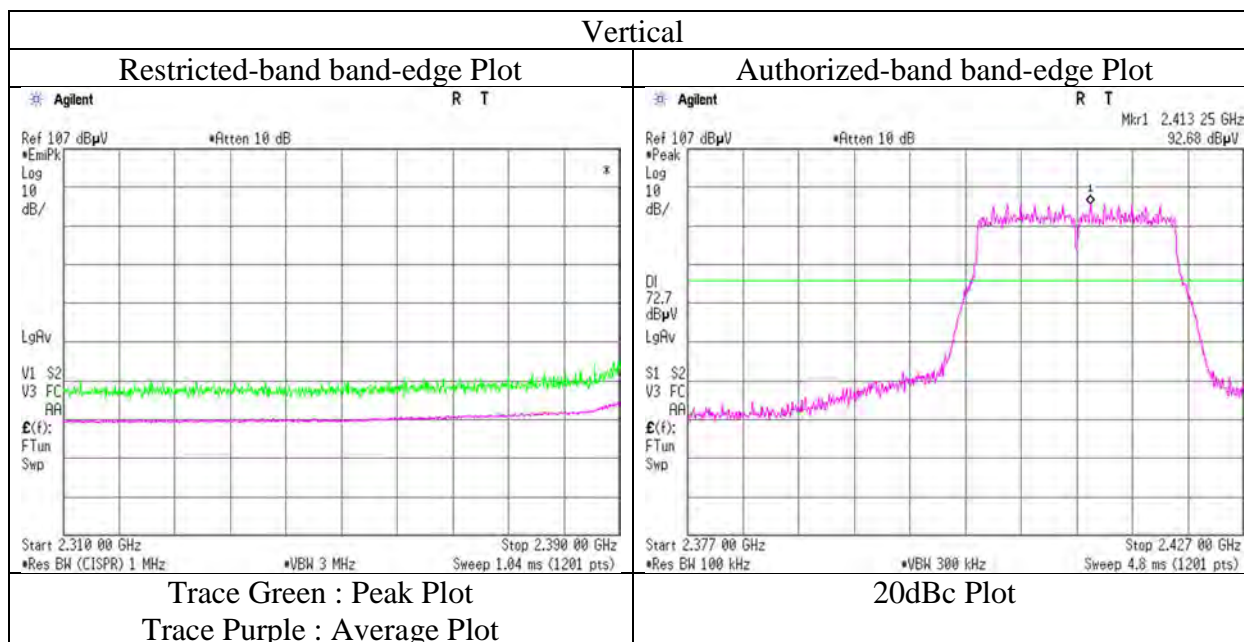
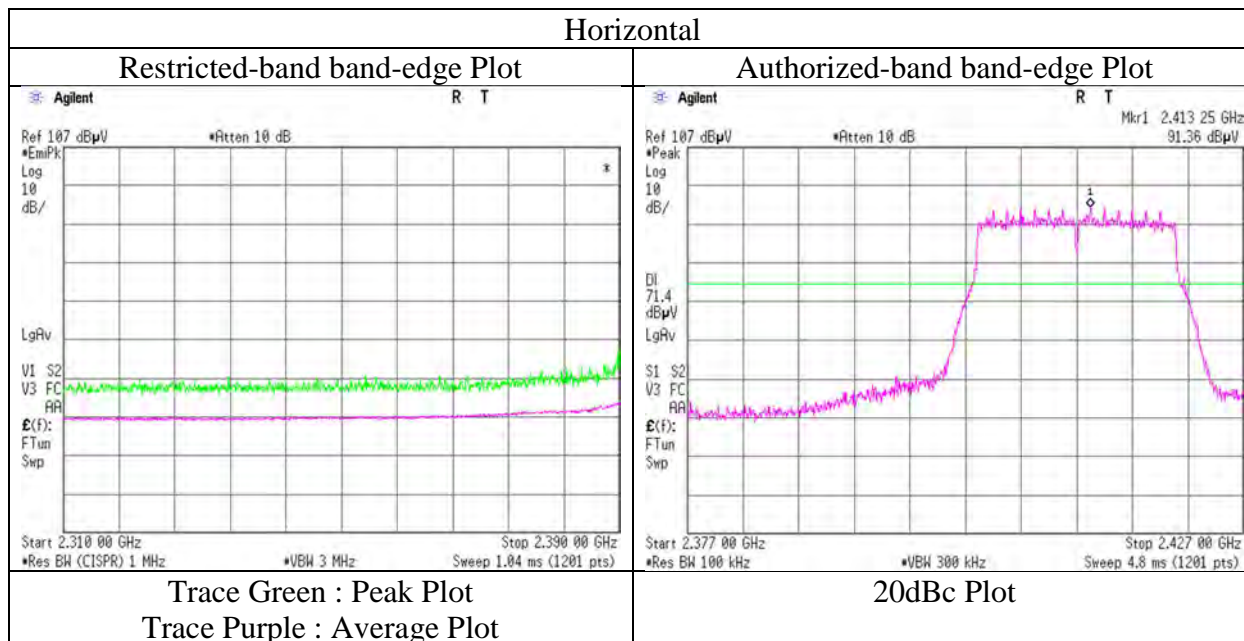

* The measurement was conducted for a sufficiently long enough time to detect any possible spurious emissions. Final result of restricted band edge was shown in tabular data.

UL Japan, Inc.

Shonan EMC Lab.

1-22-3 Megumigaoka, Hiratsuka-shi, Kanagawa-ken, 259-1220 JAPAN

Telephone : +81 463 50 6400

Facsimile : +81 463 50 6401

Radiated Emission

Report No. 12656071S
 Test place Shonan EMC Lab.
 Semi Anechoic Chamber No.3 No.3 No.3 No.3
 Date January 24, 2019 February 24, 2019 February 25, 2019 February 25, 2019
 Temperature / Humidity 25 deg.C / 21 %RH 22 deg.C / 33 %RH 25 deg.C / 35 %RH 25 deg.C / 35 %RH
 Engineer Yosuke Ishikawa Kazutaka Takeyama Kazutaka Takeyama Kazutaka Takeyama
 (1 GHz - 2.8 GHz) (2.8 GHz - 13 GHz) (13 GHz - 18 GHz) (18 GHz - 26.5 GHz)
 Mode Tx, 2417 MHz
 Tx, OFDM VHT20 (SISO)

(* PK: Peak, AV: Average, QP: Quasi-Peak)

Polarity	Frequency [MHz]	Detector	Reading [dBuV]	Ant.Fac. [dB/m]	Loss [dB]	Gain [dB]	Distance Factor [dB]	Result [dBuV/m]	Limit [dBuV/m]	Margin [dB]	Height [cm]	Angle [deg]	Remark
Hori.	2390.000	PK	51.41	27.86	14.67	34.78	2.26	61.42	73.90	12.4	100		217
Hori.	4834.000	PK	48.33	31.33	6.52	39.50	2.26	48.94	73.90	24.9	178		129
Hori.	7251.000	PK	47.60	36.82	7.77	39.32	2.26	55.13	73.90	18.7	149		82
Hori.	9668.000	PK	46.14	38.28	8.92	39.48	2.26	56.12	73.90	17.7	150		0
Hori.	2390.000	AV	39.15	27.86	14.67	34.78	2.26	49.16	53.90	4.7	100		217
Hori.	4834.000	AV	38.69	31.33	6.52	39.50	2.26	39.30	53.90	14.6	178		129
Hori.	7251.000	AV	37.41	36.82	7.77	39.32	2.26	44.94	53.90	8.9	149		82
Hori.	9668.000	AV	35.91	38.28	8.92	39.48	2.26	45.89	53.90	8.0	150		0
Vert.	2390.000	PK	54.10	27.86	14.67	34.78	2.26	64.11	73.90	9.7	155		95
Vert.	4834.000	PK	48.41	31.33	6.52	39.50	2.26	49.02	73.90	24.8	128		33
Vert.	7251.000	PK	48.37	36.82	7.77	39.32	2.26	55.90	73.90	18.0	107		298
Vert.	9668.000	PK	46.20	38.28	8.92	39.48	2.26	56.18	73.90	17.7	150		0
Vert.	2390.000	AV	40.37	27.86	14.67	34.78	2.26	50.38	53.90	3.5	155		95
Vert.	4834.000	AV	38.72	31.33	6.52	39.50	2.26	39.33	53.90	14.5	128		33
Vert.	7251.000	AV	37.92	36.82	7.77	39.32	2.26	45.45	53.90	8.4	107		298
Vert.	9668.000	AV	35.79	38.28	8.92	39.48	2.26	45.77	53.90	8.1	150		0

Result = Reading + Ant.Fac. + Loss (Cable+(Attenuator or Filter)(below 18 GHz)) - Gain(Amplifier) + Distance factor

Distance factor : 1 GHz - 13 GHz : 20log (3.89 m / 3.0 m) = 2.26 dB

13 GHz - 40 GHz : 20log (1.0 m / 3.0 m) = -9.54 dB

20 dBc Data Sheet (RBW 100 kHz, VBW 300 kHz)

Polarity	Frequency [MHz]	Detector	Reading [dBuV]	Ant.Fac. [dB/m]	Loss [dB]	Gain [dB]	Distance Factor [dB]	Result [dBuV/m]	Limit [dBuV/m]	Margin [dB]	Remark
Hori.	2417.000	PK	87.86	27.84	14.69	34.78	2.26	97.87	-	-	Carrier
Hori.	2400.000	PK	46.88	27.86	14.68	34.78	2.26	56.90	77.87	20.9	
Vert.	2417.000	PK	89.91	27.84	14.69	34.78	2.26	99.92	-	-	Carrier
Vert.	2400.000	PK	45.73	27.86	14.68	34.78	2.26	55.75	79.92	24.1	

Result = Reading + Ant.Fac. + Loss (Cable+(Attenuator or Filter)(below 18 GHz)) - Gain(Amplifier) + Distance factor

Distance factor : 1 GHz - 13 GHz : 20log (3.89 m / 3.0 m) = 2.26 dB

13 GHz - 40 GHz : 20log (1.0 m / 3.0 m) = -9.54 dB

UL Japan, Inc.**Shonan EMC Lab.**

1-22-3 Megumigaoka, Hiratsuka-shi, Kanagawa 259-1220 JAPAN

Telephone : +81 463 50 6400

Facsimile : +81 463 50 6401

Radiated Spurious Emission (Reference Plot for band-edge)

Test place	Shonan EMC Lab.
Semi Anechoic Chamber	No.3
Date	January 24, 2019
Temperature / Humidity	25 deg.C / 21 %RH
Engineer	Yosuke Ishikawa
	(1 GHz – 2.8 GHz)
Mode	Tx, OFDM VHT20 (SISO) ,2417 MHz

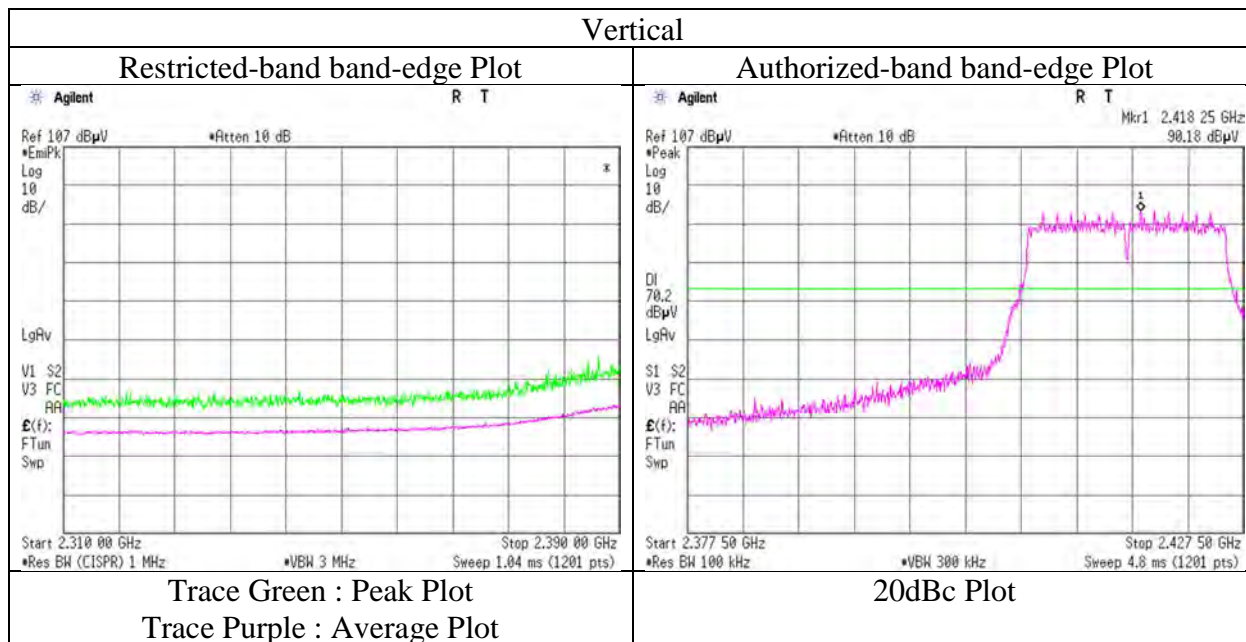
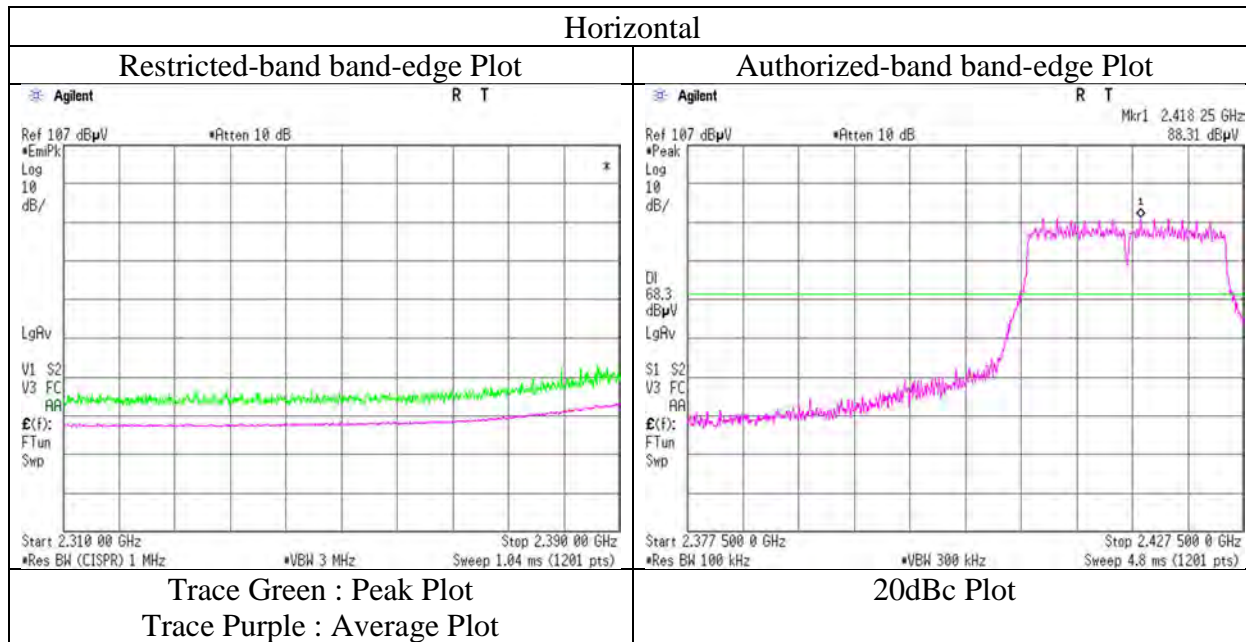

* The measurement was conducted for a sufficiently long enough time to detect any possible spurious emissions. Final result of restricted band edge was shown in tabular data.

UL Japan, Inc.

Shonan EMC Lab.

1-22-3 Megumigaoka, Hiratsuka-shi, Kanagawa-ken, 259-1220 JAPAN

Telephone : +81 463 50 6400

Facsimile : +81 463 50 6401

Radiated Emission

Report No. 12656071S
 Test place Shonan EMC Lab.
 Semi Anechoic Chamber No.3 No.3 No.3 No.3
 Date January 15, 2019 January 16, 2019 February 25, 2019 January 17, 2019
 Temperature / Humidity 20 deg.C / 35 %RH 22 deg.C / 44 %RH 25 deg.C / 35 %RH 21 deg.C / 35 %RH
 Engineer Kazutaka Takeyama Makoto Hosaka Kazutaka Takeyama Makoto Hosaka
 (1 GHz -2.8 GHz) (2.8 GHz - 13 GHz) (13 GHz - 18 GHz) (18 GHz- 26.5 GHz)
 Mode Tx, 2437 MHz
 Tx, OFDM VHT20 (SISO)

(* PK: Peak, AV: Average, QP: Quasi-Peak)

Polarity	Frequency [MHz]	Detector	Reading [dBuV]	Ant.Fac. [dB/m]	Loss [dB]	Gain [dB]	Distance Factor [dB]	Result [dBuV/m]	Limit [dBuV/m]	Margin [dB]	Height [cm]	Angle [deg]	Remark
Hori.	4874.000	PK	48.00	31.40	7.21	39.50	2.26	49.37	73.90	24.5	105	274	
Hori.	7311.000	PK	45.96	36.99	9.08	39.35	2.26	54.94	73.90	18.9	164	26	
Hori.	9748.000	PK	43.88	38.92	10.45	39.42	2.26	56.09	73.90	17.8	150	149	
Hori.	4874.000	AV	36.90	31.40	7.21	39.50	2.26	38.27	53.90	15.6	105	274	
Hori.	7311.000	AV	35.33	36.99	9.08	39.35	2.26	44.31	53.90	9.5	164	26	
Hori.	9748.000	AV	33.42	38.92	10.45	39.42	2.26	45.63	53.90	8.2	150	149	
Hori.	12185.000	AV	32.46	39.26	12.04	38.55	2.26	47.47	53.90	6.4	150	0	
Vert.	4874.000	PK	47.57	31.40	7.21	39.50	2.26	48.94	73.90	24.9	110	24	
Vert.	7311.000	PK	46.27	36.99	9.08	39.35	2.26	55.25	73.90	18.6	123	268	
Vert.	9748.000	PK	44.34	38.92	10.45	39.42	2.26	56.55	73.90	17.3	132	169	
Vert.	4874.000	AV	36.84	31.40	7.21	39.50	2.26	38.21	53.90	15.6	110	24	
Vert.	7311.000	AV	35.41	36.99	9.08	39.35	2.26	44.39	53.90	9.5	123	268	
Vert.	9748.000	AV	33.44	38.92	10.45	39.42	2.26	45.65	53.90	8.2	132	169	

Result = Reading + Ant.Fac. + Loss (Cable+(Attenuator or Filter)(below 18 GHz)) - Gain(Amplifier) + Distance factor

Distance factor : 1 GHz - 13 GHz : $20\log(3.89\text{ m} / 3.0\text{ m}) = 2.26\text{ dB}$

13 GHz - 40 GHz : $20\log(1.0\text{ m} / 3.0\text{ m}) = -9.54\text{ dB}$

UL Japan, Inc.

Shonan EMC Lab.

1-22-3 Megumigaoka, Hiratsuka-shi, Kanagawa 259-1220 JAPAN

Telephone : +81 463 50 6400

Facsimile : +81 463 50 6401

Radiated Emission

Report No. 12656071S
 Test place Shonan EMC Lab.
 Semi Anechoic Chamber No.3 No.3 No.3 No.3
 Date January 15, 2019 January 16, 2019 February 25, 2019 January 17, 2019
 Temperature / Humidity 20 deg.C / 35 %RH 22 deg.C / 44 %RH 25 deg.C / 35 %RH 21 deg.C / 35 %RH
 Engineer Kazutaka Takeyama Makoto Hosaka Kazutaka Takeyama Makoto Hosaka
 (1 GHz - 2.8 GHz) (2.8 GHz - 13 GHz) (13 GHz - 18 GHz) (18 GHz - 26.5 GHz)
 Mode Tx, 2462 MHz
 Tx, OFDM VHT20 (SISO)

(* PK: Peak, AV: Average, QP: Quasi-Peak)

Polarity	Frequency [MHz]	Detector	Reading [dBuV]	Ant.Fac. [dB/m]	Loss [dB]	Gain [dB]	Distance Factor [dB]	Result [dBuV/m]	Limit [dBuV/m]	Margin [dB]	Height [cm]	Angle [deg]	Remark
Hori.	2483.500	PK	58.00	27.65	14.77	34.77	2.26	67.91	73.90	5.9	327	51	
Hori.	4924.000	PK	47.85	31.37	7.25	39.50	2.26	49.23	73.90	24.6	207	282	
Hori.	7386.000	PK	46.00	37.01	9.13	39.39	2.26	55.01	73.90	18.8	257	280	
Hori.	9848.000	PK	44.98	39.12	10.38	39.35	2.26	57.39	73.90	16.5	150	0	
Hori.	2483.500	AV	39.70	27.65	14.77	34.77	2.26	49.61	53.90	4.2	327	51	
Hori.	4924.000	AV	36.77	31.37	7.25	39.50	2.26	38.15	53.90	15.7	207	282	
Hori.	7386.000	AV	34.55	37.01	9.13	39.39	2.26	43.56	53.90	10.3	257	280	
Hori.	9848.000	AV	33.75	39.12	10.38	39.35	2.26	46.16	53.90	7.7	150	0	
Vert.	2483.500	PK	57.10	27.65	14.77	34.77	2.26	67.01	73.90	6.8	113	237	
Vert.	4924.000	PK	47.36	31.37	7.25	39.50	2.26	48.74	73.90	25.1	102	30	
Vert.	7386.000	PK	45.69	37.01	9.13	39.39	2.26	54.70	73.90	19.2	129	291	
Vert.	9848.000	PK	44.31	39.12	10.38	39.35	2.26	56.72	73.90	17.1	150	107	
Vert.	2483.500	AV	39.70	27.65	14.77	34.77	2.26	49.61	53.90	4.2	113	237	
Vert.	4924.000	AV	36.56	31.37	7.25	39.50	2.26	37.94	53.90	15.9	102	30	
Vert.	7386.000	AV	34.80	37.01	9.13	39.39	2.26	43.81	53.90	10.0	129	291	
Vert.	9848.000	AV	33.59	39.12	10.38	39.35	2.26	46.00	53.90	7.9	150	107	

Result = Reading + Ant.Fac. + Loss (Cable+(Attenuator or Filter)(below 18 GHz)) - Gain(Amplifier) + Distance factor

Distance factor : 1 GHz - 13 GHz : $20\log(3.89\text{ m} / 3.0\text{ m}) = 2.26\text{ dB}$

13 GHz - 40 GHz : $20\log(1.0\text{ m} / 3.0\text{ m}) = -9.54\text{ dB}$

UL Japan, Inc.

Shonan EMC Lab.

1-22-3 Megumigaoka, Hiratsuka-shi, Kanagawa 259-1220 JAPAN

Telephone : +81 463 50 6400

Facsimile : +81 463 50 6401

Radiated Spurious Emission (Reference Plot for band-edge)

Test place	Shonan EMC Lab.
Semi Anechoic Chamber	No.3
Date	January 15, 2019
Temperature / Humidity	20 deg.C / 35 %RH
Engineer	Kazutaka Takeyama
	(1 GHz – 2.8 GHz)
Mode	Tx, OFDM VHT20 (SISO) ,2462 MHz

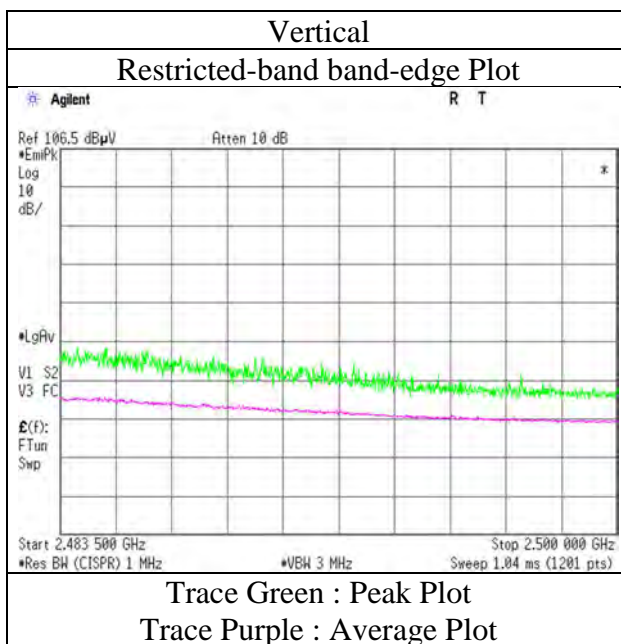
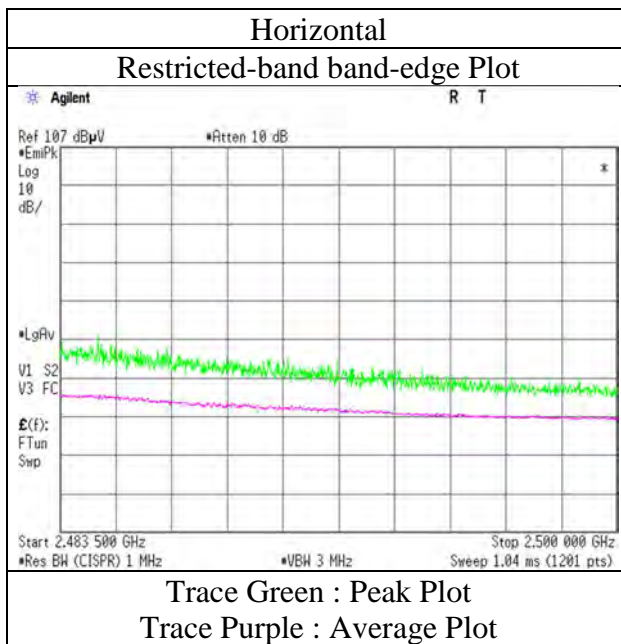

* The measurement was conducted for a sufficiently long enough time to detect any possible spurious emissions. Final result of restricted band edge was shown in tabular data.

UL Japan, Inc.

Shonan EMC Lab.

1-22-3 Megumigaoka, Hiratsuka-shi, Kanagawa-ken, 259-1220 JAPAN

Telephone : +81 463 50 6400

Facsimile : +81 463 50 6401

Radiated Emission

Report No. 12656071S
 Test place Shonan EMC Lab.
 Semi Anechoic Chamber No.3 No.3 No.3 No.3
 Date January 15, 2019 January 16, 2019 February 25, 2019 January 17, 2019
 Temperature / Humidity 20 deg.C / 35 %RH 22 deg.C / 44 %RH 25 deg.C / 35 %RH 21 deg.C / 35 %RH
 Engineer Kazutaka Takeyama Makoto Hosaka Kazutaka Takeyama Makoto Hosaka
 (1 GHz - 2.8 GHz) (2.8 GHz - 13 GHz) (13 GHz - 18 GHz) (18 GHz - 26.5 GHz)
 Mode Tx, 2467 MHz
 Tx, OFDM VHT20 (SISO)

(* PK: Peak, AV: Average, QP: Quasi-Peak)

Polarity	Frequency [MHz]	Detector	Reading [dBuV]	Ant.Fac. [dB/m]	Loss [dB]	Gain [dB]	Distance Factor [dB]	Result [dBuV/m]	Limit [dBuV/m]	Margin [dB]	Height [cm]	Angle [deg]	Remark
Hori.	2483.500	PK	45.10	27.65	14.77	34.77	2.26	55.01	73.90	18.8	400	44	
Hori.	4934.000	PK	45.21	31.41	7.26	39.50	2.26	46.64	73.90	27.2	150	250	
Hori.	7401.000	PK	44.71	36.99	9.13	39.40	2.26	53.69	73.90	20.2	150	0	
Hori.	9868.000	PK	45.13	39.07	10.38	39.34	2.26	57.50	73.90	16.4	150	0	
Hori.	2483.500	AV	34.70	27.65	14.77	34.77	2.26	44.61	53.90	9.2	400	44	
Hori.	4934.000	AV	34.31	31.41	7.26	39.50	2.26	35.74	53.90	18.1	150	250	
Hori.	7401.000	AV	34.42	36.99	9.13	39.40	2.26	43.40	53.90	10.5	150	0	
Hori.	9868.000	AV	34.19	39.07	10.38	39.34	2.26	46.56	53.90	7.3	150	0	
Vert.	2483.500	PK	44.40	27.65	14.77	34.77	2.26	54.31	73.90	19.5	100	237	
Vert.	4934.000	PK	45.19	31.41	7.26	39.50	2.26	46.62	73.90	27.2	196	25	
Vert.	7401.000	PK	44.86	36.99	9.13	39.40	2.26	53.84	73.90	20.0	150	0	
Vert.	9868.000	PK	45.07	39.07	10.38	39.34	2.26	57.44	73.90	16.4	150	0	
Vert.	2483.500	AV	34.90	27.65	14.77	34.77	2.26	44.81	53.90	9.0	100	237	
Vert.	4934.000	AV	34.22	31.41	7.26	39.50	2.26	35.65	53.90	18.2	196	25	
Vert.	7401.000	AV	34.25	36.99	9.13	39.40	2.26	43.23	53.90	10.6	150	0	
Vert.	9868.000	AV	33.96	39.07	10.38	39.34	2.26	46.33	53.90	7.5	150	0	

Result = Reading + Ant.Fac. + Loss (Cable+(Attenuator or Filter)(below 18 GHz)) - Gain(Amplifier) + Distance factor

Distance factor : 1 GHz - 13 GHz : $20\log(3.89\text{ m} / 3.0\text{ m}) = 2.26\text{ dB}$

13 GHz - 40 GHz : $20\log(1.0\text{ m} / 3.0\text{ m}) = -9.54\text{ dB}$

UL Japan, Inc.

Shonan EMC Lab.

1-22-3 Megumigaoka, Hiratsuka-shi, Kanagawa 259-1220 JAPAN

Telephone : +81 463 50 6400

Facsimile : +81 463 50 6401

Radiated Spurious Emission (Reference Plot for band-edge)

Test place	Shonan EMC Lab.
Semi Anechoic Chamber	No.3
Date	January 15, 2019
Temperature / Humidity	20 deg.C / 35 %RH
Engineer	Kazutaka Takeyama
	(1 GHz – 2.8 GHz)
Mode	Tx, OFDM VHT20 (SISO) ,2467 MHz

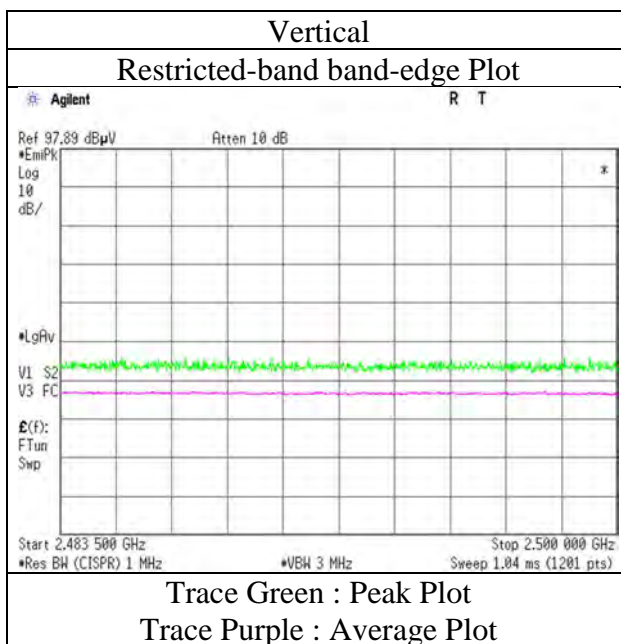
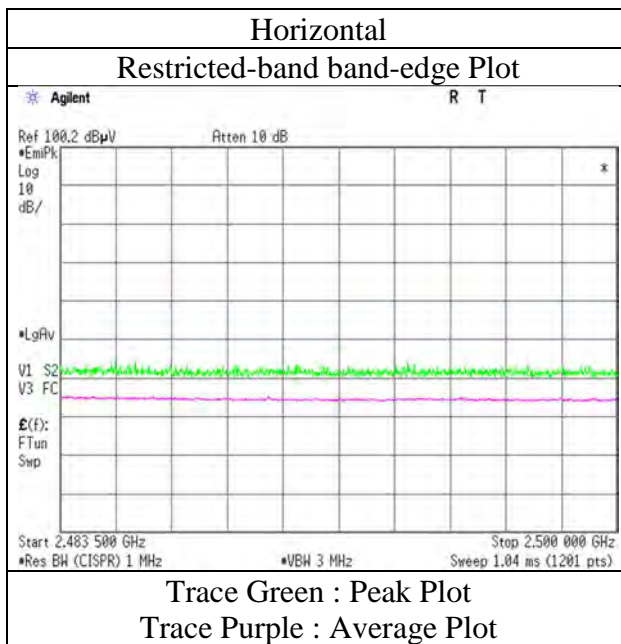

* The measurement was conducted for a sufficiently long enough time to detect any possible spurious emissions. Final result of restricted band edge was shown in tabular data.

UL Japan, Inc.

Shonan EMC Lab.

1-22-3 Megumigaoka, Hiratsuka-shi, Kanagawa-ken, 259-1220 JAPAN

Telephone : +81 463 50 6400

Facsimile : +81 463 50 6401

Radiated Emission

Report No. 12656071S
 Test place Shonan EMC Lab.
 Semi Anechoic Chamber No.3 No.3 No.3 No.3
 Date January 15, 2019 January 16, 2019 February 25, 2019 January 17, 2019
 Temperature / Humidity 20 deg.C / 35 %RH 22 deg.C / 44 %RH 25 deg.C / 35 %RH 21 deg.C / 35 %RH
 Engineer Kazutaka Takeyama Makoto Hosaka Kazutaka Takeyama Makoto Hosaka
 (1 GHz - 2.8 GHz) (2.8 GHz - 13 GHz) (13 GHz - 18 GHz) (18 GHz - 26.5 GHz)
 Mode Tx, 2472 MHz
 Tx, OFDM VHT20 (SISO)

(* PK: Peak, AV: Average, QP: Quasi-Peak)

Polarity	Frequency [MHz]	Detector	Reading [dBuV]	Ant.Fac. [dB/m]	Loss [dB]	Gain [dB]	Distance Factor [dB]	Result [dBuV/m]	Limit [dBuV/m]	Margin [dB]	Height [cm]	Angle [deg]	Remark
Hori.	2483.500	PK	45.20	27.65	14.77	34.77	2.26	55.11	73.90	18.7	400	45	
Hori.	4944.000	PK	45.11	31.44	7.27	39.50	2.26	46.58	73.90	27.3	185	269	
Hori.	7416.000	PK	45.22	37.03	9.14	39.40	2.26	54.25	73.90	19.6	150	0	
Hori.	9888.000	PK	44.35	39.00	10.38	39.32	2.26	56.67	73.90	17.2	150	0	
Hori.	2483.500	AV	34.50	27.65	14.77	34.77	2.26	44.41	53.90	9.4	400	45	
Hori.	4944.000	AV	33.96	31.44	7.27	39.50	2.26	35.43	53.90	18.4	185	269	
Hori.	7416.000	AV	34.46	37.03	9.14	39.40	2.26	43.49	53.90	10.4	150	0	
Hori.	9888.000	AV	34.34	39.00	10.38	39.32	2.26	46.66	53.90	7.2	150	0	
Vert.	2483.500	PK	44.60	27.65	14.77	34.77	2.26	54.51	73.90	19.3	100	241	
Vert.	4944.000	PK	45.02	31.44	7.27	39.50	2.26	46.49	73.90	27.4	100	23	
Vert.	7416.000	PK	45.50	37.03	9.14	39.40	2.26	54.53	73.90	19.3	150	0	
Vert.	9888.000	PK	45.21	39.00	10.38	39.32	2.26	57.53	73.90	16.3	150	0	
Vert.	2483.500	AV	34.50	27.65	14.77	34.77	2.26	44.41	53.90	9.4	100	241	
Vert.	4944.000	AV	34.18	31.44	7.27	39.50	2.26	35.65	53.90	18.2	100	23	
Vert.	7416.000	AV	34.29	37.03	9.14	39.40	2.26	43.32	53.90	10.5	150	0	
Vert.	9888.000	AV	33.54	39.00	10.38	39.32	2.26	45.86	53.90	8.0	150	0	

Result = Reading + Ant.Fac. + Loss (Cable+(Attenuator or Filter)(below 18 GHz)) - Gain(Amplifier) + Distance factor

Distance factor : 1 GHz - 13 GHz : $20\log(3.89\text{ m} / 3.0\text{ m}) = 2.26\text{ dB}$

13 GHz - 40 GHz : $20\log(1.0\text{ m} / 3.0\text{ m}) = -9.54\text{ dB}$

UL Japan, Inc.

Shonan EMC Lab.

1-22-3 Megumigaoka, Hiratsuka-shi, Kanagawa 259-1220 JAPAN

Telephone : +81 463 50 6400

Facsimile : +81 463 50 6401

Radiated Spurious Emission (Reference Plot for band-edge)

Test place	Shonan EMC Lab.
Semi Anechoic Chamber	No.3
Date	January 15, 2019
Temperature / Humidity	20 deg.C / 35 %RH
Engineer	Kazutaka Takeyama
	(1 GHz – 2.8 GHz)
Mode	Tx, OFDM VHT20 (SISO) ,2472 MHz

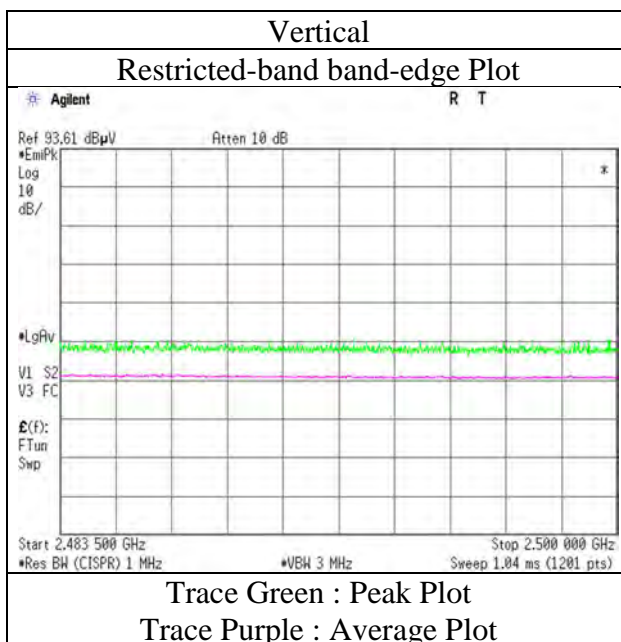
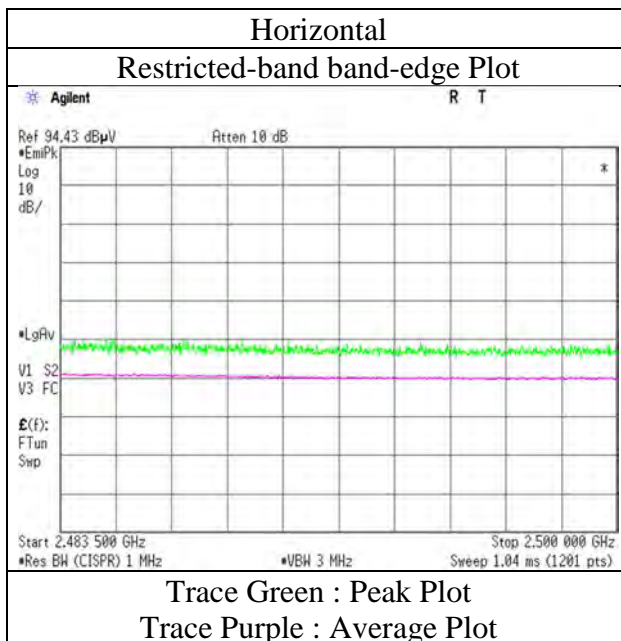

* The measurement was conducted for a sufficiently long enough time to detect any possible spurious emissions. Final result of restricted band edge was shown in tabular data.

Radiated Emission

Report No. 12656071S
 Test place Shonan EMC Lab.
 Semi Anechoic Chamber No.3 No.3 No.3 No.3
 Date January 24, 2019 February 24, 2019 February 25, 2019 February 25, 2019
 Temperature / Humidity 25 deg.C / 21 %RH 22 deg.C / 33 %RH 25 deg.C / 35 %RH 25 deg.C / 35 %RH
 Engineer Yosuke Ishikawa Kazutaka Takeyama Kazutaka Takeyama Kazutaka Takeyama
 (1 GHz - 2.8 GHz) (2.8 GHz - 13 GHz) (13 GHz - 18 GHz) (18 GHz - 26.5 GHz)
 Mode Tx, 2412 MHz
 Tx, OFDM VHT20 (MIMO)

(* PK: Peak, AV: Average, QP: Quasi-Peak)

Polarity	Frequency [MHz]	Detector	Reading [dBuV]	Ant.Fac. [dB/m]	Loss [dB]	Gain [dB]	Distance Factor [dB]	Result [dBuV/m]	Limit [dBuV/m]	Margin [dB]	Height [cm]	Angle [deg]	Remark
Hori.	2390.000	PK	50.44	27.86	14.67	34.78	2.26	60.45	73.90	13.4	100	254	
Hori.	4824.000	PK	47.86	31.34	6.52	39.50	2.26	48.48	73.90	25.4	136	228	
Hori.	7236.000	PK	47.32	36.81	7.77	39.31	2.26	54.85	73.90	19.0	272	274	
Hori.	9648.000	PK	46.37	38.26	8.92	39.49	2.26	56.32	73.90	17.5	176	209	
Hori.	2390.000	AV	37.25	27.86	14.67	34.78	2.26	47.26	53.90	6.6	100	254	
Hori.	4824.000	AV	37.96	31.34	6.52	39.50	2.26	38.58	53.90	15.3	136	228	
Hori.	7236.000	AV	37.04	36.81	7.77	39.31	2.26	44.57	53.90	9.3	272	274	
Hori.	9648.000	AV	36.28	38.26	8.92	39.49	2.26	46.23	53.90	7.6	176	209	
Vert.	2390.000	PK	47.82	27.86	14.67	34.78	2.26	57.83	73.90	16.0	115	108	
Vert.	4824.000	PK	48.64	31.34	6.52	39.50	2.26	49.26	73.90	24.6	114	31	
Vert.	7236.000	PK	47.70	36.81	7.77	39.31	2.26	55.23	73.90	18.6	111	293	
Vert.	9648.000	PK	46.83	38.26	8.92	39.49	2.26	56.78	73.90	17.1	159	196	
Vert.	2390.000	AV	35.24	27.86	14.67	34.78	2.26	45.25	53.90	8.6	115	108	
Vert.	4824.000	AV	38.92	31.34	6.52	39.50	2.26	39.54	53.90	14.3	114	31	
Vert.	7236.000	AV	37.01	36.81	7.77	39.31	2.26	44.54	53.90	9.3	111	293	
Vert.	9648.000	AV	36.33	38.26	8.92	39.49	2.26	46.28	53.90	7.6	159	196	

Result = Reading + Ant.Fac. + Loss (Cable+(Attenuator or Filter)(below 18 GHz)) - Gain(Amplifier) + Distance factor

Distance factor : 1 GHz - 13 GHz : 20log (3.89 m / 3.0 m) = 2.26 dB

13 GHz - 40 GHz : 20log (1.0 m / 3.0 m) = -9.54 dB

20 dBc Data Sheet (RBW 100 kHz, VBW 300 kHz)

Polarity	Frequency [MHz]	Detector	Reading [dBuV]	Ant.Fac. [dB/m]	Loss [dB]	Gain [dB]	Distance Factor [dB]	Result [dBuV/m]	Limit [dBuV/m]	Margin [dB]	Remark
Hori.	2412.000	PK	88.68	27.85	14.69	34.78	2.26	98.70	-	-	Carrier
Hori.	2400.000	PK	44.39	27.86	14.68	34.78	2.26	54.41	78.70	24.2	
Vert.	2412.000	PK	85.59	27.85	14.69	34.78	2.26	95.61	-	-	Carrier
Vert.	2400.000	PK	42.09	27.86	14.68	34.78	2.26	52.11	75.61	23.5	

Result = Reading + Ant.Fac. + Loss (Cable+(Attenuator or Filter)(below 18 GHz)) - Gain(Amplifier) + Distance factor

Distance factor : 1 GHz - 13 GHz : 20log (3.89 m / 3.0 m) = 2.26 dB

13 GHz - 40 GHz : 20log (1.0 m / 3.0 m) = -9.54 dB

UL Japan, Inc.

Shonan EMC Lab.

1-22-3 Megumigaoka, Hiratsuka-shi, Kanagawa 259-1220 JAPAN

Telephone : +81 463 50 6400

Facsimile : +81 463 50 6401

Radiated Spurious Emission (Reference Plot for band-edge)

Test place	Shonan EMC Lab.
Semi Anechoic Chamber	No.3
Date	January 24, 2019
Temperature / Humidity	25 deg.C / 21 %RH
Engineer	Yosuke Ishikawa
	(1 GHz – 2.8 GHz)
Mode	Tx, OFDM VHT20 (MIMO) ,2412 MHz

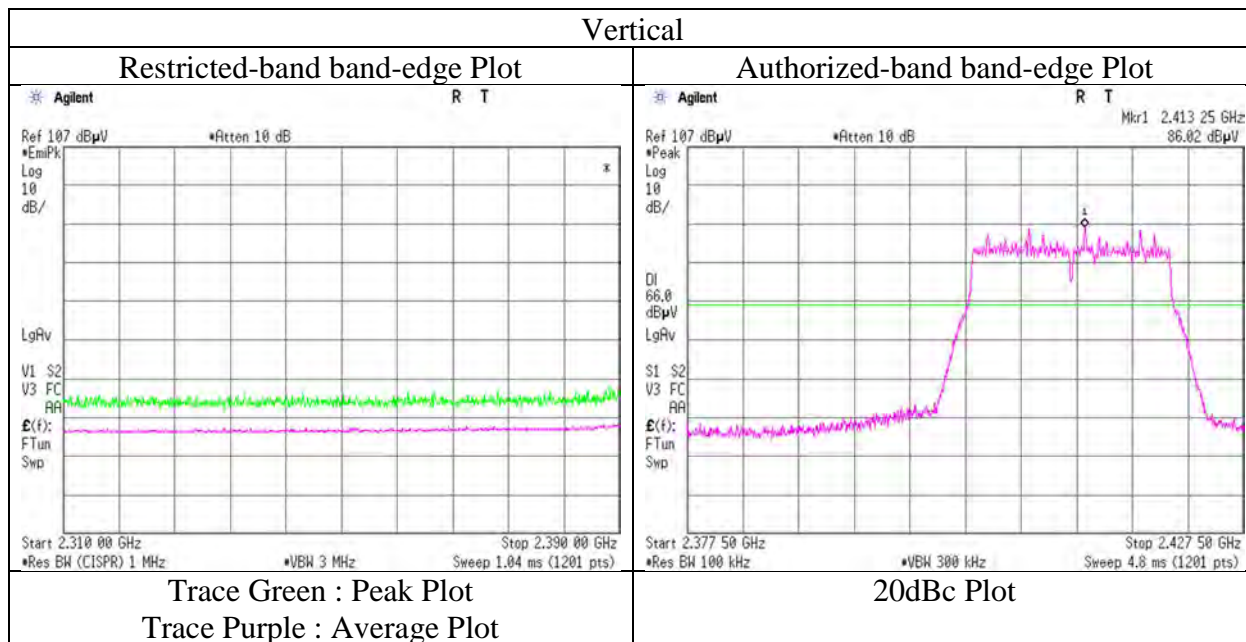
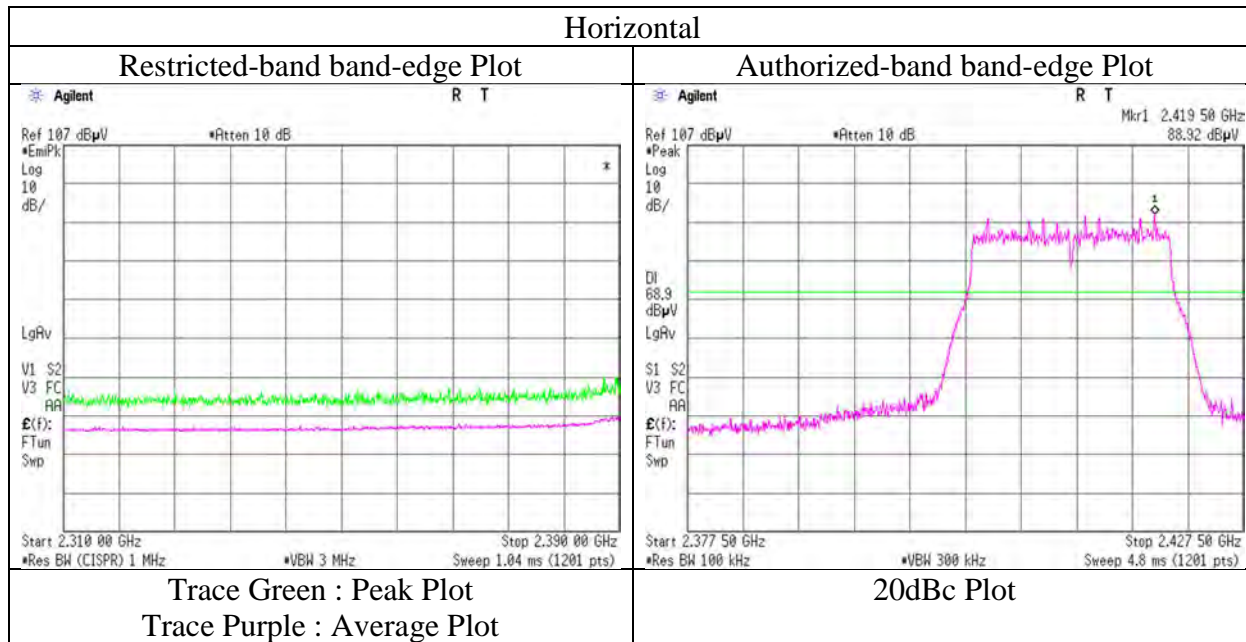

* The measurement was conducted for a sufficiently long enough time to detect any possible spurious emissions. Final result of restricted band edge was shown in tabular data.

UL Japan, Inc.

Shonan EMC Lab.

1-22-3 Megumigaoka, Hiratsuka-shi, Kanagawa-ken, 259-1220 JAPAN

Telephone : +81 463 50 6400

Facsimile : +81 463 50 6401

Radiated Emission

Report No. 12656071S
 Test place Shonan EMC Lab.
 Semi Anechoic Chamber No.3 No.3 No.3 No.3
 Date January 24, 2019 February 24, 2019 February 25, 2019 February 25, 2019
 Temperature / Humidity 25 deg.C / 21 %RH 22 deg.C / 33 %RH 25 deg.C / 35 %RH 25 deg.C / 35 %RH
 Engineer Yosuke Ishikawa Kazutaka Takeyama Kazutaka Takeyama Kazutaka Takeyama
 (1 GHz - 2.8 GHz) (2.8 GHz - 13 GHz) (13 GHz - 18 GHz) (18 GHz - 26.5 GHz)
 Mode Tx, 2417 MHz
 Tx, OFDM VHT20 (MIMO)

(* PK: Peak, AV: Average, QP: Quasi-Peak)

Polarity	Frequency [MHz]	Detector	Reading [dBuV]	Ant.Fac. [dB/m]	Loss [dB]	Gain [dB]	Distance Factor [dB]	Result [dBuV/m]	Limit [dBuV/m]	Margin [dB]	Height [cm]	Angle [deg]	Remark
Hori.	2390.000	PK	49.75	27.86	14.67	34.78	2.26	59.76	73.90	14.1	100	248	
Hori.	4834.000	PK	48.94	31.33	6.52	39.50	2.26	49.55	73.90	24.3	134	229	
Hori.	7251.000	PK	47.13	36.82	7.77	39.32	2.26	54.66	73.90	19.2	291	272	
Hori.	9668.000	PK	46.77	38.28	8.92	39.48	2.26	56.75	73.90	17.1	157	133	
Hori.	2390.000	AV	35.59	27.86	14.67	34.78	2.26	45.60	53.90	8.3	100	248	
Hori.	4834.000	AV	38.95	31.33	6.52	39.50	2.26	39.56	53.90	14.3	134	229	
Hori.	7251.000	AV	37.34	36.82	7.77	39.32	2.26	44.87	53.90	9.0	291	272	
Hori.	9668.000	AV	36.31	38.28	8.92	39.48	2.26	46.29	53.90	7.6	157	133	
Vert.	2390.000	PK	43.93	27.86	14.67	34.78	2.26	53.94	73.90	19.9	119	47	
Vert.	4834.000	PK	49.79	31.33	6.52	39.50	2.26	50.40	73.90	23.5	109	25	
Vert.	7251.000	PK	46.78	36.82	7.77	39.32	2.26	54.31	73.90	19.5	129	298	
Vert.	9668.000	PK	46.46	38.28	8.92	39.48	2.26	56.44	73.90	17.4	145	186	
Vert.	2390.000	AV	34.29	27.86	14.67	34.78	2.26	44.30	53.90	9.6	119	47	
Vert.	4834.000	AV	40.32	31.33	6.52	39.50	2.26	40.93	53.90	12.9	109	25	
Vert.	7251.000	AV	36.32	36.82	7.77	39.32	2.26	43.85	53.90	10.0	129	298	
Vert.	9668.000	AV	36.31	38.28	8.92	39.48	2.26	46.29	53.90	7.6	145	186	

Result = Reading + Ant.Fac. + Loss (Cable+(Attenuator or Filter)(below 18 GHz)) - Gain(Amplifier) + Distance factor

Distance factor : 1 GHz - 13 GHz : 20log (3.89 m / 3.0 m) = 2.26 dB

13 GHz - 40 GHz : 20log (1.0 m / 3.0 m) = -9.54 dB

20 dBc Data Sheet (RBW 100 kHz, VBW 300 kHz)

Polarity	Frequency [MHz]	Detector	Reading [dBuV]	Ant.Fac. [dB/m]	Loss [dB]	Gain [dB]	Distance Factor [dB]	Result [dBuV/m]	Limit [dBuV/m]	Margin [dB]	Remark
Hori.	2417.000	PK	89.52	27.84	14.69	34.78	2.26	99.53	-	-	Carrier
Hori.	2400.000	PK	41.24	27.86	14.68	34.78	2.26	51.26	79.53	28.2	
Vert.	2417.000	PK	85.52	27.84	14.69	34.78	2.26	95.53	-	-	Carrier
Vert.	2400.000	PK	40.29	27.86	14.68	34.78	2.26	50.31	75.53	25.2	

Result = Reading + Ant.Fac. + Loss (Cable+(Attenuator or Filter)(below 18 GHz)) - Gain(Amplifier) + Distance factor

Distance factor : 1 GHz - 13 GHz : 20log (3.89 m / 3.0 m) = 2.26 dB

13 GHz - 40 GHz : 20log (1.0 m / 3.0 m) = -9.54 dB

UL Japan, Inc.**Shonan EMC Lab.**

1-22-3 Megumigaoka, Hiratsuka-shi, Kanagawa 259-1220 JAPAN

Telephone : +81 463 50 6400

Facsimile : +81 463 50 6401

Radiated Spurious Emission (Reference Plot for band-edge)

Test place	Shonan EMC Lab.
Semi Anechoic Chamber	No.3
Date	January 24, 2019
Temperature / Humidity	25 deg.C / 21 %RH
Engineer	Yosuke Ishikawa (1 GHz – 2.8 GHz)
Mode	Tx, OFDM VHT20 (MIMO) ,2417 MHz

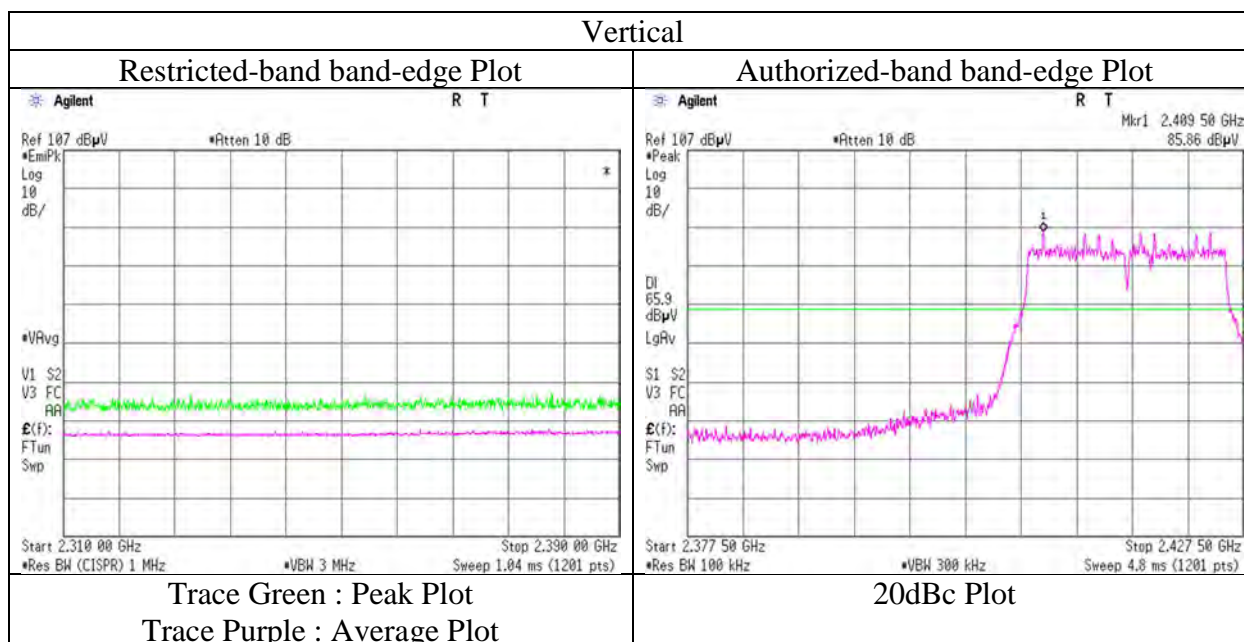
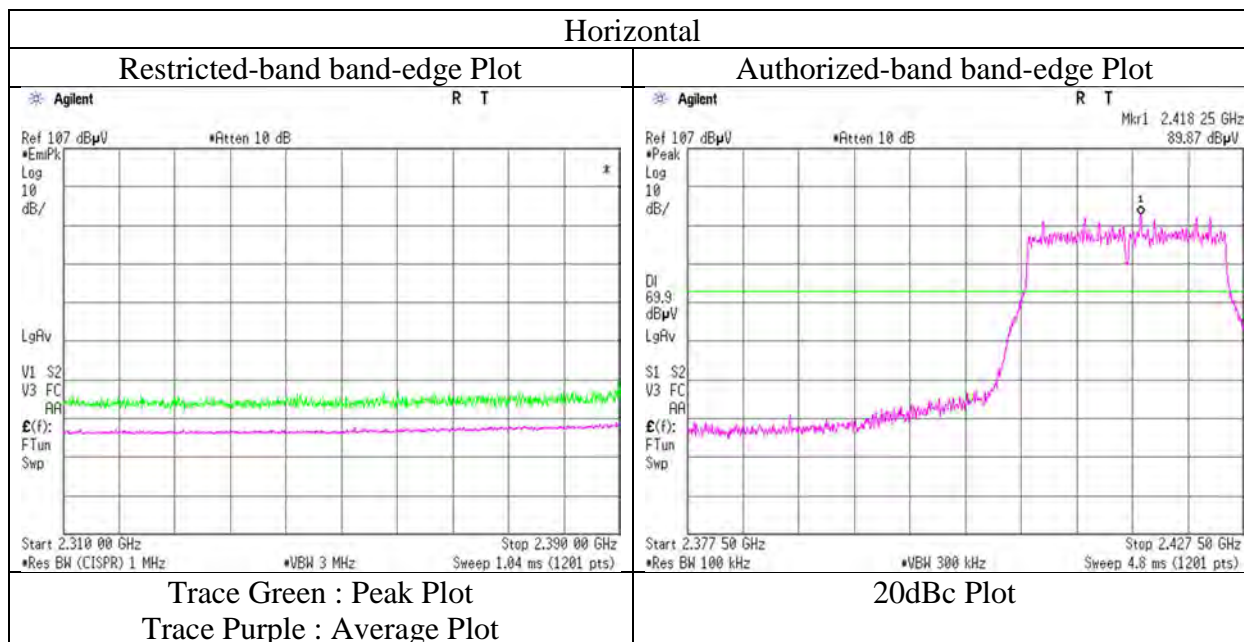

* The measurement was conducted for a sufficiently long enough time to detect any possible spurious emissions. Final result of restricted band edge was shown in tabular data.

UL Japan, Inc.

Shonan EMC Lab.

1-22-3 Megumigaoka, Hiratsuka-shi, Kanagawa-ken, 259-1220 JAPAN

Telephone : +81 463 50 6400

Facsimile : +81 463 50 6401

Radiated Emission

Report No. 12656071S
 Test place Shonan EMC Lab.
 Semi Anechoic Chamber No.3 No.3 No.3 No.3 No.3
 Date January 26, 2019 January 15, 2019 January 16, 2019 February 25, 2019 January 17, 2019
 Temperature / Humidity 22 deg.C / 31 %RH 20 deg.C / 35 %RH 22 deg.C / 44 %RH 25 deg.C / 35 %RH 21 deg.C / 35 %RH
 Engineer Kenichi Adachi Kazutaka Takeyama Makoto Hosaka Kazutaka Takeyama Makoto Hosaka
 (30 MHz - 1000 MHz) (1 GHz - 2.8 GHz) (2.8 GHz - 13 GHz) (13 GHz - 18 GHz) (18 GHz - 26.5 GHz)
 Mode Tx, 2437 MHz
 Tx, OFDM VHT20 (MIMO)

(* PK: Peak, AV: Average, QP: Quasi-Peak)

Polarity	Frequency [MHz]	Detector	Reading [dBuV]	Ant.Fac. [dB/m]	Loss [dB]	Gain [dB]	Distance Factor [dB]	Result [dBuV/m]	Limit [dBuV/m]	Margin [dB]	Height [cm]	Angle [deg]	Remark
Hori.	36.768	QP	34.24	16.09	6.58	32.20	0.00	24.71	40.00	15.2	400	59	
Hori.	92.841	QP	43.11	8.82	7.50	32.16	0.00	27.27	43.50	16.2	277	208	
Hori.	156.854	QP	28.16	14.97	7.86	32.11	0.00	18.88	43.50	24.6	197	258	
Hori.	250.012	QP	53.87	11.81	8.38	32.01	0.00	42.05	46.00	3.9	123	178	
Hori.	430.073	QP	43.78	16.33	9.37	31.97	0.00	37.51	46.00	8.4	100	43	
Hori.	651.256	QP	33.48	19.33	10.20	31.98	0.00	31.03	46.00	14.9	182	49	
Hori.	959.996	QP	33.43	22.22	11.27	30.57	0.00	36.35	46.00	9.6	100	209	
Hori.	4874.000	PK	41.82	31.40	7.21	34.05	2.26	48.64	73.90	25.2	100	278	
Hori.	7311.000	PK	41.56	36.99	9.08	33.82	2.26	56.07	73.90	17.8	134	244	
Hori.	9748.000	PK	42.04	38.92	10.45	34.12	2.26	59.55	73.90	14.3	166	233	
Hori.	4874.000	AV	31.42	31.40	7.21	34.05	2.26	38.24	53.90	15.6	100	278	
Hori.	7311.000	AV	31.08	36.99	9.08	33.82	2.26	45.59	53.90	8.3	134	244	
Hori.	9748.000	AV	30.65	38.92	10.45	34.12	2.26	48.16	53.90	5.7	166	233	
Vert.	38.234	QP	38.43	15.51	6.61	32.20	0.00	28.35	40.00	11.6	100	142	
Vert.	94.634	QP	40.96	9.16	7.47	32.16	0.00	25.43	43.50	18.0	100	103	
Vert.	158.726	QP	35.52	15.07	7.86	32.11	0.00	26.34	43.50	17.1	100	308	
Vert.	250.012	QP	41.28	11.81	8.38	32.01	0.00	29.46	46.00	16.5	100	6	
Vert.	430.073	QP	38.94	16.33	9.37	31.97	0.00	32.67	46.00	13.3	157	13	
Vert.	651.254	QP	36.49	19.33	10.20	31.98	0.00	34.04	46.00	11.9	100	237	
Vert.	724.982	QP	35.02	20.18	10.48	31.84	0.00	33.84	46.00	12.1	100	174	
Vert.	4874.000	PK	42.78	31.40	7.21	34.05	2.26	49.60	73.90	24.3	123	11	
Vert.	7311.000	PK	41.43	36.99	9.08	33.82	2.26	55.94	73.90	17.9	187	88	
Vert.	9748.000	PK	41.96	38.92	10.45	34.12	2.26	59.47	73.90	14.4	145	232	
Vert.	4874.000	AV	32.89	31.40	7.21	34.05	2.26	39.71	53.90	14.1	123	11	
Vert.	7311.000	AV	31.14	36.99	9.08	33.82	2.26	45.65	53.90	8.2	187	88	
Vert.	9748.000	AV	30.21	38.92	10.45	34.12	2.26	47.72	53.90	6.1	145	232	

Result = Reading + Ant.Fac. + Loss (Cable+(Attenuator or Filter)(below 18 GHz)) - Gain(Amplifier) + Distance factor

Distance factor : 1 GHz - 13 GHz : $20\log(3.89\text{ m} / 3.0\text{ m}) = 2.26\text{ dB}$

13 GHz - 40 GHz : $20\log(1.0\text{ m} / 3.0\text{ m}) = -9.54\text{ dB}$

UL Japan, Inc.

Shonan EMC Lab.

1-22-3 Megumigaoka, Hiratsuka-shi, Kanagawa 259-1220 JAPAN

Telephone : +81 463 50 6400

Facsimile : +81 463 50 6401

Radiated Emission

Report No. 12656071S
 Test place Shonan EMC Lab.
 Semi Anechoic Chamber No.3 No.3 No.3 No.3
 Date January 15, 2019 January 16, 2019 February 25, 2019 January 17, 2019
 Temperature / Humidity 20 deg.C / 35 %RH 22 deg.C / 44 %RH 25 deg.C / 35 %RH 21 deg.C / 35 %RH
 Engineer Kazutaka Takeyama Makoto Hosaka Kazutaka Takeyama Makoto Hosaka
 (1 GHz - 2.8 GHz) (2.8 GHz - 13 GHz) (13 GHz - 18 GHz) (18 GHz - 26.5 GHz)
 Mode Tx, 2462 MHz
 Tx, OFDM VHT20 (MIMO)

(* PK: Peak, AV: Average, QP: Quasi-Peak)

Polarity	Frequency [MHz]	Detector	Reading [dBuV]	Ant.Fac. [dB/m]	Loss [dB]	Gain [dB]	Distance Factor [dB]	Result [dBuV/m]	Limit [dBuV/m]	Margin [dB]	Height [cm]	Angle [deg]	Remark
Hori.	2483.500	PK	49.21	27.65	14.77	34.77	2.26	59.12	73.90	14.7	138	218	
Hori.	4924.000	PK	46.87	31.37	7.25	39.50	2.26	48.25	73.90	25.6	212	285	
Hori.	7386.000	PK	45.22	37.01	9.13	39.39	2.26	54.23	73.90	19.6	100	0	
Hori.	9848.000	PK	45.22	39.12	10.38	39.35	2.26	57.63	73.90	16.2	150	0	
Hori.	2483.500	AV	35.08	27.65	14.77	34.77	2.26	44.99	53.90	8.9	138	218	
Hori.	4924.000	AV	36.99	31.37	7.25	39.50	2.26	38.37	53.90	15.5	212	285	
Hori.	7386.000	AV	34.91	37.01	9.13	39.39	2.26	43.92	53.90	9.9	100	0	
Hori.	9848.000	AV	34.17	39.12	10.38	39.35	2.26	46.58	53.90	7.3	150	0	
Vert.	2483.500	PK	51.70	27.65	14.77	34.77	2.26	61.61	73.90	12.2	177	106	
Vert.	4924.000	PK	47.69	31.37	7.25	39.50	2.26	49.07	73.90	24.8	154	44	
Vert.	7386.000	PK	44.69	37.01	9.13	39.39	2.26	53.70	73.90	20.2	150	0	
Vert.	9848.000	PK	45.86	39.12	10.38	39.35	2.26	58.27	73.90	15.6	150	0	
Vert.	2483.500	AV	35.98	27.65	14.77	34.77	2.26	45.89	53.90	8.0	177	106	
Vert.	4924.000	AV	36.55	31.37	7.25	39.50	2.26	37.93	53.90	15.9	154	44	
Vert.	7386.000	AV	34.70	37.01	9.13	39.39	2.26	43.71	53.90	10.1	150	0	
Vert.	9848.000	AV	34.23	39.12	10.38	39.35	2.26	46.64	53.90	7.2	150	0	

Result = Reading + Ant.Fac. + Loss (Cable+(Attenuator or Filter)(below 18 GHz)) - Gain(Amplifier) + Distance factor

Distance factor : 1 GHz - 13 GHz : $20\log(3.89\text{ m} / 3.0\text{ m}) = 2.26\text{ dB}$

13 GHz - 40 GHz : $20\log(1.0\text{ m} / 3.0\text{ m}) = -9.54\text{ dB}$

UL Japan, Inc.

Shonan EMC Lab.

1-22-3 Megumigaoka, Hiratsuka-shi, Kanagawa 259-1220 JAPAN

Telephone : +81 463 50 6400

Facsimile : +81 463 50 6401

Radiated Spurious Emission
(Reference Plot for band-edge)

Test place	Shonan EMC Lab.
Semi Anechoic Chamber	No.3
Date	January 15, 2019
Temperature / Humidity	20 deg.C / 35 %RH
Engineer	Kazutaka Takeyama
	(1 GHz – 2.8 GHz)
Mode	Tx, OFDM VHT20 (MIMO) ,2462 MHz

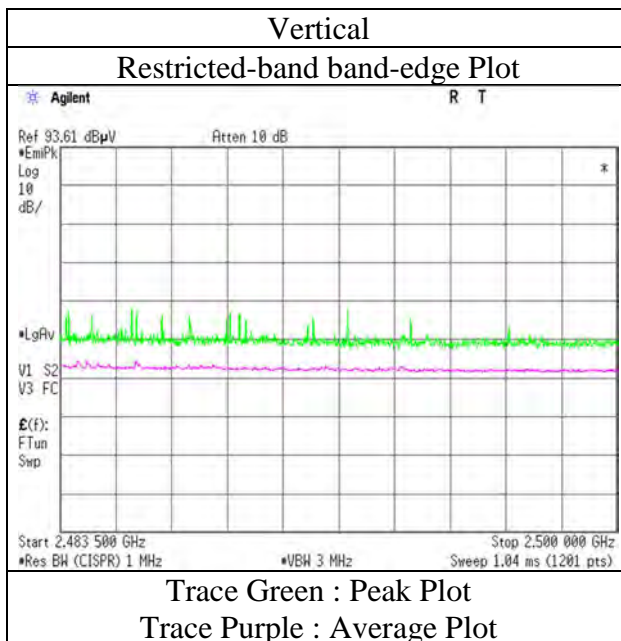
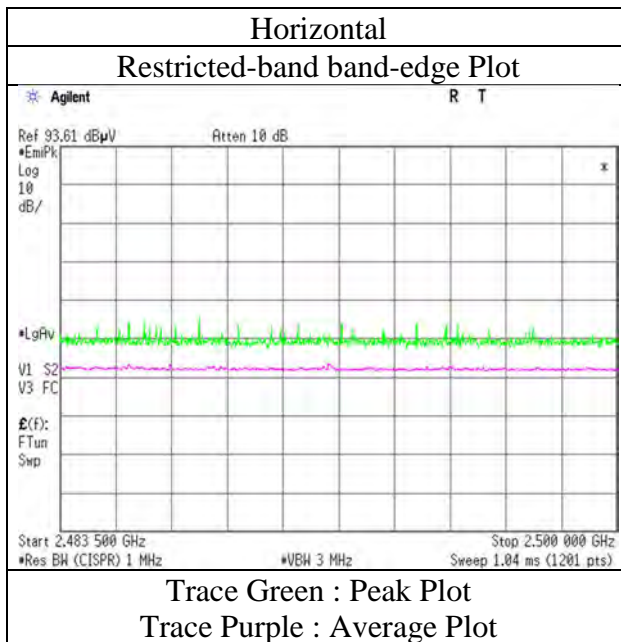

* The measurement was conducted for a sufficiently long enough time to detect any possible spurious emissions. Final result of restricted band edge was shown in tabular data.

Radiated Emission

Report No. 12656071S
 Test place Shonan EMC Lab.
 Semi Anechoic Chamber No.3 No.3 No.3 No.3
 Date January 15, 2019 January 16, 2019 February 25, 2019 January 17, 2019
 Temperature / Humidity 20 deg.C / 35 %RH 22 deg.C / 44 %RH 25 deg.C / 35 %RH 21 deg.C / 35 %RH
 Engineer Kazutaka Takeyama Makoto Hosaka Kazutaka Takeyama Makoto Hosaka
 (1 GHz - 2.8 GHz) (2.8 GHz - 13 GHz) (13 GHz - 18 GHz) (18 GHz - 26.5 GHz)
 Mode Tx, 2467 MHz
 Tx, OFDM VHT20 (MIMO)

(* PK: Peak, AV: Average, QP: Quasi-Peak)

Polarity	Frequency [MHz]	Detector	Reading [dBuV]	Ant.Fac. [dB/m]	Loss [dB]	Gain [dB]	Distance Factor [dB]	Result [dBuV/m]	Limit [dBuV/m]	Margin [dB]	Height [cm]	Angle [deg]	Remark
Hori.	2483.500	PK	45.13	27.65	14.77	34.77	2.26	55.04	73.90	18.8	100	258	
Hori.	4934.000	PK	45.21	31.41	7.26	39.50	2.26	46.64	73.90	27.2	256	334	
Hori.	7401.000	PK	45.86	36.99	9.13	39.40	2.26	54.84	73.90	19.0	150	0	
Hori.	9868.000	PK	45.10	39.07	10.38	39.34	2.26	57.47	73.90	16.4	150	0	
Hori.	2483.500	AV	34.47	27.65	14.77	34.77	2.26	44.38	53.90	9.5	100	258	
Hori.	4934.000	AV	35.37	31.41	7.26	39.50	2.26	36.80	53.90	17.1	256	334	
Hori.	7401.000	AV	35.13	36.99	9.13	39.40	2.26	44.11	53.90	9.7	150	0	
Hori.	9868.000	AV	34.42	39.07	10.38	39.34	2.26	46.79	53.90	7.1	150	0	
Vert.	2483.500	PK	45.07	27.65	14.77	34.77	2.26	54.98	73.90	18.9	176	105	
Vert.	4934.000	PK	45.74	31.41	7.26	39.50	2.26	47.17	73.90	26.7	202	38	
Vert.	7401.000	PK	46.17	36.99	9.13	39.40	2.26	55.15	73.90	18.7	150	0	
Vert.	9868.000	PK	44.77	39.07	10.38	39.34	2.26	57.14	73.90	16.7	150	0	
Vert.	2483.500	AV	34.48	27.65	14.77	34.77	2.26	44.39	53.90	9.5	176	105	
Vert.	4934.000	AV	35.52	31.41	7.26	39.50	2.26	36.95	53.90	16.9	202	38	
Vert.	7401.000	AV	35.19	36.99	9.13	39.40	2.26	44.17	53.90	9.7	150	0	
Vert.	9868.000	AV	34.32	39.07	10.38	39.34	2.26	46.69	53.90	7.2	150	0	

Result = Reading + Ant.Fac. + Loss (Cable+(Attenuator or Filter)(below 18 GHz)) - Gain(Amplifier) + Distance factor

Distance factor : 1 GHz - 13 GHz : $20\log(3.89\text{ m} / 3.0\text{ m}) = 2.26\text{ dB}$

13 GHz - 40 GHz : $20\log(1.0\text{ m} / 3.0\text{ m}) = -9.54\text{ dB}$

UL Japan, Inc.

Shonan EMC Lab.

1-22-3 Megumigaoka, Hiratsuka-shi, Kanagawa 259-1220 JAPAN

Telephone : +81 463 50 6400

Facsimile : +81 463 50 6401

Radiated Spurious Emission (Reference Plot for band-edge)

Test place Shonan EMC Lab.
Semi Anechoic Chamber No.3
Date January 15, 2019
Temperature / Humidity 20 deg.C / 35 %RH
Engineer Kazutaka Takeyama
 (1 GHz – 2.8 GHz)
Mode Tx, OFDM VHT20 (MIMO), 2467 MHz

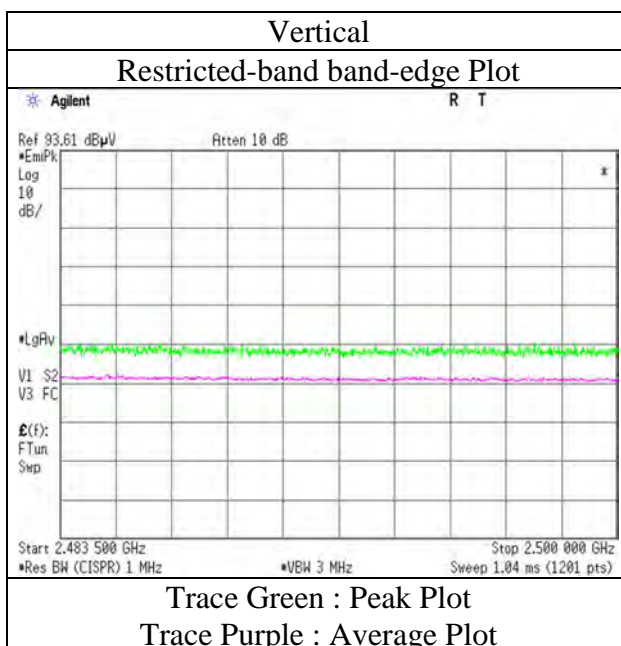
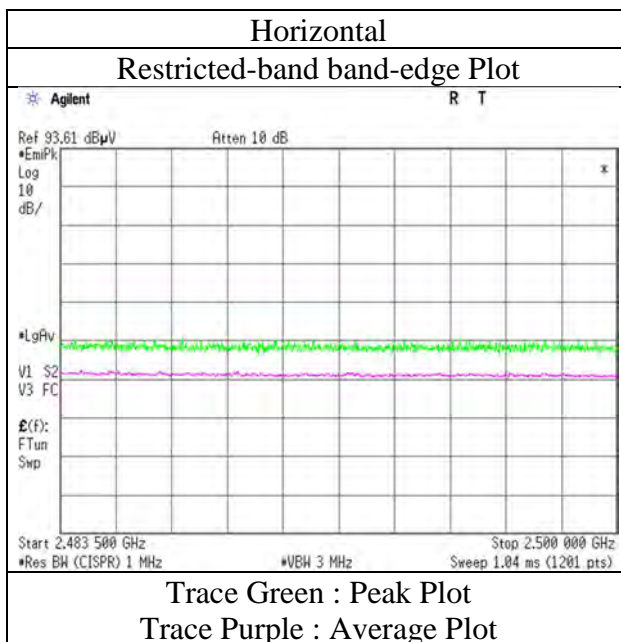

* The measurement was conducted for a sufficiently long enough time to detect any possible spurious emissions. Final result of restricted band edge was shown in tabular data.

Radiated Emission

Report No. 12656071S
 Test place Shonan EMC Lab.
 Semi Anechoic Chamber No.3 No.3 No.3 No.3
 Date January 15, 2019 January 16, 2019 February 25, 2019 January 17, 2019
 Temperature / Humidity 20 deg.C / 35 %RH 22 deg.C / 44 %RH 25 deg.C / 35 %RH 21 deg.C / 35 %RH
 Engineer Kazutaka Takeyama Makoto Hosaka Kazutaka Takeyama Makoto Hosaka
 (1 GHz - 2.8 GHz) (2.8 GHz - 13 GHz) (13 GHz - 18 GHz) (18 GHz - 26.5 GHz)
 Mode Tx, 2472 MHz
 Tx, OFDM VHT20 (MIMO)

(* PK: Peak, AV: Average, QP: Quasi-Peak)

Polarity	Frequency [MHz]	Detector	Reading [dBuV]	Ant.Fac. [dB/m]	Loss [dB]	Gain [dB]	Distance Factor [dB]	Result [dBuV/m]	Limit [dBuV/m]	Margin [dB]	Height [cm]	Angle [deg]	Remark
Hori.	2483.500	PK	45.07	27.65	14.77	34.77	2.26	54.98	73.90	18.9	134	217	
Hori.	4944.000	PK	45.48	31.44	7.27	39.50	2.26	46.95	73.90	26.9	249	254	
Hori.	7416.000	PK	45.14	37.03	9.14	39.40	2.26	54.17	73.90	19.7	150	0	
Hori.	9888.000	PK	45.83	39.00	10.38	39.32	2.26	58.15	73.90	15.7	150	0	
Hori.	2483.500	AV	34.61	27.65	14.77	34.77	2.26	44.52	53.90	9.3	134	217	
Hori.	4944.000	AV	35.09	31.44	7.27	39.50	2.26	36.56	53.90	17.3	249	254	
Hori.	7416.000	AV	34.95	37.03	9.14	39.40	2.26	43.98	53.90	9.9	150	0	
Hori.	9888.000	AV	34.42	39.00	10.38	39.32	2.26	46.74	53.90	7.1	150	0	
Vert.	2483.500	PK	45.09	27.65	14.77	34.77	2.26	55.00	73.90	18.9	179	104	
Vert.	4944.000	PK	45.39	31.44	7.27	39.50	2.26	46.86	73.90	27.0	108	276	
Vert.	7416.000	PK	45.96	37.03	9.14	39.40	2.26	54.99	73.90	18.9	150	0	
Vert.	9888.000	PK	44.95	39.00	10.38	39.32	2.26	57.27	73.90	16.6	150	0	
Vert.	2483.500	AV	34.48	27.65	14.77	34.77	2.26	44.39	53.90	9.5	179	104	
Vert.	4944.000	AV	35.55	31.44	7.27	39.50	2.26	37.02	53.90	16.8	108	276	
Vert.	7416.000	AV	35.25	37.03	9.14	39.40	2.26	44.28	53.90	9.6	150	0	
Vert.	9888.000	AV	34.33	39.00	10.38	39.32	2.26	46.65	53.90	7.2	150	0	

Result = Reading + Ant.Fac. + Loss (Cable+(Attenuator or Filter)(below 18 GHz)) - Gain(Amplifier) + Distance factor

Distance factor : 1 GHz - 13 GHz : $20\log(3.89\text{ m} / 3.0\text{ m}) = 2.26\text{ dB}$

13 GHz - 40 GHz : $20\log(1.0\text{ m} / 3.0\text{ m}) = -9.54\text{ dB}$

UL Japan, Inc.

Shonan EMC Lab.

1-22-3 Megumigaoka, Hiratsuka-shi, Kanagawa 259-1220 JAPAN

Telephone : +81 463 50 6400

Facsimile : +81 463 50 6401

Radiated Spurious Emission (Reference Plot for band-edge)

Test place	Shonan EMC Lab.
Semi Anechoic Chamber	No.3
Date	January 15, 2019
Temperature / Humidity	20 deg.C / 35 %RH
Engineer	Kazutaka Takeyama
	(1 GHz – 2.8 GHz)
Mode	Tx, OFDM VHT20 (MIMO) ,2472 MHz

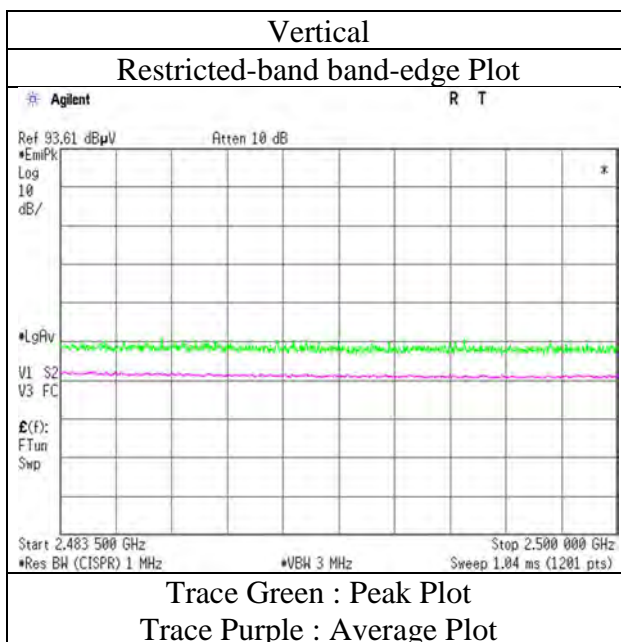
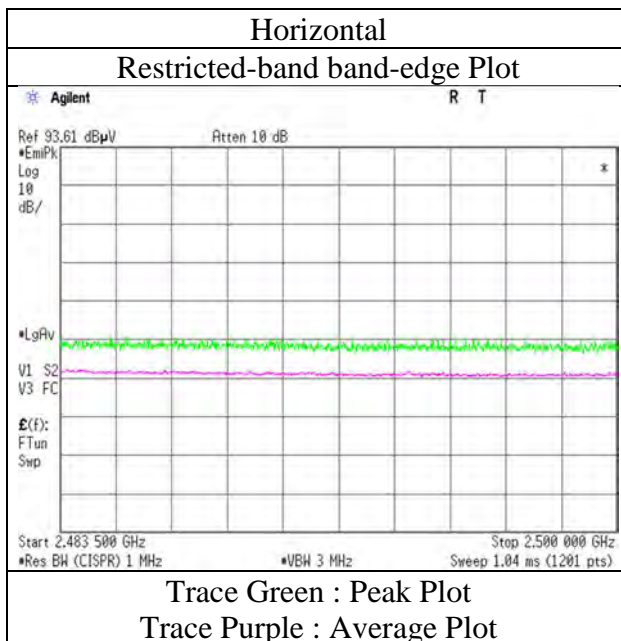

* The measurement was conducted for a sufficiently long enough time to detect any possible spurious emissions. Final result of restricted band edge was shown in tabular data.

UL Japan, Inc.

Shonan EMC Lab.

1-22-3 Megumigaoka, Hiratsuka-shi, Kanagawa-ken, 259-1220 JAPAN

Telephone : +81 463 50 6400

Facsimile : +81 463 50 6401

Radiated Emission

Report No. 12656071S
 Test place Shonan EMC Lab.
 Semi Anechoic Chamber No.3 No.3 No.3 No.3
 Date January 15, 2019 January 18, 2019 February 25, 2019 January 17, 2019
 Temperature / Humidity 22 deg.C / 36 %RH 22 deg.C / 34 %RH 25 deg.C / 35 %RH 21 deg.C / 35 %RH
 Engineer Makoto Hosaka Makoto Hosaka Kazutaka Takeyama Makoto Hosaka
 (1 GHz - 2.8 GHz) (2.8 GHz - 13 GHz) (13 GHz - 18 GHz) (18 GHz - 26.5 GHz)
 Mode Tx, 2422 MHz
 Tx, IEEE802.11n HT40 (SISO)

(* PK: Peak, AV: Average, QP: Quasi-Peak)

Polarity	Frequency [MHz]	Detector	Reading [dBuV]	Ant.Fac. [dB/m]	Loss [dB]	Gain [dB]	Distance Factor [dB]	Result [dBuV/m]	Limit [dBuV/m]	Margin [dB]	Height [cm]	Angle [deg]	Remark
Hori.	2390.000	PK	45.68	27.86	14.67	34.78	2.26	55.69	73.90	18.2	215	45	
Hori.	4844.000	PK	46.09	31.49	7.20	39.50	2.26	47.54	73.90	26.3	172	231	
Hori.	7266.000	PK	44.37	36.91	9.06	39.32	2.26	53.28	73.90	20.6	150	0	
Hori.	9688.000	PK	45.02	38.79	10.48	39.46	2.26	57.09	73.90	16.8	150	0	
Hori.	2390.000	AV	35.87	27.86	14.67	34.78	2.26	45.88	53.90	8.0	215	45	
Hori.	4844.000	AV	36.14	31.49	7.20	39.50	2.26	37.59	53.90	16.3	172	231	
Hori.	7266.000	AV	35.09	36.91	9.06	39.32	2.26	44.00	53.90	9.9	150	0	
Hori.	9688.000	AV	36.02	38.79	10.48	39.46	2.26	48.09	53.90	5.8	150	0	
Vert.	2390.000	PK	45.10	27.86	14.67	34.78	2.26	55.11	73.90	18.7	152	257	
Vert.	4844.000	PK	45.08	31.49	7.20	39.50	2.26	46.53	73.90	27.3	104	23	
Vert.	7266.000	PK	44.51	36.91	9.06	39.32	2.26	53.42	73.90	20.4	150	0	
Vert.	9688.000	PK	45.11	38.79	10.48	39.46	2.26	57.18	73.90	16.7	150	0	
Vert.	2390.000	AV	35.79	27.86	14.67	34.78	2.26	45.80	53.90	8.1	152	257	
Vert.	4844.000	AV	35.74	31.49	7.20	39.50	2.26	37.19	53.90	16.7	104	23	
Vert.	7266.000	AV	35.23	36.91	9.06	39.32	2.26	44.14	53.90	9.7	150	0	
Vert.	9688.000	AV	35.98	38.79	10.48	39.46	2.26	48.05	53.90	5.8	150	0	

Result = Reading + Ant.Fac. + Loss (Cable+(Attenuator or Filter)(below 18 GHz)) - Gain(Amplifier) + Distance factor

Distance factor : 1 GHz - 13 GHz : 20log (3.89 m / 3.0 m) = 2.26 dB

13 GHz - 40 GHz : 20log (1.0 m / 3.0 m) = -9.54 dB

20 dBc Data Sheet (RBW 100 kHz, VBW 300 kHz)

Polarity	Frequency [MHz]	Detector	Reading [dBuV]	Ant.Fac. [dB/m]	Loss [dB]	Gain [dB]	Distance Factor [dB]	Result [dBuV/m]	Limit [dBuV/m]	Margin [dB]	Remark
Hori.	2422.000	PK	78.19	27.83	14.70	34.78	2.26	88.20	-	-	Carrier
Hori.	2400.000	PK	37.42	27.86	14.68	34.78	2.26	47.44	68.20	20.7	
Vert.	2422.000	PK	77.32	27.83	14.70	34.78	2.26	87.33	-	-	Carrier
Vert.	2400.000	PK	35.81	27.86	14.68	34.78	2.26	45.83	67.33	21.5	

Result = Reading + Ant.Fac. + Loss (Cable+(Attenuator or Filter)(below 18 GHz)) - Gain(Amplifier) + Distance factor

Distance factor : 1 GHz - 13 GHz : 20log (3.89 m / 3.0 m) = 2.26 dB

13 GHz - 40 GHz : 20log (1.0 m / 3.0 m) = -9.54 dB

UL Japan, Inc.

Shonan EMC Lab.

1-22-3 Megumigaoka, Hiratsuka-shi, Kanagawa 259-1220 JAPAN

Telephone : +81 463 50 6400

Facsimile : +81 463 50 6401

Radiated Spurious Emission (Reference Plot for band-edge)

Test place	Shonan EMC Lab.
Semi Anechoic Chamber	No.3
Date	January 15, 2019
Temperature / Humidity	22 deg.C / 36 %RH
Engineer	Makoto Hosaka
	(1 GHz – 2.8 GHz)
Mode	Tx, IEEE802.11n HT40 (SISO) , 2422 MHz

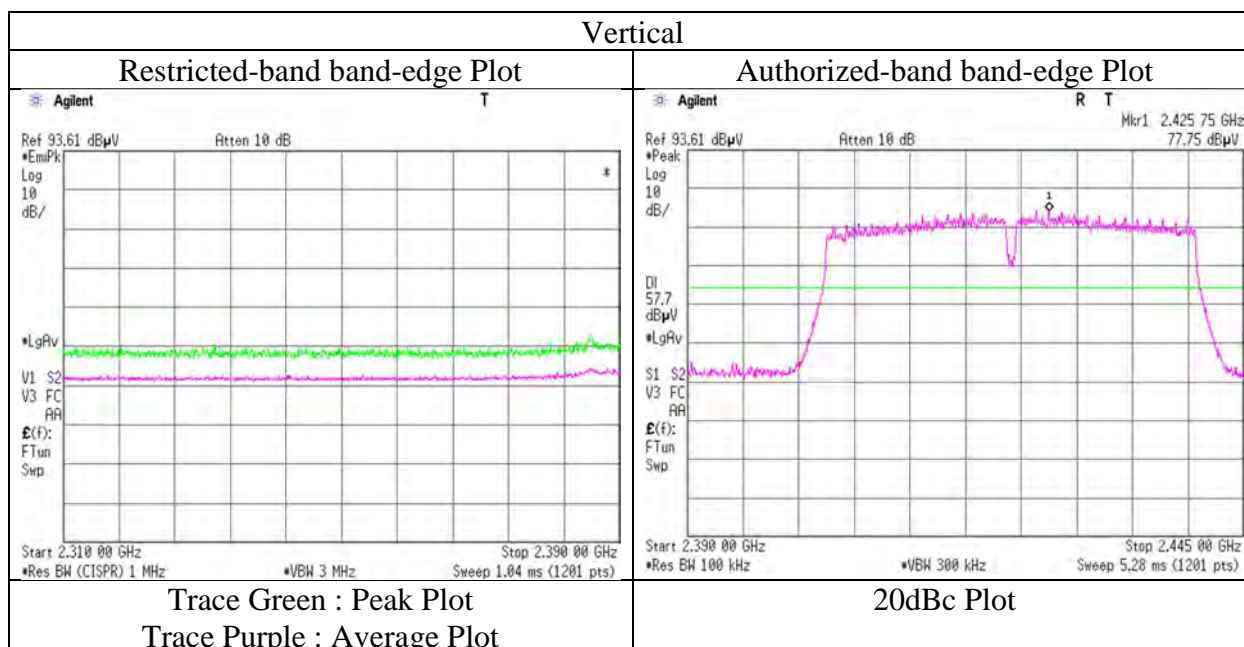
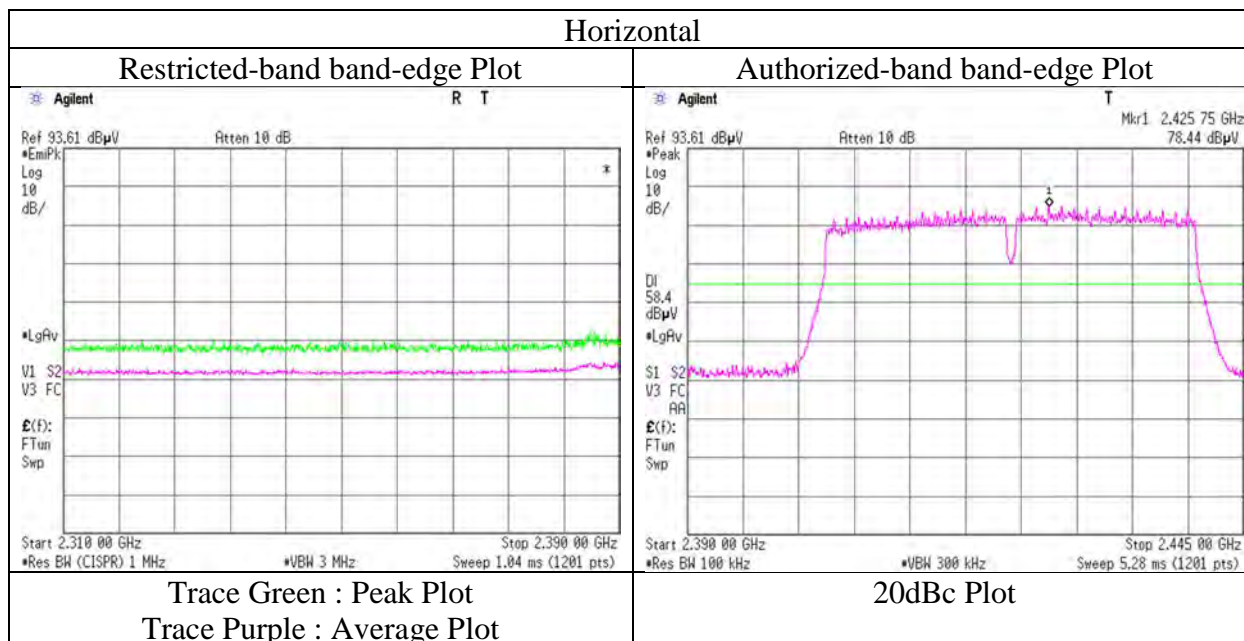

* The measurement was conducted for a sufficiently long enough time to detect any possible spurious emissions. Final result of restricted band edge was shown in tabular data.

Radiated Emission

Report No. 12656071S
 Test place Shonan EMC Lab.
 Semi Anechoic Chamber No.3 No.3 No.3 No.3
 Date January 15, 2019 January 18, 2019 February 25, 2019 January 17, 2019
 Temperature / Humidity 22 deg.C / 36 %RH 22 deg.C / 34 %RH 25 deg.C / 35 %RH 21 deg.C / 35 %RH
 Engineer Makoto Hosaka Makoto Hosaka Kazutaka Takeyama Makoto Hosaka
 (1 GHz - 2.8 GHz) (2.8 GHz - 13 GHz) (13 GHz - 18 GHz) (18 GHz - 26.5 GHz)
 Mode Tx, 2437 MHz
 Tx, IEEE802.11n HT40 (SISO)

(* PK: Peak, AV: Average, QP: Quasi-Peak)

Polarity	Frequency [MHz]	Detector	Reading [dBuV]	Ant.Fac. [dB/m]	Loss [dB]	Gain [dB]	Distance Factor [dB]	Result [dBuV/m]	Limit [dBuV/m]	Margin [dB]	Height [cm]	Angle [deg]	Remark
Hori.	4874.000	PK	45.08	31.40	7.21	39.50	2.26	46.45	73.90	27.4	153	274	
Hori.	7311.000	PK	43.10	36.99	9.08	39.35	2.26	52.08	73.90	21.8	150	0	
Hori.	9748.000	PK	44.37	38.92	10.45	39.42	2.26	56.58	73.90	17.3	150	0	
Hori.	4874.000	AV	35.56	31.40	7.21	39.50	2.26	36.93	53.90	16.9	153	274	
Hori.	7311.000	AV	34.15	36.99	9.08	39.35	2.26	43.13	53.90	10.7	150	0	
Hori.	9748.000	AV	34.50	38.92	10.45	39.42	2.26	46.71	53.90	7.1	150	0	
Vert.	4874.000	PK	45.21	31.40	7.21	39.50	2.26	46.58	73.90	27.3	105	30	
Vert.	7311.000	PK	43.88	36.99	9.08	39.35	2.26	52.86	73.90	21.0	150	0	
Vert.	9748.000	PK	44.32	38.92	10.45	39.42	2.26	56.53	73.90	17.3	150	0	
Vert.	4874.000	AV	34.92	31.40	7.21	39.50	2.26	36.29	53.90	17.6	105	30	
Vert.	7311.000	AV	34.44	36.99	9.08	39.35	2.26	43.42	53.90	10.4	150	0	
Vert.	9748.000	AV	34.73	38.92	10.45	39.42	2.26	46.94	53.90	6.9	150	0	

Result = Reading + Ant.Fac. + Loss (Cable+(Attenuator or Filter)(below 18 GHz)) - Gain(Amplifier) + Distance factor

Distance factor : 1 GHz - 13 GHz : $20\log(3.89\text{ m} / 3.0\text{ m}) = 2.26\text{ dB}$

13 GHz - 40 GHz : $20\log(1.0\text{ m} / 3.0\text{ m}) = -9.54\text{ dB}$

UL Japan, Inc.

Shonan EMC Lab.

1-22-3 Megumigaoka, Hiratsuka-shi, Kanagawa 259-1220 JAPAN

Telephone : +81 463 50 6400

Facsimile : +81 463 50 6401

Radiated Emission

Report No. 12656071S
 Test place Shonan EMC Lab.
 Semi Anechoic Chamber No.3 No.3 No.3 No.3
 Date January 15, 2019 January 18, 2019 February 25, 2019 January 17, 2019
 Temperature / Humidity 22 deg.C / 36 %RH 22 deg.C / 34 %RH 25 deg.C / 35 %RH 21 deg.C / 35 %RH
 Engineer Makoto Hosaka Makoto Hosaka Kazutaka Takeyama Makoto Hosaka
 (1 GHz -2.8 GHz) (2.8 GHz - 13 GHz) (13 GHz - 18 GHz) (18 GHz - 26.5 GHz)
 Mode Tx, 2452 MHz
 Tx, IEEE802.11n HT40 (SISO)

(* PK: Peak, AV: Average, QP: Quasi-Peak)

Polarity	Frequency [MHz]	Detector	Reading [dBuV]	Ant.Fac. [dB/m]	Loss [dB]	Gain [dB]	Distance Factor [dB]	Result [dBuV/m]	Limit [dBuV/m]	Margin [dB]	Height [cm]	Angle [deg]	Remark
Hori.	2483.500	PK	45.14	27.65	14.77	34.77	2.26	55.05	73.90	18.8	285	52	
Hori.	4904.000	PK	44.92	31.30	7.24	39.50	2.26	46.22	73.90	27.6	162	283	
Hori.	7356.000	PK	43.96	37.04	9.10	39.37	2.26	52.99	73.90	20.9	150	0	
Hori.	9808.000	PK	44.87	38.95	10.42	39.38	2.26	57.12	73.90	16.7	150	0	
Hori.	2483.500	AV	35.17	27.65	14.77	34.77	2.26	45.08	53.90	8.8	285	52	
Hori.	4904.000	AV	35.08	31.30	7.24	39.50	2.26	36.38	53.90	17.5	162	283	
Hori.	7356.000	AV	34.66	37.04	9.10	39.37	2.26	43.69	53.90	10.2	150	0	
Hori.	9808.000	AV	35.41	38.95	10.42	39.38	2.26	47.66	53.90	6.2	150	0	
Vert.	2483.500	PK	44.46	27.65	14.77	34.77	2.26	54.37	73.90	19.5	137	128	
Vert.	4904.000	PK	44.78	31.30	7.24	39.50	2.26	46.08	73.90	27.8	104	41	
Vert.	7356.000	PK	43.53	37.04	9.10	39.37	2.26	52.56	73.90	21.3	150	0	
Vert.	9808.000	PK	44.22	38.95	10.42	39.38	2.26	56.47	73.90	17.4	150	0	
Vert.	2483.500	AV	35.23	27.65	14.77	34.77	2.26	45.14	53.90	8.7	137	128	
Vert.	4904.000	AV	35.43	31.30	7.24	39.50	2.26	36.73	53.90	17.1	104	41	
Vert.	7356.000	AV	34.36	37.04	9.10	39.37	2.26	43.39	53.90	10.5	150	0	
Vert.	9808.000	AV	35.50	38.95	10.42	39.38	2.26	47.75	53.90	6.1	150	0	

Result = Reading + Ant.Fac. + Loss (Cable+(Attenuator or Filter)(below 18 GHz)) - Gain(Amplifier) + Distance factor

Distance factor : 1 GHz - 13 GHz : $20\log(3.89\text{ m} / 3.0\text{ m}) = 2.26\text{ dB}$

13 GHz - 40 GHz : $20\log(1.0\text{ m} / 3.0\text{ m}) = -9.54\text{ dB}$

UL Japan, Inc.

Shonan EMC Lab.

1-22-3 Megumigaoka, Hiratsuka-shi, Kanagawa 259-1220 JAPAN

Telephone : +81 463 50 6400

Facsimile : +81 463 50 6401

Radiated Spurious Emission (Reference Plot for band-edge)

Test place	Shonan EMC Lab.
Semi Anechoic Chamber	No.3
Date	January 15, 2019
Temperature / Humidity	22 deg.C / 36 %RH
Engineer	Makoto Hosaka
	(1 GHz – 2.8 GHz)
Mode	Tx, IEEE802.11n HT40 (SISO) , 2452 MHz

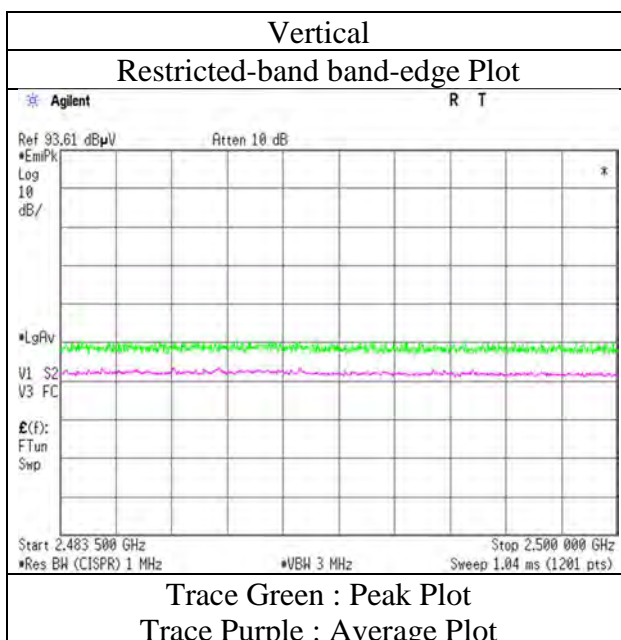
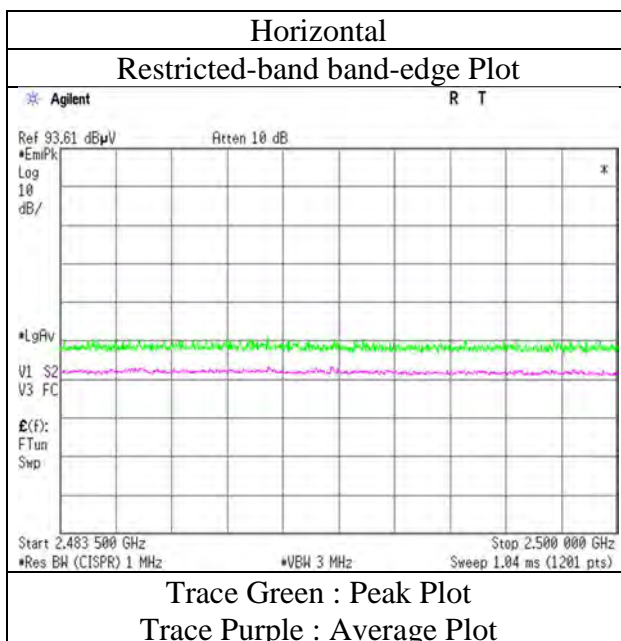

* The measurement was conducted for a sufficiently long enough time to detect any possible spurious emissions. Final result of restricted band edge was shown in tabular data.

Radiated Emission

Report No. 12656071S
 Test place Shonan EMC Lab.
 Semi Anechoic Chamber No.3 No.3 No.3 No.3
 Date January 15, 2019 January 18, 2019 February 25, 2019 January 17, 2019
 Temperature / Humidity 22 deg.C / 36 %RH 22 deg.C / 34 %RH 25 deg.C / 35 %RH 21 deg.C / 35 %RH
 Engineer Makoto Hosaka Makoto Hosaka Kazutaka Takeyama Makoto Hosaka
 (1 GHz - 2.8 GHz) (2.8 GHz - 13 GHz) (13 GHz - 18 GHz) (18 GHz - 26.5 GHz)
 Mode Tx, 2457 MHz
 Tx, IEEE802.11n HT40 (SISO)

(* PK: Peak, AV: Average, QP: Quasi-Peak)

Polarity	Frequency [MHz]	Detector	Reading [dBuV]	Ant.Fac. [dB/m]	Loss [dB]	Gain [dB]	Distance Factor [dB]	Result [dBuV/m]	Limit [dBuV/m]	Margin [dB]	Height [cm]	Angle [deg]	Remark
Hori.	2483.500	PK	46.19	27.65	14.77	34.77	2.26	56.10	73.90	17.8	327	51	
Hori.	4914.000	PK	44.74	31.34	7.24	39.50	2.26	46.08	73.90	27.8	153	332	
Hori.	7371.000	PK	44.70	37.02	9.10	39.38	2.26	53.70	73.90	20.2	150	0	
Hori.	9828.000	PK	45.09	39.04	10.40	39.36	2.26	57.43	73.90	16.4	150	0	
Hori.	2483.500	AV	35.77	27.65	14.77	34.77	2.26	45.68	53.90	8.2	327	51	
Hori.	4914.000	AV	35.86	31.34	7.24	39.50	2.26	37.20	53.90	16.7	153	332	
Hori.	7371.000	AV	34.59	37.02	9.10	39.38	2.26	43.59	53.90	10.3	150	0	
Hori.	9828.000	AV	35.23	39.04	10.40	39.36	2.26	47.57	53.90	6.3	150	0	
Vert.	2483.500	PK	45.06	27.65	14.77	34.77	2.26	54.97	73.90	18.9	150	262	
Vert.	4914.000	PK	44.96	31.34	7.24	39.50	2.26	46.30	73.90	27.6	104	10	
Vert.	7371.000	PK	43.51	37.02	9.10	39.38	2.26	52.51	73.90	21.3	150	0	
Vert.	9828.000	PK	44.34	39.04	10.40	39.36	2.26	56.68	73.90	17.2	150	0	
Vert.	2483.500	AV	35.23	27.65	14.77	34.77	2.26	45.14	53.90	8.7	150	262	
Vert.	4914.000	AV	35.52	31.34	7.24	39.50	2.26	36.86	53.90	17.0	104	10	
Vert.	7371.000	AV	34.46	37.02	9.10	39.38	2.26	43.46	53.90	10.4	150	0	
Vert.	9828.000	AV	35.02	39.04	10.40	39.36	2.26	47.36	53.90	6.5	150	0	

Result = Reading + Ant.Fac. + Loss (Cable+(Attenuator or Filter)(below 18 GHz)) - Gain(Amplifier) + Distance factor

Distance factor : 1 GHz - 13 GHz : $20\log(3.89\text{ m} / 3.0\text{ m}) = 2.26\text{ dB}$

13 GHz - 40 GHz : $20\log(1.0\text{ m} / 3.0\text{ m}) = -9.54\text{ dB}$

UL Japan, Inc.

Shonan EMC Lab.

1-22-3 Megumigaoka, Hiratsuka-shi, Kanagawa 259-1220 JAPAN

Telephone : +81 463 50 6400

Facsimile : +81 463 50 6401

Radiated Spurious Emission (Reference Plot for band-edge)

Test place	Shonan EMC Lab.
Semi Anechoic Chamber	No.3
Date	January 15, 2019
Temperature / Humidity	22 deg.C / 36 %RH
Engineer	Makoto Hosaka
	(1 GHz – 2.8 GHz)
Mode	Tx, IEEE802.11n HT40 (SISO) , 2457 MHz

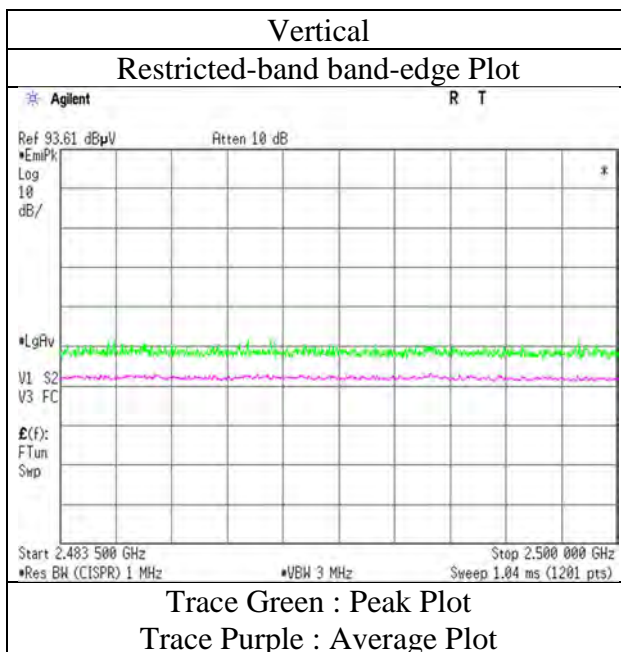
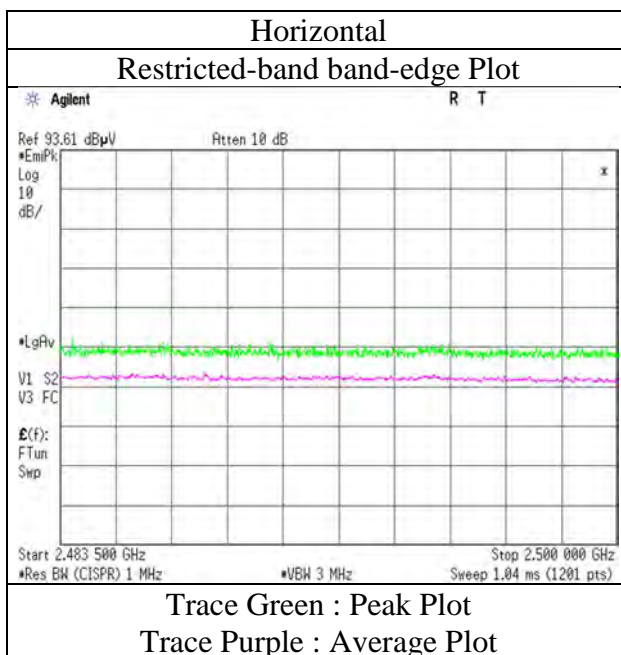

* The measurement was conducted for a sufficiently long enough time to detect any possible spurious emissions. Final result of restricted band edge was shown in tabular data.

Radiated Emission

Report No. 12656071S
 Test place Shonan EMC Lab.
 Semi Anechoic Chamber No.3 No.3 No.3 No.3
 Date January 15, 2019 January 18, 2019 February 25, 2019 January 17, 2019
 Temperature / Humidity 22 deg.C / 36 %RH 22 deg.C / 34 %RH 25 deg.C / 35 %RH 21 deg.C / 35 %RH
 Engineer Makoto Hosaka Makoto Hosaka Kazutaka Takeyama Makoto Hosaka
 (1 GHz - 2.8 GHz) (2.8 GHz - 13 GHz) (13 GHz - 18 GHz) (18 GHz - 26.5 GHz)
 Mode Tx, 2462 MHz
 Tx, IEEE802.11n HT40 (SISO)

(* PK: Peak, AV: Average, QP: Quasi-Peak)

Polarity	Frequency [MHz]	Detector	Reading [dBuV]	Ant.Fac. [dB/m]	Loss [dB]	Gain [dB]	Distance Factor [dB]	Result [dBuV/m]	Limit [dBuV/m]	Margin [dB]	Height [cm]	Angle [deg]	Remark
Hori.	2483.500	PK	47.42	27.65	14.77	34.77	2.26	57.33	73.90	16.5	265	213	
Hori.	4924.000	PK	45.73	31.37	7.25	39.50	2.26	47.11	73.90	26.7	176	289	
Hori.	7386.000	PK	44.03	37.01	9.13	39.39	2.26	53.04	73.90	20.8	150	0	
Hori.	9848.000	PK	44.69	39.12	10.38	39.35	2.26	57.10	73.90	16.8	150	0	
Hori.	2483.500	AV	36.84	27.65	14.77	34.77	2.26	46.75	53.90	7.1	265	213	
Hori.	4924.000	AV	35.60	31.37	7.25	39.50	2.26	36.98	53.90	16.9	176	289	
Hori.	7386.000	AV	34.72	37.01	9.13	39.39	2.26	43.73	53.90	10.1	150	0	
Hori.	9848.000	AV	35.48	39.12	10.38	39.35	2.26	47.89	53.90	6.0	150	0	
Vert.	2483.500	PK	46.65	27.65	14.77	34.77	2.26	56.56	73.90	17.3	184	106	
Vert.	4924.000	PK	44.81	31.37	7.25	39.50	2.26	46.19	73.90	27.7	103	32	
Vert.	7386.000	PK	43.89	37.01	9.13	39.39	2.26	52.90	73.90	21.0	150	0	
Vert.	9848.000	PK	44.24	39.12	10.38	39.35	2.26	56.65	73.90	17.2	150	0	
Vert.	2483.500	AV	36.78	27.65	14.77	34.77	2.26	46.69	53.90	7.2	184	106	
Vert.	4924.000	AV	35.71	31.37	7.25	39.50	2.26	37.09	53.90	16.8	103	32	
Vert.	7386.000	AV	35.03	37.01	9.13	39.39	2.26	44.04	53.90	9.8	150	0	
Vert.	9848.000	AV	35.25	39.12	10.38	39.35	2.26	47.66	53.90	6.2	150	0	

Result = Reading + Ant.Fac. + Loss (Cable+(Attenuator or Filter)(below 18 GHz)) - Gain(Amplifier) + Distance factor

Distance factor : 1 GHz - 13 GHz : $20\log(3.89\text{ m} / 3.0\text{ m}) = 2.26\text{ dB}$

13 GHz - 40 GHz : $20\log(1.0\text{ m} / 3.0\text{ m}) = -9.54\text{ dB}$

UL Japan, Inc.

Shonan EMC Lab.

1-22-3 Megumigaoka, Hiratsuka-shi, Kanagawa 259-1220 JAPAN

Telephone : +81 463 50 6400

Facsimile : +81 463 50 6401

Radiated Spurious Emission (Reference Plot for band-edge)

Test place	Shonan EMC Lab.
Semi Anechoic Chamber	No.3
Date	January 15, 2019
Temperature / Humidity	22 deg.C / 36 %RH
Engineer	Makoto Hosaka
	(1 GHz – 2.8 GHz)
Mode	Tx, IEEE802.11n HT40 (SISO) , 2462 MHz

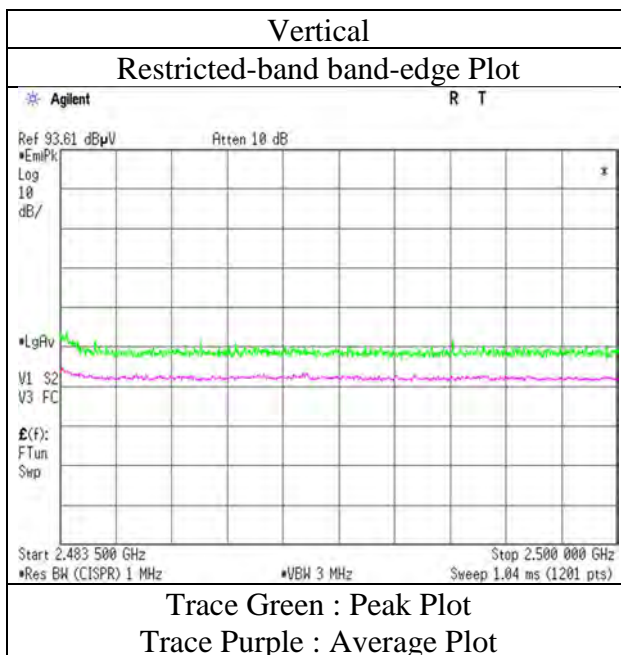
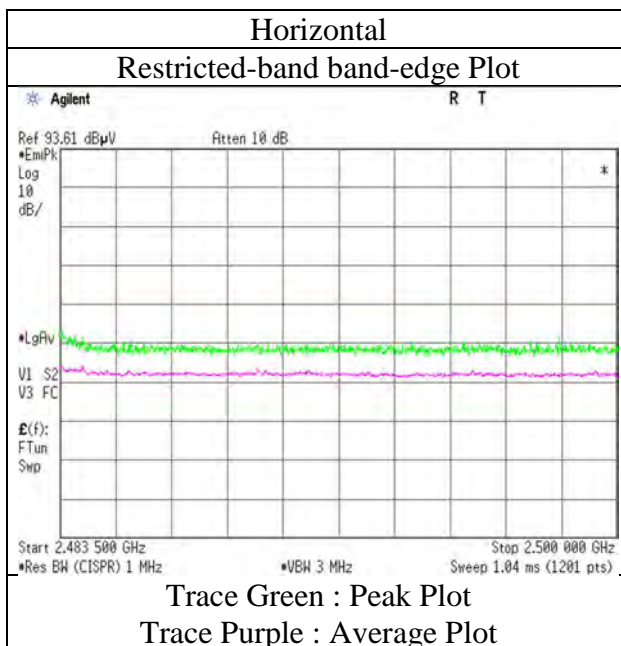

* The measurement was conducted for a sufficiently long enough time to detect any possible spurious emissions. Final result of restricted band edge was shown in tabular data.

Radiated Emission

Report No. 12656071S
 Test place Shonan EMC Lab.
 Semi Anechoic Chamber No.3 No.3 No.3 No.3
 Date January 14, 2019 January 18, 2019 February 25, 2019 January 17, 2019
 Temperature / Humidity 23 deg.C / 25 %RH 22 deg.C / 34 %RH 25 deg.C / 35 %RH 21 deg.C / 35 %RH
 Engineer Kenichi Adachi Makoto Hosaka Kazutaka Takeyama Makoto Hosaka
 (1 GHz -2.8 GHz) (2.8 GHz - 13 GHz) (13 GHz - 18 GHz) (18 GHz - 26.5 GHz)
 Mode Tx, 2422 MHz
 Tx, IEEE802.11n HT40 (MIMO)

(* PK: Peak, AV: Average, QP: Quasi-Peak)

Polarity	Frequency [MHz]	Detector	Reading [dBuV]	Ant.Fac. [dB/m]	Loss [dB]	Gain [dB]	Distance Factor [dB]	Result [dBuV/m]	Limit [dBuV/m]	Margin [dB]	Height [cm]	Angle [deg]	Remark
Hori.	2386.864	PK	47.71	27.85	14.67	34.78	2.26	57.71	73.90	16.1	271	214	
Hori.	2390.000	PK	45.54	27.86	14.67	34.78	2.26	55.55	73.90	18.3	271	214	
Hori.	4844.000	PK	45.48	31.49	7.20	39.50	2.26	46.93	73.90	26.9	186	285	
Hori.	7266.000	PK	43.23	36.91	9.06	39.32	2.26	52.14	73.90	21.7	150	0	
Hori.	9688.000	PK	44.78	38.79	10.48	39.46	2.26	56.85	73.90	17.0	150	0	
Hori.	2386.864	AV	37.33	27.85	14.67	34.78	2.26	47.33	53.90	6.5	271	214	
Hori.	2390.000	AV	36.39	27.86	14.67	34.78	2.26	46.40	53.90	7.5	271	214	
Hori.	4844.000	AV	35.59	31.49	7.20	39.50	2.26	37.04	53.90	16.8	186	285	
Hori.	7266.000	AV	33.33	36.91	9.06	39.32	2.26	42.24	53.90	11.6	150	0	
Hori.	9688.000	AV	35.01	38.79	10.48	39.46	2.26	47.08	53.90	6.8	150	0	
Vert.	2386.864	PK	47.63	27.85	14.67	34.78	2.26	57.63	73.90	16.2	181	106	
Vert.	2390.000	PK	45.68	27.86	14.67	34.78	2.26	55.69	73.90	18.2	181	106	
Vert.	4844.000	PK	44.76	31.49	7.20	39.50	2.26	46.21	73.90	27.6	106	8	
Vert.	7266.000	PK	42.96	36.91	9.06	39.32	2.26	51.87	73.90	22.0	150	0	
Vert.	9688.000	PK	44.57	38.79	10.48	39.46	2.26	56.64	73.90	17.2	150	0	
Vert.	2386.864	AV	37.29	27.85	14.67	34.78	2.26	47.29	53.90	6.6	181	106	
Vert.	2390.000	AV	36.04	27.86	14.67	34.78	2.26	46.05	53.90	7.8	181	106	
Vert.	4844.000	AV	35.23	31.49	7.20	39.50	2.26	36.68	53.90	17.2	106	8	
Vert.	7266.000	AV	33.53	36.91	9.06	39.32	2.26	42.44	53.90	11.4	150	0	
Vert.	9688.000	AV	35.52	38.79	10.48	39.46	2.26	47.59	53.90	6.3	150	0	

Result = Reading + Ant.Fac. + Loss (Cable+(Attenuator or Filter)(below 18 GHz)) - Gain(Amplifier) + Distance factor

Distance factor : 1 GHz - 13 GHz : $20\log(3.89\text{ m} / 3.0\text{ m}) = 2.26\text{ dB}$ 13 GHz - 40 GHz : $20\log(1.0\text{ m} / 3.0\text{ m}) = -9.54\text{ dB}$ **20 dBc Data Sheet (RBW 100 kHz, VBW 300 kHz)**

Polarity	Frequency [MHz]	Detector	Reading [dBuV]	Ant.Fac. [dB/m]	Loss [dB]	Gain [dB]	Distance Factor [dB]	Result [dBuV/m]	Limit [dBuV/m]	Margin [dB]	Remark
Hori.	2422.000	PK	83.98	27.83	14.70	34.78	2.26	93.99	-	-	Carrier
Hori.	2400.000	PK	38.58	27.86	14.68	34.78	2.26	48.60	73.99	25.3	
Vert.	2422.000	PK	83.23	27.83	14.70	34.78	2.26	93.24	-	-	Carrier
Vert.	2400.000	PK	38.25	27.86	14.68	34.78	2.26	48.27	73.24	24.9	

Result = Reading + Ant.Fac. + Loss (Cable+(Attenuator or Filter)(below 18 GHz)) - Gain(Amplifier) + Distance factor

Distance factor : 1 GHz - 13 GHz : $20\log(3.89\text{ m} / 3.0\text{ m}) = 2.26\text{ dB}$ 13 GHz - 40 GHz : $20\log(1.0\text{ m} / 3.0\text{ m}) = -9.54\text{ dB}$ **UL Japan, Inc.****Shonan EMC Lab.**

1-22-3 Megumigaoka, Hiratsuka-shi, Kanagawa 259-1220 JAPAN

Telephone : +81 463 50 6400

Facsimile : +81 463 50 6401

Radiated Spurious Emission (Reference Plot for band-edge)

Test place	Shonan EMC Lab.
Semi Anechoic Chamber	No.3
Date	January 14, 2019
Temperature / Humidity	23 deg.C / 25 %RH
Engineer	Kenichi Adachi
	(1 GHz – 2.8 GHz)
Mode	Tx, IEEE802.11n HT40 (MIMO) , 2422 MHz

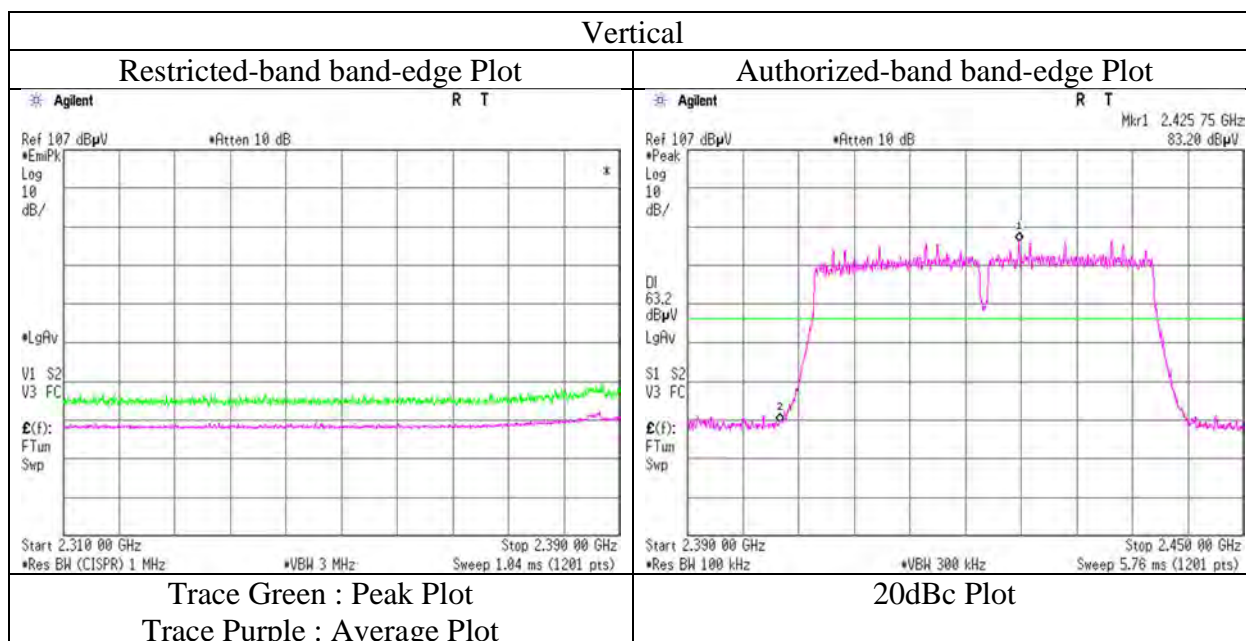
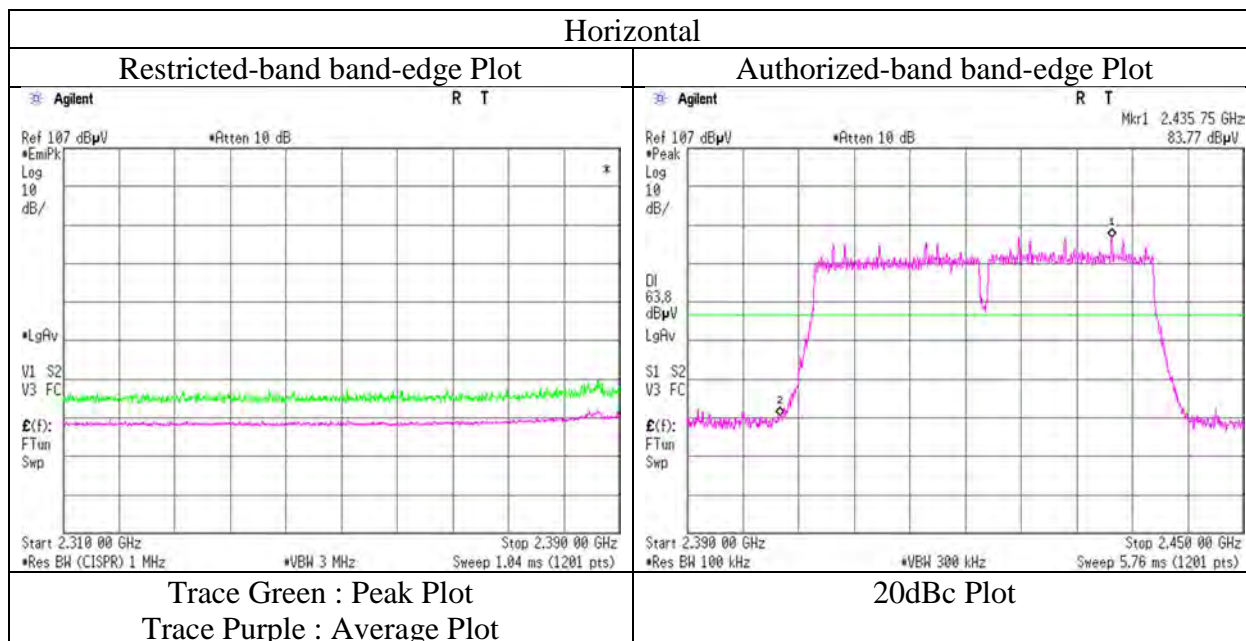

* The measurement was conducted for a sufficiently long enough time to detect any possible spurious emissions. Final result of restricted band edge was shown in tabular data.

UL Japan, Inc.

Shonan EMC Lab.

1-22-3 Megumigaoka, Hiratsuka-shi, Kanagawa-ken, 259-1220 JAPAN

Telephone : +81 463 50 6400

Facsimile : +81 463 50 6401

Radiated Emission

Report No. 12656071S
 Test place Shonan EMC Lab.
 Semi Anechoic Chamber No.3 No.3 No.3 No.3
 Date January 15, 2019 January 18, 2019 February 25, 2019 January 17, 2019
 Temperature / Humidity 22 deg.C / 36 %RH 22 deg.C / 34 %RH 25 deg.C / 35 %RH 21 deg.C / 35 %RH
 Engineer Makoto Hosaka Makoto Hosaka Kazutaka Takeyama Makoto Hosaka
 (1 GHz - 2.8 GHz) (2.8 GHz - 13 GHz) (13 GHz - 18 GHz) (18 GHz - 26.5 GHz)
 Mode Tx, 2437 MHz
 Tx, IEEE802.11n HT40 (MIMO)

(* PK: Peak, AV: Average, QP: Quasi-Peak)

Polarity	Frequency [MHz]	Detector	Reading [dBuV]	Ant.Fac. [dB/m]	Loss [dB]	Gain [dB]	Distance Factor [dB]	Result [dBuV/m]	Limit [dBuV/m]	Margin [dB]	Height [cm]	Angle [deg]	Remark
Hori.	4874.000	PK	45.62	31.40	7.21	39.50	2.26	46.99	73.90	26.9	189	294	
Hori.	7311.000	PK	43.91	36.99	9.08	39.35	2.26	52.89	73.90	21.0	150	0	
Hori.	9748.000	PK	44.79	38.92	10.45	39.42	2.26	57.00	73.90	16.9	150	0	
Hori.	4874.000	AV	35.31	31.40	7.21	39.50	2.26	36.68	53.90	17.2	189	294	
Hori.	7311.000	AV	33.91	36.99	9.08	39.35	2.26	42.89	53.90	11.0	150	0	
Hori.	9748.000	AV	34.14	38.92	10.45	39.42	2.26	46.35	53.90	7.5	150	0	
Vert.	4874.000	PK	44.84	31.40	7.21	39.50	2.26	46.21	73.90	27.6	103	15	
Vert.	7311.000	PK	43.14	36.99	9.08	39.35	2.26	52.12	73.90	21.7	150	0	
Vert.	9748.000	PK	43.92	38.92	10.45	39.42	2.26	56.13	73.90	17.7	150	0	
Vert.	4874.000	AV	35.36	31.40	7.21	39.50	2.26	36.73	53.90	17.1	103	15	
Vert.	7311.000	AV	33.95	36.99	9.08	39.35	2.26	42.93	53.90	10.9	150	0	
Vert.	9748.000	AV	34.18	38.92	10.45	39.42	2.26	46.39	53.90	7.5	150	0	

Result = Reading + Ant.Fac. + Loss (Cable+(Attenuator or Filter)(below 18 GHz)) - Gain(Amplifier) + Distance factor

Distance factor : 1 GHz - 13 GHz : $20\log(3.89\text{ m} / 3.0\text{ m}) = 2.26\text{ dB}$

13 GHz - 40 GHz : $20\log(1.0\text{ m} / 3.0\text{ m}) = -9.54\text{ dB}$

UL Japan, Inc.

Shonan EMC Lab.

1-22-3 Megumigaoka, Hiratsuka-shi, Kanagawa 259-1220 JAPAN

Telephone : +81 463 50 6400

Facsimile : +81 463 50 6401

Radiated Emission

Report No. 12656071S
 Test place Shonan EMC Lab.
 Semi Anechoic Chamber No.3 No.3 No.3 No.3
 Date January 15, 2019 January 18, 2019 February 25, 2019 January 17, 2019
 Temperature / Humidity 22 deg.C / 36 %RH 22 deg.C / 34 %RH 25 deg.C / 35 %RH 21 deg.C / 35 %RH
 Engineer Makoto Hosaka Makoto Hosaka Kazutaka Takeyama Makoto Hosaka
 (1 GHz - 2.8 GHz) (2.8 GHz - 13 GHz) (13 GHz - 18 GHz) (18 GHz - 26.5 GHz)
 Mode Tx, 2452 MHz
 Tx, IEEE802.11n HT40 (MIMO)

(* PK: Peak, AV: Average, QP: Quasi-Peak)

Polarity	Frequency [MHz]	Detector	Reading [dBuV]	Ant.Fac. [dB/m]	Loss [dB]	Gain [dB]	Distance Factor [dB]	Result [dBuV/m]	Limit [dBuV/m]	Margin [dB]	Height [cm]	Angle [deg]	Remark
Hori.	2483.500	PK	45.87	27.65	14.77	34.77	2.26	55.78	73.90	18.1	137	149	
Hori.	4904.000	PK	45.04	31.30	7.24	39.50	2.26	46.34	73.90	27.5	189	287	
Hori.	7356.000	PK	43.42	37.04	9.10	39.37	2.26	52.45	73.90	21.4	150	0	
Hori.	9808.000	PK	44.14	38.95	10.42	39.38	2.26	56.39	73.90	17.5	150	0	
Hori.	2483.500	AV	36.13	27.65	14.77	34.77	2.26	46.04	53.90	7.8	137	149	
Hori.	4904.000	AV	35.31	31.30	7.24	39.50	2.26	36.61	53.90	17.2	189	287	
Hori.	7356.000	AV	34.23	37.04	9.10	39.37	2.26	43.26	53.90	10.6	150	0	
Hori.	9808.000	AV	35.05	38.95	10.42	39.38	2.26	47.30	53.90	6.6	150	0	
Vert.	2483.500	PK	46.57	27.65	14.77	34.77	2.26	56.48	73.90	17.4	184	108	
Vert.	4904.000	PK	44.96	31.30	7.24	39.50	2.26	46.26	73.90	27.6	104	12	
Vert.	7356.000	PK	43.40	37.04	9.10	39.37	2.26	52.43	73.90	21.4	150	0	
Vert.	9808.000	PK	44.41	38.95	10.42	39.38	2.26	56.66	73.90	17.2	150	0	
Vert.	2483.500	AV	36.11	27.65	14.77	34.77	2.26	46.02	53.90	7.8	184	108	
Vert.	4904.000	AV	35.57	31.30	7.24	39.50	2.26	36.87	53.90	17.0	104	12	
Vert.	7356.000	AV	33.94	37.04	9.10	39.37	2.26	42.97	53.90	10.9	150	0	
Vert.	9808.000	AV	34.80	38.95	10.42	39.38	2.26	47.05	53.90	6.8	150	0	

Result = Reading + Ant.Fac. + Loss (Cable+(Attenuator or Filter)(below 18 GHz)) - Gain(Amplifier) + Distance factor

Distance factor : 1 GHz - 13 GHz : $20\log(3.89\text{ m} / 3.0\text{ m}) = 2.26\text{ dB}$

13 GHz - 40 GHz : $20\log(1.0\text{ m} / 3.0\text{ m}) = -9.54\text{ dB}$

UL Japan, Inc.

Shonan EMC Lab.

1-22-3 Megumigaoka, Hiratsuka-shi, Kanagawa 259-1220 JAPAN

Telephone : +81 463 50 6400

Facsimile : +81 463 50 6401

Radiated Spurious Emission (Reference Plot for band-edge)

Test place	Shonan EMC Lab.
Semi Anechoic Chamber	No.3
Date	January 15, 2019
Temperature / Humidity	22 deg.C / 36 %RH
Engineer	Makoto Hosaka
	(1 GHz – 2.8 GHz)
Mode	Tx, IEEE802.11n HT40 (MIMO) , 2452 MHz

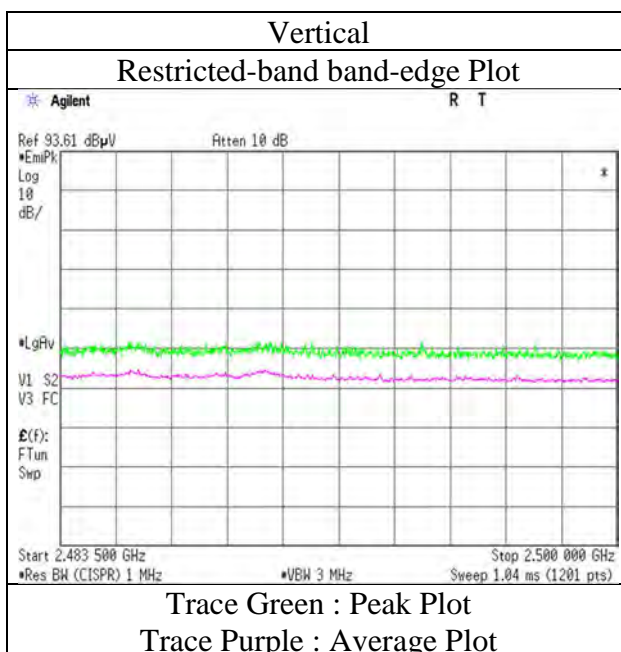
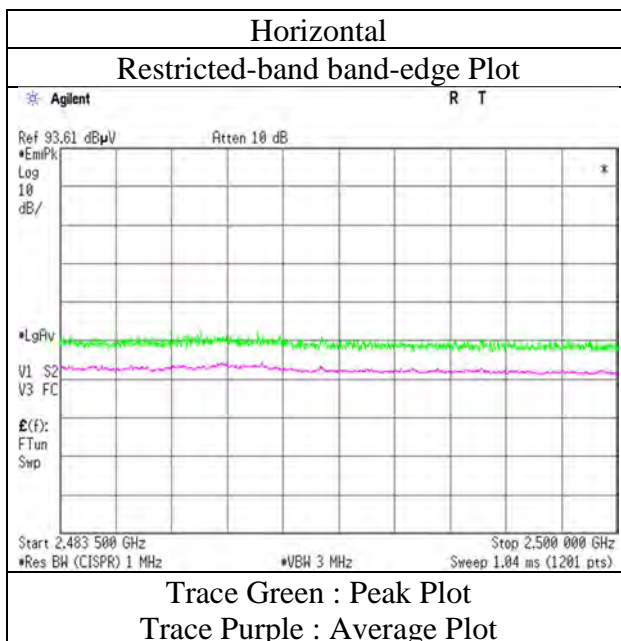

* The measurement was conducted for a sufficiently long enough time to detect any possible spurious emissions. Final result of restricted band edge was shown in tabular data.

Radiated Emission

Report No. 12656071S
 Test place Shonan EMC Lab.
 Semi Anechoic Chamber No.3 No.3 No.3 No.3
 Date January 15, 2019 January 18, 2019 February 25, 2019 January 17, 2019
 Temperature / Humidity 22 deg.C / 36 %RH 22 deg.C / 34 %RH 25 deg.C / 35 %RH 21 deg.C / 35 %RH
 Engineer Makoto Hosaka Makoto Hosaka Kazutaka Takeyama Makoto Hosaka
 (1 GHz - 2.8 GHz) (2.8 GHz - 13 GHz) (13 GHz - 18 GHz) (18 GHz - 26.5 GHz)
 Mode Tx, 2457 MHz
 Tx, IEEE802.11n HT40 (MIMO)

(* PK: Peak, AV: Average, QP: Quasi-Peak)

Polarity	Frequency [MHz]	Detector	Reading [dBuV]	Ant.Fac. [dB/m]	Loss [dB]	Gain [dB]	Distance Factor [dB]	Result [dBuV/m]	Limit [dBuV/m]	Margin [dB]	Height [cm]	Angle [deg]	Remark
Hori.	2483.500	PK	45.96	27.65	14.77	34.77	2.26	55.87	73.90	18.0	231	257	
Hori.	4914.000	PK	45.70	31.34	7.24	39.50	2.26	47.04	73.90	26.8	195	293	
Hori.	7371.000	PK	43.90	37.02	9.10	39.38	2.26	52.90	73.90	21.0	150	0	
Hori.	9828.000	PK	43.66	39.04	10.40	39.36	2.26	56.00	73.90	17.9	150	0	
Hori.	2483.500	AV	36.00	27.65	14.77	34.77	2.26	45.91	53.90	7.9	231	257	
Hori.	4914.000	AV	35.85	31.34	7.24	39.50	2.26	37.19	53.90	16.7	195	293	
Hori.	7371.000	AV	34.73	37.02	9.10	39.38	2.26	43.73	53.90	10.1	150	0	
Hori.	9828.000	AV	34.72	39.04	10.40	39.36	2.26	47.06	53.90	6.8	150	0	
Vert.	2483.500	PK	46.21	27.65	14.77	34.77	2.26	56.12	73.90	17.7	182	109	
Vert.	4914.000	PK	45.85	31.34	7.24	39.50	2.26	47.19	73.90	26.7	105	18	
Vert.	7371.000	PK	44.46	37.02	9.10	39.38	2.26	53.46	73.90	20.4	150	0	
Vert.	9828.000	PK	43.97	39.04	10.40	39.36	2.26	56.31	73.90	17.5	150	0	
Vert.	2483.500	AV	36.68	27.65	14.77	34.77	2.26	46.59	53.90	7.3	182	109	
Vert.	4914.000	AV	35.41	31.34	7.24	39.50	2.26	36.75	53.90	17.1	105	18	
Vert.	7371.000	AV	34.78	37.02	9.10	39.38	2.26	43.78	53.90	10.1	150	0	
Vert.	9828.000	AV	34.88	39.04	10.40	39.36	2.26	47.22	53.90	6.6	150	0	

Result = Reading + Ant.Fac. + Loss (Cable+(Attenuator or Filter)(below 18 GHz)) - Gain(Amplifier) + Distance factor

Distance factor : 1 GHz - 13 GHz : $20\log(3.89\text{ m} / 3.0\text{ m}) = 2.26\text{ dB}$

13 GHz - 40 GHz : $20\log(1.0\text{ m} / 3.0\text{ m}) = -9.54\text{ dB}$

UL Japan, Inc.

Shonan EMC Lab.

1-22-3 Megumigaoka, Hiratsuka-shi, Kanagawa 259-1220 JAPAN

Telephone : +81 463 50 6400

Facsimile : +81 463 50 6401

Radiated Spurious Emission
(Reference Plot for band-edge)

Test place	Shonan EMC Lab.
Semi Anechoic Chamber	No.3
Date	January 15, 2019
Temperature / Humidity	22 deg.C / 36 %RH
Engineer	Makoto Hosaka
	(1 GHz – 2.8 GHz)
Mode	Tx, IEEE802.11n HT40 (MIMO) , 2457 MHz

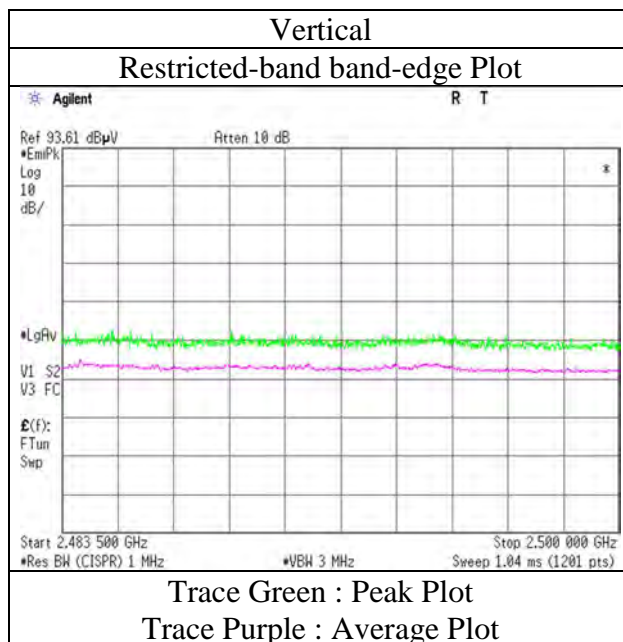
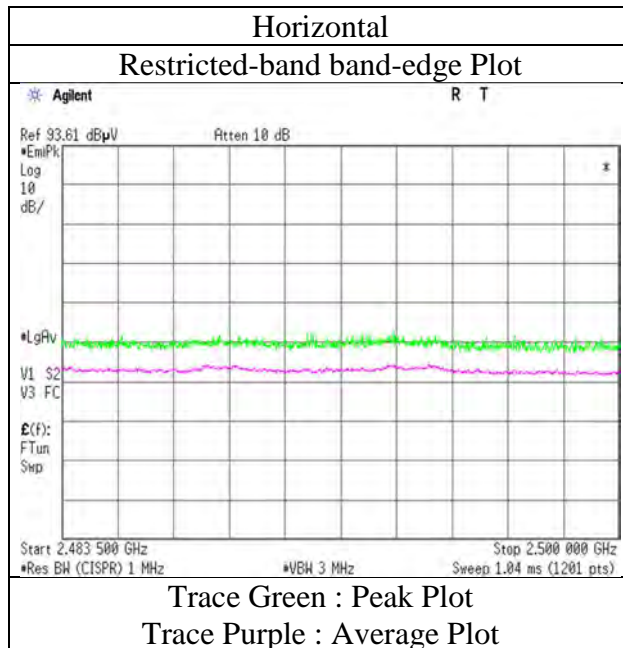

* The measurement was conducted for a sufficiently long enough time to detect any possible spurious emissions. Final result of restricted band edge was shown in tabular data.

Radiated Emission

Report No. 12656071S
 Test place Shonan EMC Lab.
 Semi Anechoic Chamber No.3 No.3 No.3 No.3
 Date January 14, 2019 January 18, 2019 February 25, 2019 January 17, 2019
 Temperature / Humidity 23 deg.C / 25 %RH 22 deg.C / 34 %RH 25 deg.C / 35 %RH 21 deg.C / 35 %RH
 Engineer Kenichi Adachi Makoto Hosaka Kazutaka Takeyama Makoto Hosaka
 (1 GHz - 2.8 GHz) (2.8 GHz - 13 GHz) (13 GHz - 18 GHz) (18 GHz - 26.5 GHz)
 Mode Tx, 2462 MHz
 Tx, IEEE802.11n HT40 (MIMO)

(* PK: Peak, AV: Average, QP: Quasi-Peak)

Polarity	Frequency [MHz]	Detector	Reading [dBuV]	Ant.Fac. [dB/m]	Loss [dB]	Gain [dB]	Distance Factor [dB]	Result [dBuV/m]	Limit [dBuV/m]	Margin [dB]	Height [cm]	Angle [deg]	Remark
Hori.	2483.500	PK	47.42	27.65	14.77	34.77	2.26	57.33	73.90	16.5	265	213	
Hori.	4924.000	PK	45.42	31.37	7.25	39.50	2.26	46.80	73.90	27.1	188	291	
Hori.	7386.000	PK	45.19	37.01	9.13	39.39	2.26	54.20	73.90	19.7	150	0	
Hori.	9848.000	PK	44.51	39.12	10.38	39.35	2.26	56.92	73.90	16.9	150	0	
Hori.	2483.500	AV	36.84	27.65	14.77	34.77	2.26	46.75	53.90	7.1	265	213	
Hori.	4924.000	AV	35.43	31.37	7.25	39.50	2.26	36.81	53.90	17.0	188	291	
Hori.	7386.000	AV	34.58	37.01	9.13	39.39	2.26	43.59	53.90	10.3	150	0	
Hori.	9848.000	AV	35.09	39.12	10.38	39.35	2.26	47.50	53.90	6.4	150	0	
Vert.	2483.500	PK	46.65	27.65	14.77	34.77	2.26	56.56	73.90	17.3	184	106	
Vert.	4924.000	PK	45.62	31.37	7.25	39.50	2.26	47.00	73.90	26.9	102	15	
Vert.	7386.000	PK	43.57	37.01	9.13	39.39	2.26	52.58	73.90	21.3	150	0	
Vert.	9848.000	PK	44.60	39.12	10.38	39.35	2.26	57.01	73.90	16.8	150	0	
Vert.	2483.500	AV	36.78	27.65	14.77	34.77	2.26	46.69	53.90	7.2	184	106	
Vert.	4924.000	AV	35.23	31.37	7.25	39.50	2.26	36.61	53.90	17.2	102	15	
Vert.	7386.000	AV	34.35	37.01	9.13	39.39	2.26	43.36	53.90	10.5	150	0	
Vert.	9848.000	AV	35.10	39.12	10.38	39.35	2.26	47.51	53.90	6.3	150	0	

Result = Reading + Ant.Fac. + Loss (Cable+(Attenuator or Filter)(below 18 GHz)) - Gain(Amplifier) + Distance factor

Distance factor : 1 GHz - 13 GHz : $20\log(3.89\text{ m} / 3.0\text{ m}) = 2.26\text{ dB}$

13 GHz - 40 GHz : $20\log(1.0\text{ m} / 3.0\text{ m}) = -9.54\text{ dB}$

UL Japan, Inc.

Shonan EMC Lab.

1-22-3 Megumigaoka, Hiratsuka-shi, Kanagawa 259-1220 JAPAN

Telephone : +81 463 50 6400

Facsimile : +81 463 50 6401

Radiated Spurious Emission
(Reference Plot for band-edge)

Test place	Shonan EMC Lab.
Semi Anechoic Chamber	No.3
Date	January 14, 2019
Temperature / Humidity	23 deg.C / 35 %RH
Engineer	Kenichi Adachi
	(1 GHz – 2.8 GHz)
Mode	Tx, IEEE802.11n HT40 (MIMO) , 2462 MHz

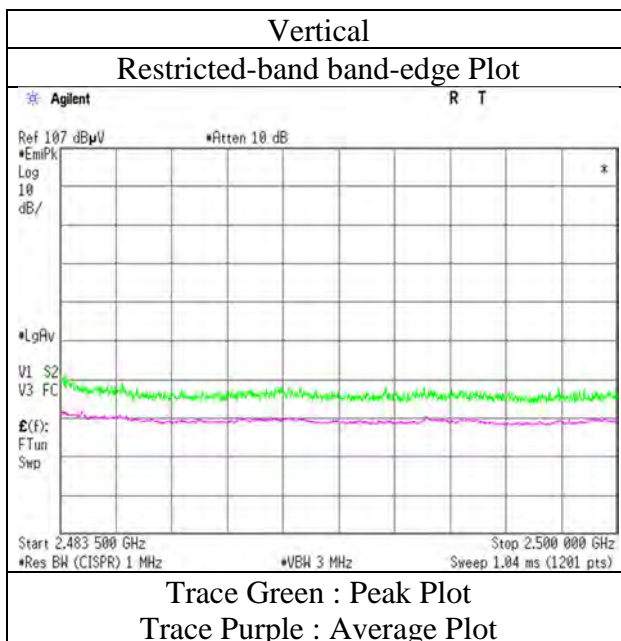
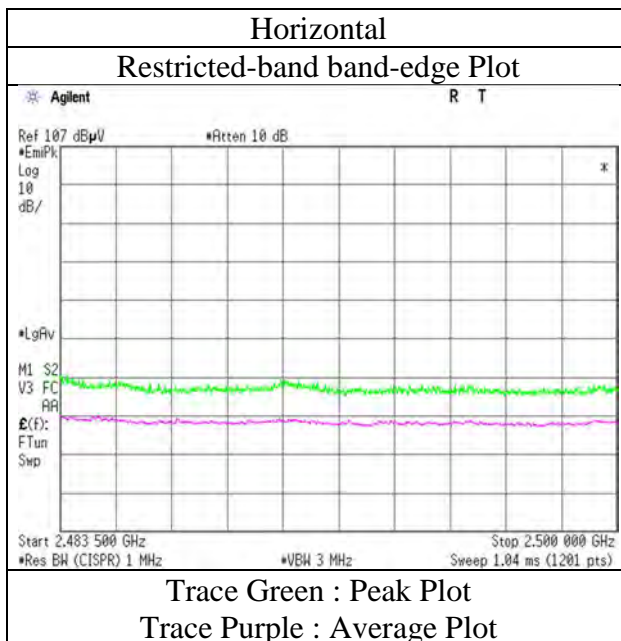

* The measurement was conducted for a sufficiently long enough time to detect any possible spurious emissions. Final result of restricted band edge was shown in tabular data.

Radiated Emission (Worst mode plot)

Report No.	Refer to previous sheet
Test place	Refer to previous sheet
Semi Anechoic Chamber	Refer to previous sheet
Date	Refer to previous sheet
Temperature / Humidity	Refer to previous sheet
Engineer	Refer to previous sheet
Mode	Tx, OFDM VHT20 (MIMO)

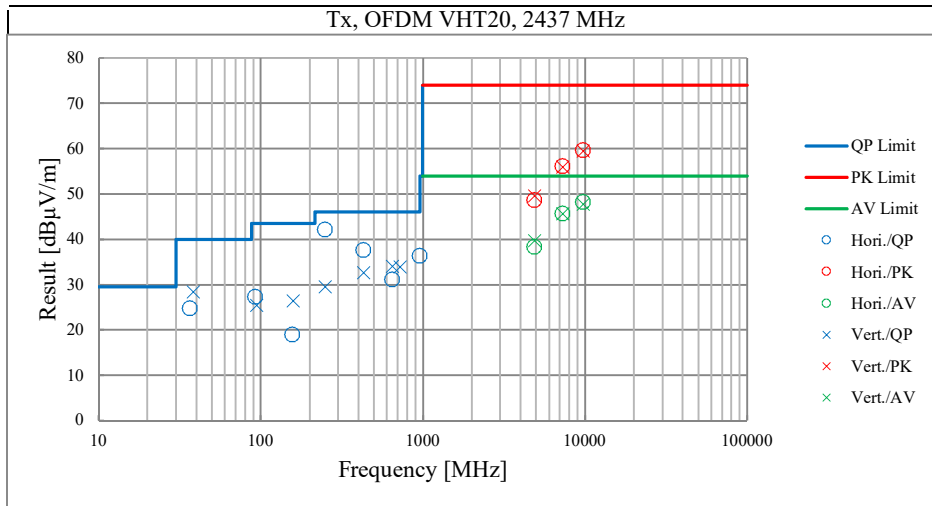

UL Japan, Inc.

Shonan EMC Lab.

1-22-3 Megumigaoka, Hiratsuka-shi, Kanagawa 259-1220 JAPAN

Telephone : +81 463 50 6400

Facsimile : +81 463 50 6401

Spurious emission (Conducted)

Tx, Bluetooth Low Energy, PN9

Tx, 2402 MHz (below 30MHz)

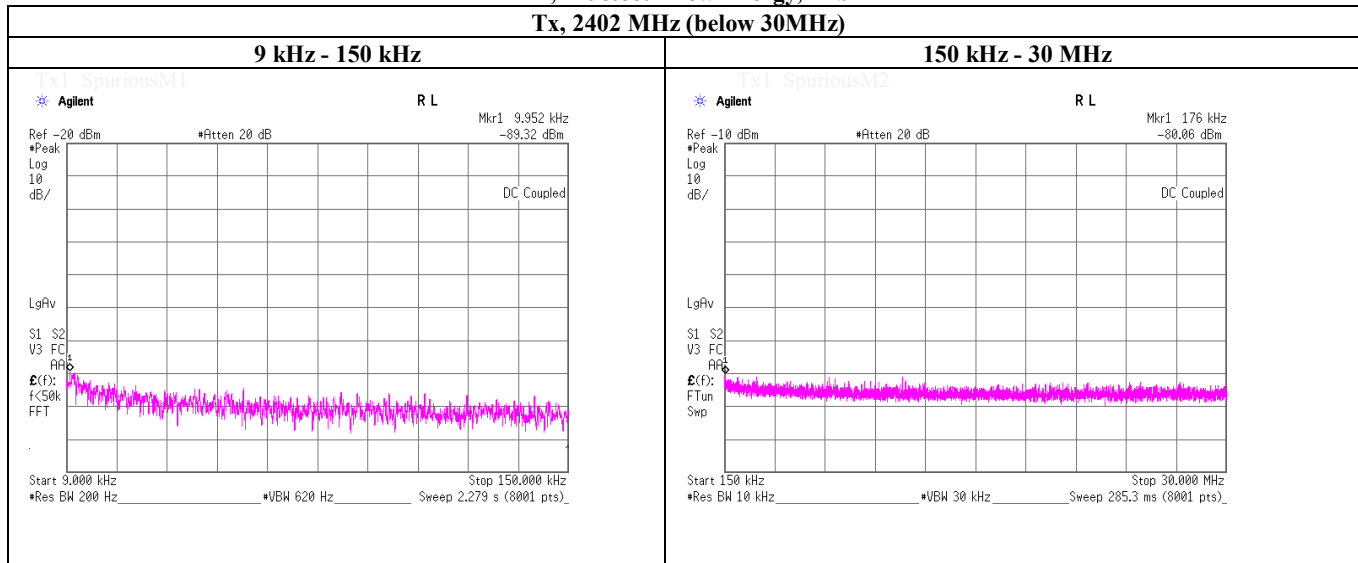

Frequency [kHz]	Reading [dBm]	Cable Loss [dB]	Attenuator Loss [dB]	Antenna Gain* [dBi]	N (Number of Output)	EIRP [dBm]	Distance [m]	Ground bounce [dB]	E (field strength) [dBuV/m]	Limit [dBuV/m]	Margin [dB]	Remark
9.95	-89.32	0.01	10.11	2.0	2	-74.2	300	6.0	-12.9	47.6	60.5	
176.00	-80.06	0.01	10.11	2.0	2	-64.9	300	6.0	-3.7	22.6	26.3	

$E \text{ [dBuV/m]} = \text{EIRP [dBm]} - 20 \log(\text{Distance [m]}) + \text{Ground bounce [dB]} + 104.8 \text{ [dBuV/m]}$

$\text{EIRP [dBm]} = \text{Reading [dBm]} + \text{Cable loss [dB]} + \text{Attenuator Loss [dB]} + \text{Antenna gain [dBi]} + 10 * \log(N)$

N: Number of output

*2.0 dBi was applied to the test result based on KDB 558074 since antenna gain was less than 2.0 dBi.

UL Japan, Inc.

Shonan EMC Lab.

1-22-3 Megumigaoka, Hiratsuka-shi, Kanagawa 259-1220 JAPAN

Telephone : +81 463 50 6400

Facsimile : +81 463 50 6401

Spurious emission (Conducted)

Tx, Bluetooth Low Energy, PN9

Tx, 2440 MHz (below 30MHz)

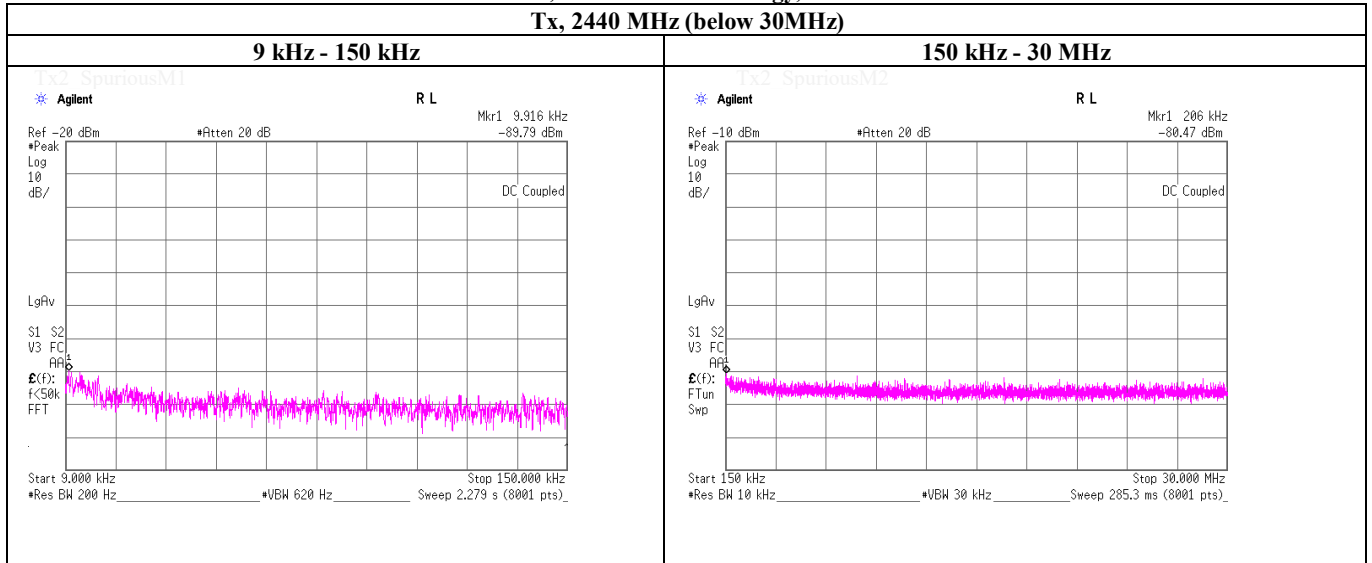

Frequency [kHz]	Reading [dBm]	Cable Loss [dB]	Attenuator Loss [dB]	Antenna Gain* [dBi]	N (Number of Output)	EIRP [dBm]	Distance [m]	Ground bounce [dB]	E (field strength) [dBuV/m]	Limit [dBuV/m]	Margin [dB]	Remark
9.92	-89.79	0.01	10.11	2.0	2	-74.7	300	6.0	-13.4	47.6	61.0	
206.00	-80.47	0.01	10.11	2.0	2	-65.3	300	6.0	-4.1	21.3	25.4	

$E \text{ [dBuV/m]} = \text{EIRP [dBm]} - 20 \log(\text{Distance [m]}) + \text{Ground bounce [dB]} + 104.8 \text{ [dBuV/m]}$

$\text{EIRP [dBm]} = \text{Reading [dBm]} + \text{Cable loss [dB]} + \text{Attenuator Loss [dB]} + \text{Antenna gain [dBi]} + 10 * \log(N)$

N: Number of output

*2.0 dBi was applied to the test result based on KDB 558074 since antenna gain was less than 2.0 dBi.

UL Japan, Inc.

Shonan EMC Lab.

1-22-3 Megumigaoka, Hiratsuka-shi, Kanagawa 259-1220 JAPAN

Telephone : +81 463 50 6400

Facsimile : +81 463 50 6401

Spurious emission (Conducted)

Tx, Bluetooth Low Energy, PN9

Tx, 2480 MHz (below 30MHz)

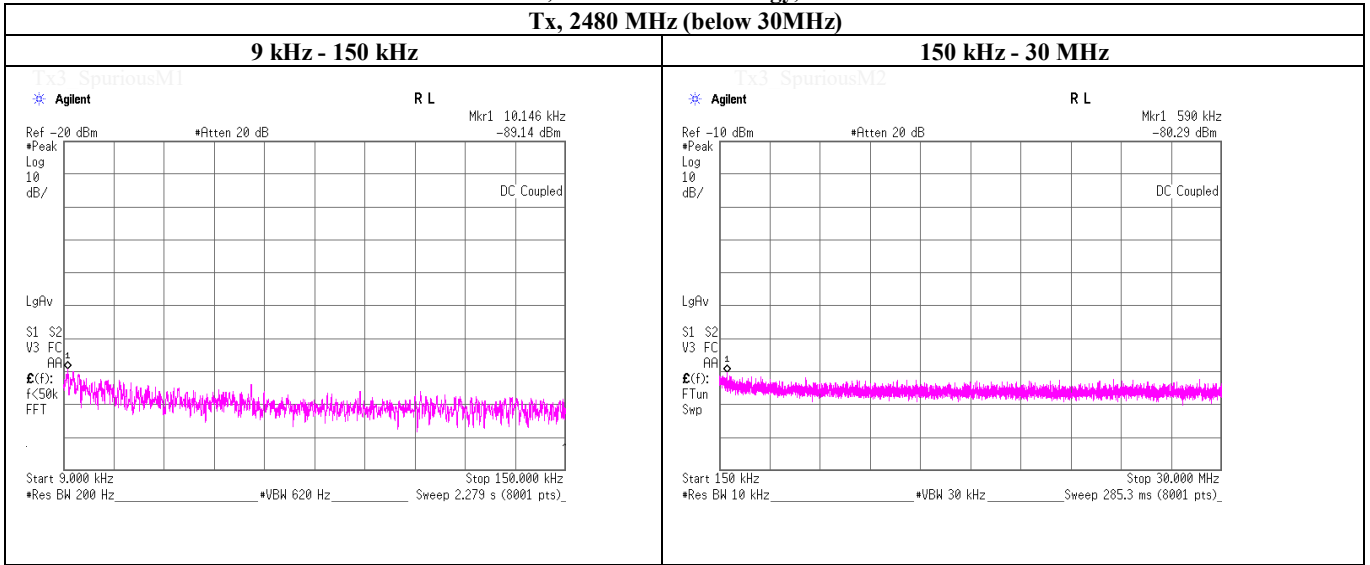

Frequency [kHz]	Reading [dBm]	Cable Loss [dB]	Attenuator Loss [dB]	Antenna Gain* [dBi]	N (Number of Output)	EIRP [dBm]	Distance [m]	Ground bounce [dB]	E (field strength) [dBuV/m]	Limit [dBuV/m]	Margin [dB]	Remark
10.15	-89.14	0.01	10.11	2.0	2	-74.0	300	6.0	-12.8	47.4	60.2	
590.00	-80.29	0.01	10.11	2.0	2	-65.2	30	6.0	16.1	32.1	16.0	

$E \text{ [dBuV/m]} = \text{EIRP [dBm]} - 20 \log(\text{Distance [m]}) + \text{Ground bounce [dB]} + 104.8 \text{ [dBuV/m]}$

$\text{EIRP [dBm]} = \text{Reading [dBm]} + \text{Cable loss [dB]} + \text{Attenuator Loss [dB]} + \text{Antenna gain [dBi]} + 10 * \log(N)$

N: Number of output

*2.0 dBi was applied to the test result based on KDB 558074 since antenna gain was less than 2.0 dBi.

UL Japan, Inc.

Shonan EMC Lab.

1-22-3 Megumigaoka, Hiratsuka-shi, Kanagawa 259-1220 JAPAN

Telephone : +81 463 50 6400

Facsimile : +81 463 50 6401

Spurious emission (Conducted)

(Worst mode)

Tx, OFDM VHT20 (MIMO), PN9, antenna port 1, worst data mode 3 (MCS)

Tx, 2437 MHz (below 30 MHz)

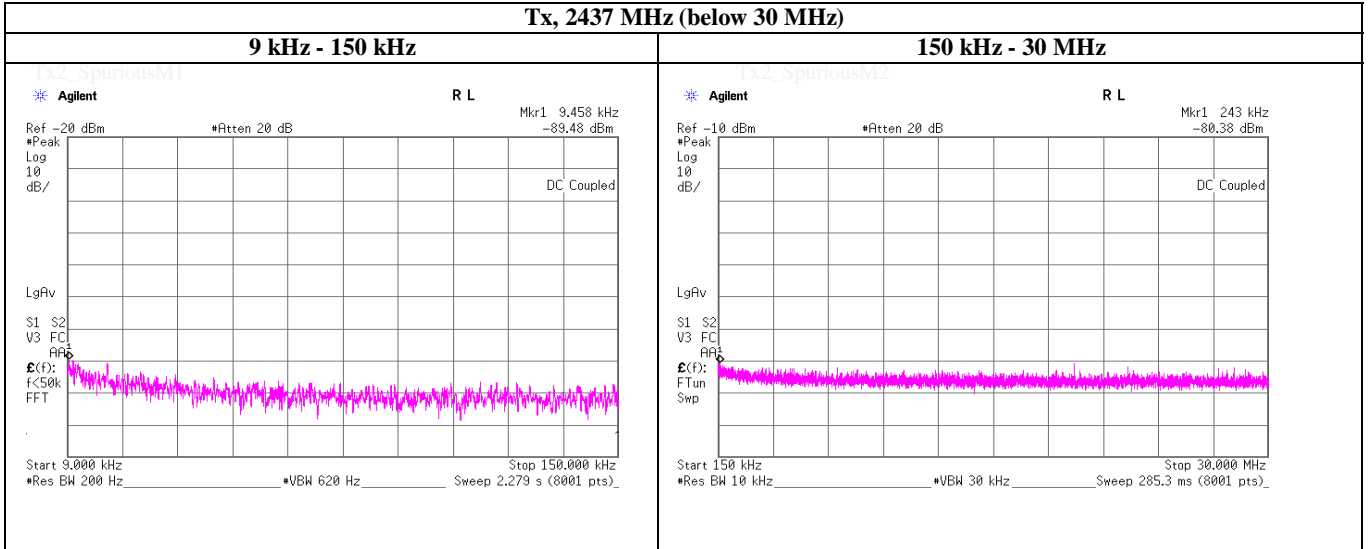

Frequency [kHz]	Reading [dBm]	Cable Loss [dB]	Attenuator Loss [dB]	Antenna Gain* [dBi]	N (Number of Output)	EIRP [dBm]	Distance [m]	Ground bounce [dB]	E (field strength) [dBuV/m]	Limit [dBuV/m]	Margin [dB]	Remark
9.46	-89.48	0.01	10.11	2.0	2	-74.4	300	6.0	-13.1	48.0	61.1	
243.00	-80.38	0.01	10.11	2.0	2	-65.2	300	6.0	-4.0	19.8	23.8	

$E \text{ [dBuV/m]} = \text{EIRP [dBm]} - 20 \log(\text{Distance [m]}) + \text{Ground bounce [dB]} + 104.8 \text{ [dBuV/m]}$

$\text{EIRP[dBm]} = \text{Reading [dBm]} + \text{Cable loss [dB]} + \text{Attenuator Loss [dB]} + \text{Antenna gain [dBi]} + 10 * \log(N)$

N: Number of output

*2.0 dBi was applied to the test result based on KDB 558074 since antenna gain was less than 2.0 dBi.

UL Japan, Inc.

Shonan EMC Lab.

1-22-3 Megumigaoka, Hiratsuka-shi, Kanagawa 259-1220 JAPAN

Telephone : +81 463 50 6400

Facsimile : +81 463 50 6401

Maximum Power Spectral Density

(PKPSD)

Test place	UL Japan, Inc. Shonan EMC Lab.	No.1 Measurement Room
Date	March 11, 2019	
Temperature / Humidity	24 deg.C , 55 %RH	
Engineer	Yosuke Ishikawa	
Mode	Tx, Bluetooth Low Energy, PN9	

Ch. Freq. [MHz]	Freq. Reading [MHz]	Reading [dBm]	Cable Loss [dB]	Atten. [dB]	Result [dBm]	Limit [dBm]	Margin [dB]
2402.0000	2401.97	-25.96	2.40	10.18	-13.38	8.00	21.38
2440.0000	2439.96	-25.79	2.41	10.18	-13.20	8.00	21.20
2480.0000	2479.96	-25.70	2.42	10.18	-13.10	8.00	21.10

Sample Calculation:
Result = Reading + Cable Loss (including the cable(s) customer supplied) + Atten. Loss

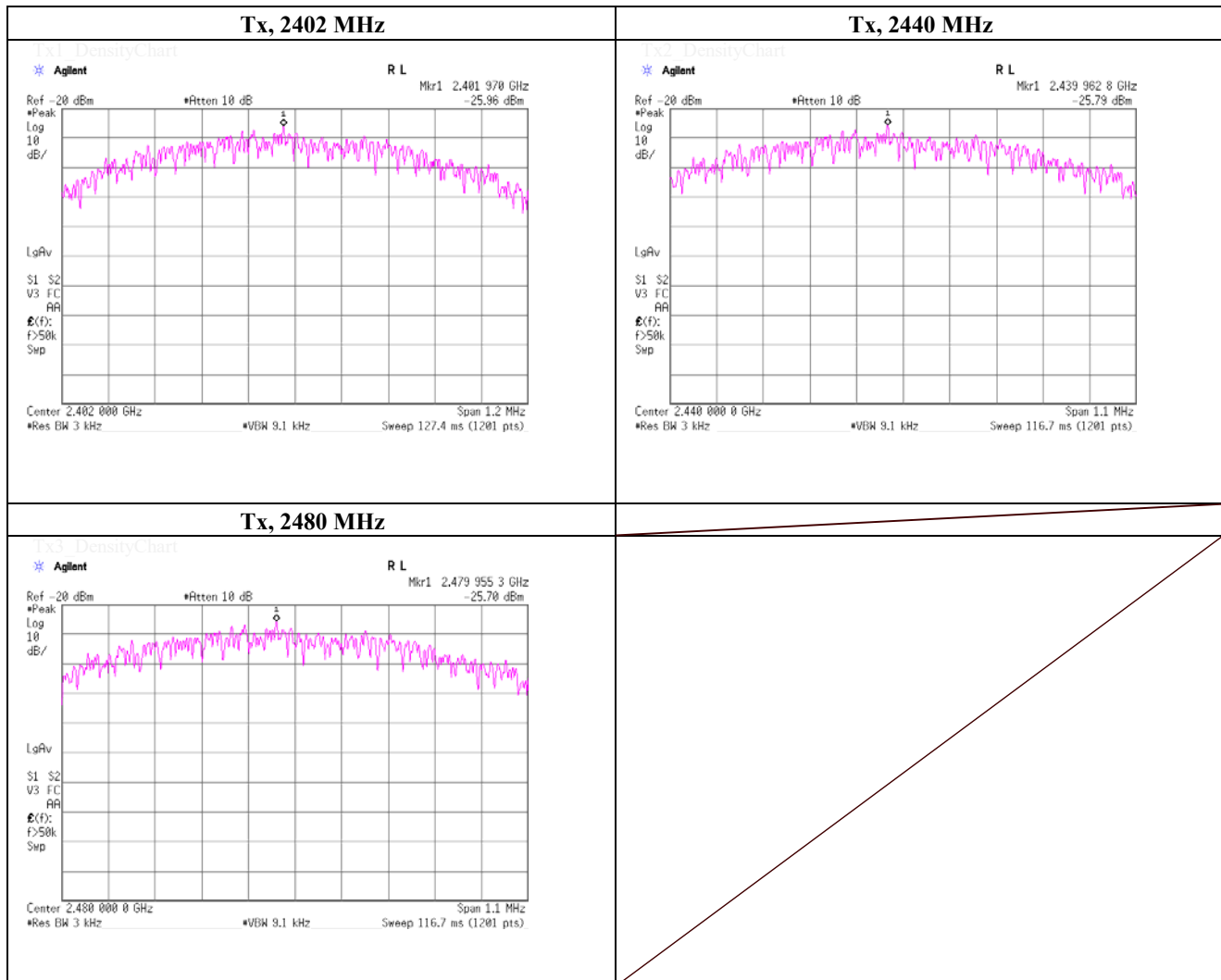

UL Japan, Inc.
Shonan EMC Lab.
 1-22-3 Megumigaoka, Hiratsuka-shi, Kanagawa 259-1220 JAPAN
 Telephone : +81 463 50 6400
 Facsimile : +81 463 50 6401

Maximum Power Spectral Density (PKPSD)

Test place	UL Japan, Inc. Shonan EMC Lab.	No.1 Measurement Room
Date	February 28, 2019	
Temperature / Humidity	23 deg.C , 55 %RH	
Engineer	Yosuke Ishikawa	
Mode	Tx, IEEE802.11b, PN9, worst antenna port 1, worst data mode 11 Mbps	

Ch. Freq. [MHz]	Freq. Reading [MHz]	Reading [dBm]	Cable Loss [dB]	Atten. [dB]	Result [dBm]	Limit [dBm]	Margin [dB]
2412.0000	2410.49	-17.43	2.41	10.18	-4.84	8.00	12.84
2437.0000	2436.78	-17.63	2.41	10.18	-5.04	8.00	13.04
2462.0000	2461.29	-18.42	2.42	10.18	-5.82	8.00	13.82

Sample Calculation:
Result = Reading + Cable Loss (including the cable(s) customer supplied) + Atten. Loss

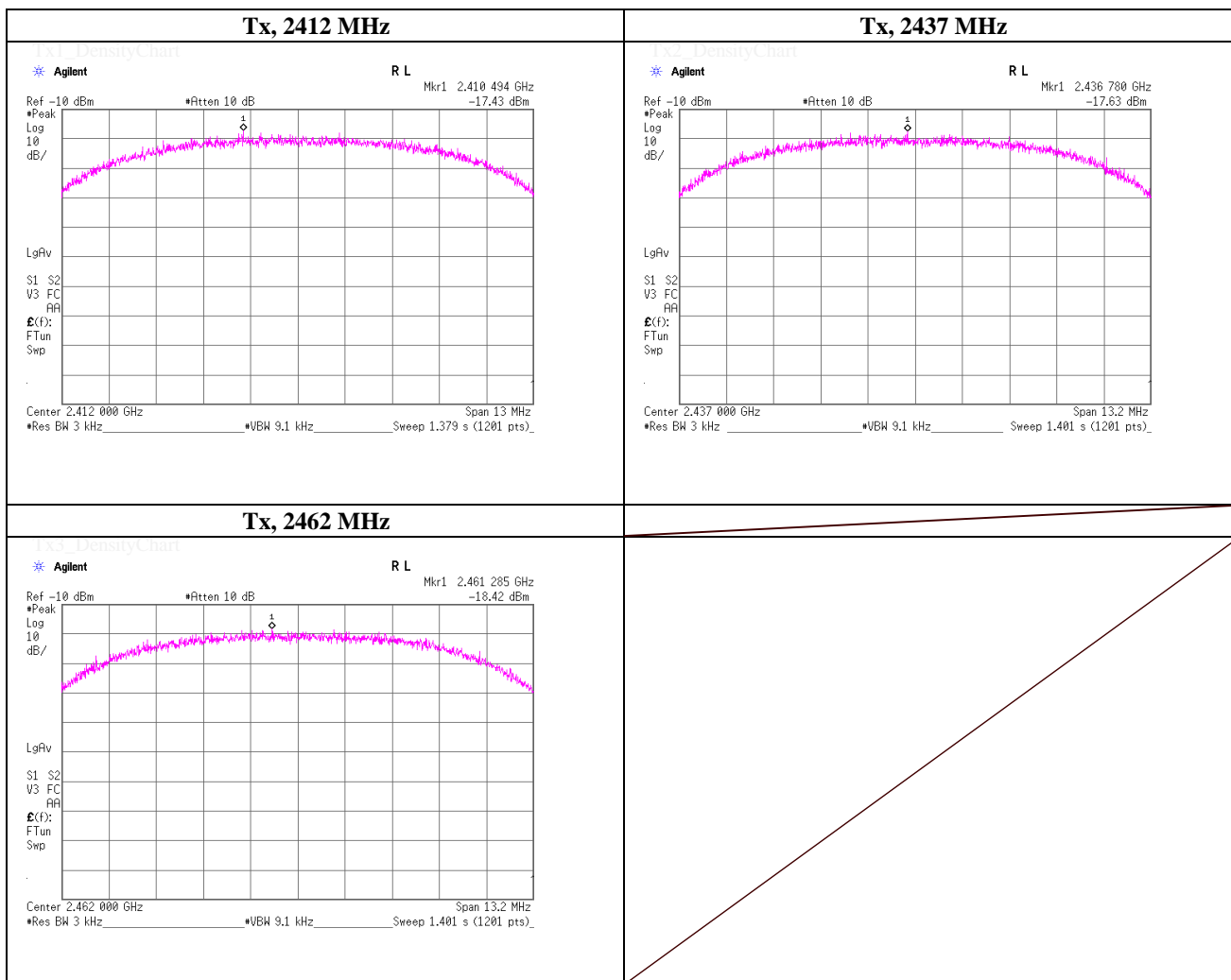

Maximum Power Spectral Density

(PKPSD)

Test place	UL Japan, Inc. Shonan EMC Lab.	No.1 Measurement Room
Date	February 28, 2019	
Temperature / Humidity	23 deg.C , 55 %RH	
Engineer	Yosuke Ishikawa	
Mode	Tx, IEEE802.11b, PN9, worst antenna port 1, worst data mode 11 Mbps	

Ch. Freq. [MHz]	Freq. Reading [MHz]	Reading [dBm]	Cable Loss [dB]	Atten. [dB]	Result [dBm]	Limit [dBm]	Margin [dB]
2467.0000	2467.61	-27.31	2.42	10.18	-14.71	8.00	22.71
2472.0000	2470.37	-31.30	2.42	10.18	-18.70	8.00	26.70

Sample Calculation:
Result = Reading + Cable Loss (including the cable(s) customer supplied) + Atten. Loss

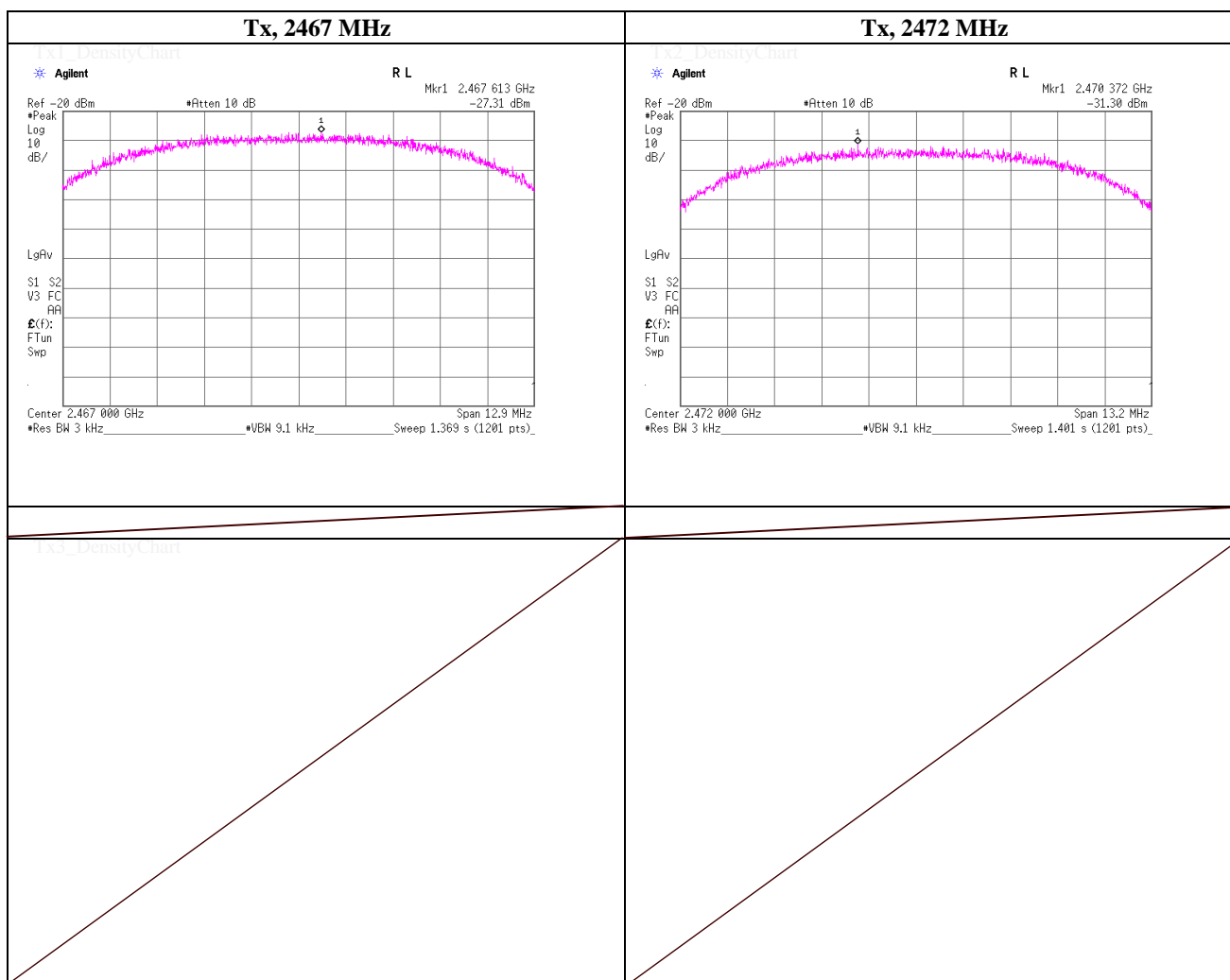

Maximum Power Spectral Density
(PKPSD)

Test place	UL Japan, Inc. Shonan EMC Lab.	No.1 Measurement Room
Date	February 28, 2019	
Temperature / Humidity	23 deg.C , 55 %RH	
Engineer	Yosuke Ishikawa	
Mode	Tx, IEEE802.11g, PN9, worst antenna port 1, worst data mode 48 Mbps	

Ch. Freq. [MHz]	Freq. Reading [MHz]	Reading [dBm]	Cable Loss [dB]	Atten. [dB]	Result [dBm]	Limit [dBm]	Margin [dB]
2412.0000	2414.56	-25.38	2.41	10.18	-12.79	8.00	20.79

Sample Calculation:
Result = Reading + Cable Loss (including the cable(s) customer supplied) + Atten. Loss

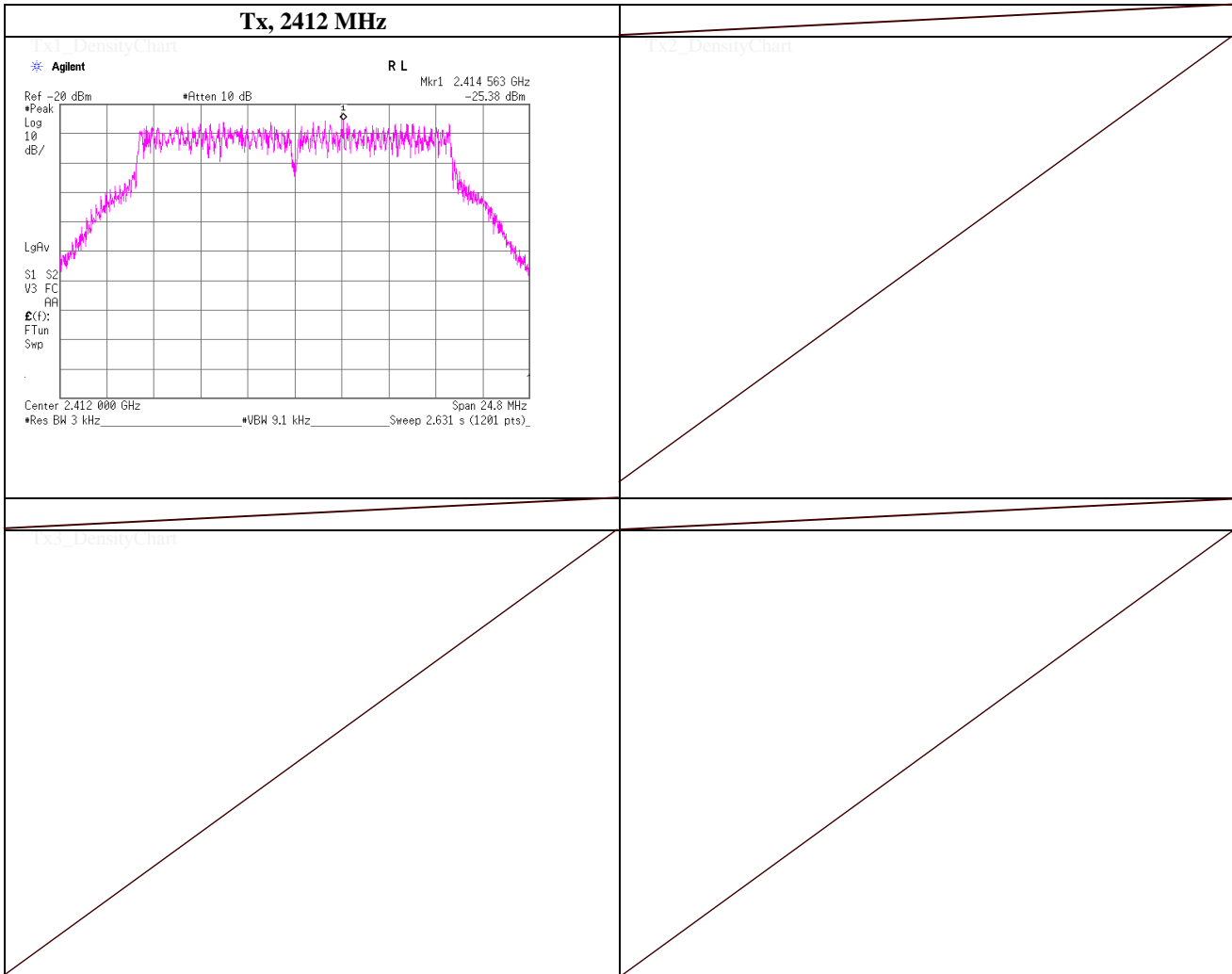

Maximum Power Spectral Density (PKPSD)

Test place	UL Japan, Inc. Shonan EMC Lab.	No.1 Measurement Room
Date	February 28, 2019	
Temperature / Humidity	23 deg.C , 55 %RH	
Engineer	Yosuke Ishikawa	
Mode	Tx, IEEE802.11g, PN9, worst antenna port 1, worst data mode 48 Mbps	

Ch. Freq. [MHz]	Freq. Reading [MHz]	Reading [dBm]	Cable Loss [dB]	Atten. [dB]	Result [dBm]	Limit [dBm]	Margin [dB]
2417.0000	2419.56	-25.23	2.41	10.18	-12.64	8.00	20.64
2437.0000	2439.55	-25.15	2.41	10.18	-12.56	8.00	20.56
2462.0000	2464.55	-25.47	2.42	10.18	-12.87	8.00	20.87

Sample Calculation:
Result = Reading + Cable Loss (including the cable(s) customer supplied) + Atten. Loss

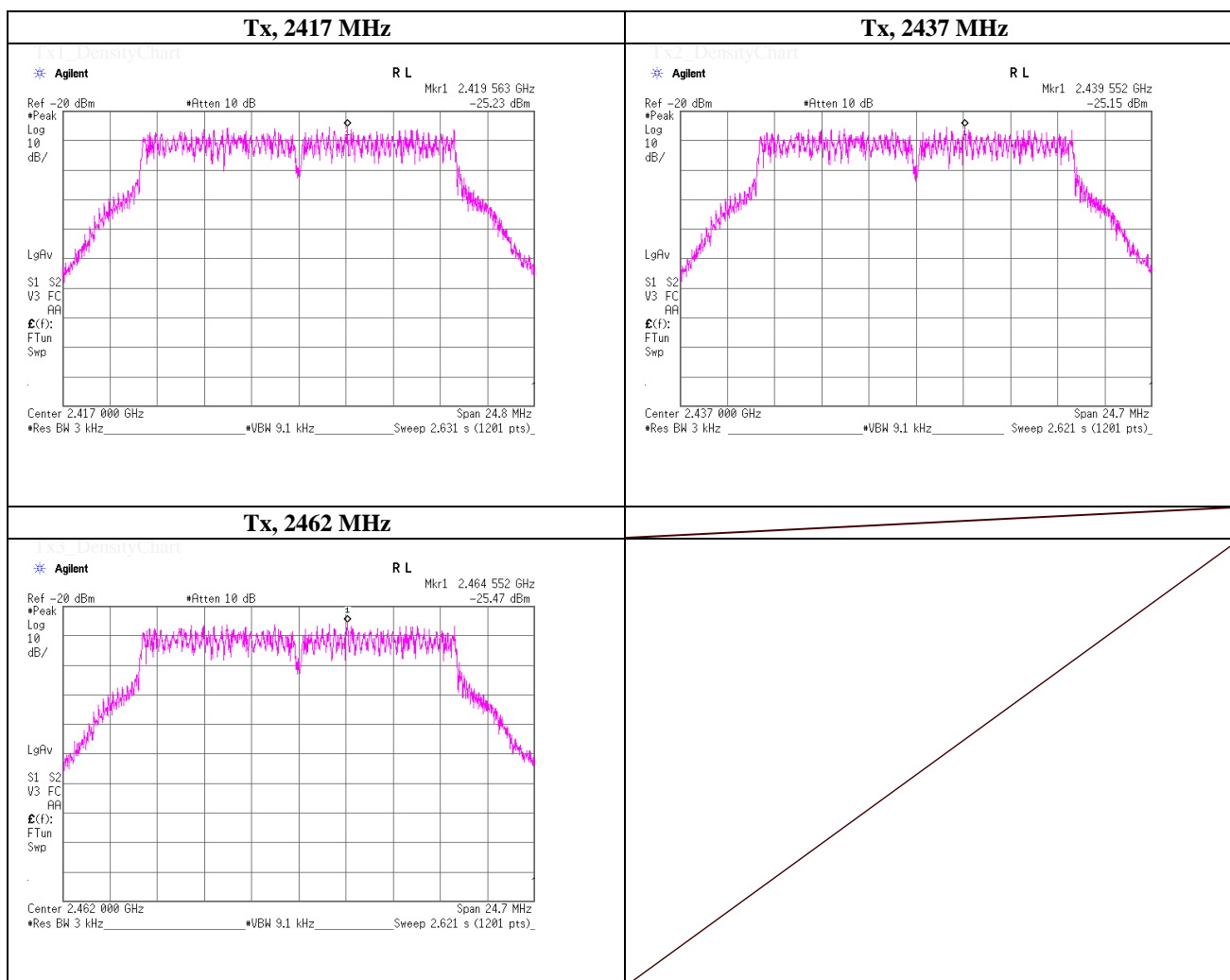

Maximum Power Spectral Density
(PKPSD)

Test place	UL Japan, Inc. Shonan EMC Lab.	No.1 Measurement Room
Date	February 28, 2019	
Temperature / Humidity	23 deg.C , 55 %RH	
Engineer	Yosuke Ishikawa	
Mode	Tx, IEEE802.11g, PN9, worst antenna port 1, worst data mode 48 Mbps	

Ch. Freq. [MHz]	Freq. Reading [MHz]	Reading [dBm]	Cable Loss [dB]	Atten. [dB]	Result [dBm]	Limit [dBm]	Margin [dB]
2467.0000	2469.56	-31.10	2.42	10.18	-18.50	8.00	26.50
2472.0000	2474.56	-35.63	2.42	10.18	-23.03	8.00	31.03

Sample Calculation:
Result = Reading + Cable Loss (including the cable(s) customer supplied) + Atten. Loss

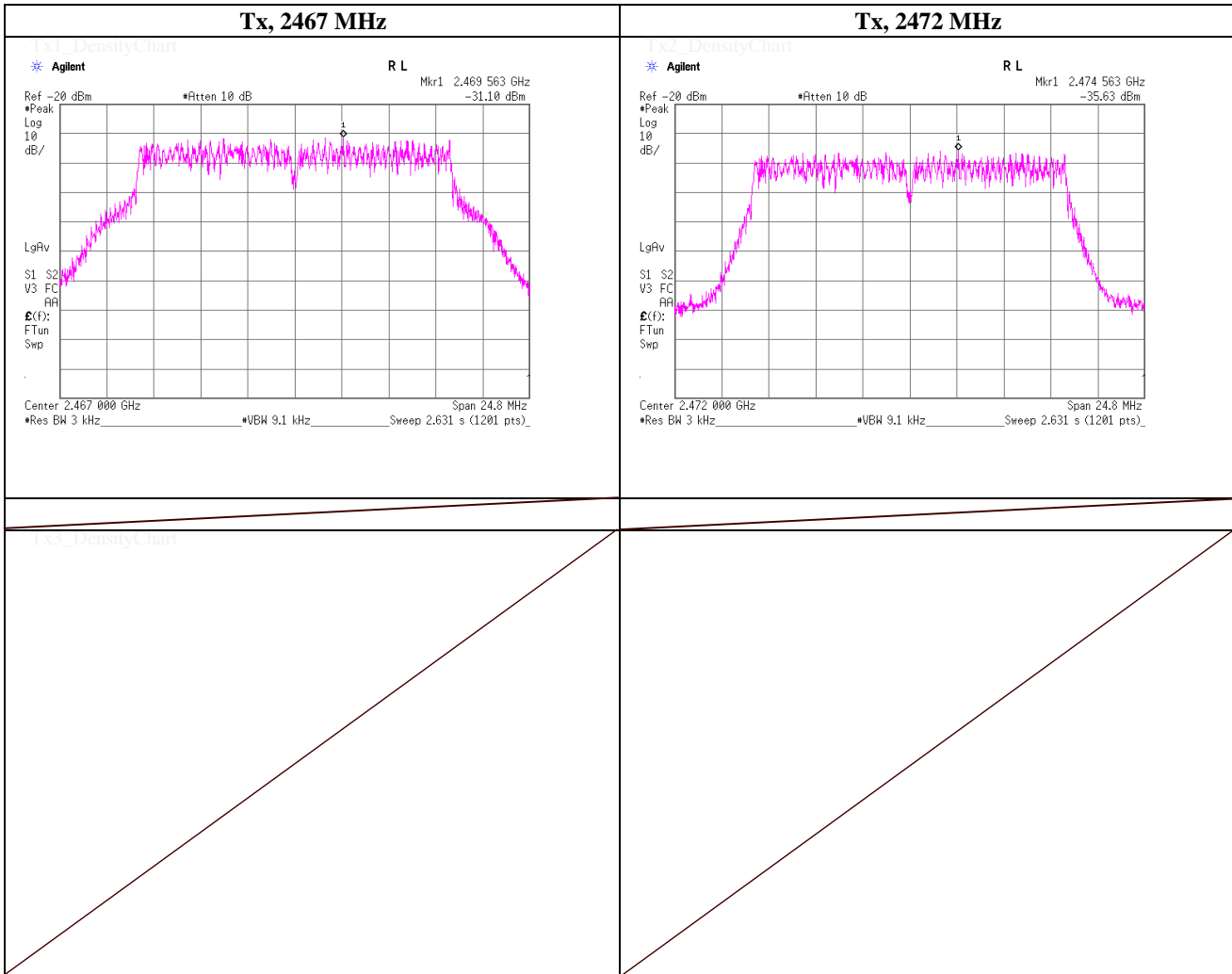

Maximum Power Spectral Density
(PKPSD)

Test place	UL Japan, Inc. Shonan EMC Lab.	No.1 Measurement Room
Date	February 28, 2019	
Temperature / Humidity	23 deg.C , 55 %RH	
Engineer	Yosuke Ishikawa	
Mode	Tx, IEEE802.11n HT20 (SISO), PN9, worst antenna port 1, worst data mode 4 (MCS)	

Ch. Freq. [MHz]	Freq. Reading [MHz]	Reading [dBm]	Cable Loss [dB]	Atten. [dB]	Result [dBm]	Limit [dBm]	Margin [dB]
2412.0000	2404.18	-22.76	2.41	10.18	-10.17	8.00	18.17

Sample Calculation:
Result = Reading + Cable Loss (including the cable(s) customer supplied) + Atten. Loss

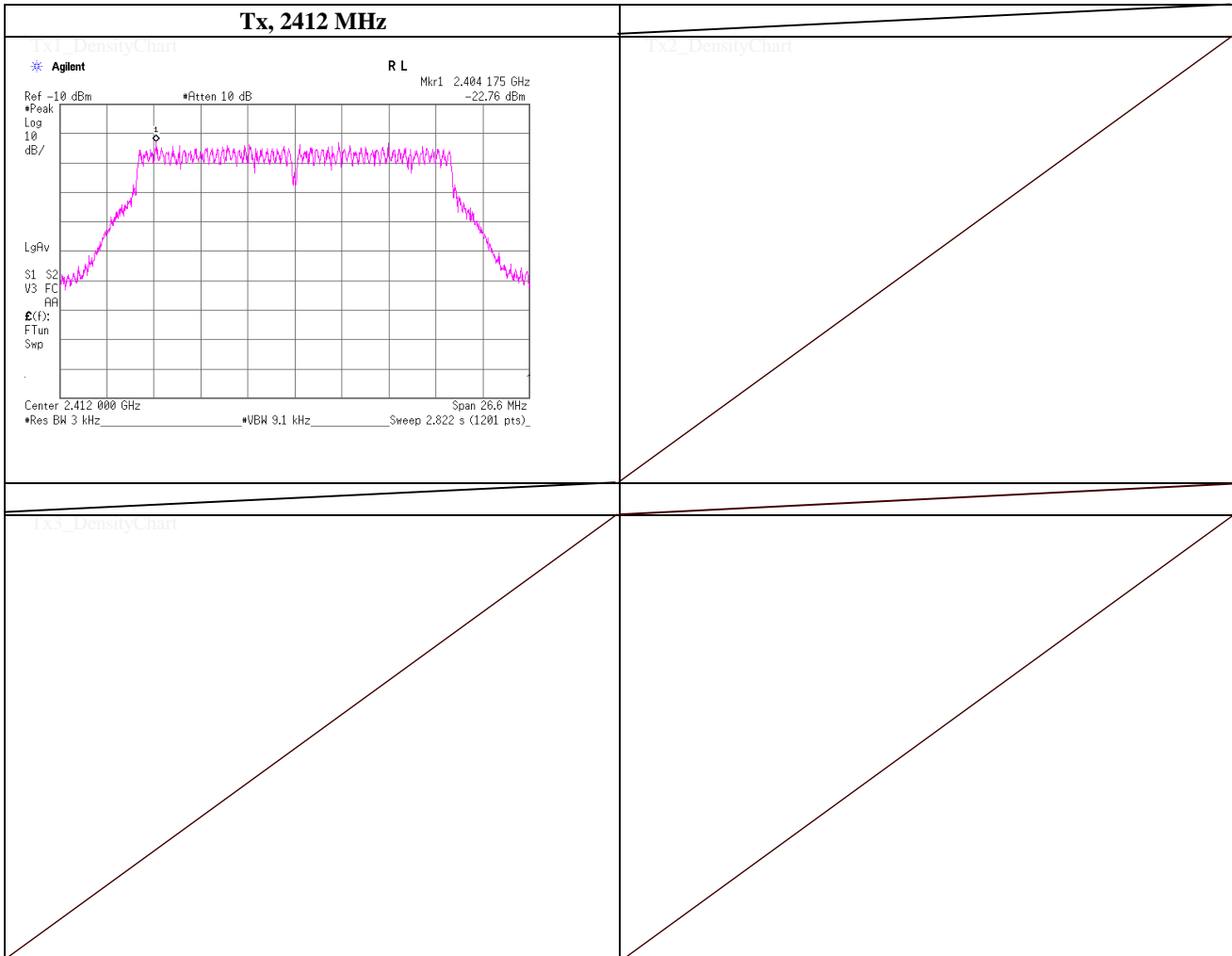

Maximum Power Spectral Density

(PKPSD)

Test place	UL Japan, Inc. Shonan EMC Lab.	No.1 Measurement Room
Date	February 28, 2019	
Temperature / Humidity	23 deg.C , 55 %RH	
Engineer	Yosuke Ishikawa	
Mode	Tx, IEEE802.11n HT20 (SISO), PN9, worst antenna port 1, worst data mode 3 (MCS)	

Ch. Freq. [MHz]	Freq. Reading [MHz]	Reading [dBm]	Cable Loss [dB]	Atten. [dB]	Result [dBm]	Limit [dBm]	Margin [dB]
2417.0000	2418.27	-22.01	2.41	10.18	-9.42	8.00	17.42
2437.0000	2429.52	-22.02	2.41	10.18	-9.43	8.00	17.43
2462.0000	2466.34	-22.22	2.42	10.18	-9.62	8.00	17.62

Sample Calculation:
Result = Reading + Cable Loss (including the cable(s) customer supplied) + Atten. Loss

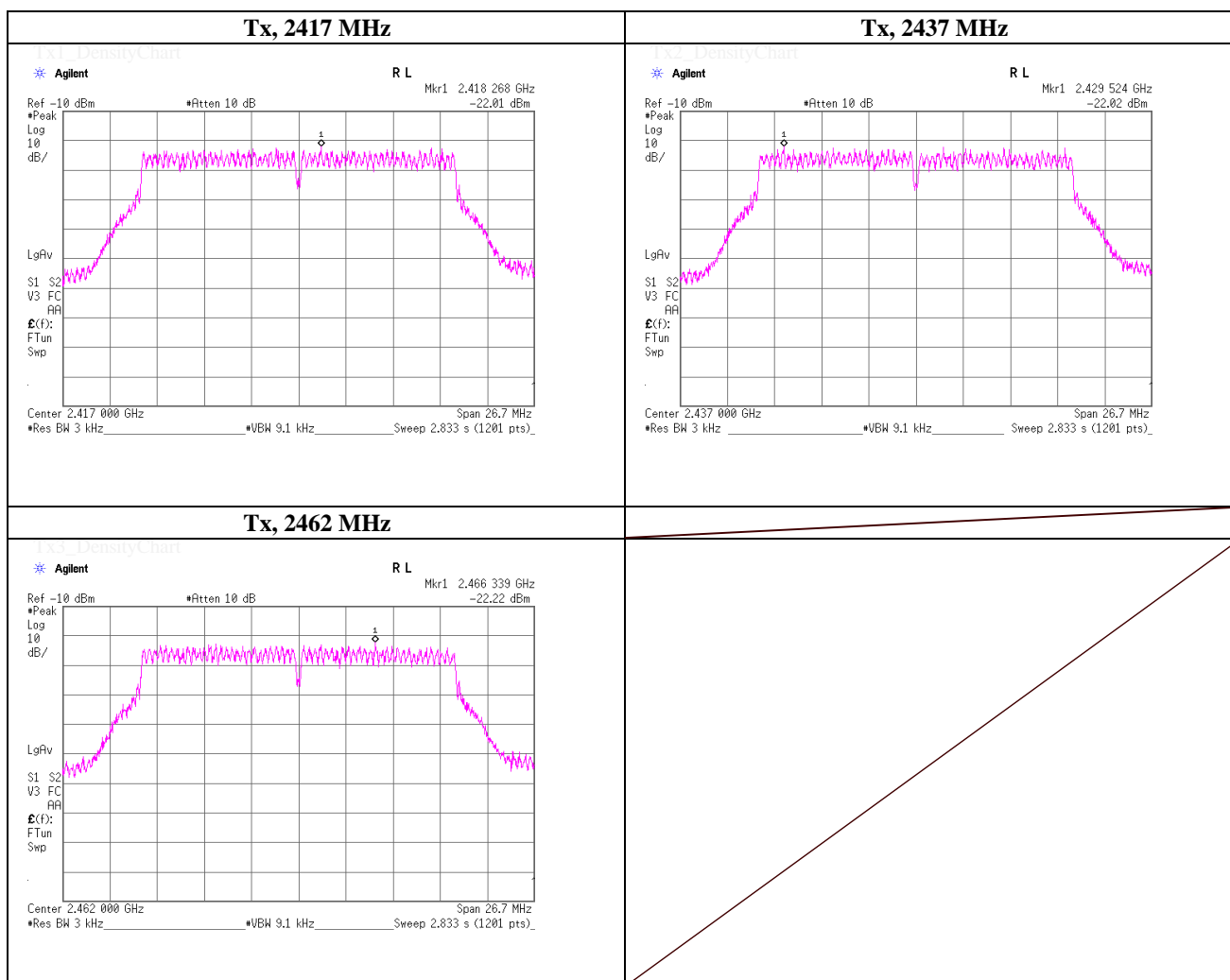

Maximum Power Spectral Density

(PKPSD)

Test place	UL Japan, Inc. Shonan EMC Lab.	No.1 Measurement Room
Date	February 28, 2019	
Temperature / Humidity	23 deg.C , 55 %RH	
Engineer	Yosuke Ishikawa	
Mode	Tx, IEEE802.11n HT20 (SISO), PN9, worst antenna port 1, worst data mode 3 (MCS)	

Ch. Freq. [MHz]	Freq. Reading [MHz]	Reading [dBm]	Cable Loss [dB]	Atten. [dB]	Result [dBm]	Limit [dBm]	Margin [dB]
2467.0000	2466.09	-29.36	2.42	10.18	-16.76	8.00	24.76
2472.0000	2474.44	-34.44	2.42	10.18	-21.84	8.00	29.84

Sample Calculation:
Result = Reading + Cable Loss (including the cable(s) customer supplied) + Atten. Loss

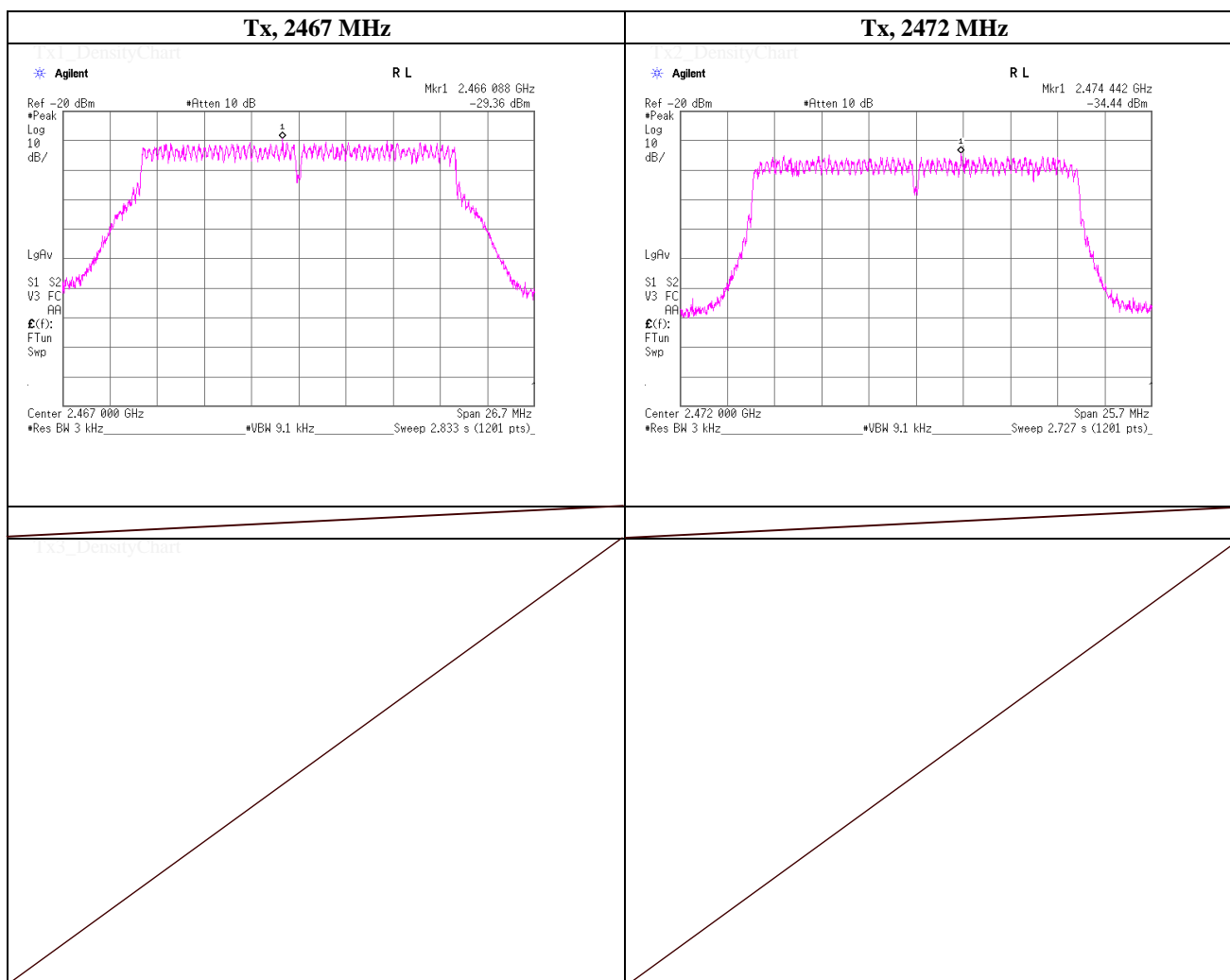

Maximum Power Spectral Density

(PKPSD)

Test place	UL Japan, Inc. Shonan EMC Lab.	No.1 Measurement Room
Date	February 28, 2019	
Temperature / Humidity	23 deg.C , 55 %RH	
Engineer	Yosuke Ishikawa	
Mode	Tx, OFDM VHT20 (SISO), PN9, worst antenna port 1, worst data mode 4 (MCS)	

Ch. Freq. [MHz]	Freq. Reading [MHz]	Reading [dBm]	Cable Loss [dB]	Atten. [dB]	Result [dBm]	Limit [dBm]	Margin [dB]
2412.0000	2413.27	-22.54	2.41	10.18	-9.95	8.00	17.95

Sample Calculation:
Result = Reading + Cable Loss (including the cable(s) customer supplied) + Atten. Loss

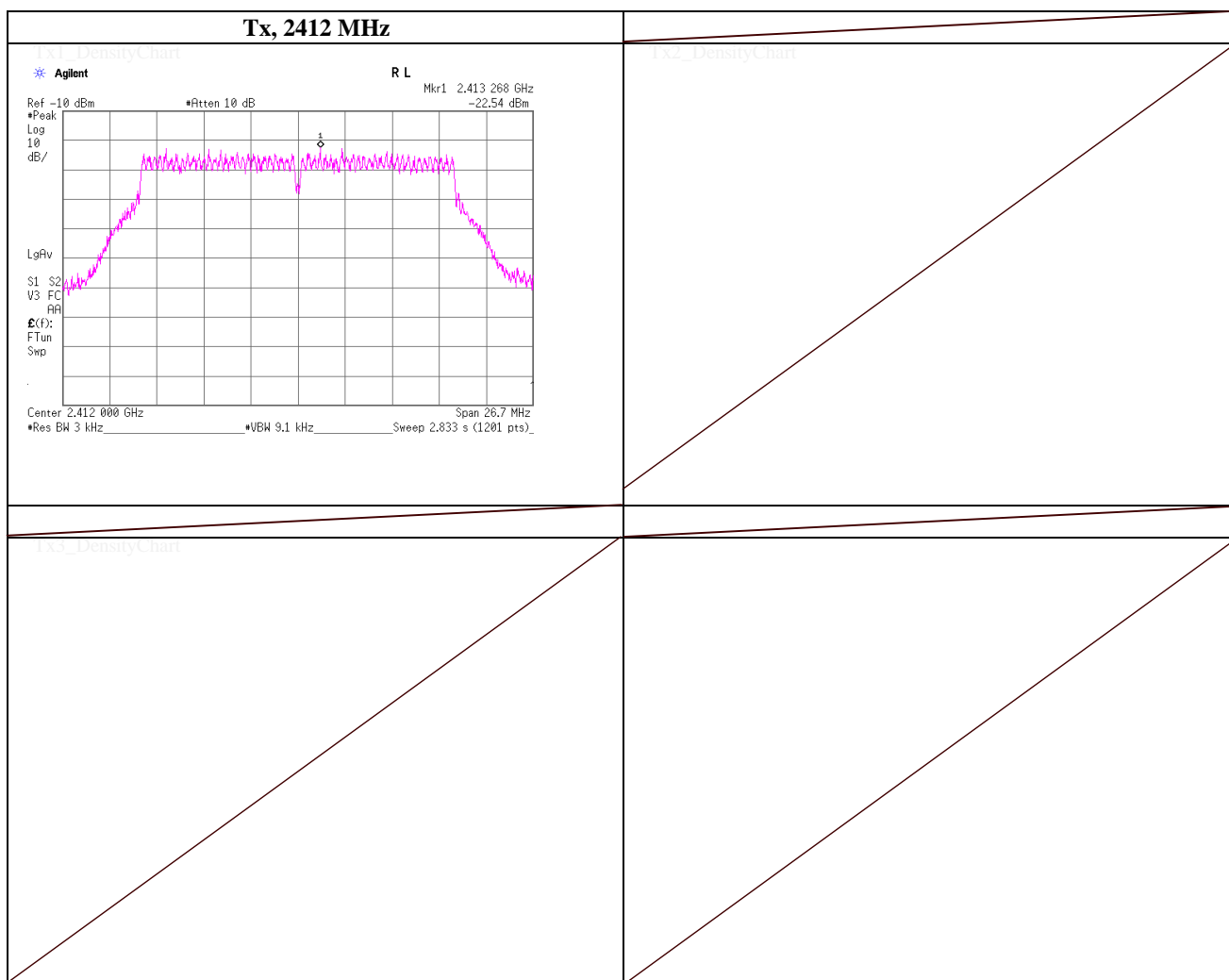

Maximum Power Spectral Density (PKPSD)

Test place	UL Japan, Inc. Shonan EMC Lab.	No.1 Measurement Room
Date	February 28, 2019	
Temperature / Humidity	23 deg.C , 55 %RH	
Engineer	Yosuke Ishikawa	
Mode	Tx, OFDM VHT20 (SISO), PN9, worst antenna port 1, worst data mode 3 (MCS)	

Ch. Freq. [MHz]	Freq. Reading [MHz]	Reading [dBm]	Cable Loss [dB]	Atten. [dB]	Result [dBm]	Limit [dBm]	Margin [dB]
2417.0000	2415.38	-21.74	2.41	10.18	-9.15	8.00	17.15
2437.0000	2432.02	-22.49	2.41	10.18	-9.90	8.00	17.90
2462.0000	2455.75	-22.01	2.42	10.18	-9.41	8.00	17.41

Sample Calculation:
Result = Reading + Cable Loss (including the cable(s) customer supplied) + Atten. Loss

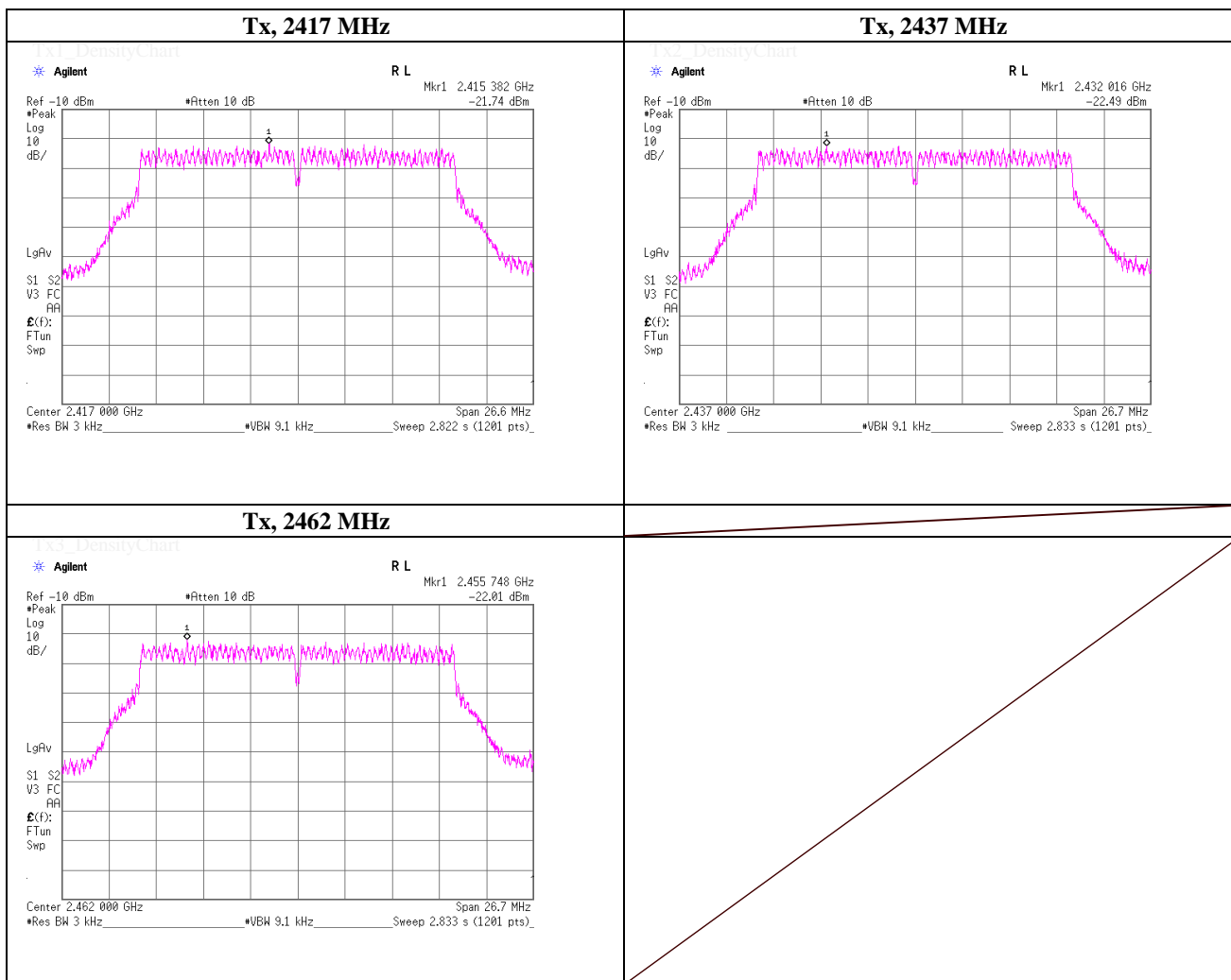

Maximum Power Spectral Density

(PKPSD)

Test place	UL Japan, Inc. Shonan EMC Lab.	No.1 Measurement Room
Date	February 28, 2019	
Temperature / Humidity	23 deg.C , 55 %RH	
Engineer	Yosuke Ishikawa	
Mode	Tx, OFDM VHT20 (SISO), PN9, worst antenna port 1, worst data mode 3 (MCS)	

Ch. Freq. [MHz]	Freq. Reading [MHz]	Reading [dBm]	Cable Loss [dB]	Atten. [dB]	Result [dBm]	Limit [dBm]	Margin [dB]
2467.0000	2472.92	-30.24	2.42	10.18	-17.64	8.00	25.64
2472.0000	2467.31	-34.52	2.42	10.18	-21.92	8.00	29.92

Sample Calculation:
Result = Reading + Cable Loss (including the cable(s) customer supplied) + Atten. Loss

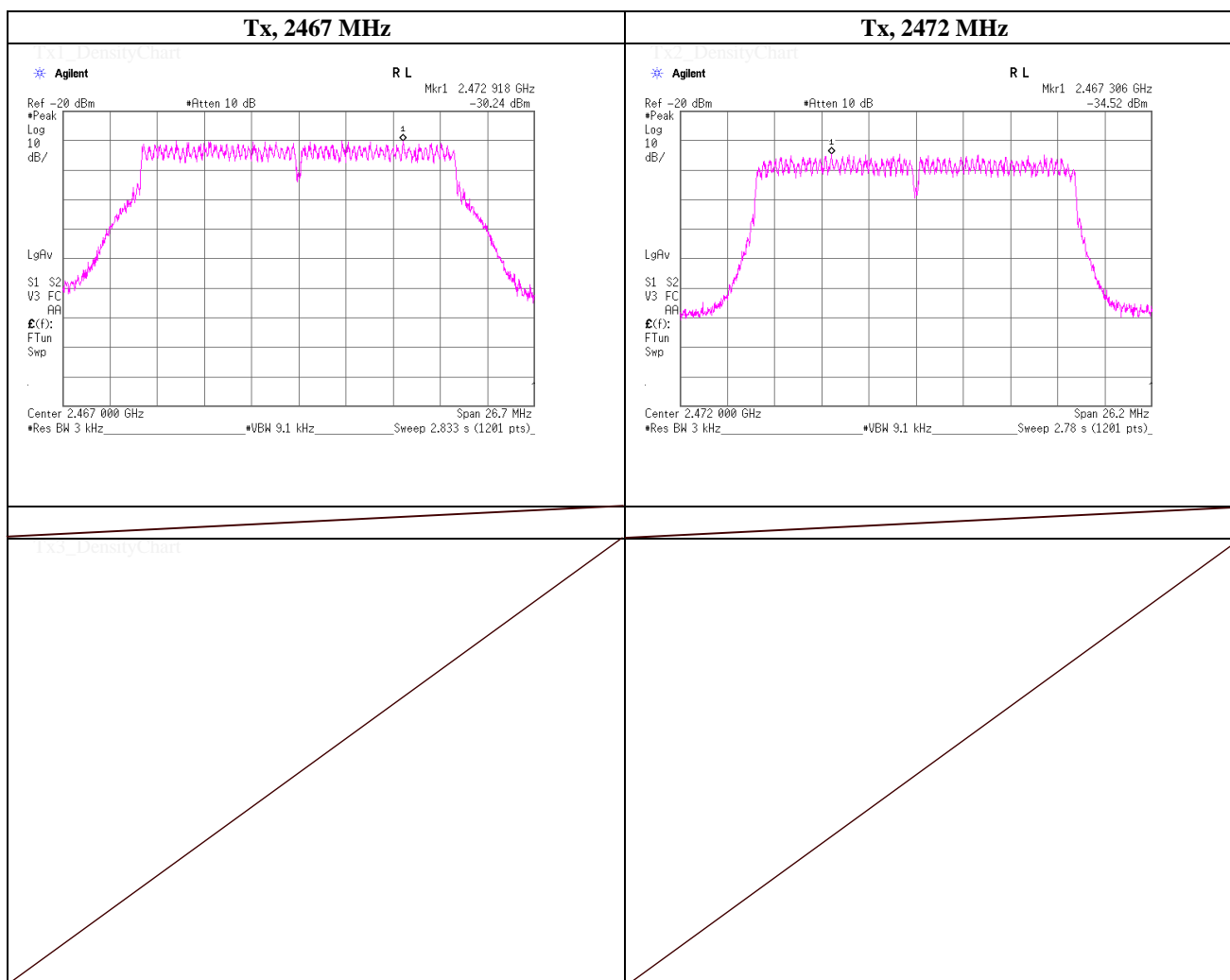

Maximum Power Spectral Density

(PKPSD)

Test place UL Japan, Inc. Shonan EMC Lab. No.1 Measurement Room
 Date March 1, 2019
 Temperature / Humidity 24 deg.C , 52 %RH
 Engineer Yosuke Ishikawa
 Mode Tx, IEEE802.11n HT20 (MIMO), PN9, worst data mode 14 (MCS)

Antenna 0

Ch. Freq. [MHz]	Freq. Reading [MHz]	Reading [dBm]	Cable Loss [dB]	Atten. [dB]	10log (N _{ANT})* [dB]	Result [dBm]	Limit [dBm]	Margin [dB]
2412.0000	2406.99	-28.34	2.41	10.18	3.01	-12.74	8.00	20.74

Sample Calculation:

Result = Reading + Cable Loss (including the cable(s) customer supplied) + Atten. Loss + 10log(NANT)

Antenna 1

Ch. Freq. [MHz]	Freq. Reading [MHz]	Reading [dBm]	Cable Loss [dB]	Atten. [dB]	10log (N _{ANT})* [dB]	Result [dBm]	Limit [dBm]	Margin [dB]
2412.0000	2413.29	-27.43	2.41	10.18	3.01	-11.83	8.00	19.83

Sample Calculation:

Result = Reading + Cable Loss (including the cable(s) customer supplied) + Atten. Loss + 10log(NANT)

*) This test was measured based on Method In-Band Power Spectral Density (PSD) Measurements (2) of
 "Emissions Testing of Transmitters with Multiple Outputs in the Same Band (KDB662911 D1)"

UL Japan, Inc.**Shonan EMC Lab.**

1-22-3 Megumigaoka, Hiratsuka-shi, Kanagawa 259-1220 JAPAN

Telephone : +81 463 50 6400

Facsimile : +81 463 50 6401

Power Density

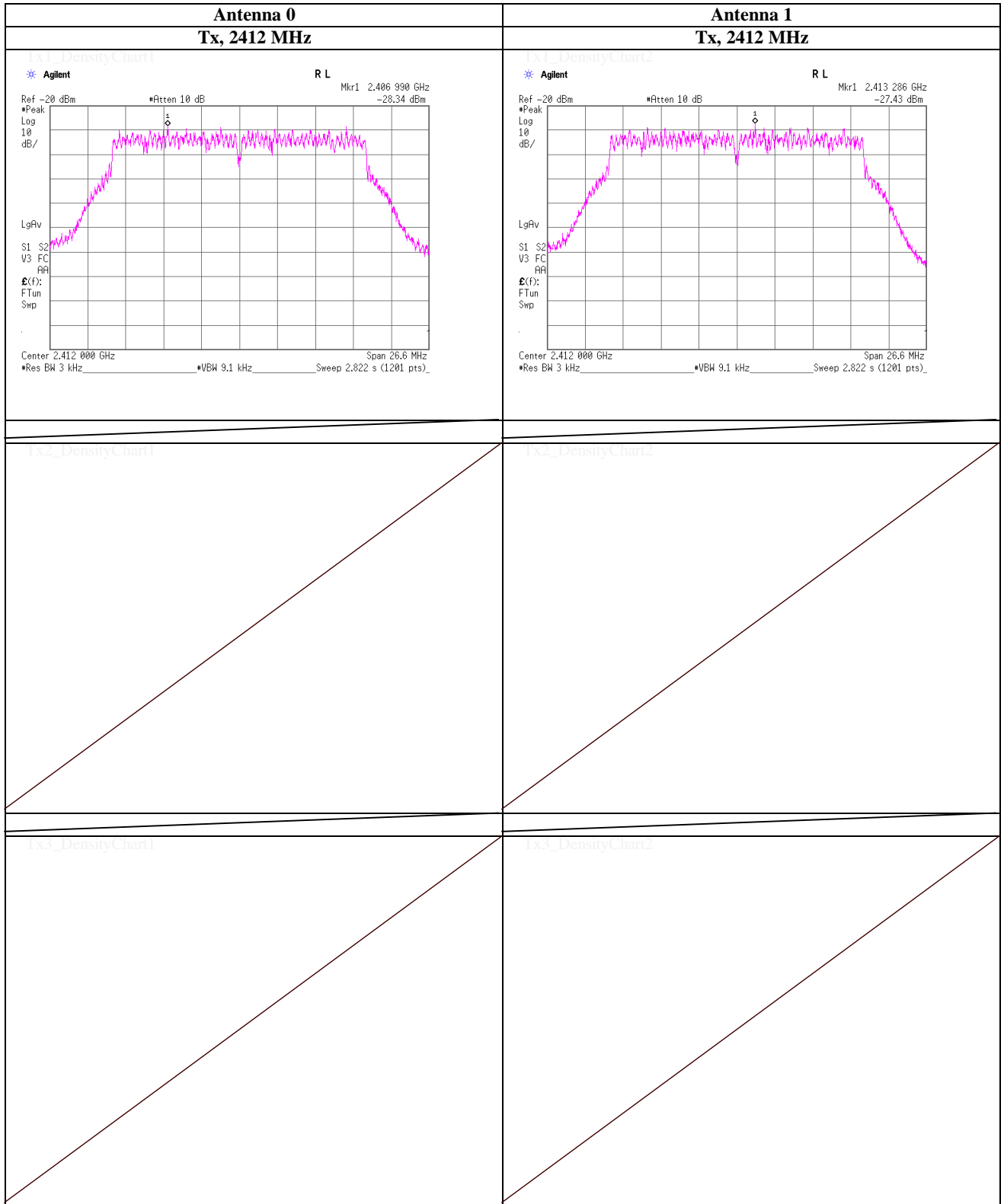

Maximum Power Spectral Density

(PKPSD)

Test place UL Japan, Inc. Shonan EMC Lab. No.1 Measurement Room
 Date March 1, 2019
 Temperature / Humidity 24 deg.C , 52 %RH
 Engineer Yosuke Ishikawa
 Mode Tx, IEEE802.11n HT20 (MIMO), PN9, worst data mode 14 (MCS)

Antenna 0

Ch. Freq. [MHz]	Freq. Reading [MHz]	Reading [dBm]	Cable Loss [dB]	Atten. [dB]	10log (N _{ANT})* [dB]	Result [dBm]	Limit [dBm]	Margin [dB]
2417.0000	2419.45	-27.80	2.41	10.18	3.01	-12.20	8.00	20.20
2437.0000	2444.50	-26.72	2.41	10.18	3.01	-11.12	8.00	19.12
2462.0000	2458.28	-28.39	2.42	10.18	3.01	-12.78	8.00	20.78

Sample Calculation:

Result = Reading + Cable Loss (including the cable(s) customer supplied) + Atten. Loss + 10log(NANT)

Antenna 1

Ch. Freq. [MHz]	Freq. Reading [MHz]	Reading [dBm]	Cable Loss [dB]	Atten. [dB]	10log (N _{ANT})* [dB]	Result [dBm]	Limit [dBm]	Margin [dB]
2417.0000	2410.73	-27.19	2.41	10.18	3.01	-11.59	8.00	19.59
2437.0000	2430.73	-26.53	2.41	10.18	3.01	-10.93	8.00	18.93
2462.0000	2466.99	-26.95	2.42	10.18	3.01	-11.34	8.00	19.34

Sample Calculation:

Result = Reading + Cable Loss (including the cable(s) customer supplied) + Atten. Loss + 10log(NANT)

*) This test was measured based on Method In-Band Power Spectral Density (PSD) Measurements (2) of
 "Emissions Testing of Transmitters with Multiple Outputs in the Same Band (KDB662911 D1)"

UL Japan, Inc.**Shonan EMC Lab.**

1-22-3 Megumigaoka, Hiratsuka-shi, Kanagawa 259-1220 JAPAN

Telephone : +81 463 50 6400

Facsimile : +81 463 50 6401

Power Density

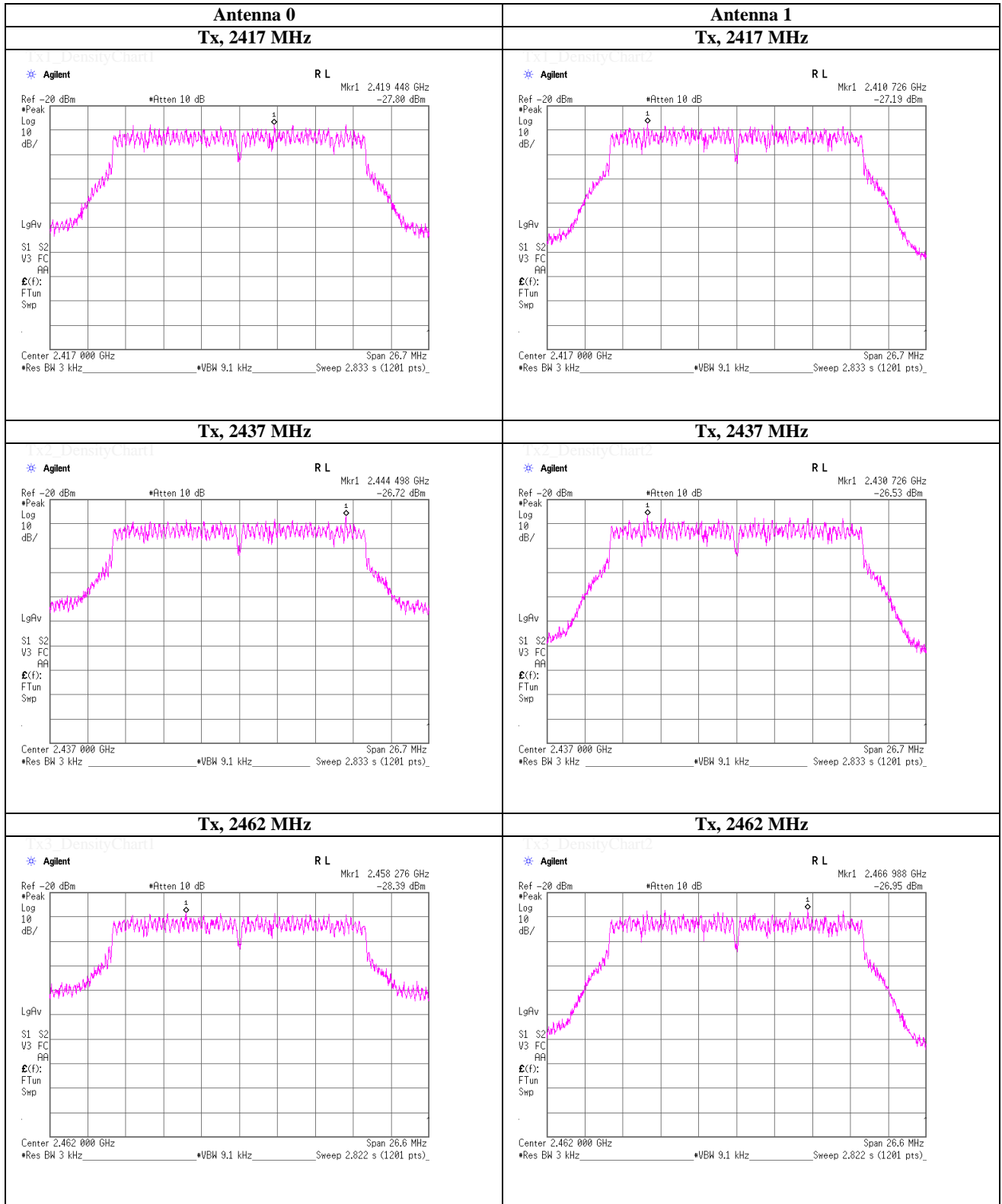

Maximum Power Spectral Density

(PKPSD)

Test place UL Japan, Inc. Shonan EMC Lab. No.1 Measurement Room
Date March 1, 2019
Temperature / Humidity 24 deg.C , 52 %RH
Engineer Yosuke Ishikawa
Mode Tx, IEEE802.11n HT20 (MIMO), PN9, worst data mode 14 (MCS)

Antenna 0

Ch. Freq. [MHz]	Freq. Reading [MHz]	Reading [dBm]	Cable Loss [dB]	Atten. [dB]	10log (N _{ANT})* [dB]	Result [dBm]	Limit [dBm]	Margin [dB]
2467.0000	2460.73	-34.69	2.42	10.18	3.01	-19.08	8.00	27.08
2472.0000	2479.50	-38.20	2.42	10.18	3.01	-22.59	8.00	30.59

Sample Calculation:

Result = Reading + Cable Loss (including the cable(s) customer supplied) + Atten. Loss + 10log(NANT)

Antenna 1

Ch. Freq. [MHz]	Freq. Reading [MHz]	Reading [dBm]	Cable Loss [dB]	Atten. [dB]	10log (N _{ANT})* [dB]	Result [dBm]	Limit [dBm]	Margin [dB]
2467.0000	2459.51	-33.21	2.42	10.18	3.01	-17.60	8.00	25.60
2472.0000	2473.28	-38.20	2.42	10.18	3.01	-22.59	8.00	30.59

Sample Calculation:

Result = Reading + Cable Loss (including the cable(s) customer supplied) + Atten. Loss + 10log(NANT)

*) This test was measured based on Method In-Band Power Spectral Density (PSD) Measurements (2) of
"Emissions Testing of Transmitters with Multiple Outputs in the Same Band (KDB662911 D1)"

UL Japan, Inc.**Shonan EMC Lab.**

1-22-3 Megumigaoka, Hiratsuka-shi, Kanagawa 259-1220 JAPAN

Telephone : +81 463 50 6400

Facsimile : +81 463 50 6401

Power Density

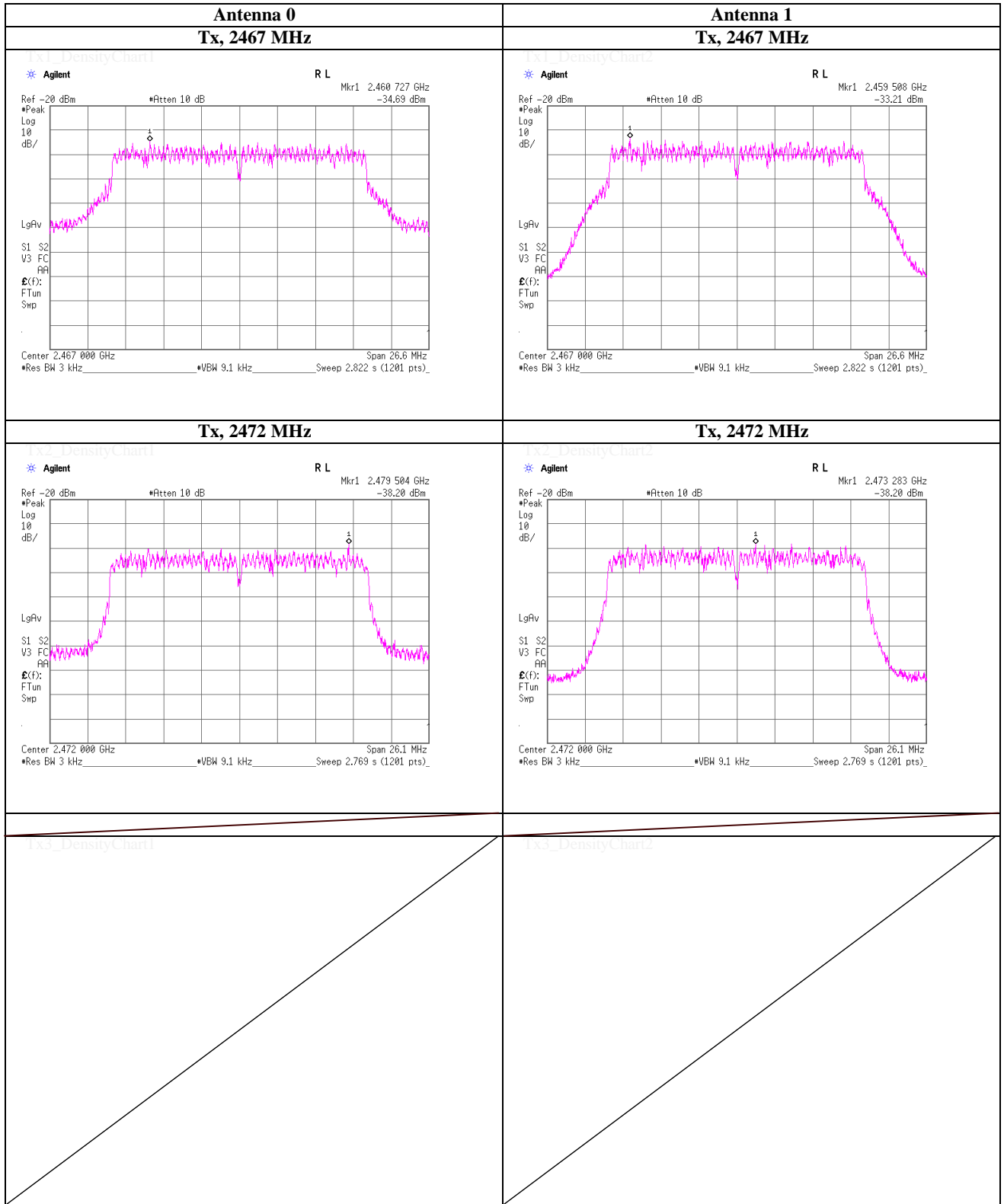

Maximum Power Spectral Density

(PKPSD)

Test place UL Japan, Inc. Shonan EMC Lab. No.1 Measurement Room
Date March 5, 2019
Temperature / Humidity 23 deg.C , 53 %RH
Engineer Kazutaka Takeyama
Mode Tx, OFDM VHT20 (MIMO), PN9, worst data mode 3 (MCS)

Antenna 0

Ch. Freq. [MHz]	Freq. Reading [MHz]	Reading [dBm]	Cable Loss [dB]	Atten. [dB]	10log (N _{ANT})* [dB]	Result [dBm]	Limit [dBm]	Margin [dB]
2412.0000	2418.89	-28.12	2.41	10.18	3.01	-12.52	8.00	20.52

Sample Calculation:

Result = Reading + Cable Loss (including the cable(s) customer supplied) + Atten. Loss + 10log(NANT)

Antenna 1

Ch. Freq. [MHz]	Freq. Reading [MHz]	Reading [dBm]	Cable Loss [dB]	Atten. [dB]	10log (N _{ANT})* [dB]	Result [dBm]	Limit [dBm]	Margin [dB]
2412.0000	2415.44	-26.96	2.41	10.18	3.01	-11.36	8.00	19.36

Sample Calculation:

Result = Reading + Cable Loss (including the cable(s) customer supplied) + Atten. Loss + 10log(NANT)

*) This test was measured based on Method In-Band Power Spectral Density (PSD) Measurements (2) of
"Emissions Testing of Transmitters with Multiple Outputs in the Same Band (KDB662911 D1)"

UL Japan, Inc.**Shonan EMC Lab.**

1-22-3 Megumigaoka, Hiratsuka-shi, Kanagawa 259-1220 JAPAN

Telephone : +81 463 50 6400

Facsimile : +81 463 50 6401

Power Density

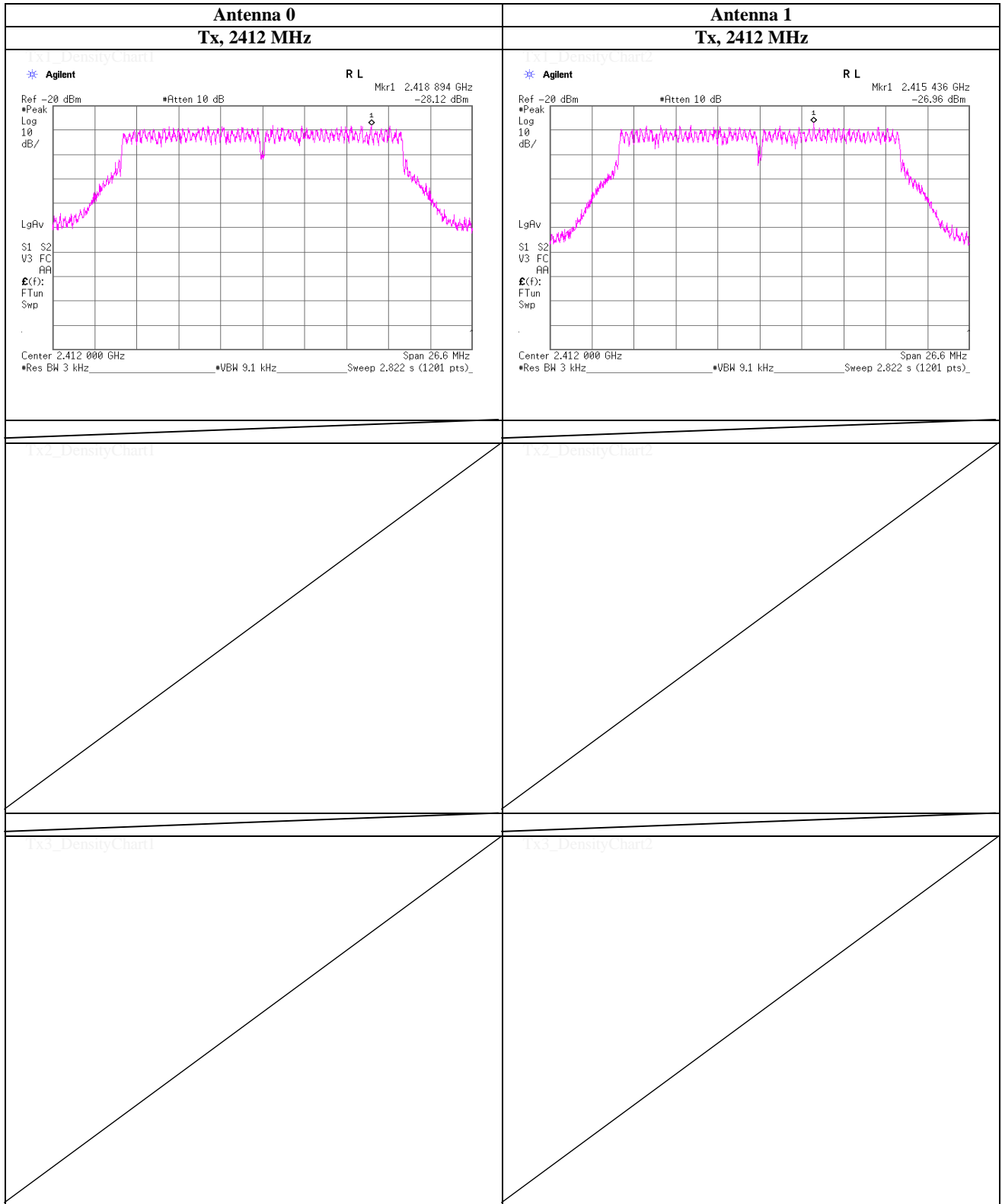

Maximum Power Spectral Density

(PKPSD)

Test place UL Japan, Inc. Shonan EMC Lab. No.1 Measurement Room
Date March 5, 2019
Temperature / Humidity 23 deg.C , 53 %RH
Engineer Kazutaka Takeyama
Mode Tx, OFDM VHT20 (MIMO), PN9, worst data mode 3 (MCS)

Antenna 0

Ch. Freq. [MHz]	Freq. Reading [MHz]	Reading [dBm]	Cable Loss [dB]	Atten. [dB]	10log (N _{ANT})* [dB]	Result [dBm]	Limit [dBm]	Margin [dB]
2417.0000	2413.23	-26.77	2.41	10.18	3.01	-11.17	8.00	19.17
2437.0000	2433.25	-26.71	2.41	10.18	3.01	-11.11	8.00	19.11
2462.0000	2458.52	-26.45	2.42	10.18	3.01	-10.84	8.00	18.84

Sample Calculation:

Result = Reading + Cable Loss (including the cable(s) customer supplied) + Atten. Loss + 10log(NANT)

Antenna 1

Ch. Freq. [MHz]	Freq. Reading [MHz]	Reading [dBm]	Cable Loss [dB]	Atten. [dB]	10log (N _{ANT})* [dB]	Result [dBm]	Limit [dBm]	Margin [dB]
2417.0000	2411.97	-25.49	2.41	10.18	3.01	-9.89	8.00	17.89
2437.0000	2439.51	-27.05	2.41	10.18	3.01	-11.45	8.00	19.45
2462.0000	2456.95	-25.84	2.42	10.18	3.01	-10.23	8.00	18.23

Sample Calculation:

Result = Reading + Cable Loss (including the cable(s) customer supplied) + Atten. Loss + 10log(NANT)

*) This test was measured based on Method In-Band Power Spectral Density (PSD) Measurements (2) of
"Emissions Testing of Transmitters with Multiple Outputs in the Same Band (KDB662911 D1)"

UL Japan, Inc.**Shonan EMC Lab.**

1-22-3 Megumigaoka, Hiratsuka-shi, Kanagawa 259-1220 JAPAN

Telephone : +81 463 50 6400

Facsimile : +81 463 50 6401

Power Density

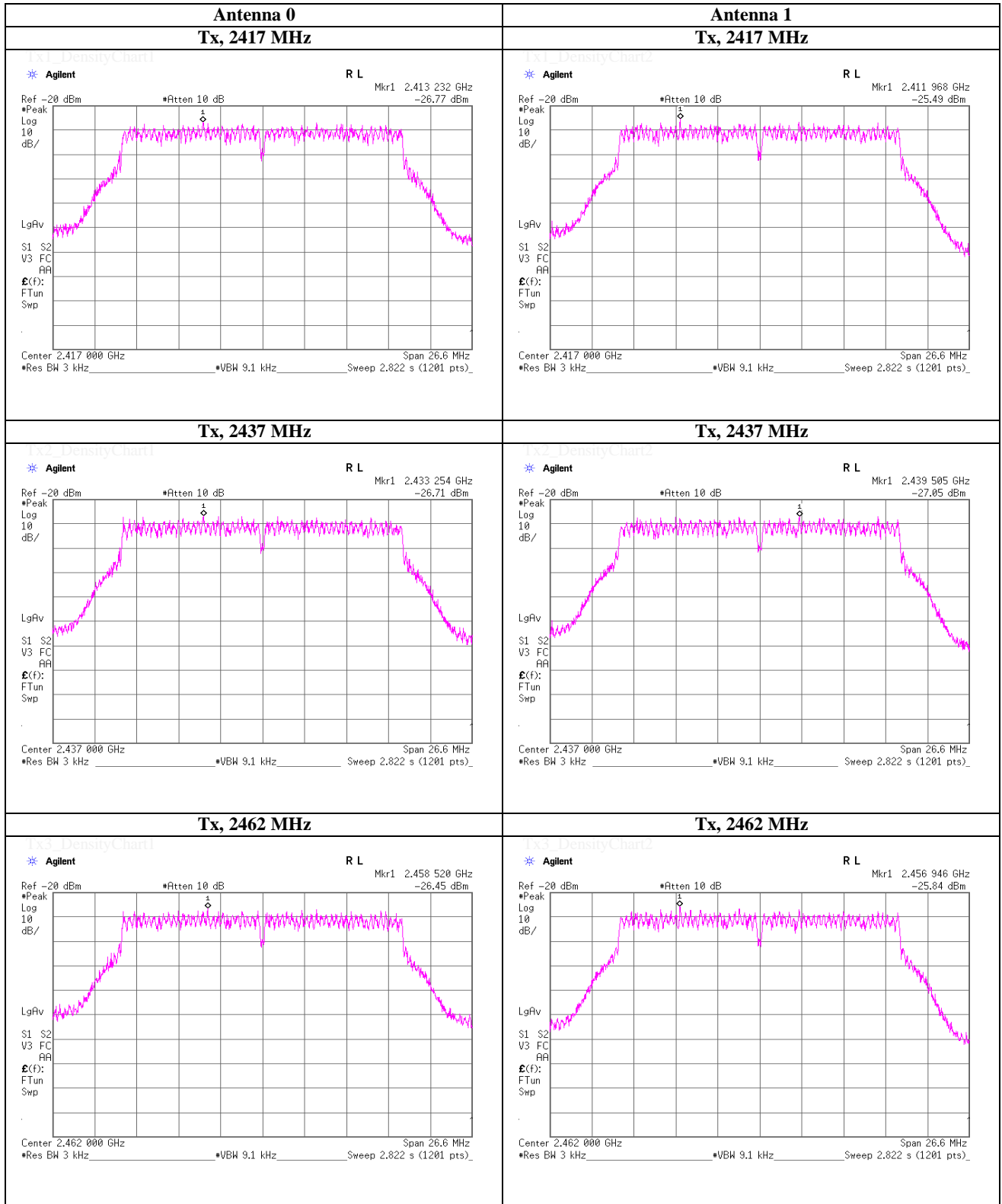

Maximum Power Spectral Density

(PKPSD)

Test place UL Japan, Inc. Shonan EMC Lab. No.1 Measurement Room
 Date March 5, 2019
 Temperature / Humidity 23 deg.C , 53 %RH
 Engineer Kazutaka Takeyama
 Mode Tx, OFDM VHT20 (MIMO), PN9, worst data mode 3 (MCS)

Antenna 0

Ch. Freq. [MHz]	Freq. Reading [MHz]	Reading [dBm]	Cable Loss [dB]	Atten. [dB]	10log (N _{ANT})* [dB]	Result [dBm]	Limit [dBm]	Margin [dB]
2467.0000	2469.49	-34.38	2.42	10.18	3.01	-18.77	8.00	26.77
2472.0000	2469.18	-38.77	2.42	10.18	3.01	-23.16	8.00	31.16

Sample Calculation:

Result = Reading + Cable Loss (including the cable(s) customer supplied) + Atten. Loss + 10log(NANT)

Antenna 1

Ch. Freq. [MHz]	Freq. Reading [MHz]	Reading [dBm]	Cable Loss [dB]	Atten. [dB]	10log (N _{ANT})* [dB]	Result [dBm]	Limit [dBm]	Margin [dB]
2467.0000	2461.95	-32.11	2.42	10.18	3.01	-16.50	8.00	24.50
2472.0000	2475.42	-37.10	2.42	10.18	3.01	-21.49	8.00	29.49

Sample Calculation:

Result = Reading + Cable Loss (including the cable(s) customer supplied) + Atten. Loss + 10log(NANT)

*) This test was measured based on Method In-Band Power Spectral Density (PSD) Measurements (2) of
 "Emissions Testing of Transmitters with Multiple Outputs in the Same Band (KDB662911 D1)"

UL Japan, Inc.**Shonan EMC Lab.**

1-22-3 Megumigaoka, Hiratsuka-shi, Kanagawa 259-1220 JAPAN

Telephone : +81 463 50 6400

Facsimile : +81 463 50 6401

Power Density

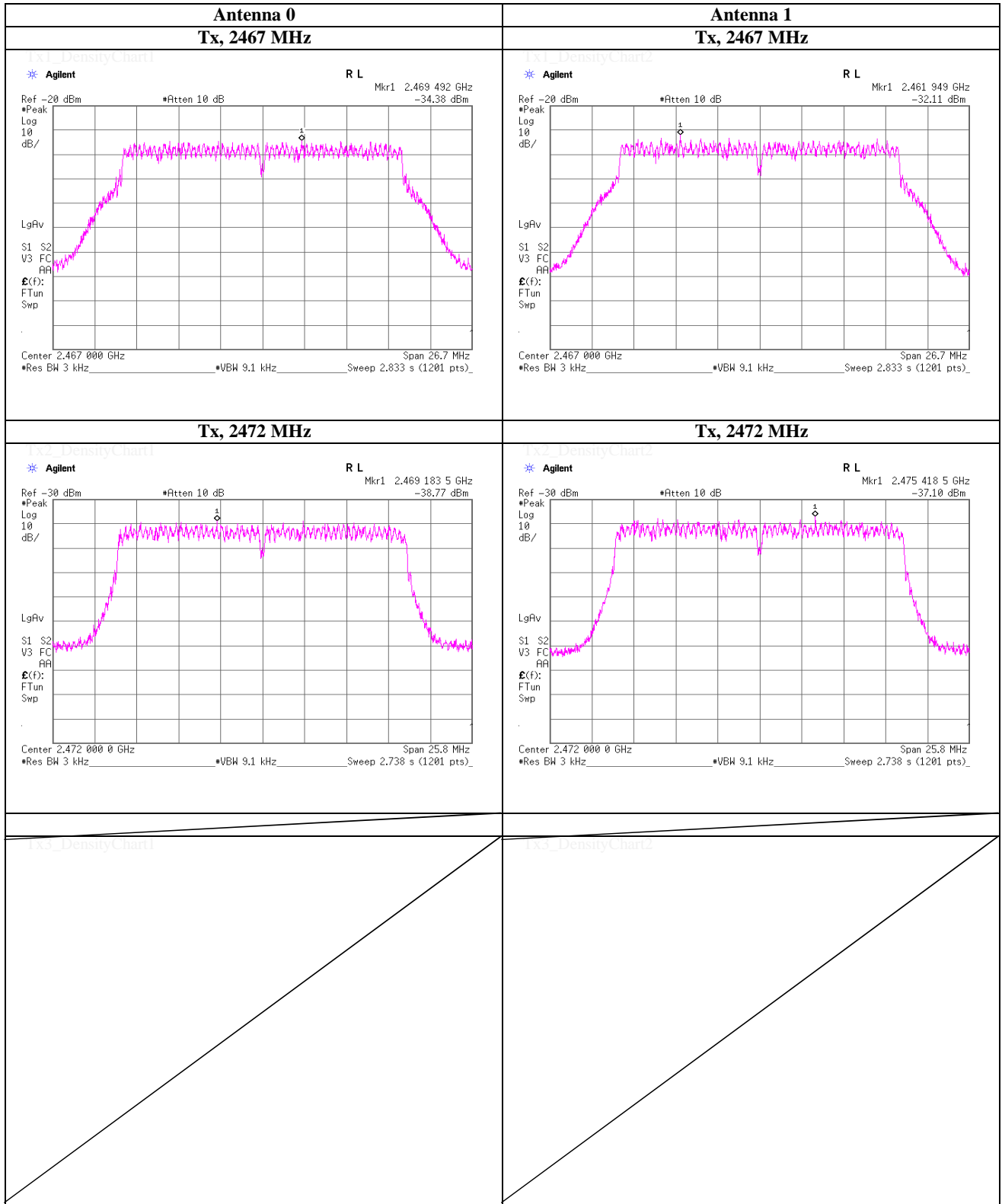

Maximum Power Spectral Density (PKPSD)

Test place	UL Japan, Inc. Shonan EMC Lab.	No.1 Measurement Room
Date	March 1, 2019	
Temperature / Humidity	24 deg.C , 52 %RH	
Engineer	Yosuke Ishikawa	
Mode	Tx, IEEE802.11n HT40 (SISO), PN9, worst antenna port 1, worst data mode 6 (MCS)	

Ch. Freq. [MHz]	Freq. Reading [MHz]	Reading [dBm]	Cable Loss [dB]	Atten. [dB]	Result [dBm]	Limit [dBm]	Margin [dB]
2422.0000	2416.98	-34.02	2.41	10.18	-21.43	8.00	29.43
2437.0000	2434.49	-32.81	2.41	10.18	-20.22	8.00	28.22
2452.0000	2446.98	-33.46	2.42	10.18	-20.86	8.00	28.86

Sample Calculation:
Result = Reading + Cable Loss (including the cable(s) customer supplied) + Atten. Loss

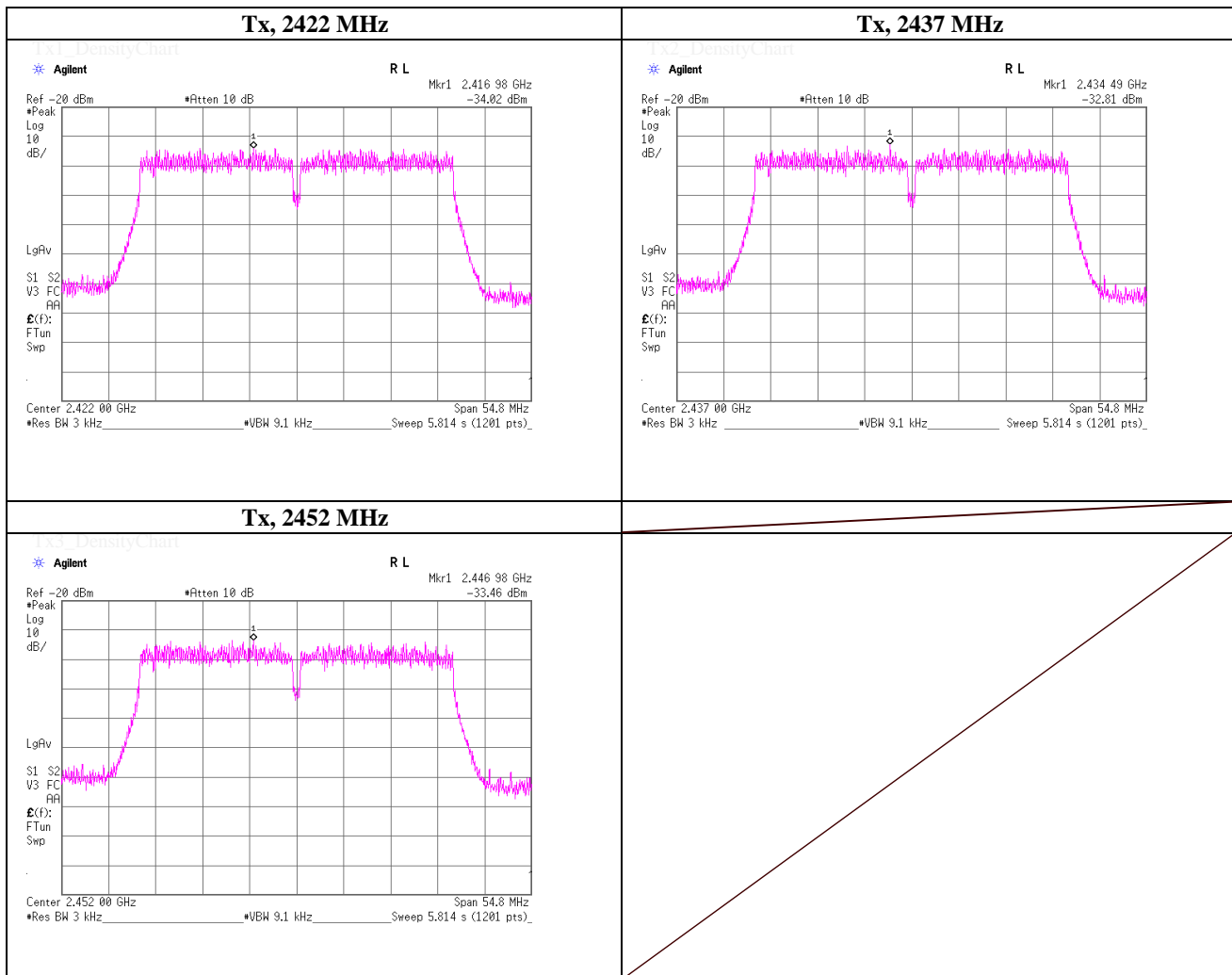

Maximum Power Spectral Density

(PKPSD)

Test place	UL Japan, Inc. Shonan EMC Lab.	No.1 Measurement Room
Date	March 1, 2019	
Temperature / Humidity	24 deg.C , 52 %RH	
Engineer	Yosuke Ishikawa	
Mode	Tx, IEEE802.11n HT40 (SISO), PN9, worst antenna port 1, worst data mode 6 (MCS)	

Ch. Freq. [MHz]	Freq. Reading [MHz]	Reading [dBm]	Cable Loss [dB]	Atten. [dB]	Result [dBm]	Limit [dBm]	Margin [dB]
2457.0000	2451.97	-32.91	2.42	10.18	-20.31	8.00	28.31
2462.0000	2446.95	-33.02	2.42	10.18	-20.42	8.00	28.42

Sample Calculation:
Result = Reading + Cable Loss (including the cable(s) customer supplied) + Atten. Loss

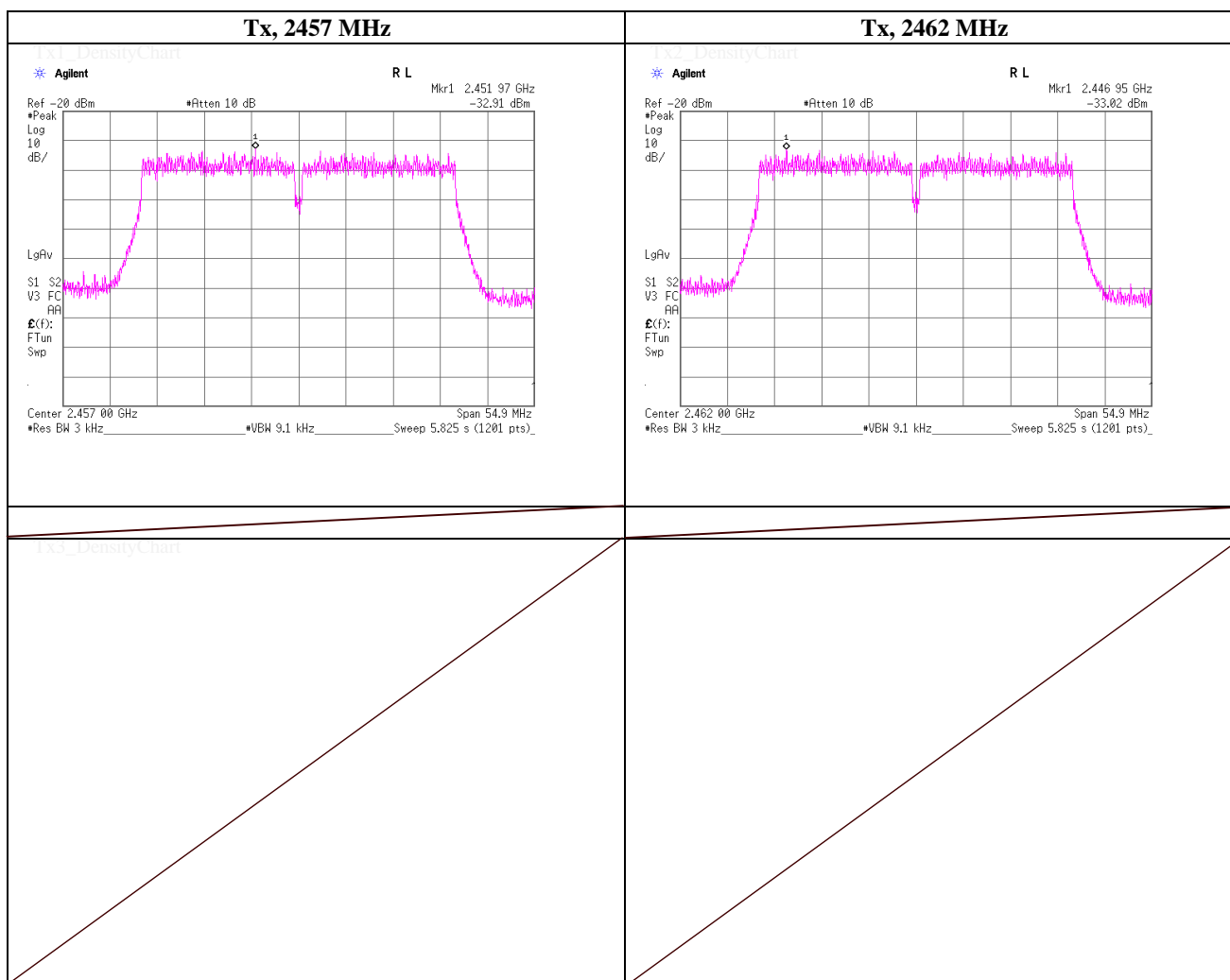

Maximum Power Spectral Density (PKPSD)

Test place	UL Japan, Inc. Shonan EMC Lab.	No.1 Measurement Room
Date	March 1, 2019	
Temperature / Humidity	24 deg.C , 52 %RH	
Engineer	Yosuke Ishikawa	
Mode	Tx, OFDM VHT40 (SISO), PN9, worst antenna port 1, worst data mode 4 (MCS)	

Ch. Freq. [MHz]	Freq. Reading [MHz]	Reading [dBm]	Cable Loss [dB]	Atten. [dB]	Result [dBm]	Limit [dBm]	Margin [dB]
2422.0000	2434.51	-32.79	2.41	10.18	-20.20	8.00	28.20
2437.0000	2445.71	-32.50	2.41	10.18	-19.91	8.00	27.91
2452.0000	2440.72	-33.25	2.42	10.18	-20.65	8.00	28.65

Sample Calculation:
Result = Reading + Cable Loss (including the cable(s) customer supplied) + Atten. Loss

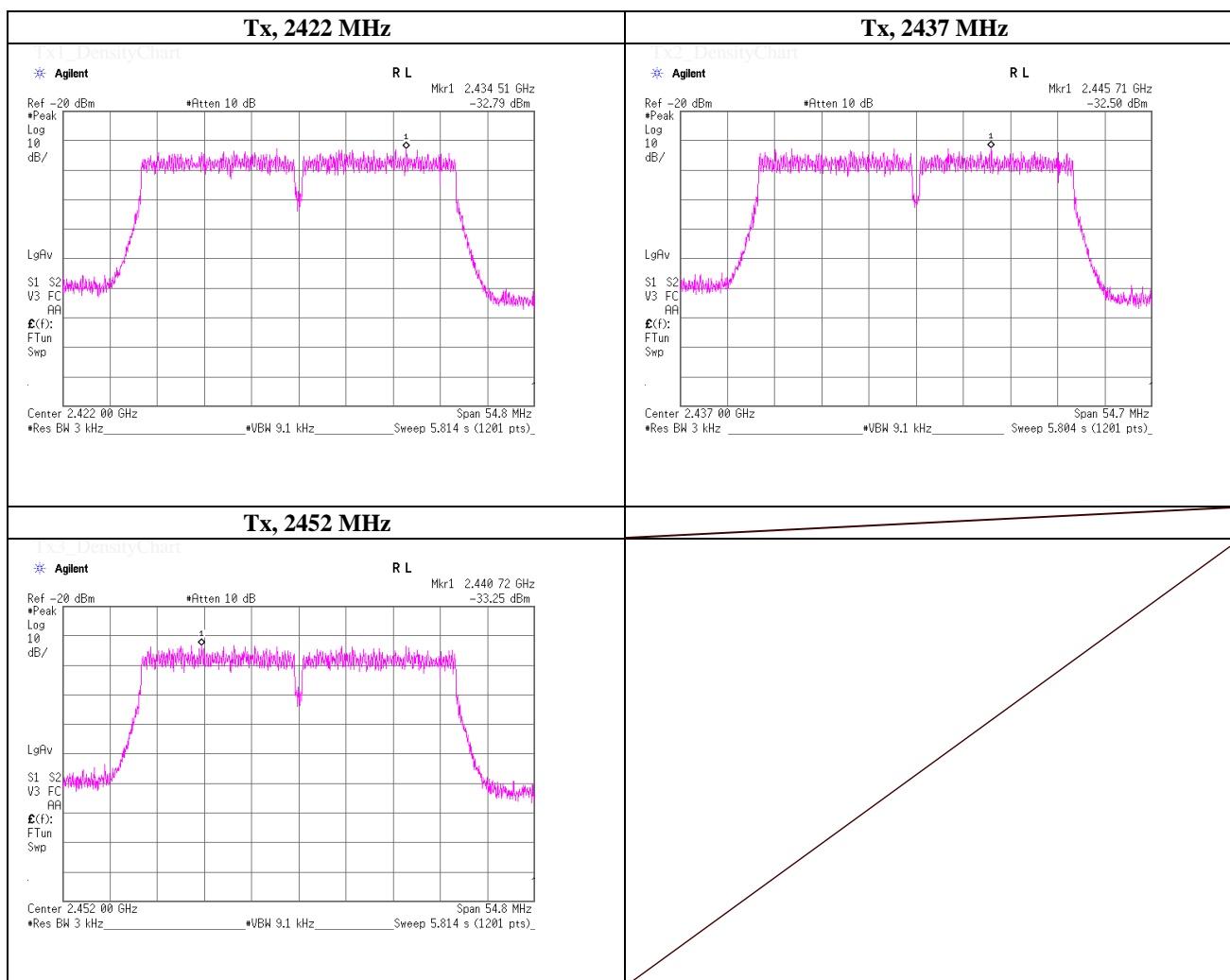

Maximum Power Spectral Density

(PKPSD)

Test place	UL Japan, Inc. Shonan EMC Lab.	No.1 Measurement Room
Date	March 1, 2019	
Temperature / Humidity	24 deg.C , 52 %RH	
Engineer	Yosuke Ishikawa	
Mode	Tx, OFDM VHT40 (SISO), PN9, worst antenna port 1, worst data mode 4 (MCS)	

Ch. Freq. [MHz]	Freq. Reading [MHz]	Reading [dBm]	Cable Loss [dB]	Atten. [dB]	Result [dBm]	Limit [dBm]	Margin [dB]
2457.0000	2445.70	-32.04	2.42	10.18	-19.44	8.00	27.44
2462.0000	2457.93	-31.97	2.42	10.18	-19.37	8.00	27.37

Sample Calculation:
Result = Reading + Cable Loss (including the cable(s) customer supplied) + Atten. Loss

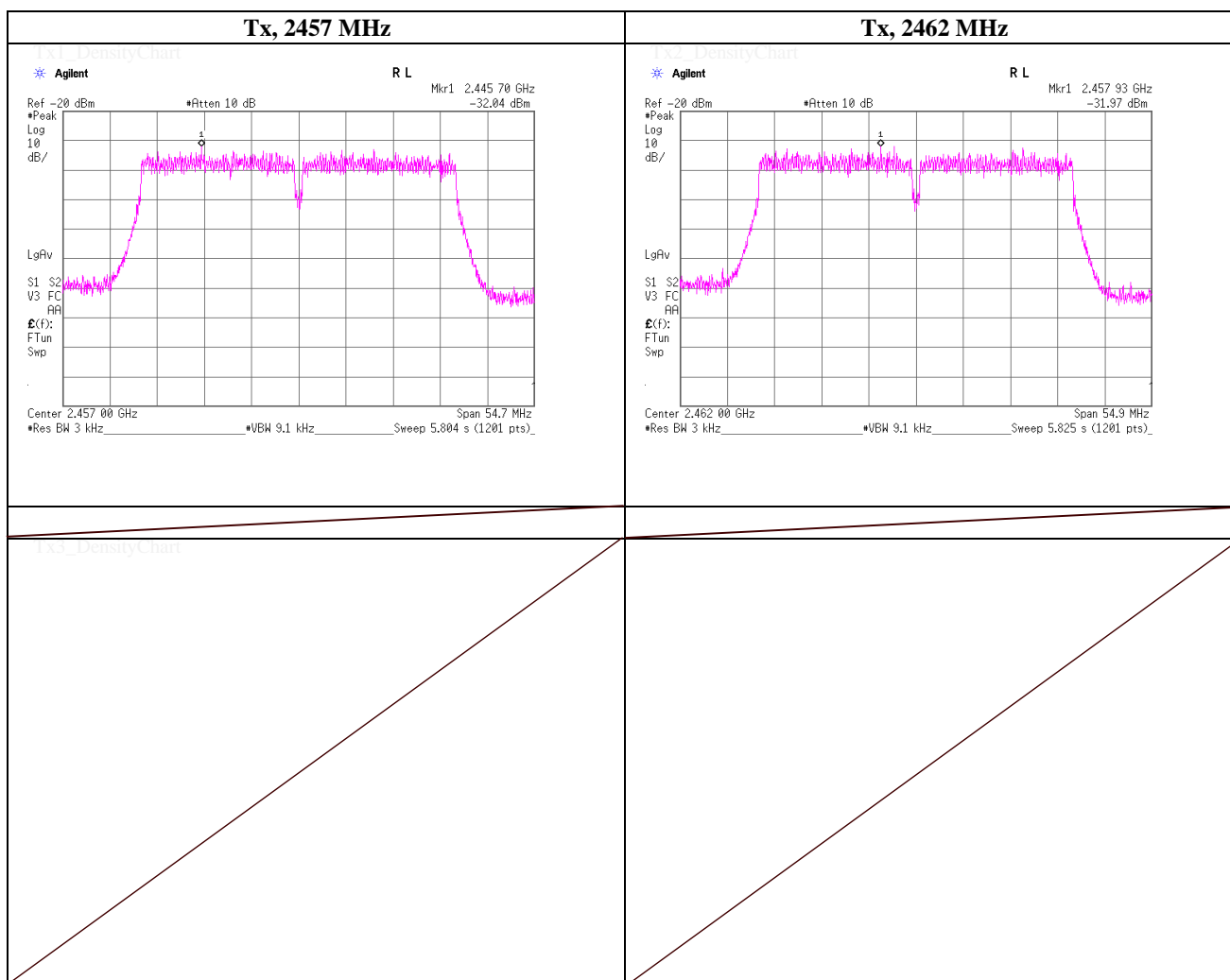

Maximum Power Spectral Density

(PKPSD)

Test place	UL Japan, Inc. Shonan EMC Lab.	No.1 Measurement Room
Date	March 5, 2019	
Temperature / Humidity	23 deg.C , 53 %RH	
Engineer	Kazutaka Takeyama	
Mode	Tx, IEEE802.11n HT40 (MIMO), PN9, worst data mode 11 (MCS)	

Antenna 0

Ch. Freq. [MHz]	Freq. Reading [MHz]	Reading [dBm]	Cable Loss [dB]	Atten. [dB]	10log (N _{ANT})* [dB]	Result [dBm]	Limit [dBm]	Margin [dB]
2422.0000	2424.51	-34.15	2.41	10.18	3.01	-18.55	8.00	26.55
2437.0000	2428.23	-34.26	2.41	10.18	3.01	-18.66	8.00	26.66
2452.0000	2446.93	-34.18	2.42	10.18	3.01	-18.57	8.00	26.57

Sample Calculation:

Result = Reading + Cable Loss (including the cable(s) customer supplied) + Atten. Loss + 10log(NANT)

Antenna 1

Ch. Freq. [MHz]	Freq. Reading [MHz]	Reading [dBm]	Cable Loss [dB]	Atten. [dB]	10log (N _{ANT})* [dB]	Result [dBm]	Limit [dBm]	Margin [dB]
2422.0000	2425.74	-33.14	2.41	10.18	3.01	-17.54	8.00	25.54
2437.0000	2440.74	-33.50	2.41	10.18	3.01	-17.90	8.00	25.90
2452.0000	2455.74	-33.93	2.42	10.18	3.01	-18.32	8.00	26.32

Sample Calculation:

Result = Reading + Cable Loss (including the cable(s) customer supplied) + Atten. Loss + 10log(NANT)

*) This test was measured based on Method In-Band Power Spectral Density (PSD) Measurements (2) of "Emissions Testing of Transmitters with Multiple Outputs in the Same Band (KDB662911 D1)"

UL Japan, Inc.

Shonan EMC Lab.

1-22-3 Megumigaoka, Hiratsuka-shi, Kanagawa 259-1220 JAPAN

Telephone : +81 463 50 6400

Facsimile : +81 463 50 6401

Power Density

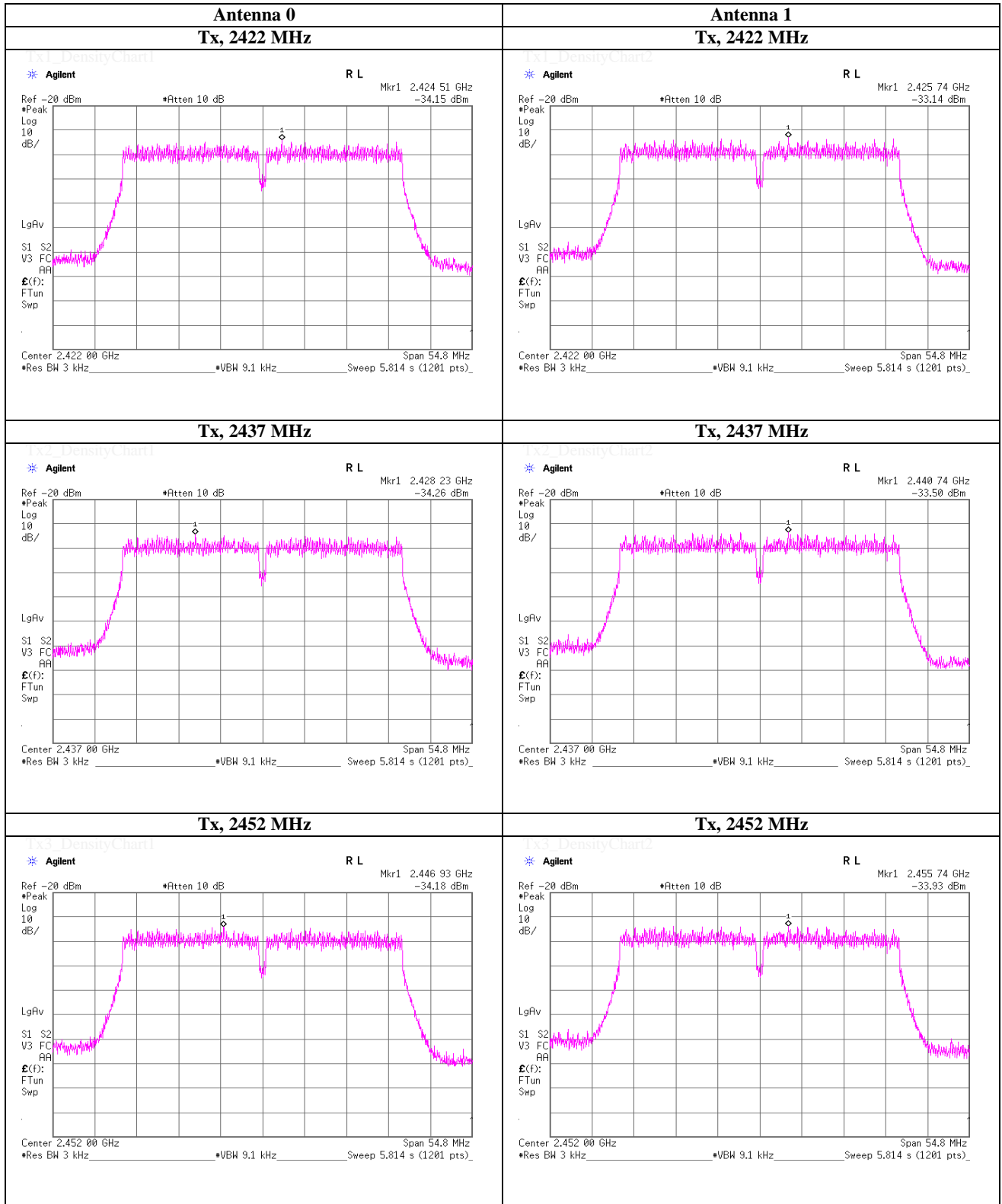

Maximum Power Spectral Density

(PKPSD)

Test place UL Japan, Inc. Shonan EMC Lab. No.1 Measurement Room
Date March 5, 2019
Temperature / Humidity 23 deg.C , 53 %RH
Engineer Kazutaka Takeyama
Mode Tx, IEEE802.11n HT40 (MIMO), PN9, worst data mode 11 (MCS)

Antenna 0

Ch. Freq. [MHz]	Freq. Reading [MHz]	Reading [dBm]	Cable Loss [dB]	Atten. [dB]	10log (N _{ANT})* [dB]	Result [dBm]	Limit [dBm]	Margin [dB]
2457.0000	2462.62	-34.28	2.42	10.18	3.01	-18.67	8.00	26.67
2462.0000	2464.51	-35.98	2.42	10.18	3.01	-20.37	8.00	28.37

Sample Calculation:

Result = Reading + Cable Loss (including the cable(s) customer supplied) + Atten. Loss + 10log(NANT)

Antenna 1

Ch. Freq. [MHz]	Freq. Reading [MHz]	Reading [dBm]	Cable Loss [dB]	Atten. [dB]	10log (N _{ANT})* [dB]	Result [dBm]	Limit [dBm]	Margin [dB]
2457.0000	2448.23	-33.37	2.42	10.18	3.01	-17.76	8.00	25.76
2462.0000	2453.29	-35.50	2.42	10.18	3.01	-19.89	8.00	27.89

Sample Calculation:

Result = Reading + Cable Loss (including the cable(s) customer supplied) + Atten. Loss + 10log(NANT)

*) This test was measured based on Method In-Band Power Spectral Density (PSD) Measurements (2) of
"Emissions Testing of Transmitters with Multiple Outputs in the Same Band (KDB662911 D1)"

UL Japan, Inc.**Shonan EMC Lab.**

1-22-3 Megumigaoka, Hiratsuka-shi, Kanagawa 259-1220 JAPAN

Telephone : +81 463 50 6400

Facsimile : +81 463 50 6401

Power Density

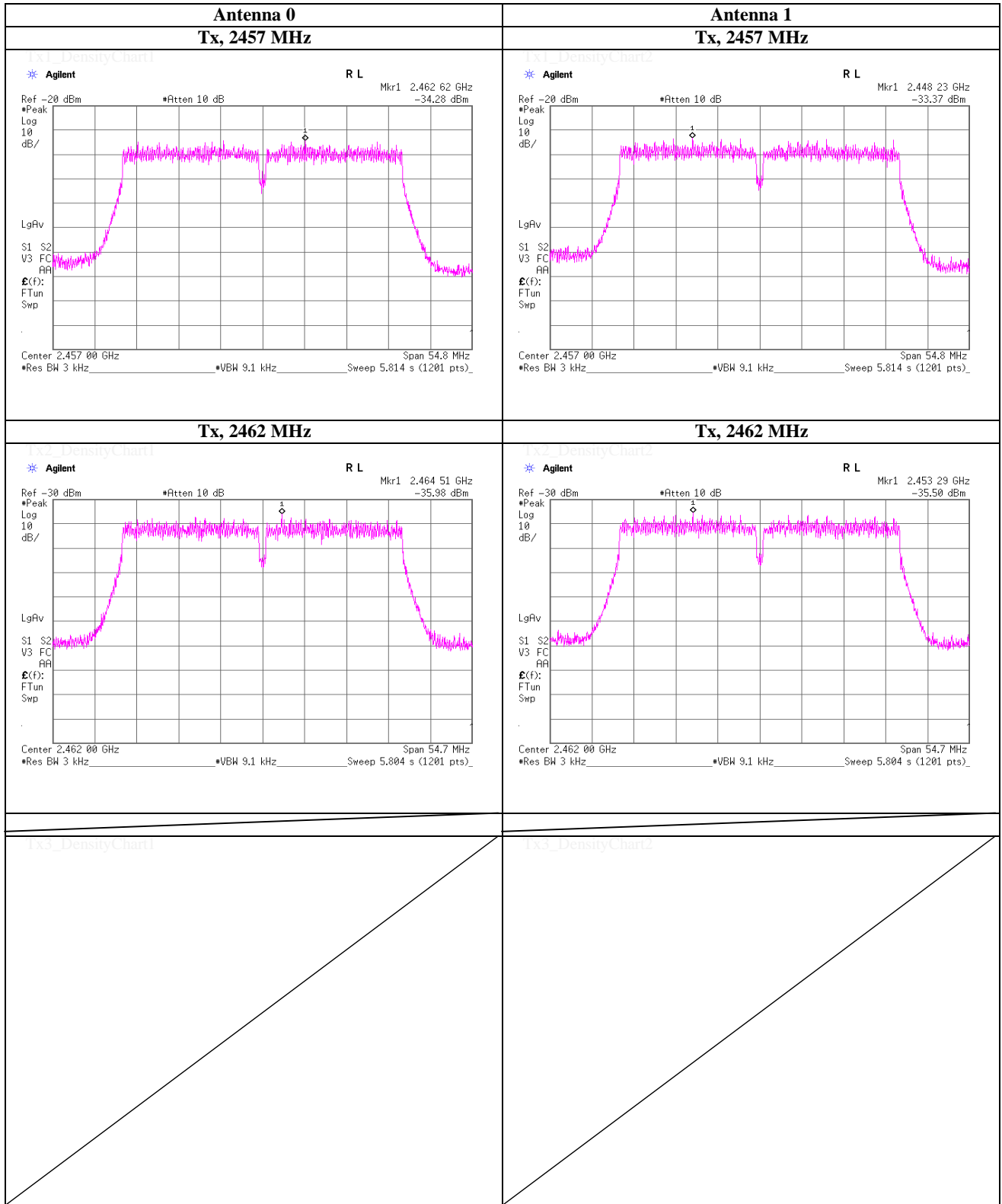

Maximum Power Spectral Density
(PKPSD)

Test place UL Japan, Inc. Shonan EMC Lab. No.1 Measurement Room
Date March 5, 2019
Temperature / Humidity 23 deg.C , 53 %RH
Engineer Kazutaka Takeyama
Mode Tx, OFDM VHT40 (MIMO), PN9, worst data mode 3 (MCS)

Antenna 0

Ch. Freq. [MHz]	Freq. Reading [MHz]	Reading [dBm]	Cable Loss [dB]	Atten. [dB]	10log (N _{ANT})* [dB]	Result [dBm]	Limit [dBm]	Margin [dB]
2422.0000	2426.98	-34.22	2.41	10.18	3.01	-18.61	8.00	26.61
2437.0000	2440.70	-34.37	2.41	10.18	3.01	-18.77	8.00	26.77
2452.0000	2459.48	-34.44	2.42	10.18	3.01	-18.83	8.00	26.83

Sample Calculation:

Result = Reading + Cable Loss (including the cable(s) customer supplied) + Atten. Loss + 10log(NANT)

Antenna 1

Ch. Freq. [MHz]	Freq. Reading [MHz]	Reading [dBm]	Cable Loss [dB]	Atten. [dB]	10log (N _{ANT})* [dB]	Result [dBm]	Limit [dBm]	Margin [dB]
2422.0000	2419.44	-33.25	2.41	10.18	3.01	-17.65	8.00	25.65
2437.0000	2454.44	-32.56	2.41	10.18	3.01	-16.96	8.00	24.96
2452.0000	2444.52	-32.96	2.42	10.18	3.01	-17.35	8.00	25.35

Sample Calculation:

Result = Reading + Cable Loss (including the cable(s) customer supplied) + Atten. Loss + 10log(NANT)

*) This test was measured based on Method In-Band Power Spectral Density (PSD) Measurements (2) of "Emissions Testing of Transmitters with Multiple Outputs in the Same Band (KDB662911 D1)"

Power Density

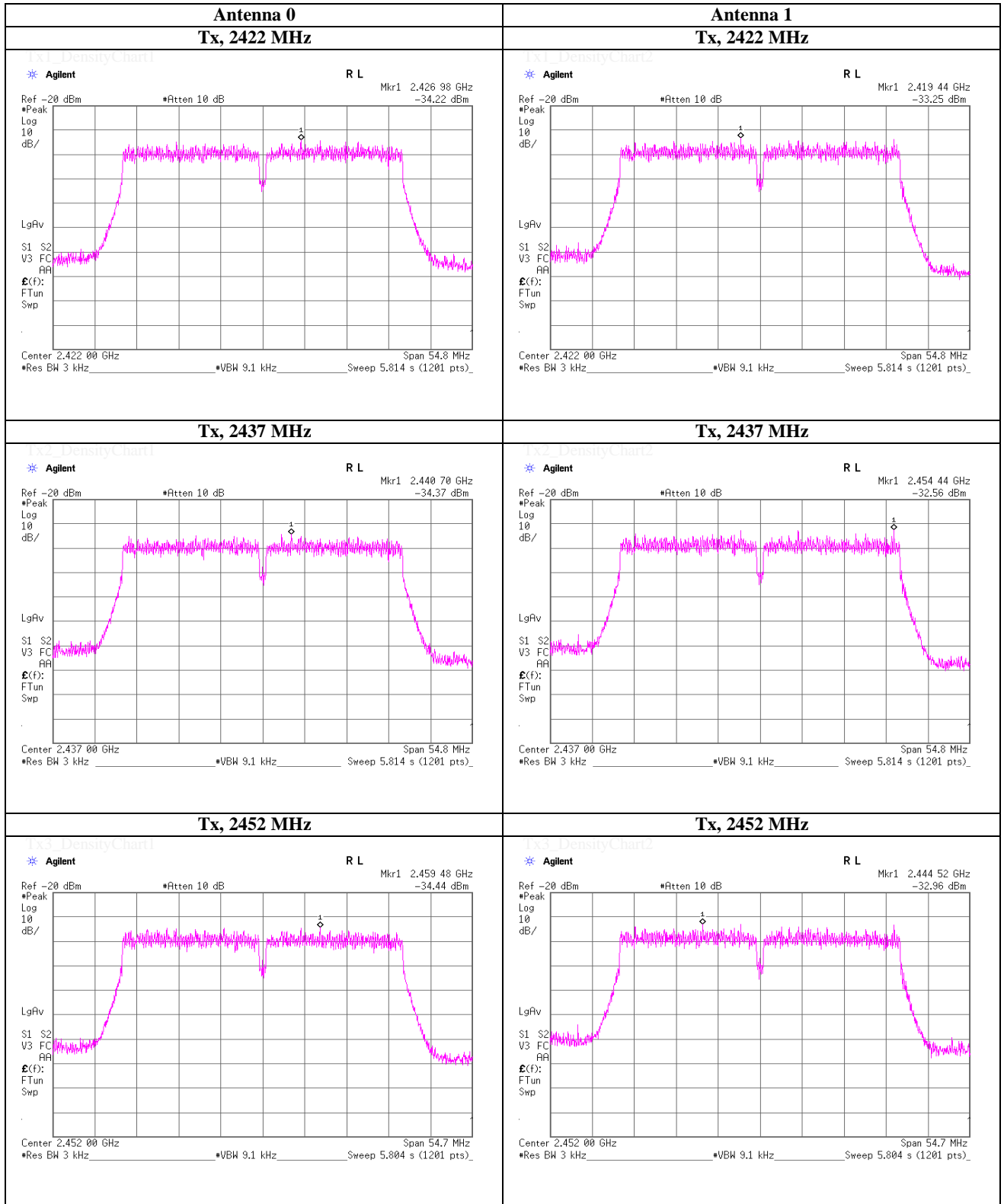

Maximum Power Spectral Density

(PKPSD)

Test place UL Japan, Inc. Shonan EMC Lab. No.1 Measurement Room
Date March 5, 2019
Temperature / Humidity 23 deg.C , 53 %RH
Engineer Kazutaka Takeyama
Mode Tx, OFDM VHT40 (MIMO), PN9, worst data mode 3 (MCS)

Antenna 0

Ch. Freq. [MHz]	Freq. Reading [MHz]	Reading [dBm]	Cable Loss [dB]	Atten. [dB]	10log (N _{ANT})* [dB]	Result [dBm]	Limit [dBm]	Margin [dB]
2457.0000	2439.54	-34.46	2.42	10.18	3.01	-18.85	8.00	26.85
2462.0000	2447.00	-37.94	2.42	10.18	3.01	-22.33	8.00	30.33

Sample Calculation:

Result = Reading + Cable Loss (including the cable(s) customer supplied) + Atten. Loss + 10log(NANT)

Antenna 1

Ch. Freq. [MHz]	Freq. Reading [MHz]	Reading [dBm]	Cable Loss [dB]	Atten. [dB]	10log (N _{ANT})* [dB]	Result [dBm]	Limit [dBm]	Margin [dB]
2457.0000	2461.97	-33.38	2.42	10.18	3.01	-17.76	8.00	25.76
2462.0000	2466.97	-35.27	2.42	10.18	3.01	-19.66	8.00	27.66

Sample Calculation:

Result = Reading + Cable Loss (including the cable(s) customer supplied) + Atten. Loss + 10log(NANT)

*) This test was measured based on Method In-Band Power Spectral Density (PSD) Measurements (2) of
"Emissions Testing of Transmitters with Multiple Outputs in the Same Band (KDB662911 D1)"

UL Japan, Inc.**Shonan EMC Lab.**

1-22-3 Megumigaoka, Hiratsuka-shi, Kanagawa 259-1220 JAPAN

Telephone : +81 463 50 6400

Facsimile : +81 463 50 6401

Power Density

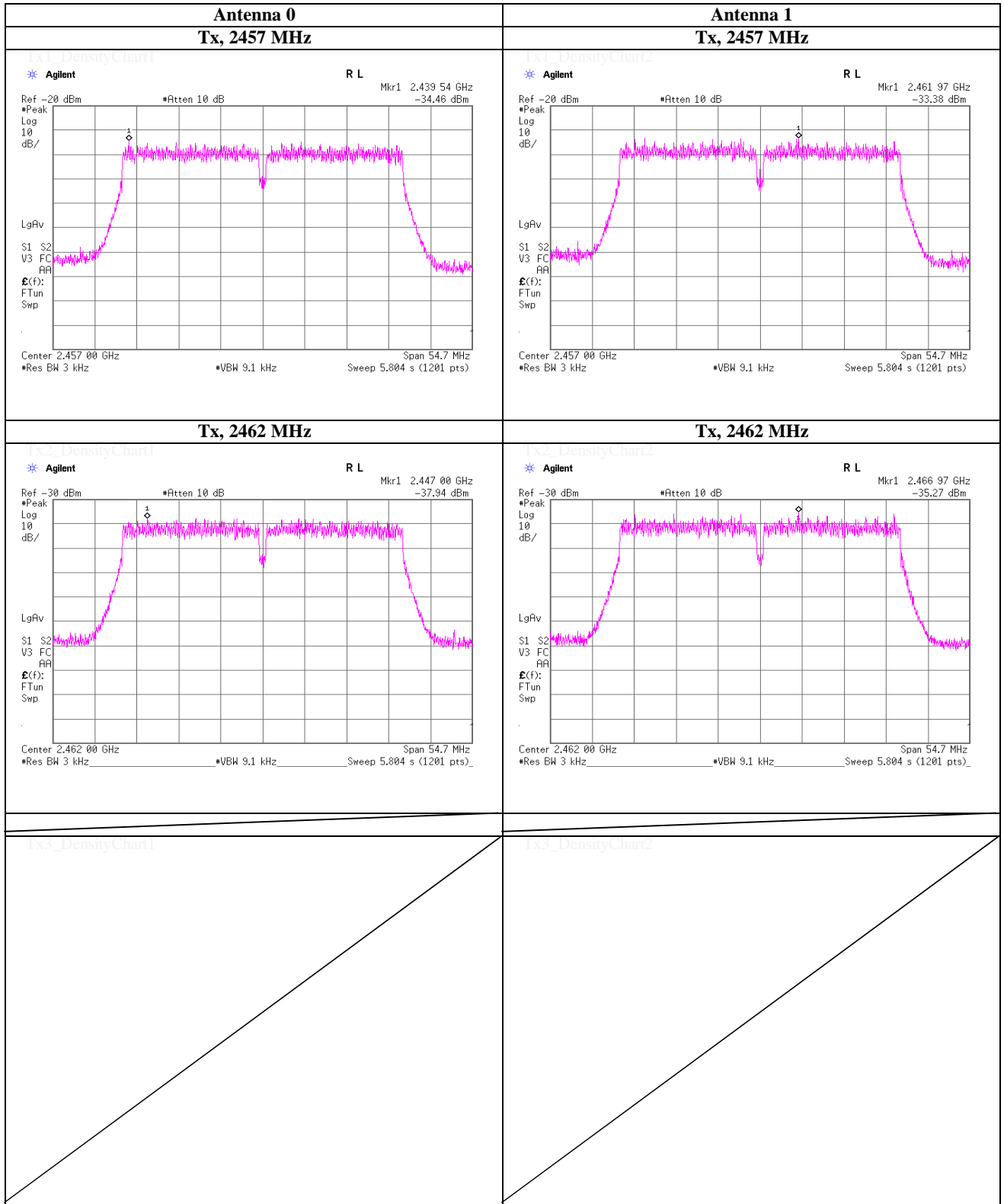

APPENDIX 2

Test Instruments

Test equipment

Local ID	Test Name	LIMS ID	Description	Manufacturer	Model	Serial	Last Calibration Date	Calibration Due Date	Calibration Interval (Month)
SAT10-15	AT	160493	Attenuator	Weinschel Corp.	54A-10	83406	2018/12/6	2019/12/30	12
SCC-G13	AT	145166	Coaxial Cable	Suhner	SUCOFLEX 102	31599/2	2018/12/25	2019/12/31	12
SOS-13	AT	146321	Humidity Indicator	CUSTOM	CTH-202	Q.C.17	2018/12/5	2019/12/31	12
SPM-07	AT	146247	Power Meter	AGILENT	8990B	MY5100272	2018/7/13	2019/7/31	12
SPSS-04	AT	146310	Power sensor	AGILENT	N1923A	MY5326009	2018/7/13	2019/7/31	12
STM-G7	AT	171614	Terminator	WEINSCHEL	M1459A	88995	2018/7/10	2019/7/31	12
SSA-03	AT	145801	Spectrum Analyzer	AGILENT	E4448A	MY48250152	2018/8/30	2019/8/31	12
SCC-C9/C10/SRSE-03	CE	145036	Coaxial Cable&RF Selector	Suhner/Suhner/TOYO	RG223U/141PE/NS4906	-/0901-271(RF Selector)	2019/4/19	2020/4/30	12
SOS-06	CE	146294	Humidity Indicator	A&D	AD-5681	4062118	2018/12/5	2019/12/31	12
SLS-05	CE (AE)	145542	LISN	Rohde & Schwarz	ENV216	100516	2019/2/19	2020/2/29	12
STM-08	CE (AE)	146190	Terminator	TME	CT-01 BP	-	2018/12/25	2019/12/31	12
SAT3-13	CE (EUT)	150923	Attenuator	JFW	50HF-003N		2019/1/25	2020/1/31	12
SLS-02	CE (EUT)	145539	LISN	Rohde & Schwarz	ENV216	100512	2019/2/20	2020/2/29	12
KJM-09	RE	145929	Measure	KOMELON	KMC-36	-	-	-	-
KSA-08	RE	145089	Spectrum Analyzer	AGILENT	E4446A	MY46180525	2018/10/7	2019/10/31	12
SAEC-03(NSA)	RE	145565	Semi-Anechoic Chamber	TDK	SAEC-03(NSA)	3	2019/4/8	2020/4/30	12
SAEC-03(SVSWR)	RE	145566	Semi-Anechoic Chamber	TDK	SAEC-03(SVSWR)	3	2018/7/17	2019/7/31	12
SAF-03	RE	145126	Pre Amplifier	SONOMA	310N	290213	2019/2/5	2020/2/29	12
SAF-04	RE	145127	Pre Amplifier	Toyo Corporation	TPA0118-36	2072554	2018/6/26	2019/6/30	12
SAF-06	RE	145005	Pre Amplifier	Toyo Corporation	TPA0118-36	1440491	2019/2/8	2020/2/29	12
SAF-08	RE	145007	Pre Amplifier	Toyo Corporation	HAP18-26W	19	2019/3/5	2020/3/31	12
SAJ-02	RE	146104	Antenna Tilt Jig	Intelligent System Engineering Co., Ltd	Antenna Tilt Jig	T-S002	-	-	-
SAJ-03	RE	146105	Antenna Tilt Jig	Intelligent System Engineering Co., Ltd	Antenna Tilt Jig	T-S003	-	-	-
SAT10-05	RE	145136	Attenuator(above 1 GHz)	AGILENT	8493C-010	74864	2018/11/25	2019/11/30	12
SAT6-13	RE	167094	Attenuator	JFW	50HF-006N		2019/2/5	2020/2/29	12
SBA-03	RE	145023	Biconical Antenna	Schwarzbeck	BBA9106	91032666	2018/6/17	2019/6/30	12

Test equipment

Local ID	Test Name	LIMS ID	Description	Manufacturer	Model	Serial	Last Calibration Date	Calibration Due Date	Calibration Interval (Month)
SCC-C1/C2/C3/C4/C5/C10/SRSE-03	RE	145171	Coaxial Cable&RF Selector	Fujikura/Fujikura/Suhner/Suhner/Suhner/Suhner/TOYO	8D2W/12DSFA/141PE/141PE/141PE/141PE	-/0901-271(RF Selector)	2019/4/19	2020/4/30	12
SCC-G05	RE	145039	Coaxial Cable	Junkosha	J12J102207-00	APR-30-15-037	2019/1/25	2020/1/31	12
SCC-G15	RE	145176	Coaxial Cable	Suhner	SUCOFLEX 102	32703/2	2019/3/27	2020/3/31	12
SCC-G22	RE	145180	Coaxial Cable	Suhner	SUCOFLEX 104	296199/4	2018/5/11	2019/5/31	12
SCC-G33	RE	145184	Coaxial Cable	Junkosha	MWX241-01000KMSKMS	-	2018/4/20	2019/4/30	12
SCC-G40	RE	166491	Coaxial Cable	Junkosha	MWX221-01000NFSNMS/B	1612S005	2019/1/25	2020/1/31	12
SCC-G41	RE	151617	Coaxial Cable	Junkosha	MWX221-01000NFSNMS/B	1612S006	2019/1/25	2020/1/31	12
SCC-G43	RE	156380	Coaxial Cable	HUBER+SUNER	SUCOFLEX_104_E	SN MY 13406/4E	2018/7/10	2019/7/31	12
SCC-G44	RE	168300	Coaxial Cable	HUBER+SUNER	SUCOFLEX 104	800070/4A	2019/3/26	2020/3/31	12
SCC-G45	RE	168301	Coaxial Cable	HUBER+SUNER	SUCOFLEX 102 E	800137/2EA	2019/3/26	2020/3/31	12
SFL-02	RE	145301	Highpass Filter	MICRO-TRONICS	HPM50111	51	2018/11/16	2019/11/30	12
SHA-01	RE	145383	Horn Antenna	Schwarzbeck	BBHA9120D	9120D-725	2018/7/23	2019/7/31	12
SHA-03	RE	145501	Horn Antenna	Schwarzbeck	BBHA9120D	9120D-739	2018/7/23	2019/7/31	12
SHA-04	RE	145512	Horn Antenna	ETS LINDGREN	Sep-60	LM3640	2018/7/23	2019/7/31	12
SLA-07	RE	145529	Logperiodic Antenna	Schwarzbeck	VUSLP9111B	196	2018/6/17	2019/6/30	12
SOS-01	RE	146316	Humidity Indicator	A&D	AD-5681	4062555	2018/10/25	2019/10/31	12
SOS-05	RE	146293	Humidity Indicator	A&D	AD-5681	4062518	2018/10/25	2019/10/31	12
SRENT-20	RE	176115	Pre Amplifier	Agilent	8449B	3008A02595	2018/12/18	2019/12/31	12
SSA-02	RE	145800	Spectrum Analyzer	AGILENT	E4448A	MY48250106	2018/3/5	2019/3/31	12
STS-01	RE	145792	Digital Hitester	HIOKI	3805-50	80997812	2018/10/16	2019/10/31	12
STR-08	RE, CE	150463	Test Receiver	Rohde & Schwarz	ESW44	101581	2018/11/28	2019/11/30	12
COTS-SEMI-5	RE,CE	170932	EMI Software	TSJ	TEPTO-DV3(RE,CE,ME,PE)	-	-	-	-
KJM-02	RE,CE	146432	Measure	TAJIMA	GL19-55	-	-	-	-
STS-03	RE,CE	146210	Digital Hitester	HIOKI	3805-50	80997823	2018/10/16	2019/10/31	12

*Hyphens for Last Calibration Date, Calibration Due Date and Cal Int (month) are instruments Calibration is not required (e.g. software), or instruments checked in advance before use.

The expiration date of the calibration is the end of the expired month.

As for some calibrations performed after the tested dates, those test equipment have been controlled by means of an unbroken chains of calibrations.

All equipment is calibrated with valid calibrations. Each measurement data is traceable to the national or international standards

Test Item:

CE: Conducted emission,

RE: Radiated emission,

AT: Antenna terminal conducted test