



SAR TEST REPORT

Test Report No. : 11676681H

Applicant : Nintendo Co., Ltd.
Type of Equipment : EDEV
Model No. : HAT-002
FCC ID : BKEHAT002
Test regulation : FCC47CFR 2.1093
Test Result : Complied
Reported SAR(1g) Value : **The highest reported SAR(1g)**
Body : 1.11 W/kg
Simultaneous Transmission: 1.17 W/kg

1. This test report shall not be reproduced in full or partial, without the written approval of UL Japan, Inc.
2. The results in this report apply only to the sample tested.
3. This sample tested is in compliance with the limits of the above regulation.
4. The test results in this report are traceable to the national or international standards.
5. This test report must not be used by the customer to claim product certification, approval, or endorsement by NVLAP, NIST, or any agency of the Federal Government.
6. This test report covers SAR technical requirements. It does not cover administrative issues such as Manual or non-SAR test related Requirements. (if applicable)

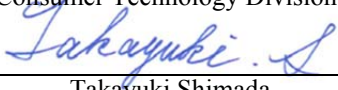
Date of test: November 14 to 17, 2016
Representative test engineer: 
Hisayoshi Sato
Engineer
Consumer Technology Division
Approved by : 
Takayuki Shimada
Engineer
Consumer Technology Division

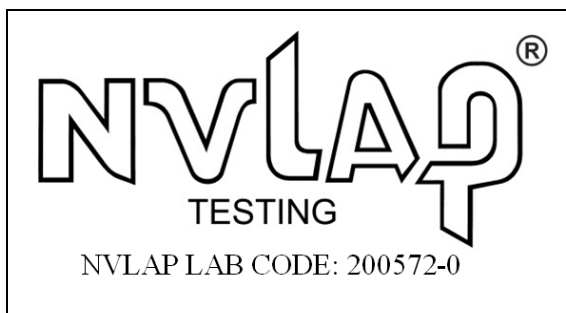

This laboratory is accredited by the NVLAP LAB CODE 200572-0, U.S.A. The tests reported herein have been performed in accordance with its terms of accreditation. *As for the range of Accreditation in NVLAP, you may refer to the WEB address, http://japan.ul.com/resources/emc_accredited/

REVISION HISTORY

Original Test Report No.: 11676681H

Revision	Test report No.	Date	Page revised	Contents
- (Original)	11676681H	March 31, 2017	-	-

CONTENTS	PAGE
SECTION1: Customer information.....	4
SECTION2: Equipment under test (E.U.T.).....	4
2.1 Identification of E.U.T.	4
2.2 Product Description.....	4
SECTION3: Test standard information.....	6
3.1 Test Specification.....	6
3.2 Procedure.....	6
3.3 Exposure limit.....	7
3.4 Test Location.....	7
SECTION4: Test result.....	8
4.1 Stand-alone SAR result.....	8
4.2 Simurateinou transmission SAR result.....	8
4.3 Maximum tune-up tolerance limit.....	9
SECTION5: RF Exposure Conditions (Test Configurations).....	12
5.1 SAR test exclusion considerations according to KDB447498 D01.....	12
5.2 SAR test exclusion considerations according to KDB941225D07.....	14
5.3 Estimated SAR for Simultaneous Transmission SAR Analysis according to KDB447498 D01.....	15
5.4 Description of the operating mode.....	16
5.5 Output Power and SAR test required for WLAN.....	17
5.6 Output Power and SAR test required for Bluetooth.....	26
SECTION6: Description of the Body setup.....	27
6.1 Procedure for SAR testing.....	27
6.2 Test position for Body setup.....	27
SECTION7: Test surrounding.....	28
7.1 Measurement uncertainty.....	28
SECTION8: Parameter Check.....	30
SECTION9: System Check confirmation.....	33
SECTION10: SAR Test data for WLAN.....	34
10.1 Result of Body SAR.....	34
SECTION11: Simultaneous Transmission SAR Analysis.....	39
SECTION12: Test instruments.....	41
APPENDIX 1 : SAR Measurement data.....	42
Evaluation procedure.....	42
Measurement data.....	44
APPENDIX 2 : System Check.....	60
System check result Body 2450MHz.....	60
APPENDIX 3 : System specifications.....	64
Configuration and peripherals.....	64
Specifications.....	65
System Check Dipole SAR Calibration Certificate -Dipole 2450MHz(D2450V2,S/N:713).....	69
System Check Dipole SAR Calibration Certificate -Dipole 5GHz(D5GHzV2,S/N:1020).....	77
Dosimetric E-Field Probe Calibration Certificate (EX3DV4, S/N: 3825).....	94
System check uncertainty.....	105
APPENDIX 4 : Photographs of test setup.....	107
Photographs of EUT.....	107
Antenna position.....	108
Photographs of setup.....	109

SECTION1: Customer information

Company Name : Nintendo Co., Ltd.
Address : 11-1 Hokotate-cho, Kamitoba, Minami-ku, Kyoto 601-8501, Japan
Telephone Number : +81-75-662-9600
Facsimile Number : +81-75-662-9624
Contact Person : Kazuya Kuramoto

SECTION2: Equipment under test (E.U.T.)

2.1 Identification of E.U.T.

Type of Equipment : EDEV
Model No. : HAT-002
Serial No. : XAW01500007568
Rating : DC 3.7 V (battery),
AC Adapter input: AC 100 – 240 V, 50 / 60 Hz, 1 A,
AC Adapter output: DC 5 V – DC 15 V, 2.6 A
*The Battery is had built-in in the EUT, and the user can't remove the
battery.
Receipt Date of Sample : August 3, 2016
Country of Mass-production : China
Condition of EUT : Production prototype
(Not for Sale: This sample is equivalent to mass-produced items.)
Modification of EUT : No Modification by the test lab

2.2 Product Description

Model: HAT-002 (referred to as the EUT in this report) is a EDEV.

The EUT is intended to be used for software development or events.

General Specification

Clock frequency(ies) in the system : 37.4 MHz

Radio Specification

Radio Type : Transceiver
Frequency of Operation : Wireless LAN part: 2412 MHz - 2472 MHz, 5180 MHz - 5320 MHz
Bluetooth part: 2402 MHz - 2480 MHz
Modulation : Wireless LAN part:
2.4 GHz bands: DBPSK, DQPSK, CCK, OFDM
5 GHz bands: OFDM
Bluetooth part:
BDR (Basic Data Rate): GFSK
EDR (Enhanced Data Rate): $\pi/4$ -DQPSK, 8DPSK
LE (Low Energy mode): GFSK
Antenna type : PCB Antenna (Dipole)
Antenna connector : (Ant: 0): MHF 4L, (Ant: 1): MHF II
Antenna Gain : 2400 MHz - 2483.5 MHz:
-0.70 dBi max (ANT0: Wireless LAN & Bluetooth)
-8.38 dBi max (ANT1: Wireless LAN)
5150 MHz - 5320 MHz:
+3.31 dBi max (ANT0: Wireless LAN & Bluetooth)
-0.96.dBi max (ANT1: Wireless LAN)
Operation temperature : +5 deg.C to +35 deg.C
Remarks: This Wireless Module consists of 1 chip each of 5 GHz band and 2.4 GHz band.

SECTION3: Test standard information

3.1 Test Specification

Title : **FCC47CFR 2.1093**

Radiofrequency radiation exposure evaluation: portable devices.

: **IEEE Std 1528-2013:**

IEEE Recommended Practice for Determining the Peak Spatial-Average Specific Absorption Rate (SAR) in the Human Head from Wireless Communications Devices: Measurement Techniques.

: **Published RF exposure KDB procedures**

- KDB447498D01(v06)** Mobile and Portable Device RF Exposure Procedures and Equipment Authorization Policies
- KDB447498D02(v02r01)** SAR Measurement Procedures for USB Dongle Transmitters
- KDB648474D04(v01r03)** SAR Evaluation Considerations for Wireless Handsets
- KDB941225D01(v03r01)** 3G SAR MEASUREMENT PROCEDURES
- KDB941225D05(v02r05)** SAR for LTE Devices
- KDB941225D06(v02r01)** SAR test procedures for devices incorporating SAR Evaluation Procedures for Portable Devices with Wireless Router Capabilities (Hot Spot SAR)
- KDB941225D07(v01r02)** SAR Evaluation Procedures for UMPC Mini-Tablet Devices
- KDB616217D04(v01r02)** SAR Evaluation Considerations for Laptop, Notebook, Netbook and Tablet Computers
- KDB865664D01(v01r04)** SAR Measurement Requirements for 100MHz to 6 GHz
- KDB248227D01(v02r02)** SAR Measurement Procedures for 802.11(Wi-Fi) Transmitters

Reference

[1]SPEAG uncertainty document (AN 15-7/AN19-17) for DASY 5 System from SPEAG (Schmid & Partner Engineering AG).

3.2 Procedure

Transmitter	WLAN and Bluetooth
Test Procedure	Published RF exposure KDB procedures
Category	FCC47CFR 2.1093
Note: UL Japan, Inc. 's SAR Work Procedures 13-EM-W0429 and 13-EM-W0430	

3.3 Exposure limit

(A) Limits for Occupational/Controlled Exposure (W/kg)

Spatial Average (averaged over the whole body)	Spatial Peak (averaged over any 1g of tissue)	Spatial Peak (hands/wrists/feet/ankles averaged over 10g)
0.4	8.0	20.0

(B) Limits for General population/Uncontrolled Exposure (W/kg)

Spatial Average (averaged over the whole body)	Spatial Peak (averaged over any 1g of tissue)	Spatial Peak (hands/wrists/feet/ankles averaged over 10g)
0.08	1.6	4.0

Occupational/Controlled Environments: are defined as locations where there is exposure that may be incurred by people who are aware of the potential for exposure, (i.e. as a result of employment or occupation).

General Population/Uncontrolled Environments: are defined as locations where there is the exposure of individuals who have no knowledge or control of their exposure.

<p style="text-align: center;">NOTE:GENERAL POPULATION/UNCONTROLLED EXPOSURE SPATIAL PEAK(averaged over any 1g of tissue) LIMIT 1.6 W/kg</p>

3.4 Test Location

*Shielded room for SAR testings
UL Japan, Inc. Ise EMC Lab. *NVLAP Lab. code: 200572-0
4383-326 Asama-cho, Ise-shi, Mie-ken 516-0021 JAPAN
Telephone : +81 596 24 8999 Facsimile : +81 596 24 8124

SECTION4: Test result

4.1 Stand-alone SAR result

Reported SAR

Body SAR

Mode	Frequency (MHz)	Reported SAR (W/kg)
WLAN11b	2437	1.107

4.2 Simurateinou transmission SAR result

Detail is shown at section 11.

Body SAR

Stand-alone 1-g SAR (W/kg)		Σ 1-g SAR (W/kg)
WLAN 2.4GHz Ant 0	WLAN 2.4GHz Ant 1	
1.052	0.122	1.174

4.3 Maximum tune-up tolerance limit

Maximum tune-up tolerance limit is burst average power.
Maximum tune-up tolerance limit is defined by a customer as Duty100%.

Wi-Fi 2.4GHz (DTS Band)

SISO

Band (GHz)	Mode	Data Rate	Ch #	Freq. (MHz)	Maximum tune-up tolerance limit (dBm)	
					An0t Tx	Ant1 Tx
2.4	802.11b	1 Mbps	1	2412	19.00	19.00
			6	2437		
			11	2462		
			12	2467	10.00	10.00
			13	2472	5.00	5.00
	802.11g	6 Mbps	1	2412	18.00	18.00
			6	2437		
			11	2462		
			12	2467	10.00	10.00
			13	2472	5.00	5.00
	802.11n (HT20)	6.5 Mbps	1	2412	18.00	18.00
			6	2437		
			11	2462		
			12	2467	10.00	10.00
			13	2472	5.00	5.00
	802.11n (HT40)	13.5 Mbps	3	2422	10.00	10.00
11			2462	10.00	10.00	

MIMO

Band (GHz)	Mode	Data Rate	Ch #	Freq. (MHz)	Maximum tune-up tolerance limit (dBm)
					Ant0&Ant1 Simultaneous Tx
2.4	802.11n (HT20)	6.5 Mbps	1	2412	13.50
			6	2437	13.50
			11	2462	13.50
			12	2467	7.00
			13	2472	2.00
	802.11n (HT40)	13.5 Mbps	3	2422	9.50
			6	2437	9.50
			9	2452	9.50
			10	2457	9.50
			11	2462	7.00

Wi-Fi 5GHz (U-NII-1 and U-NII-2A Bands)

SISO

Band (GHz)	Mode	Data Rate	Ch #	Freq. (MHz)	Maximum tune-up tolerance limit (dBm)	
					An0t Tx	Ant1 Tx
5.2 (U-NII-1)	802.11a	6 Mbps	36	5180	15.00	15.00
			40	5200		
			44	5220		
			48	5240		
	802.11n (HT20)	6.5 Mbps	36	5180	15.00	15.00
			40	5200		
			44	5220		
			48	5240		
	802.11ac (VHT20)	6.5 Mbps	36	5180	15.00	15.00
			40	5200		
			44	5220		
			48	5240		
802.11n (HT40)	13.5 Mbps	38	5190	11.50	11.50	
		46	5230	15.00	15.00	
802.11ac (VHT40)	13.5 Mbps	38	5190	11.50	11.50	
		46	5230	15.00	15.00	
802.11ac (VHT80)	29.3 Mbps	42	5210	10.50	10.50	
5.3 (U-NII-2A)	802.11a	6 Mbps	52	5260	15.00	15.00
			56	5280		
			60	5300		
			64	5320		
	802.11n (HT20)	6.5 Mbps	52	5260	15.00	15.00
			56	5280		
			60	5300		
			64	5320		
	802.11ac (VHT20)	6.5 Mbps	52	5260	15.00	15.00
			56	5280		
			60	5300		
			64	5320		
	802.11n (HT40)	13.5 Mbps	54	5270	15.00	15.00
			62	5310	15.00	15.00
	802.11ac (VHT40)	13.5 Mbps	54	5270	15.00	15.00
			62	5310	15.00	15.00
802.11ac (VHT80)	29.3 Mbps	58	5290	10.50	10.50	

MIMO

Band (GHz)	Mode	Data Rate	Ch #	Freq. (MHz)	Maximum tune-up tolerance limit (dBm)
					Ant0&Ant1 Simultaneous Tx
5.2 (U-NII-1)	802.11n (HT20)	6.5 Mbps	36	5180	12.00
			40	5200	
			44	5220	
			48	5240	
	802.11ac (VHT20)	6.5 Mbps	36	5180	12.00
			40	5200	
			44	5220	
			48	5240	
802.11n (HT40)	13.5 Mbps	38	5190	8.50	
		46	5230	12.00	
802.11ac (VHT40)	13.5 Mbps	38	5190	8.50	
		46	5230	12.00	
802.11ac (VHT80)	29.3 Mbps	42	5210	7.50	
5.3 (U-NII-2A)	802.11n (HT20)	6.5 Mbps	52	5260	12.00
			56	5280	
			60	5300	
			64	5320	
	802.11ac (VHT20)	6.5 Mbps	52	5260	12.00
			56	5280	
			60	5300	
			64	5320	
	802.11n (HT40)	13.5 Mbps	54	5270	12.00
			62	5310	12.00
	802.11ac (VHT40)	13.5 Mbps	54	5270	12.00
			62	5310	12.00
802.11ac (VHT80)	29.3 Mbps	58	5290	7.50	

UL Japan, Inc.

Ise EMC Lab.

4383-326 Asama-cho, Ise-shi, Mie-ken 516-0021 JAPAN

Telephone: +81 596 24 8999

Facsimile: +81 596 24 8124

Bluetooth

Band (GHz)	Mode	Data Rate	Ch #	Freq. (MHz)	Maximum tune-up tolerance limit (dBm)
					BT Tx
2.4	BDR	DH5	0	2402	3.00
			39	2441	
			78	2480	
	EDR	2DH5	0	2402	3.00
			39	2441	
			78	2480	
	EDR	3DH5	0	2402	3.00
			39	2441	
			78	2480	
	LE	-	0	2402	3.00
			19	2440	
			39	2480	

SECTION5: RF Exposure Conditions (Test Configurations)

5.1 SAR test exclusion considerations according to KDB447498 D01

The following is based on KDB447498D01.

1) The 1-g and 10-g SAR test exclusion thresholds for 100 MHz to 6 GHz at test separation distances ≤ 50 mm are determined by:

$$[(\text{max. power of channel, including tune-up tolerance, mW})/(\text{min. test separation distance, mm})] \cdot [\sqrt{f(\text{GHz})}] \leq 3.0$$

for 1-g SAR and ≤ 7.5 for 10-g extremity SAR

When the calculated threshold value by a numerical formula above-mentioned in the following table is 3.0 or less, SAR test is excluded.

SAR exclusion calculations for antenna <50mm from the user

Antenna	Tx Interface	Frequency (MHz)	Output Power		Separation Distances (mm)						Calculated Threshold Value					
			dBm	mW	Top	Bottom	Right	Left	Front	Rear	Top	Bottom	Right	Left	Front	Rear
Ant0	11b	2472	19.00	79	2	51	51	10	3	10	24.8	> 50 mm	> 50 mm	24.8	24.8	24.8
Ant0	11g	2472	18.00	63	2	51	51	10	3	10	-MEASURE-	> 50 mm	> 50 mm	-MEASURE-	-MEASURE-	-MEASURE-
Ant0	11n HT20	2472	18.00	63	2	51	51	10	3	10	19.8	> 50 mm	> 50 mm	19.8	19.8	19.8
Ant0	11n HT40	2472	10.00	10	2	51	51	10	3	10	-MEASURE-	> 50 mm	> 50 mm	-MEASURE-	-MEASURE-	-MEASURE-
Ant0	BT	2480	3.00	2	2	51	51	10	3	10	0.6	> 50 mm	> 50 mm	0.6	0.6	0.6

Antenna	Tx Interface	Frequency (MHz)	Output Power		Separation Distances (mm)						Calculated Threshold Value					
			dBm	mW	Top	Bottom	Right	Left	Front	Rear	Top	Bottom	Right	Left	Front	Rear
Ant0	11a	5320	15.00	32	2	51	51	10	3	10	14.8	> 50 mm	> 50 mm	14.8	14.8	14.8
Ant0	11n HT20	5320	15.00	32	2	51	51	10	3	10	-MEASURE-	> 50 mm	> 50 mm	-MEASURE-	-MEASURE-	-MEASURE-
Ant0	11n HT40	5320	15.00	32	2	51	51	10	3	10	14.8	> 50 mm	> 50 mm	14.8	14.8	14.8
Ant0	11ac VHT80	5320	10.50	11	2	51	51	10	3	10	5.1	> 50 mm	> 50 mm	5.1	5.1	5.1

Antenna	Tx Interface	Frequency (MHz)	Output Power		Separation Distances (mm)						Calculated Threshold Value					
			dBm	mW	Top	Bottom	Right	Left	Front	Rear	Top	Bottom	Right	Left	Front	Rear
Ant1	11b	2472	19.00	79	1	51	41	51	3	5	24.8	> 50 mm	24.8	> 50 mm	24.8	24.8
Ant1	11g	2472	18.00	63	1	51	41	51	3	5	-MEASURE-	> 50 mm	-MEASURE-	> 50 mm	-MEASURE-	-MEASURE-
Ant1	11n HT20	2472	18.00	63	1	51	41	51	3	5	19.8	> 50 mm	19.8	> 50 mm	19.8	19.8
Ant1	11n HT40	2472	10.00	10	1	51	41	51	3	5	-MEASURE-	> 50 mm	-MEASURE-	> 50 mm	-MEASURE-	-MEASURE-

Antenna	Tx Interface	Frequency (MHz)	Output Power		Separation Distances (mm)						Calculated Threshold Value					
			dBm	mW	Top	Bottom	Right	Left	Front	Rear	Top	Bottom	Right	Left	Front	Rear
Ant1	11a	5320	15.00	32	1	51	41	51	3	5	14.8	> 50 mm	14.8	> 50 mm	14.8	14.8
Ant1	11n HT20	5320	15.00	32	1	51	41	51	3	5	-MEASURE-	> 50 mm	-MEASURE-	> 50 mm	-MEASURE-	-MEASURE-
Ant1	11n HT40	5320	15.00	32	1	51	41	51	3	5	14.8	> 50 mm	14.8	> 50 mm	14.8	14.8
Ant1	11ac VHT80	5320	10.50	11	1	51	41	51	3	5	5.1	> 50 mm	5.1	> 50 mm	5.1	5.1

Notes:

1. The upper frequency of the frequency band was used in order to calculate standalone SAR test exclusion considerations.
2. Power and distance are rounded to the nearest mW and mm before calculation
3. The result is rounded to one decimal place for comparison
4. The test exclusions are applicable only when the minimum test separation distance is ≤ 50 mm and for transmission frequencies between 100 MHz and 6 GHz. When the minimum test separation distance is < 5 mm, a distance of 5 mm is applied to determine SAR test exclusion. When the separation of antenna to EUT's surfaces and edges are ≤ 50 mm, the separation distance used for the SAR exclusion calculations is 5 mm.

2) At 100 MHz to 6 GHz and for test separation distances > 50 mm, the SAR test exclusion threshold is determined according to the following.

- a) $[(3 \cdot 50) / (\sqrt{f(\text{GHz})})] + (\text{test separation distance} - 50 \text{ mm}) \cdot (f(\text{MHz}) / 150)$ mW at > 100 MHz and ≤ 1500 MHz
b) $[(3 \cdot 50) / (\sqrt{f(\text{GHz})})] + (\text{test separation distance} - 50 \text{ mm}) \cdot 10$ mW at > 1500 MHz and ≤ 6 GHz

When output power is less than the calculated threshold value by a numerical formula above-mentioned in the following table, SAR test is excluded.

SAR exclusion calculations for antenna >50mm from the user

Antenna	Tx Interface	Frequency (MHz)	Output Power		Separation Distances (mm)						Calculated Threshold Value					
			dBm	mW	Top	Bottom	Right	Left	Front	Rear	Top	Bottom	Right	Left	Front	Rear
Ant0	11b	2472	19.00	79	2	51	51	10	3	10	< 50 mm	105.4 mW -EXEMPT-	105.4 mW -EXEMPT-	< 50 mm	< 50 mm	< 50 mm
Ant0	11g	2472	18.00	63	2	51	51	10	3	10	< 50 mm	105.4 mW -EXEMPT-	105.4 mW -EXEMPT-	< 50 mm	< 50 mm	< 50 mm
Ant0	11n HT20	2472	18.00	63	2	51	51	10	3	10	< 50 mm	105.4 mW -EXEMPT-	105.4 mW -EXEMPT-	< 50 mm	< 50 mm	< 50 mm
Ant0	11n HT40	2472	10.00	10	2	51	51	10	3	10	< 50 mm	105.4 mW -EXEMPT-	105.4 mW -EXEMPT-	< 50 mm	< 50 mm	< 50 mm
Ant0	BT	2480	3.00	2	2	51	51	10	3	10	< 50 mm	105.3 mW -EXEMPT-	105.3 mW -EXEMPT-	< 50 mm	< 50 mm	< 50 mm

Antenna	Tx Interface	Frequency (MHz)	Output Power		Separation Distances (mm)						Calculated Threshold Value					
			dBm	mW	Top	Bottom	Right	Left	Front	Rear	Top	Bottom	Right	Left	Front	Rear
Ant0	11a	5320	15.00	32	2	51	51	10	3	10	< 50 mm	75 mW -EXEMPT-	75 mW -EXEMPT-	< 50 mm	< 50 mm	< 50 mm
Ant0	11n HT20	5320	15.00	32	2	51	51	10	3	10	< 50 mm	75 mW -EXEMPT-	75 mW -EXEMPT-	< 50 mm	< 50 mm	< 50 mm
Ant0	11n HT40	5320	15.00	32	2	51	51	10	3	10	< 50 mm	75 mW -EXEMPT-	75 mW -EXEMPT-	< 50 mm	< 50 mm	< 50 mm
Ant0	11ac VHT80	5320	10.50	11	2	51	51	10	3	10	< 50 mm	75 mW -EXEMPT-	75 mW -EXEMPT-	< 50 mm	< 50 mm	< 50 mm

Antenna	Tx Interface	Frequency (MHz)	Output Power		Separation Distances (mm)						Calculated Threshold Value					
			dBm	mW	Top	Bottom	Right	Left	Front	Rear	Top	Bottom	Right	Left	Front	Rear
Ant1	11b	2472	19.00	79	1	51	41	51	3	5	< 50 mm	105.4 mW -EXEMPT-	< 50 mm	105.4 mW -EXEMPT-	< 50 mm	< 50 mm
Ant1	11g	2472	18.00	63	1	51	41	51	3	5	< 50 mm	105.4 mW -EXEMPT-	< 50 mm	105.4 mW -EXEMPT-	< 50 mm	< 50 mm
Ant1	11n HT20	2472	18.00	63	1	51	41	51	3	5	< 50 mm	105.4 mW -EXEMPT-	< 50 mm	105.4 mW -EXEMPT-	< 50 mm	< 50 mm
Ant1	11n HT40	2472	10.00	10	1	51	41	51	3	5	< 50 mm	105.4 mW -EXEMPT-	< 50 mm	105.4 mW -EXEMPT-	< 50 mm	< 50 mm

Antenna	Tx Interface	Frequency (MHz)	Output Power		Separation Distances (mm)						Calculated Threshold Value					
			dBm	mW	Top	Bottom	Right	Left	Front	Rear	Top	Bottom	Right	Left	Front	Rear
Ant1	11a	5320	15.00	32	1	51	41	51	3	5	< 50 mm	75 mW -EXEMPT-	< 50 mm	75 mW -EXEMPT-	< 50 mm	< 50 mm
Ant1	11n HT20	5320	15.00	32	1	51	41	51	3	5	< 50 mm	75 mW -EXEMPT-	< 50 mm	75 mW -EXEMPT-	< 50 mm	< 50 mm
Ant1	11n HT40	5320	15.00	32	1	51	41	51	3	5	< 50 mm	75 mW -EXEMPT-	< 50 mm	75 mW -EXEMPT-	< 50 mm	< 50 mm
Ant1	11ac VHT80	5320	10.50	11	1	51	41	51	3	5	< 50 mm	75 mW -EXEMPT-	< 50 mm	75 mW -EXEMPT-	< 50 mm	< 50 mm

Notes:

- The upper frequency of the frequency band was used in order to calculate standalone SAR test exclusion considerations.
- Power and distance are rounded to the nearest mW and mm before calculation

5.2 SAR test exclusion considerations according to KDB941225D07

Based on KDB941225D07, UMPC mini-tablet devices must be tested for 1-g SAR on all surfaces and side edges with a transmitting antenna located at ≤ 25 mm from that surface or edge, at 5 mm separation from a flat phantom, for the data modes, wireless technologies and frequency bands supported by the device to determine SAR compliance.

KDB 941225 UMPC

Antenna	Tx Interface	Separation Distances (mm)						SAR test required					
		Top	Bottom	Right	Left	Front	Rear	Top	Bottom	Right	Left	Front	Rear
Ant0	WLAN	2	51	51	10	3	10	MEASURE	EXEMPT	EXEMPT	MEASURE	MEASURE	MEASURE
Ant0	BT	2	51	51	10	3	10	MEASURE	EXEMPT	EXEMPT	MEASURE	MEASURE	MEASURE
Ant1	WLAN	1	51	41	51	3	5	MEASURE	EXEMPT	EXEMPT	EXEMPT	MEASURE	MEASURE

Notes:

1. Power and distance are rounded to the nearest mW and mm before calculation
2. When the separation of antenna to EUT's surfaces and edges are 50 mm <, the separation distance used is 51 mm.

5.3 Estimated SAR for Simultaneous Transmission SAR Analysis according to KDB447498 D01

The following is based on KDB447498D01.

When standalone SAR test exclusion applies to an antenna that transmits simultaneously with other antennas, the standalone SAR must be estimated according to following to determine simultaneous transmission SAR test exclusion:

$$(max. \text{ power of channel, including tune-up tolerance, mW}) / (\min. \text{ test separation distance, mm}) \cdot [\sqrt{f(\text{GHz})} / x] \text{ W/kg}$$

for test separation distances ≤ 50 mm; where $x = 7.5$ for 1-g SAR, and $x = 18.75$ for 10-g SAR.

0.4 W/kg for 1-g SAR and 1.0 W/kg for 10-g SAR, when the test separation distances is > 50 mm.

Estimated SAR

Antenna	Tx Interface	Frequency (MHz)	Output Power		Separation Distances (mm)						Estimated 1-g SAR Value (W/kg)					
			dBm	mW	Top	Bottom	Right	Left	Front	Rear	Top	Bottom	Right	Left	Front	Rear
Ant0	11b	2472	19.00	79	2	51	51	10	3	10	-MEASURE-	0.400	0.400	-MEASURE-	-MEASURE-	-MEASURE-
Ant0	11g	2472	18.00	63	2	51	51	10	3	10	-MEASURE-	0.400	0.400	-MEASURE-	-MEASURE-	-MEASURE-
Ant0	11n HT20	2472	18.00	63	2	51	51	10	3	10	-MEASURE-	0.400	0.400	-MEASURE-	-MEASURE-	-MEASURE-
Ant0	11n HT40	2472	10.00	10	2	51	51	10	3	10	-MEASURE-	0.400	0.400	-MEASURE-	-MEASURE-	-MEASURE-
Ant0	BT	2480	3.00	2	2	51	51	10	3	10	0.084	0.400	0.400	0.084	0.084	0.084

Estimated SAR

Antenna	Tx Interface	Frequency (MHz)	Output Power		Separation Distances (mm)						Estimated 1-g SAR Value (W/kg)					
			dBm	mW	Top	Bottom	Right	Left	Front	Rear	Top	Bottom	Right	Left	Front	Rear
Ant0	11a	5320	15.00	32	2	51	51	10	3	10	-MEASURE-	0.400	0.400	-MEASURE-	-MEASURE-	-MEASURE-
Ant0	11n HT20	5320	15.00	32	2	51	51	10	3	10	-MEASURE-	0.400	0.400	-MEASURE-	-MEASURE-	-MEASURE-
Ant0	11n HT40	5320	15.00	32	2	51	51	10	3	10	-MEASURE-	0.400	0.400	-MEASURE-	-MEASURE-	-MEASURE-
Ant0	11ac VHT80	5320	10.50	11	2	51	51	10	3	10	-MEASURE-	0.400	0.400	-MEASURE-	-MEASURE-	-MEASURE-

Estimated SAR

Antenna	Tx Interface	Frequency (MHz)	Output Power		Separation Distances (mm)						Estimated 1-g SAR Value (W/kg)					
			dBm	mW	Top	Bottom	Right	Left	Front	Rear	Top	Bottom	Right	Left	Front	Rear
Ant1	11b	2472	19.00	79	1	51	41	51	3	5	-MEASURE-	0.400	-MEASURE-	0.400	-MEASURE-	-MEASURE-
Ant1	11g	2472	18.00	63	1	51	41	51	3	5	-MEASURE-	0.400	-MEASURE-	0.400	-MEASURE-	-MEASURE-
Ant1	11n HT20	2472	18.00	63	1	51	41	51	3	5	-MEASURE-	0.400	-MEASURE-	0.400	-MEASURE-	-MEASURE-
Ant1	11n HT40	2472	10.00	10	1	51	41	51	3	5	-MEASURE-	0.400	-MEASURE-	0.400	-MEASURE-	-MEASURE-

Estimated SAR

Antenna	Tx Interface	Frequency (MHz)	Output Power		Separation Distances (mm)						Estimated 1-g SAR Value (W/kg)					
			dBm	mW	Top	Bottom	Right	Left	Front	Rear	Top	Bottom	Right	Left	Front	Rear
Ant1	11a	5320	15.00	32	1	51	41	51	3	5	-MEASURE-	0.400	-MEASURE-	0.400	-MEASURE-	-MEASURE-
Ant1	11n HT20	5320	15.00	32	1	51	41	51	3	5	-MEASURE-	0.400	-MEASURE-	0.400	-MEASURE-	-MEASURE-
Ant1	11n HT40	5320	15.00	32	1	51	41	51	3	5	-MEASURE-	0.400	-MEASURE-	0.400	-MEASURE-	-MEASURE-
Ant1	11ac VHT80	5320	10.50	11	1	51	41	51	3	5	-MEASURE-	0.400	-MEASURE-	0.400	-MEASURE-	-MEASURE-

Notes:

1. The upper frequency of the frequency band was used in order to calculate standalone SAR test exclusion considerations.
2. Power and distance are rounded to the nearest mW and mm before calculation
3. The result is rounded to one decimal place for comparison
4. When the minimum test separation distance is < 5 mm, a distance of 5 mm is applied. For antennas ≤ 50 mm from the bottom side or edge the separation distance used for the SAR exclusion calculations is 5 mm.
5. When the separation of antenna to EUT's surfaces and edges are 50 mm $<$, the separation distance used is 51 mm.

5.4 Description of the operating mode

Setting

*The power value of the EUT was set for testing as follows (setting value might be different from product specification value);

Power settings: Refer to section 5.5.

Software: Dut labtool version 2.0.0.83

*This setting of software is the worst case.

The test was performed with condition that obtained the maximum average power in pre-check.

Any conditions under the normal use do not exceed the condition of setting.

In addition, end users cannot change the settings of the output power of the product.

5.5 Output Power and SAR test required for WLAN

According to KDB 248227D01The initial test configuration for 2.4 GHz and 5 GHz OFDM transmission modes is determined by the 802.11 configuration with the highest maximum output power specified for production units, including tune-up tolerance, in each standalone and aggregated frequency band. SAR for the initial test configuration is measured using the highest maximum output power channel determined by the default power measurement procedures. When multiple configurations in a frequency band have the same specified maximum output power, the initial test configuration is determined according to the following steps applied sequentially.

1. The largest channel bandwidth configuration is selected among the multiple configurations with the same specified maximum output power.
2. If multiple configurations have the same specified maximum output power and largest channel bandwidth, the lowest order modulation among the largest channel bandwidth configurations is selected.
3. If multiple configurations have the same specified maximum output power, largest channel bandwidth and lowest order modulation, the lowest data rate configuration among these configurations is selected.
4. When multiple transmission modes (802.11a/g/n/ac) have the same specified maximum output power, largest channel bandwidth, lowest order modulation and lowest data rate, the lowest order 802.11 mode is selected; i.e., 802.11a is chosen over 802.11n then 802.11ac or 802.11g is chosen over 802.11n.

Wi-Fi 2.4GHz (DTS Band)

SISO

Band (GHz)	Mode	Data Rate	Ch #	Freq. (MHz)	Measured average Power (dBm)		Maximum tune-up tolerance limit (dBm)		Initial SAR Test (Yes/No)	Note(s)	Ant0 Tx	Ant1 Tx
					An0t Tx	Ant1 Tx	An0t Tx	Ant1 Tx			Power setting (dBm)	Power setting (dBm)
2.4	802.11b	1 Mbps	1	2412	17.67	17.19	19.00	19.00	Yes	3	17.5	17.5
			6	2437	17.54	17.08					17.5	17.5
			11	2462	17.41	17.16	17.5	17.5				
			12	2467	8.60	8.28	10.00	10.00				
			13	2472	3.35	3.34	5.00	5.00				
	802.11g	6 Mbps	1	2412	16.23	16.69	18.00	18.00	No	1	16.5	17.5
			6	2437	16.29	16.70					16.5	17.5
			11	2462	16.08	16.75	16.5	17.5				
			12	2467	8.43	8.85	10.00	10.00				
	802.11n (HT20)	6.5 Mbps	1	2412	16.11	16.69	18.00	18.00	No	1	16.5	17.5
			6	2437	16.29	16.68					16.5	17.5
			11	2462	16.24	16.75	16.5	17.5				
			12	2467	8.37	8.85	10.00	10.00				
	802.11n (HT40)	13.5 Mbps	3	2422	9.12	8.32	10.00	10.00	No	1	8.5	8.5
			7	2442	9.13	8.48					8.5	8.5
			11	2462	9.38	8.62	8.5	8.5				
13			2472	3.34	3.83	5.00	5.00					

MIMO

Band (GHz)	Mode	Data Rate	Ch #	Freq. (MHz)	Measured average Power (dBm)	Maximum tune-up tolerance limit (dBm)	Initial SAR Test (Yes/No)	Note(s)
					Ant0&Ant1 Simultaneous Tx	Ant0&Ant1 Simultaneous Tx		
2.4	802.11n (HT20)	6.5 Mbps	1	2412	-	13.50	No	2
			6	2437	-			
			11	2462	-			
			12	2467	-			
	13	2472	-	7.00				
	802.11n (HT40)	13.5 Mbps	3	2422	-	9.50	No	2
			7	2442	-			
10			2457	-	7.00			
			11	2462	-			

Note(s):

1. According to KDB248227D01, SAR is required for 802.11g/n HT20 channels when the highest reported SAR for DSSS is adjusted by the ratio of OFDM to DSSS specified maximum output power and the adjusted SAR is >1.2 W/kg.
2. The standalone (SISO) SAR results were considered acceptable for the MIMO simultaneous transmission analysis as the MIMO power does not exceed the SISO power. The antenna separation distance will not be less than 50mm.
3. SAR test channel was chosen. (shaded blue frame)

Wi-Fi 5GHz (U-NII-1 and U-NII-2A Bands)
SISO

Band (GHz)	Mode	Data Rate	Ch #	Freq. (MHz)	Measured average Power (dBm)		Maximum tune-up tolerance limit (dBm)		Initial SAR Test (Yes/No)	Note(s)	Ant0 Tx Power setting (dBm)	Ant1 Tx Power setting (dBm)
					An0 Tx	Ant1 Tx	An0 Tx	Ant1 Tx				
5.2 (U-NII-1)	802.11a	6 Mbps	36	5180	13.77	13.67	15.00	15.00	No	2	13.5	13.5
			40	5200	13.60	13.70					13.5	13.5
			44	5220	13.67	13.58					13.5	13.5
			48	5240	13.65	13.68					13.5	13.5
	802.11n (HT20)	6.5 Mbps	36	5180	13.61	13.56	15.00	15.00	No	2	13.5	13.5
			40	5200	13.60	13.64					13.5	13.5
			44	5220	13.50	13.49					13.5	13.5
			48	5240	13.38	13.61					13.5	13.5
	802.11ac (VHT20)	6.5 Mbps	36	5180	13.43	13.60	15.00	15.00	No	2	13.5	13.5
			40	5200	13.66	13.57					13.5	13.5
			44	5220	13.42	13.58					13.5	13.5
			48	5240	13.54	13.53					13.5	13.5
	802.11n (HT40)	13.5 Mbps	38	5190	10.16	10.57	11.50	11.50	No	2	10	10
			46	5230	13.07	13.26	15.00	15.00			13.5	13.5
802.11ac (VHT40)	13.5 Mbps	38	5190	10.15	10.43	11.50	11.50	No	2	10	10	
		46	5230	13.06	13.20	15.00	15.00			13.5	13.5	
802.11ac (VHT80)	29.3 Mbps	42	5210	9.32	8.90	10.50	10.50	No	2	9	9	
5.3 (U-NII-2A)	802.11a	6 Mbps	52	5260	14.67	13.79	15.00	15.00	No	1	13.5	13.5
			56	5280	14.66	13.77					13.5	13.5
			60	5300	14.48	13.71					13.5	13.5
			64	5320	14.48	13.73					13.5	13.5
	802.11n (HT20)	6.5 Mbps	52	5260	14.64	13.74	15.00	15.00	No	1	13.5	13.5
			56	5280	14.56	13.64					13.5	13.5
			60	5300	14.56	13.60					13.5	13.5
			64	5320	14.53	13.52					13.5	13.5
	802.11ac (VHT20)	6.5 Mbps	52	5260	14.66	14.01	15.00	15.00	No	1	13.5	13.5
			56	5280	14.53	13.99					13.5	13.5
			60	5300	14.58	13.84					13.5	13.5
			64	5320	14.46	13.77					13.5	13.5
	802.11n (HT40)	13.5 Mbps	54	5270	14.14	13.34	15.00	15.00	Yes	4	13.5	13.5
			62	5310	13.98	13.13	13.5	13.5				
802.11ac (VHT40)	13.5 Mbps	54	5270	14.12	13.32	15.00	15.00	No	1	13.5	13.5	
		62	5310	13.96	13.12	13.5	13.5					
802.11ac (VHT80)	29.3 Mbps	58	5290	9.37	8.80	10.50	10.50	No	1	9	9	

MIMO

Band (GHz)	Mode	Data Rate	Ch #	Freq. (MHz)	Measured average Power (dBm)	Maximum tune-up tolerance limit (dBm)	Initial SAR Test (Yes/No)	Note(s)
					Ant0&Ant1 Simultaneous Tx	Ant0&Ant1 Simultaneous Tx		
5.2 (U-NII-1)	802.11n (HT20)	6.5 Mbps	36	5180	-	12.00	No	3
			40	5200	-			
			44	5220	-			
			48	5240	-			
	802.11ac (VHT20)	6.5 Mbps	36	5180	-	12.00	No	3
			40	5200	-			
			44	5220	-			
			48	5240	-			
	802.11n (HT40)	13.5 Mbps	38	5190	-	8.50	No	3
			46	5230	-	12.00		
	802.11ac (VHT40)	13.5 Mbps	38	5190	-	8.50	No	3
			46	5230	-	12.00		
802.11ac (VHT80)	29.3 Mbps	42	5210	-	7.50	No	3	
5.3 (U-NII-2A)	802.11n (HT20)	6.5 Mbps	52	5260	-	12.00	No	3
			56	5280	-			
			60	5300	-			
			64	5320	-			
	802.11ac (VHT20)	6.5 Mbps	52	5260	-	12.00	No	3
			56	5280	-			
			60	5300	-			
			64	5320	-			
	802.11n (HT40)	13.5 Mbps	54	5270	-	12.00	No	3
			62	5310	-	-		
	802.11ac (VHT40)	13.5 Mbps	54	5270	-	12.00	No	3
			62	5310	-	-		
802.11ac (VHT80)	29.3 Mbps	58	5290	-	7.50	No	3	

Note(s):

- When the same transmission mode configurations have the same maximum output power on the same channel for the 802.11 a/g/n/ac modes, the channel with the largest bandwidth and lowest data rate is selected.
- When the specified maximum output power is the same for both UNII band I and UNII band 2A, begin SAR measurement in UNII band 2A; and if the highest *reported* SAR for UNII band 2A is
 - ≤ 1.2 W/kg, SAR is not required for UNII band I
 - > 1.2 W/kg, both bands should be tested independently for SAR.
- The standalone (SISO) SAR results were considered acceptable for the MIMO simultaneous transmission analysis as the MIMO power does not exceed the SISO power. The antenna separation distance will not be less than 50mm.
- According to KDB248227D01, SAR test channel was chosen. (shaded blue frame)

Duty factor conformation

11b 1 Mbps

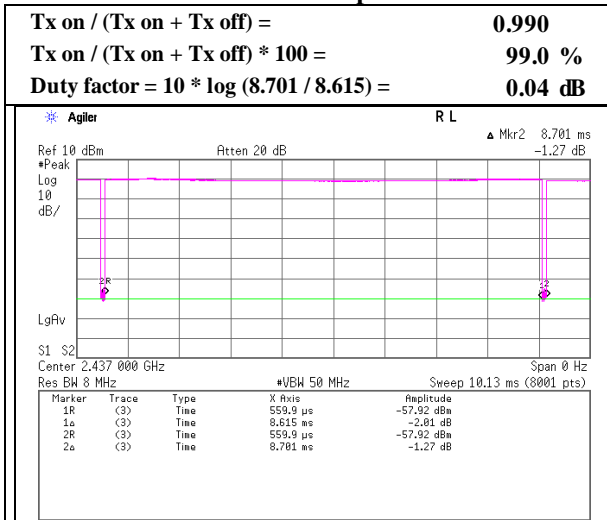

11g 6 Mbps

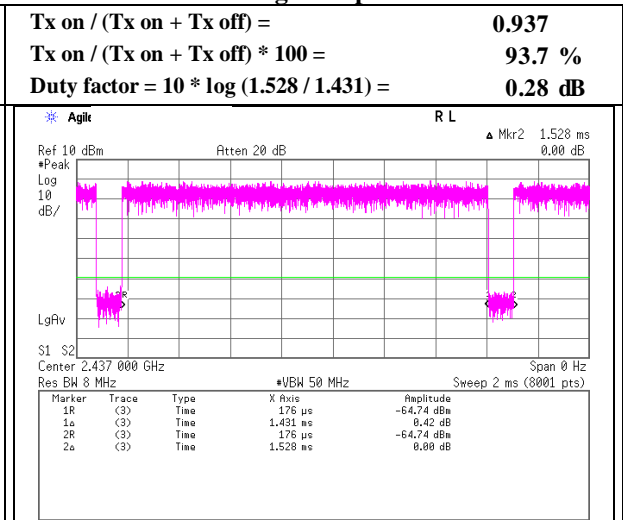

11n HT20 MCS 0 SISO (2.4GHz)

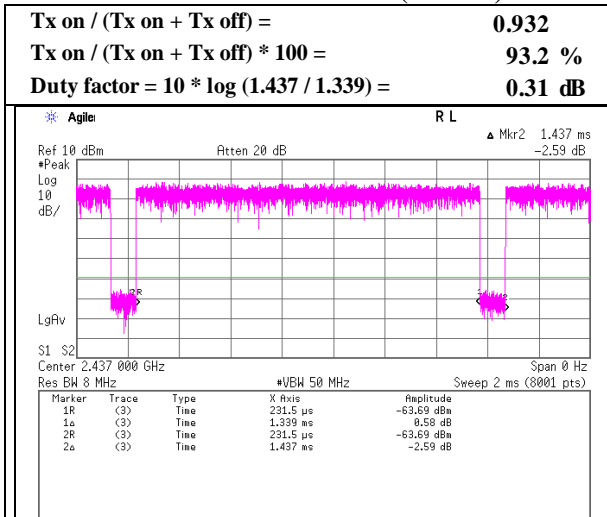

11n HT40 MCS0 SISO (2.4GHz)

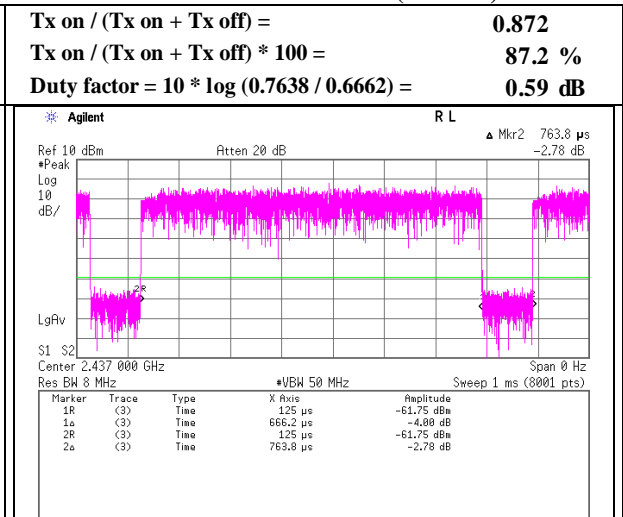

11n HT20 MCS 0 MIMO (2.4GHz)

Tx on / (Tx on + Tx off) = 0.878
Tx on / (Tx on + Tx off) * 100 = 87.8 %
Duty factor = 10 * log (0.791 / 0.6946) = 0.56 dB

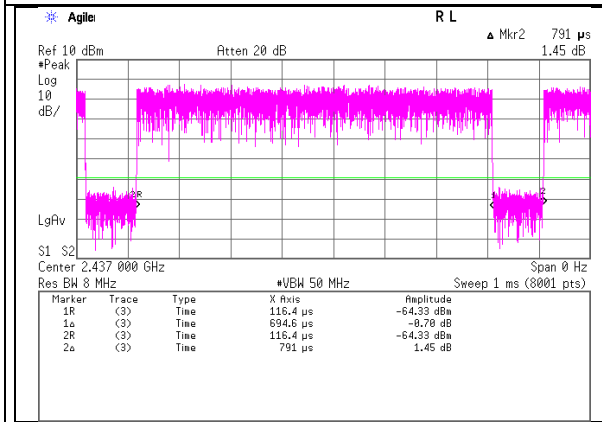

11n HT40 MCS0 MIMO (2.4GHz)

Tx on / (Tx on + Tx off) = 0.786
Tx on / (Tx on + Tx off) * 100 = 78.6 %
Duty factor = 10 * log (0.456 / 0.3584) = 1.05 dB

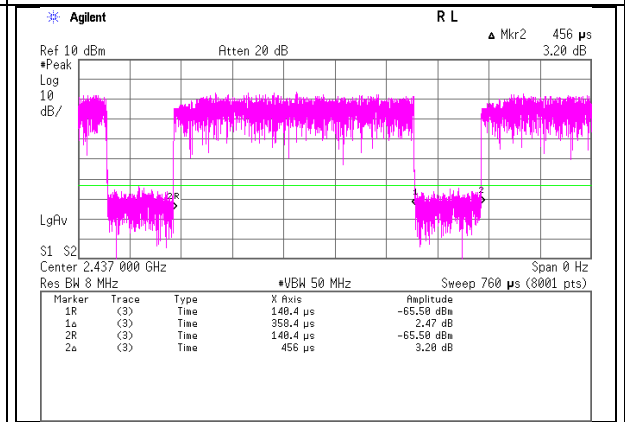

11a 6Mbps

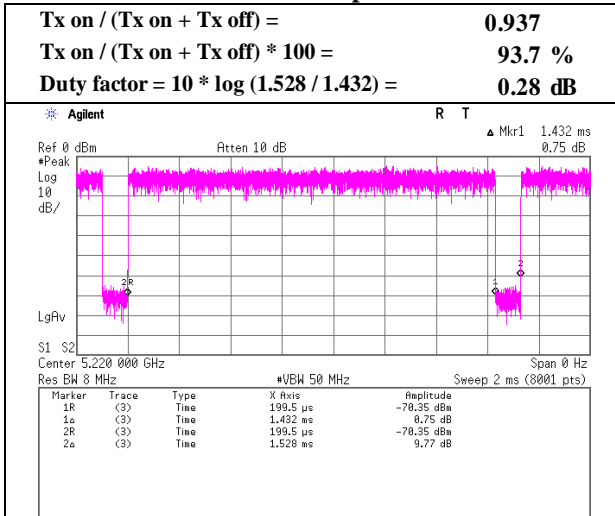

11n HT20 MCS0 SISO(5GHz)

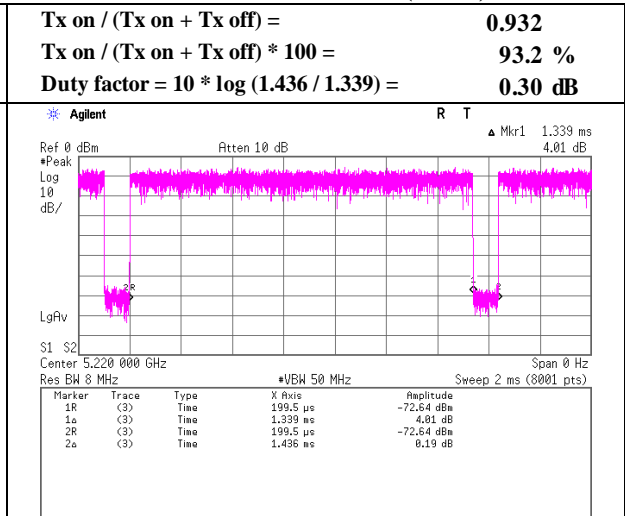

11n HT40 MCS 0 SISO(5GHz)

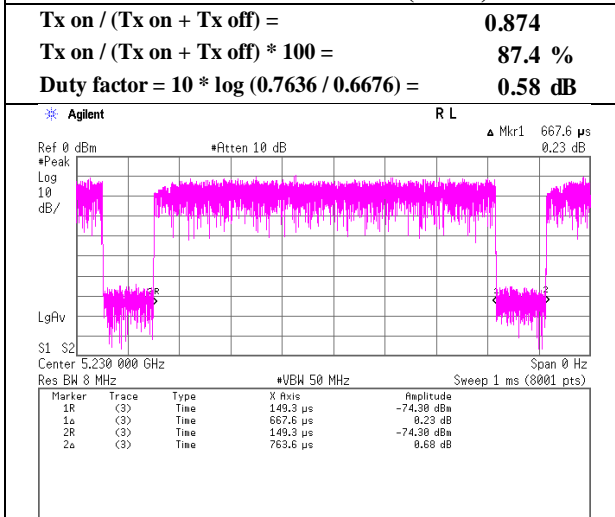

11ac HT20 MCS0 SISO(5GHz)

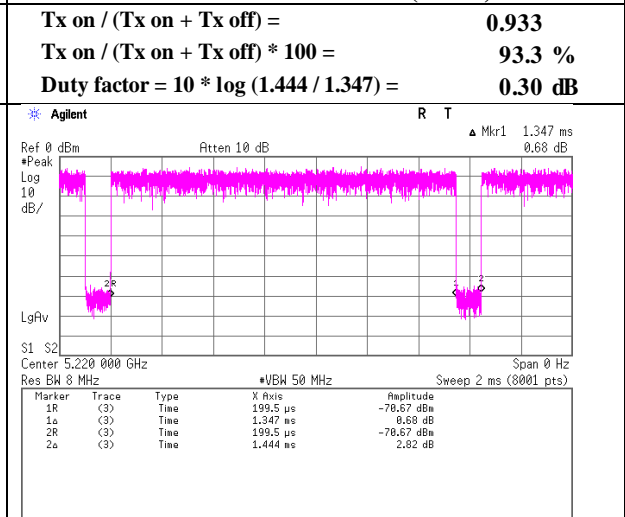

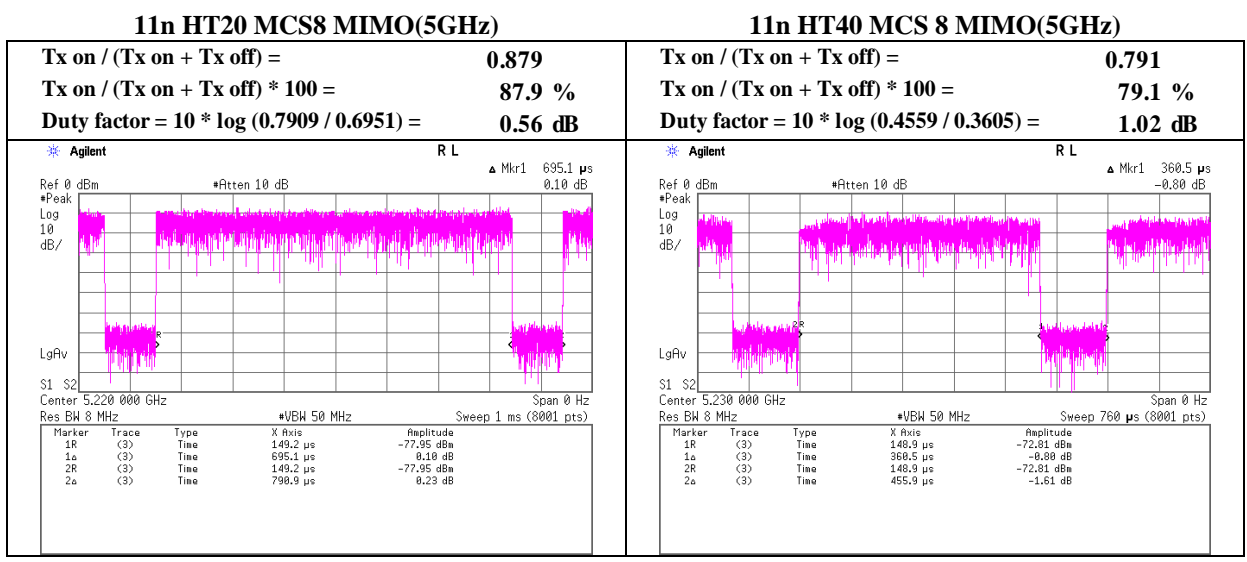
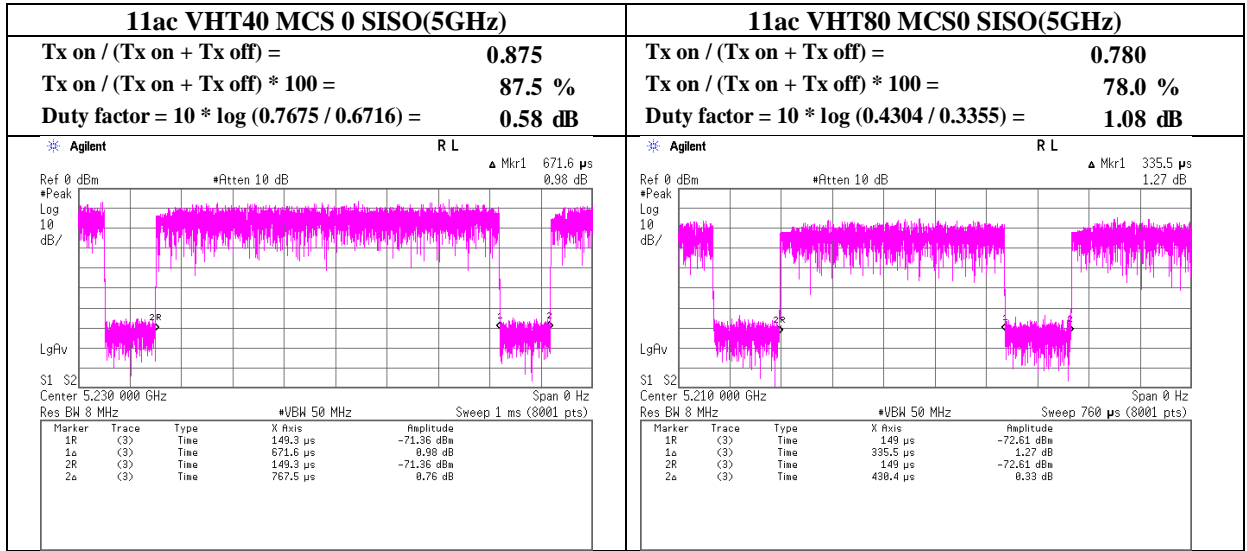

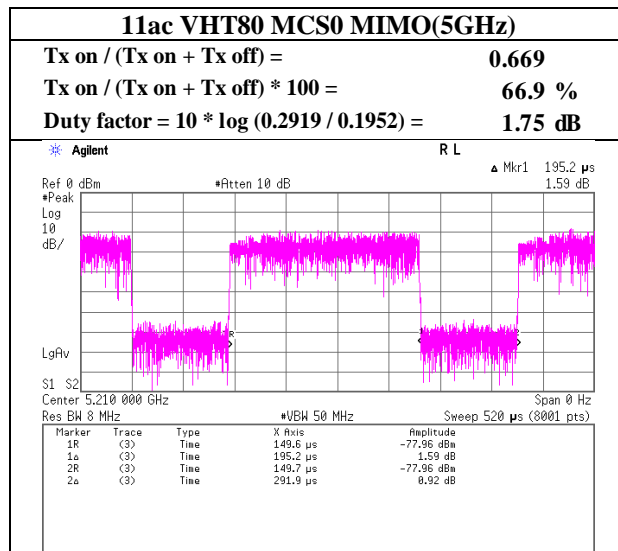
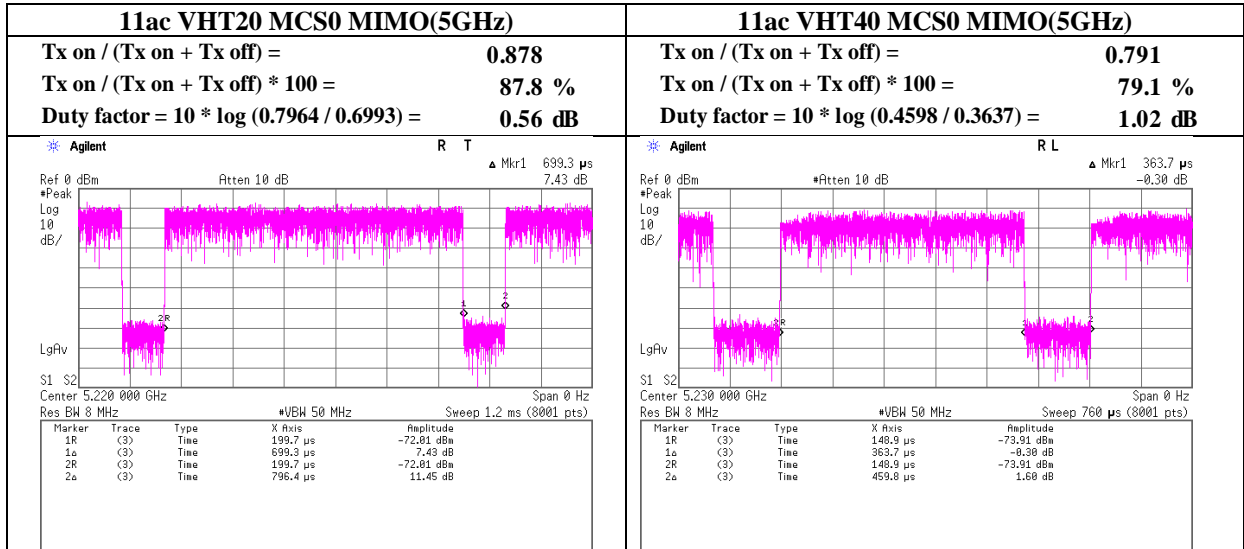

5.6 Output Power and SAR test required for Bluetooth

Band (GHz)	Mode	Data Rate	Ch #	Freq. (MHz)	Measured average Power (dBm)	Maximum tune-up tolerance limit (dBm)	Initial SAR Test (Yes/No)	Note(s)
					BT Tx	BT Tx		
2.4	BDR	DH5	0	2402	-	3.00	No	Refer to section 5.1
			39	2441	-			
			78	2480	-			
	EDR	2DH5	0	2402	-	3.00	No	Refer to section 5.1
			39	2441	-			
			78	2480	-			
	EDR	3DH5	0	2402	-	3.00	No	Refer to section 5.1
			39	2441	-			
			78	2480	-			
	LE	-	0	2402	-	3.00	No	Refer to section 5.1
			19	2440	-			
			39	2480	-			

Duty factor conformation

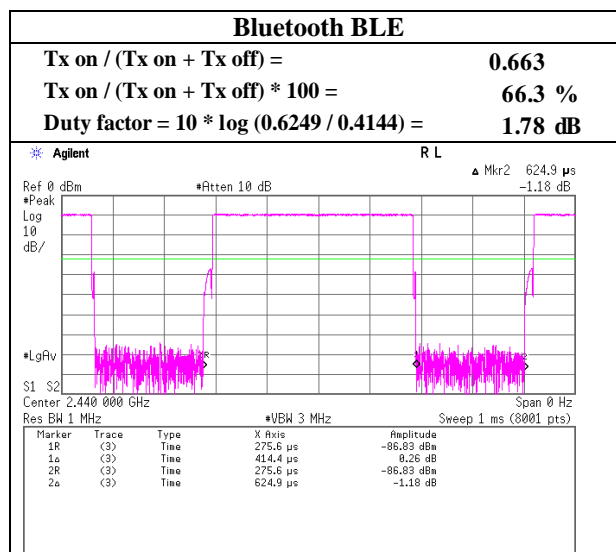
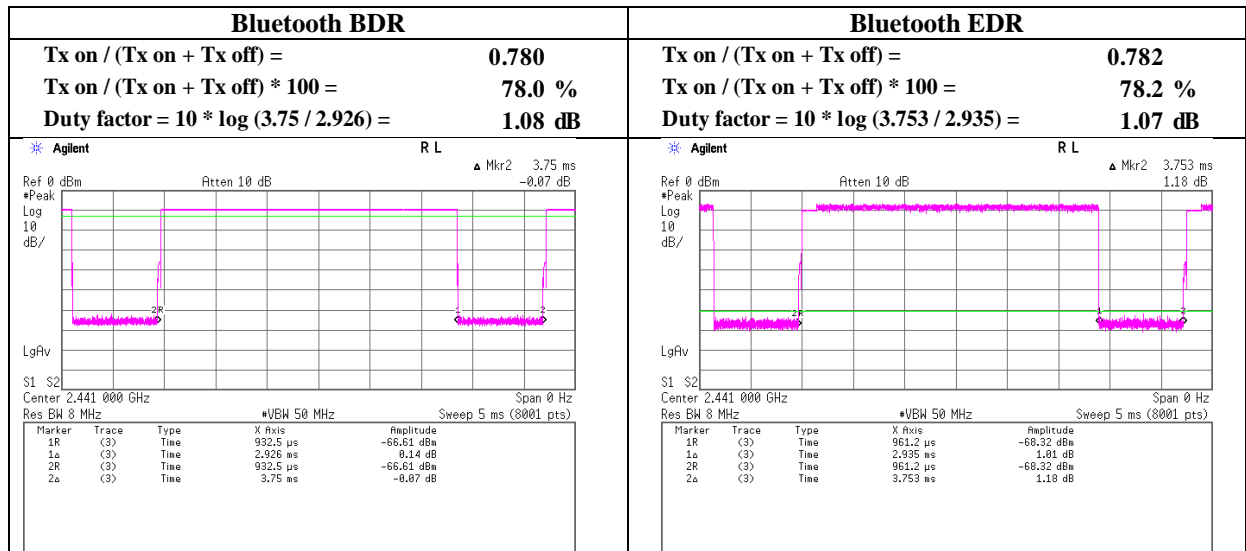

SECTION6: Description of the Body setup

6.1 Procedure for SAR testing

-The tested procedure was performed according to the KDB 941225 D07 (SAR Evaluation Procedures for UMPC Mini-Tablet Devices)and KDB 447498 D01 (Mobile and Portable Device RF Exposure Procedures and Equipment Authorization Policies).

6.2 Test position for Body setup

Refer to section 5.1 to 5.3.

No.	Position	Test distance	WLAN ant0	WLAN ant1	Bluetooth
			Tested	Tested	Tested
1	Top	5 mm	<input checked="" type="checkbox"/>	<input checked="" type="checkbox"/>	<input type="checkbox"/> *1
2	Bottom	5 mm	<input type="checkbox"/>	<input type="checkbox"/>	<input type="checkbox"/>
3	Right	5 mm	<input type="checkbox"/>	<input type="checkbox"/>	<input type="checkbox"/>
4	Left	5 mm	<input checked="" type="checkbox"/>	<input type="checkbox"/> *1	<input type="checkbox"/> *1
5	Front	5 mm	<input checked="" type="checkbox"/>	<input checked="" type="checkbox"/>	<input type="checkbox"/> *1
6	Rear	5 mm	<input checked="" type="checkbox"/>	<input checked="" type="checkbox"/>	<input type="checkbox"/> *1

*1 In case of simultaneous transmission evaluation, this position used the estimated SAR value.

SECTION7: Test surrounding

7.1 Measurement uncertainty

This measurement uncertainty budget is suggested by IEEE Std 1528(2013) and IEC62209-2:2010, and determined by Schmid & Partner Engineering AG (DASY5 Uncertainty Budget). Per KDB 865664 D01 SAR Measurement 100 MHz to 6 GHz Section 2.8.1., when the highest measured SAR(1g) within a frequency band is < 1.5W/kg, the extensive SAR measurement uncertainty analysis described in IEEE Std.1528 (2013) is not required in SAR reports submitted for equipment approval.

<0.3 – 3GHz range Body>

Error Description	Uncertain value ± %	Probability distribution	divisor	(ci) 1g	Standard (1g)
Measurement System					
Probe calibration	± 6.00	Normal	1	1	± 6.00
Axial isotropy of the probe	± 4.7	Rectangular	√3	0.7	± 1.9
Spherical isotropy of the probe	± 9.6	Rectangular	√3	0.7	± 3.9
Boundary effects	± 1.0	Rectangular	√3	1	± 0.6
Probe linearity	± 4.7	Rectangular	√3	1	± 2.7
Detection limit	± 1.0	Rectangular	√3	1	± 0.6
Modulation response	± 2.4	Rectangular	√3	1	± 1.4
Readout electronics	± 0.3	Normal	1	1	± 0.3
Response time	± 0.8	Rectangular	√3	1	± 0.5
Integration time	± 2.6	Rectangular	√3	1	± 1.5
RF ambient Noise	± 3.0	Rectangular	√3	1	± 1.7
RF ambient Reflections	± 3.0	Rectangular	√3	1	± 1.7
Probe Positioner	± 0.4	Rectangular	√3	1	± 0.2
Probe positioning	± 2.9	Rectangular	√3	1	± 1.7
Max.SAR Eval.	± 2.0	Rectangular	√3	1	± 1.2
Test Sample Related					
Device positioning	± 2.9	Normal	1	1	± 2.9
Device holder uncertainty	± 3.6	Normal	1	1	± 3.6
Power drift	± 5.0	Rectangular	√3	1	± 2.9
Power Scaling	+ 0.0	Rectangular	√3	1	± 0.0
Phantom and Setup					
Phantom uncertainty	± 6.1	Rectangular	√3	1	± 3.5
Algorithm for correcting SAR for deviations in permittivity and conductivity	± 1.9	Rectangular	√3	1	± 1.1
Liquid conductivity (meas.)	+ 3.6	Rectangular	√3	0.78	+ 1.6
Liquid permittivity (meas.)	- 3.4	Rectangular	√3	0.26	- 0.5
Liquid conductivity - temp.unc (below 2deg.C.)	± 5.2	Rectangular	√3	0.78	± 2.3
Liquid permittivity - temp.unc (below 2deg.C.)	± 0.8	Rectangular	√3	0.23	± 0.1
Combined Standard Uncertainty					± 11.283
Expanded Uncertainty (k=2)					± 22.6

*. Table of uncertainties are listed for ISO/IEC 17025.

<3 – 6GHz range Body>

Error Description	Uncertain value \pm	Probability distribution	divisor	(ci) 1g	Standard (1g)
Measurement System					
Probe calibration	\pm 6.55	Normal	1	1	\pm 6.55
Axial isotropy of the probe	\pm 4.7	Rectangular	$\sqrt{3}$	0.7	\pm 1.9
Spherical isotropy of the probe	\pm 9.6	Rectangular	$\sqrt{3}$	0.7	\pm 3.9
Boundary effects	\pm 1.0	Rectangular	$\sqrt{3}$	1	\pm 0.6
Probe linearity	\pm 4.7	Rectangular	$\sqrt{3}$	1	\pm 2.7
Detection limit	\pm 1.0	Rectangular	$\sqrt{3}$	1	\pm 0.6
Modulation response	\pm 2.4	Rectangular	$\sqrt{3}$	1	\pm 1.4
Readout electronics	\pm 0.3	Normal	1	1	\pm 0.3
Response time	\pm 0.8	Rectangular	$\sqrt{3}$	1	\pm 0.5
Integration time	\pm 2.6	Rectangular	$\sqrt{3}$	1	\pm 1.5
RF ambient Noise	\pm 3.0	Rectangular	$\sqrt{3}$	1	\pm 1.7
RF ambient Reflections	\pm 3.0	Rectangular	$\sqrt{3}$	1	\pm 1.7
Probe Positioner	\pm 0.4	Rectangular	$\sqrt{3}$	1	\pm 0.2
Probe positioning	\pm 2.9	Rectangular	$\sqrt{3}$	1	\pm 1.7
Max.SAR Eval.	\pm 2.0	Rectangular	$\sqrt{3}$	1	\pm 1.2
Test Sample Related					
Device positioning	\pm 2.9	Normal	1	1	\pm 2.9
Device holder uncertainty	\pm 3.6	Normal	1	1	\pm 3.6
Power drift	\pm 5.0	Rectangular	$\sqrt{3}$	1	\pm 2.9
Power Scaling	+ 0.0	Rectangular	$\sqrt{3}$	1	\pm 0.0
Phantom and Setup					
Phantom uncertainty	\pm 6.1	Rectangular	$\sqrt{3}$	1	\pm 3.5
Algorithm for correcting SAR for deviations in permittivity and conductivity	\pm 1.9	Rectangular	$\sqrt{3}$	1	\pm 1.1
Liquid conductivity (meas.)	+ 2.2	Rectangular	$\sqrt{3}$	0.78	+ 1.0
Liquid permittivity (meas.)	- 4.6	Rectangular	$\sqrt{3}$	0.26	- 0.7
Liquid conductivity - temp.unc (below 2deg.C.)	\pm 5.2	Rectangular	$\sqrt{3}$	0.78	\pm 2.3
Liquid permittivity - temp.unc (below 2deg.C.)	\pm 0.8	Rectangular	$\sqrt{3}$	0.23	\pm 0.1
Combined Standard Uncertainty					\pm 11.522
Expanded Uncertainty (k=2)					\pm 23.0

*. Table of uncertainties are listed for ISO/IEC 17025.

SECTION8: Parameter Check

The dielectric parameters were checked prior to assessment using the DAK dielectric probe kit.
The dielectric parameters measurement is reported in each correspondent section.

According to KDB865664 D01, +/- 5% tolerances are required for ϵ_r and σ and then below table which is the target value of the simulated tissue liquid is quoted from KDB865664 D01.

Target Frequency (MHz)	Head		Body	
	ϵ_r	σ (S/m)	ϵ_r	σ (S/m)
150	52.3	0.76	61.9	0.80
300	45.3	0.87	58.2	0.92
450	43.5	0.87	56.7	0.94
835	41.5	0.90	55.2	0.97
900	41.5	0.97	55.0	1.05
915	41.5	0.98	55.0	1.06
1450	40.5	1.20	54.0	1.30
1610	40.3	1.29	53.8	1.40
1800 – 2000	40.0	1.40	53.3	1.52
2450	39.2	1.80	52.7	1.95
3000	38.5	2.40	52.0	2.73
5800	35.3	5.27	48.2	6.00

(ϵ_r = relative permittivity, σ = conductivity and ρ = 1000 kg/m³)

For SAR system check

DIELECTRIC PARAMETERS MEASUREMENT RESULTS											
Date	Ambient Temp. [deg.c]	Relative Humidity [%]	Liquid type	Liquid Temp. [deg.c]	Measured Frequency [MHz]	Parameters	Target Value*1	Measured	Deviation [%]	Limit [%]	Remark
2016/11/14	24.0	45	MSL 2450	23.5	2450	σ [mho/m]	1.95	2.03	3.8	+/-5	*1
						ϵ_r	52.7	50.9	-3.4	+/-5	
2016/11/17	24.0	45	MBBL 3.5-5.8	23.5	5250	σ [mho/m]	5.36	5.45	1.7	+/-5	*2
						ϵ_r	48.9	46.8	-4.4	+/-5	

For SAR measurement

DIELECTRIC PARAMETERS MEASUREMENT RESULTS											
Date	Ambient Temp. [deg.c]	Relative Humidity [%]	Liquid type	Liquid Temp. [deg.c]	Measured Frequency [MHz]	Parameters	Target Value*1	Measured	Deviation [%]	Limit [%]	Remark
2016/11/14	24.0	45	MSL 2450	23.5	2412	σ [mho/m]	1.91	1.97	3.0	+/-5	*2
						ϵ_r	52.8	51.0	-3.3	+/-5	
2016/11/14	24.0	45	MSL 2450	23.5	2437	σ [mho/m]	1.94	2.01	3.6	+/-5	*2
						ϵ_r	52.7	50.9	-3.4	+/-5	
2016/11/14	24.0	45	MBBL 3.5-5.8	23.5	5270	σ [mho/m]	5.38	5.50	2.2	+/-5	*2
						ϵ_r	48.9	46.7	-4.6	+/-5	

For SAR measurement

σ : Conductivity / ϵ_r : Relative Permittivity

*1 The Target value is a parameter defined in KDB 865664D01.

*2 The dielectric parameters should be linearly interpolated between the closest pair of target frequencies to determine the applicable dielectric parameters corresponding to the device test frequency.

Correlation confirmation with measured TSL parameters of the calibration certificate of system validation dipoles (Refer to Appendix 2)

+/- 6% limit for deviation provided by manufacture tolerances are required for ϵ_r and σ and then below table which is the target value of the simulated tissue liquid is quoted from data measured TSL parameters of dipole calibration.

Freq [MHz]	Model,S/N	Head		Body	
		ϵ	σ	ϵ	σ
2450	D2450,713	37.9	1.88	51.6	2.04
5250	D5GHV2,1020	35.2	4.55	47	5.44
5600	D5GHV2,1020	34.7	4.9	46.4	5.91
5750	D5GHV2,1020	34.5	5.05	46.1	6.12

DIELECTRIC PARAMETERS MEASUREMENT RESULTS											
Date	Ambient Temp. [deg.c]	Relative Humidity [%]	Liquid type	Liquid Temp. [deg.c]	Measured Frequency [MHz]	Parameters	Target Value*1	Measured	Deviation [%]	Limit [%]	Remark
2016/11/14	24.0	45	MSL 2450	23.5	2450	σ [mho/m]	2.04	2.03	-0.7	+/-6	*1
						ϵ_r	51.6	50.9	-1.3	+/-6	
2016/11/17	24.0	45	MBBL 3.5-5.8	23.5	5250	σ [mho/m]	5.44	5.45	0.2	+/-6	*1
						ϵ_r	47.0	46.8	-0.5	+/-6	

ϵ_r : Relative Permittivity / σ : Conductivity

*1 The Target value is a parameter defined in each Dipole.

SECTION9: System Check confirmation

The measurements were performed in the flat section of the TWIN SAM or ELI phantom, shell thickness: 2.0 ±0.2 mm (bottom plate) filled with Body or Head simulating liquid of the following parameters.

The depth of tissue-equivalent liquid in a phantom must be ≥ 15.0 cm ± 0.5 cm for SAR measurements ≤ 3 GHz and ≥ 10.0 cm ± 0.5 cm for measurements > 3 GHz.

The DASY system with an E-Field Probe was used for the measurements.

The dipole was mounted on the small tripod so that the dipole feed point was positioned below the center marking of the flat phantom section and the dipole was oriented parallel to the body axis (the long side of the phantom).

The standard measuring distance was 10 mm (above 1GHz to 6GHz) and 15 mm (below 1GHz) from dipole center to the simulating liquid surface.

The coarse grid with a grid spacing of 12 mm (1GHz to 3GHz) and 15 mm (below 1GHz) was aligned with the dipole.

For 5 GHz band - The coarse grid with a grid spacing of 10 mm was aligned with the dipole.

Special 7x7x7 (below 3 GHz) and/or 8x8x7 (above 3 GHz) fine cube was chosen for the cube.

Distance between probe sensors and phantom surface was set to 3 mm.

For 5 GHz band - Distance between probe sensors and phantom surface was set to 2.5 mm

The dipole input power (forward power) was 100 mW(For 5GHz band) or 250 mW(For other band).

The results are normalized to 1 W input power.

Freq [MHz]	Model,S/N	Head		Body	
		(SPEAG) 1g [W/kg]	(SPEAG) 10g[W/kg]	(SPEAG) 1g [W/kg]	(SPEAG) 10g[W/kg]
2450	D2450,713	53.6	24.92	52	24.44
5250	D5GHV2,1020	80	23.1	73.6	20.9
5600	D5GHV2,1020	84.2	24.3	78.2	22.1
5750	D5GHV2,1020	79.6	22.8	73.9	20.7

*1 The target(reference) SAR values can be obtained from the calibration certificate of system validation dipoles(Refer to Appendix 2). The target SAR values are SAR measured value in the calibration certificate scaled to 1W.

Date Tested	Test Freq	Model,S/N	T.S. Liquid	Measured Results		Target (Ref. Value)	Delta ±10 %	
				Zoom Scan	Normalize to 1 W			
11/14/2016	2450	D2450,713	Body	1g	13.40	53.6	52.00	3.1
				10g	6.18	24.7	24.44	1.1
11/17/2016	5250	D5GHV2,1020	Body	1g	7.55	75.5	73.60	2.6
				10g	2.11	21.10	20.90	1.0

SECTION10: SAR Test data for WLAN

10.1 Result of Body SAR

2.4GHz Band
Ant 0 Tx

Test Position	Mode	Dist. (mm)	Ch #.	Freq. (MHz)	Duty [%]	Duty scaled factor	Power (dBm)		Power scaled factor	1-g SAR (W/kg)	
							Tune-up limit	Meas.		Meas.	Reported
Top	802.11b	5	1	2412	99.0	1.01	19.00	17.67	1.36	0.767	1.052
			6	2437	99.0	1.01	19.00	17.54	1.40	0.682	0.964
			11	2462	99.0	1.01	19.00	17.41	1.44		
Left	802.11b	5	1	2412	99.0	1.01	19.00	17.67	1.36	0.164	0.225
			6	2437	99.0	1.01	19.00	17.54	1.40		
			11	2462	99.0	1.01	19.00	17.41	1.44		
Front	802.11b	5	1	2412	99.0	1.01	19.00	17.67	1.36	0.614	0.842
			6	2437	99.0	1.01	19.00	17.54	1.40	0.783	1.107
			11	2462	99.0	1.01	19.00	17.41	1.44		
Rear	802.11b	5	1	2412	99.0	1.01	19.00	17.67	1.36	0.218	0.299
			6	2437	99.0	1.01	19.00	17.54	1.40		
			11	2462	99.0	1.01	19.00	17.41	1.44		

Ant 1 Tx

Test Position	Mode	Dist. (mm)	Ch #.	Freq. (MHz)	Duty [%]	Duty scaled factor	Power (dBm)		Power scaled factor	1-g SAR (W/kg)	
							Tune-up limit	Meas.		Meas.	Reported
Top	802.11b	5	1	2412	99.0	1.01	19.00	17.19	1.52	0.079	0.122
			6	2437	99.0	1.01	19.00	17.08	1.56		
			11	2462	99.0	1.01	19.00	17.16	1.53		
Front	802.11b	5	1	2412	99.0	1.01	19.00	17.19	1.52	0.013	0.020
			6	2437	99.0	1.01	19.00	17.08	1.56		
			11	2462	99.0	1.01	19.00	17.16	1.53		
Rear	802.11b	5	1	2412	99.0	1.01	19.00	17.19	1.52	0.005	0.007
			6	2437	99.0	1.01	19.00	17.08	1.56		
			11	2462	99.0	1.01	19.00	17.16	1.53		

Note(s):

1. Power Scaled factor = Maximum tune-up tolerance limit [mW] / Measured power [mW]
2. Duty Scaled factor = 1 / Duty(%) / 100
3. Reported SAR= Measured SAR [W/kg] · power Scaled factor * Duty Scaled factor
4. Highest measured output power channel was tested initially according to KDB248227D01.
5. According to KDB248227D01
 - 1) Highest reported SAR is ≤ 0.4 W/kg. Therefore, further SAR measurements within this exposure condition are not required.
 - 2) Highest reported SAR is > 0.4 W/kg. Due to the highest reported SAR for this test position, other test positions in standalone exposure condition were evaluated until a SAR ≤ 0.8 W/kg was reported.
 - 3) For all positions/configurations tested using the initial test position and subsequent test positions, when the reported SAR is > 0.8 W/kg, measure the SAR for these positions/configurations on the subsequent next highest measured output power channel(s) until the reported SAR is ≤ 1.2 W/kg or all required test channels are considered.

UL Japan, Inc.

Ise EMC Lab.

4383-326 Asama-cho, Ise-shi, Mie-ken 516-0021 JAPAN

Telephone: +81 596 24 8999

Facsimile: +81 596 24 8124

OFDM was excluded from the following table according to KDB248227D01.

SAR is not required for the following 2.4 GHz OFDM conditions according to KDB248227D01.

- 1) When KDB447498D01 SAR test exclusion applies to the OFDM configuration.
- 2) When the highest reported SAR for DSSS is adjusted by the ratio of OFDM to DSSS specified maximum output power and the adjusted SAR is ≤ 1.2 W/kg.

Ant 0 Tx

Maximum tune-up tolerance limit		Maximum tune-up tolerance limit		OFDM scaled factor *1	Position	DSSS Reported SAR value [W/kg]	OFDM Estimated SAR value [W/kg] *2	Exclusion limit [W/kg]	Standalone SAR tested
DSSS(11b)		OFDM(11g)							
[dBm]	[mW]	[dBm]	[mW]						
19.00	79.43	18.00	63.10	0.794	Front	1.107	0.879	< 1.2	No

Maximum tune-up tolerance limit		Maximum tune-up tolerance limit		OFDM scaled factor *1	Position	DSSS Reported SAR value [W/kg]	OFDM Estimated SAR value [W/kg] *2	Exclusion limit [W/kg]	Standalone SAR tested
DSSS(11b)		OFDM(11n HT20)							
[dBm]	[mW]	[dBm]	[mW]						
19.00	79.43	18.00	63.10	0.794	Front	1.107	0.879	< 1.2	No

Maximum tune-up tolerance limit		Maximum tune-up tolerance limit		OFDM scaled factor *1	Position	DSSS Reported SAR value [W/kg]	OFDM Estimated SAR value [W/kg] *2	Exclusion limit [W/kg]	Standalone SAR tested
DSSS(11b)		OFDM(11n HT40)							
[dBm]	[mW]	[dBm]	[mW]						
19.00	79.43	10.00	10.00	0.126	Front	1.107	0.139	< 1.2	No

Ant 1 Tx

Maximum tune-up tolerance limit		Maximum tune-up tolerance limit		OFDM scaled factor *1	Position	DSSS Reported SAR value [W/kg]	OFDM Estimated SAR value [W/kg] *2	Exclusion limit [W/kg]	Standalone SAR tested
DSSS(11b)		OFDM(11g)							
[dBm]	[mW]	[dBm]	[mW]						
19.00	79.43	18.00	63.10	0.794	Top	0.122	0.097	< 1.2	No

Maximum tune-up tolerance limit		Maximum tune-up tolerance limit		OFDM scaled factor *1	Position	DSSS Reported SAR value [W/kg]	OFDM Estimated SAR value [W/kg] *2	Exclusion limit [W/kg]	Standalone SAR tested
DSSS(11b)		OFDM(11n HT20)							
[dBm]	[mW]	[dBm]	[mW]						
19.00	79.43	18.00	63.10	0.794	Top	0.122	0.097	< 1.2	No

Maximum tune-up tolerance limit		Maximum tune-up tolerance limit		OFDM scaled factor *1	Position	DSSS Reported SAR value [W/kg]	OFDM Estimated SAR value [W/kg] *2	Exclusion limit [W/kg]	Standalone SAR tested
DSSS(11b)		OFDM(11n HT40)							
[dBm]	[mW]	[dBm]	[mW]						
19.00	79.43	10.00	10.00	0.126	Top	0.122	0.015	< 1.2	No

Notes:

1. OFDM scaled factor = Maximum tune-up tolerance limit of OFDM [mW] / Maximum tune-up tolerance limit of DSSS [mW]
2. OFDM Estimated SAR= Reported SAR of DSSS[W/kg] · OFDM scaled factor

5.3GHz Band

Ant 0 Tx

Test Position	Mode	Dist. (mm)	Ch #.	Freq. (MHz)	Duty [%]	Duty scaled factor	Power (dBm)		Power scaled factor	1-g SAR (W/kg)	
							Tune-up limit	Meas.		Meas.	Reported
Top	802.11n HT40	5	54	5270	87.4	1.14	15.00	14.14	1.22	0.333	0.464
			62	5310	87.4	1.14	15.00	13.98	1.26		
Left	802.11n HT40	5	54	5270	87.4	1.14	15.00	14.14	1.22	0.013	0.018
			62	5310	87.4	1.14	15.00	13.98	1.26		
Front	802.11n HT40	5	54	5270	87.4	1.14	15.00	14.14	1.22	0.214	0.298
			62	5310	87.4	1.14	15.00	13.98	1.26		
Rear	802.11n HT40	5	54	5270	87.4	1.14	15.00	14.14	1.22	0.098	0.137
			62	5310	87.4	1.14	15.00	13.98	1.26		

Ant 1 Tx

Test Position	Mode	Dist. (mm)	Ch #.	Freq. (MHz)	Duty [%]	Duty scaled factor	Power (dBm)		Power scaled factor	1-g SAR (W/kg)	
							Tune-up limit	Meas.		Meas.	Reported
Top	802.11n HT40	5	54	5270	87.4	1.14	15.00	13.34	1.47	0.300	0.503
			62	5310	87.4	1.14	15.00	13.13	1.54		
Front	802.11n HT40	5	54	5270	87.4	1.14	15.00	13.34	1.47	0.090	0.151
			62	5310	87.4	1.14	15.00	13.13	1.54		
Rear	802.11n HT40	5	54	5270	87.4	1.14	15.00	13.34	1.47	0.034	0.057
			62	5310	87.4	1.14	15.00	13.13	1.54		

Note(s):

- Power Scaled factor = Maximum tune-up tolerance limit [mW] / Measured power [mW]
- Duty Scaled factor = 1 / Duty(%) / 100
- Reported SAR= Measured SAR [W/kg] · power Scaled factor * Duty Scaled factor
- Highest measured output power channel was tested initially according to KDB248227D01.
- According to KDB248227D01
 - Highest reported SAR is ≤ 0.4 W/kg. Therefore, further SAR measurements within this exposure condition are not required.
 - Highest reported SAR is > 0.4 W/kg. Due to the highest reported SAR for this test position, other test positions in standalone exposure condition were evaluated until a SAR ≤ 0.8 W/kg was reported.
 - For all positions/configurations tested using the initial test position and subsequent test positions, when the reported SAR is > 0.8 W/kg, measure the SAR for these positions/configurations on the subsequent next highest measured output power channel(s) until the reported SAR is ≤ 1.2 W/kg or all required test channels are considered.

Subsequent test configuration was excluded from the following table according to KDB248227D01.

SAR is not required for the following exclusion conditions according to KDB248227D01.

- When KDB447498D01 SAR test exclusion applies to the initial test configuration.
- When the highest reported SAR for initial test configuration is adjusted by the ratio of Subsequent test configuration to initial test configuration specified maximum output power and the adjusted SAR is ≤ 1.2 W/kg.

Ant 0 Tx

Maximum tune-up tolerance limit		Maximum tune-up tolerance limit		Scaled factor *1	Position	Initial test configuration Reported SAR value [W/kg]	Estimated SAR of sbsequent test configuration [W/kg] *2	Exclusion limit [W/kg]	Standalone SAR tested
Initial test configuration (11n HT40)		Subsequent test configuration (11a)							
[dBm]	[mW]	[dBm]	[mW]						
15.00	31.62	15.00	31.62	1.000	Top	0.464	0.464	< 1.2	No

Maximum tune-up tolerance limit		Maximum tune-up tolerance limit		Scaled factor *1	Position	Initial test configuration Reported SAR value [W/kg]	Estimated SAR of sbsequent test configuration [W/kg] *2	Exclusion limit [W/kg]	Standalone SAR tested
Initial test configuration (11n HT40)		Subsequent test configuration (11n HT20, 11ac VHT20)							
[dBm]	[mW]	[dBm]	[mW]						
15.00	31.62	15.00	31.62	1.000	Top	0.464	0.464	< 1.2	No

UL Japan, Inc.

Ise EMC Lab.

4383-326 Asama-cho, Ise-shi, Mie-ken 516-0021 JAPAN
Telephone: +81 596 24 8999
Facsimile: +81 596 24 8124

Maximum tune-up tolerance limit		Maximum tune-up tolerance limit		Scaled factor *1	Position	Initial test configuration Reported SAR value [W/kg]	Estimated SAR of sbsquent test configuration [W/kg] *2	Exclusion limit [W/kg]	Standalone SAR tested
Initial test configuration (11n HT40)		Subsequent test configuration (11ac VHT40)							
[dBm]	[mW]	[dBm]	[mW]						
15.00	31.62	15.00	31.62	1.000	Top	0.464	0.464	< 1.2	No

Maximum tune-up tolerance limit		Maximum tune-up tolerance limit		Scaled factor *1	Position	Initial test configuration Reported SAR value [W/kg]	Estimated SAR of sbsquent test configuration [W/kg] *2	Exclusion limit [W/kg]	Standalone SAR tested
Initial test configuration (11n HT40)		Subsequent test configuration (11ac VHT80)							
[dBm]	[mW]	[dBm]	[mW]						
15.00	31.62	10.50	11.22	0.355	Top	0.464	0.165	< 1.2	No

Ant 1 Tx

Maximum tune-up tolerance limit		Maximum tune-up tolerance limit		Scaled factor *1	Position	Initial test configuration Reported SAR value [W/kg]	Estimated SAR of sbsquent test configuration [W/kg] *2	Exclusion limit [W/kg]	Standalone SAR tested
Initial test configuration (11n HT40)		Subsequent test configuration (11a)							
[dBm]	[mW]	[dBm]	[mW]						
15.00	31.62	15.00	31.62	1.000	Top	0.503	0.503	< 1.2	No

Maximum tune-up tolerance limit		Maximum tune-up tolerance limit		Scaled factor *1	Position	Initial test configuration Reported SAR value [W/kg]	Estimated SAR of sbsquent test configuration [W/kg] *2	Exclusion limit [W/kg]	Standalone SAR tested
Initial test configuration (11n HT40)		Subsequent test configuration (11n HT20, 11ac VHT20)							
[dBm]	[mW]	[dBm]	[mW]						
15.00	31.62	15.00	31.62	1.000	Top	0.503	0.503	< 1.2	No

Maximum tune-up tolerance limit		Maximum tune-up tolerance limit		Scaled factor *1	Position	Initial test configuration Reported SAR value [W/kg]	Estimated SAR of sbsquent test configuration [W/kg] *2	Exclusion limit [W/kg]	Standalone SAR tested
Initial test configuration (11n HT40)		Subsequent test configuration (11ac VHT40)							
[dBm]	[mW]	[dBm]	[mW]						
15.00	31.62	15.00	31.62	1.000	Top	0.503	0.503	< 1.2	No

Maximum tune-up tolerance limit		Maximum tune-up tolerance limit		Scaled factor *1	Position	Initial test configuration Reported SAR value [W/kg]	Estimated SAR of sbsquent test configuration [W/kg] *2	Exclusion limit [W/kg]	Standalone SAR tested
Initial test configuration (11n HT40)		Subsequent test configuration (11ac VHT80)							
[dBm]	[mW]	[dBm]	[mW]						
15.00	31.62	10.50	11.22	0.355	Top	0.503	0.178	< 1.2	No

Notes:

1. Scaled factor = Maximum tune-up tolerance limit of subsequent test configuration [mW] / Maximum tune-up tolerance limit of initial test configuration [mW]
2. Estimated SAR of sbsquent test configuration = Reported SAR of initial test configuration [W/kg] · scaled factor

UL Japan, Inc.

Ise EMC Lab.

4383-326 Asama-cho, Ise-shi, Mie-ken 516-0021 JAPAN

Telephone: +81 596 24 8999

Facsimile: +81 596 24 8124

Repeated measurement

According to KDB865664 D1.

- 1) Repeated measurement is not required when the original highest measured SAR is < 0.80 W/kg; steps 2) through 4) do not apply.
- 2) When the original highest measured SAR is ≥ 0.80 W/kg, repeat that measurement once.
- 3) Perform a second repeated measurement only if the ratio of largest to smallest SAR for the original and first repeated measurements is > 1.20 or when the original or repeated measurement is ≥ 1.45 W/kg (~ 10% from the 1-g SAR limit).
- 4) Perform a third repeated measurement only if the original, first or second repeated measurement is ≥ 1.5 W/kg and the ratio of largest to smallest SAR for the original, first and second repeated measurements is > 1.20.

Wireless Technologies	Test Configuration			Mode	Dist. (mm)	Ch #.	Freq. (MHz)	Meas. SAR (W/kg)		Largest to Smallest SAR Ratio	Plot No.
	Transmit Antenna	Exposure	Position					Original	Repeated		
Wi-Fi 2.4 GHz	Ant0	Body	Front	802.11b	5	6	2437	0.783	N/A	N/A	-
Wi-Fi 5.3 GHz	Ant0	Body	Top	802.11a	5	52	5260	0.407	N/A	N/A	-

Note(s):

N/A: Repeated Measurement is not required since the original highest measured SAR for all band is < 0.80 W/kg.

SECTION11: Simultaneous Transmission SAR Analysis

Test Position	Stand-alone SAR Value [W/kg]			Σ 1-g SAR (W/kg)
	WLAN 2.4GHz Ant 0	WLAN 2.4GHz Ant 1	Bluetooth	
Top	1.052	0.122		1.174
Top		0.122	0.084	0.206
Left	0.225	0.400		0.625
Left		0.400	0.084	0.484
Front	1.107	0.020		1.127
Front		0.020	0.084	0.104
Rear	0.299	0.007		0.306
Rear		0.007	0.084	0.091

Note(s):

1. Bluetooth and WLAN Ant0 cannot simultaneously transmit.
2. Values shaded green are estimated SAR. Refer to section 5.3.

Conclusion:

Simultaneous transmission SAR measurement (Volume Scan) is not required because the either sum of the 1-g SAR is < 1.6 W/kg or the SPLSR is < 0.04 for all circumstances that require SPLSR calculation.

Test Position	Stand-alone SAR Value [W/kg]			Σ 1-g SAR (W/kg)
	WLAN 5.3GHz Ant 0	WLAN 5.3GHz Ant 1	Bluetooth	
Top	0.464	0.503		0.967
Top		0.503	0.084	0.587
Left	0.018	0.400		0.418
Left		0.400	0.084	0.484
Front	0.298	0.151		0.449
Front		0.151	0.084	0.235
Rear	0.137	0.057		0.194
Rear		0.057	0.084	0.141

Note(s):

1. Bluetooth and WLAN Ant0 cannot simultaneously transmit.
2. Values shaded green are estimated SAR. Refer to section 5.3.

Conclusion:

Simultaneous transmission SAR measurement (Volume Scan) is not required because the either sum of the 1-g SAR is < 1.6 W/kg or the SPLSR is < 0.04 for all circumstances that require SPLSR calculation.

SECTION12: Test instruments

Control No.	Instrument	Manufacturer	Model No	Serial No	Test Item	Calibration Date * Interval(month)
MNA-03	Vector Reflectometer	Copper Mountain Technologies	PLANAR R140	0030913	SAR	2016/04/22 * 12
MDPK-03	Dielectric assessment kit	Schmid&Partner Engineering AG	DAK-3.5	0008	SAR	2016/04/12 * 12
MOS-37	Digital thermometer	LKM electronic	DTM3000	-	SAR	2016/07/28 * 12
COTS-MSAR-04	Dielectric assessment software	Schmid&Partner Engineering AG	DAK		SAR	-
MDAE-01	Data Acquisition Electronics	Schmid&Partner Engineering AG	D4E4	509	SAR	2016/07/07 * 12
MPB-07	Dosimetric E-Field Probe	Schmid&Partner Engineering AG	EX3DV4	3825	SAR	2015/12/11 * 12
MPF-02	2mm Oval Flat Phantom	Schmid&Partner Engineering AG	QDOVA001BB	1045	SAR	2016/05/07 * 12
MOS-26	Thermo-Hygrometer	CUSTOM	CTH-201	A08Q29	SAR	2016/04/19 * 12
COTS-MSAR-03	Dasy5	Schmid&Partner Engineering AG	DASY5	-	SAR	-
MRBT-02	SAR robot	Schmid&Partner Engineering AG	TX60 Lspeag	F10/5E3LA1/A/01	SAR	2016/04/30 * 12
MPF-04	2mm Oval Flat Phantom	Schmid&Partner Engineering AG	QDOVA001BB	1207	SAR	2016/05/07 * 12
MDH-03	Device holder	Schmid&Partner Engineering AG	Mounting device for transmitter	-	SAR	Pre Check
MOS-35	Digital thermometer	HANNA	Checktemp 4	-	SAR	2016/07/28 * 12
MRBT-04	SAR robot	Schmid&Partner Engineering AG	TX60 Lspeag	F13/5PPLA1/A/01	SAR	2016/06/01 * 12
MPM-11	Dual Power Meter	Agilent	E4419B	MY45102060	SAR	2016/08/24 * 12
MPSE-15	Power sensor	Agilent	E9301A	MY41498311	SAR	2016/08/24 * 12
MPSE-16	Power sensor	Agilent	E9301A	MY41498313	SAR	2016/08/24 * 12
MRFA-24	Pre Amplifier	R&K	R&K CGA020M602-2633R	B30550	SAR	2016/06/27 * 12
MSG-10	Signal Generator	Agilent	N5181A	MY47421098	SAR	2016/11/09 * 12
MAT-78	Attenuator	Telegrartner	J01156A0011	0042294119	SAR	Pre Check
MPM-15	Power Meter	Agilent	N1914A	MY53060017	SAR	2016/06/27 * 12
MPSE-21	Power sensor	Agilent	N8482H	MY52460010	SAR	2016/06/27 * 12
MHDC-12	Dual Directional Coupler	Hewlett Packard	772D	2839A0016	SAR(2-18GHz)	Pre Check
MDA-07	Dipole Antenna	Schmid&Partner Engineering AG	D2450V2	713	SAR(D2450)	2016/09/13 * 12
MMSL2450	Tissue simulation liquid (Body)	Schmid&Partner Engineering AG	MSL2450V2	SL AA 245 BA	SAR*Daily Check Target Value ±5%	Pre Check
MDA-08	Dipole Antenna	Schmid&Partner Engineering AG	D5GHzV2	1020	SAR(D5G)	2016/01/20 * 12
MMBL3.5-5.8	Tissue simulation liquid (Body)	Schmid&Partner Engineering AG	MBBL3500-5800V5	SL AAM 501 DA	SAR*Daily Check Target Value ±5%	Pre Check

*1) This test equipment was used for the tests before the expiration date of the calibration.

The expiration date of the calibration is the end of the expired month.

All equipment is calibrated with valid calibrations. Each measurement data is traceable to the national or international standards.

As for some calibrations performed after the tested dates, those test equipment have been controlled by means of an unbroken chains of calibrations.

SAR room is checked before every testing and ambient noise is <0.012W/kg

UL Japan, Inc.

Ise EMC Lab.

4383-326 Asama-cho, Ise-shi, Mie-ken 516-0021 JAPAN

Telephone: +81 596 24 8999

Facsimile: +81 596 24 8124

APPENDIX 1 : SAR Measurement data

Evaluation procedure

The evaluation was performed with the following procedure:

Step 1: Measurement of the E-field at a fixed location above the ear point or central position of flat phantom was used as a reference value for assessing the power drop.

Step 2: The SAR distribution at the exposed side of head or body position was measured at a distance of each device from the inner surface of the shell. The area covered the entire dimension of the antenna of EUT and the horizontal grid spacing was 15 mm x 15 mm, 12 mm x 12 mm or 10mm x 10mm. Based on these data, the area of the maximum absorption was determined by spline interpolation.

Step 3: Around this point found in the Step 2 (area scan), a volume of 30mm x 30mm x 30mm or more was assessed by measuring 7 x 7 x 7 points at least for below 3GHz and a volume of 28 mm x 28mm x 22.5mm or more was assessed by measuring 8 x 8 x 6(ratio step method (*1)) points at least for 5GHz band.

And for any secondary peaks found in the Step2 which are within 2dB of maximum peak and not with this Step3 (Zoom scan) is repeated. On the basis of this data set, the spatial peak SAR value was evaluated under the following procedure:

(1). The data at the surface were extrapolated, since the center of the dipoles is 1mm(EX3DV4) away from the tip of the probe and the distance between the surface and the lowest measuring point is 1.3 mm. The extrapolation was based on a least square algorithm [4]. A polynomial of the fourth order was calculated through the points in z-axes.

This polynomial was then used to evaluate the points between the surface and the probe tip.

(2). The maximum interpolated value was searched with a straightforward algorithm. Around this maximum the SAR values averaged over the spatial volumes (1 g or 10 g) were computed by the 3D-Spline interpolation algorithm. The 3D-Spline is composed of three one-dimensional splines with the "Not a knot"-condition (in x, y and z-directions) [4], [5]. The volume was integrated with the trapezoidal-algorithm. One thousand points (10 x 10 x 10) were interpolated to calculate the average.

(3). All neighboring volumes were evaluated until no neighboring volume with a higher average value was found.

***1. Ratio step method parameters used;**

**The first measurement point: 2mm from the phantom surface, the initial grid separation: 2mm, subsequent graded grid ratio: 1.5
These parameters comply with the requirement of the KDB 865664D01.**

Step 4: Re-measurement of the E-field at the same location as in Step 1.

Confirmation after SAR testing

It was checked that the power drift [W] is within +/-5%. The verification of power drift during the SAR test is that DASY5 system calculates the power drift by measuring the e-field at the same location at beginning and the end of the scan measurement for each test position.

DASY5 system calculation Power drift value[dB] = $20\log(E_a)/(E_b)$

Before SAR testing : E_b [V/m]

After SAR testing : E_a [V/m]

Limit of power drift[W] = +/-5%

$X[\text{dB}] = 10\log[P] = 10\log(1.05/1) = 10\log(1.05) - 10\log(1) = 0.212\text{dB}$

from E-field relations with power.

$p = E^2/\eta = E^2/$

Therefore, The correlation of power and the E-field

$X[\text{dB}] = 10\log(P) = 10\log(E)^2 = 20\log(E)$

Therefore,

The calculated power drift of DASY5 System must be the less than +/-0.212dB.

Measurement data

WLAN 11b 2412MHz Ant0 Top

Communication System: UID 0, WLAN (0); Communication System Band: 11b/g/n; Frequency: 2412 MHz; Duty Cycle: 1:1

Medium parameters used (interpolated): $f = 2412$ MHz; $\sigma = 1.971$ S/m; $\epsilon_r = 51.003$; $\rho = 1000$ kg/m³

Phantom section: Flat Section

Measurement Standard: DASY5 (IEEE/IEC/ANSI C63.19-2011)

DASY5 Configuration

Probe: EX3DV4 - SN3825; ConvF(7.29, 7.29, 7.29); Calibrated: 2015/12/11;

Sensor-Surface: 1.4mm (Mechanical Surface Detection)

Electronics: DAE4 Sn509; Calibrated: 2016/07/07

Phantom: ELI v5.0 (30deg probe tilt); Type: QDOVA002AA; Serial: TP:xxxx

Measurement SW: DASY52, Version 52.8 (8); SEMCAD X Version 14.6.10 (7331)

Top/5mm Ant0 Lowch/Area Scan 2 (61x131x1): Interpolated grid: dx=1.500 mm, dy=1.500 mm

Maximum value of SAR (interpolated) = 1.19 W/kg

Top/5mm Ant0 Lowch/Zoom Scan (7x7x7)/Cube 0: Measurement grid: dx=5mm, dy=5mm, dz=5mm

Reference Value = 26.09 V/m; Power Drift = -0.07 dB

Peak SAR (extrapolated) = 1.81 W/kg

SAR(1 g) = 0.767 W/kg; SAR(10 g) = 0.307 W/kg

Maximum value of SAR (measured) = 1.43 W/kg

Date: 2016/11/14

Ambient Temp. : 24.0 degree.C. Liquid Temp.; 23.5 degree.C.

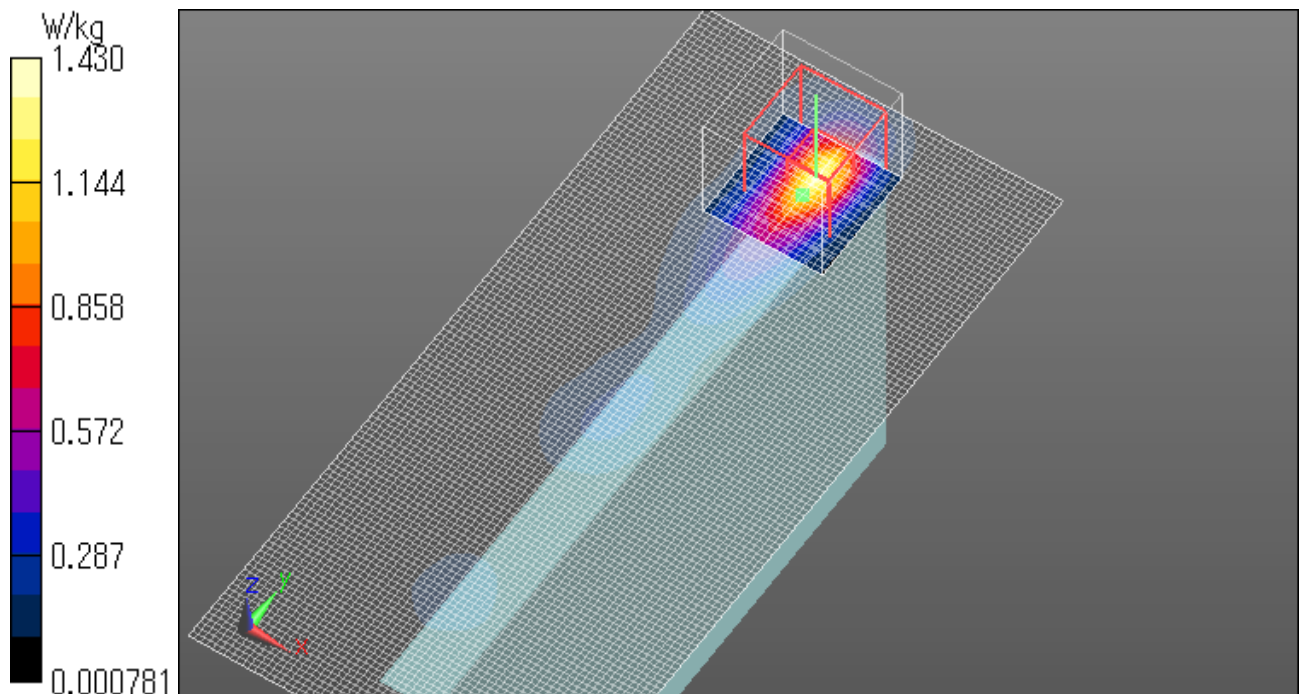

WLAN 11b 2437MHz Ant0 Top

Communication System: UID 0, WLAN 11a/b/g/n (0); Communication System Band: 11b/g/n (2.4G); Frequency: 2437 MHz; Duty Cycle: 1:1

Medium parameters used (interpolated): $f = 2437$ MHz; $\sigma = 2.007$ S/m; $\epsilon_r = 50.948$; $\rho = 1000$ kg/m³

Phantom section: Flat Section

Measurement Standard: DASY5 (IEEE/IEC/ANSI C63.19-2011)

DASY5 Configuration

Probe: EX3DV4 - SN3825; ConvF(7.29, 7.29, 7.29); Calibrated: 2015/12/11;

Sensor-Surface: 1.4mm (Mechanical Surface Detection)

Electronics: DAE4 Sn509; Calibrated: 2016/07/07

Phantom: ELI v5.0 (30deg probe tilt); Type: QDOVA002AA; Serial: TP:xxxx

Measurement SW: DASY52, Version 52.8 (8); SEMCAD X Version 14.6.10 (7331)

Top/5mm Ant0 Midch/Area Scan 2 (61x131x1): Interpolated grid: dx=1.500 mm, dy=1.500 mm

Maximum value of SAR (interpolated) = 1.27 W/kg

Top/5mm Ant0 Midch/Zoom Scan (7x7x7)/Cube 0: Measurement grid: dx=5mm, dy=5mm, dz=5mm

Reference Value = 25.86 V/m; Power Drift = 0.07 dB

Peak SAR (extrapolated) = 1.63 W/kg

SAR(1 g) = 0.682 W/kg; SAR(10 g) = 0.272 W/kg

Maximum value of SAR (measured) = 1.26 W/kg

Date: 2016/11/14

Ambient Temp. : 24.0 degree.C. Liquid Temp.; 23.5 degree.C.

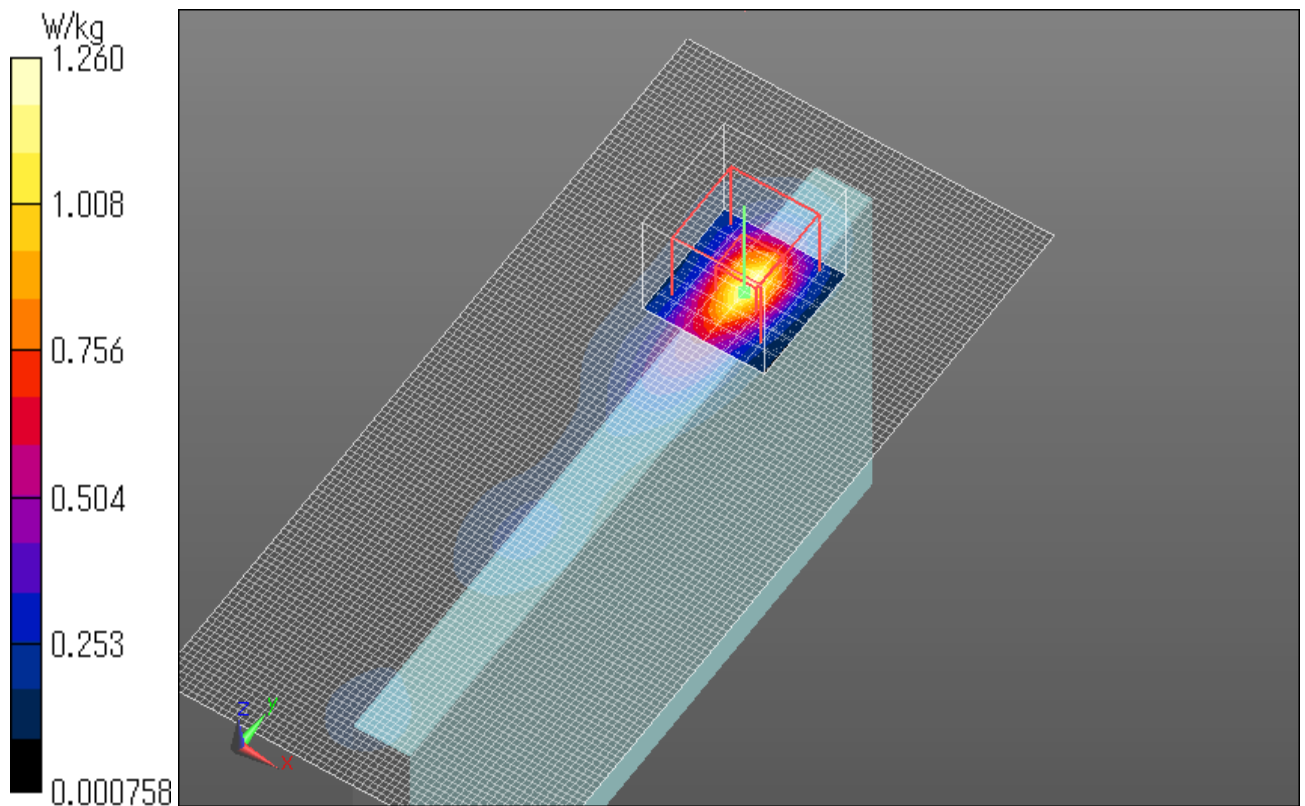

WLAN 11b 2412MHz Ant0 Left

Communication System: UID 0, WLAN (0); Communication System Band: 11b/g/n; Frequency: 2412 MHz; Duty Cycle: 1:1

Medium parameters used (interpolated): $f = 2412$ MHz; $\sigma = 1.971$ S/m; $\epsilon_r = 51.003$; $\rho = 1000$ kg/m³

Phantom section: Flat Section

Measurement Standard: DASY5 (IEEE/IEC/ANSI C63.19-2011)

DASY5 Configuration

Probe: EX3DV4 - SN3825; ConvF(7.29, 7.29, 7.29); Calibrated: 2015/12/11;

Sensor-Surface: 1.4mm (Mechanical Surface Detection)

Electronics: DAE4 Sn509; Calibrated: 2016/07/07

Phantom: ELI v5.0 (30deg probe tilt); Type: QDOVA002AA; Serial: TP:xxxx

Measurement SW: DASY52, Version 52.8 (8); SEMCAD X Version 14.6.10 (7331)

Left/5mm/Area Scan 2 (71x121x1): Interpolated grid: dx=1.200 mm, dy=1.200 mm

Maximum value of SAR (interpolated) = 0.279 W/kg

Left/5mm/Zoom Scan (7x7x7)/Cube 0: Measurement grid: dx=5mm, dy=5mm, dz=5mm

Reference Value = 12.04 V/m; Power Drift = -0.02 dB

Peak SAR (extrapolated) = 0.331 W/kg

SAR(1 g) = 0.164 W/kg; SAR(10 g) = 0.079 W/kg

Maximum value of SAR (measured) = 0.266 W/kg

Date: 2016/11/14

Ambient Temp. : 24.0 degree.C. Liquid Temp.; 23.5 degree.C.

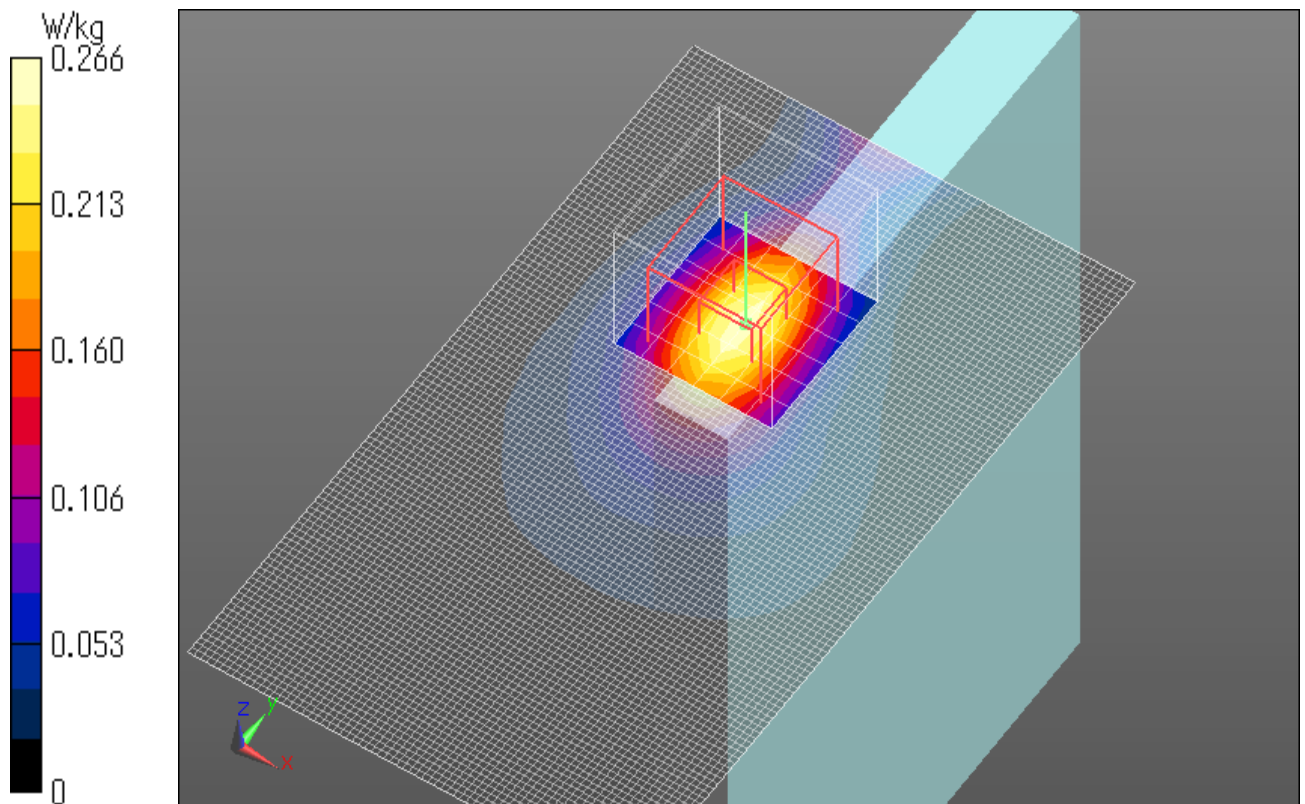

WLAN 11b 2412MHz Ant0 Front

Communication System: UID 0, WLAN (0); Communication System Band: 11b/g/n; Frequency: 2412 MHz; Duty Cycle: 1:1

Medium parameters used (interpolated): $f = 2412$ MHz; $\sigma = 1.971$ S/m; $\epsilon_r = 51.003$; $\rho = 1000$ kg/m³

Phantom section: Flat Section

Measurement Standard: DASY5 (IEEE/IEC/ANSI C63.19-2011)

DASY5 Configuration

Probe: EX3DV4 - SN3825; ConvF(7.29, 7.29, 7.29); Calibrated: 2015/12/11;

Sensor-Surface: 1.4mm (Mechanical Surface Detection (Locations From Previous Scan Used)), Sensor-Surface: 1.4mm (Mechanical Surface Detection)

Electronics: DAE4 Sn509; Calibrated: 2016/07/07

Phantom: ELI v5.0 (30deg probe tilt); Type: QDOVA002AA; Serial: TP:xxxx

Measurement SW: DASY52, Version 52.8 (8); SEMCAD X Version 14.6.10 (7331)

Front/5mm Ant0 Lowch/Area Scan 2 2 (61x71x1): Interpolated grid: dx=1.200 mm, dy=1.200 mm

Maximum value of SAR (interpolated) = 1.04 W/kg

Front/5mm Ant0 Lowch/Zoom Scan (7x7x7)/Cube 0: Measurement grid: dx=5mm, dy=5mm, dz=5mm

Reference Value = 23.85 V/m; Power Drift = -0.08 dB

Peak SAR (extrapolated) = 1.41 W/kg

SAR(1 g) = 0.614 W/kg; SAR(10 g) = 0.272 W/kg

Maximum value of SAR (measured) = 1.05 W/kg

Date: 2016/11/14

Ambient Temp. : 24.0 degree.C. Liquid Temp.; 23.5 degree.C.

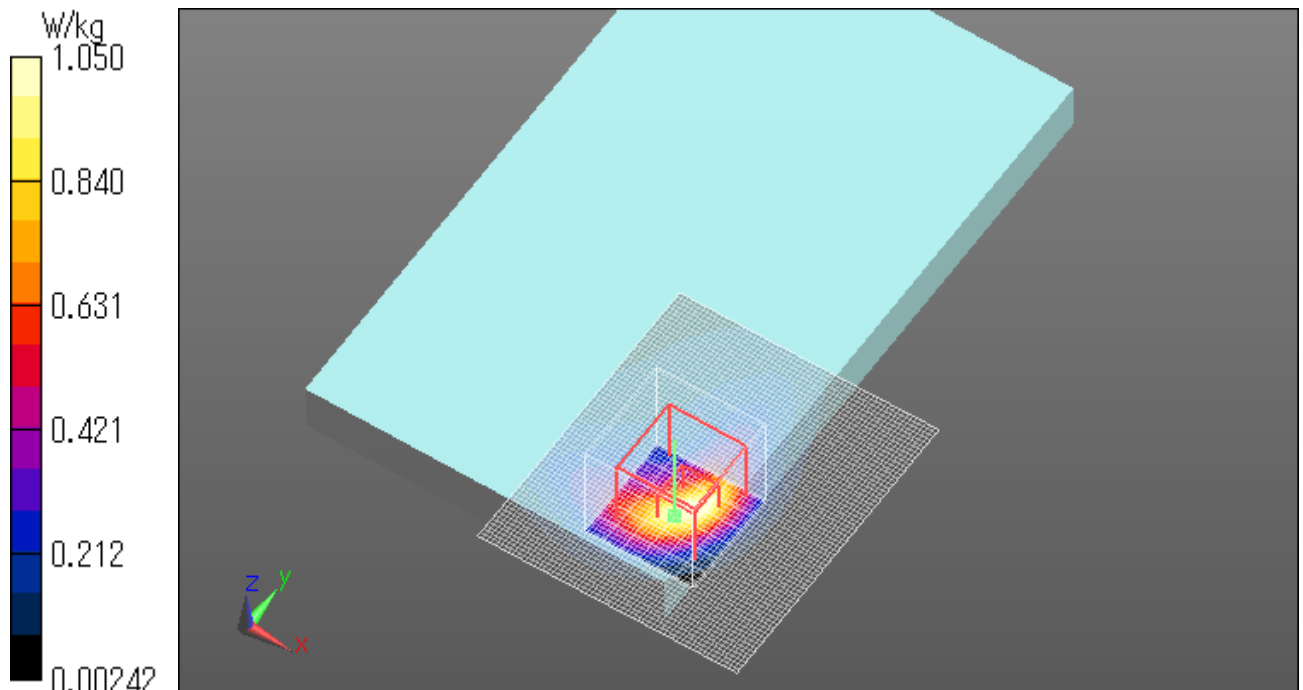

WLAN 11b 2437MHz Ant0 Front

Communication System: UID 0, WLAN (0); Communication System Band: 11b/g/n; Frequency: 2437 MHz; Duty Cycle: 1:1

Medium parameters used (interpolated): $f = 2437$ MHz; $\sigma = 2.007$ S/m; $\epsilon_r = 50.948$; $\rho = 1000$ kg/m³

Phantom section: Flat Section

Measurement Standard: DASY5 (IEEE/IEC/ANSI C63.19-2011)

DASY5 Configuration

Probe: EX3DV4 - SN3825; ConvF(7.29, 7.29, 7.29); Calibrated: 2015/12/11;

Sensor-Surface: 1.4mm (Mechanical Surface Detection), Sensor-Surface: 1.4mm (Mechanical Surface Detection (Locations From Previous Scan Used))

Electronics: DAE4 Sn509; Calibrated: 2016/07/07

Phantom: ELI v5.0 (30deg probe tilt); Type: QDOVA002AA; Serial: TP:xxxx

Measurement SW: DASY52, Version 52.8 (8); SEMCAD X Version 14.6.10 (7331)

Front/5mm Ant0 Midch/Area Scan 2 2 (31x101x1): Interpolated grid: dx=1.200 mm, dy=1.200 mm

Maximum value of SAR (interpolated) = 1.53 W/kg

Front/5mm Ant0 Midch/Area Scan 2 (71x101x1): Interpolated grid: dx=1.200 mm, dy=1.200 mm

Maximum value of SAR (interpolated) = 0.942 W/kg

Front/5mm Ant0 Midch/Zoom Scan (7x7x7)/Cube 0: Measurement grid: dx=5mm, dy=5mm, dz=5mm

Reference Value = 27.81 V/m; Power Drift = -0.17 dB

Peak SAR (extrapolated) = 1.91 W/kg

SAR(1 g) = 0.783 W/kg; SAR(10 g) = 0.335 W/kg

Maximum value of SAR (measured) = 1.46 W/kg

Date: 2016/11/14

Ambient Temp. : 24.0 degree.C. Liquid Temp.; 23.5 degree.C.

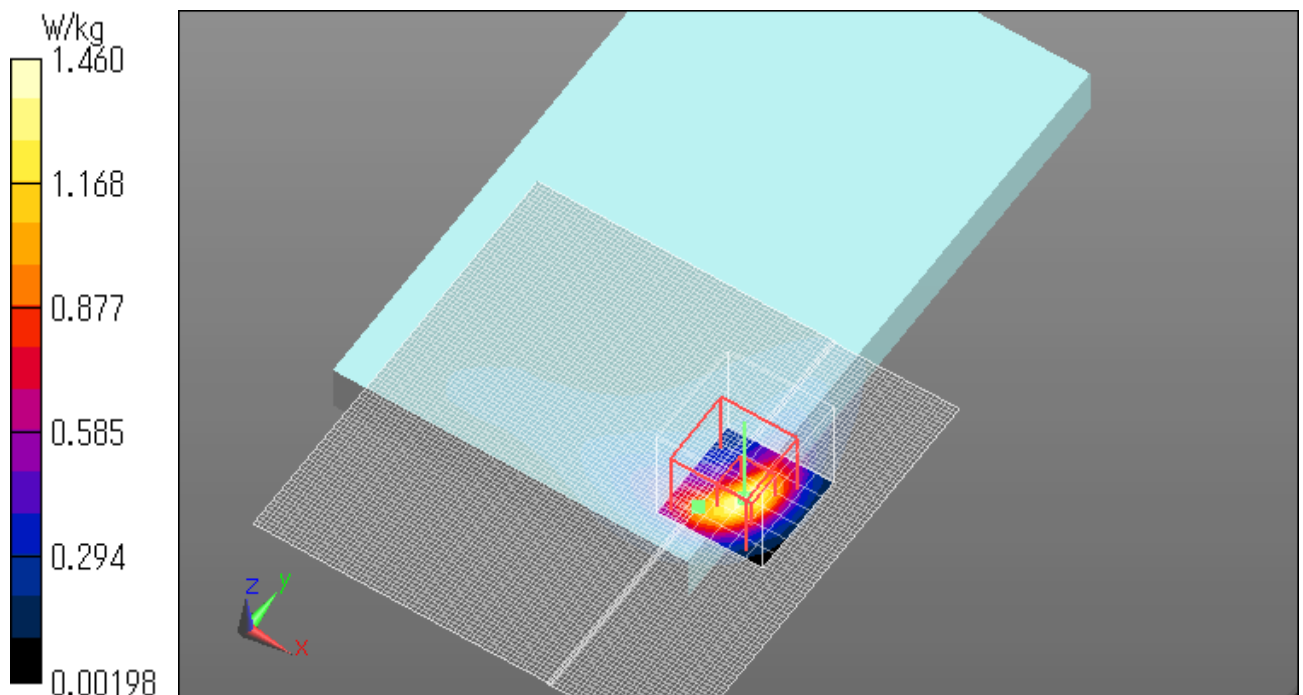

WLAN 11b 2412MHz Ant0 Rear

Communication System: UID 0, WLAN (0); Communication System Band: 11b/g/n; Frequency: 2412 MHz; Duty Cycle: 1:1

Medium parameters used (interpolated): $f = 2412$ MHz; $\sigma = 1.971$ S/m; $\epsilon_r = 51.003$; $\rho = 1000$ kg/m³

Phantom section: Flat Section

Measurement Standard: DASY5 (IEEE/IEC/ANSI C63.19-2011)

DASY5 Configuration

Probe: EX3DV4 - SN3825; ConvF(7.29, 7.29, 7.29); Calibrated: 2015/12/11;

Sensor-Surface: 1.4mm (Mechanical Surface Detection (Locations From Previous Scan Used)), Sensor-Surface: 1.4mm (Mechanical Surface Detection)

Electronics: DAE4 Sn509; Calibrated: 2016/07/07

Phantom: ELI v5.0 (30deg probe tilt); Type: QDOVA002AA; Serial: TP:xxxx

Measurement SW: DASY52, Version 52.8 (8); SEMCAD X Version 14.6.10 (7331)

Rear/5mm Ant0/Area Scan 3 (71x71x1): Interpolated grid: dx=1.200 mm, dy=1.200 mm

Maximum value of SAR (interpolated) = 0.298 W/kg

Rear/5mm Ant0/Zoom Scan (7x7x7)/Cube 0: Measurement grid: dx=5mm, dy=5mm, dz=5mm

Reference Value = 13.24 V/m; Power Drift = 0.13 dB

Peak SAR (extrapolated) = 0.434 W/kg

SAR(1 g) = 0.218 W/kg; SAR(10 g) = 0.110 W/kg

Maximum value of SAR (measured) = 0.352 W/kg

Date: 2016/11/14

Ambient Temp. : 24.0 degree.C. Liquid Temp.; 23.5 degree.C.

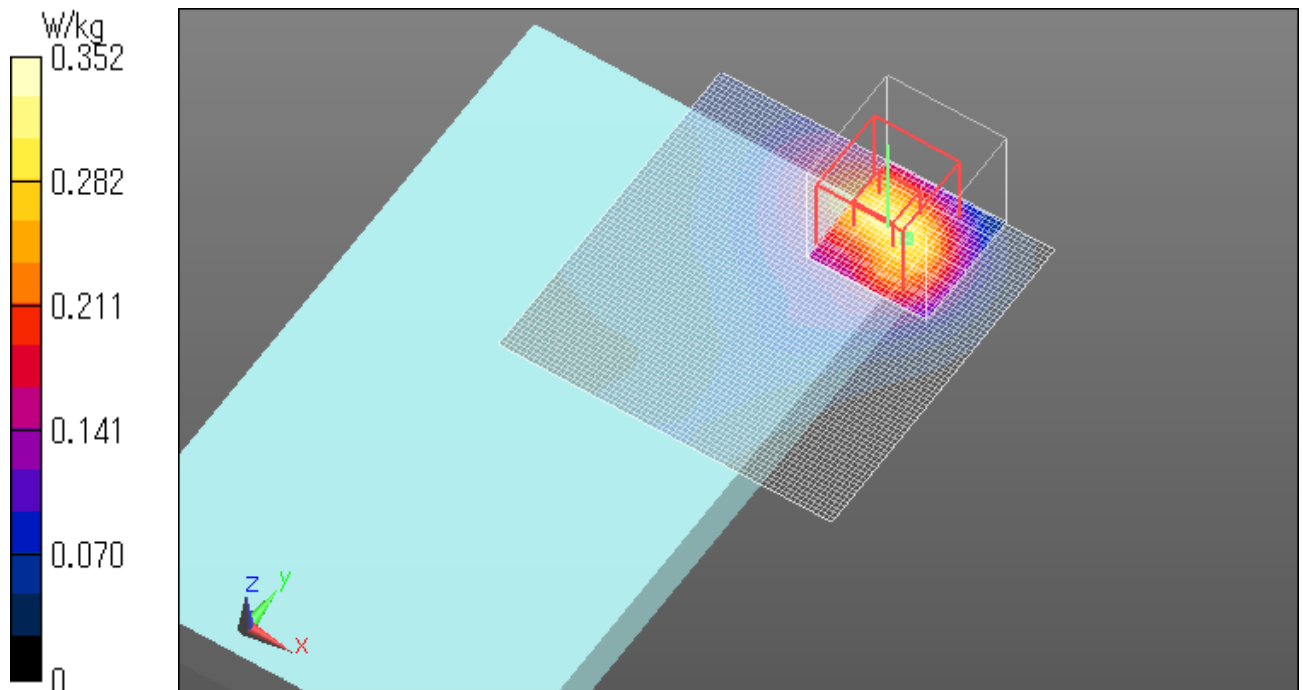

WLAN 11b 2412MHz Ant1 Top

Communication System: UID 0, WLAN (0); Communication System Band: 11b/g/n; Frequency: 2412 MHz; Duty Cycle: 1:1

Medium parameters used (interpolated): $f = 2412$ MHz; $\sigma = 1.971$ S/m; $\epsilon_r = 51.003$; $\rho = 1000$ kg/m³

Phantom section: Flat Section

Measurement Standard: DASY5 (IEEE/IEC/ANSI C63.19-2011)

DASY5 Configuration

Probe: EX3DV4 - SN3825; ConvF(7.29, 7.29, 7.29); Calibrated: 2015/12/11;

Sensor-Surface: 1.4mm (Mechanical Surface Detection)

Electronics: DAE4 Sn509; Calibrated: 2016/07/07

Phantom: ELI v5.0 (30deg probe tilt); Type: QDOVA002AA; Serial: TP:xxxx

Measurement SW: DASY52, Version 52.8 (8); SEMCAD X Version 14.6.10 (7331)

Top/5mm Ant1/Area Scan 4 (71x101x1): Interpolated grid: dx=1.200 mm, dy=1.200 mm

Maximum value of SAR (interpolated) = 0.102 W/kg

Top/5mm Ant1/Zoom Scan (7x7x7)/Cube 0: Measurement grid: dx=5mm, dy=5mm, dz=5mm

Reference Value = 9.123 V/m; Power Drift = -0.01 dB

Peak SAR (extrapolated) = 0.198 W/kg

SAR(1 g) = 0.079 W/kg; SAR(10 g) = 0.025 W/kg

Maximum value of SAR (measured) = 0.154 W/kg

Date: 2016/11/14

Ambient Temp. : 24.0 degree.C. Liquid Temp.; 23.5 degree.C.

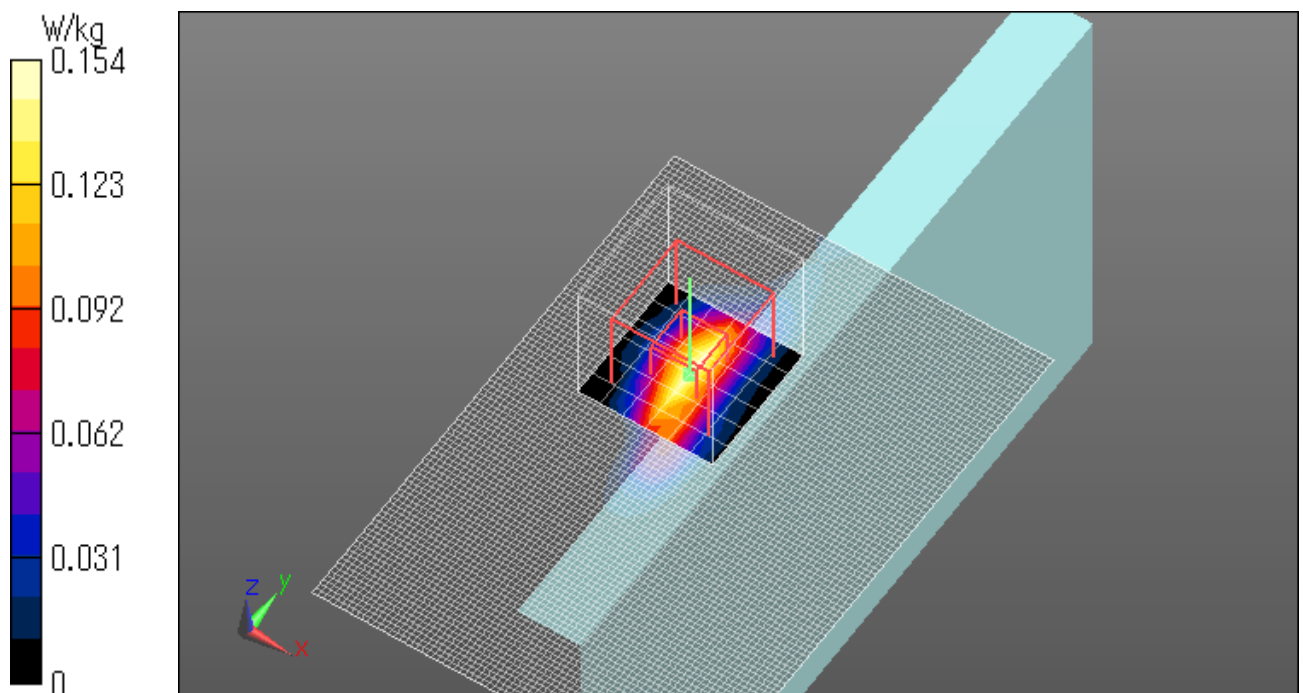

WLAN 11b 2412MHz Ant1 Front

Communication System: UID 0, WLAN (0); Communication System Band: 11b/g/n; Frequency: 2412 MHz; Duty Cycle: 1:1

Medium parameters used (interpolated): $f = 2412$ MHz; $\sigma = 1.971$ S/m; $\epsilon_r = 51.003$; $\rho = 1000$ kg/m³

Phantom section: Flat Section

Measurement Standard: DASY5 (IEEE/IEC/ANSI C63.19-2011)

DASY5 Configuration

Probe: EX3DV4 - SN3825; ConvF(7.29, 7.29, 7.29); Calibrated: 2015/12/11;

Sensor-Surface: 1.4mm (Mechanical Surface Detection)

Electronics: DAE4 Sn509; Calibrated: 2016/07/07

Phantom: ELI v5.0 (30deg probe tilt); Type: QDOVA002AA; Serial: TP:xxxx

Measurement SW: DASY52, Version 52.8 (8); SEMCAD X Version 14.6.10 (7331)

Front/5mm Ant1/Area Scan 3 (51x121x1): Interpolated grid: dx=1.200 mm, dy=1.200 mm

Maximum value of SAR (interpolated) = 0.0345 W/kg

Front/5mm Ant1/Zoom Scan (7x7x7)/Cube 0: Measurement grid: dx=5mm, dy=5mm, dz=5mm

Reference Value = 3.947 V/m; Power Drift = 0.06 dB

Peak SAR (extrapolated) = 0.0370 W/kg

SAR(1 g) = 0.013 W/kg; SAR(10 g) = 0.0027 W/kg

Maximum value of SAR (measured) = 0.0292 W/kg

Date: 2016/11/14

Ambient Temp. : 24.0 degree.C. Liquid Temp.; 23.5 degree.C.

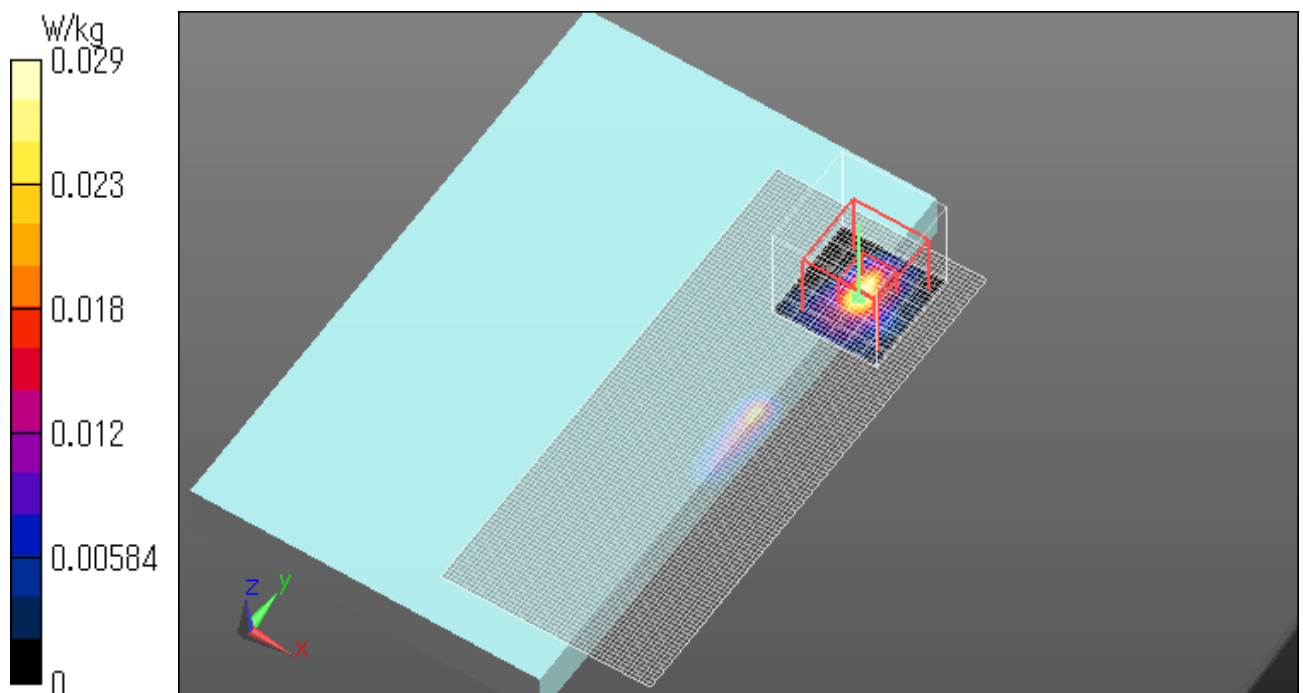

WLAN 11b 2412MHz Ant1 Rear

Communication System: UID 0, WLAN (0); Communication System Band: 11b/g/n; Frequency: 2412 MHz; Duty Cycle: 1:1

Medium parameters used (interpolated): $f = 2412$ MHz; $\sigma = 1.971$ S/m; $\epsilon_r = 51.003$; $\rho = 1000$ kg/m³

Phantom section: Flat Section

Measurement Standard: DASYS (IEEE/IEC/ANSI C63.19-2011)

DASY5 Configuration

Probe: EX3DV4 - SN3825; ConvF(7.29, 7.29, 7.29); Calibrated: 2015/12/11;

Sensor-Surface: 1.4mm (Mechanical Surface Detection)

Electronics: DAE4 Sn509; Calibrated: 2016/07/07

Phantom: ELI v5.0 (30deg probe tilt); Type: QDOVA002AA; Serial: TP:xxxx

Measurement SW: DASYS2, Version 52.8 (8); SEMCAD X Version 14.6.10 (7331)

Rear/5mm Ant1/Area Scan 2 (71x171x1): Interpolated grid: dx=1.200 mm, dy=1.200 mm

Maximum value of SAR (interpolated) = 0.0206 W/kg

Rear/5mm Ant1/Zoom Scan (7x7x7)/Cube 0: Measurement grid: dx=5mm, dy=5mm, dz=5mm

Reference Value = 2.912 V/m; Power Drift = -0.14 dB

Peak SAR (extrapolated) = 0.0400 W/kg

SAR(1 g) = 0.00487 W/kg; SAR(10 g) = 0.000851 W/kg

Maximum value of SAR (measured) = 0.0211 W/kg

Date: 2016/11/14

Ambient Temp. : 24.0 degree.C. Liquid Temp.; 23.5 degree.C.

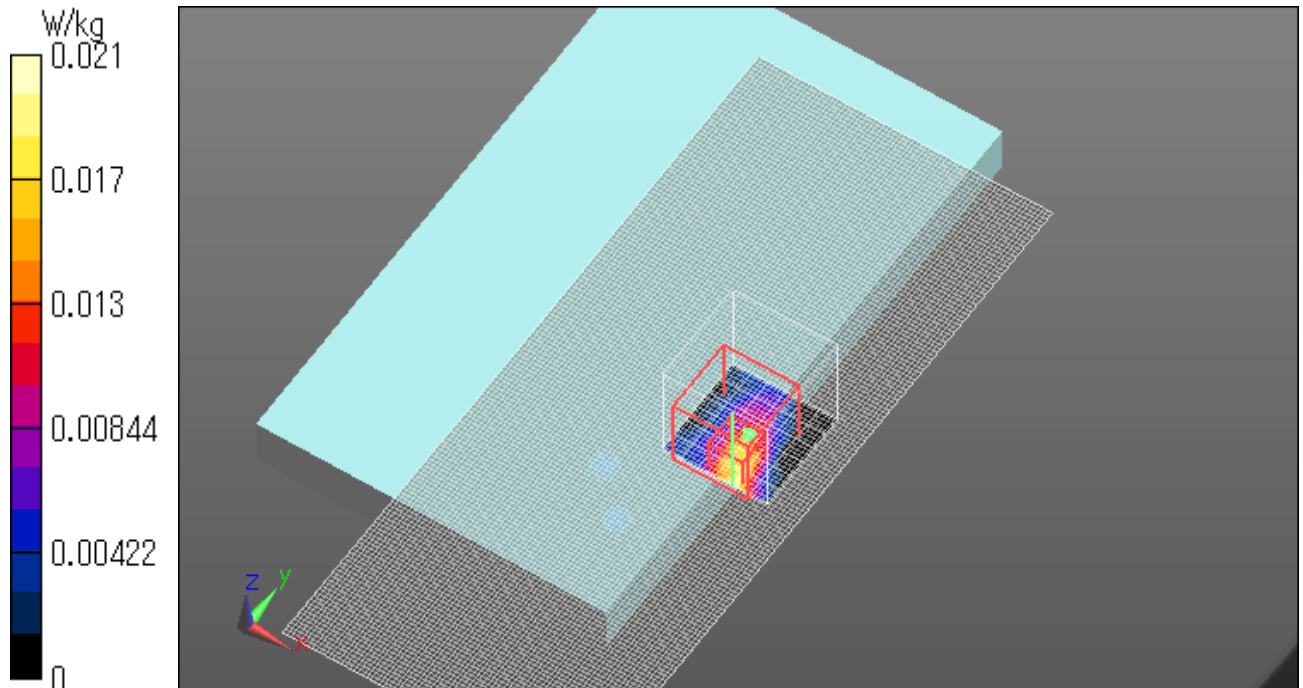

WLAN 11n HT40 5270MHz Ant0 Top 5mm

Communication System: UID 0, WLAN 11a/b/g/n (0); Communication System Band: 11a/n (W52 53); Frequency: 5270 MHz; Duty Cycle: 1:1

Medium parameters used: $f = 5270$ MHz; $\sigma = 5.502$ S/m; $\epsilon_r = 46.651$; $\rho = 1000$ kg/m³

Phantom section: Flat Section

Measurement Standard: DASY5 (IEEE/IEC/ANSI C63.19-2011)

DASY5 Configuration

Probe: EX3DV4 - SN3825; ConvF(4.25, 4.25, 4.25); Calibrated: 2015/12/11;

Sensor-Surface: 1.4mm (Mechanical Surface Detection)

Electronics: DAE4 Sn509; Calibrated: 2016/07/07

Phantom: ELI v4.0 (20deg probe tilt); Type: QDOVA001BB; Serial: TP:1045

Measurement SW: DASY52, Version 52.8 (8); SEMCAD X Version 14.6.10 (7331)

Top/11n HT40/Area Scan 2 (91x151x1): Interpolated grid: dx=1.000 mm, dy=1.000 mm

Maximum value of SAR (interpolated) = 0.882 W/kg

Top/11n HT40/Zoom Scan (4x4x1.4mm, graded), dist=1.4mm (8x8x7)/Cube 0: Measurement grid: dx=4mm, dy=4mm, dz=1.4mm

Reference Value = 14.71 V/m; Power Drift = 0.05 dB

Peak SAR (extrapolated) = 1.41 W/kg

SAR(1 g) = 0.333 W/kg; SAR(10 g) = 0.083 W/kg

Maximum value of SAR (measured) = 0.858 W/kg

Date: 2016/11/17

Ambient Temp. : 24.0 degree.C. Liquid Temp.; 23.5 degree.C.

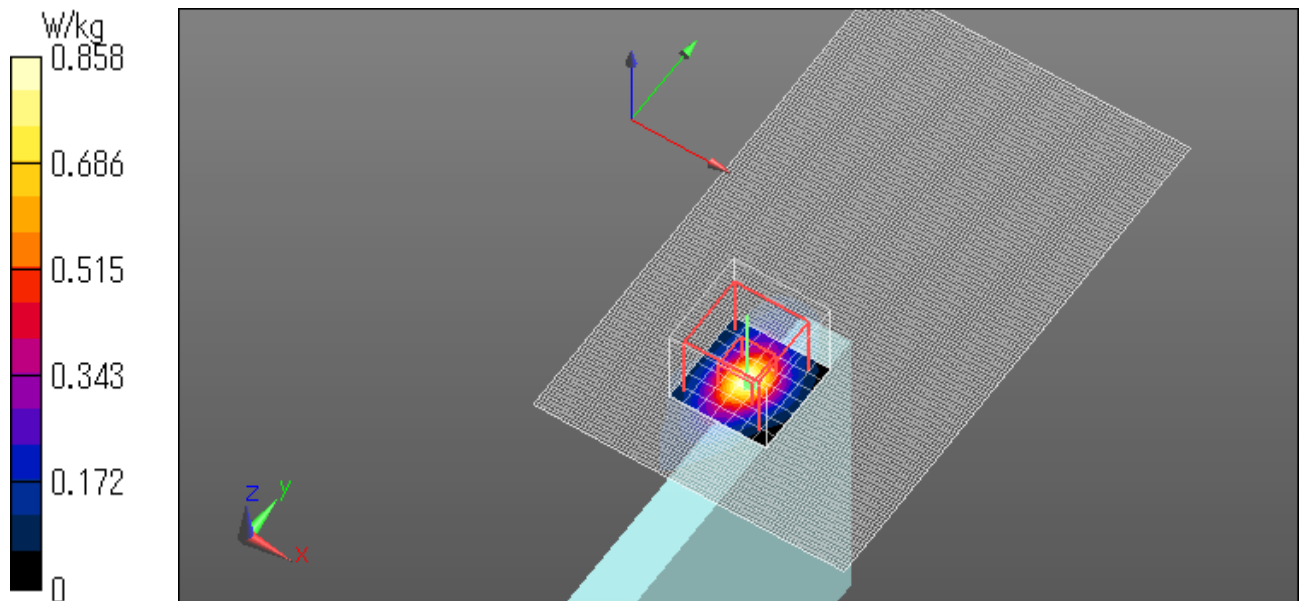

WLAN 11n HT40 5270MHz Ant0 Left 5mm

Communication System: UID 0, WLAN 11a/b/g/n (0); Communication System Band: 11a/n (W52 53); Frequency: 5270 MHz; Duty Cycle: 1:1

Medium parameters used: $f = 5270$ MHz; $\sigma = 5.502$ S/m; $\epsilon_r = 46.651$; $\rho = 1000$ kg/m³

Phantom section: Flat Section

Measurement Standard: DASY5 (IEEE/IEC/ANSI C63.19-2011)

DASY5 Configuration

Probe: EX3DV4 - SN3825; ConvF(4.25, 4.25, 4.25); Calibrated: 2015/12/11;

Sensor-Surface: 1.4mm (Mechanical Surface Detection)

Electronics: DAE4 Sn509; Calibrated: 2016/07/07

Phantom: ELI v4.0 (20deg probe tilt); Type: QDOVA001BB; Serial: TP:1045

Measurement SW: DASY52, Version 52.8 (8); SEMCAD X Version 14.6.10 (7331)

Left/11n HT40/Area Scan 2 (91x151x1): Interpolated grid: dx=1.000 mm, dy=1.000 mm

Maximum value of SAR (interpolated) = 0.0887 W/kg

Left/11n HT40/Zoom Scan (4x4x1.4mm, graded), dist=1.4mm (8x8x7)/Cube 0: Measurement grid: dx=4mm, dy=4mm, dz=1.4mm

Reference Value = 2.972 V/m; Power Drift = -0.18 dB

Peak SAR (extrapolated) = 0.220 W/kg

SAR(1 g) = 0.013 W/kg; SAR(10 g) = 0.00527 W/kg

Maximum value of SAR (measured) = 0.0444 W/kg

Date: 2016/11/17

Ambient Temp. : 24.0 degree.C. Liquid Temp.; 23.5 degree.C.

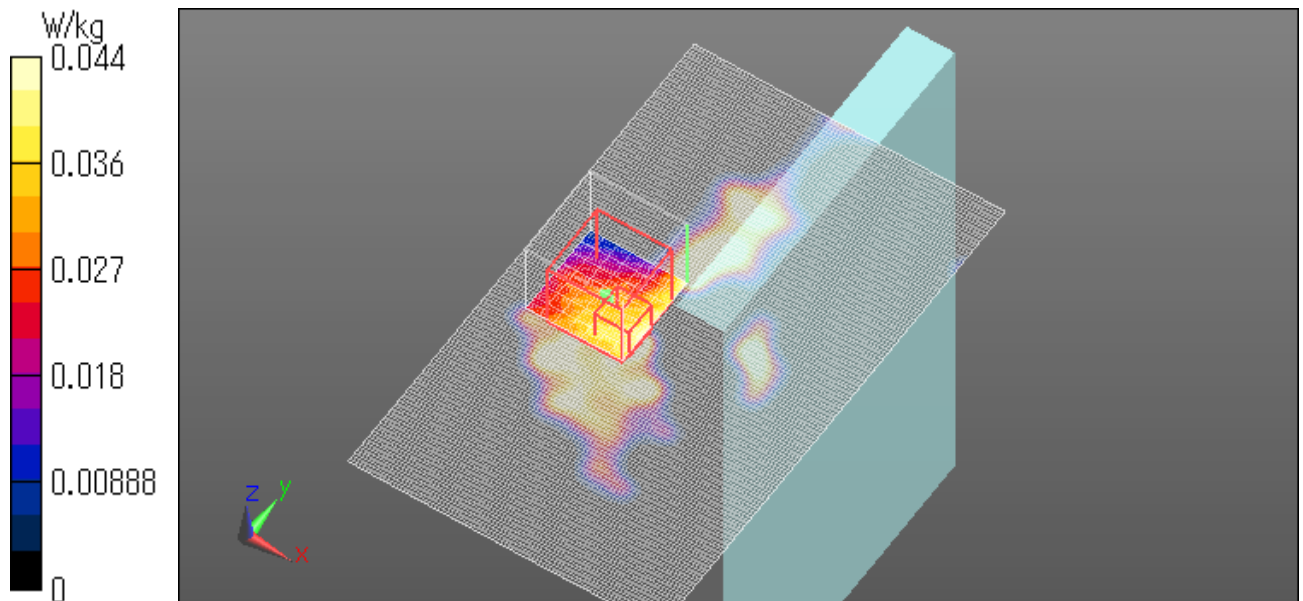

WLAN 11n HT40 5270MHz Ant0 Front 5mm

Communication System: UID 0, WLAN 11a/b/g/n (0); Communication System Band: 11a/n (W52 53); Frequency: 5270 MHz; Duty Cycle: 1:1

Medium parameters used: $f = 5270$ MHz; $\sigma = 5.502$ S/m; $\epsilon_r = 46.651$; $\rho = 1000$ kg/m³

Phantom section: Flat Section

Measurement Standard: DASY5 (IEEE/IEC/ANSI C63.19-2011)

DASY5 Configuration

Probe: EX3DV4 - SN3825; ConvF(4.25, 4.25, 4.25); Calibrated: 2015/12/11;

Sensor-Surface: 1.4mm (Mechanical Surface Detection)

Electronics: DAE4 Sn509; Calibrated: 2016/07/07

Phantom: ELI v4.0 (20deg probe tilt); Type: QDOVA001BB; Serial: TP:1045

Measurement SW: DASY52, Version 52.8 (8); SEMCAD X Version 14.6.10 (7331)

Front/11n HT40/Area Scan 3 (61x121x1): Interpolated grid: dx=1.000 mm, dy=1.000 mm

Maximum value of SAR (interpolated) = 0.489 W/kg

Front/11n HT40/Zoom Scan (4x4x1.4mm, graded), dist=1.4mm (8x8x7)/Cube 0: Measurement grid: dx=4mm, dy=4mm, dz=1.4mm

Reference Value = 12.17 V/m; Power Drift = -0.10 dB

Peak SAR (extrapolated) = 0.983 W/kg

SAR(1 g) = 0.214 W/kg; SAR(10 g) = 0.055 W/kg

Maximum value of SAR (measured) = 0.597 W/kg

Date: 2016/11/17

Ambient Temp. : 24.0 degree.C. Liquid Temp.; 23.5 degree.C.

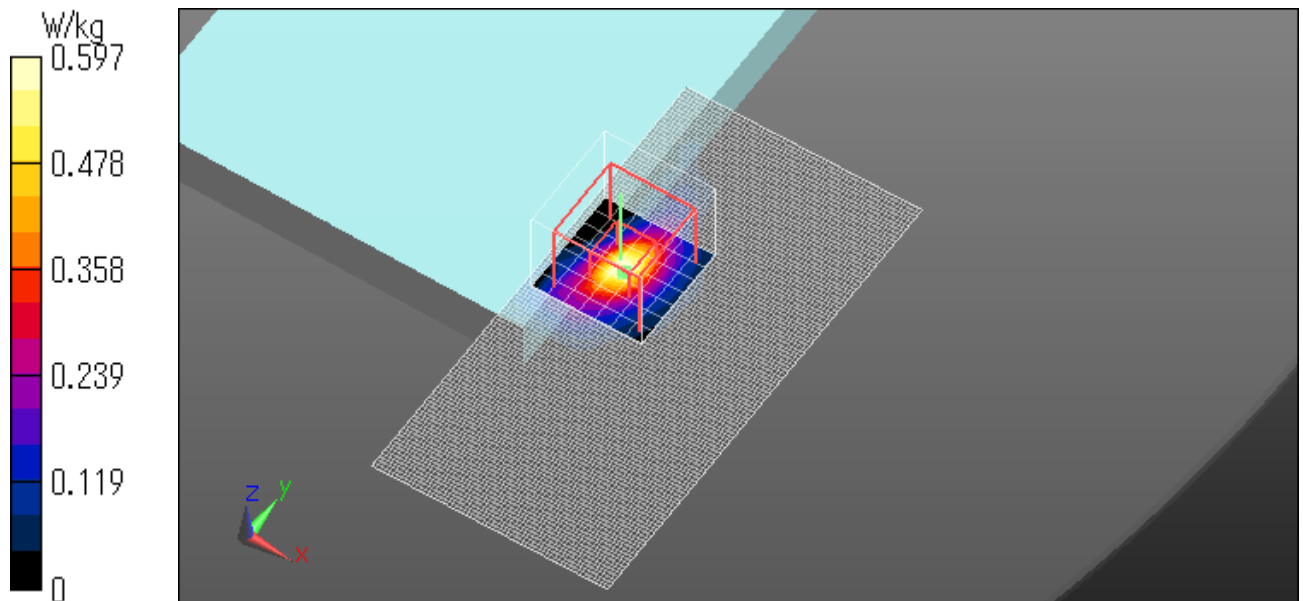

WLAN 11n HT40 5270MHz Ant0 Rear 5mm

Communication System: UID 0, WLAN 11a/b/g/n (0); Communication System Band: 11a/n (W52 53); Frequency: 5270 MHz; Duty Cycle: 1:1

Medium parameters used: $f = 5270$ MHz; $\sigma = 5.502$ S/m; $\epsilon_r = 46.651$; $\rho = 1000$ kg/m³

Phantom section: Flat Section

Measurement Standard: DASY5 (IEEE/IEC/ANSI C63.19-2011)

DASY5 Configuration

Probe: EX3DV4 - SN3825; ConvF(4.25, 4.25, 4.25); Calibrated: 2015/12/11;

Sensor-Surface: 1.4mm (Mechanical Surface Detection)

Electronics: DAE4 Sn509; Calibrated: 2016/07/07

Phantom: ELI v4.0 (20deg probe tilt); Type: QDOVA001BB; Serial: TP:1045

Measurement SW: DASY52, Version 52.8 (8); SEMCAD X Version 14.6.10 (7331)

Rear/11n HT40/Area Scan 2 (91x121x1): Interpolated grid: dx=1.000 mm, dy=1.000 mm

Maximum value of SAR (interpolated) = 0.297 W/kg

Rear/11n HT40/Zoom Scan (4x4x1.4mm, graded), dist=1.4mm (8x8x7)/Cube 0: Measurement grid: dx=4mm, dy=4mm, dz=1.4mm

Reference Value = 8.015 V/m; Power Drift = -0.11 dB

Peak SAR (extrapolated) = 0.413 W/kg

SAR(1 g) = 0.098 W/kg; SAR(10 g) = 0.033 W/kg

Maximum value of SAR (measured) = 0.272 W/kg

Date: 2016/11/17

Ambient Temp. : 24.0 degree.C. Liquid Temp.; 23.5 degree.C.

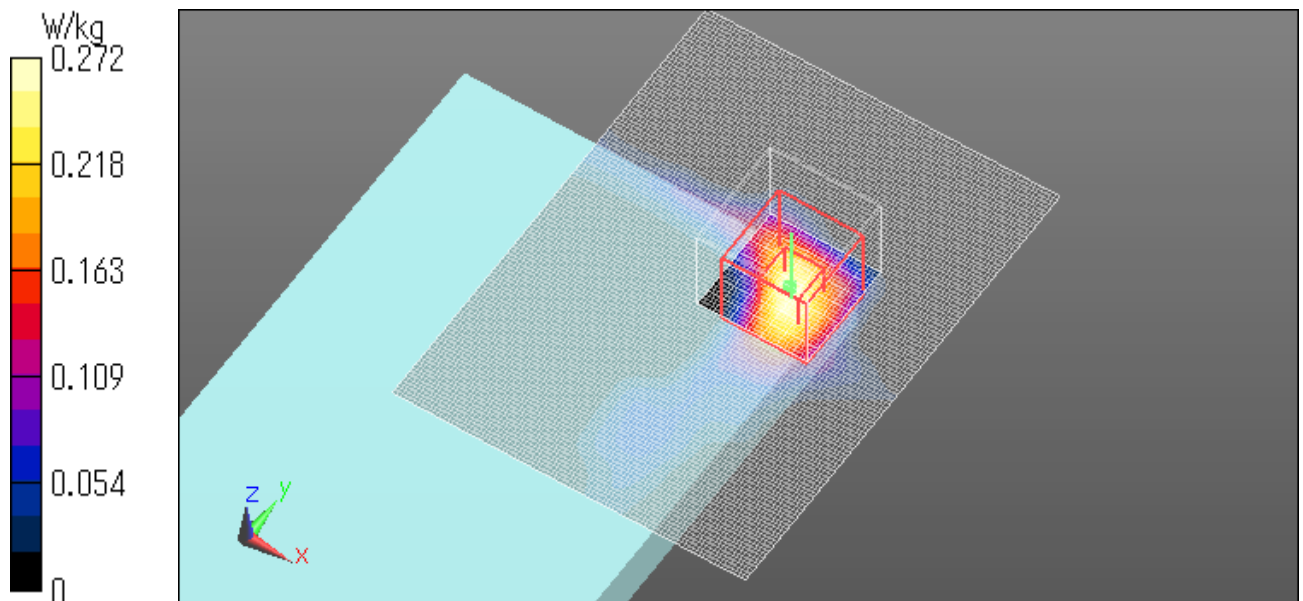

WLAN 11n HT40 5270MHz Ant1 Top 5mm

Communication System: UID 0, WLAN 11a/b/g/n (0); Communication System Band: 11a/n (W52 53); Frequency: 5270 MHz; Duty Cycle: 1:1

Medium parameters used: $f = 5270$ MHz; $\sigma = 5.502$ S/m; $\epsilon_r = 46.651$; $\rho = 1000$ kg/m³

Phantom section: Flat Section

Measurement Standard: DASY5 (IEEE/IEC/ANSI C63.19-2011)

DASY5 Configuration

Probe: EX3DV4 - SN3825; ConvF(4.25, 4.25, 4.25); Calibrated: 2015/12/11;

Sensor-Surface: 1.4mm (Mechanical Surface Detection)

Electronics: DAE4 Sn509; Calibrated: 2016/07/07

Phantom: ELI v4.0 (20deg probe tilt); Type: QDOVA001BB; Serial: TP:1045

Measurement SW: DASY52, Version 52.8 (8); SEMCAD X Version 14.6.10 (7331)

Top/5mm/Area Scan 2 (91x151x1): Interpolated grid: dx=1.000 mm, dy=1.000 mm
Maximum value of SAR (interpolated) = 0.930 W/kg

Top/5mm/Zoom Scan (4x4x1.4mm, graded), dist=1.4mm (8x8x7)/Cube 0: Measurement grid: dx=4mm, dy=4mm, dz=1.4mm

Reference Value = 14.71 V/m; Power Drift = -0.11 dB

Peak SAR (extrapolated) = 1.42 W/kg

SAR(1 g) = 0.300 W/kg; SAR(10 g) = 0.060 W/kg

Maximum value of SAR (measured) = 0.851 W/kg

Date: 2016/11/17

Ambient Temp. : 24.0 degree.C. Liquid Temp.; 23.5 degree.C.

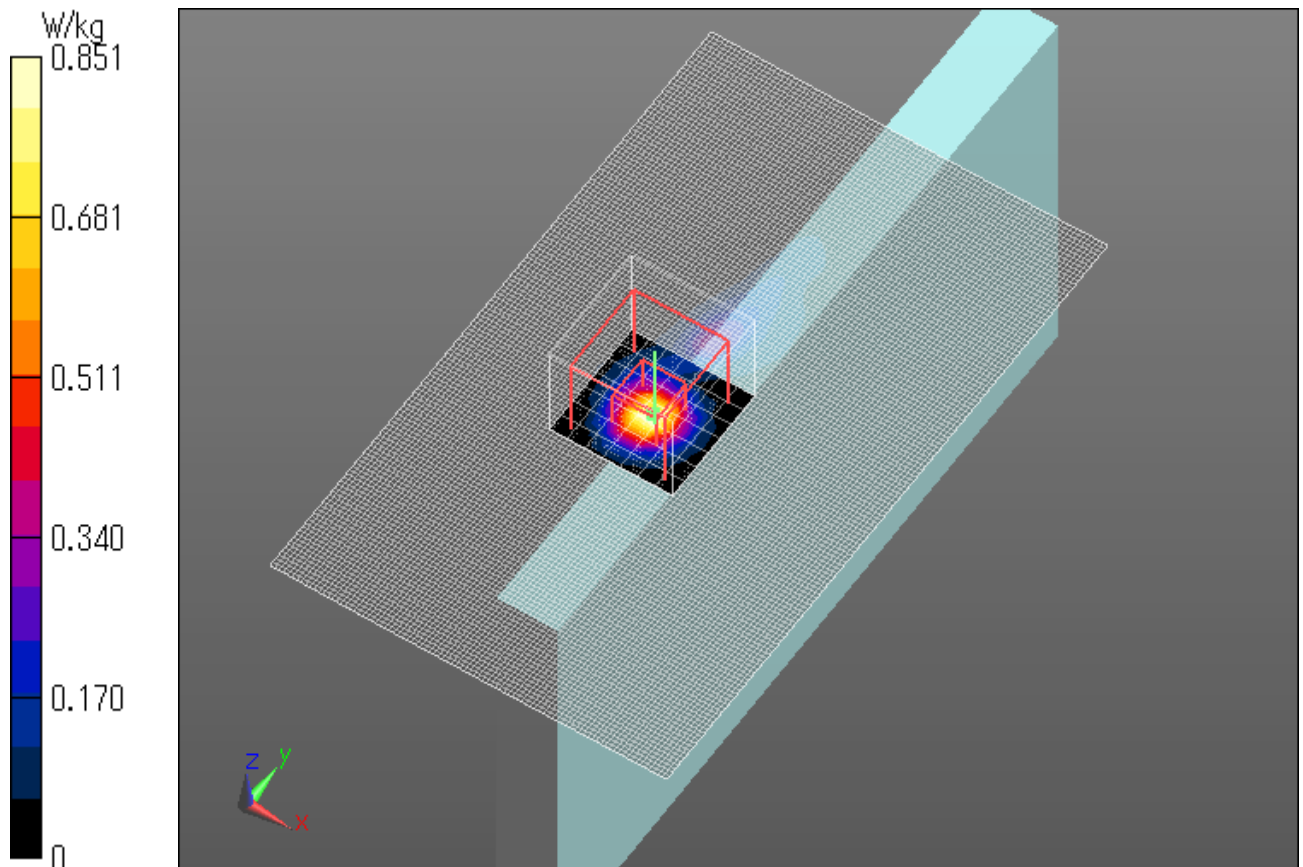

Front add WLAN 11n 5270MHz Ant1 Front 5mm

Communication System: UID 0, WLAN 11a/b/g/n (0); Communication System Band: 11a/n (W52 53); Frequency: 5270 MHz; Duty Cycle: 1:1

Medium parameters used: $f = 5270$ MHz; $\sigma = 5.502$ S/m; $\epsilon_r = 46.651$; $\rho = 1000$ kg/m³

Phantom section: Flat Section

Measurement Standard: DASY5 (IEEE/IEC/ANSI C63.19-2011)

DASY5 Configuration

Probe: EX3DV4 - SN3825; ConvF(4.25, 4.25, 4.25); Calibrated: 2015/12/11;

Sensor-Surface: 1.4mm (Mechanical Surface Detection)

Electronics: DAE4 Sn509; Calibrated: 2016/07/07

Phantom: ELI v4.0 (20deg probe tilt); Type: QDOVA001BB; Serial: TP:1045

Measurement SW: DASY52, Version 52.8 (8); SEMCAD X Version 14.6.10 (7331)

Front/5mm 2nd/Area Scan 2 (61x91x1): Interpolated grid: dx=1.000 mm, dy=1.000 mm

Maximum value of SAR (interpolated) = 0.374 W/kg

Front/5mm 2nd/Zoom Scan (4x4x1.4mm, graded), dist=1.4mm (8x8x7)/Cube 0: Measurement grid: dx=4mm, dy=4mm, dz=1.4mm

Reference Value = 7.512 V/m; Power Drift = -0.11 dB

Peak SAR (extrapolated) = 0.428 W/kg

SAR(1 g) = 0.090 W/kg; SAR(10 g) = 0.020 W/kg

Maximum value of SAR (measured) = 0.278 W/kg

Front/5mm 2nd/Area Scan 2 2 (61x91x1): Interpolated grid: dx=1.000 mm, dy=1.000 mm

Maximum value of SAR (interpolated) = 0.140 W/kg

Date: 2016/11/17

Ambient Temp. : 24.0 degree.C. Liquid Temp.; 23.5 degree.C.

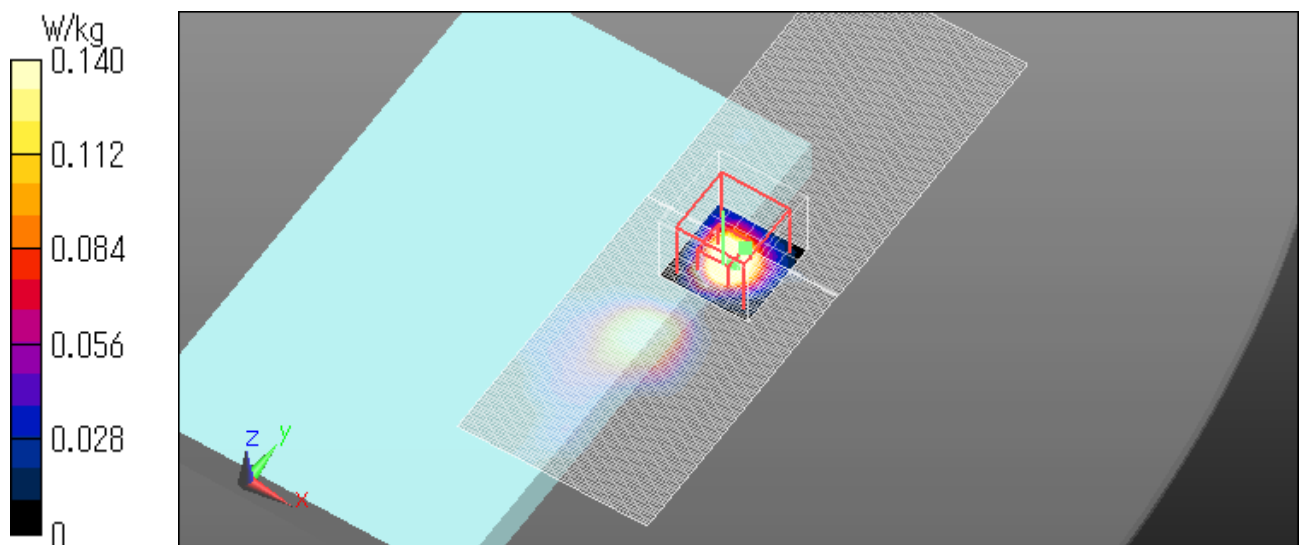

WLAN 11n HT40 5270MHz Ant1 Rear 5mm

Communication System: UID 0, WLAN 11a/b/g/n (0); Communication System Band: 11a/n (W52 53); Frequency: 5270 MHz; Duty Cycle: 1:1

Medium parameters used: $f = 5270$ MHz; $\sigma = 5.502$ S/m; $\epsilon_r = 46.651$; $\rho = 1000$ kg/m³

Phantom section: Flat Section

Measurement Standard: DASY5 (IEEE/IEC/ANSI C63.19-2011)

DASY5 Configuration

Probe: EX3DV4 - SN3825; ConvF(4.25, 4.25, 4.25); Calibrated: 2015/12/11;

Sensor-Surface: 1.4mm (Mechanical Surface Detection)

Electronics: DAE4 Sn509; Calibrated: 2016/07/07

Phantom: ELI v4.0 (20deg probe tilt); Type: QDOVA001BB; Serial: TP:1045

Measurement SW: DASY52, Version 52.8 (8); SEMCAD X Version 14.6.10 (7331)

Rear/5mm/Area Scan 2 (61x121x1): Interpolated grid: dx=1.000 mm, dy=1.000 mm

Maximum value of SAR (interpolated) = 0.191 W/kg

Rear/5mm/Zoom Scan (4x4x1.4mm, graded), dist=1.4mm (8x8x7)/Cube 0: Measurement grid: dx=4mm, dy=4mm, dz=1.4mm

Reference Value = 4.989 V/m; Power Drift = -0.14 dB

Peak SAR (extrapolated) = 0.343 W/kg

SAR(1 g) = 0.034 W/kg; SAR(10 g) = 0.00758 W/kg

Maximum value of SAR (measured) = 0.108 W/kg

Date: 2016/11/17

Ambient Temp. : 24.0 degree.C. Liquid Temp.; 23.5 degree.C.

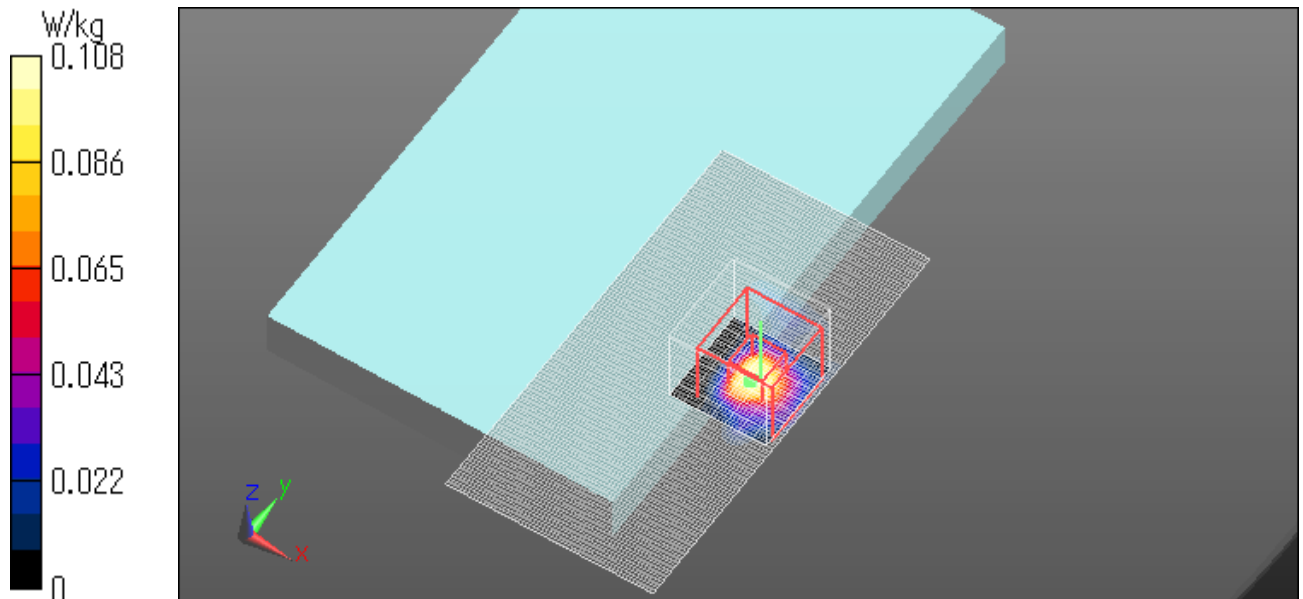

APPENDIX 2 : System Check

System check result Body 2450MHz

BODY 2450MHz System Check DATA / Dipole 2450MHz / Forward Conducted Power : 250mW

Communication System: UID 0, CW (0); Communication System Band: D2450 (2450.0 MHz); Frequency: 2450 MHz;
Duty Cycle: 1:1

Medium parameters used: $f = 2450$ MHz; $\sigma = 2.025$ S/m; $\epsilon_r = 50.91$; $\rho = 1000$ kg/m³

Phantom section: Flat Section

Measurement Standard: DASY5 (IEEE/IEC/ANSI C63.19-2007)

DASY5 Configuration

Probe: EX3DV4 - SN3825; ConvF(7.29, 7.29, 7.29); Calibrated: 2015/12/11;

Sensor-Surface: 2mm (Mechanical Surface Detection)

Electronics: DAE4 Sn509; Calibrated: 2016/07/07

Phantom: ELI v5.0 (30deg probe tilt); Type: QDOVA002AA; Serial: TP:xxxx

Measurement SW: DASY52, Version 52.8 (8); SEMCAD X Version 14.6.10 (7331)

Area Scan (81x71x1): Interpolated grid: dx=1.200 mm, dy=1.200 mm

Maximum value of SAR (interpolated) = 20.8 W/kg

Zoom Scan (7x7x7) (7x7x7)/Cube 0: Measurement grid: dx=5mm, dy=5mm, dz=5mm

Reference Value = 102.4 V/m; Power Drift = -0.01 dB

Peak SAR (extrapolated) = 27.7 W/kg

SAR(1 g) = 13.4 W/kg; SAR(10 g) = 6.18 W/kg

Maximum value of SAR (measured) = 20.6 W/kg

Date: 2016/11/14

Ambient Temp. : 24.0 degree.C. Liquid Temp.; 23.5 degree.C.

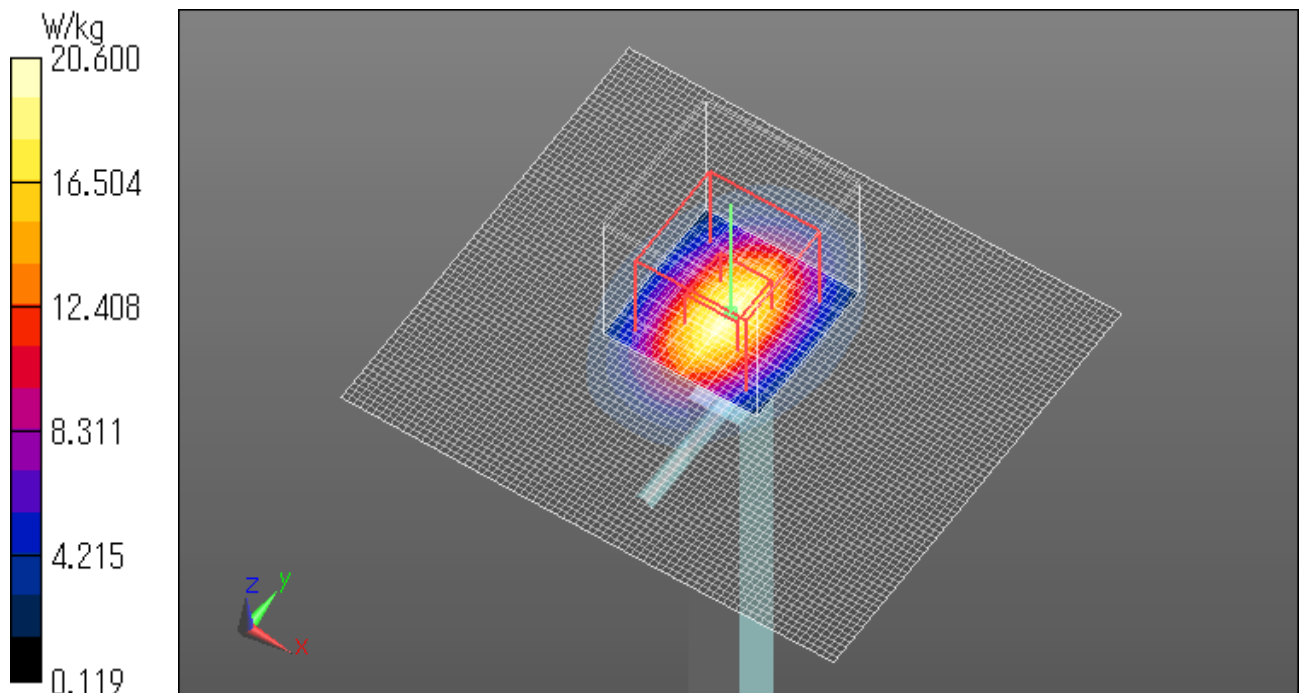

BODY 2450MHz System Check DATA / Dipole 2450MHz / Forward Conducted Power : 250mW

Communication System: UID 0, CW (0); Communication System Band: D2450 (2450.0 MHz); Frequency: 2450 MHz;
Duty Cycle: 1:1

Medium parameters used: $f = 2450$ MHz; $\sigma = 2.025$ S/m; $\epsilon_r = 50.91$; $\rho = 1000$ kg/m³

Phantom section: Flat Section

Measurement Standard: DASYS5 (IEEE/IEC/ANSI C63.19-2007)

DASY5 Configuration

Probe: EX3DV4 - SN3825; ConvF(7.29, 7.29, 7.29); Calibrated: 2015/12/11;

Sensor-Surface: 0mm (Fix Surface)

Electronics: DAE4 Sn509; Calibrated: 2016/07/07

Phantom: ELI v5.0 (30deg probe tilt); Type: QDOVA002AA; Serial: TP:xxxx

Measurement SW: DASYS52, Version 52.8 (8); SEMCAD X Version 14.6.10 (7331)

Z Scan (1x1x31): Measurement grid: dx=20mm, dy=20mm, dz=5mm

Maximum value of SAR (measured) = 11.9 W/kg

Date: 2016/11/14

Ambient Temp. : 24.0 degree.C. Liquid Temp.; 23.5 degree.C.

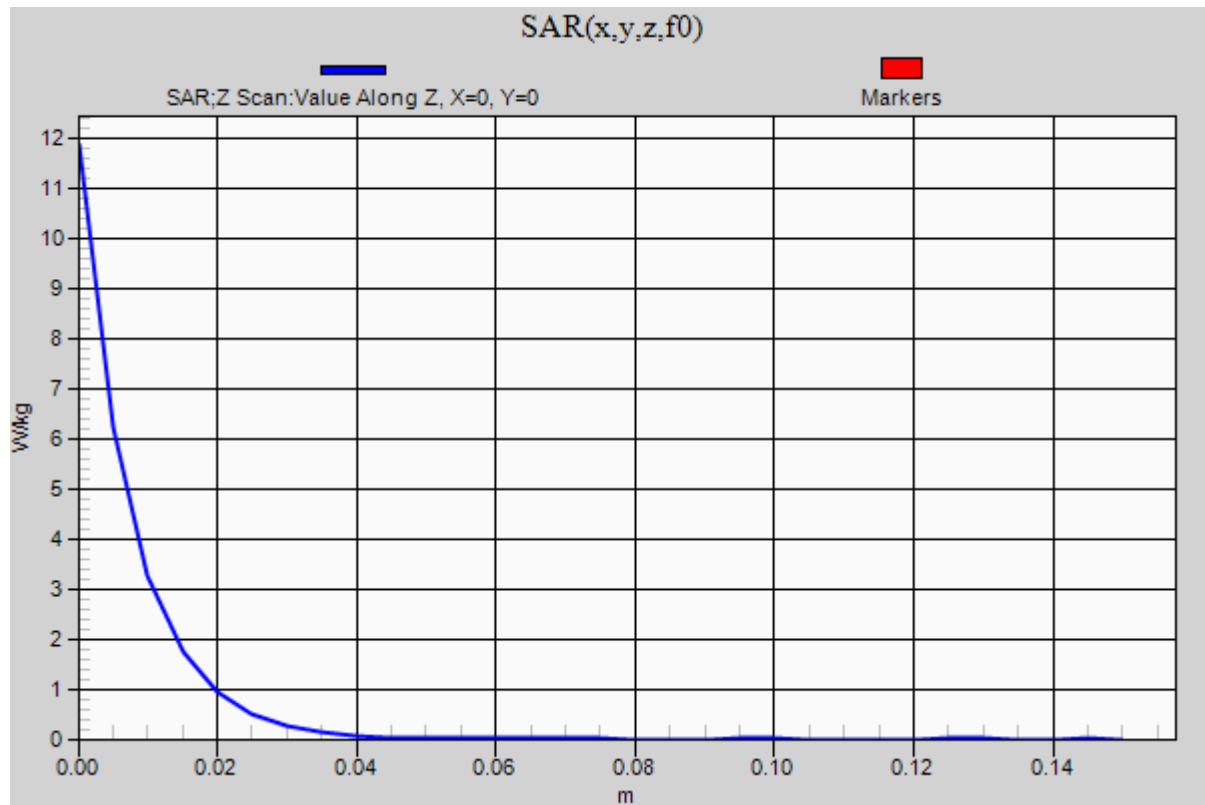

BODY 5250MHz System Check DATA / Dipole 5GHz / Forward Conducted Power : 100mW

Communication System: UID 0, CW; Communication System Band: D5GHz (5000.0 - 6000.0 MHz); Frequency: 5250 MHz; Duty Cycle: 1:1

Medium parameters used: $f = 5250$ MHz; $\sigma = 5.451$ S/m; $\epsilon_r = 46.783$; $\rho = 1000$ kg/m³

Phantom section: Flat Section

Measurement Standard: DASYS (IEEE/IEC/ANSI C63.19-2011)

DASY5 Configuration

Probe: EX3DV4 - SN3825; ConvF(4.25, 4.25, 4.25); Calibrated: 2015/12/11;

Sensor-Surface: 1.4mm (Mechanical Surface Detection)

Electronics: DAE4 Sn509; Calibrated: 2016/07/07

Phantom: ELI v4.0 (20deg probe tilt); Type: QDOVA001BB; Serial: TP:1045

Measurement SW: DASYS2, Version 52.8 (8); SEMCAD X Version 14.6.10 (7331)

Area Scan (91x91x1): Interpolated grid: dx=1.000 mm, dy=1.000 mm

Maximum value of SAR (interpolated) = 17.5 W/kg

Zoom Scan (4x4x1.4mm, graded), dist=1.4mm (8x8x7)/Cube 0: Measurement grid: dx=4mm, dy=4mm, dz=1.4mm

Reference Value = 68.90 V/m; Power Drift = -0.03 dB

Peak SAR (extrapolated) = 30.1 W/kg

SAR(1 g) = 7.55 W/kg; SAR(10 g) = 2.11 W/kg

Maximum value of SAR (measured) = 17.8 W/kg

Date: 2016/11/17

Ambient Temp. : 24.0 degree.C. Liquid Temp.; 23.5 degree.C.

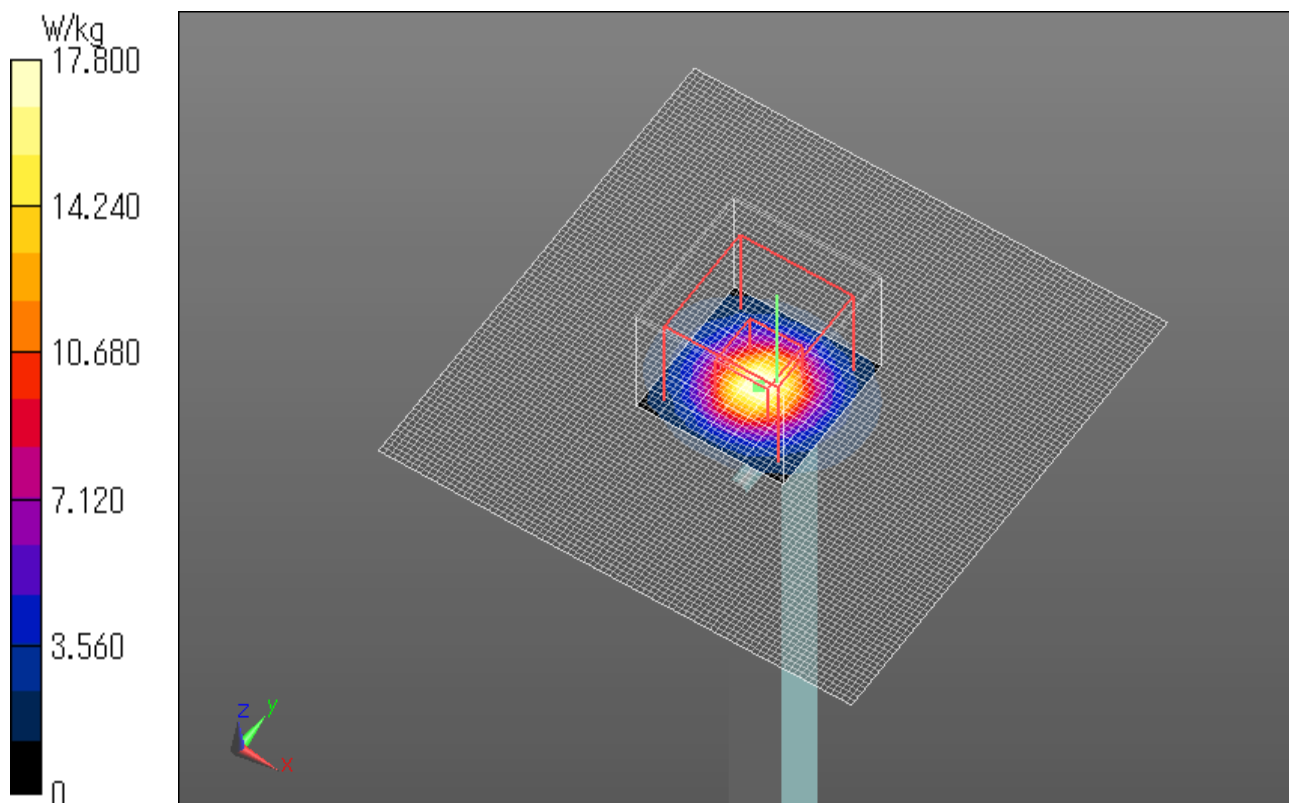

BODY 5250MHz System Check DATA / Dipole 5GHz / Forward Conducted Power : 100mW

Communication System: UID 0, CW; Communication System Band: D5GHz (5000.0 - 6000.0 MHz); Frequency: 5250 MHz; Duty Cycle: 1:1

Medium parameters used: $f = 5250$ MHz; $\sigma = 5.451$ S/m; $\epsilon_r = 46.783$; $\rho = 1000$ kg/m³

Phantom section: Flat Section

Measurement Standard: DASYS5 (IEEE/IEC/ANSI C63.19-2011)

DASY5 Configuration

Probe: EX3DV4 - SN3825; ConvF(4.25, 4.25, 4.25); Calibrated: 2015/12/11;

Sensor-Surface: 0mm (Fix Surface)

Electronics: DAE4 Sn509; Calibrated: 2016/07/07

Phantom: ELI v4.0 (20deg probe tilt); Type: QDOVA001BB; Serial: TP:1045

Measurement SW: DASYS52, Version 52.8 (8); SEMCAD X Version 14.6.10 (7331)

Z Scan (1x1x31): Measurement grid: dx=20mm, dy=20mm, dz=5mm

Maximum value of SAR (measured) = 10.8 W/kg

Date: 2016/11/17

Ambient Temp. : 24.0 degree.C. Liquid Temp.; 23.5 degree.C.

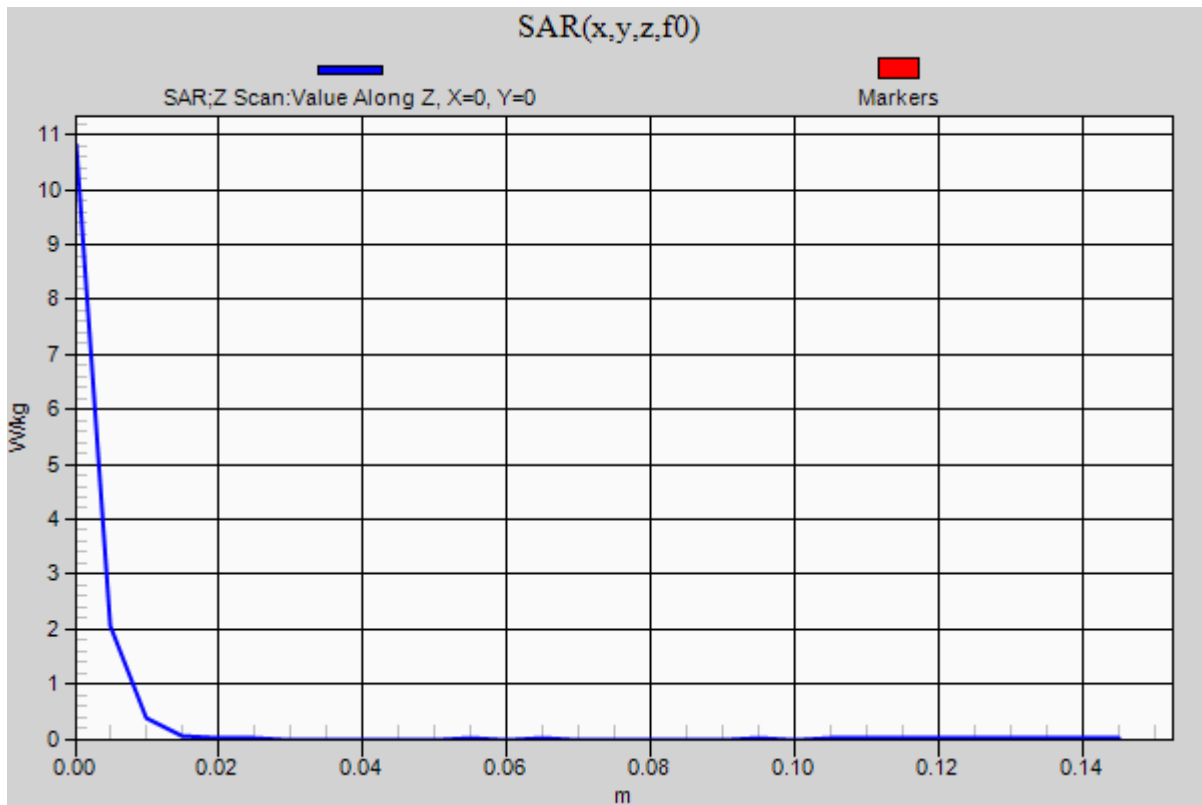

APPENDIX 3 : System specifications

Configuration and peripherals

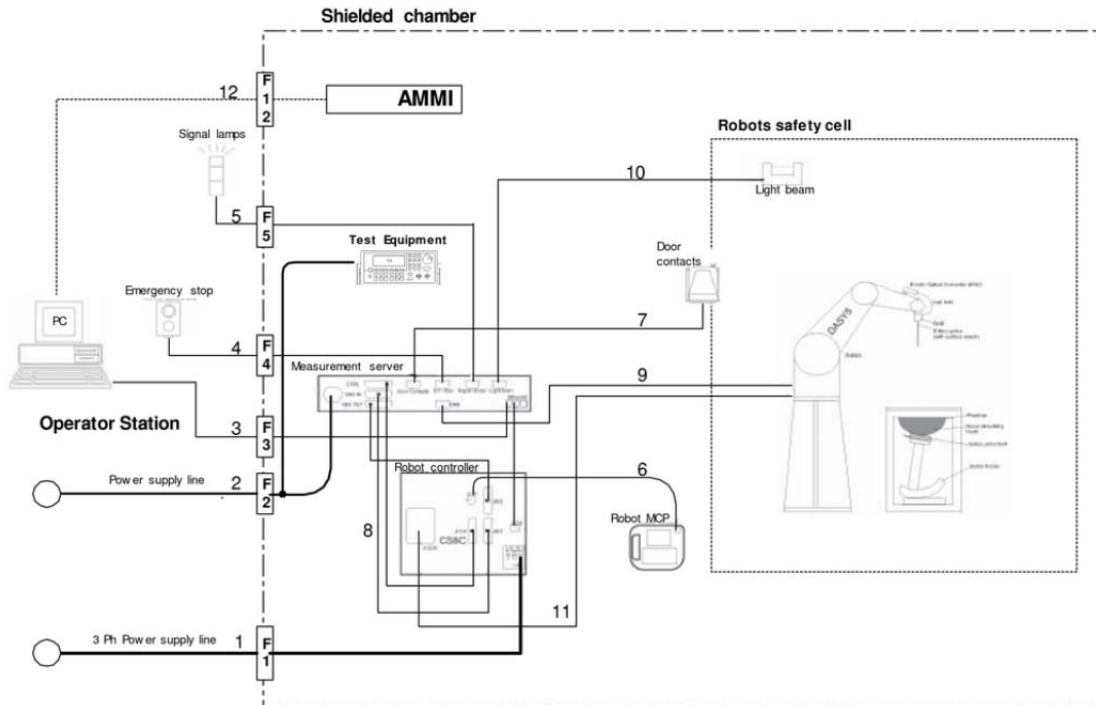

The DASYS system for performing compliance tests consist of the following items:

- a) A standard high precision 6-axis robot (Stäubli RX family) with controller and software.
An arm extension for accommodating the data acquisition electronics (DAE).
- b) An isotropic field probe optimized and calibrated for the targeted measurement.
- c) A data acquisition electronic (DAE), which performs the signal amplification, signal multiplexing, AD-conversion, offset measurements, mechanical surface detection, collision detection, etc. The unit is battery powered with standard or rechargeable batteries. The signal is optically transmitted to the EOC.
- d) The Electro-optical converter (EOC) performs the conversion between optical and electrical of the signals for the digital communication to the DAE and for the analog signal from the optical surface detection.
The EOC is connected to the measurement server.
- e) The function of the measurement server is to perform the time critical tasks such as signal filtering, control of the robot operation and fast movement interrupts.
- f) The Light Beam used is for probe alignment. This improves the (absolute) accuracy of the probe positioning.
- g) A computer running WinXP and the DASYS software.
- h) Remote control with teaches pendant and additional circuitry for robot safety such as warning lamps, etc.
- i) The phantom, the device holder and other accessories according to the targeted measurement.

UL Japan, Inc.

Ise EMC Lab.

4383-326 Asama-cho, Ise-shi, Mie-ken 516-0021 JAPAN

Telephone: +81 596 24 8999

Facsimile: +81 596 24 8124

Specifications

a) Robot TX60L

Number of Axes	:	6
Nominal Load	:	2 kg
Maximum Load	:	5kg
Reach	:	920mm
Repeatability	:	+/-0.03mm
Control Unit	:	CS8c
Programming Language	:	VAL3
Weight	:	52.2kg
Manufacture	:	Stäubli Robotics

b) E-Field Probe

Model	:	EX3DV4
Construction	:	Symmetrical design with triangular core Built-in shielding against static charges PEEK enclosure material (resistant to organic solvents, e.g., glycol ether)
Frequency	:	10 MHz to > 6 GHz Linearity: ± 0.2 dB (30 MHz to 6 GHz)
Directivity	:	+/-0.3 dB in HSL (rotation around probe axis) +/-0.5 dB in tissue material (rotation normal probe axis)
Dynamic Range	:	10uW/g to > 100 mW/g; Linearity +/-0.2 dB (noise: typically < 1uW/g)
Dimensions	:	Overall length: 337 mm (Tip: 20 mm) Tip diameter: 2.5mm (Body: 12 mm) Typical distance from probe tip to dipole centers: 1 mm
Application	:	Highprecision dosimetric measurement in any exposure scenario (e.g., very strong gradient fields). Only probe which enables compliance testing for frequencies up to 6GHz with precision of better 30%.
Manufacture	:	Schmid & Partner Engineering AG



EX3DV4 E-field Probe

c)Data Acquisition Electronic (DAE4)

Features	:	Signal amplifier, multiplexer, A/D converter and control logic Serial optical link for communication with DASY5 embedded system (fully remote controlled)
Measurement Range	:	Two step probe touch detector for mechanical surface detection and emergency robot stop -100 to +300 mV (16 bit resolution and two range settings: 4mV, 400mV)
Input Offset voltage	:	< 5 μ V (with auto zero)
Input Resistance	:	200 M Ω
Input Bias Current	:	< 50 fA
Battery Power	:	> 10 h of operation (with two 9.6 V NiMH accus)
Dimension	:	60 x 60 x 68 mm
Manufacture	:	Schmid & Partner Engineering AG

d)Electro-Optic Converter (EOC)

Version	:	EOC 61
Description	:	for TX60 robot arm, including proximity sensor
Manufacture	:	Schmid & Partner Engineering AG

e)DASY5 Measurement server

Features	:	Intel ULV Celeron 400MHz 128MB chip disk and 128MB RAM 16 Bit A/D converter for surface detection system Vacuum Fluorescent Display Robot Interface Serial link to DAE (with watchdog supervision) Door contact port (Possibility to connect a light curtain) Emergency stop port (to connect the remote control) Signal lamps port Light beam port Three Ethernet connection ports Two USB 2.0 Ports Two serial links Expansion port for future applications
Dimensions (L x W x H)	:	440 x 241 x 89 mm
Manufacture	:	Schmid & Partner Engineering AG

f) Light Beam Switches

Version	:	LB5
Dimensions (L x H)	:	110 x 80 mm
Thickness	:	12 mm
Beam-length	:	80 mm
Manufacture	:	Schmid & Partner Engineering AG

g)Software

Item	:	Dosimetric Assessment System DASY5
Type No.	:	SD 000 401A, SD 000 402A
Software version No.	:	DASY52, Version 52.6 (1)
Manufacture / Origin	:	Schmid & Partner Engineering AG

h)Robot Control Unit

Weight	:	70 Kg
AC Input Voltage	:	selectable
Manufacturer	:	Stäubli Robotics

i)Phantom and Device Holder

Phantom

Type	:	SAM Twin Phantom V4.0
Description	:	The shell corresponds to the specifications of the Specific Anthropomorphic Mannequin (SAM) phantom defined in IEEE 1528 and IEC 62209-1. It enables the dosimetric evaluation of left and right hand phone usage as well as body mounted usage at the flat phantom region. A cover prevents evaporation of the liquid. Reference markings on the phantom allow the complete setup of all predefined phantom positions and measurement grids by teaching three points with the robot.
Material	:	Vinylester, glass fiber reinforced (VE-GF)
Shell Material	:	Fiberglass
Thickness	:	2.0 +/-0.2 mm
Dimensions	:	Length: 1000 mm Width: 500 mm Height: adjustable feet
Volume	:	Approx. 25 liters
Manufacture	:	Schmid & Partner Engineering AG

Type	:	2mm Flat phantom ERI4.0
Description	:	Phantom for compliance testing of handheld and body-mounted wireless devices in the frequency range of 30 MHz to 6 GHz. ELI4 is fully compatible with the latest draft of the standard IEC 62209 Part II and all known tissue simulating liquids. ELI4 has been optimized regarding its performance and can be integrated into our standard phantom tables. A cover prevents evaporation of the liquid. Reference markings on the phantom allow installation of the complete setup, including all predefined phantom positions and measurement grids, by teaching three points. The phantom is supported by software version DASY4.5 and higher and is compatible with all SPEAG dosimetric probes and dipoles.
Material	:	Vinylester, glass fiber reinforced (VE-GF)
Shell Thickness	:	2.0 ± 0.2 mm (sagging: <1%)
Filling Volume	:	approx. 30 liters
Dimensions	:	Major ellipse axis: 600 mm Minor axis: 400 mm
Manufacture	:	Schmid & Partner Engineering AG

Device Holder

In combination with the Twin SAM Phantom V4.0/V4.0c or ELI4, the Mounting Device enables the rotation of the mounted transmitter device in spherical coordinates. Rotation point is the ear opening point. Transmitter devices can be easily and accurately positioned according to IEC, IEEE, FCC or other specifications. The device holder can be locked for positioning at different phantom sections (left head, right head, flat).

Material	:	POM
-----------------	---	-----

Laptio Extensions kit

Simple but effective and easy-to-use extension for Mounting Device that facilitates the testing of larger devices according to IEC 62209-2 (e.g., laptops, cameras, etc.). It is lightweight and fits easily on the upper part of the Mounting Device in place of the phone positioner. The extension is fully compatible with the Twin-SAM, ELI4 Phantoms.

Material	:	POM, Acrylic glass, Foam
-----------------	---	--------------------------

Urethane

For this measurement, the urethane foam was used as device holder.

j) Simulated Tissues (Liquid)

The following tissue formulations are provided for reference only as some of the parameters have not been thoroughly verified. The composition of ingredients may be modified accordingly to achieve the desired target tissue parameters required for routine SAR evaluation.

Mixture (%)	Frequency (MHz)									
	450		900		1800		1950		2450	
Tissue Type	Head	Body	Head	Body	Head	Body	Head	Body	Head	Body
Water	38.91	46.21	40.29	50.75	55.24	70.17	55.41	69.79	55.0	68.64
Sugar	56.93	51.17	57.90	48.21	-	-	-	-	-	-
Cellulose	0.25	0.18	0.24	0.00	-	-	-	-	-	-
Salt (NaCl)	3.79	2.34	1.38	0.94	0.31	0.39	0.08	0.2	-	-
Preventol	0.12	0.08	0.18	0.10	-	-	-	-	-	-
DGMBE	-	-	-	-	44.45	29.44	44.51	30.0	45.0	31.37
Dielectric Constant	43.42	58.0	42.54	56.1	42.0	56.8	39.9	54.0	39.8	52.5
Conductivity (S/m)	0.85	0.83	0.91	0.95	1.0	1.07	1.42	1.45	1.88	1.78

Note: DGMBE (Diethylenglycol-monobuthyl ether)

The simulated tissue (liquid) of 1800MHz was used for the test frequency of 1700MHz to 1800MHz.

Mixture (%)	Frequency (MHz)	
	650&750	1450
Tissue Type	Head and Body	Head and Body
Water	35-58%	52-75%
Sugar	40-60%	-
Cellulose	<0.3%	-
Salt (NaCl)	0-6%	<1%
Preventol	0.1-0.7%	-
DGMBE	-	25-48%

Mixture (%)	Frequency (MHz)	
	5800	
Tissue Type	Head	Body
Water	64.0	78.0
Mineral Oil	18.0	11.0
Emulsifiers	15.0	9.0
Additives and salt	3.0	2.0

System Check Dipole SAR Calibration Certificate -Dipole 2450MHz(D2450V2,S/N:713)

**Calibration Laboratory of
Schmid & Partner
Engineering AG**
Zeughausstrasse 43, 8004 Zurich, Switzerland



S Schweizerischer Kalibrierdienst
S Service suisse d'étalonnage
C Servizio svizzero di taratura
S Swiss Calibration Service

Accredited by the Swiss Accreditation Service (SAS)
The Swiss Accreditation Service is one of the signatories to the EA
Multilateral Agreement for the recognition of calibration certificates

Accreditation No.: **SCS 0108**

Client **UL Japan (Vitec)**

Certificate No: **D2450V2-713_Sep16**

CALIBRATION CERTIFICATE

Object: **D2450V2 - SN:713**

Calibration procedure(s): **QA CAL-05.v9
Calibration procedure for dipole validation kits above 700 MHz**

Calibration date: **September 13, 2016**

This calibration certificate documents the traceability to national standards, which realize the physical units of measurements (SI).
The measurements and the uncertainties with confidence probability are given on the following pages and are part of the certificate.

All calibrations have been conducted in the closed laboratory facility: environment temperature (22 ± 3)°C and humidity < 70%.

Calibration Equipment used (M&TE critical for calibration)

Primary Standards	ID #	Cal Date (Certificate No.)	Scheduled Calibration
Power meter NRP	SN: 104778	06-Apr-16 (No. 217-02288/02289)	Apr-17
Power sensor NRP-Z91	SN: 103244	06-Apr-16 (No. 217-02288)	Apr-17
Power sensor NRP-Z91	SN: 103245	06-Apr-16 (No. 217-02289)	Apr-17
Reference 20 dB Attenuator	SN: 5058 (20k)	05-Apr-16 (No. 217-02292)	Apr-17
Type-N mismatch combination	SN: 5047.2 / 06327	05-Apr-16 (No. 217-02295)	Apr-17
Reference Probe EX3DV4	SN: 7349	15-Jun-16 (No. EX3-7349_Jun16)	Jun-17
DAE4	SN: 601	30-Dec-15 (No. DAE4-601_Dec15)	Dec-16
Secondary Standards	ID #	Check Date (in house)	Scheduled Check
Power meter EPM-442A	SN: GB37480704	07-Oct-15 (No. 217-02222)	In house check: Oct-16
Power sensor HP 8481A	SN: US37292783	07-Oct-15 (No. 217-02222)	In house check: Oct-16
Power sensor HP 8481A	SN: MY41092317	07-Oct-15 (No. 217-02223)	In house check: Oct-16
RF generator R&S SMT-06	SN: 100972	15-Jun-15 (in house check Jun-15)	In house check: Oct-16
Network Analyzer HP 8753E	SN: US37380585	18-Oct-01 (in house check Oct-15)	In house check: Oct-16

Calibrated by:	Name: Jeton Kastrioti	Function: Laboratory Technician	Signature:
Approved by:	Name: Katja Pokovic	Function: Technical Manager	Signature:

Issued: September 13, 2016

This calibration certificate shall not be reproduced except in full without written approval of the laboratory.

Calibration Laboratory of
Schmid & Partner
Engineering AG
Zeughausstrasse 43, 8004 Zurich, Switzerland



S Schweizerischer Kalibrierdienst
C Service suisse d'étalonnage
S Servizio svizzero di taratura
S Swiss Calibration Service

Accredited by the Swiss Accreditation Service (SAS)
The Swiss Accreditation Service is one of the signatories to the EA
Multilateral Agreement for the recognition of calibration certificates

Accreditation No.: **SCS 0108**

Glossary:

TSL tissue simulating liquid
ConvF sensitivity in TSL / NORM x,y,z
N/A not applicable or not measured

Calibration is Performed According to the Following Standards:

- a) IEEE Std 1528-2013, "IEEE Recommended Practice for Determining the Peak Spatial-Averaged Specific Absorption Rate (SAR) in the Human Head from Wireless Communications Devices: Measurement Techniques", June 2013
- b) IEC 62209-1, "Procedure to measure the Specific Absorption Rate (SAR) for hand-held devices used in close proximity to the ear (frequency range of 300 MHz to 3 GHz)", February 2005
- c) IEC 62209-2, "Procedure to determine the Specific Absorption Rate (SAR) for wireless communication devices used in close proximity to the human body (frequency range of 30 MHz to 6 GHz)", March 2010
- d) KDB 865664, "SAR Measurement Requirements for 100 MHz to 6 GHz"

Additional Documentation:

- e) DASY4/5 System Handbook

Methods Applied and Interpretation of Parameters:

- *Measurement Conditions:* Further details are available from the Validation Report at the end of the certificate. All figures stated in the certificate are valid at the frequency indicated.
- *Antenna Parameters with TSL:* The dipole is mounted with the spacer to position its feed point exactly below the center marking of the flat phantom section, with the arms oriented parallel to the body axis.
- *Feed Point Impedance and Return Loss:* These parameters are measured with the dipole positioned under the liquid filled phantom. The impedance stated is transformed from the measurement at the SMA connector to the feed point. The Return Loss ensures low reflected power. No uncertainty required.
- *Electrical Delay:* One-way delay between the SMA connector and the antenna feed point. No uncertainty required.
- *SAR measured:* SAR measured at the stated antenna input power.
- *SAR normalized:* SAR as measured, normalized to an input power of 1 W at the antenna connector.
- *SAR for nominal TSL parameters:* The measured TSL parameters are used to calculate the nominal SAR result.

The reported uncertainty of measurement is stated as the standard uncertainty of measurement multiplied by the coverage factor k=2, which for a normal distribution corresponds to a coverage probability of approximately 95%.

Measurement Conditions

DASY system configuration, as far as not given on page 1.

DASY Version	DASY5	V52.8.8
Extrapolation	Advanced Extrapolation	
Phantom	Modular Flat Phantom	
Distance Dipole Center - TSL	10 mm	with Spacer
Zoom Scan Resolution	dx, dy, dz = 5 mm	
Frequency	2450 MHz ± 1 MHz	

Head TSL parameters

The following parameters and calculations were applied.

	Temperature	Permittivity	Conductivity
Nominal Head TSL parameters	22.0 °C	39.2	1.80 mho/m
Measured Head TSL parameters	(22.0 ± 0.2) °C	37.9 ± 6 %	1.88 mho/m ± 6 %
Head TSL temperature change during test	< 0.5 °C	----	----

SAR result with Head TSL

SAR averaged over 1 cm ³ (1 g) of Head TSL	Condition	
SAR measured	250 mW input power	13.4 W/kg
SAR for nominal Head TSL parameters	normalized to 1W	52.1 W/kg ± 17.0 % (k=2)

SAR averaged over 10 cm ³ (10 g) of Head TSL	condition	
SAR measured	250 mW input power	6.23 W/kg
SAR for nominal Head TSL parameters	normalized to 1W	24.5 W/kg ± 16.5 % (k=2)

Body TSL parameters

The following parameters and calculations were applied.

	Temperature	Permittivity	Conductivity
Nominal Body TSL parameters	22.0 °C	52.7	1.95 mho/m
Measured Body TSL parameters	(22.0 ± 0.2) °C	51.6 ± 6 %	2.04 mho/m ± 6 %
Body TSL temperature change during test	< 0.5 °C	----	----

SAR result with Body TSL

SAR averaged over 1 cm ³ (1 g) of Body TSL	Condition	
SAR measured	250 mW input power	13.0 W/kg
SAR for nominal Body TSL parameters	normalized to 1W	50.7 W/kg ± 17.0 % (k=2)

SAR averaged over 10 cm ³ (10 g) of Body TSL	condition	
SAR measured	250 mW input power	6.11 W/kg
SAR for nominal Body TSL parameters	normalized to 1W	24.1 W/kg ± 16.5 % (k=2)

Appendix (Additional assessments outside the scope of SCS 0108)

Antenna Parameters with Head TSL

Impedance, transformed to feed point	53.0 Ω + 2.3 $j\Omega$
Return Loss	- 28.8 dB

Antenna Parameters with Body TSL

Impedance, transformed to feed point	49.6 Ω + 3.7 $j\Omega$
Return Loss	- 28.5 dB

General Antenna Parameters and Design

Electrical Delay (one direction)	1.158 ns
----------------------------------	----------

After long term use with 100W radiated power, only a slight warming of the dipole near the feedpoint can be measured.

The dipole is made of standard semirigid coaxial cable. The center conductor of the feeding line is directly connected to the second arm of the dipole. The antenna is therefore short-circuited for DC-signals. On some of the dipoles, small end caps are added to the dipole arms in order to improve matching when loaded according to the position as explained in the "Measurement Conditions" paragraph. The SAR data are not affected by this change. The overall dipole length is still according to the Standard.

No excessive force must be applied to the dipole arms, because they might bend or the soldered connections near the feedpoint may be damaged.

Additional EUT Data

Manufactured by	SPEAG
Manufactured on	July 05, 2002

DASY5 Validation Report for Head TSL

Date: 13.09.2016

Test Laboratory: SPEAG, Zurich, Switzerland

DUT: Dipole 2450 MHz; Type: D2450V2; Serial: D2450V2 - SN:713

Communication System: UID 0 - CW; Frequency: 2450 MHz
Medium parameters used: $f = 2450$ MHz; $\sigma = 1.88$ S/m; $\epsilon_r = 37.9$; $\rho = 1000$ kg/m³
Phantom section: Flat Section
Measurement Standard: DASY5 (IEEE/IEC/ANSI C63.19-2011)

DASY52 Configuration:

- Probe: EX3DV4 - SN7349; ConvF(7.72, 7.72, 7.72); Calibrated: 15.06.2016;
- Sensor-Surface: 1.4mm (Mechanical Surface Detection)
- Electronics: DAE4 Sn601; Calibrated: 30.12.2015
- Phantom: Flat Phantom 5.0 (front); Type: QD000P50AA; Serial: 1001
- DASY52 52.8.8(1258); SEMCAD X 14.6.10(7372)

Dipole Calibration for Head Tissue/Pin=250 mW, d=10mm/Zoom Scan (7x7x7)/Cube 0:

Measurement grid: dx=5mm, dy=5mm, dz=5mm
Reference Value = 113.5 V/m; Power Drift = -0.01 dB
Peak SAR (extrapolated) = 26.7 W/kg
SAR(1 g) = 13.4 W/kg; SAR(10 g) = 6.23 W/kg
Maximum value of SAR (measured) = 21.9 W/kg

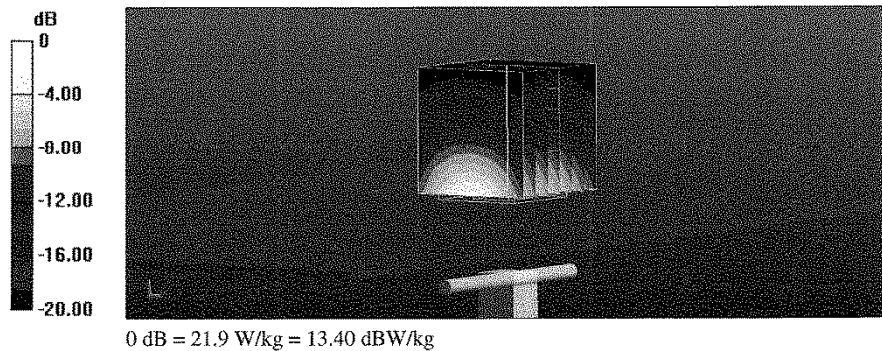

Impedance Measurement Plot for Head TSL

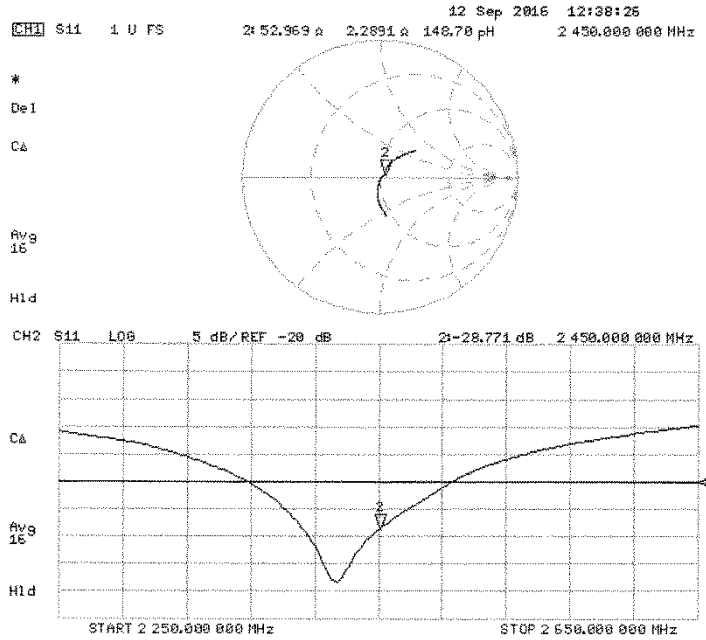

DASY5 Validation Report for Body TSL

Date: 13.09.2016

Test Laboratory: SPEAG, Zurich, Switzerland

DUT: Dipole 2450 MHz; Type: D2450V2; Serial: D2450V2 - SN:713

Communication System: UID 0 - CW; Frequency: 2450 MHz
Medium parameters used: $f = 2450$ MHz; $\sigma = 2.04$ S/m; $\epsilon_r = 51.6$; $\rho = 1000$ kg/m³
Phantom section: Flat Section
Measurement Standard: DASY5 (IEEE/IEC/ANSI C63.19-2011)

DASY52 Configuration:

- Probe: EX3DV4 - SN7349; ConvF(7.79, 7.79, 7.79); Calibrated: 15.06.2016;
- Sensor-Surface: 1.4mm (Mechanical Surface Detection)
- Electronics: DAE4 Sn601; Calibrated: 30.12.2015
- Phantom: Flat Phantom 5.0 (back); Type: QD000P50AA; Serial: 1002
- DASY52 52.8.8(1258); SEMCAD X 14.6.10(7372)

Dipole Calibration for Body Tissue/Pin=250 mW, d=10mm/Zoom Scan (7x7x7)/Cube 0:

Measurement grid: dx=5mm, dy=5mm, dz=5mm
Reference Value = 106.4 V/m; Power Drift = -0.03 dB
Peak SAR (extrapolated) = 25.5 W/kg
SAR(1 g) = 13 W/kg; SAR(10 g) = 6.11 W/kg
Maximum value of SAR (measured) = 21.2 W/kg

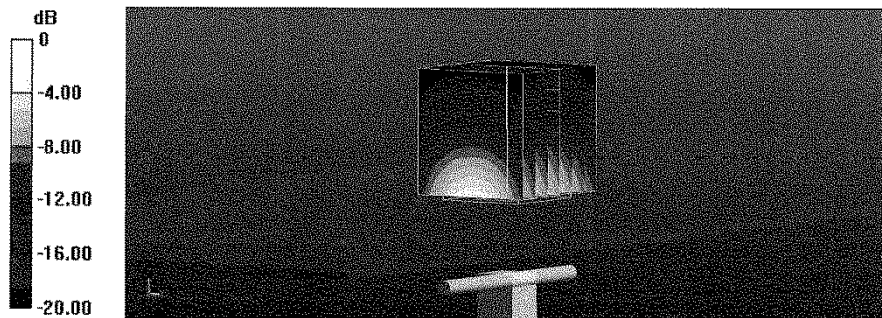

0 dB = 21.2 W/kg = 13.26 dBW/kg

Impedance Measurement Plot for Body TSL

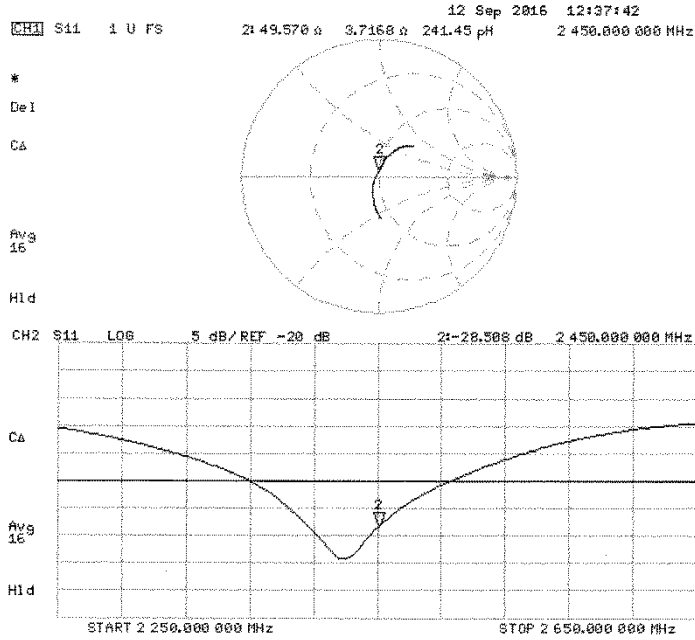

System Check Dipole SAR Calibration Certificate -Dipole 5GHz(D5GHzV2,S/N:1020)

**Calibration Laboratory of
Schmid & Partner
Engineering AG**
Zeughausstrasse 43, 8004 Zurich, Switzerland



S Schweizerischer Kalibrierdienst
S Service suisse d'étalonnage
S Servizio svizzero di taratura
S Swiss Calibration Service

Accredited by the Swiss Accreditation Service (SAS)
The Swiss Accreditation Service is one of the signatories to the EA
Multilateral Agreement for the recognition of calibration certificates

Accreditation No.: SCS 0108

Client **UL Japan HQ (Vitec)**

Certificate No: **D5GHzV2-1020_Jan16**

CALIBRATION CERTIFICATE																																															
Object	D5GHzV2 - SN: 1020																																														
Calibration procedure(s)	QA CAL-22.v2 Calibration procedure for dipole validation kits between 3-6 GHz																																														
Calibration date:	January 20, 2016																																														
<p>This calibration certificate documents the traceability to national standards, which realize the physical units of measurements (SI). The measurements and the uncertainties with confidence probability are given on the following pages and are part of the certificate.</p> <p>All calibrations have been conducted in the closed laboratory facility: environment temperature (22 ± 3)°C and humidity < 70%.</p> <p>Calibration Equipment used (M&TE critical for calibration)</p> <table border="1"> <thead> <tr> <th>Primary Standards</th> <th>ID #</th> <th>Cal Date (Certificate No.)</th> <th>Scheduled Calibration</th> </tr> </thead> <tbody> <tr> <td>Power meter EPM-442A</td> <td>GB37480704</td> <td>07-Oct-15 (No. 217-02222)</td> <td>Oct-16</td> </tr> <tr> <td>Power sensor HP 8481A</td> <td>US37292783</td> <td>07-Oct-15 (No. 217-02222)</td> <td>Oct-16</td> </tr> <tr> <td>Power sensor HP 8481A</td> <td>MY41092317</td> <td>07-Oct-15 (No. 217-02223)</td> <td>Oct-16</td> </tr> <tr> <td>Reference 20 dB Attenuator</td> <td>SN: 5058 (20k)</td> <td>01-Apr-15 (No. 217-02131)</td> <td>Mar-16</td> </tr> <tr> <td>Type-N mismatch combination</td> <td>SN: 5047.2 / 06327</td> <td>01-Apr-15 (No. 217-02134)</td> <td>Mar-16</td> </tr> <tr> <td>Reference Probe EX3DV4</td> <td>SN: 3503</td> <td>31-Dec-15 (No. EX3-3503_Dec15)</td> <td>Dec-16</td> </tr> <tr> <td>DAE4</td> <td>SN: 601</td> <td>30-Dec-15 (No. DAE4-601_Dec15)</td> <td>Dec-16</td> </tr> </tbody> </table> <table border="1"> <thead> <tr> <th>Secondary Standards</th> <th>ID #</th> <th>Check Date (in house)</th> <th>Scheduled Check</th> </tr> </thead> <tbody> <tr> <td>RF generator R&S SMT-06</td> <td>100972</td> <td>15-Jun-15 (in house check Jun-15)</td> <td>In house check: Jun-18</td> </tr> <tr> <td>Network Analyzer HP 8753E</td> <td>US37390585 S4206</td> <td>18-Oct-01 (in house check Oct-15)</td> <td>In house check: Oct-16</td> </tr> </tbody> </table>				Primary Standards	ID #	Cal Date (Certificate No.)	Scheduled Calibration	Power meter EPM-442A	GB37480704	07-Oct-15 (No. 217-02222)	Oct-16	Power sensor HP 8481A	US37292783	07-Oct-15 (No. 217-02222)	Oct-16	Power sensor HP 8481A	MY41092317	07-Oct-15 (No. 217-02223)	Oct-16	Reference 20 dB Attenuator	SN: 5058 (20k)	01-Apr-15 (No. 217-02131)	Mar-16	Type-N mismatch combination	SN: 5047.2 / 06327	01-Apr-15 (No. 217-02134)	Mar-16	Reference Probe EX3DV4	SN: 3503	31-Dec-15 (No. EX3-3503_Dec15)	Dec-16	DAE4	SN: 601	30-Dec-15 (No. DAE4-601_Dec15)	Dec-16	Secondary Standards	ID #	Check Date (in house)	Scheduled Check	RF generator R&S SMT-06	100972	15-Jun-15 (in house check Jun-15)	In house check: Jun-18	Network Analyzer HP 8753E	US37390585 S4206	18-Oct-01 (in house check Oct-15)	In house check: Oct-16
Primary Standards	ID #	Cal Date (Certificate No.)	Scheduled Calibration																																												
Power meter EPM-442A	GB37480704	07-Oct-15 (No. 217-02222)	Oct-16																																												
Power sensor HP 8481A	US37292783	07-Oct-15 (No. 217-02222)	Oct-16																																												
Power sensor HP 8481A	MY41092317	07-Oct-15 (No. 217-02223)	Oct-16																																												
Reference 20 dB Attenuator	SN: 5058 (20k)	01-Apr-15 (No. 217-02131)	Mar-16																																												
Type-N mismatch combination	SN: 5047.2 / 06327	01-Apr-15 (No. 217-02134)	Mar-16																																												
Reference Probe EX3DV4	SN: 3503	31-Dec-15 (No. EX3-3503_Dec15)	Dec-16																																												
DAE4	SN: 601	30-Dec-15 (No. DAE4-601_Dec15)	Dec-16																																												
Secondary Standards	ID #	Check Date (in house)	Scheduled Check																																												
RF generator R&S SMT-06	100972	15-Jun-15 (in house check Jun-15)	In house check: Jun-18																																												
Network Analyzer HP 8753E	US37390585 S4206	18-Oct-01 (in house check Oct-15)	In house check: Oct-16																																												
Calibrated by:	Name Jeton Kastrati	Function Laboratory Technician	Signature 																																												
Approved by:	Name Katja Pokovic	Function Technical Manager	Signature 																																												
			Issued: January 20, 2016																																												
This calibration certificate shall not be reproduced except in full without written approval of the laboratory.																																															

Calibration Laboratory of
Schmid & Partner
Engineering AG
Zeughausstrasse 43, 8004 Zurich, Switzerland



S Schweizerischer Kalibrierdienst
C Service suisse d'étalonnage
S Servizio svizzero di taratura
S Swiss Calibration Service

Accredited by the Swiss Accreditation Service (SAS)
The Swiss Accreditation Service is one of the signatories to the EA
Multilateral Agreement for the recognition of calibration certificates

Accreditation No.: SCS 0108

Glossary:

TSL tissue simulating liquid
ConvF sensitivity in TSL / NORM x,y,z
N/A not applicable or not measured

Calibration is Performed According to the Following Standards:

- IEEE Std 1528-2013, "IEEE Recommended Practice for Determining the Peak Spatial-Averaged Specific Absorption Rate (SAR) in the Human Head from Wireless Communications Devices: Measurement Techniques", June 2013
- IEC 62209-2, "Procedure to determine the Specific Absorption Rate (SAR) for wireless communication devices used in close proximity to the human body (frequency range of 30 MHz to 6 GHz)", March 2010
- KDB 865664, "SAR Measurement Requirements for 100 MHz to 6 GHz"

Additional Documentation:

- DASY4/5 System Handbook

Methods Applied and Interpretation of Parameters:

- Measurement Conditions:** Further details are available from the Validation Report at the end of the certificate. All figures stated in the certificate are valid at the frequency indicated.
- Antenna Parameters with TSL:** The dipole is mounted with the spacer to position its feed point exactly below the center marking of the flat phantom section, with the arms oriented parallel to the body axis.
- Feed Point Impedance and Return Loss:** These parameters are measured with the dipole positioned under the liquid filled phantom. The impedance stated is transformed from the measurement at the SMA connector to the feed point. The Return Loss ensures low reflected power. No uncertainty required.
- Electrical Delay:** One-way delay between the SMA connector and the antenna feed point. No uncertainty required.
- SAR measured:** SAR measured at the stated antenna input power.
- SAR normalized:** SAR as measured, normalized to an input power of 1 W at the antenna connector.
- SAR for nominal TSL parameters:** The measured TSL parameters are used to calculate the nominal SAR result.

The reported uncertainty of measurement is stated as the standard uncertainty of measurement multiplied by the coverage factor $k=2$, which for a normal distribution corresponds to a coverage probability of approximately 95%.

Measurement Conditions

DASY system configuration, as far as not given on page 1.

DASY Version	DASY5	V52.8.8
Extrapolation	Advanced Extrapolation	
Phantom	Modular Flat Phantom V5.0	
Distance Dipole Center - TSL	10 mm	with Spacer
Zoom Scan Resolution	dx, dy = 4.0 mm, dz = 1.4 mm	Graded Ratio = 1.4 (Z direction)
Frequency	5200 MHz ± 1 MHz 5250 MHz ± 1 MHz 5300 MHz ± 1 MHz 5500 MHz ± 1 MHz 5600 MHz ± 1 MHz 5750 MHz ± 1 MHz 5800 MHz ± 1 MHz	

Head TSL parameters at 5200 MHz

The following parameters and calculations were applied.

	Temperature	Permittivity	Conductivity
Nominal Head TSL parameters	22.0 °C	36.0	4.66 mho/m
Measured Head TSL parameters	(22.0 ± 0.2) °C	35.2 ± 6 %	4.51 mho/m ± 6 %
Head TSL temperature change during test	< 0.5 °C	---	---

SAR result with Head TSL at 5200 MHz

SAR averaged over 1 cm ³ (1 g) of Head TSL	Condition	
SAR measured	100 mW input power	7.79 W/kg
SAR for nominal Head TSL parameters	normalized to 1W	77.5 W/kg ± 19.9 % (k=2)

SAR averaged over 10 cm ³ (10 g) of Head TSL	condition	
SAR measured	100 mW input power	2.25 W/kg
SAR for nominal Head TSL parameters	normalized to 1W	22.3 W/kg ± 19.5 % (k=2)

Head TSL parameters at 5250 MHz

The following parameters and calculations were applied.

	Temperature	Permittivity	Conductivity
Nominal Head TSL parameters	22.0 °C	35.9	4.71 mho/m
Measured Head TSL parameters	(22.0 ± 0.2) °C	35.2 ± 6 %	4.55 mho/m ± 6 %
Head TSL temperature change during test	< 0.5 °C	---	---

SAR result with Head TSL at 5250 MHz

SAR averaged over 1 cm ³ (1 g) of Head TSL	Condition	
SAR measured	100 mW input power	8.00 W/kg
SAR for nominal Head TSL parameters	normalized to 1W	79.6 W/kg ± 19.9 % (k=2)

SAR averaged over 10 cm ³ (10 g) of Head TSL	condition	
SAR measured	100 mW input power	2.31 W/kg
SAR for nominal Head TSL parameters	normalized to 1W	22.9 W/kg ± 19.5 % (k=2)

Head TSL parameters at 5300 MHz

The following parameters and calculations were applied.

	Temperature	Permittivity	Conductivity
Nominal Head TSL parameters	22.0 °C	35.9	4.76 mho/m
Measured Head TSL parameters	(22.0 ± 0.2) °C	35.1 ± 6 %	4.60 mho/m ± 6 %
Head TSL temperature change during test	< 0.5 °C	---	---

SAR result with Head TSL at 5300 MHz

SAR averaged over 1 cm ³ (1 g) of Head TSL	Condition	
SAR measured	100 mW input power	8.28 W/kg
SAR for nominal Head TSL parameters	normalized to 1W	82.3 W/kg ± 19.9 % (k=2)

SAR averaged over 10 cm ³ (10 g) of Head TSL	condition	
SAR measured	100 mW input power	2.39 W/kg
SAR for nominal Head TSL parameters	normalized to 1W	23.7 W/kg ± 19.5 % (k=2)

Head TSL parameters at 5500 MHz

The following parameters and calculations were applied.

	Temperature	Permittivity	Conductivity
Nominal Head TSL parameters	22.0 °C	35.6	4.96 mho/m
Measured Head TSL parameters	(22.0 ± 0.2) °C	34.8 ± 6 %	4.79 mho/m ± 6 %
Head TSL temperature change during test	< 0.5 °C	---	---

SAR result with Head TSL at 5500 MHz

SAR averaged over 1 cm ³ (1 g) of Head TSL	Condition	
SAR measured	100 mW input power	8.10 W/kg
SAR for nominal Head TSL parameters	normalized to 1W	80.5 W/kg ± 19.9 % (k=2)

SAR averaged over 10 cm ³ (10 g) of Head TSL	condition	
SAR measured	100 mW input power	2.32 W/kg
SAR for nominal Head TSL parameters	normalized to 1W	23.0 W/kg ± 19.5 % (k=2)

Head TSL parameters at 5600 MHz

The following parameters and calculations were applied.

	Temperature	Permittivity	Conductivity
Nominal Head TSL parameters	22.0 °C	35.5	5.07 mho/m
Measured Head TSL parameters	(22.0 ± 0.2) °C	34.7 ± 6 %	4.90 mho/m ± 6 %
Head TSL temperature change during test	< 0.5 °C	---	---

SAR result with Head TSL at 5600 MHz

SAR averaged over 1 cm ³ (1 g) of Head TSL	Condition	
SAR measured	100 mW input power	8.42 W/kg
SAR for nominal Head TSL parameters	normalized to 1W	83.7 W/kg ± 19.9 % (k=2)

SAR averaged over 10 cm ³ (10 g) of Head TSL	condition	
SAR measured	100 mW input power	2.43 W/kg
SAR for nominal Head TSL parameters	normalized to 1W	24.1 W/kg ± 19.5 % (k=2)

Head TSL parameters at 5750 MHz

The following parameters and calculations were applied.

	Temperature	Permittivity	Conductivity
Nominal Head TSL parameters	22.0 °C	35.4	5.22 mho/m
Measured Head TSL parameters	(22.0 ± 0.2) °C	34.5 ± 6 %	5.05 mho/m ± 6 %
Head TSL temperature change during test	< 0.5 °C	---	---

SAR result with Head TSL at 5750 MHz

SAR averaged over 1 cm ³ (1 g) of Head TSL	Condition	
SAR measured	100 mW input power	7.96 W/kg
SAR for nominal Head TSL parameters	normalized to 1W	79.1 W/kg ± 19.9 % (k=2)

SAR averaged over 10 cm ³ (10 g) of Head TSL	condition	
SAR measured	100 mW input power	2.28 W/kg
SAR for nominal Head TSL parameters	normalized to 1W	22.6 W/kg ± 19.5 % (k=2)

Head TSL parameters at 5800 MHz

The following parameters and calculations were applied.

	Temperature	Permittivity	Conductivity
Nominal Head TSL parameters	22.0 °C	35.3	5.27 mho/m
Measured Head TSL parameters	(22.0 ± 0.2) °C	34.4 ± 6 %	5.10 mho/m ± 6 %
Head TSL temperature change during test	< 0.5 °C	---	---

SAR result with Head TSL at 5800 MHz

SAR averaged over 1 cm ³ (1 g) of Head TSL	Condition	
SAR measured	100 mW input power	7.99 W/kg
SAR for nominal Head TSL parameters	normalized to 1W	79.4 W/kg ± 19.9 % (k=2)

SAR averaged over 10 cm ³ (10 g) of Head TSL	condition	
SAR measured	100 mW input power	2.29 W/kg
SAR for nominal Head TSL parameters	normalized to 1W	22.7 W/kg ± 19.5 % (k=2)

Body TSL parameters at 5250 MHz

The following parameters and calculations were applied.

	Temperature	Permittivity	Conductivity
Nominal Body TSL parameters	22.0 °C	48.9	5.36 mho/m
Measured Body TSL parameters	(22.0 ± 0.2) °C	47.0 ± 6 %	5.44 mho/m ± 6 %
Body TSL temperature change during test	< 0.5 °C	---	----

SAR result with Body TSL at 5250 MHz

SAR averaged over 1 cm ³ (1 g) of Body TSL	Condition	
SAR measured	100 mW input power	7.36 W/kg
SAR for nominal Body TSL parameters	normalized to 1W	73.0 W/kg ± 19.9 % (k=2)

SAR averaged over 10 cm ³ (10 g) of Body TSL	condition	
SAR measured	100 mW input power	2.09 W/kg
SAR for nominal Body TSL parameters	normalized to 1W	20.7 W/kg ± 19.5 % (k=2)

Body TSL parameters at 5600 MHz

The following parameters and calculations were applied.

	Temperature	Permittivity	Conductivity
Nominal Body TSL parameters	22.0 °C	48.5	5.77 mho/m
Measured Body TSL parameters	(22.0 ± 0.2) °C	46.4 ± 6 %	5.91 mho/m ± 6 %
Body TSL temperature change during test	< 0.5 °C	---	----

SAR result with Body TSL at 5600 MHz

SAR averaged over 1 cm ³ (1 g) of Body TSL	Condition	
SAR measured	100 mW input power	7.82 W/kg
SAR for nominal Body TSL parameters	normalized to 1W	77.6 W/kg ± 19.9 % (k=2)

SAR averaged over 10 cm ³ (10 g) of Body TSL	condition	
SAR measured	100 mW input power	2.21 W/kg
SAR for nominal Body TSL parameters	normalized to 1W	21.9 W/kg ± 19.5 % (k=2)

Body TSL parameters at 5750 MHz

The following parameters and calculations were applied.

	Temperature	Permittivity	Conductivity
Nominal Body TSL parameters	22.0 °C	48.3	5.94 mho/m
Measured Body TSL parameters	(22.0 ± 0.2) °C	46.1 ± 6 %	6.12 mho/m ± 6 %
Body TSL temperature change during test	< 0.5 °C	---	---

SAR result with Body TSL at 5750 MHz

SAR averaged over 1 cm ³ (1 g) of Body TSL	Condition	
SAR measured	100 mW input power	7.39 W/kg
SAR for nominal Body TSL parameters	normalized to 1W	73.3 W/kg ± 19.9 % (k=2)

SAR averaged over 10 cm ³ (10 g) of Body TSL	condition	
SAR measured	100 mW input power	2.07 W/kg
SAR for nominal Body TSL parameters	normalized to 1W	20.5 W/kg ± 19.5 % (k=2)

Appendix (Additional assessments outside the scope of SCS 0108)

Antenna Parameters with Head TSL at 5200 MHz

Impedance, transformed to feed point	49.4 Ω - 9.7 j Ω
Return Loss	- 20.2 dB

Antenna Parameters with Head TSL at 5250 MHz

Impedance, transformed to feed point	49.4 Ω - 5.7 j Ω
Return Loss	- 24.7 dB

Antenna Parameters with Head TSL at 5300 MHz

Impedance, transformed to feed point	51.7 Ω - 3.6 j Ω
Return Loss	- 28.3 dB

Antenna Parameters with Head TSL at 5500 MHz

Impedance, transformed to feed point	49.2 Ω - 1.5 j Ω
Return Loss	- 35.0 dB

Antenna Parameters with Head TSL at 5600 MHz

Impedance, transformed to feed point	54.8 Ω - 3.3 j Ω
Return Loss	- 25.1 dB

Antenna Parameters with Head TSL at 5750 MHz

Impedance, transformed to feed point	57.5 Ω + 0.3 j Ω
Return Loss	- 23.1 dB

Antenna Parameters with Head TSL at 5800 MHz

Impedance, transformed to feed point	56.0 Ω + 0.1 j Ω
Return Loss	- 25.0 dB

Antenna Parameters with Body TSL at 5250 MHz

Impedance, transformed to feed point	51.8 Ω - 5.2 $\mu\Omega$
Return Loss	- 25.4 dB

Antenna Parameters with Body TSL at 5600 MHz

Impedance, transformed to feed point	54.4 Ω - 1.6 $\mu\Omega$
Return Loss	- 26.9 dB

Antenna Parameters with Body TSL at 5750 MHz

Impedance, transformed to feed point	58.8 Ω + 0.9 $\mu\Omega$
Return Loss	- 21.8 dB

General Antenna Parameters and Design

Electrical Delay (one direction)	1.199 ns
----------------------------------	----------

After long term use with 100W radiated power, only a slight warming of the dipole near the feedpoint can be measured.

The dipole is made of standard semirigid coaxial cable. The center conductor of the feeding line is directly connected to the second arm of the dipole. The antenna is therefore short-circuited for DC-signals. On some of the dipoles, small end caps are added to the dipole arms in order to improve matching when loaded according to the position as explained in the "Measurement Conditions" paragraph. The SAR data are not affected by this change. The overall dipole length is still according to the Standard.

No excessive force must be applied to the dipole arms, because they might bend or the soldered connections near the feedpoint may be damaged.

Additional EUT Data

Manufactured by	SPEAG
Manufactured on	February 05, 2004

DASY5 Validation Report for Head TSL

Date: 20.01.2016

Test Laboratory: SPEAG, Zurich, Switzerland

DUT: Dipole D5GHzV2; Type: D5GHzV2; Serial: D5GHzV2 - SN: 1020

Communication System: UID 0 - CW; Frequency: 5200 MHz, Frequency: 5250 MHz, Frequency: 5300 MHz, Frequency: 5500 MHz, Frequency: 5600 MHz, Frequency: 5750 MHz, Frequency: 5800 MHz
Medium parameters used: $f = 5200$ MHz; $\sigma = 4.51$ S/m; $\epsilon_r = 35.2$; $\rho = 1000$ kg/m³, Medium parameters used: $f = 5250$ MHz; $\sigma = 4.55$ S/m; $\epsilon_r = 35.2$; $\rho = 1000$ kg/m³, Medium parameters used: $f = 5300$ MHz; $\sigma = 4.6$ S/m; $\epsilon_r = 35.1$; $\rho = 1000$ kg/m³, Medium parameters used: $f = 5500$ MHz; $\sigma = 4.79$ S/m; $\epsilon_r = 34.8$; $\rho = 1000$ kg/m³, Medium parameters used: $f = 5600$ MHz; $\sigma = 4.9$ S/m; $\epsilon_r = 34.7$; $\rho = 1000$ kg/m³, Medium parameters used: $f = 5750$ MHz; $\sigma = 5.05$ S/m; $\epsilon_r = 34.5$; $\rho = 1000$ kg/m³, Medium parameters used: $f = 5800$ MHz; $\sigma = 5.1$ S/m; $\epsilon_r = 34.4$; $\rho = 1000$ kg/m³
Phantom section: Flat Section
Measurement Standard: DASY5 (IEEE/IEC/ANSI C63.19-2011)

DASY52 Configuration:

- Probe: EX3DV4 - SN3503; ConvF(5.59, 5.59, 5.59); Calibrated: 31.12.2015, ConvF(5.53, 5.53, 5.53); Calibrated: 31.12.2015, ConvF(5.25, 5.25, 5.25); Calibrated: 31.12.2015, ConvF(5.18, 5.18, 5.18); Calibrated: 31.12.2015, ConvF(4.99, 4.99, 4.99); Calibrated: 31.12.2015, ConvF(4.95, 4.95, 4.95); Calibrated: 31.12.2015, ConvF(4.95, 4.95, 4.95); Calibrated: 31.12.2015;
- Sensor-Surface: 1.4mm (Mechanical Surface Detection)
- Electronics: DAE4 Sn601; Calibrated: 30.12.2015
- Phantom: Flat Phantom 5.0 (front); Type: QD000P50AA; Serial: 1001
- DASY52 52.8.8(1258); SEMCAD X 14.6.10(7372)

Dipole Calibration for Head Tissue 2/Pin=100mW, dist=10mm, f=5200 MHz/Zoom Scan, dist=1.4mm (8x8x7)/Cube 0: Measurement grid: dx=4mm, dy=4mm, dz=1.4mm
Reference Value = 72.07 V/m; Power Drift = 0.01 dB
Peak SAR (extrapolated) = 28.1 W/kg
SAR(1 g) = 7.79 W/kg; SAR(10 g) = 2.25 W/kg
Maximum value of SAR (measured) = 18.2 W/kg

Dipole Calibration for Head Tissue 2/Pin=100mW, dist=10mm, f=5250 MHz/Zoom Scan, dist=1.4mm (8x8x7)/Cube 0: Measurement grid: dx=4mm, dy=4mm, dz=1.4mm
Reference Value = 72.72 V/m; Power Drift = 0.06 dB
Peak SAR (extrapolated) = 29.2 W/kg
SAR(1 g) = 8 W/kg; SAR(10 g) = 2.31 W/kg
Maximum value of SAR (measured) = 18.7 W/kg

Dipole Calibration for Head Tissue 2/Pin=100mW, dist=10mm, f=5300 MHz/Zoom Scan, dist=1.4mm (8x8x7)/Cube 0: Measurement grid: dx=4mm, dy=4mm, dz=1.4mm
Reference Value = 73.60 V/m; Power Drift = 0.09 dB
Peak SAR (extrapolated) = 31.2 W/kg
SAR(1 g) = 8.28 W/kg; SAR(10 g) = 2.39 W/kg
Maximum value of SAR (measured) = 19.6 W/kg

Dipole Calibration for Head Tissue 2/Pin=100mW, dist=10mm, f=5500 MHz/Zoom Scan, dist=1.4mm
(8x8x7)/Cube 0: Measurement grid: dx=4mm, dy=4mm, dz=1.4mm
Reference Value = 72.02 V/m; Power Drift = 0.06 dB
Peak SAR (extrapolated) = 32.0 W/kg
SAR(1 g) = 8.1 W/kg; SAR(10 g) = 2.32 W/kg
Maximum value of SAR (measured) = 19.7 W/kg

Dipole Calibration for Head Tissue 2/Pin=100mW, dist=10mm, f=5600 MHz/Zoom Scan, dist=1.4mm
(8x8x7)/Cube 0: Measurement grid: dx=4mm, dy=4mm, dz=1.4mm
Reference Value = 72.66 V/m; Power Drift = 0.02 dB
Peak SAR (extrapolated) = 32.9 W/kg
SAR(1 g) = 8.42 W/kg; SAR(10 g) = 2.43 W/kg
Maximum value of SAR (measured) = 20.5 W/kg

Dipole Calibration for Head Tissue 2/Pin=100mW, dist=10mm, f=5750 MHz/Zoom Scan, dist=1.4mm
(8x8x7)/Cube 0: Measurement grid: dx=4mm, dy=4mm, dz=1.4mm
Reference Value = 70.61 V/m; Power Drift = 0.05 dB
Peak SAR (extrapolated) = 32.4 W/kg
SAR(1 g) = 7.96 W/kg; SAR(10 g) = 2.28 W/kg
Maximum value of SAR (measured) = 19.5 W/kg

Dipole Calibration for Head Tissue 2/Pin=100mW, dist=10mm, f=5800 MHz/Zoom Scan, dist=1.4mm
(8x8x7)/Cube 0: Measurement grid: dx=4mm, dy=4mm, dz=1.4mm
Reference Value = 70.21 V/m; Power Drift = 0.07 dB
Peak SAR (extrapolated) = 32.7 W/kg
SAR(1 g) = 7.99 W/kg; SAR(10 g) = 2.29 W/kg
Maximum value of SAR (measured) = 19.8 W/kg

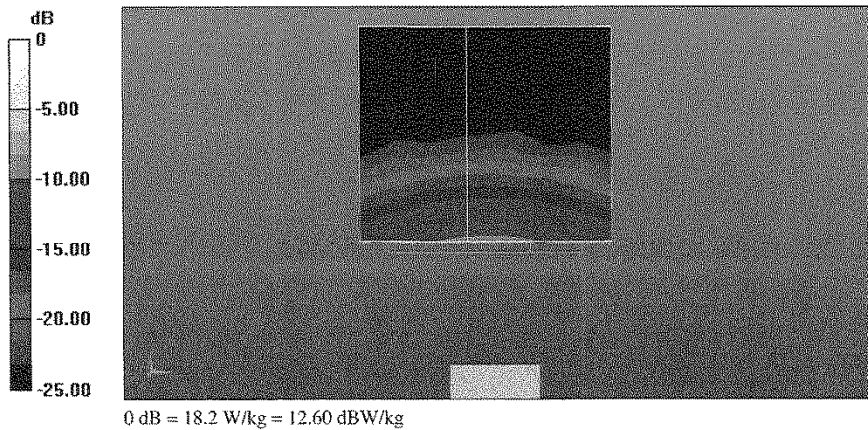

Impedance Measurement Plot for Head TSL (5200, 5300, 5600, 5800)

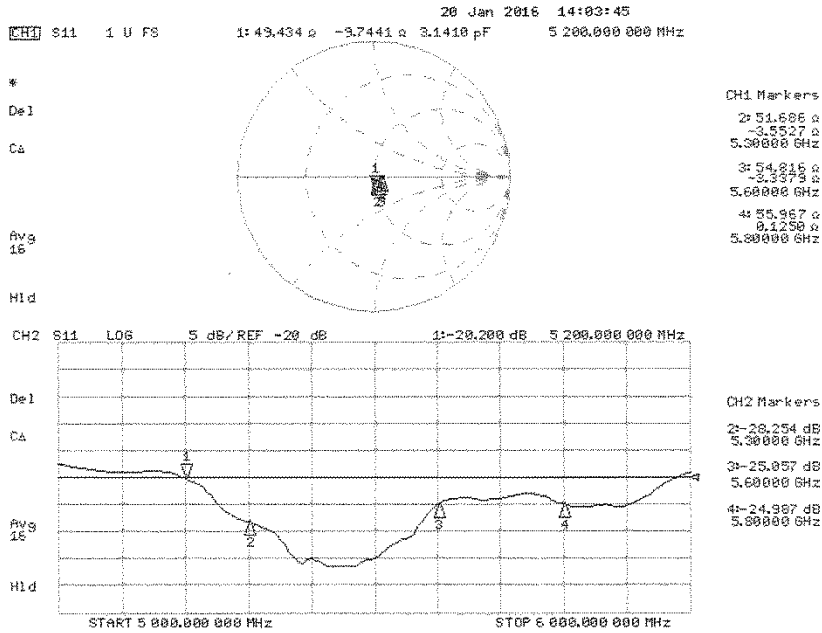

Impedance Measurement Plot for Head TSL (5250, 5500, 5750)

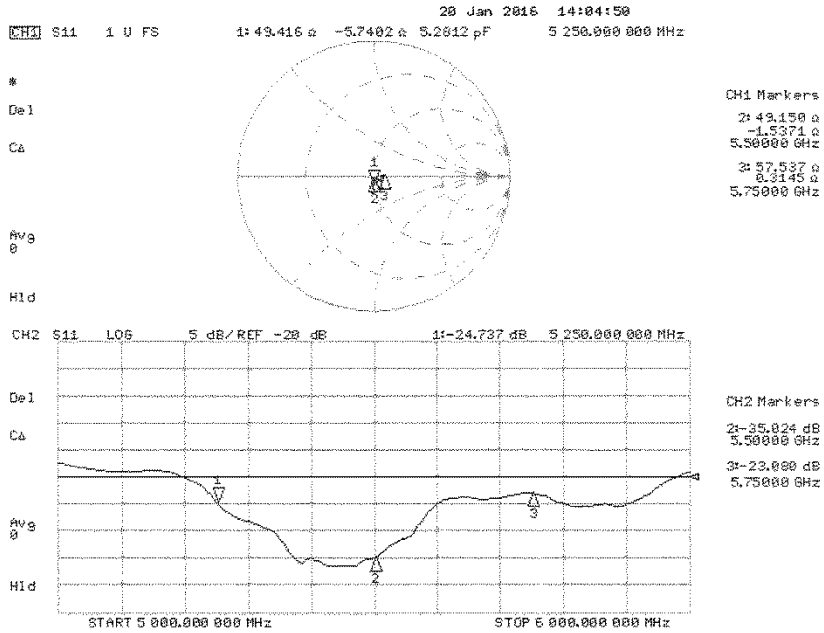

DASY5 Validation Report for Body TSL

Date: 13.01.2016

Test Laboratory: SPEAG, Zurich, Switzerland

DUT: Dipole 5GHz; Type: D5GHzV2; Serial: D5GHzV2 - SN: 1020

Communication System: UID 0 - CW; Frequency: 5250 MHz, Frequency: 5600 MHz, Frequency: 5750 MHz
Medium parameters used: $f = 5250$ MHz; $\sigma = 5.44$ S/m; $\epsilon_r = 47$; $\rho = 1000$ kg/m³, Medium parameters used: $f = 5600$ MHz; $\sigma = 5.91$ S/m; $\epsilon_r = 46.4$; $\rho = 1000$ kg/m³, Medium parameters used: $f = 5750$ MHz; $\sigma = 6.12$ S/m; $\epsilon_r = 46.1$; $\rho = 1000$ kg/m³

Phantom section: Flat Section

Measurement Standard: DASY5 (IEEE/IEC/ANSI C63.19-2011)

DASY52 Configuration:

- Probe: EX3DV4 - SN3503; ConvF(4.85, 4.85, 4.85); Calibrated: 31.12.2015, ConvF(4.35, 4.35, 4.35); Calibrated: 31.12.2015, ConvF(4.3, 4.3, 4.3); Calibrated: 31.12.2015;
- Sensor-Surface: 1.4mm (Mechanical Surface Detection)
- Electronics: DAE4 Sn601; Calibrated: 30.12.2015
- Phantom: Flat Phantom 5.0 (back); Type: QD000P50AA; Serial: 1002
- DASY52 52.8.8(1258); SEMCAD X 14.6.10(7372)

Dipole Calibration for Body Tissue/Pin=100mW, dist=10mm, f=5250 MHz/Zoom Scan, dist=1.4mm (8x8x7)/Cube 0: Measurement grid: dx=4mm, dy=4mm, dz=1.4mm

Reference Value = 66.83 V/m; Power Drift = -0.04 dB

Peak SAR (extrapolated) = 27.5 W/kg

SAR(1 g) = 7.36 W/kg; SAR(10 g) = 2.09 W/kg

Maximum value of SAR (measured) = 17.4 W/kg

Dipole Calibration for Body Tissue/Pin=100mW, dist=10mm, f=5600 MHz/Zoom Scan, dist=1.4mm (8x8x7)/Cube 0: Measurement grid: dx=4mm, dy=4mm, dz=1.4mm

Reference Value = 67.07 V/m; Power Drift = -0.01 dB

Peak SAR (extrapolated) = 31.9 W/kg

SAR(1 g) = 7.82 W/kg; SAR(10 g) = 2.21 W/kg

Maximum value of SAR (measured) = 19.1 W/kg

Dipole Calibration for Body Tissue/Pin=100mW, dist=10mm, f=5750 MHz/Zoom Scan, dist=1.4mm (8x8x7)/Cube 0: Measurement grid: dx=4mm, dy=4mm, dz=1.4mm

Reference Value = 64.16 V/m; Power Drift = 0.01 dB

Peak SAR (extrapolated) = 31.5 W/kg

SAR(1 g) = 7.39 W/kg; SAR(10 g) = 2.07 W/kg

Maximum value of SAR (measured) = 18.3 W/kg

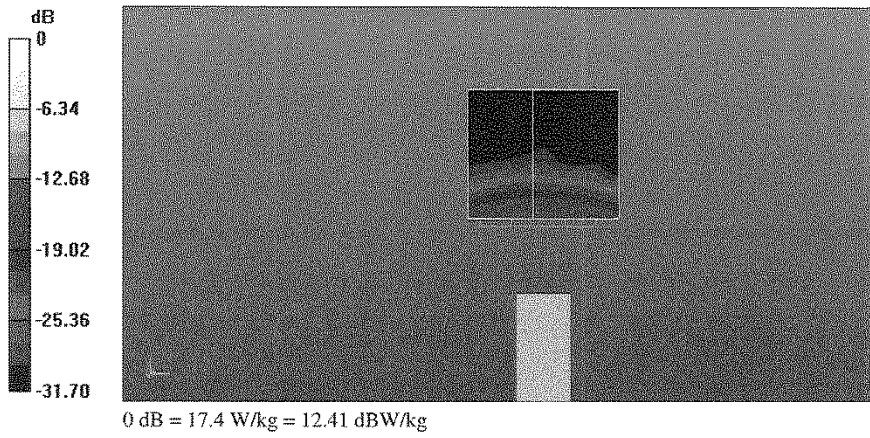

Impedance Measurement Plot for Body TSL

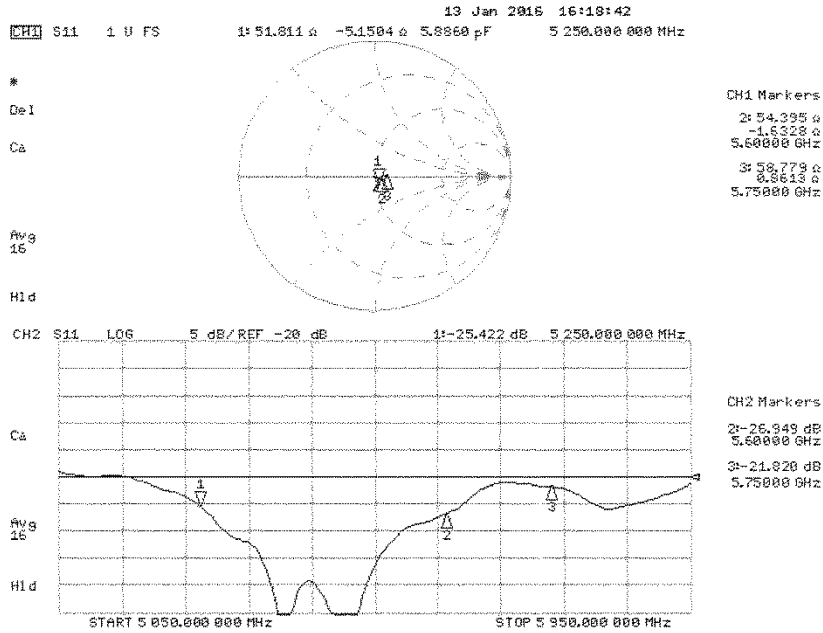

Dosimetric E-Field Probe Calibration Certificate (EX3DV4, S/N: 3825)

**Calibration Laboratory of
 Schmid & Partner
 Engineering AG**
 Zeughausstrasse 43, 8004 Zurich, Switzerland



S Schweizerischer Kalibrierdienst
C Service suisse d'étalonnage
S Servizio svizzero di taratura
S Swiss Calibration Service

Accredited by the Swiss Accreditation Service (SAS)
 The Swiss Accreditation Service is one of the signatories to the EA
 Multilateral Agreement for the recognition of calibration certificates

Accreditation No.: **SCS 0108**

Client **UL Japan (Vitec)**

Certificate No: **EX3-3825_Dec15**

CALIBRATION CERTIFICATE

Object **EX3DV4 - SN:3825**

Calibration procedure(s) **QA CAL-01.v9, QA CAL-14.v4, QA CAL-23.v5, QA CAL-25.v6
 Calibration procedure for dosimetric E-field probes**

Calibration date: **December 11, 2015**

This calibration certificate documents the traceability to national standards, which realize the physical units of measurements (SI).
 The measurements and the uncertainties with confidence probability are given on the following pages and are part of the certificate.

All calibrations have been conducted in the closed laboratory facility: environment temperature (22 ± 3)°C and humidity < 70%.

Calibration Equipment used (M&TE critical for calibration)

Primary Standards	ID	Cal Date (Certificate No.)	Scheduled Calibration
Power meter E4419B	GB41293874	01-Apr-15 (No. 217-02128)	Mar-16
Power sensor E4412A	MY41498087	01-Apr-15 (No. 217-02128)	Mar-16
Reference 3 dB Attenuator	SN: S5054 (3c)	01-Apr-15 (No. 217-02129)	Mar-16
Reference 20 dB Attenuator	SN: S5277 (20x)	01-Apr-15 (No. 217-02132)	Mar-16
Reference 30 dB Attenuator	SN: S5129 (30b)	01-Apr-15 (No. 217-02133)	Mar-16
Reference Probe ES3DV2	SN: 3013	30-Dec-14 (No. ES3-3013_Dec14)	Dec-15
DAE4	SN: 660	14-Jan-15 (No. DAE4-660_Jan15)	Jan-16
Secondary Standards	ID	Check Date (in house)	Scheduled Check
RF generator HP 8648C	US3642U01700	4-Aug-99 (in house check Apr-13)	In house check: Apr-16
Network Analyzer HP 8753E	US37390585	18-Oct-01 (in house check Oct-15)	In house check: Oct-16

Calibrated by:	Name Leif Klysner	Function Laboratory Technician	Signature
Approved by:	Name Katja Pokovic	Function Technical Manager	Signature

Issued: December 15, 2015

This calibration certificate shall not be reproduced except in full without written approval of the laboratory.

Calibration Laboratory of
Schmid & Partner
Engineering AG
Zeughausstrasse 43, 8004 Zurich, Switzerland



S Schweizerischer Kalibrierdienst
C Service suisse d'étalonnage
S Servizio svizzero di taratura
Swiss Calibration Service

Accredited by the Swiss Accreditation Service (SAS)

Accreditation No.: SCS 0108

The Swiss Accreditation Service is one of the signatories to the EA
Multilateral Agreement for the recognition of calibration certificates

Glossary:

TSL	tissue simulating liquid
NORM _{x,y,z}	sensitivity in free space
ConvF	sensitivity in TSL / NORM _{x,y,z}
DCP	diode compression point
CF	crest factor (1/duty_cycle) of the RF signal
A, B, C, D	modulation dependent linearization parameters
Polarization ϕ	ϕ rotation around probe axis
Polarization ϑ	ϑ rotation around an axis that is in the plane normal to probe axis (at measurement center), i.e., $\vartheta = 0$ is normal to probe axis
Connector Angle	information used in DASY system to align probe sensor X to the robot coordinate system

Calibration is Performed According to the Following Standards:

- IEEE Std 1528-2013, "IEEE Recommended Practice for Determining the Peak Spatial-Averaged Specific Absorption Rate (SAR) in the Human Head from Wireless Communications Devices: Measurement Techniques", June 2013
- IEC 62209-1, "Procedure to measure the Specific Absorption Rate (SAR) for hand-held devices used in close proximity to the ear (frequency range of 300 MHz to 3 GHz)", February 2005
- IEC 62209-2, "Procedure to determine the Specific Absorption Rate (SAR) for wireless communication devices used in close proximity to the human body (frequency range of 30 MHz to 6 GHz)", March 2010
- KDB 865664, "SAR Measurement Requirements for 100 MHz to 6 GHz"

Methods Applied and Interpretation of Parameters:

- NORM_{x,y,z}**: Assessed for E-field polarization $\vartheta = 0$ ($f \leq 900$ MHz in TEM-cell; $f > 1800$ MHz: R22 waveguide). NORM_{x,y,z} are only intermediate values, i.e., the uncertainties of NORM_{x,y,z} does not affect the E²-field uncertainty inside TSL (see below ConvF).
- NORM(f)_{x,y,z} = NORM_{x,y,z} * frequency_response** (see Frequency Response Chart). This linearization is implemented in DASY4 software versions later than 4.2. The uncertainty of the frequency response is included in the stated uncertainty of ConvF.
- DCP_{x,y,z}**: DCP are numerical linearization parameters assessed based on the data of power sweep with CW signal (no uncertainty required). DCP does not depend on frequency nor media.
- PAR**: PAR is the Peak to Average Ratio that is not calibrated but determined based on the signal characteristics
- A_{x,y,z}; B_{x,y,z}; C_{x,y,z}; D_{x,y,z}; VR_{x,y,z}; A, B, C, D** are numerical linearization parameters assessed based on the data of power sweep for specific modulation signal. The parameters do not depend on frequency nor media. VR is the maximum calibration range expressed in RMS voltage across the diode.
- ConvF and Boundary Effect Parameters**: Assessed in flat phantom using E-field (or Temperature Transfer Standard for $f \leq 800$ MHz) and inside waveguide using analytical field distributions based on power measurements for $f > 800$ MHz. The same setups are used for assessment of the parameters applied for boundary compensation (alpha, depth) of which typical uncertainty values are given. These parameters are used in DASY4 software to improve probe accuracy close to the boundary. The sensitivity in TSL corresponds to NORM_{x,y,z} * ConvF whereby the uncertainty corresponds to that given for ConvF. A frequency dependent ConvF is used in DASY version 4.4 and higher which allows extending the validity from ± 50 MHz to ± 100 MHz.
- Spherical isotropy (3D deviation from isotropy)**: in a field of low gradients realized using a flat phantom exposed by a patch antenna.
- Sensor Offset**: The sensor offset corresponds to the offset of virtual measurement center from the probe tip (on probe axis). No tolerance required.
- Connector Angle**: The angle is assessed using the information gained by determining the NORM_x (no uncertainty required).

EX3DV4 – SN:3825

December 11, 2015

Probe EX3DV4

SN:3825

Manufactured: September 6, 2011
Calibrated: December 11, 2015

Calibrated for DASYS/EASY Systems
(Note: non-compatible with DASYS2 system!)

EX3DV4- SN:3825

December 11, 2015

DASY/EASY - Parameters of Probe: EX3DV4 - SN:3825

Basic Calibration Parameters

	Sensor X	Sensor Y	Sensor Z	Unc (k=2)
Norm ($\mu\text{V}/(\text{V}/\text{m})^2$) ^A	0.43	0.39	0.43	$\pm 10.1 \%$
DCP (mV) ^B	101.4	102.7	100.2	

Modulation Calibration Parameters

UID	Communication System Name		A dB	B dB $\sqrt{\mu\text{V}}$	C	D dB	VR mV	Unc ^E (k=2)
0	CW	X	0.0	0.0	1.0	0.00	143.6	$\pm 2.7 \%$
		Y	0.0	0.0	1.0		139.1	
		Z	0.0	0.0	1.0		153.8	

The reported uncertainty of measurement is stated as the standard uncertainty of measurement multiplied by the coverage factor k=2, which for a normal distribution corresponds to a coverage probability of approximately 95%.

^A The uncertainties of Norm X,Y,Z do not affect the E²-field uncertainty inside TSL (see Pages 5 and 6).

^B Numerical linearization parameter: uncertainty not required.

^E Uncertainty is determined using the max. deviation from linear response applying rectangular distribution and is expressed for the square of the field value.

EX3DV4- SN:3825

December 11, 2015

DASY/EASY - Parameters of Probe: EX3DV4 - SN:3825

Calibration Parameter Determined in Head Tissue Simulating Media

f (MHz) ^C	Relative Permittivity ^F	Conductivity (S/m) ^F	ConvF X	ConvF Y	ConvF Z	Alpha ^G	Depth (mm) ^G	Unc (k=2)
750	41.9	0.89	9.79	9.79	9.79	0.23	1.25	± 12.0 %
835	41.5	0.90	9.49	9.49	9.49	0.21	1.30	± 12.0 %
900	41.5	0.97	9.23	9.23	9.23	0.24	1.24	± 12.0 %
1450	40.5	1.20	8.30	8.30	8.30	0.12	2.03	± 12.0 %
1750	40.1	1.37	8.18	8.18	8.18	0.24	0.95	± 12.0 %
1900	40.0	1.40	7.94	7.94	7.94	0.31	0.85	± 12.0 %
1950	40.0	1.40	7.69	7.69	7.69	0.31	0.85	± 12.0 %
2450	39.2	1.80	7.31	7.31	7.31	0.34	0.83	± 12.0 %
3500	37.9	2.91	6.91	6.91	6.91	0.28	1.25	± 13.1 %
5200	36.0	4.66	5.13	5.13	5.13	0.35	1.80	± 13.1 %
5250	35.9	4.71	5.06	5.06	5.06	0.35	1.80	± 13.1 %
5300	35.9	4.76	4.83	4.83	4.83	0.40	1.80	± 13.1 %
5500	35.6	4.96	4.60	4.60	4.60	0.45	1.80	± 13.1 %
5600	35.5	5.07	4.27	4.27	4.27	0.50	1.80	± 13.1 %
5750	35.4	5.22	4.44	4.44	4.44	0.50	1.80	± 13.1 %
5800	35.3	5.27	4.34	4.34	4.34	0.50	1.80	± 13.1 %

^C Frequency validity above 300 MHz of ± 100 MHz only applies for DASY v4.4 and higher (see Page 2), else it is restricted to ± 50 MHz. The uncertainty is the RSS of the ConvF uncertainty at calibration frequency and the uncertainty for the indicated frequency band. Frequency validity below 300 MHz is ± 10, 25, 40, 50 and 70 MHz for ConvF assessments at 30, 64, 128, 150 and 220 MHz respectively. Above 5 GHz frequency validity can be extended to ± 110 MHz.

^F At frequencies below 3 GHz, the validity of tissue parameters (ϵ and σ) can be relaxed to ± 10% if liquid compensation formula is applied to measured SAR values. At frequencies above 3 GHz, the validity of tissue parameters (ϵ and σ) is restricted to ± 5%. The uncertainty is the RSS of the ConvF uncertainty for indicated target tissue parameters.

^G Alpha/Depth are determined during calibration. SPEAG warrants that the remaining deviation due to the boundary effect after compensation is always less than ± 1% for frequencies below 3 GHz and below ± 2% for frequencies between 3-6 GHz at any distance larger than half the probe tip diameter from the boundary.

DASY/EASY - Parameters of Probe: EX3DV4 - SN:3825

Calibration Parameter Determined in Body Tissue Simulating Media

f (MHz) ^C	Relative Permittivity ^F	Conductivity (S/m) ^F	ConvF X	ConvF Y	ConvF Z	Alpha ^G	Depth ^G (mm)	Unc (k=2)
750	55.5	0.96	9.89	9.89	9.89	0.35	0.92	± 12.0 %
835	55.2	0.97	9.67	9.67	9.67	0.23	1.22	± 12.0 %
900	55.0	1.05	9.56	9.56	9.56	0.30	0.98	± 12.0 %
1450	54.0	1.30	8.18	8.18	8.18	0.24	1.09	± 12.0 %
1750	53.4	1.49	7.94	7.94	7.94	0.32	0.88	± 12.0 %
1900	53.3	1.52	7.66	7.66	7.66	0.23	1.10	± 12.0 %
1950	53.3	1.52	7.93	7.93	7.93	0.29	0.96	± 12.0 %
2450	52.7	1.95	7.29	7.29	7.29	0.32	0.85	± 12.0 %
3500	51.3	3.31	6.39	6.39	6.39	0.36	1.06	± 13.1 %
5250	48.9	5.36	4.25	4.25	4.25	0.50	1.90	± 13.1 %
5600	48.5	5.77	3.61	3.61	3.61	0.60	1.90	± 13.1 %
5750	48.3	5.94	3.85	3.85	3.85	0.60	1.90	± 13.1 %

^C Frequency validity above 300 MHz of ± 100 MHz only applies for DASY v4.4 and higher (see Page 2), else it is restricted to ± 50 MHz. The uncertainty is the RSS of the ConvF uncertainty at calibration frequency and the uncertainty for the indicated frequency band. Frequency validity below 300 MHz is ± 10, 25, 40, 50 and 70 MHz for ConvF assessments at 30, 64, 128, 150 and 220 MHz respectively. Above 5 GHz frequency validity can be extended to ± 110 MHz.

^F At frequencies below 3 GHz, the validity of tissue parameters (ϵ and σ) can be relaxed to ± 10% if liquid compensation formula is applied to measured SAR values. At frequencies above 3 GHz, the validity of tissue parameters (ϵ and σ) is restricted to ± 5%. The uncertainty is the RSS of the ConvF uncertainty for indicated target tissue parameters.

^G Alpha/Depth are determined during calibration. SPEAG warrants that the remaining deviation due to the boundary effect after compensation is always less than ± 1% for frequencies below 3 GHz and below ± 2% for frequencies between 3-6 GHz at any distance larger than half the probe tip diameter from the boundary.

EX3DV4- SN:3825

December 11, 2015

Frequency Response of E-Field (TEM-Cell:ifi110 EXX, Waveguide: R22)

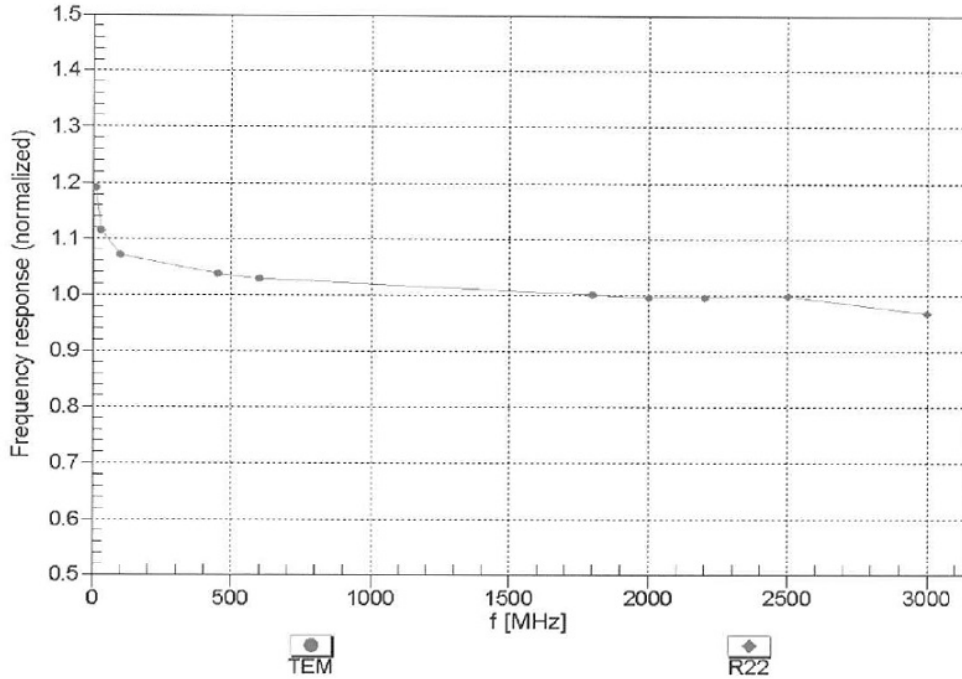

Uncertainty of Frequency Response of E-field: $\pm 6.3\%$ (k=2)

EX3DV4- SN:3825

December 11, 2015

Receiving Pattern (ϕ), $\theta = 0^\circ$

f=600 MHz,TEM

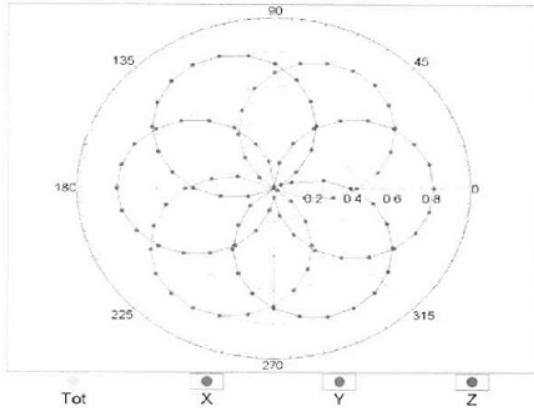

f=1800 MHz,R22

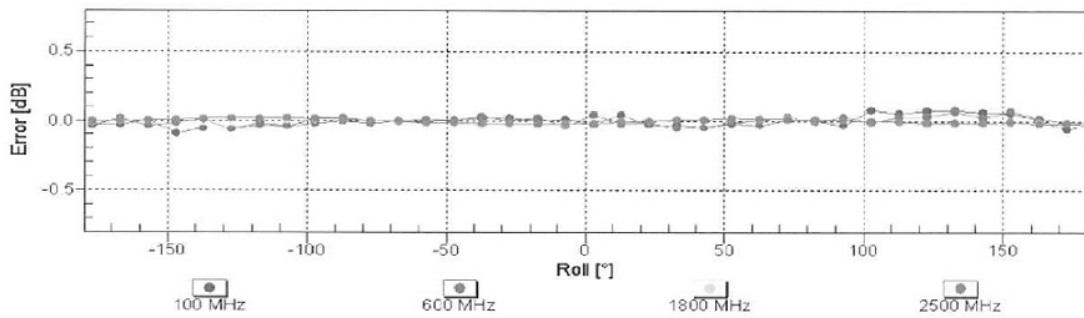
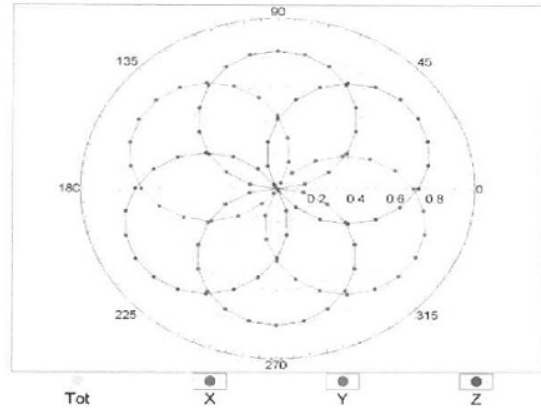

Uncertainty of Axial Isotropy Assessment: $\pm 0.5\%$ (k=2)

EX3DV4- SN:3825

December 11, 2015

Dynamic Range f(SAR_{head}) (TEM cell , f_{eval}= 1900 MHz)

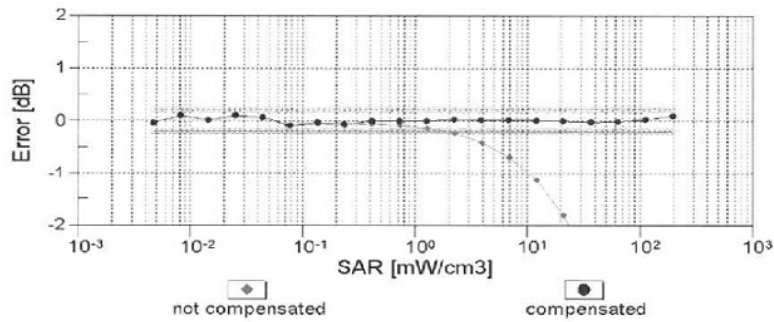
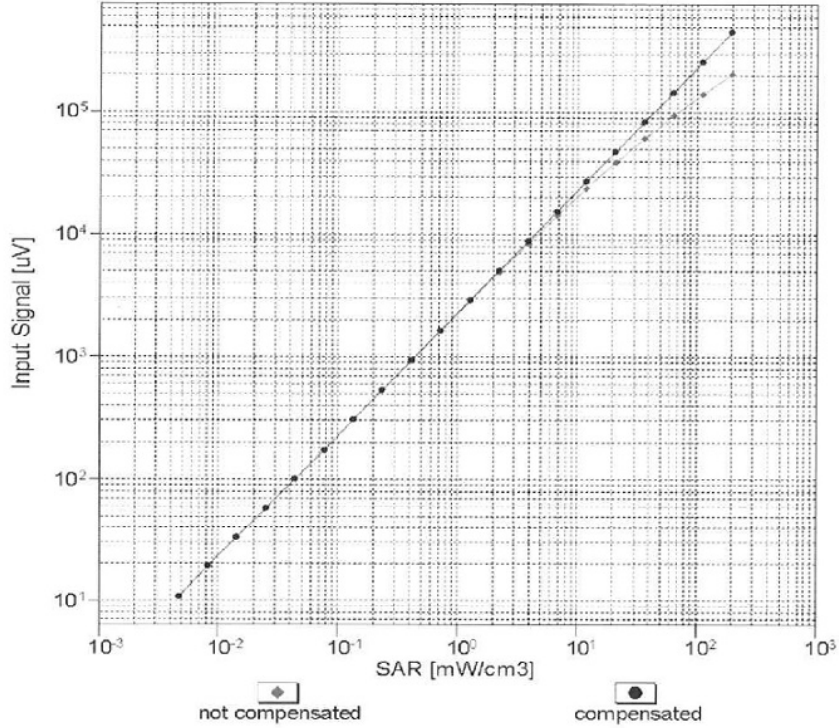

Uncertainty of Linearity Assessment: ± 0.6% (k=2)

Conversion Factor Assessment

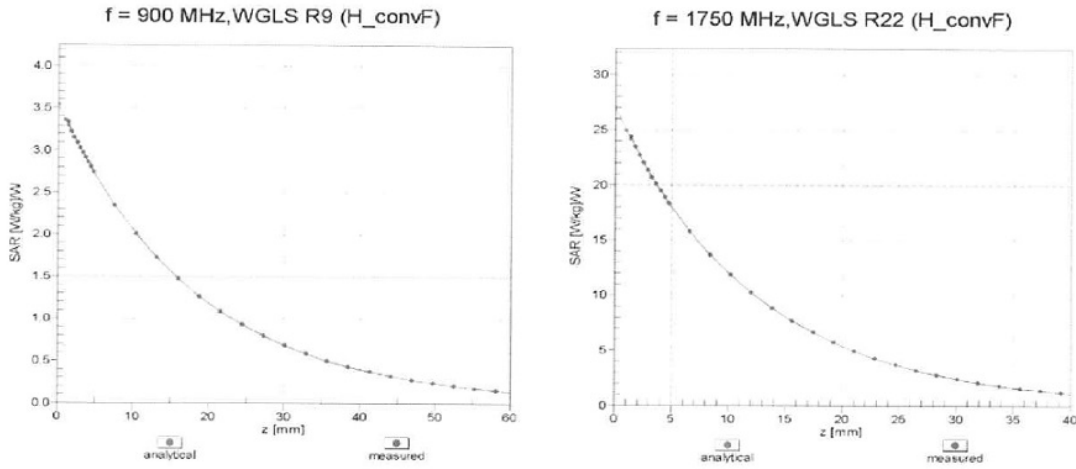

Deviation from Isotropy in Liquid

Error (ϕ , θ), f = 900 MHz

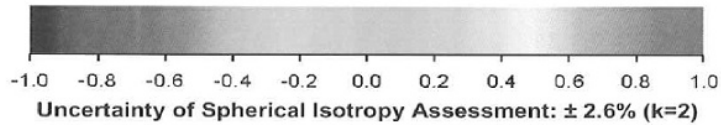
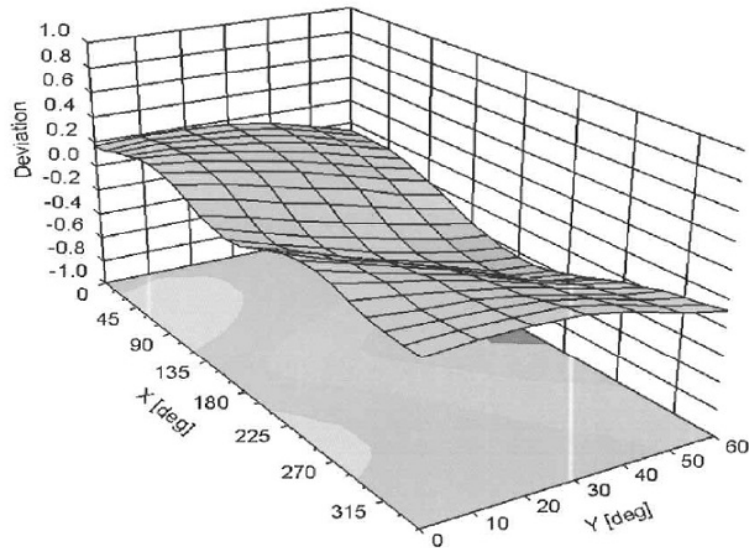

EX3DV4- SN:3825

December 11, 2015

DASY/EASY - Parameters of Probe: EX3DV4 - SN:3825

Other Probe Parameters

Sensor Arrangement	Triangular
Connector Angle (°)	-27.3
Mechanical Surface Detection Mode	enabled
Optical Surface Detection Mode	disabled
Probe Overall Length	337 mm
Probe Body Diameter	10 mm
Tip Length	9 mm
Tip Diameter	2.5 mm
Probe Tip to Sensor X Calibration Point	1 mm
Probe Tip to Sensor Y Calibration Point	1 mm
Probe Tip to Sensor Z Calibration Point	1 mm
Recommended Measurement Distance from Surface	1.4 mm

System check uncertainty

The uncertainty budget has been determined for the DASY5 measurement system according to the SPEAG documents and is given in the following Table.

Repeatability Budget for System Check

<0.3 – 3GHz range Body>

Error Description	Uncertainty value ± %	Probability distribution	divisor	(ci) 1g	Standard (1g)	vi or veff
Measurement System						
Probe calibration	± 1.8	Normal	1	1	± 1.8	∞
Axial isotropy of the probe	± 0.0	Rectangular	√3	1	± 0.0	∞
Spherical isotropy of the probe	± 0.0	Rectangular	√3	1	± 0.0	∞
Boundary effects	± 0.0	Rectangular	√3	1	± 0.0	∞
Probe linearity	± 0.0	Rectangular	√3	1	± 0.0	∞
Detection limit	± 0.0	Rectangular	√3	1	± 0.0	∞
Modulation response	± 0.0	Rectangular	√3	1	± 0.0	∞
Readout electronics	± 0.0	Normal	1	1	± 0.0	∞
Response time	± 0.0	Rectangular	√3	1	± 0.0	∞
Integration time	± 0.0	Rectangular	√3	1	± 0.0	∞
RF ambient Noise	± 0.0	Rectangular	√3	1	± 0.0	∞
RF ambient Reflections	± 0.0	Rectangular	√3	1	± 0.0	∞
Probe Positioner	± 0.4	Rectangular	√3	1	± 0.2	∞
Probe positioning	± 2.9	Rectangular	√3	1	± 1.7	∞
Max.SAR Eval.	± 0.0	Rectangular	√3	1	± 0.0	∞
Test Sample Related						
Deviation of wxp.dipole	± 0.0	Rectangular	√3	1	± 0.0	∞
Dipole Axis to Liquid Distance	± 2.0	Rectangular	√3	1	± 1.2	∞
Input power and SAR drift meas.	± 3.4	Rectangular	√3	1	± 2.0	∞
Phantom and Setup						
Phantom uncertainty	± 4.0	Rectangular	√3	1	± 2.3	∞
Algorithm for correcting SAR for deviations in permittivity and conductivity	± 1.9	Rectangular	√3	1	± 1.1	∞
Liquid conductivity (meas.)	± 5.0	Normal	1	0.78	+ 3.9	∞
Liquid permittivity (meas.)	± 5.0	Normal	1	0.26	- 1.3	∞
Liquid conductivity - temp.unc (below 2deg.C.)	± 1.7	Rectangular	√3	0.78	± 0.8	∞
Liquid permittivity - temp.unc (below 2deg.C.)	± 0.3	Rectangular	√3	0.23	± 0.0	∞
Combined Standard Uncertainty					± 5.945	
Expanded Uncertainty (k=2)					± 11.9	

<3 – 6GHz range Body>

Error Description	Uncertainty value ± %	Probability distribution	divisor	(ci) 1g	Standard (1g)	vi or veff
Measurement System						
Probe calibration	± 1.8	Normal	1	1	± 1.8	∞
Axial isotropy of the probe	± 0.0	Rectangular	√3	1	± 0.0	∞
Spherical isotropy of the probe	± 0.0	Rectangular	√3	1	± 0.0	∞
Boundary effects	± 0.0	Rectangular	√3	1	± 0.0	∞
Probe linearity	± 0.0	Rectangular	√3	1	± 0.0	∞
Detection limit	± 0.0	Rectangular	√3	1	± 0.0	∞
Modulation response	± 0.0	Rectangular	√3	1	± 0.0	∞
Readout electronics	± 0.0	Normal	1	1	± 0.0	∞
Response time	± 0.0	Rectangular	√3	1	± 0.0	∞
Integration time	± 0.0	Rectangular	√3	1	± 0.0	∞
RF ambient Noise	± 0.0	Rectangular	√3	1	± 0.0	∞
RF ambient Reflections	± 0.0	Rectangular	√3	1	± 0.0	∞
Probe Positioner	± 0.8	Rectangular	√3	1	± 0.5	∞
Probe positioning	± 6.7	Rectangular	√3	1	± 3.9	∞
Max.SAR Eval.	± 0.0	Rectangular	√3	1	± 0.0	∞
Test Sample Related						
Deviation of wxp.dipole	± 0.0	Rectangular	√3	1	± 0.0	∞
Dipole Axis to Liquid Distance	± 2.0	Rectangular	√3	1	± 1.2	∞
Input power and SAR drift meas.	± 3.4	Rectangular	√3	1	± 2.0	∞
Phantom and Setup						
Phantom uncertainty	± 4.0	Rectangular	√3	1	± 2.3	∞
Algorithm for correcting SAR for deviations in permittivity and conductivity	± 1.9	Rectangular	√3	1	± 1.1	∞
Liquid conductivity (meas.)	± 5.0	Normal	1	0.78	+ 3.9	∞
Liquid permittivity (meas.)	± 5.0	Normal	1	0.26	- 1.3	∞
Liquid conductivity - temp.unc (below 2deg.C.)	± 1.7	Rectangular	√3	0.78	± 0.8	∞
Liquid permittivity - temp.unc (below 2deg.C.)	± 0.3	Rectangular	√3	0.23	± 0.0	∞
Combined Standard Uncertainty					± 6.906	
Expanded Uncertainty (k=2)					± 13.8	