



RADIO TEST REPORT

Test Report No. : 11334871S-G-R1

Applicant : Nintendo Co., Ltd.
Type of Equipment : Game Console
Model No. : HAC-001
FCC ID : BKEHAC001
Test regulation : FCC Part 15 Subpart E: 2016
Section 15.407(DFS test only)
Test Result : Complied

1. This test report shall not be reproduced in full or partial, without the written approval of UL Japan, Inc.
2. The results in this report apply only to the sample tested.
3. This sample tested is in compliance with the limits of the above regulation.
4. The test results in this test report are traceable to the national or international standards.
5. This test report must not be used by the customer to claim product certification, approval, or endorsement by any agency of the Federal Government.
6. The opinions and the interpretations to the result of the description in this report are outside scopes where UL Japan has been accredited.
7. This test report covers Radio technical requirements.
It does not cover administrative issues such as Manual or non-Radio test related Requirements. (if applicable)
8. This report is a revised version of 11334871S-G. 11334871S-G is replaced with this report.

Date of test : December 5 to 6, 2016

Representative test engineer: 
Kenichi Adachi
Engineer
Consumer Technology Division

Approved by : 
Akio Hayashi
Leader
Consumer Technology Division



- The testing in which "Non-accreditation" is displayed is outside the accreditation scopes in UL Japan.
 There is no testing item of "Non-accreditation".

UL Japan, Inc.
Shonan EMC Lab.

1-22-3 Megumigaoka, Hiratsuka-shi, Kanagawa-ken, 259-1220 JAPAN
Telephone: +81 463 50 6400
Facsimile: +81 463 50 6401

13-EM-F0429

CONTENTS	PAGE
SECTION 1: Customer information	4
SECTION 2: Equipment under test (E.U.T.)	4
SECTION 3: Scope of Report	5
SECTION 4: Test specification, procedures & results	5
SECTION 5: Operation of E.U.T. during testing.....	10
SECTION 6: In-Service Monitoring for Channel Move Time, Channel Closing Transmission Time	17
SECTION 7: In-Service Monitoring for Non-Occupancy Period	23
APPENDIX 1: Test instruments	28
APPENDIX 2: Photographs of test setup.....	29

UL Japan, Inc.

Shonan EMC Lab.

1-22-3 Megumigaoka, Hiratsuka-shi, Kanagawa-ken, 259-1220 JAPAN

Telephone: +81 463 50 6400

Facsimile: +81 463 50 6401

SECTION 1: Customer information

Company Name : Nintendo Co., Ltd.
Address : 11-1 Hokotate-cho, Kamitoba, Minami-ku, Kyoto 601-8501, Japan
Telephone Number : +81-75-662-9600
Facsimile Number : +81-75-662-9624
Contact Person : Kazuya Kuramoto

SECTION 2: Equipment under test (E.U.T.)

2.1 Identification of E.U.T.

Type of Equipment : Game Console
Model No. : HAC-001
Serial No. : Refer to Section 5.2
Rating : DC 3.7 V (battery),
AC Adapter input: AC 100 – 240 V, 50 / 60 Hz, 1 A,
AC Adapter output: DC 5 V – DC 15 V, 2.6 A
Receipt Date of Sample : August 3, 2016
Country of Mass-production : China
Condition of EUT : Production prototype
(Not for Sale: This sample is equivalent to mass-produced items.)
Modification of EUT : No Modification by the test lab

2.2 Product description

Model: HAC-001 (referred to as the EUT in this report) is a Game console.

General Specification

Clock frequency(ies) in the system : 37.4 MHz

Radio Specification

Radio Type : Transceiver
Frequency of Operation : Wireless LAN part: 2412 MHz - 2472 MHz,
W52: 5180 MHz -5240 MHz,
W53: 5260 MHz -5320 MHz,
W56: 5500 MHz -5700 MHz *,
W58: 5745 MHz -5825 MHz *,
Bluetooth part: 2402 MHz - 2480 MHz
Modulation : Wireless LAN part:
2.4 GHz bands: DBPSK, DQPSK, CCK, OFDM
5 GHz bands: OFDM
Bluetooth part:
BDR (Basic Data Rate): GFSK
EDR (Enhanced Data Rate): $\pi/4$ -DQPSK, 8DPSK
LE (Low Energy mode): GFSK
Antenna type : PCB Antenna (Dipole)
Antenna connector : (Ant: 0): MHF 4L, (Ant: 1): MHF II
Antenna Gain : 2.4 GHz band:
-0.70 dBi max (ANT0: Wireless LAN & Bluetooth), -8.38 dBi max (ANT1: Wireless LAN)
5 GHz band:
+3.31 dBi max (ANT0: Wireless LAN), -0.96 dBi max (ANT1: Wireless LAN)
Operation temperature : +5 deg.C to +35 deg.C

Remarks: This Wireless Module consists of 1 chip each of 5 GHz band and 2.4 GHz band.

*This model does not have 40MHz Bandwidth mode on W56 and W58.

UL Japan, Inc.

Shonan EMC Lab.

1-22-3 Megumigaoka, Hiratsuka-shi, Kanagawa-ken, 259-1220 JAPAN

Telephone: +81 463 50 6400

Facsimile: +81 463 50 6401

SECTION 3: Scope of Report

The EUT has the channels from 5180 MHz to 5320MHz and 5500 MHz to 5700 MHz.
This report only covers DFS requirement subject to 5250 MHz to 5350 MHz and 5500 MHz to 5700 MHz bands,
as specified by the following referenced procedures.

SECTION 4: Test specification, procedures & results

4.1 Test Specification

Test specification : FCC Part 15 Subpart E: 2016, November 14, 2016 and effective December 14, 2016 *

Title : FCC 47CFR Part15 Radio Frequency Device
Subpart E Unlicensed National Information InfrastructurGame Consoleices
Section 15.407 General technical requirements

* The revision on November 14, 2016, does not affect the test specification applied to the EUT.

Test Specification : KDB 905462 D02 v02
Title : COMPLIANCE MEASUREMENT PROCEDURES FOR UNILICENSED
-NATIONAL INFORMATION INFRASTRUCTURGAME CONSOLEICES
OPERATING IN THE 5250 - 5350 MHz AND 5470 - 5725 MHz BANDS
INCORPORATING DYNAMIC FREQUENCY SELECTION

FCC Part 15.31 (e)

This EUT provides stable voltage (DC 3.3 V) constantly to RF Part regardless of input voltage. Therefore, this EUT complies with the requirement.

FCC Part 15.203 Antenna requirement

It is impossible for end users to replace the antenna, because the antenna is mounted inside of the EUT. Therefore, the equipment complies with the antenna requirement of Section 15.203.

4.2 Procedures and results

Table 2: Applicability of DFS Requirements

Requirement	Operating Mode	Test Procedures & Limits	Deviation	Results
	Client without Radar Detection			
U-NII Detection Bandwidth	Not required	FCC, KDB 905462 D02 Section 7.8.1	N/A	N/A
Initial Channel Availability Check Time	Not required	FCC15.407 (h)(2)	N/A	N/A
		FCC, KDB 905462 D02 Section 7.8.2.1		
		RSS-247 6.3		
Radar Burst at the Beginning of the Channel Availability Check Time	Not required	FCC15.407 (h)(2)	N/A	N/A
		FCC, KDB 905462 D02 Section 7.8.2.2		
		RSS-247 6.3		
Radar Burst at the End of the Channel Availability Check Time	Not required	FCC15.407 (h)(2)	N/A	N/A
		FCC, KDB 905462 D02 Section 7.8.2.3		
		RSS-247 6.3		
In-Service Monitoring for Channel Move Time, Channel Closing Transmission Time	Yes	FCC15.407 (h)(2)	N/A	Complied
		FCC, KDB 905462 D02 Section 7.8.3		
		RSS-247 6.3		
In-Service Monitoring for Non-Occupancy period	Yes *	FCC15.407 (h)(2)	N/A	Complied
		FCC, KDB 905462 D02 Section 7.8.3		
		RSS-247 6.3		
Statistical Performance Check	Not required	FCC15.407 (h)(2)	N/A	N/A
		FCC, KDB 905462 D02 Section 7.8.4		

*Although this test was not required in FCC, KDB 905462 D02, it was performed as additional test.

Table 3: DFS Detection Thresholds for Master Devices and Client Devices With Radar

Maximum Transmit Power	Value (See Notes 1, 2 and 3)
E.I.R.P. \geq 200 milliwatt	-64 dBm
E.I.R.P. $<$ 200 milliwatt and power spectral density $<$ 10dBm/MHz	-62 dBm
E.I.R.P. $<$ 200 milliwatt that do not meet the power spectral density requirement	-64 dBm
<p>Note 1: This is the level at the input of the receiver assuming a 0 dBi receive antenna.</p> <p>Note 2: Throughout these test procedures an additional 1 dB has been added to the amplitude of the test transmission waveforms to account for variations in measurement equipment. This will ensure that the test signal is at or above the detection threshold level to trigger a DFS response.</p> <p>Note 3: E.I.R.P. is based on the highest antenna gain. For MIMO devices refer to KDB Publication 662911 D01.</p>	

UL Japan, Inc.
Shonan EMC Lab.

1-22-3 Megumigaoka, Hiratsuka-shi, Kanagawa-ken, 259-1220 JAPAN
Telephone: +81 463 50 6400
Facsimile: +81 463 50 6401

Table 4: DFS Response Requirement Values

Parameter	Value
Non-occupancy period	Minimum 30 minutes
Channel Availability Check Time	60 seconds
Channel Move Time	10 seconds See Note 1
Channel Closing Transmission Time	200 milliseconds + an aggregate of 60 milliseconds over remaining 10 second period. See Notes 1 and 2
U-NII Detection Bandwidth	Minimum 100 % of the U-NII 99 % transmission power bandwidth See Note 3
<p>Note 1: The Channel Move Time and the Channel Closing Transmission Time should be performed with Radar Type 0. The measurement timing begins at the end of the Radar Type 0 burst.</p> <p>Note 2: The Channel Closing Transmission Time is comprised of 200 milliseconds starting at the beginning of the Channel Move Time plus any additional intermittent control signals required to facilitate a Channel move (an aggregate of 60 milliseconds) during the remainder of the 10 second period. The aggregate duration of control signal will not count quiet periods in between transmissions.</p> <p>Note 3: During the U-NII Detection Bandwidth detection test, radar type 0 should be used. For each frequency step the minimum percentage of detection is 90 percent. Measurements are performed with no data traffic.</p>	

Table 5 Short Pulse Radar Test Waveform

Radar Type	Pulse Width [μs]	PRI [μs]	Number of Pulses	Minimum Percentage of Successful Detection	Minimum Number of Trials
0	1	1428	18	See Note 1	See Note 1
1	1	Test A: 15 unique PRI values randomly selected from the list of 23 PRI values in Table 5a Test B: 15 unique PRI values randomly selected within the range of 518 - 3066 micro sec., with a minimum increment of 1 micro sec., excluding PRI values selected in Test A	$\text{Roundup} \left(\frac{1}{360} \times (19 \times 10^6) / \text{PRI} [\text{micro sec.}] \right)$	60 %	30
2	1 - 5	150 - 230	23 - 29	60 %	30
3	6 - 10	200 - 500	16 - 18	60 %	30
4	11 - 20	200 - 500	12 - 16	60 %	30
Aggregate (Rader Types 1-4)				80 %	120
Note 1: Short Pulse Radar Type 0 should be used for the detection bandwidth test, channel move time, and channel closing time tests.					

UL Japan, Inc.
Shonan EMC Lab.

1-22-3 Megumigaoka, Hiratsuka-shi, Kanagawa-ken, 259-1220 JAPAN
Telephone: +81 463 50 6400
Facsimile: +81 463 50 6401

Table 5a Pulse Repetition Interval Values for Test A

Pulse Repetition Frequency Number	Pulse Repetition Frequency (Pulses Per Second)	Pulse Repetition Interval (Micro seconds)
1	1930.5	518
2	1858.7	538
3	1792.1	558
4	1730.1	578
5	1672.2	598
6	1618.1	618
7	1567.4	638
8	1519.8	658
9	1474.9	678
10	1432.7	698
11	1392.8	718
12	1355	738
13	1319.3	758
14	1285.3	778
15	1253.1	798
16	1222.5	818
17	1193.3	838
18	1165.6	858
19	1139	878
20	1113.6	898
21	1089.3	918
22	1066.1	938
23	326.2	3066

Table 6 Long Pulse Radar Test Waveform

Radar Type	Pulse Width [μs]	Chip Width [MHz]	PRI [μs]	Number of Pulses per Burst	Number of Burst	Minimum Percentage of Successful Detection	Minimum Number of Trials
5	50 - 100	5 - 20	1000 - 2000	1 - 3	8 - 20	80 %	30

Table 7 Frequency Hopping Radar Test Waveform

Radar Type	Pulse Width [μs]	PRI [μs]	Pulse per Hop [kHz]	Hopping Rate [kHz]	Hopping Sequence Length [ms]	Minimum Percentage of Successful Detection	Minimum Number of Trials
6	1	333	9	0.333	300	70 %	30

4.3 Test Location

UL Japan, Inc. Shonan EMC Lab.
1-22-3, Megumigaoka, Hiratsuka-shi, Kanagawa-ken 259-1220 JAPAN
Telephone number : +81 463 50 6400
Facsimile number : +81 463 50 6401
JAB Accreditation No. : RTL02610

	IC Registration No.	Width x Depth x Height (m)	Size of reference ground plane (m) / horizontal conducting plane	Maximum measurement distance
<input type="checkbox"/> No.1 Semi-anechoic chamber	2973D-1	20.6 x 11.3 x 7.65	20.6 x 11.3	10 m
<input type="checkbox"/> No.2 Semi-anechoic chamber	2973D-2	20.6 x 11.3 x 7.65	20.6 x 11.3	10 m
<input type="checkbox"/> No.3 Semi-anechoic chamber	2973D-3	12.7 x 7.7 x 5.35	12.7 x 7.7	5 m
<input type="checkbox"/> No.4 Semi-anechoic chamber	-	8.1 x 5.1 x 3.55	8.1 x 5.1	-
<input type="checkbox"/> No.1 Shielded room	-	6.8 x 4.1 x 2.7	6.8 x 4.1	-
<input type="checkbox"/> No.2 Shielded room	-	6.8 x 4.1 x 2.7	6.8 x 4.1	-
<input type="checkbox"/> No.3 Shielded room	-	6.3 x 4.7 x 2.7	6.3 x 4.7	-
<input type="checkbox"/> No.4 Shielded room	-	4.4 x 4.7 x 2.7	4.4 x 4.7	-
<input checked="" type="checkbox"/> No.5 Shielded room	-	7.8 x 6.4 x 2.7	7.8 x 6.4	-
<input type="checkbox"/> No.6 Shielded room	-	7.8 x 6.4 x 2.7	7.8 x 6.4	-
<input type="checkbox"/> No.8 shielded room	-	3.45 x 5.5 x 2.4	3.45 x 5.5	-
<input type="checkbox"/> No.5 Shielded room	-	2.55 x 4.1 x 2.5	-	-

4.4 Uncertainty

The following uncertainties have been calculated to provide a confidence level of 95 % using a coverage factor $k = 2$.

Time Measurement uncertainty for this test was: (\pm) 0.012 %

4.5 Test set up, Data of DFS test, and Test instruments of DFS

Refer to APPENDIX.

SECTION 5: Operation of E.U.T. during testing

5.1 Operating Modes

The EUT, which is a Client Device without Radar detection capability, operates over the 5260 MHz - 5320 MHz and 5500 MHz to 5700 MHz.

The EUT uses one transmitter connected to a 50 ohm coaxial antenna ports. The antenna port is connected to the test system.

WLAN traffic is generated by iperf.exe (ver.2.0.5) tool some random data from the Master to the Client. (Channel loading was over 17 %)

The EUT utilizes the IEEE 802.11a, IEEE 802.11n and IEEE 802.11ac architecture, with a nominal channel bandwidth. The EUT had used IEEE 802.11ac VHT80 (widest mode).

The FCC ID for the Master Device used with EUT for DFS testing is LDK102087.

The rated output power of the Master unit is > 200 mW(23 dBm). Therefore the required interference threshold level is -64 dBm. After correction for antenna gain and procedural adjustments, the required conducted threshold at the antenna port is $-64 + 1 + 4 = -59$ dBm (threshold level + additional 1 dB + antenna gain *1)).

*1) Minimum antenna gain of the Master Device (FCC ID: LDK102087, IC No.: 2461B-102087)

5.2 Configuration and peripherals

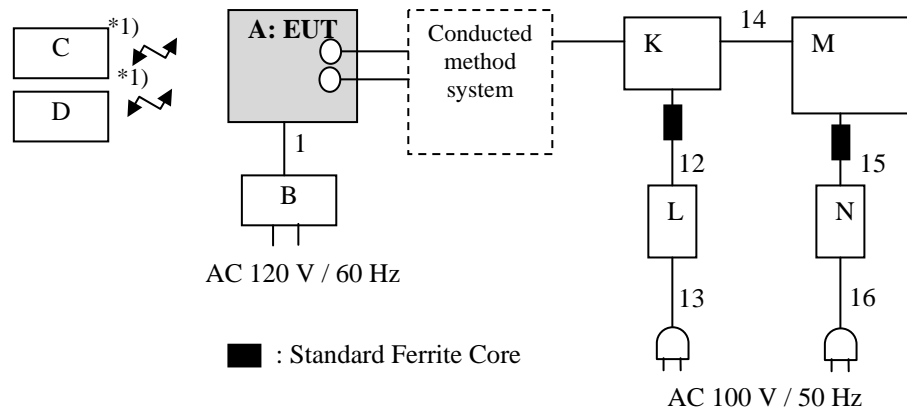

*2) This radio communication with C to A and with D to A are Bluetooth communication, and it had no relation to communication of Wireless LAN, and it was the one only of the purpose which does cursor operation of screen of A.

Description of EUT and Support equipment

No.	Item	Model number	Serial number	Manufacturer	Remarks
A	Game Console	HAC-001	XAW0150000761	Nintendo	EUT (Type B)
B	AC Adapter	HAC-002	-	Nintendo	-
C	Wireless Game Device	HAC-015	XBL0150000240	Nintendo	-
D	Wireless Game Device	HAC-016	XCL0150000151	Nintendo	-
K	Wireless LAN access point (Master Device)	AIR-CAP3702E-A-K9	FTX18227609	Cisco Systems	FCC ID: LDK102087
L	AC Adapter	AA25480L	ALD02510FEW	Cisco Systems	-
M	Notebook Computer	LATITUDE D530	CN-0HP728-48643-83R-0675	Dell	-
N	AC Adapter	FA65NS0-00	CN-0YT886--73245-83R-2744	Dell	-

Accessory and model differences

The difference between Type A and Type B is as following table.

The two crystals are compatible and are electrically identical having same radio parameters.

Parts	Manufacturer	
	Type A	Type B
Crystal (X501)	TXC	DAISHINKU

So, for the all tests, the E.U.T. was selected as a representative.

List of cables used

No.	Cable Name	Length (m)	Shield		Remarks
			Cable	Connector	
1	DC	1.5	Unshielded	Unshielded	-
12	Access Point DC Power	1.8	Unshielded	Unshielded	-
13	Access Point AC Power	1.8	Unshielded	Unshielded	-
14	LAN	3.0	Unshielded	Unshielded	-
15	DELL PC DC Power	1.9	Unshielded	Unshielded	-
16	DELL PC AC Power	0.85	Unshielded	Unshielded	-

UL Japan, Inc.
Shonan EMC Lab.

1-22-3 Megumigaoka, Hiratsuka-shi, Kanagawa-ken, 259-1220 JAPAN

Telephone: +81 463 50 6400

Facsimile: +81 463 50 6401

5.3 Test and Measurement System

SYSTEM OVERVIEW

The measurement system is based on a conducted test method.

The software selects waveform parameters from within the bounds of the signal type on a random basis using uniform distribution. The short pulse types 2, 3, and 4, the long pulse type 5, and the frequency hopping type 6 parameters are randomized at run-time.

The signal monitoring equipment consists of a spectrum analyzer with the capacity to display 8001 bins on the horizontal axis. A time-domain resolution of 2 ms/bin is achievable with a 16 seconds sweep time, meeting the 10 seconds short pulse reporting criteria. The aggregate ON time is calculated by multiplying the number of bins above a threshold during a particular observation period by the dwell time per bin, with the analyzer set to peak detection. A time-domain resolution of 3 ms/bin is achievable with a 24 seconds sweep time, meeting the 22 seconds long pulse reporting criteria and allowing a minimum of 10 seconds after the end of the long pulse waveform.

FREQUENCY HOPPING RADAR WAVEFORM GENERATING SUBSYSTEM

The first 100 frequencies are selected out of the hopping sequence of the randomized 475 hop frequencies. Only a *Burst* that has the frequency falling within the receiver bandwidth of the tested U-NII device is selected among those frequencies. (Frequency-domain simulation). The radar waveform generated at the start time of the selected *Burst* (Time-domain simulation) is download to the Signal Generator. If all of the randomly selected 100 frequencies do not fall within the receiver bandwidth of the U-NII device, the radar waveform is not used for the test.

CONDUCTED METHODS SYSTEM BLOCK DIAGRAM

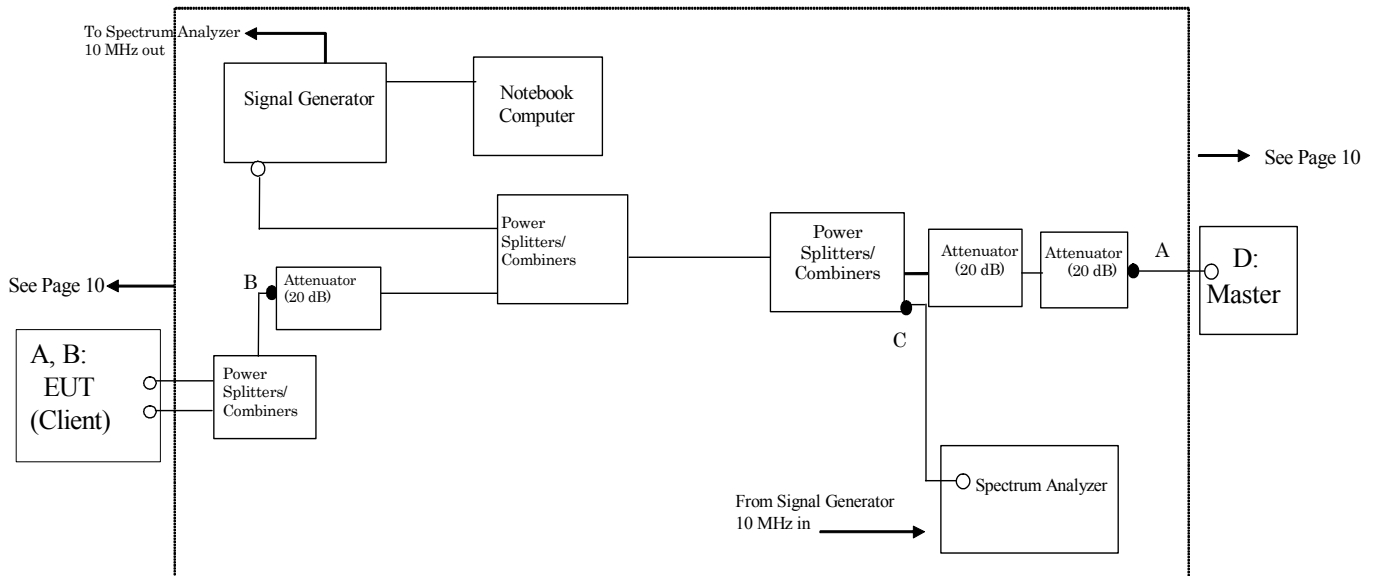

MEASUREMENT SYSTEM FREQUENCY REFERENCE

Lock the signal generator and the spectrum analyzer to the same reference sources as follows: Connect the 10 MHz OUT on the signal generator to the 10 MHz IN on the spectrum analyzer and set the spectrum analyzer 10 MHz In to On.

UL Japan, Inc. Shonan EMC Lab.

1-22-3 Megumigaoka, Hiratsuka-shi, Kanagawa-ken, 259-1220 JAPAN
Telephone: +81 463 50 6400
Facsimile: +81 463 50 6401

SYSTEM CALIBRATION

Step 1: Set the system as shown in Figure 3 of KDB 905462 D02 section 7.2.2.

Step 2: Adjust each attenuator to fulfill the following three conditions:

- WLAN can be communicated, and
- Rader detection threshold level is bigger than Client Device traffic level on the spectrum analyzer, and
- Master Device traffic level is not displayed on the spectrum analyzer.

Step 3: Terminate 50 ohm at B and C points, and connect the spectrum analyzer to the point A.

(See the figure on page 12)

At the point A, adjust the signal generator and spectrum analyzer to the center frequency of the channel to be measured. Download the applicable radar waveforms to the signal generator. Select the radar waveform, trigger a burst manually and measure the amplitude on the spectrum analyzer. Readjust the amplitude of the signal generator as required so that the peak level of the waveform is at a displayed level equal to the required or desired interference detection threshold. Separate signal generator amplitude settings are determined as required for each radar type.

Step 4: Without changing any of the instrument settings, restore the system setting to Step 2 and adjust the Reference Level Offset of the spectrum analyzer to the level at Step 3.

By taking the above steps 1 to 4, the spectrum analyzer displays the level of the signal generator as received at the antenna ports of the Master Device.

See Clause 5.4 for Plots of Noise, Rader Waveforms, and WLAN signals.

5.4 Plots of Noise, Rader Waveforms, and WLAN signals

Plots of System Noise Floor

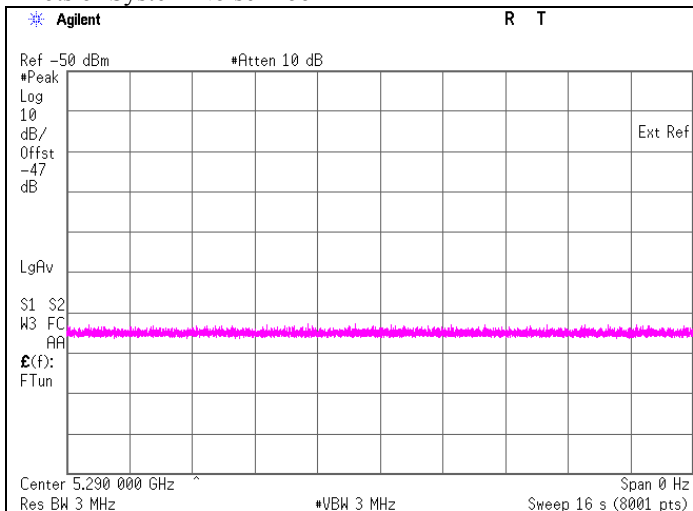

It was confirmed that the EUT did not transmit before having received appropriate control signals from a Master Device.

UL Japan, Inc. Shonan EMC Lab.

1-22-3 Megumigaoka, Hiratsuka-shi, Kanagawa-ken, 259-1220 JAPAN
Telephone: +81 463 50 6400
Facsimile: +81 463 50 6401

Plots of System Noise Floor

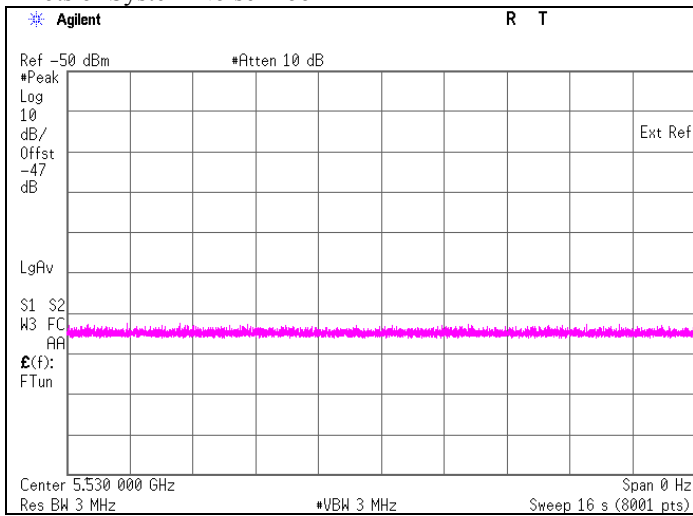

It was confirmed that the EUT did not transmit before having received appropriate control signals from a Master Device.

Plots of Radar Waveforms

Rader Type 0

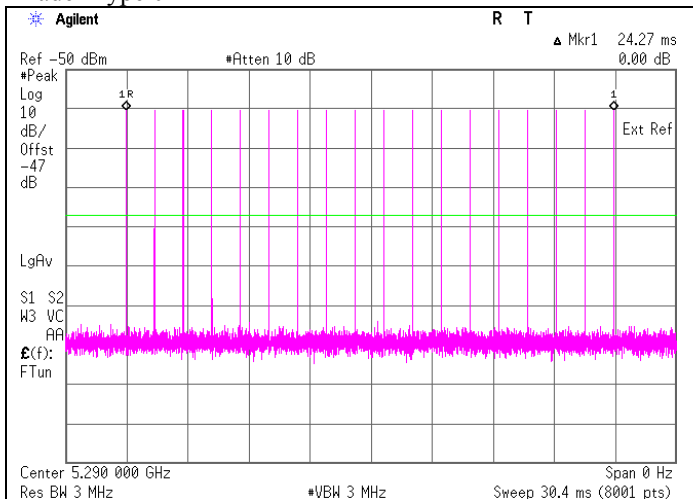

Rader Type 0

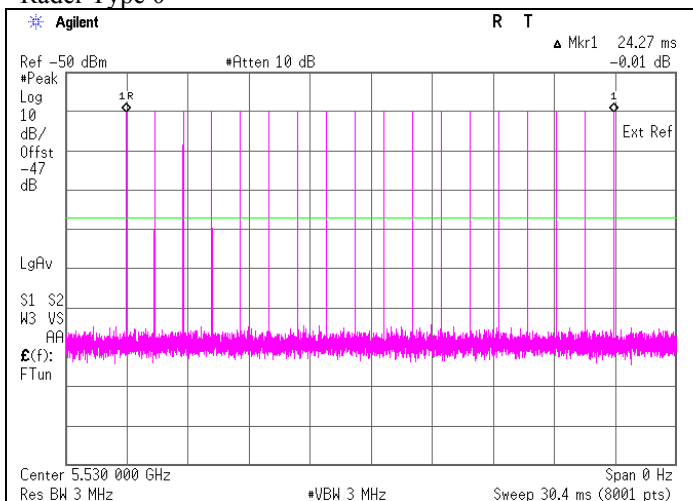

UL Japan, Inc.
Shonan EMC Lab.

1-22-3 Megumigaoka, Hiratsuka-shi, Kanagawa-ken, 259-1220 JAPAN
 Telephone: +81 463 50 6400
 Facsimile: +81 463 50 6401

Plots of WLAN Traffic (11ac VHT80, SISO, duty about 24 %)

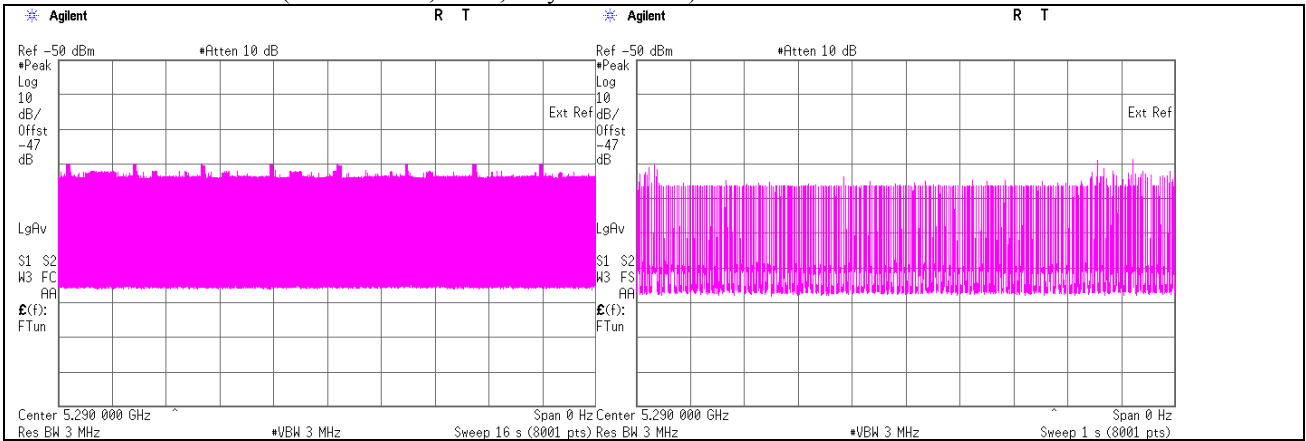

Plots of WLAN Traffic (11ac VHT80, SISO, duty about 24 %)

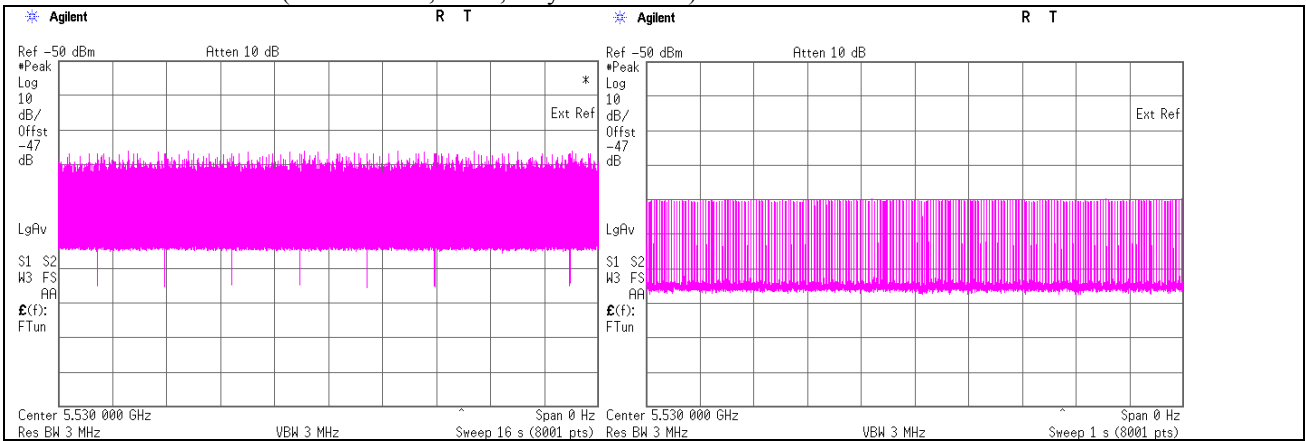

Plots of WLAN Traffic (11ac VHT80, MIMO, duty about 18 %)

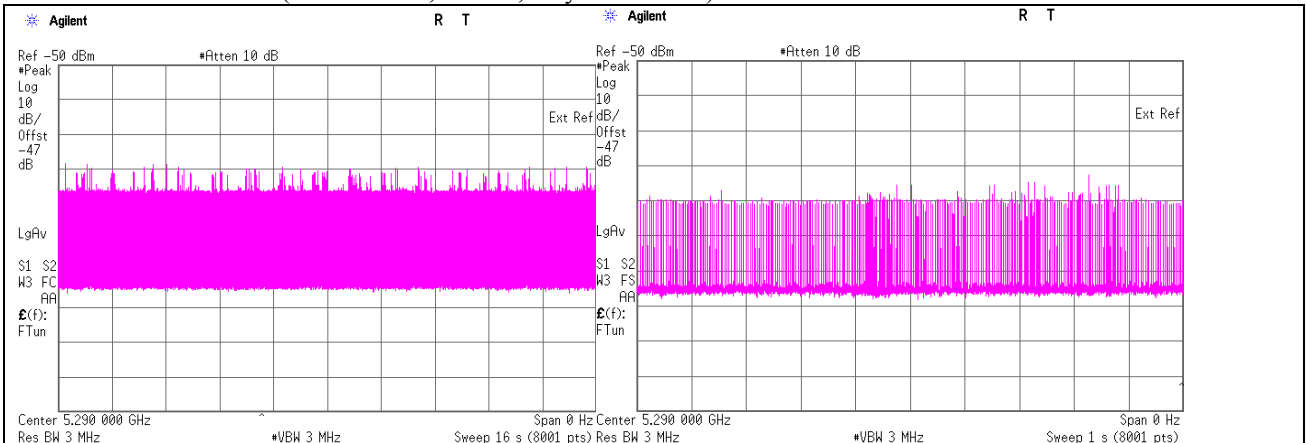

UL Japan, Inc.
Shonan EMC Lab.

1-22-3 Megumigaoka, Hiratsuka-shi, Kanagawa-ken, 259-1220 JAPAN

Telephone: +81 463 50 6400

Facsimile: +81 463 50 6401

Plots of WLAN Traffic (11ac VHT80, MIMO, duty about 18 %)

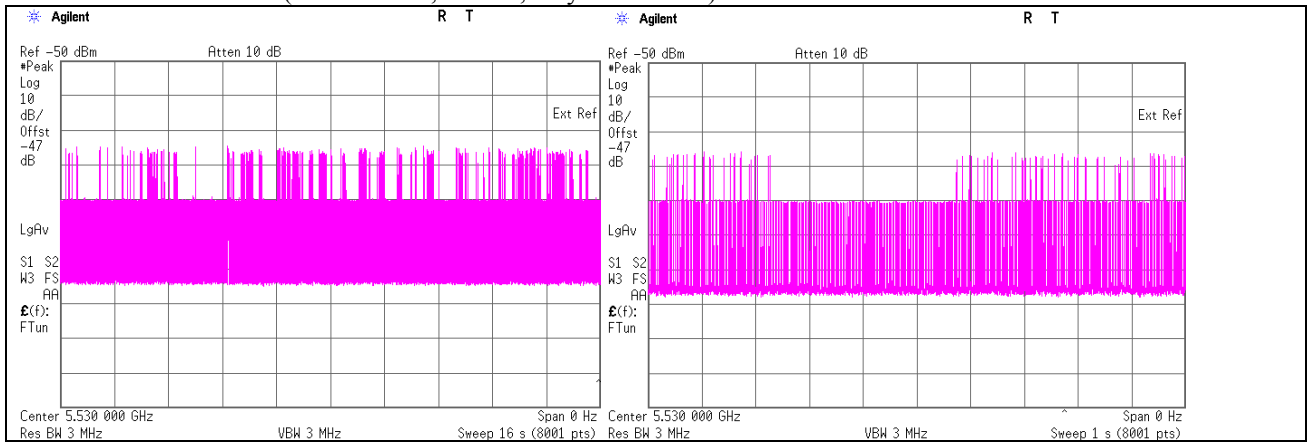

UL Japan, Inc.
Shonan EMC Lab.

1-22-3 Megumigaoka, Hiratsuka-shi, Kanagawa-ken, 259-1220 JAPAN

Telephone: +81 463 50 6400

Facsimile: +81 463 50 6401

SECTION 6: In-Service Monitoring for Channel Move Time, Channel Closing Transmission

Time

6.1 Operating environment

	(December 5, 2016)	(December 6, 2016)
Test place	: No.5 Shielded room	, No.5 Shielded room
Temperature	: 23 deg.C	, 23 deg.C
Humidity	: 62 %RH	, 42 %RH

6.2 Test Procedure

Transfer files from the Master Device to the Client Device on the tested channel during the entire period of the test. The Radar Waveform generator sends a Burst of pulses for one of the Short Pulse Radar Types 0 - 4 at levels defined, on the Operating Channel. An additional 1 dB is added to the radar test signal to ensure it is at or above the DFS Detection Threshold, accounting for equipment variations/errors. Observe the transmissions of the EUT at the end of the radar Burst on the Operating Channel for duration greater than 10 seconds.

6.3 Test data

Radar Type 0
11ac VHT80, SISO, MCS 0

Test Item	Unit	Measurement Time	Limit	Results
Channel Move Time *1)	[s]	0.002	10.000	Pass
Channel Closing Transmission Time *2)	[ms]	0	60	Pass

*1) Channel Move Time is calculated as follows:

$$(\text{Channel Move Time}) = (\text{End of Transmission}) - (\text{End of Burst}) = 1.010 - 1.008$$

*2) Channel Closing Transmission Time is calculated from (End of Burst + 200 ms) to (End of Burst + 10 s)

$$(\text{Channel Closing Transmission Time}) = (\text{Number of analyzer bins showing transmission}) \times (\text{dwell time per bin}) \\ = 0 \times 2 \text{ [ms]}$$

Radar Type 0
 11ac VHT80, SISO, MCS 0

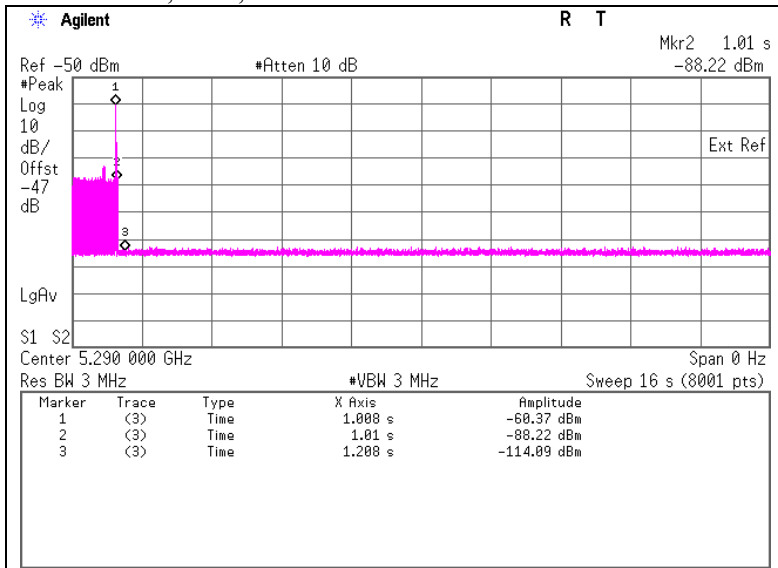

Marker 1: - End of Burst : 1.008 s
Marker 2: - End of Transmission : 1.010 s

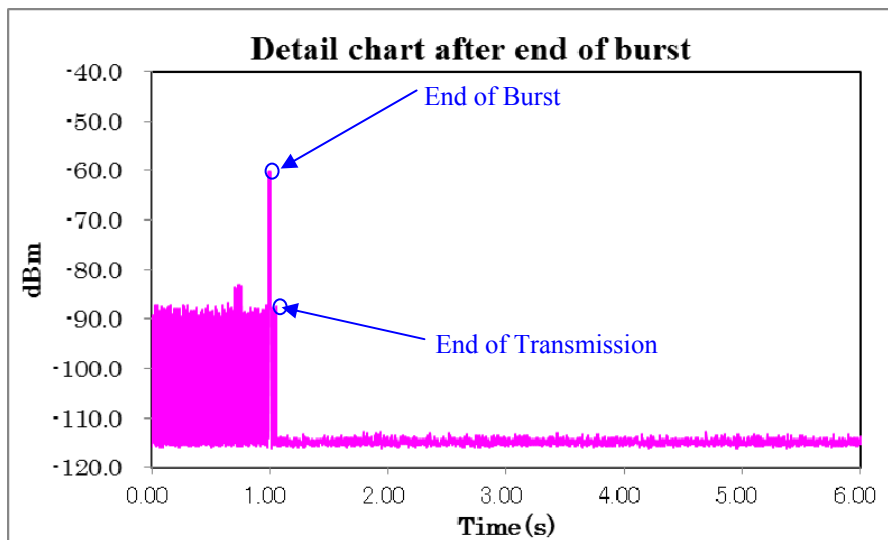

UL Japan, Inc.
Shonan EMC Lab.

1-22-3 Megumigaoka, Hiratsuka-shi, Kanagawa-ken, 259-1220 JAPAN
 Telephone: +81 463 50 6400
 Facsimile: +81 463 50 6401

Radar Type 0
11ac VHT80, MIMO, MCS 0

Test Item	Unit	Measurement Time	Limit	Results
Channel Move Time *1)	[s]	0.002	10.000	Pass
Channel Closing Transmission Time *2)	[ms]	0	60	Pass

*1) Channel Move Time is calculated as follows:

$$(\text{Channel Move Time}) = (\text{End of Transmission}) - (\text{End of Burst}) = 0.3703 - 0.3683$$

*2) Channel Closing Transmission Time is calculated from (End of Burst + 200 ms) to (End of Burst + 10 s)

$$(\text{Channel Closing Transmission Time}) = (\text{Number of analyzer bins showing transmission}) \times (\text{dwell time per bin}) = 0 \times 2 \text{ [ms]}$$

Radar Type 0
11ac VHT80, MIMO, MCS 0

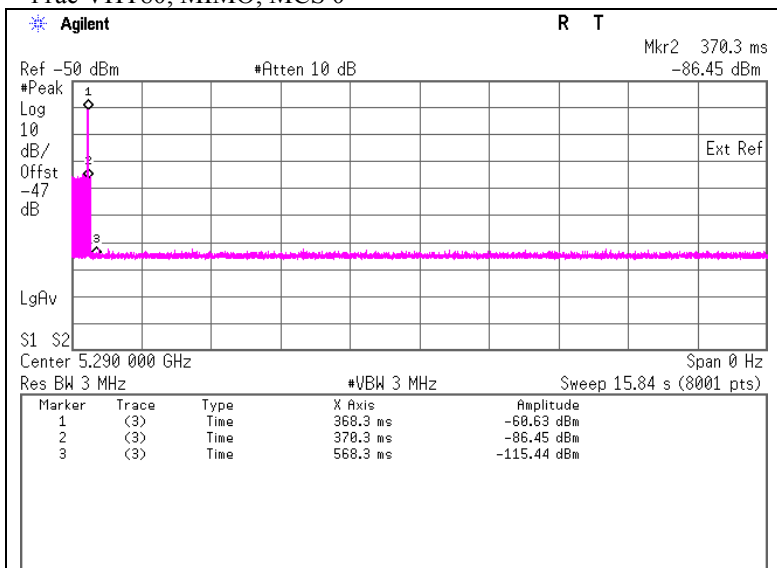

Marker 1: - End of Burst : 0.3683 s

Marker 2: - End of Transmission : 0.3703 s

Detail chart after end of burst

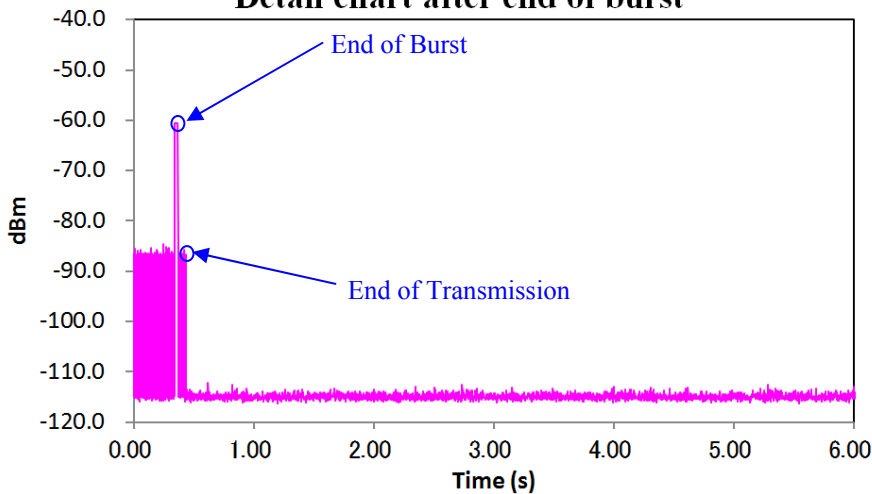

UL Japan, Inc.
Shonan EMC Lab.

1-22-3 Megumigaoka, Hiratsuka-shi, Kanagawa-ken, 259-1220 JAPAN

Telephone: +81 463 50 6400

Facsimile: +81 463 50 6401

Radar Type 0
11ac VHT80, SISO, MCS 0

Test Item	Unit	Measurement Time	Limit	Results
Channel Move Time *1)	[s]	0.072	10.000	Pass
Channel Closing Transmission Time *2)	[ms]	0	60	Pass

*1) Channel Move Time is calculated as follows:

$$(\text{Channel Move Time}) = (\text{End of Transmission}) - (\text{End of Burst}) = 0.818 - 0.746$$

*2) Channel Closing Transmission Time is calculated from (End of Burst + 200 ms) to (End of Burst + 10 s)

$$(\text{Channel Closing Transmission Time}) = (\text{Number of analyzer bins showing transmission}) \times (\text{dwell time per bin}) = 0 \times 2 \text{ [ms]}$$

Radar Type 0
11ac VHT80, SISO, MCS 0

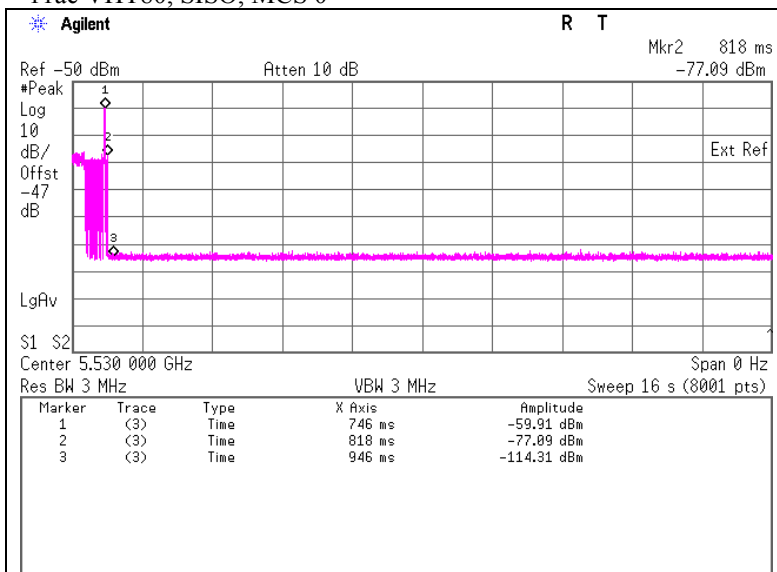

Marker 1: - End of Burst : 0.746 s

Marker 2: - End of Transmission : 0.818 s

Detail chart after end of burst

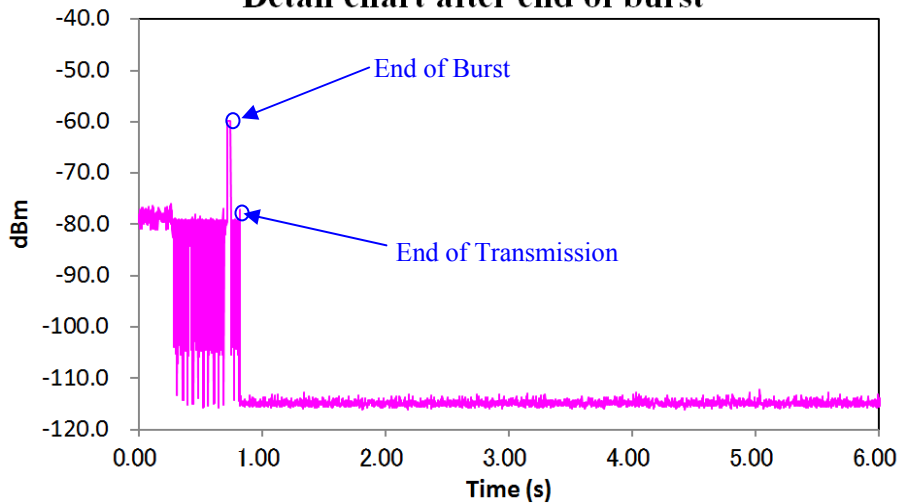

UL Japan, Inc.
Shonan EMC Lab.

1-22-3 Megumigaoka, Hiratsuka-shi, Kanagawa-ken, 259-1220 JAPAN

Telephone: +81 463 50 6400

Facsimile: +81 463 50 6401

Radar Type 0
11ac VHT80, MIMO, MCS 0

Test Item	Unit	Measurement Time	Limit	Results
Channel Move Time *1)	[s]	0.010	10.000	Pass
Channel Closing Transmission Time *2)	[ms]	0	60	Pass

*1) Channel Move Time is calculated as follows:

$$(\text{Channel Move Time}) = (\text{End of Transmission}) - (\text{End of Burst}) = 0.388 - 0.378$$

*2) Channel Closing Transmission Time is calculated from (End of Burst + 200 ms) to (End of Burst + 10 s)

$$(\text{Channel Closing Transmission Time}) = (\text{Number of analyzer bins showing transmission}) \times (\text{dwell time per bin}) = 0 \times 2 \text{ [ms]}$$

Radar Type 0
11ac VHT80, MIMO, MCS 0

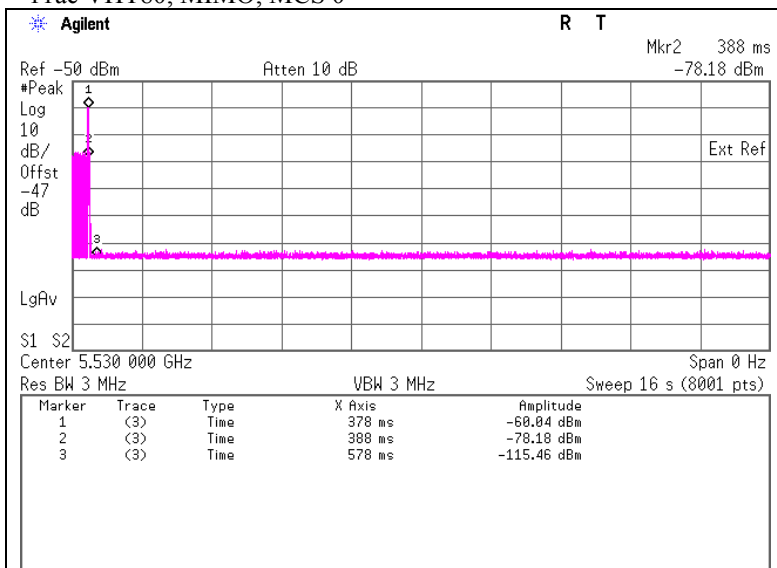

Marker 1: - End of Burst : 0.378 s

Marker 2: - End of Transmission : 0.388 s

Detail chart after end of burst

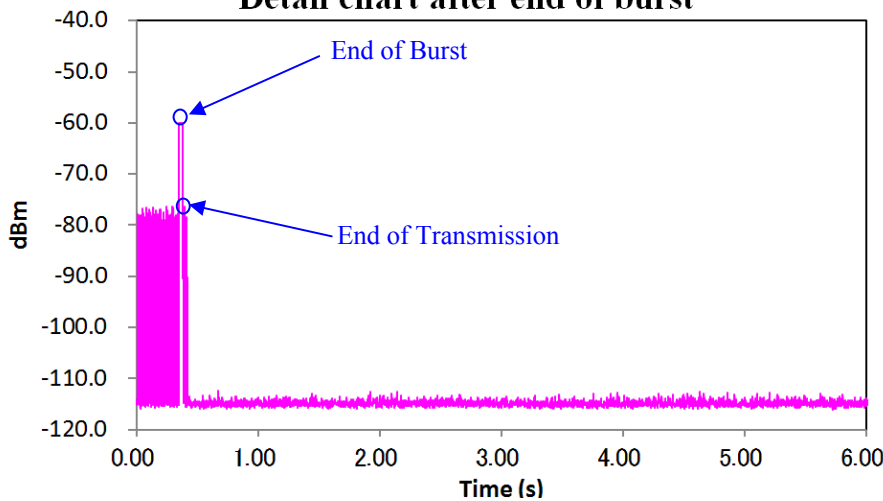

UL Japan, Inc.
Shonan EMC Lab.

1-22-3 Megumigaoka, Hiratsuka-shi, Kanagawa-ken, 259-1220 JAPAN
Telephone: +81 463 50 6400
Facsimile: +81 463 50 6401

6.4 Test result

Test result: Pass

Date : December 5 to 6, 2016

Test engineer : Kenichi Adachi

SECTION 7: In-Service Monitoring for Non-Occupancy Period

7.1 Operating environment

	(December 5, 2016)	(December 6, 2016)
Test place	: No.5 Shielded room	, No.5 Shielded room
Temperature	: 23 deg.C	, 23 deg.C
Humidity	: 62 %RH	, 42 %RH

7.2 Test Procedure

The following two tests are performed:

- 1). Transfer files from the Master Device to the Client Device on the tested channel during the entire period of the test. The Radar Waveform generator sends a Burst of pulses for one of the Radar Types 0 - 6 at levels defined on the Operating Channel. An additional 1 dB is added to the radar test signal to ensure it is at or above the DFS Detection Threshold, accounting for equipment variations/errors. Observe the transmissions of the EUT after the Channel Move Time on the Operating Channel for duration greater than 30 minutes.
- 2). Transfer files from the Master Device to the Client Device on the tested channel during the entire period of the test. Observe the transmissions of the EUT on the Operating Channel for duration greater than 30 minutes after the Master Device is shut off.

7.3 Test data

- 1). Radar Type 0
11ac VHT80, SISO, MCS 0

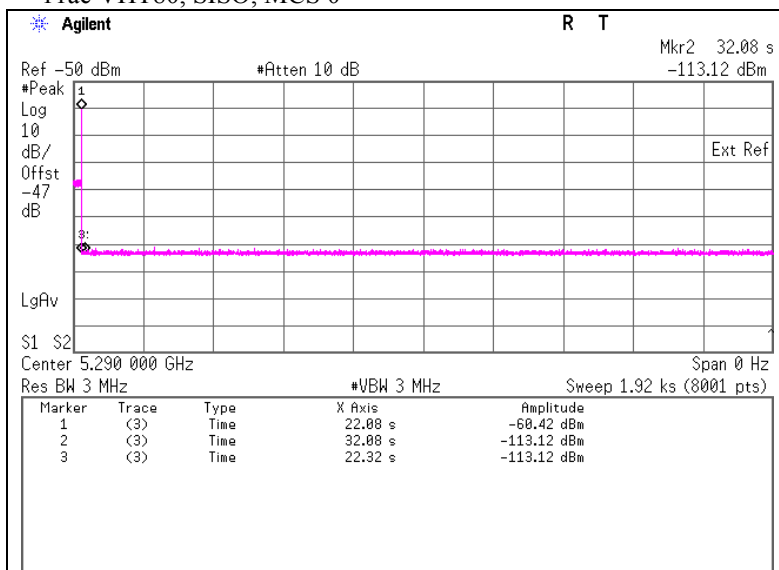

Marker 1 : End of Burst : 22.08 s
Marker 2 : End of Burst + 10 s : 32.08 s
Marker 3 : End of transmission : 22.32 s

* Measurement non-occupancy period: 31.47 minutes or more (1920 [s] – 32.08 [s] = 1887.92 [s] = 31.47 [minutes])

1). Radar Type 0
11ac VHT80, MIMO, MCS 0

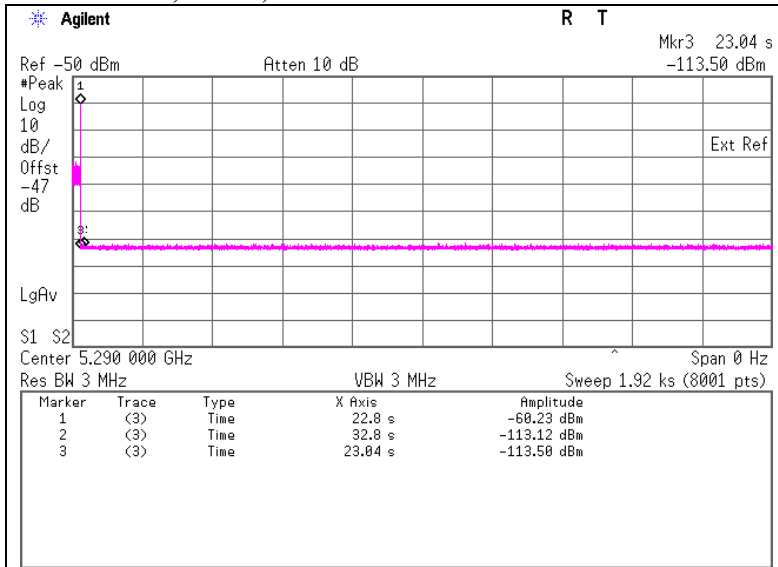

Marker 1 : End of Burst : 22.80 s
Marker 2 : End of Burst + 10 s : 32.80 s
Marker 3 : End of transmission : 23.04 s

* Measurement non-occupancy period: 31.45 minutes or more (1920 [s] – 32.80 [s] = 1887.20[s] = 31.45 [minutes])

1). Radar Type 0
11ac VHT80, SISO, MCS 0

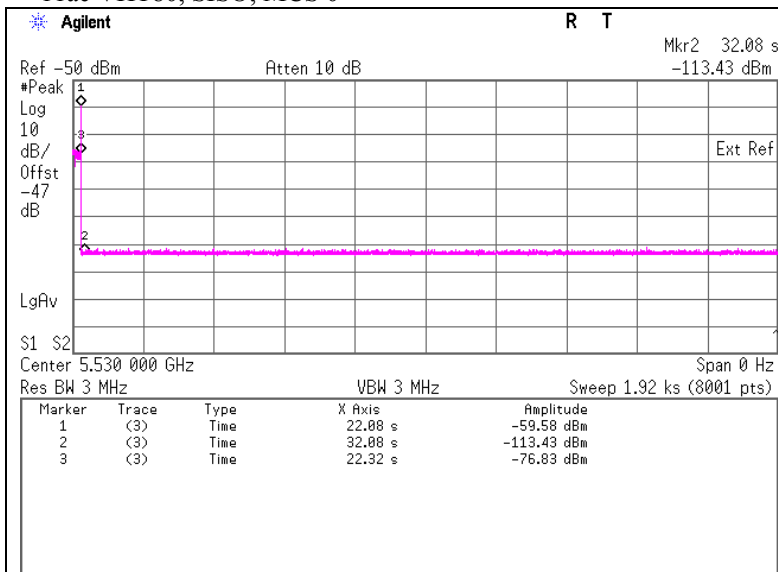

Marker 1 : End of Burst : 22.08 s
Marker 2 : End of Burst + 10 s : 32.08 s
Marker 3 : End of transmission : 22.32 s

* Measurement non-occupancy period: 31.47 minutes or more (1920 [s] – 32.08 [s] = 1887.92 [s] = 31.47 [minutes])

1). Radar Type 0
 11ac VHT80, MIMO, MCS 0

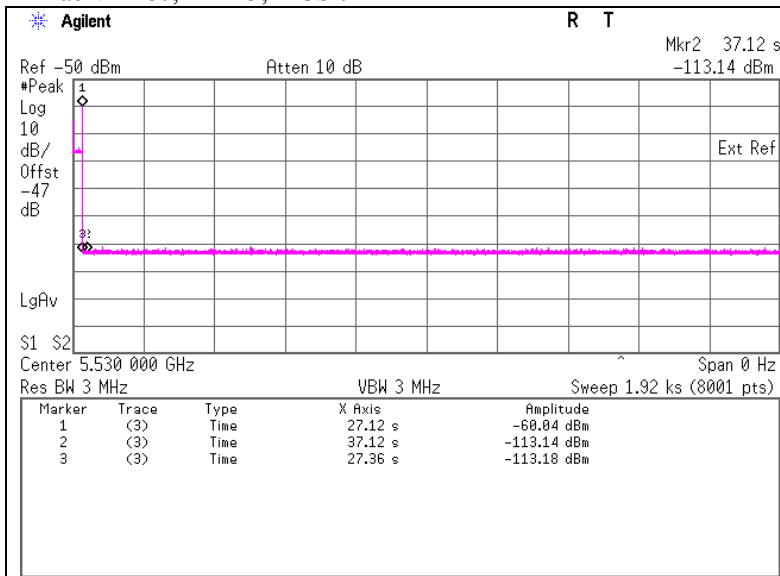

Marker 1 : End of Burst : 27.12 s
Marker 2 : End of Burst + 10 s : 37.12 s
Marker 3 : End of transmission : 27.36 s

* Measurement non-occupancy period: 31.38 minutes or more (1920 [s] – 37.12 [s] = 1882.88[s] = 31.38 [minutes])

2). Master is shut off
 11ac VHT80, SISO, MCS 0

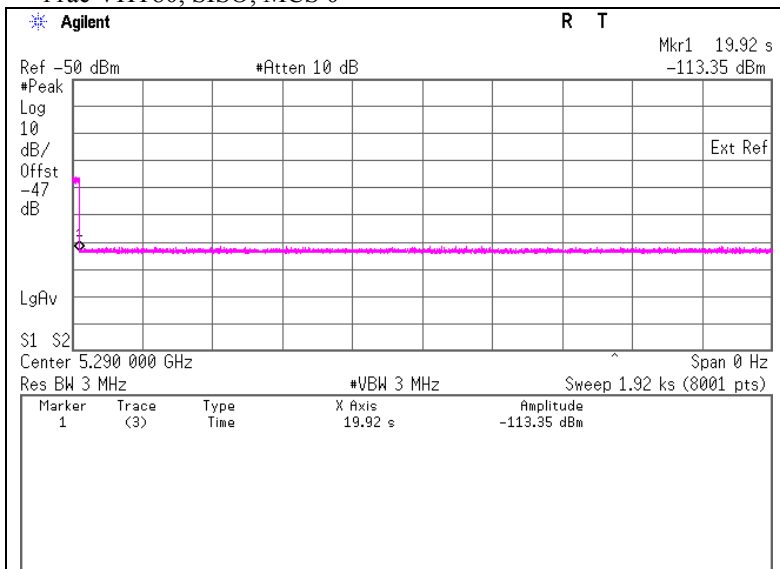

Marker 1 : End of Burst : 19.92 s

* Measurement non-occupancy period: 31.67 minutes or more (1920 [s]– 19.92 [s] = 1900.08 [s] = 31.67 [minutes])

2).Master is shut off
11ac VHT80, MIMO, MCS 0

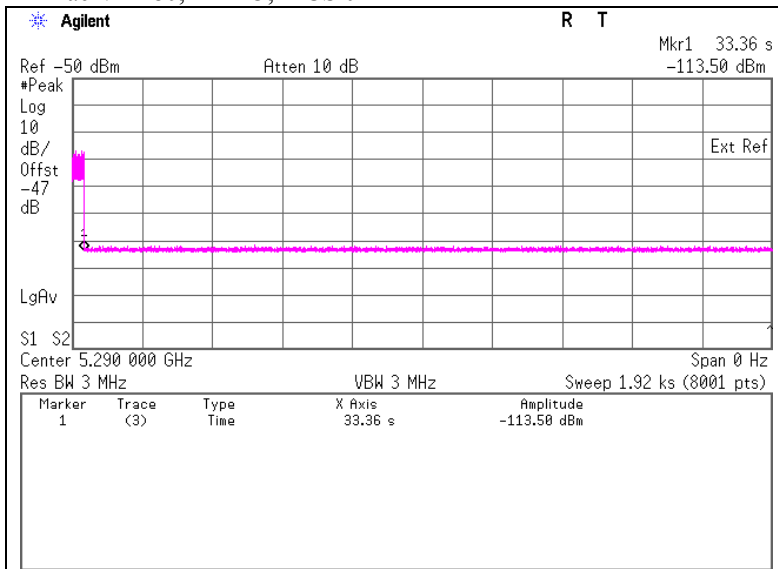

Marker 1 : End of Burst : 33.36 s

* Measurement non-occupancy period: 31.44 minutes or more (1920 [s]- 33.36 [s] = 1886.64 [s] = 31.44 [minutes])

2).Master is shut off
11ac VHT80, SISO, MCS 0

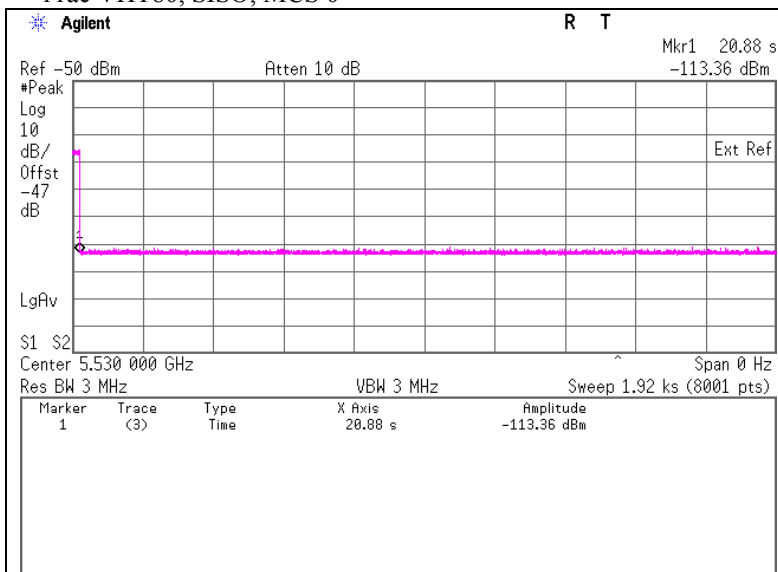

Marker 1 : End of Burst : 20.88 s

* Measurement non-occupancy period: 31.67 minutes or more (1920 [s]- 20.88 [s] = 1899.12 [s] = 31.65 [minutes])

UL Japan, Inc.
Shonan EMC Lab.

1-22-3 Megumigaoka, Hiratsuka-shi, Kanagawa-ken, 259-1220 JAPAN
Telephone: +81 463 50 6400
Facsimile: +81 463 50 6401

2).Master is shut off
 11ac VHT80, MIMO, MCS 0

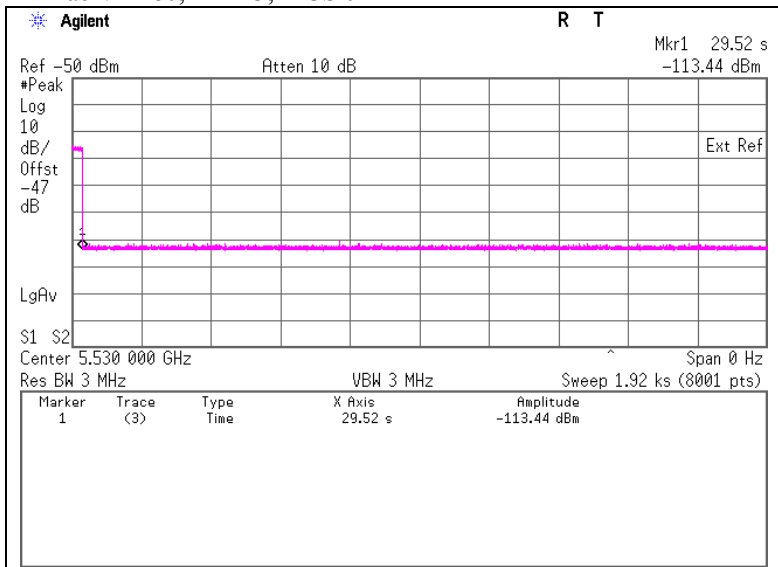

Marker 1 : End of Burst : 29.52 s

* Measurement non-occupancy period: 31.51 minutes or more (1920 [s]- 29.52 [s] = 1890.48 [s] = 31.51 [minutes])

7.4 Test result

Test result: Pass

Date : December 5 to 6, 2016

Test engineer : Kenichi Adachi

APPENDIX 1: Test instruments

EMI Test Equipment

Control No.	Instrument	Manufacturer	Model No	Serial No	Test Item	Calibration Date * Interval(month)
SSG-01	Signal Generator	Agilent	E4438C	MY47271584	DFS	2016/03/24 * 12
SCC-G31	Coaxial Cable	Junkosha	MWX241-01000KMSKMS	OCT-08-13-046	DFS	2016/04/18 * 12
SPSC-02	Power Splitters/Combiners	Mini-Circuits	ZFSC-2-10G+	-	DFS	2016/04/18 * 12
SPSC-07	Power Splitters/Combiners	Mini-Circuits	ZFSC-2-10G+	-	DFS	2016/07/28 * 12
STM-G3	Terminator	Weinschel	M1459A	U6569	DFS	2016/07/27 * 12
SPSC-08	Power Splitters/Combiners	Mini-Circuits	ZFSC-2-10G+	-	DFS	2016/07/28 * 12
SCC-G11	Coaxial Cable	Suhner	SUCOFLEX 102	31595/2	DFS	2016/03/23 * 12
SPSC-03	Power Splitters/Combiners	Mini-Circuits	ZFSC-2-10G+	-	DFS	2016/04/18 * 12
SCC-G29	Coaxial Cable	Junkosha	MWX241-01000KMSKMS	SEP-20-12-003	DFS	-
SAT20-06	Attenuator	Weinschel Corp.	54A-20	31506	DFS	2016/04/18 * 12
SAT20-07	Attenuator	Weinschel Corp.	54A-20	31484	DFS	2016/04/18 * 12
SCC-G26	Coaxial Cable	Suhner	141PE	-	DFS	2016/07/27 * 12
SPD-01	Power Divider	Agilent	11636B	56998	DFS	2016/04/18 * 12
SCC-G24	Coaxial Cable	Suhner	141PE	-	DFS	2016/07/27 * 12
SCC-G25	Coaxial Cable	Suhner	141PE	-	DFS	2016/07/27 * 12
SRE-157	Wireless LAN access point	Cisco Systems	AIR-CAP3702E-A-K9	FTX18227609	DFS	
SPC-S15	Personal Computer	Dell	LATITUDE D530 (PP17L)	CN-0HP728-48643-83R-0675	DFS	-
SOS-09	Humidity Indicator	A&D	AD-5681	4061484	DFS	2015/12/07 * 12
COTS-SDFS-01	Signal Studio Software for DFS	Agilent	N7620A-101	5010-7739	DFS	-
COTS-SDFS-02	Radar Generating Software for DFS	Agilent	-	-	DFS	-
KTS-07	Digital Tester	SANWA	PC500	7019232	DFS	2016/10/17 * 12

The expiration date of the calibration is the end of the expired month.

As for some calibrations performed after the tested dates, those test equipment have been controlled by means of an unbroken chains of calibrations.

All equipment is calibrated with valid calibrations. Each measurement data is traceable to the national or international standards.

Test Item:

DFS: Dynamic Frequency Selection

UL Japan, Inc.

Shonan EMC Lab.

1-22-3 Megumigaoka, Hiratsuka-shi, Kanagawa-ken, 259-1220 JAPAN

Telephone: +81 463 50 6400

Facsimile: +81 463 50 6401